

PROGRESS REPORT August 2000 to September 2001

DESIGN CONSIDERATIONS FOR INTEGRAL
ABUTMENT BRIDGES IN FLORIDA

Contract No. BC342

By

Dr. M. Arockiasamy

Principal Investigator

Professor and Director

Center for Infrastructure and Constructed Facilities

Department of Ocean Engineering

Florida Atlantic University

Boca Raton, FL 33431

September 2001

Table of Conversion

To convert from	To	Multiply by
Length		
Inch (in.)	Millimeter (mm)	25.4
Foot (ft)	Meter (m).	0.3048
Area		
Square inch (sq. in.)	Square millimeter. (sq. mm)	645.2
Square foot (sq. ft.) ,	Square meter (sq. m)	0.0926
Volume		
Cubic inch (cu. in.)	Cubic meter. (cu. m)	0.00001639
Cubic foot (cu. ft.)	Cubic meter (cu. m)	0.02832
Cubic yard (cu. yd.)	Cubic meter (cu. m)	0.7646
Gallon (gal)	Liter	3.785
Force		
Kip	Kilogram (kgf)	453.6
Kip	Newton (N)	4448.0
Pound (lb)	Newton (N)	4.448
Pressure or Stress		
Kip/square inch (ksi)	Megapascal (Mpa)**	6.895 Pound/square
inch (psi)	Megapascal (Mpa)**	0.006895
**a pascal equals one newton/square meter		
Mass		
Pound	Kilogram (kg)	0.4536
Ton(short, 2000 lb)	Kilogram (kg)	907.2
Mass (weight per length)		
Kip/linear foot (klf)	Kilogram/meter (kg/m)	0.001488
Pound/linear foot (klf)	Kilogram/meter. (kg/m)	1.488
Pound/linear foot (klf)	Newton/meter (N/m)	14.593

Table of Contents

Table of conversion.....	i
List of Tables	iv
List of figure	vi

Section I Specifications for Integral Abutment Bridges

1.1 American Iron and Steel Institute	1
1.2 Colorado Department of Transportation.....	11
1.3 Federal Highway Administration.....	15
1.4 Illinois Department of Transportation	22
1.5 Maine Department of Transportation.....	29
1.6 New Jersey Department of Transportation	39
1.7 New York Department of Transportation.....	61
1.8 Ohio Department of Transportation.....	66
1.9 Typical Case Studies: Integral Abutment Bridges.....	70

Section II Analysis of Laterally Loaded Piles for Integral Abutment Bridges

2.1 Introduction.....	115
2.2 Soil Characterization.....	115
2.3 Equivalent Cantilever Idealization.....	120
2.4 Equivalent Uniform Soil Stiffness	124
2.5 Beam Column	126
2.6 Pile Design	128
2.7 Computer Programs for Laterally Loaded Pile Analysis.....	131
2.7.1 COMP264P	131
2.7.2 LPILE 4.0Plus.....	164

Section III Integral Abutment Bridge: Design Example

3.1 Superstructure	166
3.2 Temperature, Creep and Shrinkage Effect.....	169
3.3 Approach Slab.....	170
3.4 Pile Foundation for Abutment	180
3.5 Abutment.....	205
3.6 Wingwall.....	216
3.7 Pier	231
3.8 Pile Foundation for Interior Pier.....	254
References	258

List of Tables

Table 1.1 Maximum length of integral bridge	11
Table 1.2 Maximum length of integral bridge	16
Table 1.3 Maximum bridge length for fixed head abutment	33
Table 1.4 Maximum bridge length pinned head abutment	34
Table 1.5 Minimum embedment length of pile	37
Table 2.1 Parameter for p-y curve	119
Table 2.2 Representative values of k for submerged sand (static and cyclic loading) ...	157
Table 2.3 Representative values of k for above sand (static and cyclic loading)	157
Table 3.1 Summary of factored load of DC and DW load on piles (kips)	182
Table 3.2 Summary of live load on piles (kips).....	183
Table 3.3 Summary of factored load of DC, DW and LL+ IM on piles (kips)	184
Table 3.4 Summary of factored DC, DW and LL+ IM on piles (kips).....	184
Table 3.5 Total equivalent cantilever length.....	193
Table 3.6 Total equivalent cantilever length.....	194
Table 3.7 Width- thickness parameters.....	201
Table 3.8 P_u load reaction at girder.....	208
Table 3.9 Vertical loads on wingwall	218
Table 3.10 Horizontal load on wingwall.....	219
Table 3.11 Factored shear and bending moment along stem.....	228
Table 3.12 Live load reactions at girder points on bent cap	234
Table 3.13 Reactions at the bents due to live load.....	235
Table 3.14 Summary of reactions	235
Table 3.15 Bending moments at girder locations in bent cap.....	236
Table 3.16 Moments in the column	241
Table 3.17 Loads on each column	242
Table 3.18 Summary of reactions	248
Table 3.19 Summary of load of DC, DW and LL+ IM on piles (kips)	257
Table 3.20 Summary of service load on pile	258
Table 3.21 Soil modulus parameter k for clay.....	260

Table 3.22 Soil modulus parameter k for sand	261
Table 3.23 Values of ϵ_{50} for clays.....	261
Table 3.24 Values of ϵ_{50} for stiff clays	261

List of Figures

Figure 1.1 Typical cross section of integral abutment.....	3
Figure 1.2 Integral abutment details	5
Figure 1.3 Integral abutment details	5
Figure 1.4a Plan view of approach slab	7
Figure 1.4b Cross section of wingwall and fill behind the abutment	7
Figure 1.4c Reinforcement details of approach slab.....	8
Figure 1.4d Joint details of approach slab and asphalt approach pavement	8
Figure 1.5 Typical abutment section.....	13
Figure 1.6 Approach slab	17
Figure 1.7 Cast in place concrete (California)	18
Figure 1.8 Prestressed concrete I-beam (FHWA region 15).....	19
Figure 1.9 Steel girder integral abutment bridges (Missouri).....	19
Figure 1.10 Required provision conditions.....	21
Figure 1.11 Integral abutment wingwall embankment	23
Figure 1.12 Section through integral abutment.....	23
Figure 1.13 Integral abutment plan (showing pile orientation)	25
Figure 1.14 Integral abutment for steel beams.....	26
Figure 1.15 Integral abutment for steel beams W690 and smaller	27
Figure 1.16 Integral abutment for PPC-I beams	28
Figure 1.17 Integral abutment details	30
Figure 1.18 Pinned head integral abutment (for precast/ prestressed superstructure)	31
Figure 1.19 Fixed head integral abutment (for precast/ prestressed superstructure)	31
Figure 1.20 Thermally induce secondary pile force	33
Figure 1.21 Maximum calculated pile load (fixed head piles)	37
Figure 1.22 Maximum calculated pile load (pinned head piles).....	38
Figure 1.23 Thermally induced secondary pile forces for multi-span bridges (pinned head).....	38
Figure 1.24 Thermally induced secondary pile forces for multi-span bridges (fixed head)	39

Figure 1.25 Integral abutment construction procedure.....	56
Figure 1.26 Integral abutment of prestressed concrete structure	57
Figure 1.27 Prestressed concrete superstructure details	58
Figure 1.28 Integral abutment details for steel girder.....	59
Figure 1.29 Integral abutment construction procedure	60
Figure 1.30 Approach slab for masonry detail.....	60
Figure 1.31 Approach slab reinforcement detail.....	61
Figure 1.32 Integral abutment details for prestressed girder	65
Figure 1.33 Integral abutment construction procedure	66
Figure 1.34 Skew VS bridge length limitation of integral abutment bridge.....	67
Figure 1.35 Typical integral abutment.....	69
Figure 1.36 Location of Smith Bridge	71
Figure 1.37 General view of Smith Bridge.....	71
Figure 1.38 Design criteria for Smith Bridge	72
Figure 1.39 Plan and sectional elevation of abutment 1	73
Figure 1.40 Plan and sectional elevation of abutment 2	74
Figure 1.41 Cross sectional details of abutment 1	75
Figure 1.42 Cross sectional details of abutment 2	75
Figure 1.43 Plan view of pier.....	76
Figure 1.44 Cross sectional elevation of pier.....	77
Figure 1.45 Pier cross section	78
Figure 1.46 Plan and transverse section of the superstructure.....	79
Figure 1.47 Abutment and pile notes.....	80
Figure 1.48 Pier and pile notes	81
Figure 1.49 Structural steel notes.....	82
Figure 1.50 Superstructure notes	82
Figure 1.51a Reinforcing steel schedule.....	83
Figure 1.51 b Reinforcing steel schedule.....	83
Figure 1.51c Reinforcing steel schedule	84
Figure 1.51d General notes	84
Figure 1.51d Type-bending diagrams	85

Figure 1.52 Design data and construction note.....	86
Figure 1.53 General plan.....	87
Figure 1.54 General elevation.....	88
Figure 1.55 The details of superstructure	89
Figure 1.56a General elevation and cross section of abutment	90
Figure 1.56b General elevation of abutment.....	91
Figure 1.57a Details of abutment reinforcement	92
Figure 1.57b Details of abutment reinforcement	93
Figure 1.58a Details of abutment reinforcement	94
Figure 1.58b Abutment and wingwall detail section D-D	95
Figure 1.58c Construction joint notes.....	95
Figure 1.59a Abutment and wingwall reinforcements.....	96
Figure 1.59b Abutment and wingwall reinforcements	97
Figure 1.59c Abutment and wingwall reinforcements.....	98
Figure 1.59d Reinforcements for abutment	98
Figure 1.60 Part elevation section at abutment diaphragm.....	99
Figure 1.61 Part longitudinal section.....	99
Figure 1.62 Plan view section at abutment diaphragm	100
Figure 1.63a Details of superstructure reinforcement.....	101
Figure 1.63b Details of superstructure reinforcement	102
Figure 1.64 General plan.....	103
Figure 1.65 Abutment elevation	104
Figure 1.66 The details of superstructure reinforcement	105
Figure 1.67 Section at intermediate bent	106
Figure 1.68 Section at end abutment.....	106
Figure 1.69 Drainage details	107
Figure 1.70 Details of Bluff Creek Bridge superstructure	108
Figure 1.71 Details of Bluff Creek Bridge superstructure	109
Figure 1.72 Details of the end abutment, and intermediate support	110
Figure 1.73 Abutment plan	111
Figure 1.74 Typical interior section.....	112

Figure 1.75 Reinforcement detail	113
Figure 1.76 Approach slab.....	114
Figure 2.1 Design model of soil-pile system	117
Figure 2.2 Typical p-y curve.....	118
Figure 2.3 Nondimensional form of the modified Ramberg-Osgood equation.....	118
Figure 2.4 Cantilever idealization of the pile: (a) fixed-head condition (b) pinned-head condition.....	121
Figure 2.5 Equivalent cantilever for fixed-head piles embedded in uniform soil	123
Figure 2.6 Equivalent cantilever for pinned-head piles embedded in uniform soil.....	123
Figure 2.7 Piles in nonuniform soil: (a) actual variation of stiffness (b) equivalent uniform stiffness.....	124
Figure 2.8 Second moment about reference line A – A.....	125
Figure 2.9 Layer soil system for determining k_e	125
Figure 2.10 Beam-column with uniformly distributed lateral load	127
Figure 2.11 Equivalent cantilever: (a) fixed-head condition (b) pinned-head condition	130
Figure 2.12 Element for beam-column (after Hetenyi, 1946)	133
Figure 2.13 Sign conventions	135
Figure 2.14 Form of the results obtained from a complete solution.....	135
Figure 2.15 Representation of deflected pile	137
Figure 2.16 Point at bottom of pile	139
Figure 2.17 Points at top of pile.....	140
Figure 2.18 Case 1 of boundary conditions at top of pile.....	141
Figure 2.19 Case 2 of boundary conditions at top of pile.....	143
Figure 2.20 Case 3 of boundary conditions at top of pile.....	144
Figure 2.21 Case 4 of boundary conditions at top of pile.....	145
Figure 2.22 Assumed passive wedge-type failure for clay: (a) shape of wedge (b) forces acting on wedge.....	147
Figure 2.23 Assumed lateral flow-around type of failure for clay: (a) section through pile (b) Mohr-Coulomb diagram (c) force acting on Pile	149
Figure 2.24 Assumed passive wedge-type failure: (a) general shape of wedge (b) forces of wedge (c) forces on pile.....	151

Figure 2.25 Assumed mode of soil failure by lateral flow around the pile: (a) section through the pile (b) Mohr-Coulomb diagram representing states of stress of soil flowing around a pile.....	152
Figure 2.26 Characteristic shapes of the p - y curves for soft clay below water surface: (a) static loading (b) cyclic loading	154
Figure 2.27 Characteristic shape of a family of p - y curves for static and cyclic loading in sand	155
Figure 2.28 Values of coefficients \bar{A}_s or \bar{A}_c	158
Figure 2.29 Values of coefficients B for soil resistance versus depth	159
Figure 2.30 Example problem for soil response for layered soils	161
Figure 2.31 Example p - y curves for layered soils.....	162
Figure 2.32 Equivalent depths of overlying soil for use in computing p - y for a layer system.....	163
Figure 3.1 Prestressed concrete girder integral abutment bridge a) elevation , and b) plan	166
Figure 3.2 Section of prestressed concrete girder integral abutment.....	167
Figure 3.3 AASHTO Girder type III.....	167
Figure 3.4 Typical section of parapet	167
Figure 3.5 Characteristics of the design truck (AASHTO, 1998)	169
Figure 3.6 Dimension of approach slab	170
Figure 3.7 Live load placement for maximum reaction in approach slab, a) design truck, b) design tandem truck and c) design truck.....	172
Figure 3.8 Live load placement for maximum reaction in approach slab, a) design truck, b) design tandem truck and c) design truck.....	173
Figure 3.9 Live load placement for edge strip shear and moment for approach slab	174
Figure 3.10 Shear and bending moment diagram for factored dead load.....	175
Figure 3.11 Strength curve (R_s vs. ρ) for singly reinforced rectangular sections. Upper limit of curves is at $0.75 \rho_b$. (Wang and Salmon,1997)	177
Figure 3.12 Standard hook embedment details.....	178
Figure 3.13 Development length L_{dh} for hook embedment	178
Figure 3.14 Design of hook embedment.....	179

Figure 3.15 Reinforcement details of approach slab	179
Figure 3.16 Abutment dimensions	180
Figure 3.17 Abutment plan	180
Figure 3.18 Dead load from girders and pile reactions.....	181
Figure 3.19 Live load placement for maximum reaction at end span (Abutment is located at A).....	182
Figure 3.20 Live load on abutment.....	183
Figure 3.21 Live load from girders and pile reactions.....	183
Figure 3.22 Soil strata below abutment	185
Figure 3.23 Section through abutment and soil profile.....	187
Figure 3.24 Adhesion factor for driven piles in clay (a) Case 1:pile driven through overlying sand or sand gravels. (b) Case 2:piles driven through overlying weak clay (c) Case 3:piles without different overlying strata. (Tomlinson, 1995)	188
Figure 3.25 Horizontal soil stiffness and displacement. (a) the variation of horizontal soil stiffness with depth (b) an approximation of existing soil stiffness (c) the displaced shape.....	190
Figure 3.26 Soil stiffness	190
Figure 3.27 Cantilever idealization of a fixed-headed pile.....	193
Figure 3.28 Free body diagram for lateral displacement of pile.....	195
Figure 3.29 Idealized abutment foundation and girder end span: (a) approximate structural model (b) free body diagram with passive soil pressure.....	196
Figure 3.30 Abutment, wingwall and approach slab plan	205
Figure 3.31 Abutment cross section.....	205
Figure 3.32 Abutment section A-A.....	206
Figure 3.33 Reinforcement details in abutment.....	207
Figure 3.34 Abutment section B-B	207
Figure 3.35 a) load on the abutment, b) shear force diagram and c) bending moment distribution diagram Load, shear and bending moment distribution diagram	209
Figure 3.36 Distribution of horizontal flexure steel in continuous deep beam.....	210
Figure 3.37 Abutment (deep beam)	211
Figure 3.38 Shear and moment at critical section.....	212

Figure 3.39 Reinforcement details of abutment.....	214
Figure 3.40 Corbel design.....	215
Figure 3.41 Wingwall section.....	216
Figure 3.42 Elevation of approach slab, abutment and wingwall.....	217
Figure 3.43 Summary of load on the wingwall.....	217
Figure 3.44 Forces on the wingwall.....	219
Figure 3.45 Forces acting on the heel.....	224
Figure 3.46 Forces acting on the toe.....	225
Figure 3.47 Earth pressure acting on the stem ($y = 11 \text{ ft } 3 \text{ in.}$).....	226
Figure 3.48 Bending moment diagram for stem.....	227
Figure 3.49 Reinforcement details for wingwall.....	230
Figure 3.50b Schematic diagram of bent cap.....	231
Figure 3.50b Bent cap plan.....	232
Figure 3.50c Pile cap plan.....	332
Figure 3.51. Dead load from girders acting on bent cap and the resulting reactions.....	233
Figure 3.52 Wheel load positions for maximum reaction at bent cap.....	233
Figure 3.53 Reactions transmitted to the bent from the girders due to live load.....	234
Figure 3.54 Total live load from girders and reactions at bent cap.....	235
Figure 3.55 Bending moment diagram of typical interior pier bent a) due to LL of superstructure b) due to DL of superstructure and c) due to DL of bent cap.....	237
Figure 3.56 Reinforcement details for bent cap.....	241
Figure 3.57 Reinforcement details of column.....	247
Figure 3.58 Reaction transmitted to the pile cap from the columns due to column load	247
Figure 3.59 a) load on pile cap b) shear force diagram and c) bending moment distribution diagram.....	248
Figure 3.60 Pile cap (deep beam).....	250
Figure 3.61 shear and moment at critical support.....	251
Figure 3.62 Reinforcement details of pile cap.....	253
Figure 3.63 Soil profile below the pier.....	255

Section I: Specifications for Integral Abutment Bridges

1.1 American Iron and Steel Institute⁽¹⁾

Integral Abutments for Steel Bridges

While integral abutments have been used successfully for 50 years, their implementation has been a matter of intuition, experimentation and observation. Inspection of many bridges with failed expansion bearings has revealed that anticipated catastrophic damage has not always occurred. The ability of bents and pile-supported abutments to accommodate thermal movements has often been underrated. Despite the lack of analytical tools, engineers have been pushing the envelope by constructing longer and longer jointless bridges.

The analysis of a pile under lateral loads is a problem in soil-structure interaction. Since the deflected shape of the loaded pile is dependent upon the soil response, and in turn, the soil response is a function of pile deflection, the system response cannot be determined by the traditional rules of static equilibrium. Further, soil response is a nonlinear function of pile deflection. The determination of the practical point of fixity of the buried pile is rather complex in structural engineering.

In recent years, elasto-plastic soil/structure analysis tools have allowed engineers to better correlate mathematically.^(2,3,12,14) Several methods have been developed that attempt to model soil-pile interaction. However the most promising method of analysis is found in Report No. FHWA-5A-91-048, COM624P entitled "Laterally, Loaded Pile Analysis Program For The Microcomputer, Version 2.0".⁽²⁷⁾

The methods used for the solution of the problem of laterally loaded piles require: 1) differential equations to obtain pile deflections and 2) iteration, since soil response is a non-linear function of the pile deflection along the length of the pile. Further, the solutions presented recognize that as the backfill is acted upon for several cycles, the

backfill becomes remolded. Thus, an array of load-deflection, moment and shear conditions can be investigated. Important to the solution is the development of a pseudo-modulus of elasticity for the embankment soils that are acted upon by piles subjected to lateral loads. In the p - y , method pile response is obtained by an interactive solution of a fourth-order differential equation using finite-difference techniques. The soil response is described by a family of non-linear curves (p - y curves) that compute soil resistance p as a function of pile deflection y .

Integral Abutment Details

Components of jointless bridges are subjected to the same forces as other, continuous bridges with expansion joints at their ends. Exceptions to this rule apply only, when integral abutments are tall and the structure is designed as a frame.

The most desirable end conditions for an integral abutment are the stub or propped-pile cap type shear in Fig. 1.1, which provides the greatest flexibility and hence, offers the least resistance to cyclic thermal, movements. Under, these conditions, only the abutment piling, and wings are subjected to higher stresses. These stresses, have not, caused unacceptable distress.

Using the pile-supported stub-type abutment, steel-girder bridges up to 122 m (400 ft) in length may be easily constructed. Longer steel bridges may be constructed, with due consideration given to the forces and movements involved.

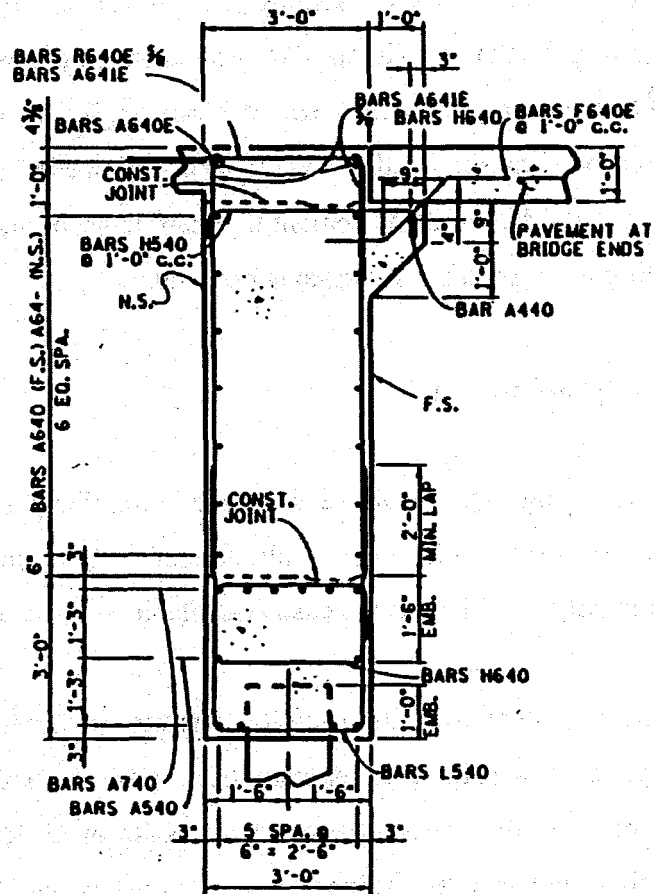

Figure 1.1 Typical cross section of integral abutment

Pile Configuration

Piles driven vertically and in only one row are highly recommended. In this manner, the greatest amount of flexibility, is achieved to accommodate cyclic thermal movements. Likewise, in seismic events, the dampening forces are engaged to the largest extent by the embankment backfill rather, than by the cap and piling, which would reduce the damage resulting from large displacements.

Pile Orientation

A survey taken in 1983 (27) demonstrated that the practice with regard to pile orientation differ in the various states in the US. Fifteen states orient the piling so that the

direction of thermal movement causes bending about the strong axis of the pile. Thirteen others orient the piling, so that the direction of movement causes bending about the weak axis of the pile. Orienting the piling for weak-axis bending offers the least resistance and facilitates pile-head bending for fixed head conditions. However, due to the potential for flange buckling, the total lateral displacement that can be accommodated is more limited than when the piling is oriented for strong-axis bending.

Anchorage of Beams to Pile Cap

Steel beams, being more sensitive to temperature changes than concrete beams, should be connected to the pile caps with anchor bolts prior to making integral connections. Fortunately, steel beams are easily adaptable to these connections.

Two details have been used successfully. The first involves placing the beams on $\frac{1}{4}$ " plain elastomeric pads (Fig. 1.2). Anchor bolts pass from the abutment pile cap through both the pad and the bottom flange of the beam or girder. The second method uses taller projecting anchor bolts equipped with double nuts—one above and one below the flange (Fig. 1.3). The latter method provides better control over the grade of the beam and requires less precision in preparing the bridge seats of the pile cap.

Both details provide a very desirable feature in that the superstructure and pile cap can move together, avoiding damage to the freshly poured concrete when the integral connection is made to lock the superstructure and abutment together. It is also recommended that a portion of the reinforcing bars located in the front face of the abutment pass continuously through the girder webs as shown in Figs. 1.2, 1.3 and 1.4.

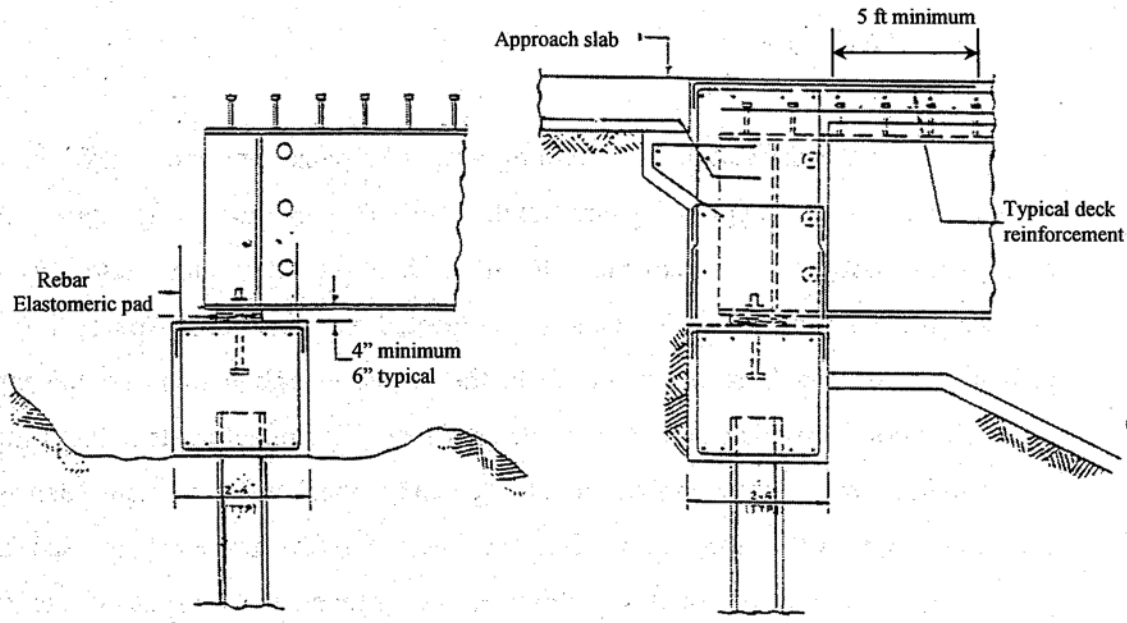

Figure 1.2 Integral abutment details

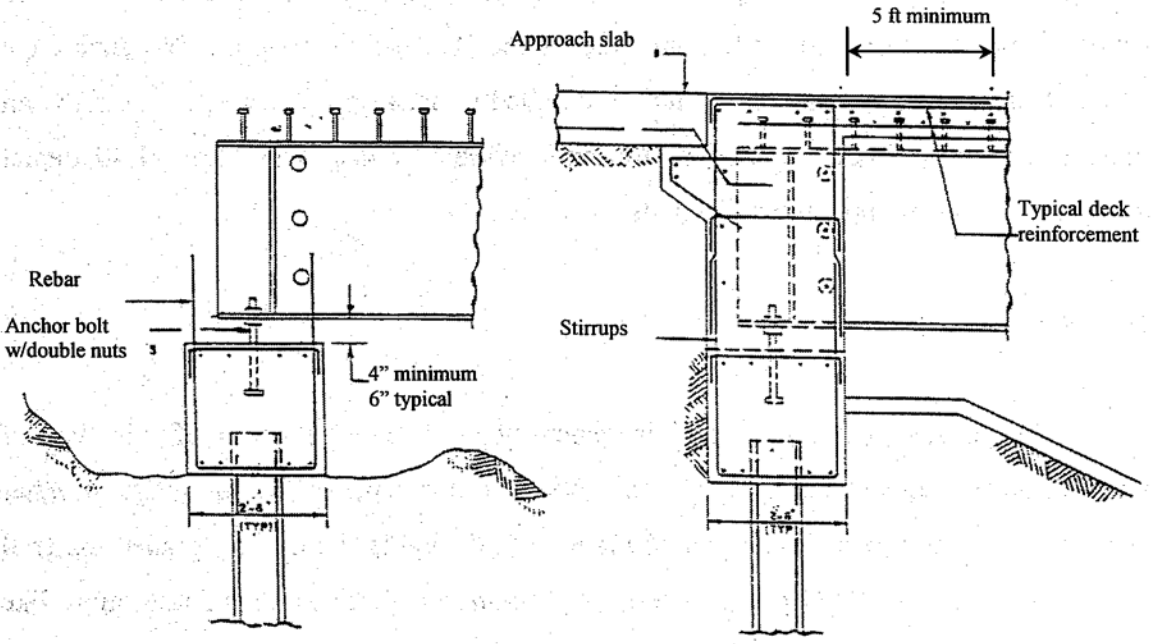

Figure 1.3 Integral abutment details

Approach Pavements

Due to the difficulties in obtaining proper embankment and backfill compaction around abutments, approach pavements are recommended especially for new construction. Approach pavements offer many benefits other than acting, as a bridge between the abutment and more densely compacted embankments. Approach pavements provide a transition from the approach to the bridge if embankment settlement occurs. Such transitions provide a smooth ride, thereby reducing impact loads to the bridge. They also provide greater load distribution at bridge ends, which aid in reducing damage to the abutments especially from overweight vehicles. Finally, properly detailed approach pavements help control roadway drainage, thus preventing erosion of the abutment backfill or freeze/thaw damage resulting from saturated backfill.

The approach slab must be anchored into the abutment backwall so that it moves in concert with the bridge. Otherwise, cyclic expansions force the slab to move with the bridge without a mechanism to pull it back when the bridge contracts. As debris fills the resulting opening, repeated cycles will ratchet the slab off its support. The anchorage used to fasten the approach slab should be detailed to act as a hinge so that the slab can rotate downward without distress as the embankment settles. Figs. 1.4a -1.4d depict desirable features of approach pavements.

Backfill

The porous granular backfill is generally used. The selection of this type of backfill has two advantages of easy compaction in close spaces, and drainage of water away from the abutments. Well-graded material is desirable. Uniformly graded material does not compact well and provides less interlocking of particles, thus acting more like marbles.

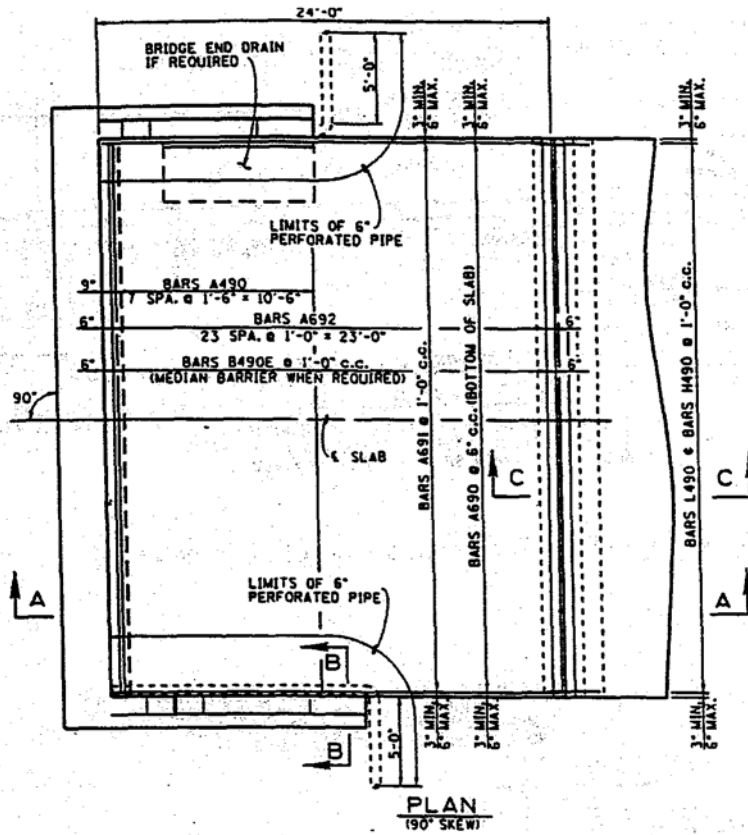

Figure 1.4a Plan view of approach slab

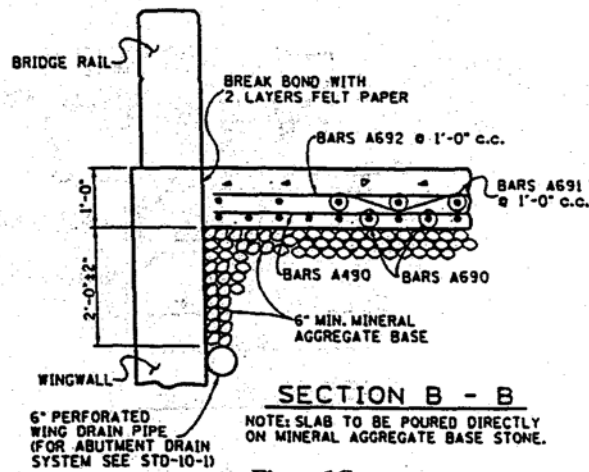

Figure 1.4b Cross section of wingwall and fill behind the abutment

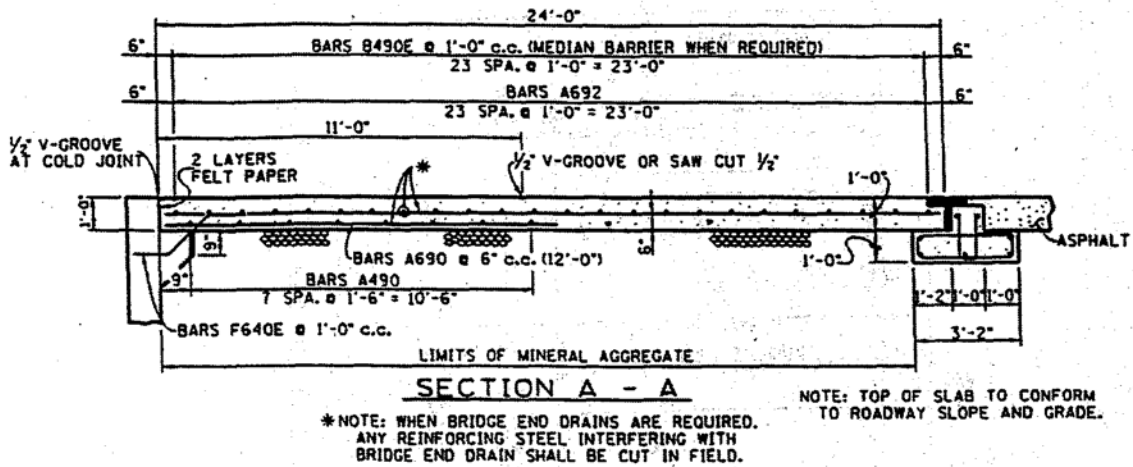

Figure 1.4c Reinforcement details of approach slab

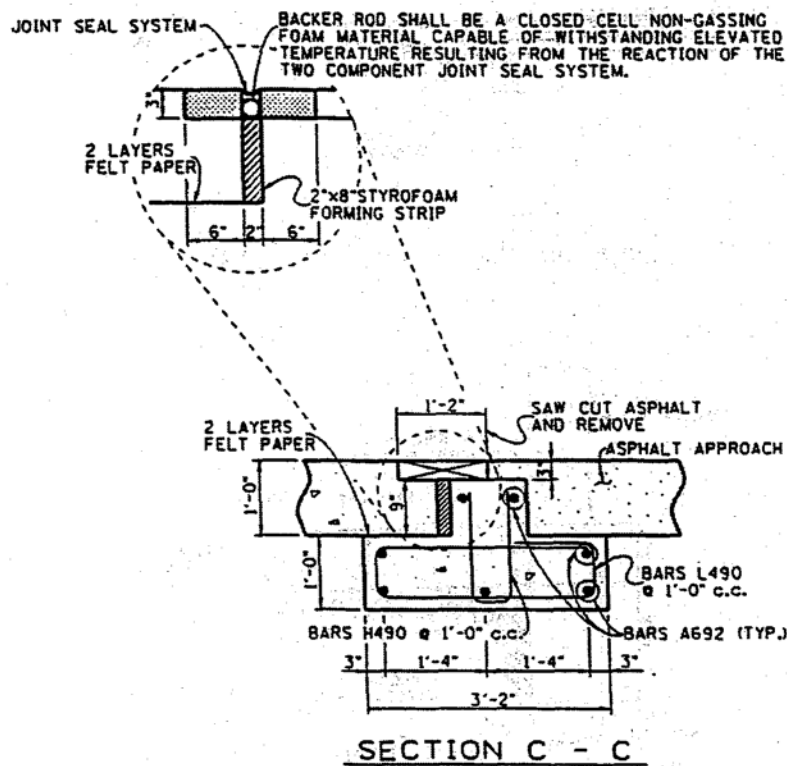

Figure 1.4d Joint details of approach slab and asphalt approach pavement

Drainage

The use of a vertical stone column about two feet width is recommended, with a height reaching, from the bottom of the abutment beam or pile cap to the top of the roadway subgrade. This drain should be placed between the abutment backwall and the embankment backfill. It should also wrap around the backwall between the parallel wingwalls and the roadway embankment since any settlement of the approach pavement would create a gap through which surface runoff will flow. A perforated drain pipe, overlying an impervious layer of soil or plastic, should be placed at the base of the vertical stone column and should be sloped to provide drainage away from the abutment area.

Provisions for Expansion

In all cases where the approach roadway or a ramp is, constructed of concrete, provisions for an expansion joint must be provided. Where the anticipated total movement at an abutment exceeds 13 mm ($\frac{1}{2}$ in.) and the approach roadway is asphalt, an expansion joint should be considered. The reason for the latter is that larger movements can damage asphalt adjacent to the end of the approach pavement in the expansion cycle. During the contraction phase, a significant gap is created through which water can infiltrate the subgrade. If regular maintenance can be arranged to fill this gap with a suitable joint sealer in cold weather, no joint will be needed.

If expansion joints are provided, the joints should only be located at the roadway end of the approach pavement. It is a certainty that the joint system will fail at some future time.

It is recommended that joints similar to the one shown in Fig. 1.4d be used, and not joints that contain metal hardware for anchorage. This will avoid the problem of replacing or raising the joint in the event of future overlay on the bridge. The joint shown in Fig. 1.4d may simply be replicated in the same manner in which it was originally installed over the existing joint.

Construction Sequence

The following sequence is recommended when constructing- steel bridges with integral abutments to reduce the effects of thermal movements on fresh concrete and control moments induced into the supporting pile system:

i) Drive the piling and pour the pile cap to the required-bridge seat elevation. Install one of the desired anchoring systems and pour the pile caps for the wingwalls concurrently.

ii) Set the beams/girders and anchor them to the abutment. Slotted holes in the bottom flanges are recommended to aid in the erection since the temperature will vary from the time that the anchors are set in the cap to the time that the girders are fully erected. Do not fully tighten the anchor nuts at this time; instead, leave free play for further dead-load rotations.

iii) Pour the bridge deck in the desired sequence excluding the abutment backwall/diaphragm and the last portion of the bridge deck equal to the backwall/diaphragm width. In this manner, all dead-load slab rotations will occur prior to lock-up, and no dead-load moments will be transferred to the supporting piles.

iv) Tighten the anchor nuts and pour the backwall/diaphragm to the full height. Since no backfilling has occurred to this point, the abutment is free to move without overcoming passive pressures against the backwall/ diaphragm. The wingwalls may also be poured concurrently.

v) Place the vertical drain system and backfill in 152-mm (6 in.) lifts until the desired subgrade elevation is reached. Place a bond breaker on the abutment surfaces in contact with the approach pavement.

vi) Pour the approach pavement starting at the end away from the abutment and progressing toward the backwall. Approach pavements may be poured in the early morning so that the superstructure is expanding, and therefore, not placing the slab in tension.

1.2 Colorado Department of transportation ⁽⁶⁾

There are many bridges that were designed and built with integral abutment or end diaphragm type abutments on a single row of piles. Although these bridges were built without expansion devices or bearings, they continue to perform satisfactorily. The primary objective of this type of abutment is to eliminate or reduce joints in bridge superstructures. The integral abutment can also simplify design, detailing, and construction. The integral abutment eliminates bearings and reduces foundation requirements by removing overturning moments from the foundation design. Integral abutment and end-diaphragm-type abutments without expansion devices or bearings shall be used where continuous structure lengths are less than the following (Table 1.1). These lengths are based on the center of motion located at the middle of the bridge, and moment of 50 mm (2 in.) temperature range. The temperature range assumed is 45 °C (80 °F) for steel structures with concrete deck and 40 °C (70 °F) for concrete structures, as per the *AASHTO Guide Specifications for Thermal Effects in Concrete Bridge Superstructures*.

Table 1.1 Maximum length of integral bridge

Type of girder	Maximum structure length
Steel	195 m (640 ft)
Cast-in-place or precast concrete	240 m (790 ft)

Pretensioned or post-tensioned concrete should have a provision for creep, shrinkage, and elastic shortening, if this shortening plus movement due to decrease in temperature exceeds 25 mm (1 in.). Temporary sliding elements between the upper and

lower abutment may be used, or details that increase the flexibility of the foundation as discussed below. Steps must also be taken to ensure the movement capability at the end of the approach slab is not exceeded.

Greater lengths may be used if analysis shows that abutment, foundation, and superstructure design limits are not exceeded, and movement at the end of approach slab is within the capabilities. The calculations backing up the decision shall be included with the design detail for the structure.

In some cases, site conditions and/or design restraints may not allow the use of this type of abutment, but oversized holes drilled for the piling and filled with sand or a cohesive mud (which flows under long term creep shortening) may be used to compensate for lack of pile flexibility. If caissons or spread foundations are used in lieu of the piles, sliding sheet metal with elastomeric pads may be used on top of caissons or spread foundations when a pinned connection does not provide enough flexibility.

Integral abutments may be placed on shallow or deep foundations behind retaining walls of all types. Integral diaphragms have been founded on old retaining wall stems or old abutment seats as well. Several structures with tall integral abutments have been built with a gap between the abutment and reinforced fill to reduce earth pressures. However, it may be impractical to extend the thermal motion capabilities substantially and the joint at the end of the approach slab has a limited capability.

Poorly balanced earth pressures due to severe skews (less than 56 degrees between abutment axis and the allowed direction of motion) may be dealt with by battering piles perpendicular to the planned and allowed motion to resist the unbalanced earth pressures. Piling details of standard integral abutment are shown in Fig. 1.5.

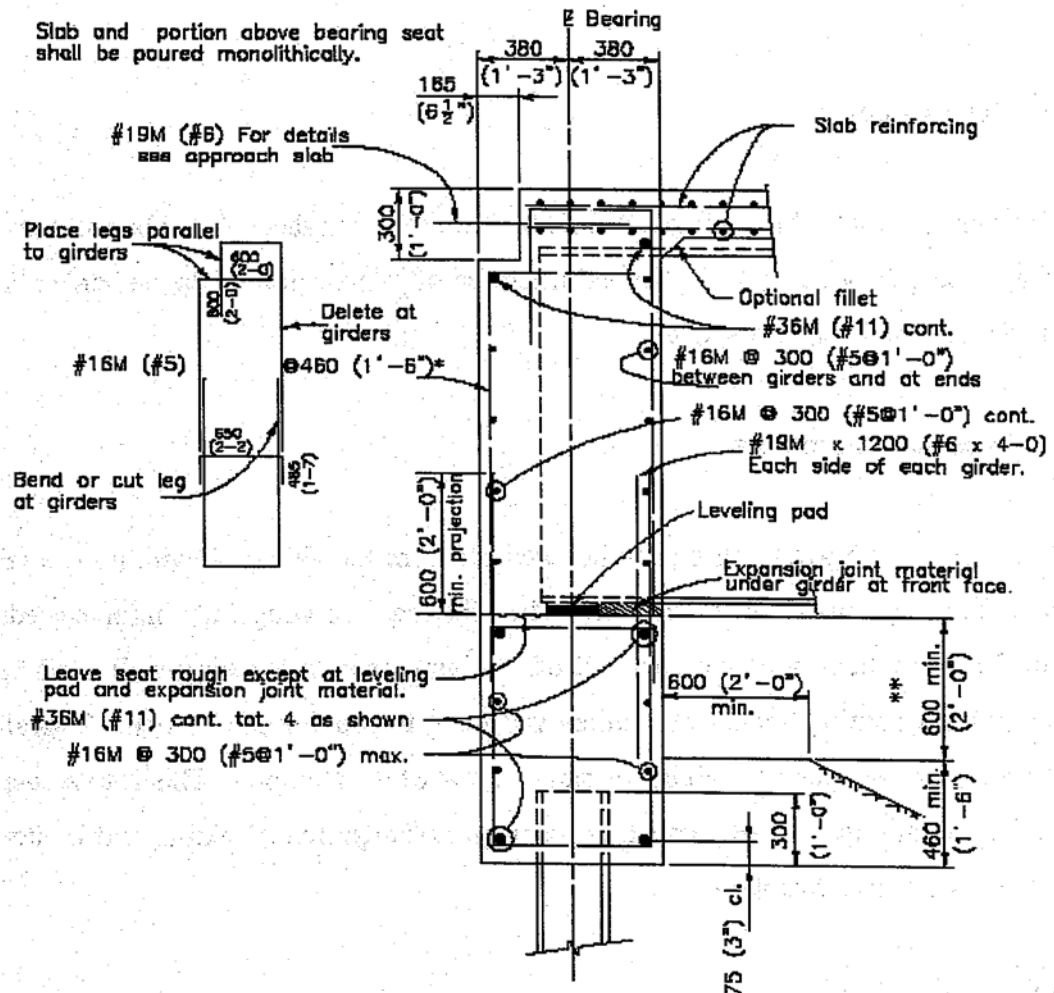

TYPICAL ABUTMENT SECTION

Note: All abutment and wingwall concrete shall be Class D (Bridge)

Extend strands from the bottom of precast sections into abutment, anchor the bottom of steel sections to abutment with studs, bearing stiffeners, anchor bolts, or diaphragm gussets.

* 300 (1'-0") if structure length longer than 90M (300') or ** greater than 1050 (3'-6").

Figure 1.5 Typical abutment section

Wingwall

Wingwall Design Length

The design length of the wingwall shall be from the back face of the abutment and shall end approximately 1.2 m (4 ft) beyond the point of intersection of the embankment slope with the finished roadway grade.

Wingwall Foundation Support

Normally, a wingwall will be cantilevered off from the abutment with no special foundation support needed for the wingwall. When the required wingwall length exceeds the length for a practical wing cantilevered off the abutment, a retaining wall shall be used along with a nominal length of cantilevered wing to provide the needed wingwall length. The foundation support shall be the same as that of the abutment. This is to reduce the risk of the retaining wall settlement, subsequent misalignment, leaking, and broken joints that are difficult to maintain.

Wingwall Design Loads

The design shall be based on an equivalent fluid pressure of 5655 N/m^3 (36 psf) and a live load surcharge of 0.6 m (2 ft) of earth. The equivalent fluid pressure and live load surcharge shall be applied to the full depth of the wingwall at the back face of the abutment and a depth 0.9 m (3 ft) below the elevation of the embankment at the outside of the end of the wing. This pattern of loading shall be used only for wingwalls cantilevered off the abutment. Retaining walls shall be fully loaded as required for their design height. The design of wings cantilevered off the abutment also shall provide for a 71.2 kN (16 kip) wheel load with impact located 0.3 m (1 ft) from the end of the wingwall. Under this vertical loading condition, a 50 percent overstress is allowed in combination with other forces. The design of wingwalls also shall provide for the 44.5 kN (10 kip) horizontal force applied to the bridge railing and distributed according to

AASHTO. Under this horizontal loading condition, no other loads, including earth pressure, need be -considered.

Approach Slabs

Approach slabs are used to alleviate problems with settlement of the bridge approaches relative to the bridge deck. The main causes of this settlement are movement of the abutment, settlement and live load compaction of the backfill, moisture, and erosion. Approach slabs shall be used under the following conditions:

- i) Overall structure length greater than 76.2-m (250 ft).
- ii) Adjacent roadway is concrete.
- iii) Where high fills may result in approach settlement.
- iv) When the Department of Transportation Districts request them.
- v) All post-tensioned structures.

In all cases, the approach slab shall be anchored to the abutment. When the adjacent roadway is concrete, an expansion device shall be required between the end of roadway and the end of approach slab. Approach slab notches shall be provided on all abutments, regardless of whether or not an approach slab will be placed with the original construction.

1.3 Federal Highway Administration

Background

After observing the successful performance of many older structures either constructed without joints or performing with inoperative joints, several states have elected to design and construct short and moderate length bridges without joints.

In July 1972, South Dakota State University issued a study report entitled "Analysis of Integral Abutment Bridges" by Henry W. Lee and Mumtaz B. Sarsam⁽¹⁵⁾.

This study was conducted to investigate the stresses induced by thermal movements in the girder and upper portion of steel bearing piles of integral abutment-type bridges.

A quote from State of Tennessee "Structure Memorandum" defines an unrestrained abutment as follows:

"When the total anticipated movement at an abutment is less than two inches and the abutment is not restrained against movement, no joint will be required and the superstructure, abutment beam and reinforced pavement at bridge ends will be constructed integrally. An unrestrained abutment is one that is free to rotate such as a stub abutment on one row of piles or an abutment hinged at the footing."

Continuous steel bridges with integral abutments have performed successfully for years in the 91.4m (300 ft) range, notably in North Dakota and Tennessee. Continuous concrete structures 152.4 - 182.9 m (500- 600 ft) long with monolithic abutments have given excellent long term performance in Kansas, California, Colorado and Tennessee.

Recommendation

It is recommended that bridges with their overall length less than the following values be constructed continuous and, if unrestrained, have integral abutments. Greater values may be used when experience indicates such designs are satisfactory.

Table 1.2 Maximum length of integral bridge

Type of bridge	Maximum length
Steel	91.4 m (300 ft)
CIP	152.4 m (500 ft)
Pre-or Post-tensioned Concrete	182.9 m (600 ft)

Approach slabs are needed to span the area immediately behind integral abutments to prevent traffic compaction of material where the fill is partially disturbed by abutment movement. The approach slab should be anchored with reinforcing steel to superstructure and have a minimum span length equal to the depth of abutment (1 to 1 slope from the bottom of the rear face of the abutment) plus a 1.2 meter (4 ft) minimum soil bearing area. A practical minimum length of slab would be 4.3 m (14 ft). Fig. 1.6 shows the details.

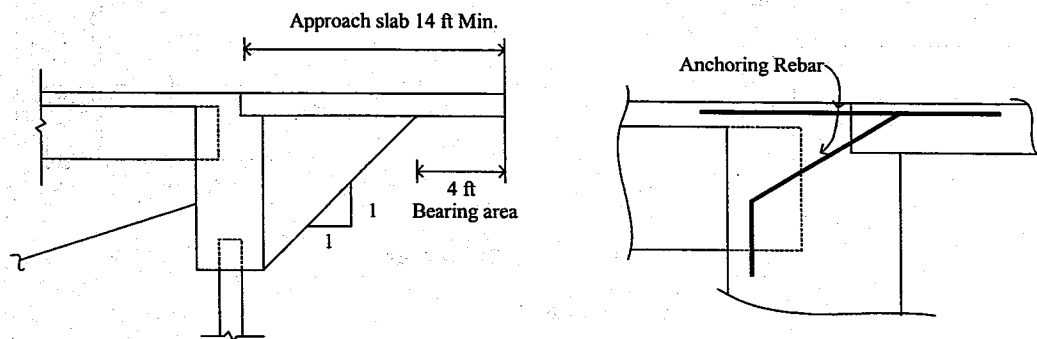

Figure 1.6 Approach slab

The design of the approach slab should be based on the American Association of State Highway Transportation Officials (AASHTO) specifications for Highway Bridges Article 1.3.2.3 Case B, where design span "S" equals slab length minus 2feet.

Positive anchorage of integral abutments to the superstructure is strongly recommended.

North Dakota provides a roadway expansion joint 152 in (50 ft) from end of bridge to accommodate any pavement growth or bridge movement. This is considered desirable.

Typical Integral Abutment Details

Figs. 1.7, 1.8 and 1.9 show examples of typical details used by some highway agencies. Even though not included in the details shown below, anchorage of the approach is strongly recommended.

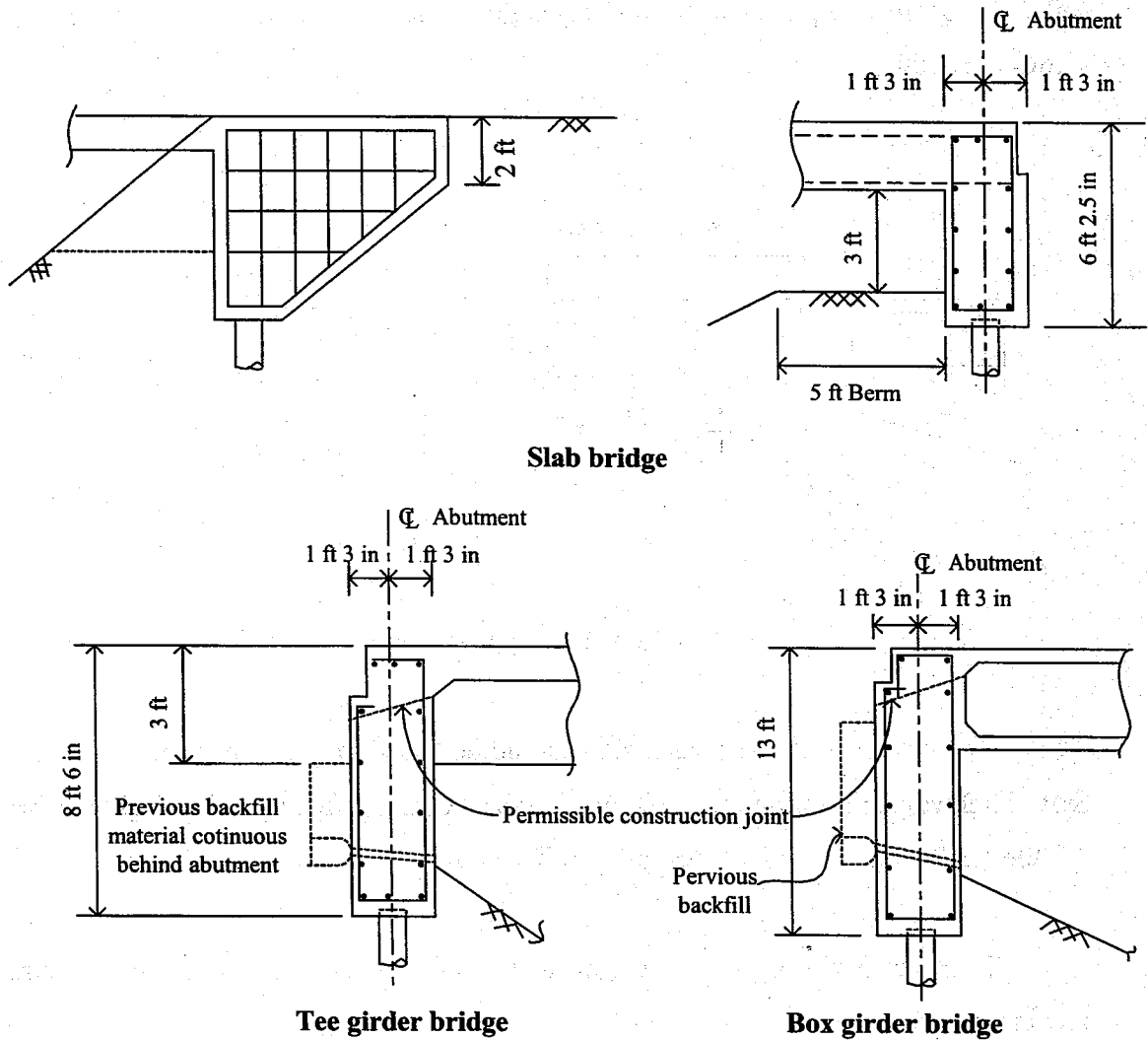

Figure 1.7 Cast in place concrete (California)

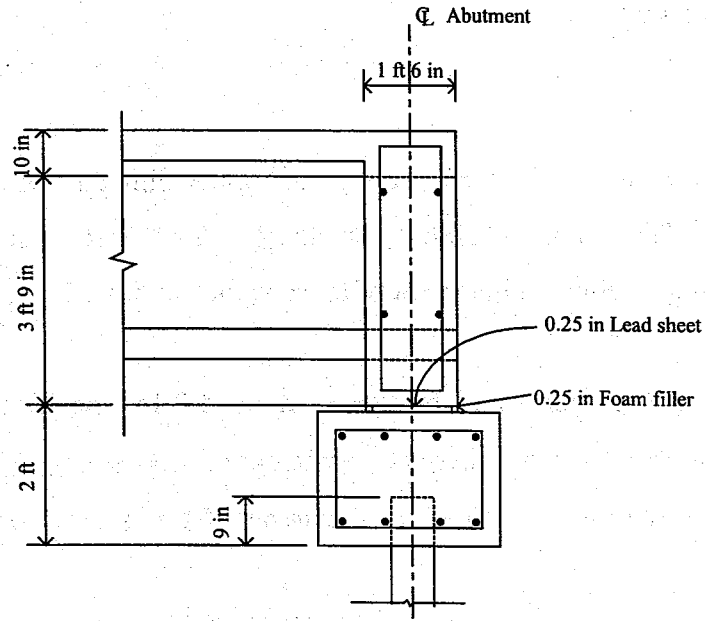
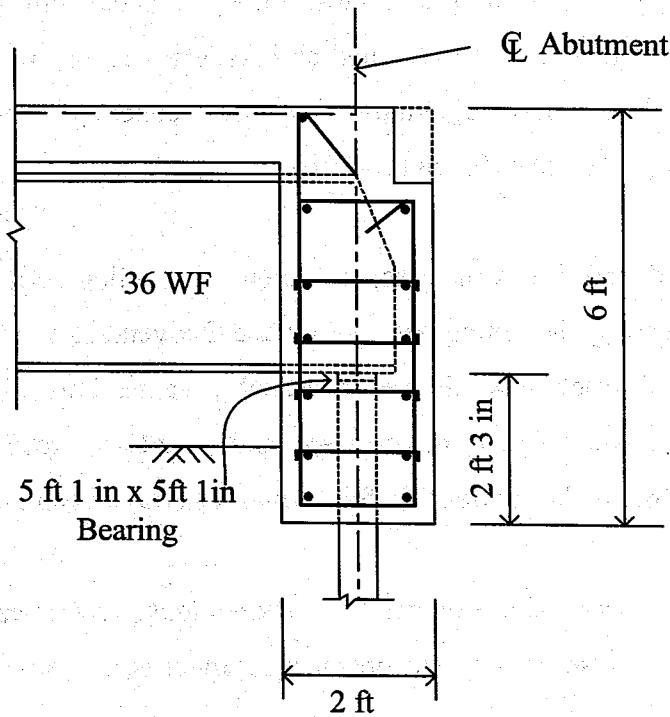

Figure 1.8 Prestressed concrete I-beam (FHWA region 15)



State of Missouri

Figure 1.9 Steel girder integral abutment bridges (Missouri)

Provision for Movement

i) Background

Thermal movements are predicted on the cold climate temperature ranges specified in the AASHTO bridge specifications, Article 1.2.15. State standards specifying other temperature ranges require adjustment of those values indicated.

For structural steel -supported bridges, Article 1.2.15 specifies old climate temperature range of 150 °F with a thermal coefficient of 0.0000065, resulting in a total thermal movement of 32 mm (1 ¼in.) of movement per 30.5 m (100 ft) of structure.

For concrete superstructures, the AASHTO bridge specification recommends a cold climate temperature range of 80° F, and a thermal coefficient of 0.0000060 and a shrinkage factor of 0.0002. However, this shrinkage effect can be reduced provided the normal construction sequence allows the initial shrinkage to occur prior to completion of the concrete operations. Based on an assumed shrinkage reduction of 50 percent, total allowance for thermal and shrinkage movement in a concrete structure would be approximately 19 mm (¾in.) per 30.5 m (100 ft).

For prestressed concrete structures, a somewhat smaller total movement will occur once the prestressing shortening has taken place. Movement of 15.9 mm (5/8 in.) per 30.5 m (100 ft) of structure would be a reasonable value. This allows for thermal movement and assumes no effect from shrinkage and long-term creep. This value has been substantiated in the field as reasonable for normal highway overcrossing structures. In long pre- or post-tensioned concrete structures long-term creep may occur; but is normally insignificant insofar as provision for movement is concerned and, therefore, has not been included.

The flexibility of individual substructure units will affect the distribution of the total movement between specified joints.

ii) Recommendations:

Cold Climate Conditions: Based on the above, Fig. 1.10 may be used for determining the required provision for total movement under cold climate conditions.

Moderate Climate Conditions: In accordance with AASHTO Article 1.2.15, for moderate climate conditions a 20 percent reduction in the temperature ranges of 120 °F (steel) and 70 °F (concrete) may be used.

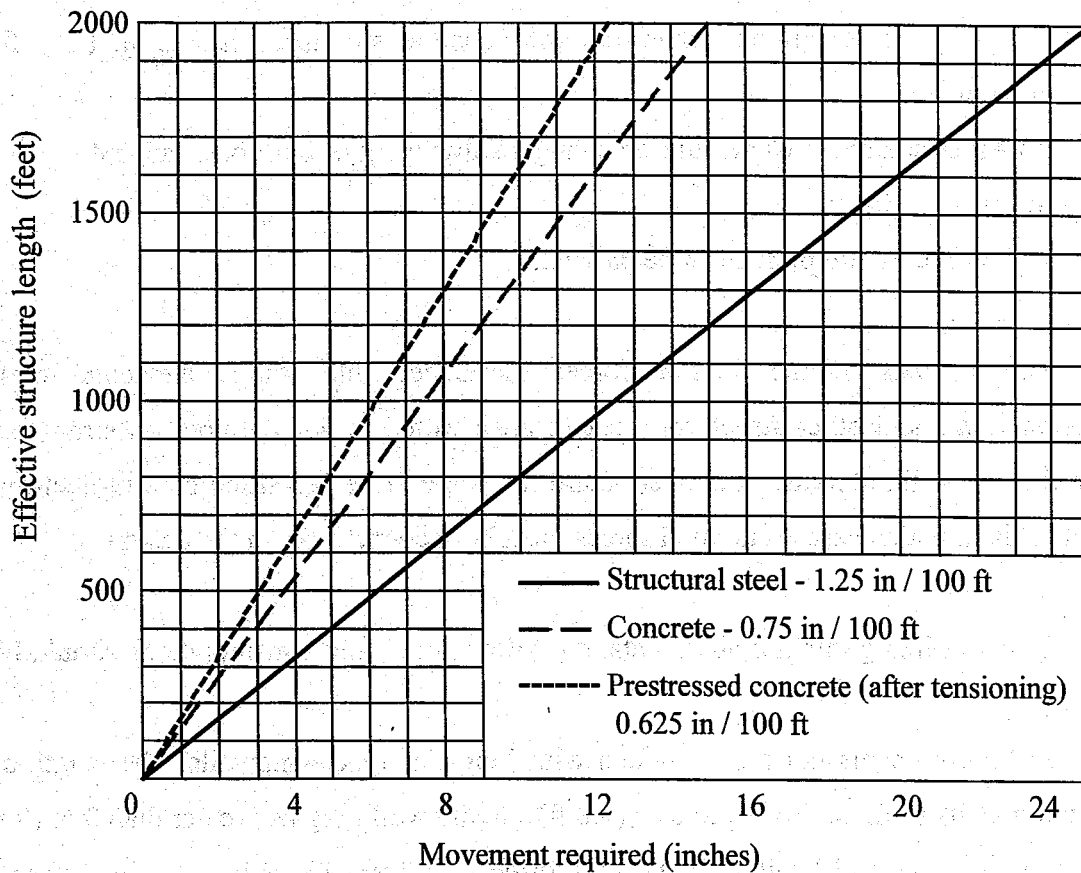

Figure 1.10 Required provision conditions

1.4 Illinois Department of Transportation ⁽¹⁶⁾

Traditionally, bridges are designed with expansion joints and other structural releases that allow the superstructure to expand and contract freely with changing temperatures. Integral abutment bridges eliminate expansion joints in the bridge decks, which reduce the initial construction cost as well as continued maintenance costs. The use of integral abutment structures is permitted when the proposed structure meets the following limitations:

- i) Maximum skew of 30°.
- ii) Total length (along centerline) for steel structures is 85 m (310 ft) maximum.
- iii) Total length (along centerline) for concrete structures is 115 m (410 ft) maximum.
- iv) All structures must be built on a tangent alignment or built on a tangent (no curved girders).
- v) Abutments and piers must be parallel.

The analysis of the thermal forces introduced into bridge elements when expansion joints and other structural releases are omitted is not required on structures within the above limitations. Longer structure lengths will be permitted on a project-by-project basis in which case all thermal forces must be accounted for in the design.

When utilizing integral abutments, the following design considerations should be made:

- i) All abutments must be provided with 'dog-ear' type wingwalls. The length of these wing walls shall be limited to 3 m (9.8 ft). If wingwall lengths greater than 3 m (9.8 ft) are required, the wall lengths should be shortened to 3 m (9.8 ft) by allowing the soil to wrap around the front face of the wingwall. The wingwalls on skew structures are typically placed parallel to the centerline of the abutment; however, they may be placed at right angles to the centerline of the roadway.

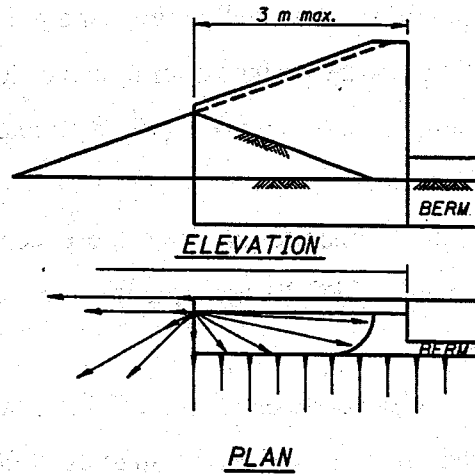
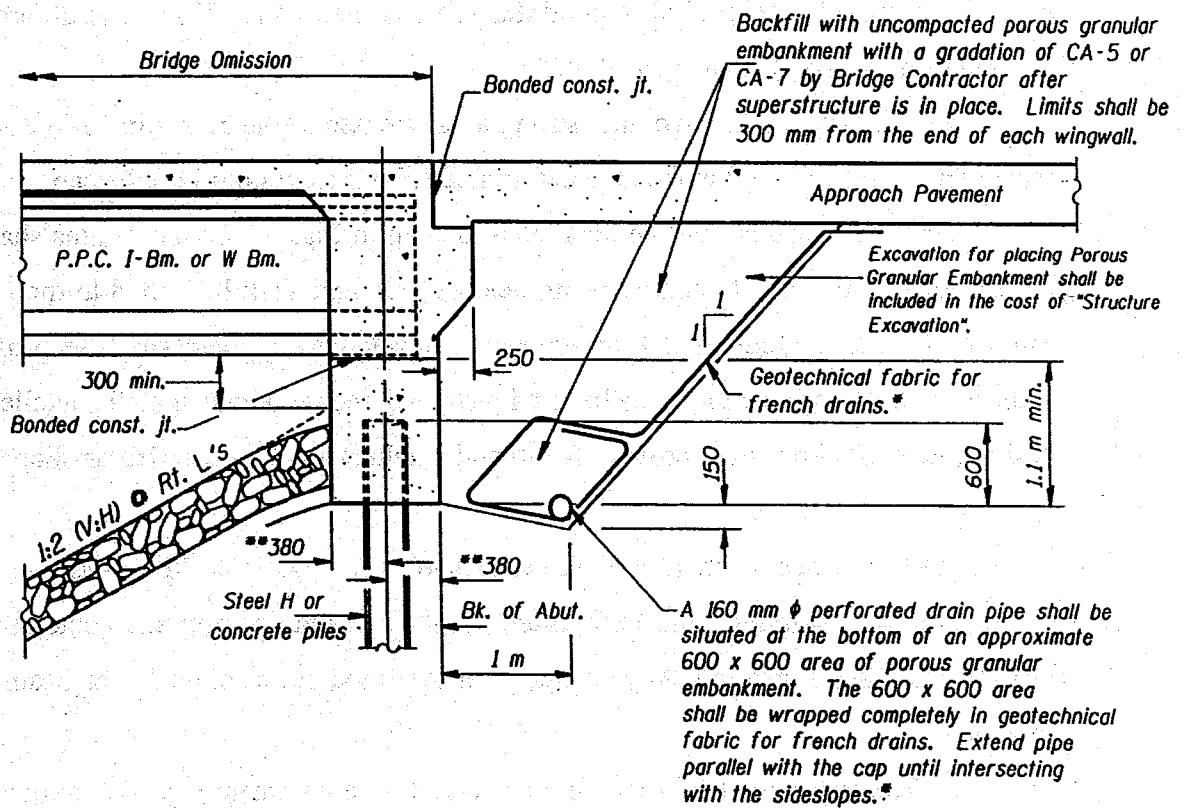

Figure 1.11 Integral abutment wingwall embankment



*Included in the cost of "Porous Granular Embankment".
 **450 mm for Bulb-T.

Figure 1.12 Section through integral abutment

ii) The abutment backfill must be well drained and noncompacted (Fig. 1. 12).

iii) Although steel H piles are preferred for structure lengths up to 60 m (196.8 ft) and required for structure lengths between 60 m (196.8 ft) and 115 m (337.3 ft), concrete piles will be permitted as follows:

a) The standard concrete, pile with the exception of Precast Prestressed Concrete Pile (PPC-P) are permitted for structure lengths up to 27m (88.6 ft).

b) The precast concrete or 356 mm (14 in.) diameter metal shell piles are permitted for structure lengths up to 60 m (196.8 ft).

iv) Pile encasements shall be provided for abutments with steel H piles.

v) Pile reinforcement shall be provided in all metal shell piles at abutments.

vi) When hard soils are encountered, 150 mm (6 in.) of porous granular embankment shall be placed all around the pile encasement for H Piles or all around the top 900 mm (35.4 in.) of metal shell piles.

vii) All piles shall have their strong axis oriented to the centerline of the abutment as shown in Fig. 1.13 and embedded 600 mm (23.6 in.) minimum into, the cap. .

viii) Steel beams shall be detailed as shown in Fig. 1.14. Steel beams shall be set on lead plates covering the entire beam bearing area and shall be bolted to the; abutment caps. If the beam grade is 2% or greater, a beveled shim plate shall be provided in addition to the neoprene mat. The beveled plate and neoprene mat shall be detailed on the design plans. Shallow steel beams (W690 and smaller) shall be detailed as shown in Fig. 1.15.

ix) PPC-I-beams shall be detailed as shown in Fig. 1.16. PPC-I-beams shall be set on an initial 15 mm (0.6 in.) minimum grout (2:1 sand and portland cement, very dry mix) to provide full bearing. Any excess grout squeezed out from under the beam shall be removed.

x) The superstructure shall be connected to the abutment cap with a minimum of #15(E) bars at 300 centers. (Figs. 1.14 and 1.16).

xi) The bridge deck shall be connected to the approach pavement with 20 mm (8 in.) diameter, bar splicers at 300 mm (11.8 in.) center to center. (Figs. 1.14 and 1.16).

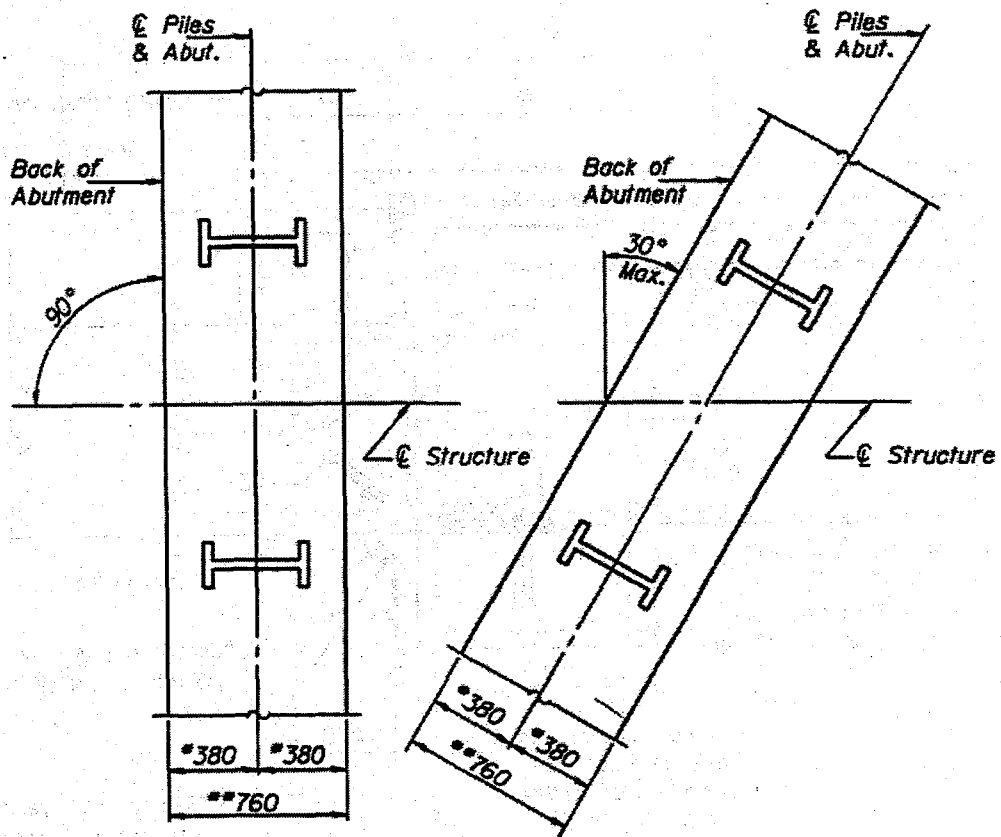

Figure 1.13 Integral abutment plan (showing pile orientation)

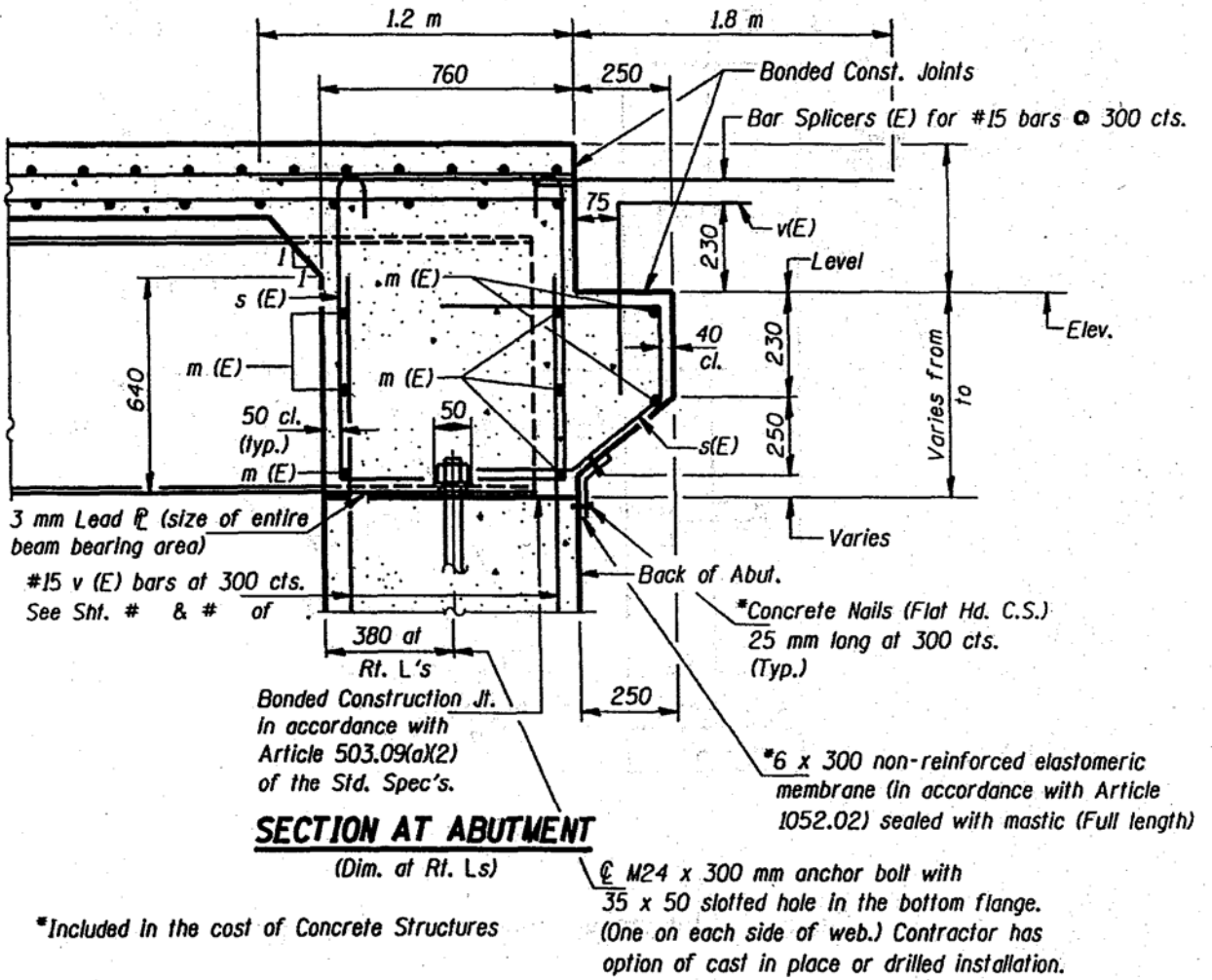

Figure 1.14 Integral abutment for steel beams

.1 I L. r-r r .
I l r r II

1 1
i

r r

r r II r

r r II

MunTo

r r I.

m

1

r r r r r

r r r r r

r r r r

r r r r r

r r r r

r r r r r

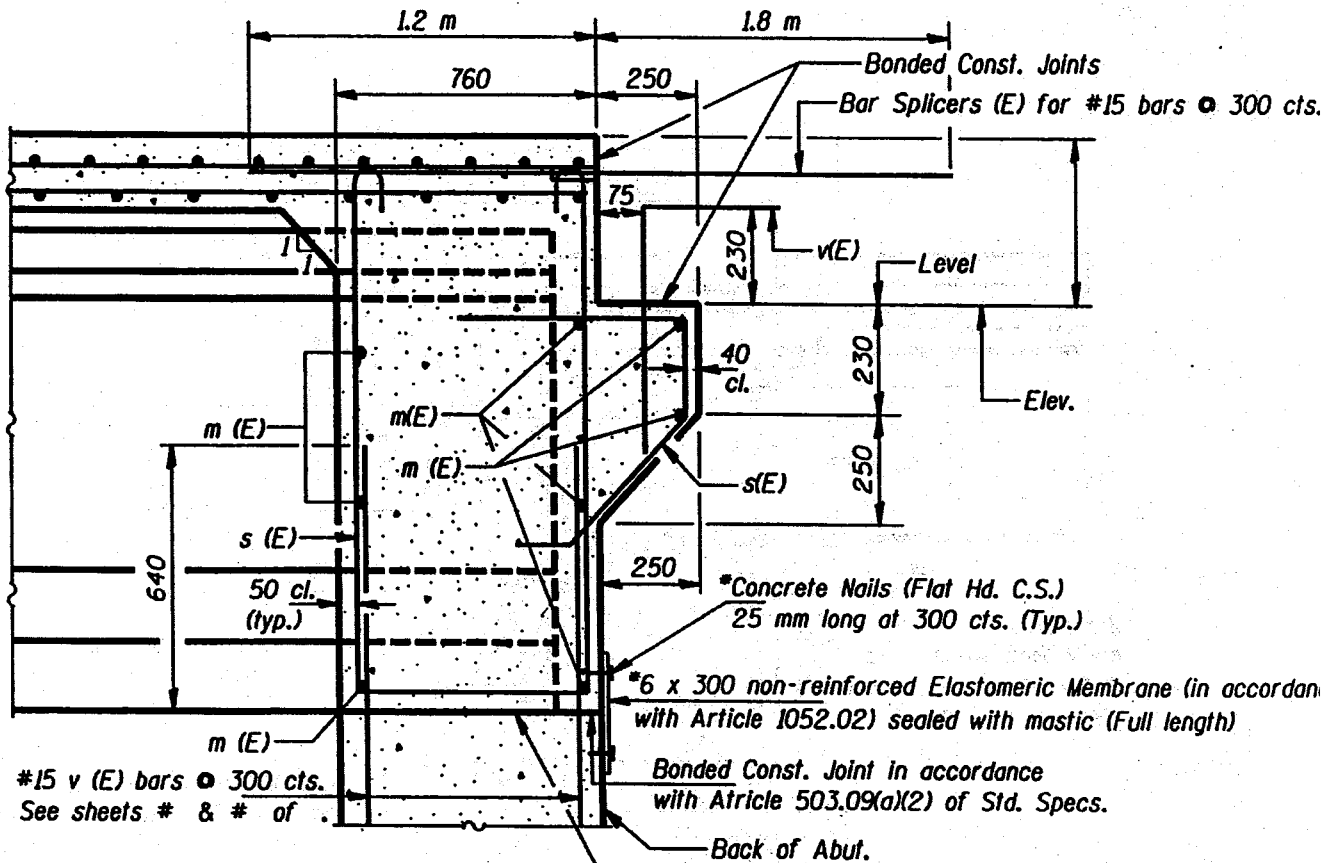

#15 v (E) bars @ 300 cts.
See sheets # & # of .

**SECTION
AT ABUTMENT**
(Dim. at Rt. Ls)

*Included in the cost of Concrete Structures

Beam ends shall be set on an initial 15 mm Min. grout (2:1 sand and portland cement, very dry mix) to provide full bearing. Any excess grout squeezed out from under the beam shall be removed. Included in the cost of Concrete Structures.

Figure 1.16 Integral abutment for PPC-I beams

1.5 Maine Department of Transportation ⁽¹⁷⁾

Design of integral abutment bridges has evolved over the last 25 years as transportation departments have gained confidence with the system. Bridge lengths have gradually increased without a rational design approach. Tennessee, South Dakota, Missouri and several other states allow lengths in excess of 90 m (274 ft) for steel structures and 180 m (549 ft) for concrete structures.

Thermally induced pile head translations in bridges of this length cause pile stresses which exceed the yield point. Greimann et al.⁽¹¹⁾ performed research during the 1980's to develop a rational design method for integral abutment piles which considers the inelastic redistribution of these thermally induced moments. This method is based upon the ability of steel piles to develop plastic hinges and undergo inelastic rotation without local buckling failure. This method is not recommended for concrete or timber piles which have insufficient ductility:

Four steel piles most commonly used by the Maine Department of Transportation (MDOT) were evaluated and maximum bridge length and maximum design pile load design guidelines were developed based upon the Greimann findings. The piles were evaluated as beam-columns without transverse loads between their ends, fixed at some depth and either pinned or fixed at their heads. Figs. 1.17, 1.18 and 1.19 show typical details of integral abutments.

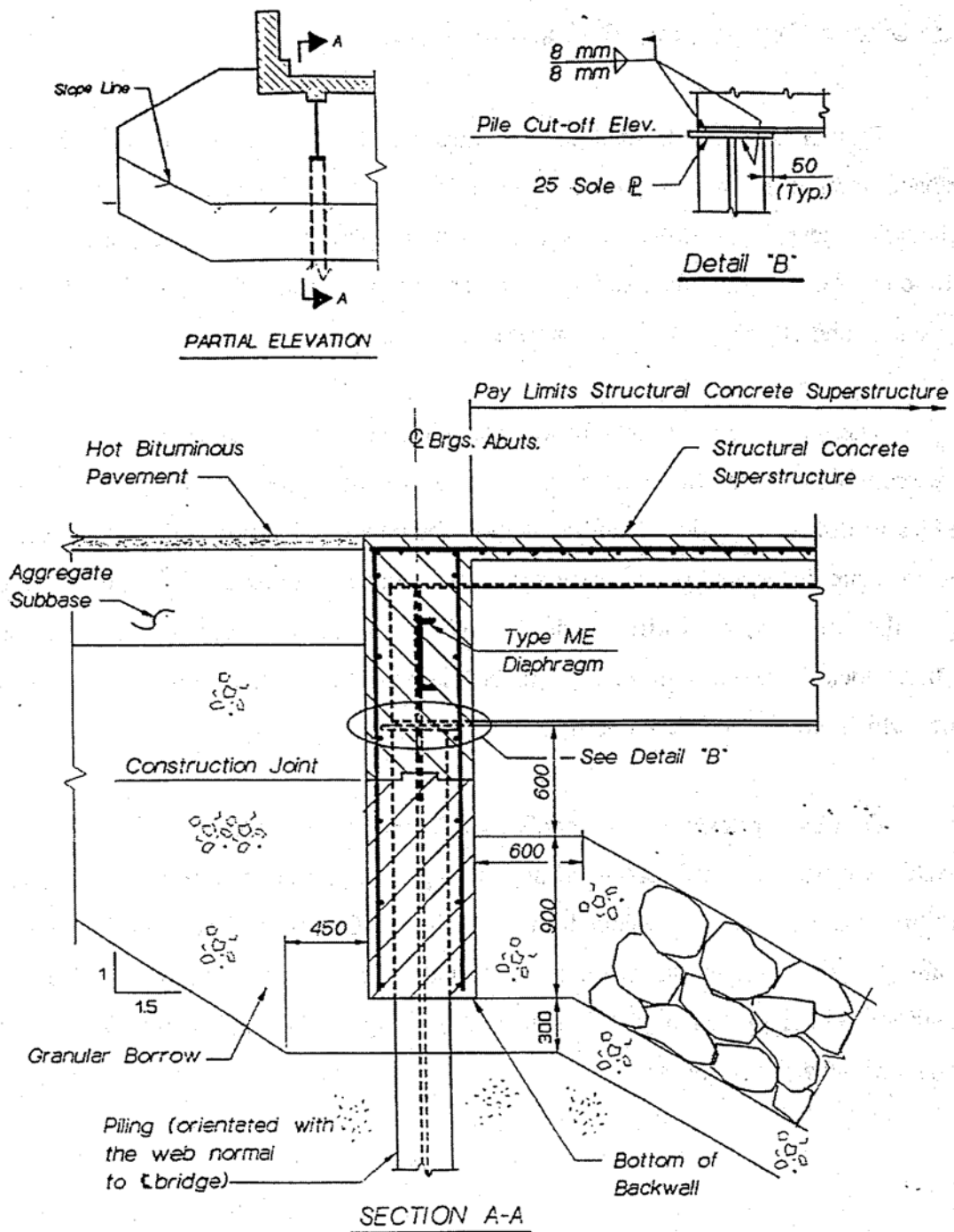

NOTE: All dimensions are in millimeters (mm) unless otherwise noted.

Figure 1.17 Integral abutment detail

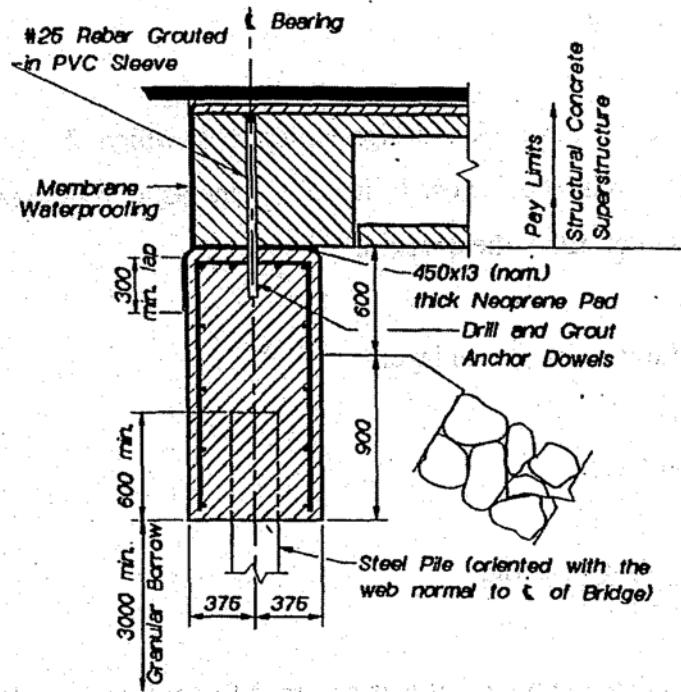

Figure 1.18 Pinned head integral abutment (for precast/ prestressed superstructure)

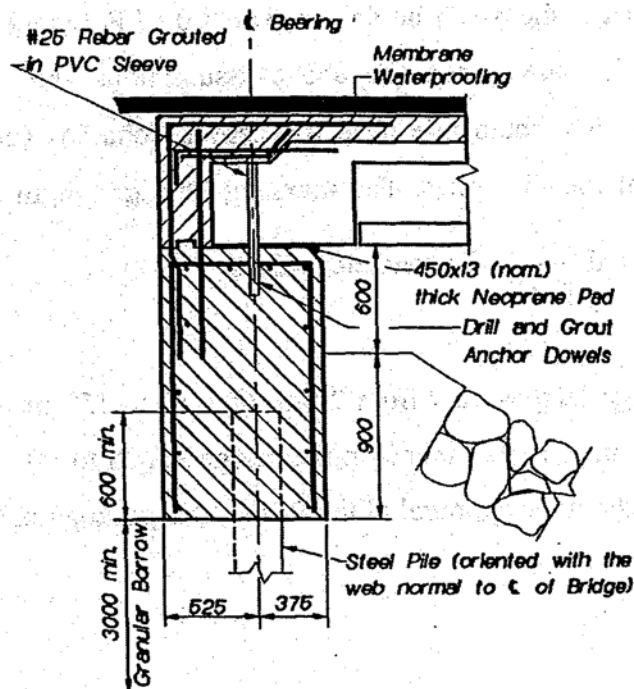

Figure 1.19 Fixed head integral abutment (for precast/ prestressed superstructure)

i) Maximum Bridge Length

Greimann et al.⁽¹¹⁾ developed design criteria by which the rotational demand placed upon the pile must not exceed the pile's inelastic rotational capacity. The following system variables affect the demand.

- i) Soil type
- ii) Depth of overlying gravel layer
- iii) Pile size
- iv) Pile head fixity
- v) Skew
- vi) Live load girder rotation

In order to simplify the policy, it was assumed that piles would be driven through a minimum of 3 m (9.8 ft) of dense gravel. Material below this level has very little influence on pile column action. It was also assumed that the live load (LL) girder end rotation stresses induced in the pile head do not exceed $0.55 F_y$ (which provides a known LL rotational demand). Based upon the above assumptions and the pile's inelastic rotational capacity, the maximum pile head translation, delta (Δ) (in millimeters) was established for each of the four piles. The maximum bridge length (in meters) equals $\frac{4\Delta}{1.04}$ for steel bridges and $\frac{4\Delta}{0.625}$ for concrete bridges.

Maximum bridge lengths vary from 20, m (65.6 ft) to 152 m (498.7 ft) for some piles. This policy currently limits the maximum bridge length to 60 m (196.8 ft) which cannot be exceeded without the approval of the Bridge Design Engineer.

ii) Pile Capacity

Pile capacity is governed by the axial and biaxial bending column action of the pile. Axial stresses result from vertical superstructure live and dead loads, abutment and pile dead load, and secondary thermal force (multi span structures only, Fig. 1.20).

The P- Δ effect of the vertical pile load is the only moment considered. Thermal translation moments and live load girder rotation moments are assumed to be redistributed through inelastic rotation.

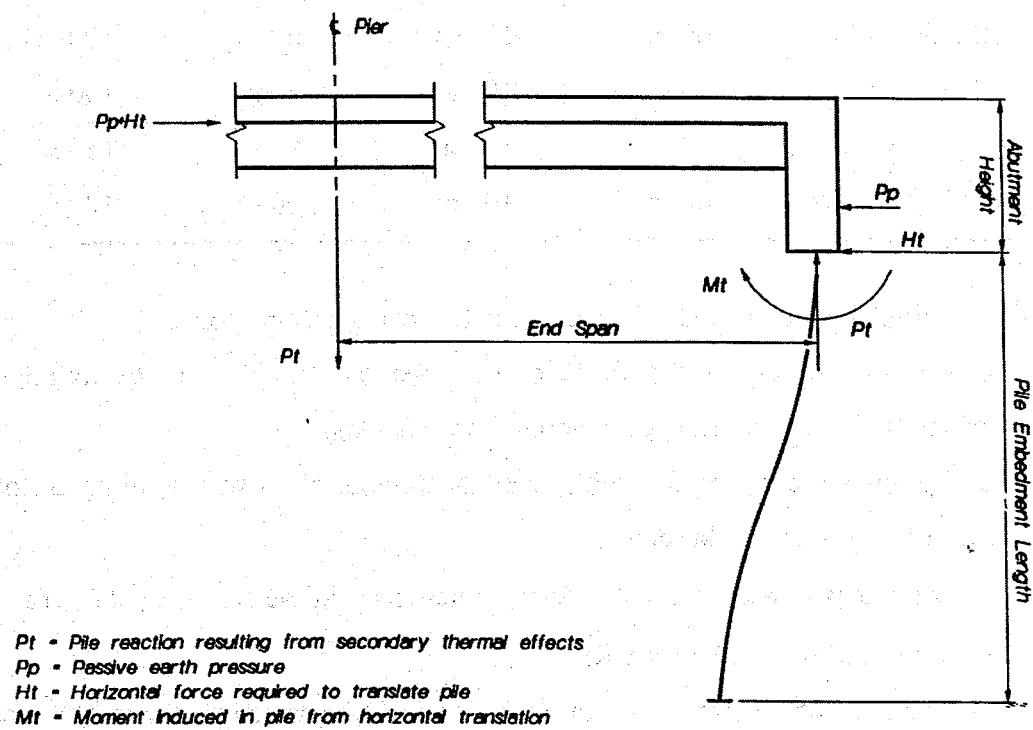

Figure 1.20 Thermally induced secondary pile force

iii) Bridge Length: Pile Supported Abutments

Table 1.3 Maximum bridge length for fixed head abutment

Pile size	0° to 20° skew		≥ 20° to 25° skew	
	Steel	Concrete	Steel	Concrete
HP 250 x 62	60 m	100 m	42 m	70 m
HP 310 x 79	40 m	65 m	22 m	38 m
HP 360 x 108	36 m	60 m	20 m	35 m
HP 360 x 132	60 m	100 m	60 m	100 m

Table 1.4 Maximum bridge length pinned head abutment

Pile size	0° to 20° skew		≥ 20° to 25° skew	
	Steel	Concrete	Steel	Concrete
HP 250 x 62	60 m	100 m	60 m	100 m
HP 310 x 79	60 m	100 m	60 m	100 m
HP 360 x 108	60 m	100 m	60 m	100 m
HP 360 x 132	60 m	100 m	60 m	100 m

The above bridge length criteria is based on the following assumptions:

- a. Steel H-piles are used with their webs oriented normal to the centerline of the bridge (longitudinal translation about the weak axis).
- b. The piles are driven through gravels or through clays with a minimum of 3 m (9.8 ft) of gravel overburden.
- c. For skews greater than 20°, abutment heights shall be ≤ 3.6 m (11.8 ft) and pile spacing shall be ≤ 3.0 m (9.8 ft).
- d. Thermal movement: 1.04 mm/m (0.012 in./ft) span length for steel structures, 0.625 mm/m (0.0075 in./ft) span length for concrete structures.

Bridge lengths in excess of the above limitations may be used with the approval of the Bridge Design Engineer when special design features are provided. However, in no case, steel structure lengths shall exceed 90 m (295.3 ft) or concrete structure lengths exceed 150 m (492.1 ft).

iv) Alignment

Curved bridges are allowed provided the stringers are straight. Beams shall be parallel to each other. All substructure units shall be parallel to each other. The maximum vertical grade between abutments shall be limited to 5%.

v) Superstructure Design

No special considerations shall be made for integral abutment designs. Fixity at the abutments shall not be considered during stringer design. When selecting span ratios for multi-span bridges, consideration should be given to providing nearly equal movement at each abutment.

vi) Wingwall

Wingwalls shall preferably be, straight extension wings not to exceed 3.0 m (9.8 ft) in length. Wing reinforcement shall be sized assuming at rest earth pressure on the back face of the wall.

vi) Approach Slabs

Approach slabs shall be used when bridge lengths exceed 24 m (78.7 ft) for steel structures and 42 m for concrete structures. Provisions for movement between the approach slab and approach pavement is not necessary until bridge lengths exceed 42 m (137.8 ft) for steel structures and 70.m (229.6 ft) for concrete structures.

viii) Drainage

The provisions of item (iii)-b, ensure adequate drainage behind the abutment. French drains or other special drainage devices are not required.

ix) Pile Design

Step 1. Calculate maximum vertical pile loads

- a. Dead load superstructure reaction
- b. Live load superstructure reaction
- c. Abutment dead load

- d. Pile dead load
- e. Secondary thermal effects in multi-span bridges only (Figs. 1.23 or 1.24)

Step 2. Select pile size as a column

Select pile size to meet loading requirements from Fig. 1.21 or 1.22.

Step 3. Piles must be capable of transferring loads to the ground by either end bearing or friction. End bearing piles shall be checked for an allowable stress of 83.3 MPa. Friction pile development lengths shall be in addition to the minimum embedment lengths given in Step 5 below.

Step 4. Check live load rotation demand. This pile stress resulting from the superstructure live loads shall not exceed $0.55 F_y$. The moment at the pile head can be calculated from the following approximate stringer end rotation:

$$R = WL_s^2 / 24E_sI_s$$

- R = Stringer rotation (radians)
- W = Total stringer live load, end span (N)
- L_s = Length of end span (mm)
- E_s = Modulus of elasticity of end span stringer (MPa)
- I_s = Moment of inertia of end span stringer (mm^4)
(composite I for composite beams)

$$M = 4EIR/L$$

- M = Pile head moment (N-m)
- E = Modulus of elasticity of pile (MPa)
- I = Moment of inertia of pile (mm^4)
- R = Stringer rotation (radians)
- L = Effective pile length (mm^4) (use embedment length below)

Step 5. Piles shall have the following minimum embedment lengths:

Table 1.5 Minimum embedment length of pile

Pile	Minimum embedment length (m)
HP 250 x 62	3.0
HP 310 x 79	3.6
HP 360 x 108	3.9
HP 360 x 132	4.5

Spread Footing Design

Spread footing abutments may be used within the following limitations:

- A. Steel structure length: ≤ 24 m (78.7 ft)
- B. Concrete structure length: ≤ 42 m (137.8 ft)
- C. Abutment heights: ≤ 2.4 m (7.8 ft)
- D. Skews: $\leq 25^\circ$

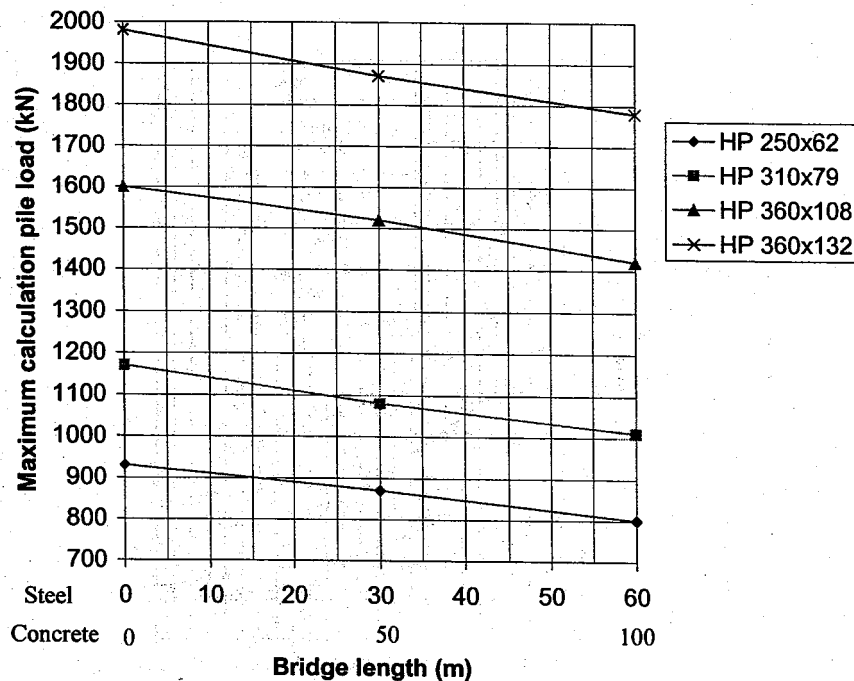

Figure 1.21 Maximum calculated pile load (fixed head piles)

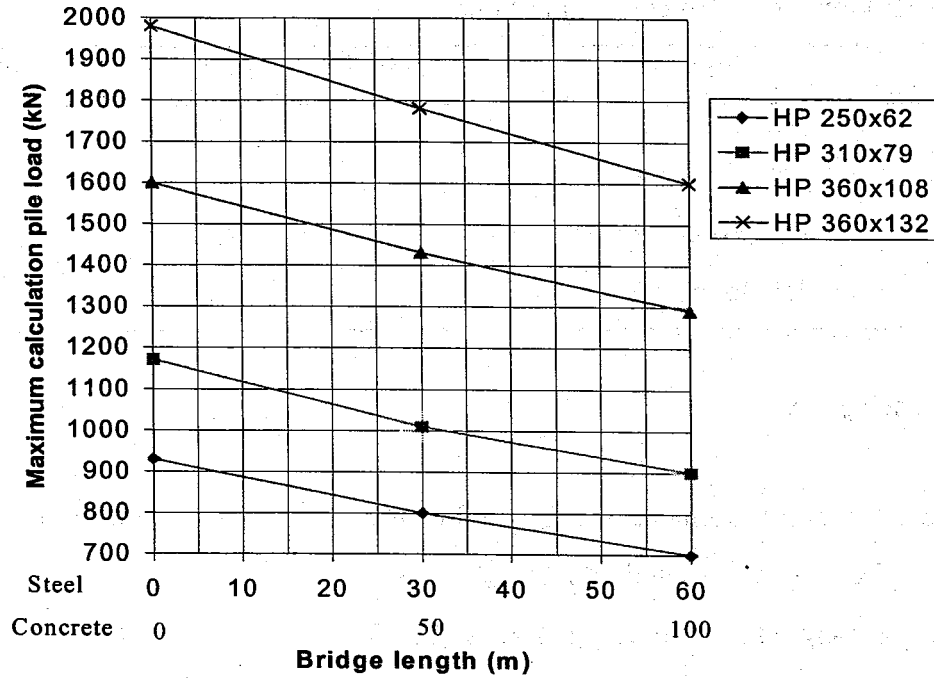

Figure 1.22 Maximum calculated pile load (pinned head piles)

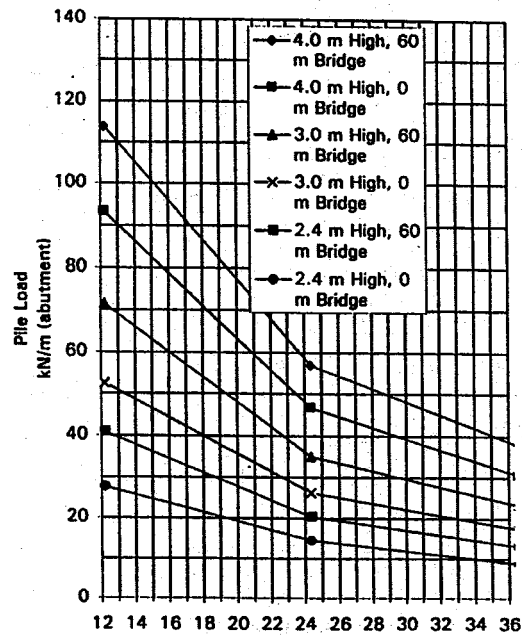

Figure 1.23 Thermally induced secondary pile forces for multi-span bridges (pinned head)

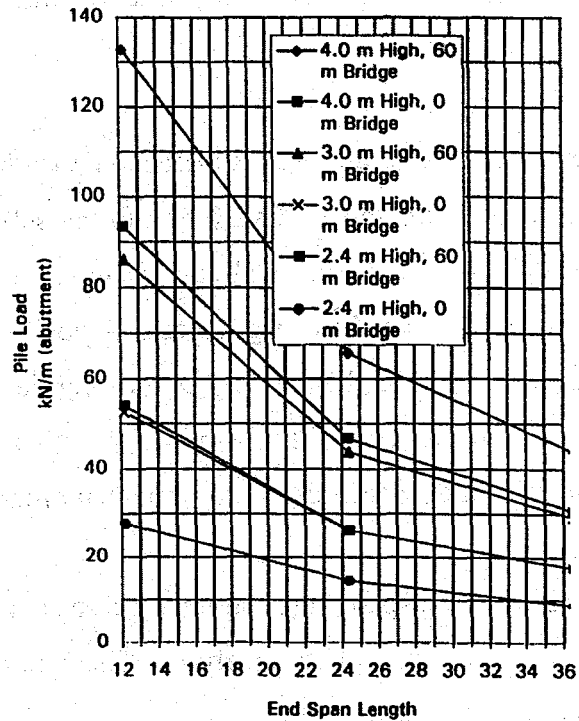

Figure 1.24 Thermally induced secondary pile forces for multi-span bridges (fixed head)

1.6 New Jersey Department of Transportation⁽¹⁹⁾ (NJDOT)

Characteristics of Integral Bridges

Integral abutment type bridge structures are simple or multiple span bridges that have their superstructure cast integrally with their substructure.

Integral abutment bridges accommodate superstructure movements without conventional expansion joints. With the superstructure rigidly connected to the substructure and with flexible substructure piling, the superstructure is permitted to expand and contract. Approach slabs, connected to the abutment and deck slab with reinforcement, move with the superstructure. At its junction to the approach pavement, the approach slab may be supported by a sleeper slab. If a sleeper slab is not utilized, the superstructure movement is accommodated using flexible pavement joints. Due to the

elimination of the bridge deck expansion joints, construction and maintenance costs are reduced.

The integral abutment bridge concept is based on the theory that due to the flexibility of the piling, thermal stresses are transferred to the substructure by way of a rigid connection between the: superstructure and substructure. The concrete abutment contains sufficient bulk to be considered as a rigid mass. A positive connection with the ends of the beams or girders is provided by rigidly connecting the beams or girders and by encasing them in reinforced concrete. This provides for full transfer of temperature variation and live load rotational displacement to the abutment piling.

The connection between the abutments and the superstructure shall be assumed to be pinned for the superstructure's design and analysis. The superstructure design shall include a check for the adverse effects of fixity.

Criteria for Integral Abutment Bridge Design

The movement associated with integral abutment bridge design can be largely associated with thermal expansion and contraction of the superstructure. By definition, the length of an integral abutment structure shall be equal to the abutment center line of bearing to abutment center line of bearing dimension. This also applies to continuous span structure lengths with expansion bearings at the piers. This length of expansion mobilizes the horizontal passive soil pressure.

i) Approach Slab

a) Approach slabs will always be required for integral abutment bridge structures: Their lengths shall vary from a minimum of 3 m (9.8 ft) to a maximum that is based on the intercept of a 1 on 1.5 line from the bottom of the abutment excavation to the top of the highway pavement. This length is to be measured along the centerline of roadway.

b) The end of the approach slab shall be parallel to the skew. A width from face of rail to face of rail is recommended. Special provisions shall be made to allow free movement of the approach slabs, if curbs or barriers are present. Approach slabs shall always be a separate pour from the superstructure slab, but shall be joined together.

c) Where warranted the approach slab maybe prevented from moving excessively by resting it on a keyed sleeper slab. The excavation for the sleeper slab shall be made after the compacted abutment backfill is placed. The sleeper slab shall be founded on undisturbed compacted: material., No loose backfill may be used.

d) The approach slab shall be cast on two layers of four mil thick polyethylene sheets. It shall be designed as a structural slab that is supported at each end.

ii) Expansion Provisions

a) For bridge lengths of 50 m (164 ft) or less, unless the highway pavement is rigid concrete, provision for expansion at the approach slab ends shall not be required.

b) For bridge lengths over 50 m (164 .ft) and up to 100 m (328 ft), provisions shall be made for;expansion at the end of each approach slab by installation of a sleeper slab.

c) For bridge lengths over 100 m (328.8 ft) and up to 140 m (459.3 ft), integral designs shall be approved on an individual basis. Provision for expansion shall be made at the end of each approach slab by installation of a sleeper slab.

d) For bridge lengths over 140 m (459.3 ft), integral abutments are not recommended at his time.

Design Procedure Guidelines

The following criteria shall be utilized in providing integral abutment bridge designs:

i) Hydraulics

Integral abutment bridges provide fixity between the superstructure and substructure, and provide greater protection against translation and uplift than conventional bridges. The NJDOT Bridge Scour Evaluation Program and Structure Inventory and Appraisal Inventory records shall be studied to verify scour potential at a project site. To address potential impact of a scour effect on proposed integral abutment bridge sites, the following areas should be reviewed and analyzed where scour potential exists:

a) Stream Velocity

Any history of erosion or scour at the bridge site should be reviewed and a determination made, if the new structure will alleviate any problems (alignment, restricted opening etc.) that may contribute to scours. Where a scour history is determined, the potential positive affects of an integral abutment bridge should be noted. Scour information may be obtained by researching the NJDOT Bridge Scour Evaluation Program and Structural Inventory and Appraisal coding records.

b) Bank Protection

Suitable slope protection construction to provide protection against scour, should be provided. On all integral abutment bridges, geotextile bedding shall be used against the front face of the abutment, under the slope protection and down the slope a minimum of 2 m (6.6 ft) length.

ii) Skew Angle

The maximum skew angle for integral abutment bridge designs shall be 30°. Skew angles greater than this shall preclude the use of integral abutment bridge construction.

iii) Foundation Types

a) The abutment and pile design shall assume that the girders transfer all moments and vertical and horizontal forces that are produced by the superimposed dead load, live load plus impact, earth pressure, temperature, shrinkage, creep and seismic loads. The transfer of these forces shall be considered to be achieved after the rigid connection to the abutments is made. The rigid connection shall be detailed to resist all applied loads.

b) All abutment substructure units shall be supported on a single row of piles. Cast-in-place (C.I.P.) or steel H piles may be used for structures with span lengths of 50 m (164 ft) or less. Only steel H piles should be used for structures with span lengths over 50 m (164 ft). When steel H piles are used, the web of the piles shall be perpendicular to the centerline of the beams regardless of the skew. This will facilitate the bending about the weak axis of the pile.

c) To facilitate expansion, for bridge span lengths of 30 m (98.4 ft) or more, each pile at each substructure unit shall be inserted into a pre-bored hole that extends 2.5 m (8.2 ft) below the bottom of the footing. The cost of provision of pre-boring these holes, casings and cushion sand shall be included in the Unit Price Bid for the pile item. All details and notes required by the Foundation Design Report shall be placed on the plans. For bridge lengths under 30 m (98.4 ft), pre boring is not required.

d) The designer must determine the practical point at which the embedded pile is determined to be fixed. The following steps may be followed to perform such an analysis.

For a bridge structure with equal intermediate bent stiffness, the movement demand will be equal and thermal movement demand is calculated. The atmospheric temperature range, coefficient of expansion and the structure's length should be considered.

The plastic moment capacity of the embedded length of the pile (embedded in the concrete cap) must be calculated. As stated earlier, the pile shall be oriented for bending about the weak axis. The column capacity must then be calculated. The adequacy of the backwall, to resist passive pressure due to expansion must also be computed.

e) When CIP piles are used, they must be pipe casings conforming to ASTM A252, Grade 2 with a minimum wall thickness of 6 mm (0.24 in.). This shall be noted on the plans.

f) All piles shall be driven to provide proper penetration into a soil strata where the required pile action is achieved, or to a minimum penetration of 6 m (19.7 ft). This is to avoid a tilt type effect, provide for scour protection and sufficient lateral support to the pile.

g) A pile bent configuration should be used for the integral abutment substructure detailing. For steel superstructure bridges, a minimum of one pile per girder shall be used.

h) The piles shall be designed to be flexible under forces and moments acting on the abutment. They shall be designed for vertical and lateral loads and for bending induced by superstructure movement. The fixity between the superstructure and the pile top may be ignored (Fig. 1.27).

i) The initial choice of pile selection shall be based upon the recommendations that are contained in the geotechnical report. The axial loads shall be based upon the

reactions from the superstructure design. This shall include the superstructure dead load, live load plus impact and the substructure dead load.

j) Live load impact shall be included in the design of integral abutment piles. The total length for single span bridges and the end span length for multiple span length bridges should be considered.

iv) Superstructure

a) Adjacent prestressed box beams, prestressed concrete girders and structural steel beams may be used for integral abutment designs. They shall be analyzed to determine the stresses in the beams that will result from thermal movements. In prestressed box beams, such stresses shall be judged to be critical when the beams act by, pulling the abutment with an approach slab. Mild reinforcement shall be added to the ends of prestressed box beams to resist such stresses.

b) Figs. 1.25 through 1.31 provide conceptual detailing for rigidly connecting the prestressed concrete box beams and structural steel type superstructures to the abutments. Steel superstructures may have their girders directly attached to the piles through the use of welded plates as shown on Figs. 1.25 through 1.27. Other type connections, such as bolting the girder to the abutment, may also be used. Prestressed girders may be connected by doweling them to the abutments.

c) Steel girders may be placed on plain elastomeric pads. The anchor bolts will pass through both the pad and the bottom flange of the girder. Another method is to use a longer bolt so that nuts may be placed above and below the bottom flange. The grade of the girder may be better controlled this way. Slotted holes should be used to allow better flexibility in aligning the girder. Slotted holes should also be used with the doweling of prestressed members to the abutments.

v) Abutments

a) In integral abutment bridges, the ends of the superstructure girders are fixed to the integral abutments. Expansion joints are thus eliminated at these supports. When the expansion joints are eliminated, forces that are induced by resistance to thermal movements must be proportioned among all substructure units. This must be considered in the design of integral abutments.

b) The integral bridge concept is based on the theory that, due to the flexibility of piles, thermal stresses are transferred to the substructure by way of a rigid connection. The concrete abutment contains sufficient bulk to be considered a rigid mass. To facilitate the stress transfer, abutments shall be placed parallel to each other and ideally be of equal height.

c) The positive moment connection between the girder ends and the abutment provides for full transfer of temperature variation and live load rotational displacement to the abutment piling.

d) To support the integral abutment, it is customary to use a single row of piles. The piles are driven vertically and none are battered. This arrangement of piles permits the abutment to move in a longitudinal direction under temperature effects.

e) The most desirable type abutment is the stub type. It will provide greater flexibility and offer the least resistance to cyclic thermal movements.

vi) Piers

a) Piers for integral bridges have similar design requirements and share common design procedures with the piers of a more traditional bridge. The primary distinguishing features of the piers for an integral abutment bridge involve their ability to accommodate

potentially large superstructure movements and the sharing of lateral and longitudinal forces among the substructure units.

b) As with integral abutments, the piers must also be designed to accommodate the movements of the superstructure. Thermal movements are usually the major concern, although superstructure movements, due to concrete creep and drying shrinkage, will also be present to some degree. Creep and shrinkage movements may be ignored for prestressed concrete girders; however, for longer bridges, these effects must also be considered in the design of the piers.

c) As part of the overall structural system, integral abutment bridge piers will typically be required to carry a portion of the externally applied longitudinal and transverse loads on the bridge. In addition, thermal movements of the superstructure will induce forces as the piers attempt to restrain those movements.

d) As the superstructure expands and contracts with seasonal temperature changes, and to a lesser extent, creep and shrinkage, the tops of the piers will be forced to undergo displacements relative to their bases. These displacements will produce curvatures in the columns that can be closely estimated based on the magnitude of the movements, the fixity conditions at the top and bottom of the columns and the height of the columns.

e) Once curvatures are estimated, an effective column stiffness must be considered to compute internal moments and shears. A set of equivalent external forces, in equilibrium with the computed internal moments and shears, must be computed. This set of equivalent forces is used in subsequent analysis to represent the effects of superstructure movements on the piers.

f) Forces induced by the distribution of the superstructure movements must be computed. Also, the distribution of externally applied loads to the substructure units must be estimated.

g) Similar to the design of a traditional pier, piers of integral abutment bridges are designed for load combinations. Often, load combinations involving temperature, creep and shrinkage control the design of integral abutment bridges, as opposed to combinations containing external loads only. A pier must be capable of undergoing the imposed superstructure movements while simultaneously resisting external forces.

h) A bearing at a pier of an integral abutment bridge structure should only be fixed when the amount of expected expansion from the bearing to both abutments or adjoining pier is equal. All other cases should use expansion bearings.

i) The following guidance shall be followed in determining the type of pier selection in integral abutment bridge designs:

A. Continuity at Piers

i) The concrete deck slab must be physically continuous, with joints limited to sawcut control joints or construction joints. Distinction must be made between slab continuity and girder continuity at the piers.

ii) If, in accommodating the load transfer, girder continuity is deemed appropriate by the design, the superstructure shall be assumed continuous for live loads and superimposed dead loads only. Girders shall be erected as simple spans and made continuous by the addition of mild steel in the deck slab.

iii) Longer span integral bridges; i.e., those with spans over 30 meters (98.4 ft) shall be detailed to provide a deck slab placement sequence if girder continuity is to be provided. Where applicable, casting of concrete diaphragms over the piers should be done concurrently with placement of the slab.

iv) When slab-only continuity is provided over the piers, girders are, to be designed as simply supported for all loads.

B. Types of Piers

To design piers to accommodate potentially large superstructure movements, the following options are available:

- i) Flexible piers, rigidly connected to the superstructure;
- ii) Isolated rigid piers, connected to the superstructure by means of flexible bearings;
- iii) Semi-rigid piers, connected to the superstructure with dowels and neoprene bearing pads;
- iv) Hinged-base piers, connected to the superstructure with dowels and neoprene bearing pads.

C. Flexible Piers

i) A single row of piles, with a concrete cap that may be rigidly attached to the superstructure, provides atypical example of a flexible pier. This type of pier is assumed to provide vertical support only. The moments induced in the piles due to superstructure rotation or, translation are small and may be ignored.

ii) A bridge, constructed with flexible piers relies entirely on the integral abutments for lateral stability and resisting lateral forces. Passive pressures behind the backwalls, friction, and passive pressures on the abutment piles should be mobilized to resist lateral and longitudinal forces.

iii) With this type of pier use, temporary lateral bracing may be required to provide stability during construction. Designers must consider a means to account for passive soil pressures in the vicinity of the backwalls.

D. Isolated Rigid Piers

i) Rigid piers are defined as piers whose base is considered fixed against rotation and translation, either by large footings bearing on soil or rock, or by pile groups designed : to resist moment. The connection to the superstructure is usually detailed in a way that allows free longitudinal movement of the superstructure, but restrains transverse movements. This type of detailing permits the superstructure to undergo thermal movements freely, yet allows the pier to participate in carrying transverse forces.

ii) With this class of pier, the superstructure is supported on relatively tall shimmed neoprene bearing pads. A shear block, isolated from the pier diaphragm with a compressible material such as cork, is cast on the top of the pier cap to guide the movement longitudinally, while restraining transverse movements.

iii) This type of pier represents the traditional solution taken with steel girder bridges at so called expansion piers. It offers the advantage of eliminating the stresses associated with superstructure thermal movements. It also provides piers that require no temporary shoring for stability during construction.

iv) In utilizing this system, additional consideration must be given to the detailing associated with the taller bearing pads and the detailing associated with the shear key. In addition, because the pier and the superstructure are isolated longitudinally, the designer must ensure that the bearing seats are wide enough to accommodate seismic movements.

E. Semi-Rigid Piers

i) These piers are similar to rigid piers. Their bases are considered fixed by either large spread footings or pile groups; however, the connection of the piers to the superstructure differs significantly.

ii) In utilizing prestressed concrete girders that bear on elastomeric pads, a diaphragm is placed between the ends of the girders. Dowels, perhaps combined with a shear key between girders, connect the diaphragm to the pier cap. Compressible materials are frequently introduced along the edges of the diaphragm, and, along with the elastomeric bearing pads, allow the girders to rotate freely under live load.

iii) The dowels force the pier to move with the superstructure as it undergoes thermal expansion and contraction and, to a lesser extent, creep and shrinkage. Accommodation of these movements requires careful analysis during the design of the piers. Normally, the stiffness of the piers is assumed to be reduced due to cracking and creep.

iv) There are several advantages to this type of pier detailing is simplified, use of thin elastomeric pads are relatively inexpensive, temporary shoring is not required; during construction, all piers participate in resisting seismic forces and the girders are positively attached to the piers. In addition, with many piers active in resisting longitudinal and transverse forces, the designer need not rely on passive soil pressures at the integral abutments to resist lateral forces.

v) Design of semi-rigid piers is slightly more complicated because careful assessment of foundation conditions, pier stiffnesses and estimated movements is required. In some situations semi-rigid piers are inappropriate. For example, short piers bearing on solid rock may not have adequate flexibility to accommodate movements without distress.

F. Hinged-Base Piers

i) This type of pier may be used to avoid the need for an expansion pier in a situation where semi-rigid piers have inadequate flexibility. A "hinge" is cast into the top of the footing to permit flexibility of the column.

ii) Temporary construction shoring may be required, and additional detailing requirements at the top of the footing may increase cost; however, the designer should keep this alternate in mind under special circumstances where the other pier types are not feasible.

vii) Wingwall Configuration

a) In-Line wingwalls cantilevered off the abutments are the preferred arrangement for integral abutment construction. Wingwalls in excess of 4 meters (13.1 ft) should be supported on their own foundation independent of the integral abutment system. In this case, a flexible joint must be provided between the wingwall stem and the abutment backwall.

b) Flared walls cantilevered off from the abutments may be considered by the designer on a case by case basis. The use of flared wingwalls should generally only be considered at stream crossings where the alignment and velocity of the stream would make in-line walls vulnerable to scour. Piles shall not be placed under, any flared walls that are integral with the abutment stem.

c) U-walls cantilevered off the abutment stem shall be allowed only if in-line or flared walls cannot be used because of right-of-way or wetlands encroachment. The U-walls shall preferably not measure more than 3 meters (9.8 ft) from the rear face of the abutment stem.

If U-walls greater than 3 meters (9:8 ft) in length are required, the wingwall foundation should be separated from the abutment foundation. A flexible joint between the abutment backwall and wingwall stem should be provided. This type of arrangement will maintain the abutment/pile flexibility so that the thermal movement of the superstructure is permitted.

d) The distance between the approach slab and the rear face of the U-wall should preferably be a minimum of 1.2 m. (3.9 ft) If the approach slab must extend to the U-wall, they shall be separated by a 50 mm (19.7 in.) joint filled with resilient joint filler.

viii) Horizontal Alignment

Only straight beams will be allowed. Structures on curved alignments will be permitted if provided that the beams are straight.

ix) Grade

The maximum grade between abutments shall be 5%.

x) Stage Construction

Stage construction is permitted and special consideration shall be given to the superstructure's rigid connection to the substructure during concrete placement when staging construction. The superstructure should be secured, free from rotation, until all concrete up to the deck- slab, is placed.

xi) Seismic Modeling

a) The general concept behind modeling the seismic response of a bridge structure is to determine a force-displacement relationship for the total structure, which is consistent with the ability of the structure to resist the predicted forces and displacements.

b) Integral abutments shall be modeled to move under seismic loading in both the longitudinal and the transverse directions, thus distributing more transverse forces to the piers.

c) The bridge structure shall be modeled in three dimensions for a stiffness analysis. A single or multi-mode analysis may be used.

Construction Procedures

The following sequence is recommended when constructing integral bridges. This will reduce the effects of thermal movements on fresh concrete and control moments induced into the supporting pile system.

i) Drive piling and pour the concrete to the required bridge seat elevation and install the rigid connection systems. Pour concrete for wingwalls concurrently.

ii) Set the beams/girders and anchor to the abutment. Figs. 1.25 through 1.29 provide details for a welded plate rigid connection, for steel superstructures, to the substructure. As an alternate, slotted bolt holes in the bottom flanges may be used. The slotted holes will aid the girder placement. Anchor nuts should not be fully tightened at this time. Free play for further dead load rotations should be accounted for.

iii) Pour the bridge deck in the sequence desired excluding the abutment backwall/diaphragm and the last portion of the bridge deck equal to the backwall/diaphragm width. In this manner, all dead load slab rotations will occur prior to lock-up, and no dead load moments will be transferred to the supporting piles.

iv) If anchor bolts are used, tighten anchor nuts and pour the backwall/diaphragm full height. Since no backfilling has occurred to this point, the abutment is free to move without overcoming passive pressures against the backwall/diaphragm. The wingwalls may also be poured concurrently.

v) Place back of wall drain system and back fill in 150 mm (492 in.) lifts until the desired subgrade elevation is reached. Place bond breaker on abutment surfaces in contact with approach pavement.

vi) Pour the approach slab concrete starting at the end away from the abutment, progressing toward the backwall. If it can be so controlled, approach pavements should be poured in early morning, so that the superstructure is expanding, and therefore not placing the slab in tension.

vii) A construction joint should be located at a distance of 150 mm (492 in.) from the back of the backwall between the approach slab and bridge slab. This will provide a controlled crack location rather than allowing a random crack pattern to develop. Corrosion coated dowels shall pass through the joint and shall be located near the bottom of the slab. This will keep the joint tight but still allow the approach slab to settle without causing tension cracking in the top of the slab.

viii) The excavation for the approach slabs shall be carefully made after compacted abutment embankment material is in place. The slabs shall be founded on undisturbed compacted material. No loose backfill will be allowed.

ix) To permit unhindered longitudinal movement of the approach slab, the surface of the subbase course must be accurately controlled to follow and be parallel to the roadway grade and cross slope.

x) A filter fabric or some type of bond breaker such as polyethylene sheets shall be placed on the finished subbase course to the full width of the roadway prior to placement of approach slab reinforcement.

xi) A lateral drainage system should be provided at the end of the approach slab adjacent to the sleeper slab. Suitable description should be provided on the plans to incorporate these construction procedures.

- Integral abutment construction procedure**
(Prestressed concrete superstructure)
1. For bridge lengths over 30 m, pre-excavate holes to a depth of 2.5 m below stem.
 2. Drive piles and cut off piles at elevations shown in the drawing.
 3. Backfill holes with cushion sand (cost to be included in pile item).
 4. If CIP piles are used, fill with concrete.
 5. Place abutment stem concrete to bridge seat elevation.
 6. Erect beams on concrete bearing blocks with pads top and bottom.
 7. Place and grout anchor dowels.
 8. Place class B concrete above seat elevation for the abutment backwall and deck slab. To facilitate complete consolidation of concrete between the top of the beam. Vent holes shall be poured up to the top of the prestressed units. High range water reducers shall not be allowed for the deck slab.
 9. Backfill abutment stems: No backfilling of abutment is allowed until the abutments have cured for 7 days.

Figure 1.25 Integral abutment construction procedure

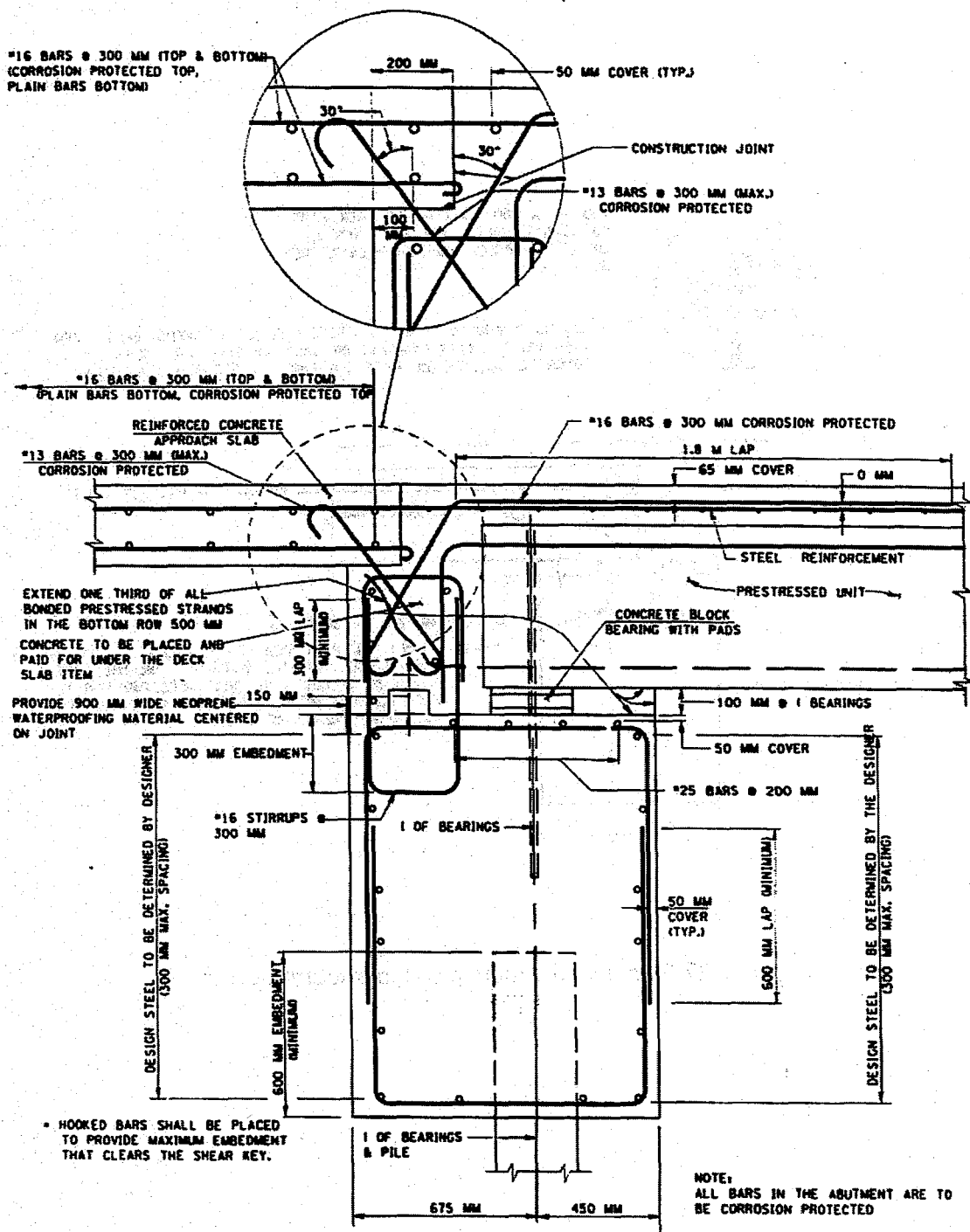

Figure 1.26 Integral abutment of prestressed concrete structure

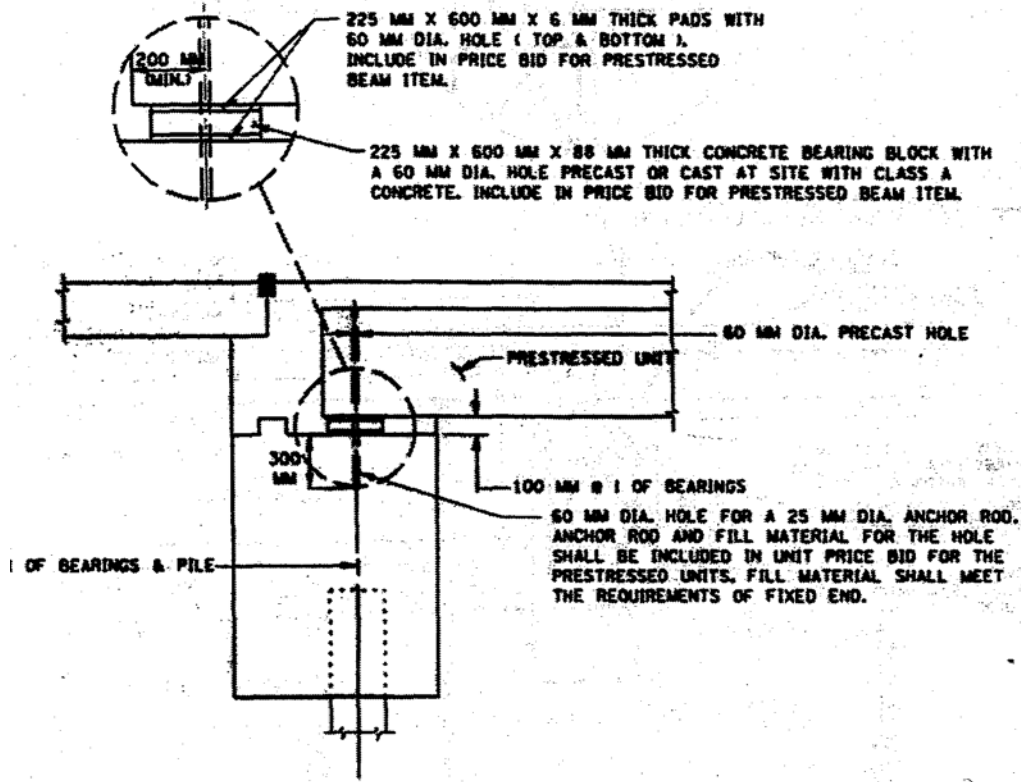

Figure 1.27 Prestressed concrete superstructure details

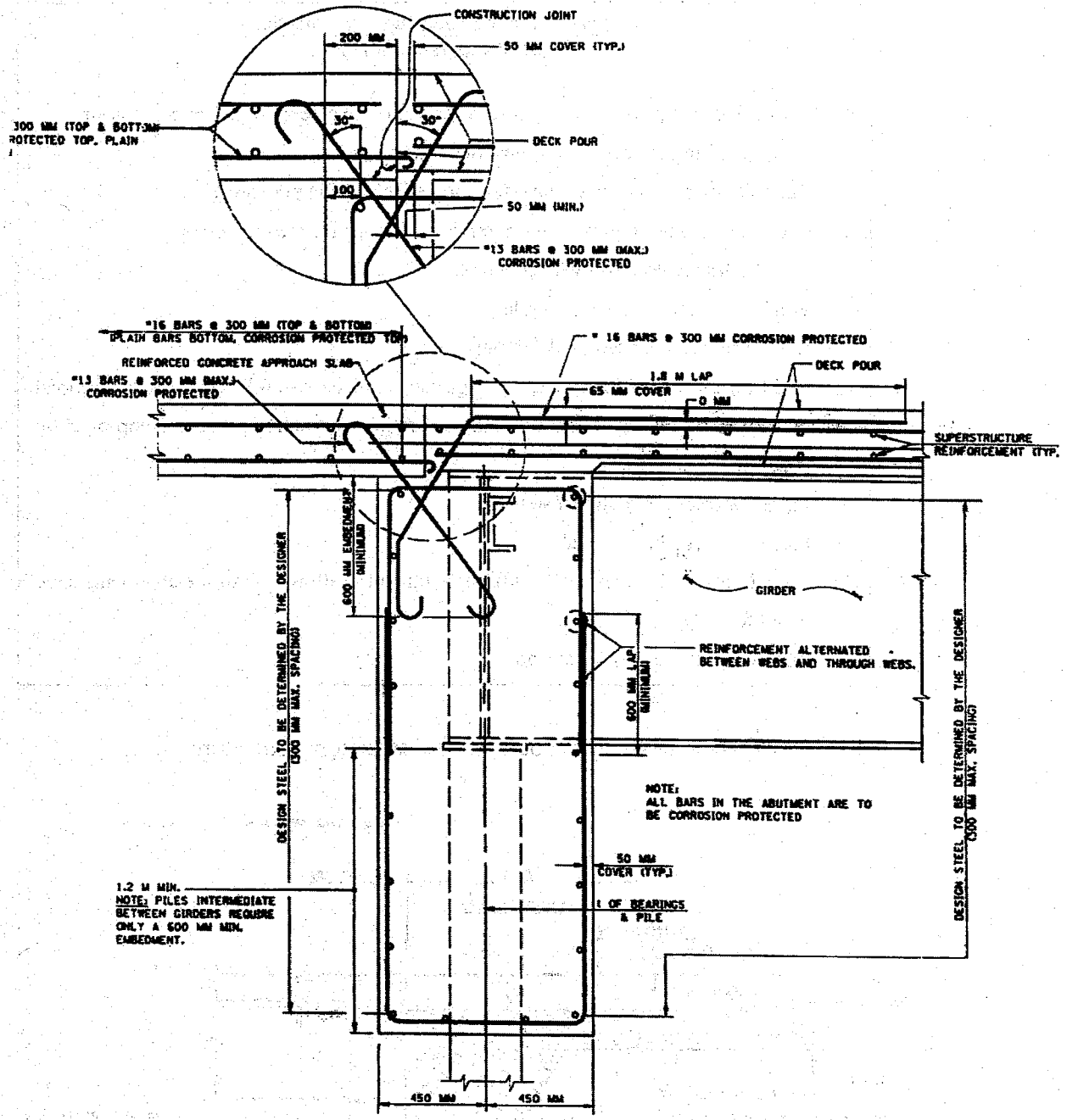

Figure 1.28 Integral abutment details for steel girder

Integral abutment construction procedure
(steel superstructure)

1. For bridge lengths over 30 m, pre-excavate holes to a depth of 2.5 m below stem.
2. Drive piles and cut off piles at elevations shown.
3. Backfill holes with cushion sand (cost to be included in pile item)
4. Grind top of piles to provide a smooth level surface for the load plate.
5. If CIP piles are used, fill with concrete.
6. Weld load plates to the top of piles.
7. Erect girders and install all diaphragms.
8. Weld all girders to load plates. All girders shall be securely clamped to the load plates prior to comment of the welding operation. A welding procedure approved by the engineer is required.
9. Place concrete for abutment stem.
10. Place concrete for deck slab.
11. Backfill abutment stem: No backfill of abutment is allowed until the abutments have cured for 7 days.
12. Place concrete for approach slabs.

Figure 1.29 Integral abutment construction procedure

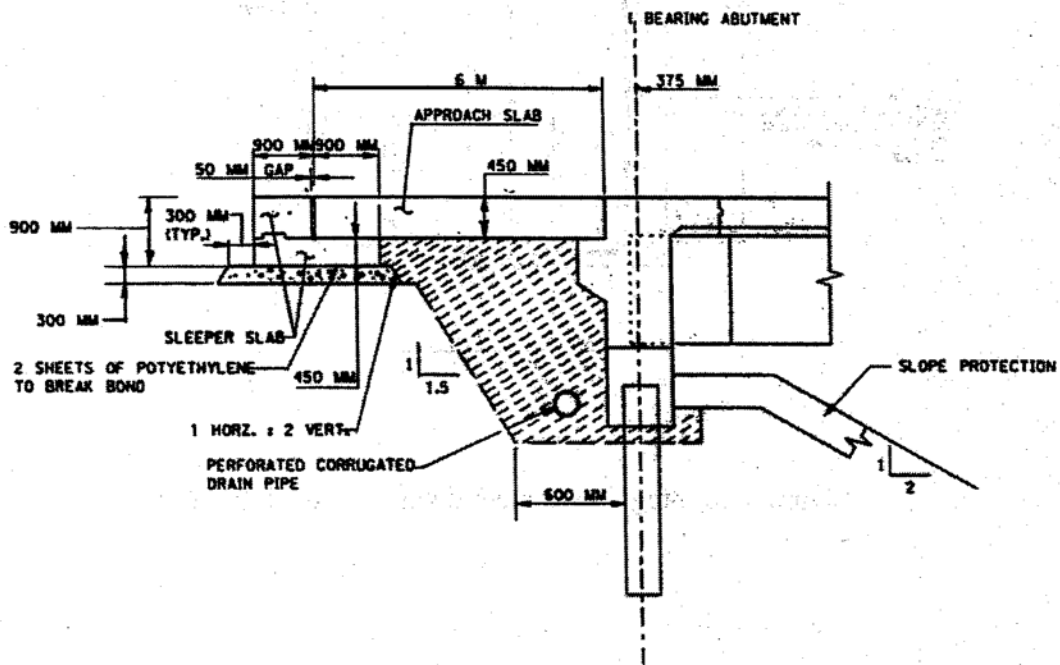

Figure 1.30 Approach slab for masonry details

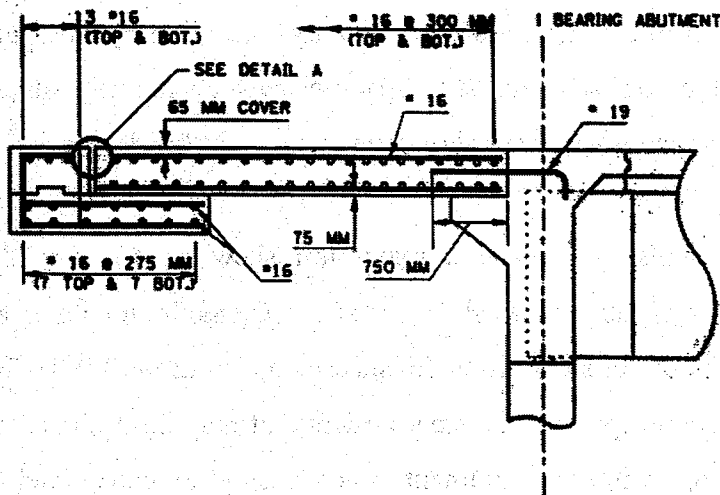

Figure 1.31 Approach slab reinforcement details

1.7 New York Department of Transportation⁽²⁰⁾

Integral abutments are constructed as a rigid connection of the deck and primary support members of the superstructure to a pile supported substructure. The abutment is supported on a single row of piles. The webs of the piles are oriented to be perpendicular to the centerline of the beams to allow the piles, to rotate and horizontally deflect as the abutment stem moves due to thermal expansion of the superstructure. There are no deck expansion joints at the abutment. Integral abutments should always be considered as the first choice of abutment because of their lower construction cost and superior long term performance.

Horizontal reinforcement in the abutment stem of steel superstructure bridges shall be designed by considering the stem to be continuous between piles. The horizontal reinforcement in the front face of the stem should be designed to withstand the positive moments between the beams due to passive soil pressure. The horizontal reinforcement in the rear face should be designed to withstand the negative moments at the beams caused by passive soil pressure. Horizontal reinforcement in the abutment stem for prestressed concrete box beam superstructure bridges is usually nominal steel based on the prestressed beams fully supporting the abutment stem along its entire horizontal

length. Vertical steel in the abutment stem is usually controlled by shear considerations. If the ratio of the abutment stem depth to spacing between the pile supports is 1:1 or greater, then deep beam considerations should be included in the design.

Integral abutments shall have a maximum skew of 45° for all spans. The maximum grade between abutments shall be 5%. The maximum dimension from the bottom of girder to the top of stone fill or finished grade is 1.2 m (3.9 ft). Structures with straight girders and single span curved steel girders that may be designed as straight are allowed. The length of an integral abutment structure shall be considered to be equal to the Beginning Abutment centerline of bearing to the Ending Abutment centerline of bearing dimension since it is this length of expansion that mobilizes horizontal passive soil pressure. The following is recommended for integral bridges:

- For a length 50 m (164 ft) or less, no provision is required for expansion at the ends of approach slabs unless the highway pavement is rigid concrete.
- For a length more than 50 m (164 ft) up to 100 m (328 ft), expansion needs to be provided at the end of each approach slab. The span arrangement and interior bearing selection should be such that approximately equal movement will occur at each abutment.
- Individual approval is required for length in the range of 100 m (328 ft) to 200 m (656 ft), and provision for expansion shall be made at the end of each approach slab.
- Integral abutment bridges are not recommended for lengths more than 200 m (656 ft).

Integral abutments have special foundation requirements. All integral abutments shall be supported on a single row of piles. C.I.P. or steel H-piles maybe used for structures with lengths of 50 m (164 ft) or less. Only steel H-piles shall be used for structures with lengths more than 50 m (164 ft). When steel H-piles are used, the web of the piles shall be perpendicular to the centerline of the beams regardless of the skew, so that bending takes place about the weak axis of the pile.

If C.I.P. piles are used, the following note should be placed on the plans: Pipe casings for C.I.P. piles shall conform to ASTM A252, Grade 2 with a minimum wall thickness of 6 mm (0.24 in.).

To accommodate expansion for: bridge lengths of 30 m (98.4 ft) or more, each pile shall be inserted in a pre-excavated hole that extends 2.5 m (8:2 ft) below the bottom of the abutment. After driving the piles, the pre-excavated holes shall be filled with cushion sand. For bridges less than 30 m (98.4 ft), no special pre-excavation provisions are required for expansion purposes.

All piles shall be driven to a minimum penetration of 6 m. This is to avoid a tilt effect, provide for scour protection, and sufficient lateral support to the pile, particularly when the top 2.5 m (8.2 ft) is excavated and backfilled with sand. If no pre-excavating for the piles is required, penetrations as low as 3 m (9.8 ft) can be used.

A pile bent configuration is to be used for the integral abutment detail. For steel and spread concrete girder bridges, a minimum of one pile per girder shall be used.

Pile loads can be determined by assuming the vertical reaction from the superstructure and the dead load of the abutment is uniformly distributed to each pile.

Unlike other abutments, the wingwalls for integral abutments have special requirements. In-line wingwalls cantilevered from the abutment are the preferred arrangement. Flared walls cantilevered from the abutment may be considered by the designer on a case by case basis. The use of flared wingwalls should generally only be considered at stream crossings where the alignment and velocity of the stream would make in-line walls subject to scour. Piles shall never be placed under flared wingwalls that are integral, with the abutment stem. Generally, the controlling design parameter is the horizontal bending in the wingwall at the fascia stringer caused by the large passive pressure behind the wingwalls. In-line or flared wingwalls connected to the abutment stem with lengths in excess of 4 m (13.1 ft) should be avoided,

Because of high bending moments due to passive soil pressure, it may be necessary to support long wingwalls (4 m (13.1 ft) measured along the wall) on their own foundation, which is independent of the integral abutment system. In this case, a flexible joint must be provided between the wingwalls and the backwall. The joint between the abutment and the wingwalls shall be parallel to the centerline of the roadway. Separate wingwalls may be designed as conventional walls with a footing or a stem with a single row of piles. The choice will be governed by the site and loading conditions, but walls using a single row of piles should generally be limited to a height of 4 m (13.1 ft).

U-wingwalls cantilevered from the abutment stem shall be allowed only if in-line or flare walls cannot be used because of right-of-way or wetlands encroachment. The U-wingwalls shall not measure more than 2 m (6.6 ft) from the rear face of the abutment stem. No piles shall be placed under the U-wingwalls. This would inhibit the abutment's ability to translate and would cause internal stresses. The distance between the approach slab and the rear face of the U-wingwall should preferably be a minimum of 1.8 m (5.9 ft). If the approach slab must extend to the U-wingwall it shall be separated from the U-wingwall by a 50 mm (2 in.) joint filled with at least two sheets of premolded resilient joint filler.

Rigid utility conduits, such as gas, water and sewer, are discouraged for use with integral abutments. If they are used, expansion joints in the conduits must be provided at each abutment. Sleeves through the abutment should provide at least 50 mm (2 in.) clearance all around the conduit. Flexible conduits for electrical or telephone utilities that are properly equipped with an expansion sleeve through the integral abutment are acceptable.

When stage construction is used with integral abutments, it is recommended that the use of a closure placement between stages in the abutments be considered. The use of a closure placement can reduce the mismatch between stages caused by deflection from the superstructure. This closure placement is not usually needed for shorter spans but become increasingly advisable at spans over 25 m (82 ft).

Fig. 1.32 shows the detail of integral abutment for prestressed girder. The construction procedure for the integral abutment bridge with prestressed concrete superstructure is shown in Fig. 1.33.

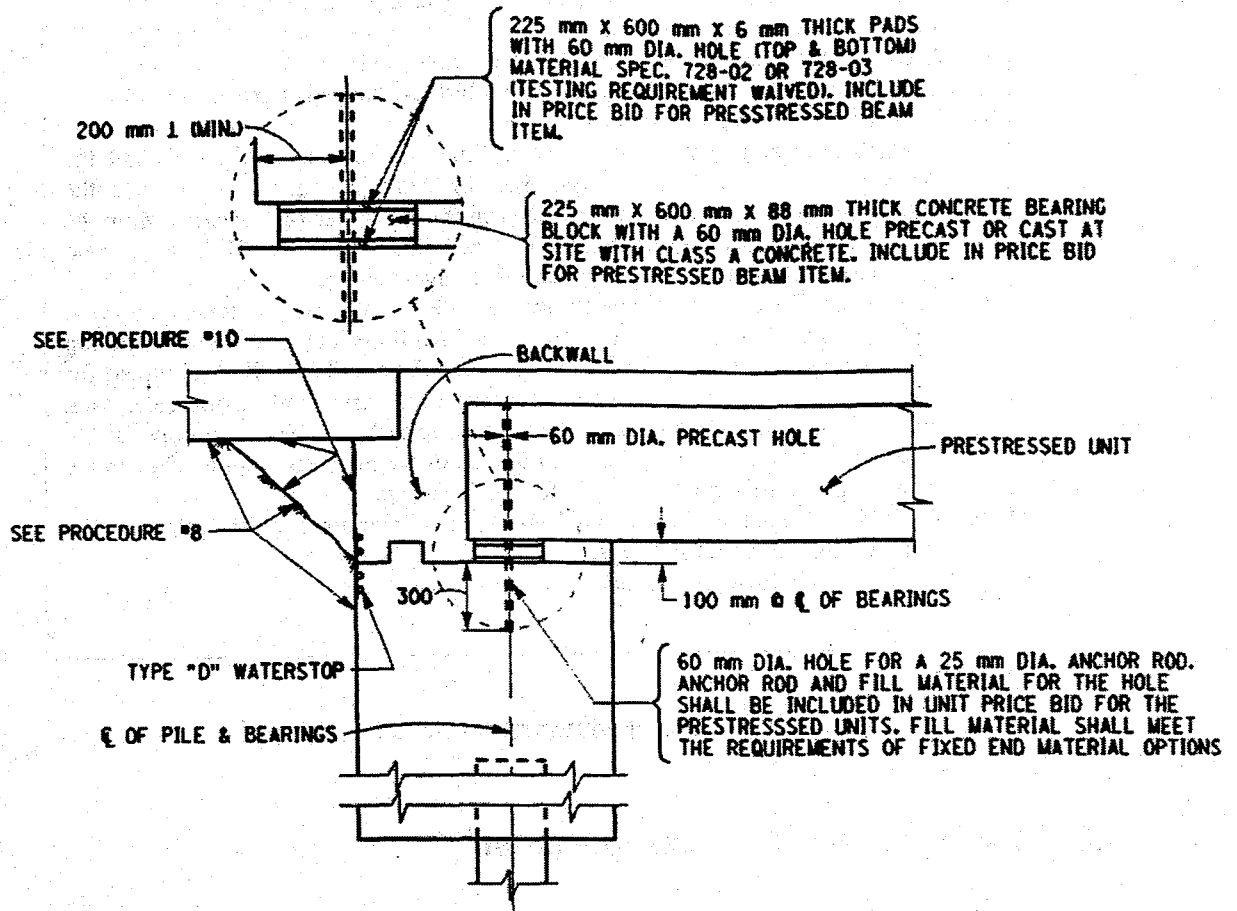

Figure 1.32 Integral abutment details for prestressed girder

Integral abutment construction procedure
(Prestressed concrete superstructure)

1. For bridge lengths over 30 m, pre-excavate holes to a depth of 2.5 m below stem and to the diameter specified in the foundation design report.
2. Drive piles and cut off piles at elevations shown in the drawing.
3. Backfill holes with cushion sand (cost to be included in pile item)
4. If CIP piles are used, fill with concrete.
5. Place abutment stem concrete to bridge seat elevation.
6. Erect prestressed units on concrete bearing blocks with pads top and bottom.
7. Place and grout anchor dowels.
8. Backfill both abutment stems, no backfilling of abutment is allowed until the abutments have cured for 7 days. Backfill shall be conducted such that the maximum differential in fill height between the two stems (as measured from the bottom of the stem) does not exceed 600 mm. in addition. The fill height behind any single abutment stem shall not vary more than 600mm.
9. Place class HP concrete above bridge seat elevation for the abutment backwall and deck slab. To facilitate complete consolidation of concrete between the top of the bridge seat and the bottom of the beam. Vent holes shall be provided for the insertion of a 25 mm diameter vibrator in the front form from under each beam. High range water reducers (super plasticizer) may be added only for the remainder of the abutment pour up to the top of the prestressed units. High range water reducers shall not be allowed for the deck slab.
10. Backfill abutment backwalls, no backfilling of abutment is allowed until the abutments have cured for 7 days.
11. Place concrete for approach slabs.

Figure 1.33 Integral abutment construction procedure

1.8 Ohio Department of Transportation

Integral construction involves attaching the superstructure and substructure (abutment) together. The longitudinal movements are accommodated by the flexibility of the abutments (capped pile abutment on single row of piles regardless of pile type). These abutment designs are appropriate for bridge expansion lengths up to 75 meters (250 ft) and a maximum skew of 30°(Fig. 1.34). A total length of 125 meters (400 ft) is possible, assuming 2/3 movement could occur in one direction.

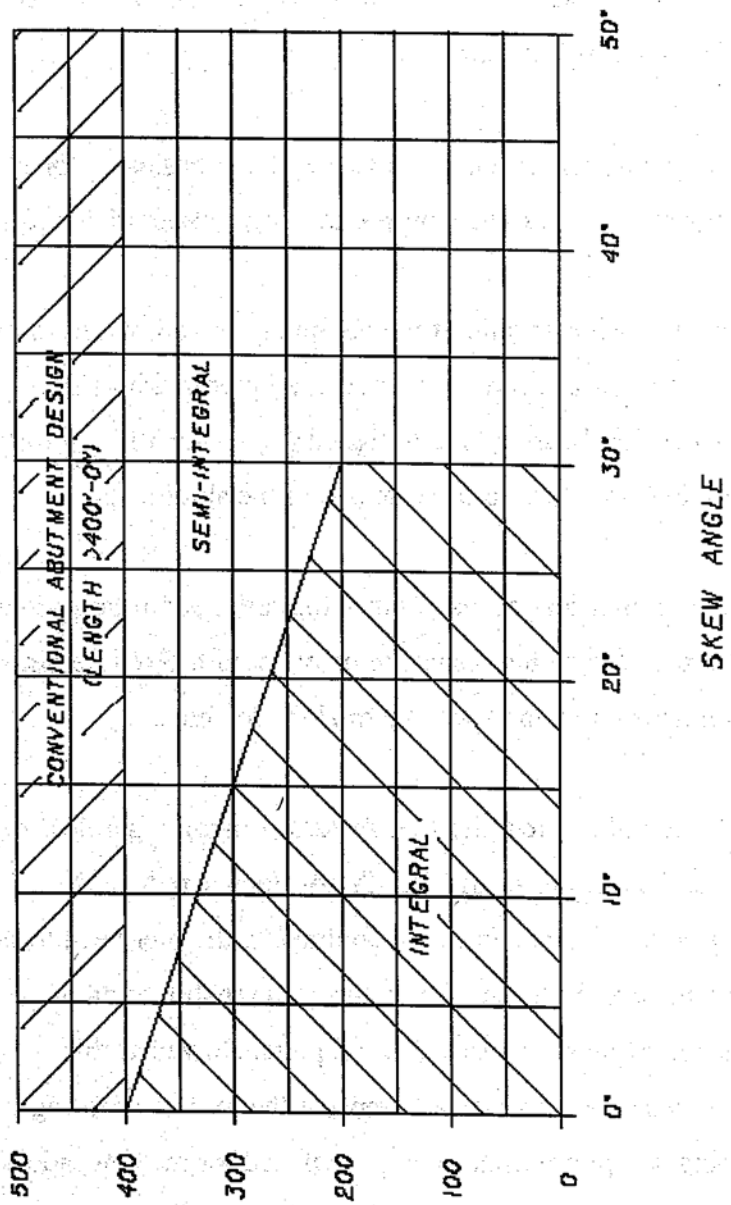

Figure 1.34 Skew vs. bridge length limitation of integral abutment bridge

The superstructure may be structural steel, cast-in-place concrete, prestressed concrete boxbeam or prestressed-I beams. Integral design shall be used where practical. This design should be used for uncurved (straight beams) structures and at sites where there are no concerns about settlement or differential settlement. A typical integral abutment is shown in Fig. 1.35.

The limitations previously discussed are basically for steel superstructures. If a concrete superstructure is being proposed, longer structure lengths maybe investigated. The expansion length, at the abutment, is considered to be two-thirds of the total length of the structure. On new structures, all pier bearings should be expansion bearings. The pier expansion bearings are designed proportionally (by distance) to the assumption that the $2/3$ movement could occur at one of the abutments.

If unsymmetrical spans (from a thermal neutral point viewpoint) are used, either all pier bearings are to be expansion or piers with fixed bearings are to be designed for the forces induced by unbalanced thermal movements.

The use of a fixed pier (i.e. fixed bearings), regardless of structural rigidity, does not allow an increase in bridge length nor does it reduce the $2/3$ movement assumption. Depending on its distance from the abutments, the pier need to be designed for a portion of the movement from the superstructure. On rehabilitation projects, preference should be given to using expansion bearings at all piers. However, this is not meant to be used as a blanket statement to automatically replace the existing bearings. If an existing pier has a fixed bearing, the pier will need to be analyzed for the new, additional loading that results from the $2/3$ movement assumption. The load will be proportional to the distance from the pier to an abutment. The fixed bearing will not be the thermal neutral point as was assumed in the original design.

Integral design should not be used with curved main members or main members which have bend points in any stringer line. For efficient and realistic an integral design, the geometry of the approach slab, the design of the wingwalls, and the transition parapets must be compatible with the freedom required for the integral (beams, deck, backwall, wingwalls and approach slab) connection to rotate and translate longitudinally.

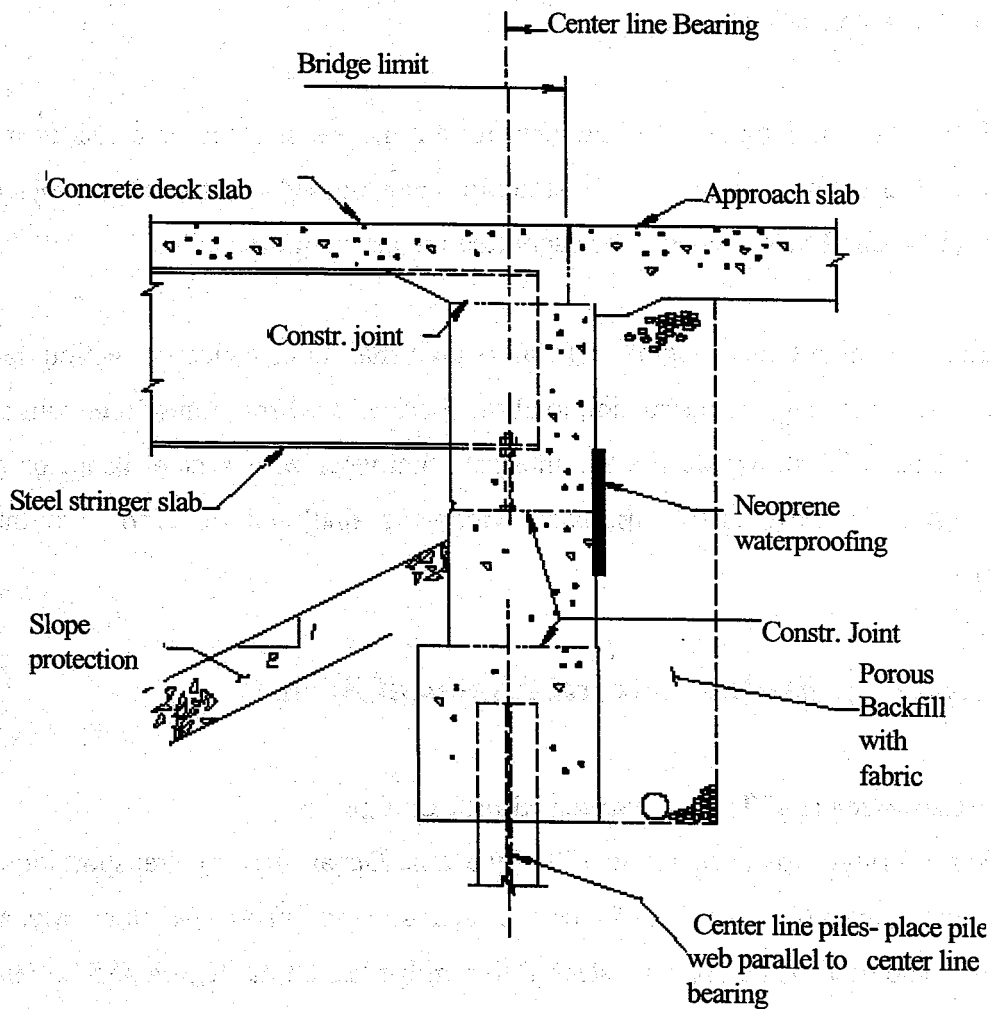

Figure 1.35 Typical integral abutment

The horizontal and vertical joint shall be sealed at the back face of the back wall by use of a 900 mm (3 ft) wide sheet of nylon reinforced neoprene sheeting. The sheeting should only be attached on one side of the joint to allow for the anticipated movement of the integral section.

Integral abutments shall be supported on a single row of parallel piles. If an integral abutment design uses steel H piles, they shall be driven so the pile's web is parallel to the centerline of bearing.

The expansion length at the abutment for an integral structure is considered to be two-thirds of the total length of the structure. For phased construction projects no abutment phase shall be designed to be supported on less than three piles.

Phased construction integral backwall details shall have a closure section detailed between sections of staged construction to allow for dead load rotation of the main beams or girders. Fig. 1.35 shows details for integral abutments with a steel beam or girder superstructure. Cantilevered or turn back wingwalls shall not be used with integral abutments.

1.9 Typical Case Studies: Integral Abutment Bridges

i) Maine Department of Transportation: Smith Bridge

Smith bridge was designed in 1993 by Maine Department of Transportation. The two lane bridge over Meduxnekeag River is located on Houlton Aroostook county, Maine (Fig. 1.36). The two span composite steel girder bridge has a total length of 57.30 m (188 ft). The general view of the bridge and design criteria are given in Figs. 1.37 and Fig. 1.38. Figs. 1.39 - 1.42 show the details of abutments. The plan view and details of pier are shown in Figs. 1.43 - 1.45. Fig. 1.46 shows the plan and transverse section of the superstructure. The descriptions of abutment, pile, pier and superstructure are given in Figs. 1.47 - 1.51.

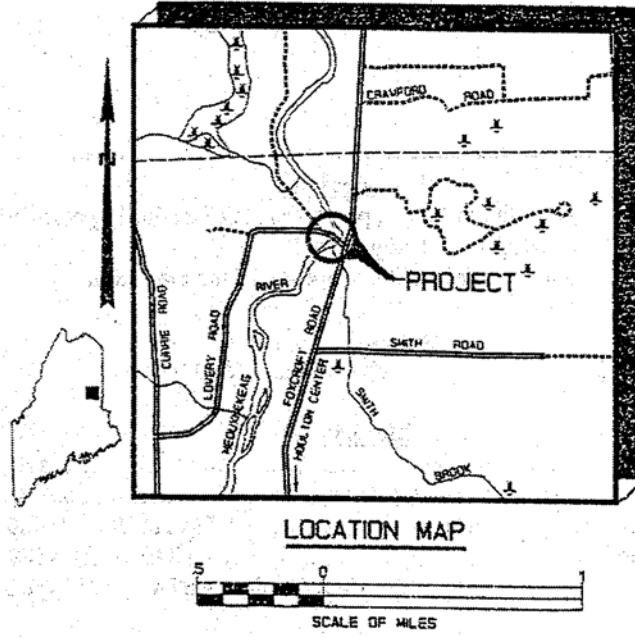

Figure 1.36 Location of Smith Bridge

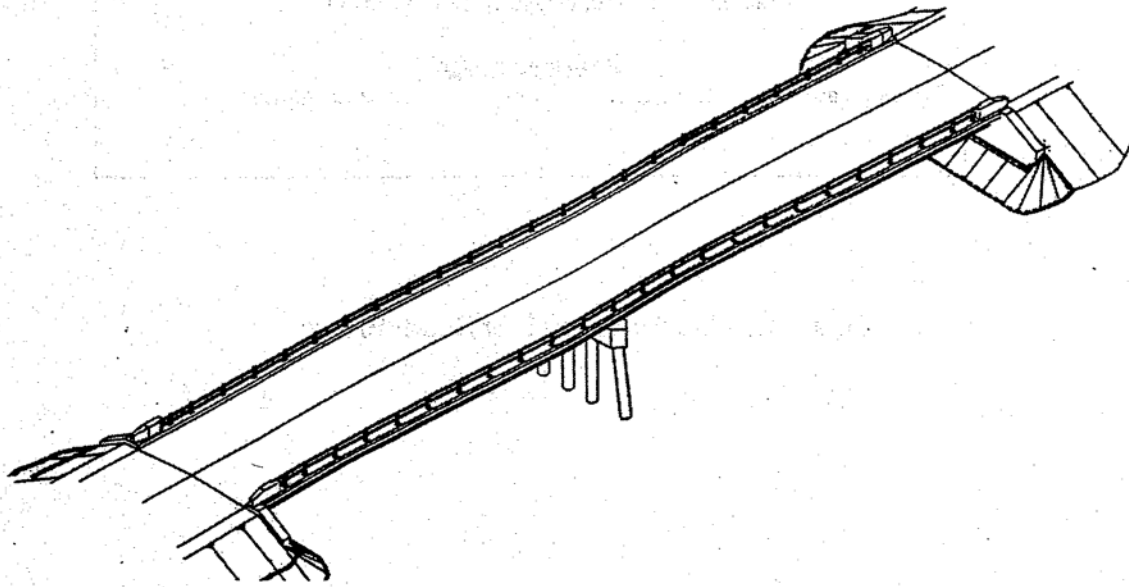

Figure 1.37 General view of Smith Bridge

<u>Specification</u>	
Design:	Load factor design per AASHTO Standard Specifications for Highway Bridges 1992.
Contract:	State of Maine, Department of Transportation
<u>Design loading</u>	
Live load: HS25	Stress cycles 500,000
<u>Materials</u>	
Concrete:	for steel casings.....class S All other unless noted.....class A
Reinforcing steel:ASTM A615 Grade 60
Structural steel:All material A588 High strength bolts ASTM A325 type 3
<u>Basic design stresses</u>	
Concrete:	$f'_c = 3,000$ psi
Reinforcing steel:	$f_y = 60,000$ psi
Structural steel: A588	$f_y = 50,000$ psi
<u>Traffic data</u>	
Data not available, bridge closed to traffic 1986	
<u>Hydrologic data</u>	
Drainage area.....	= 252 sq. miles

Figure 1.38 Design criteria for Smith Bridge

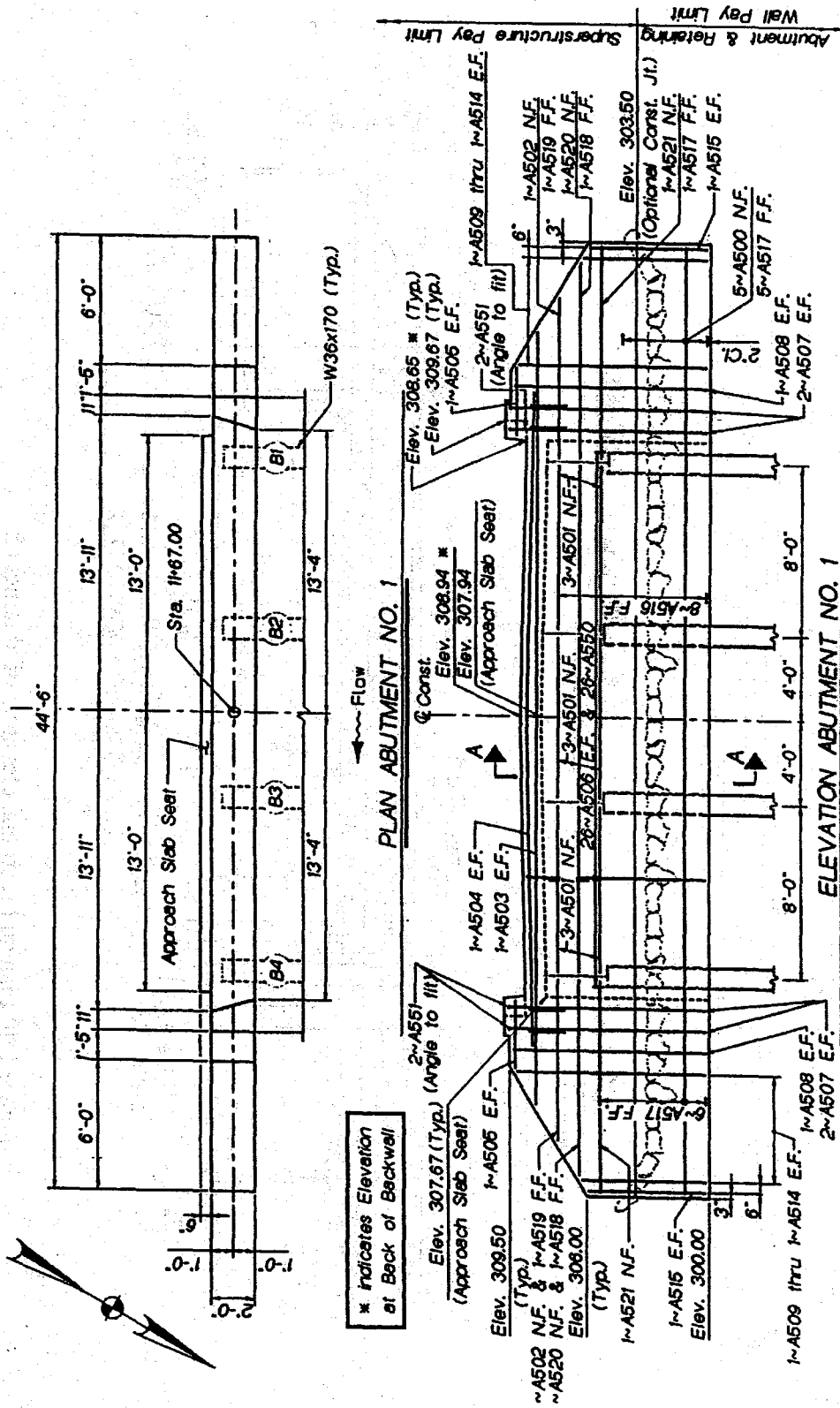

Figure 1.39 Plan and sectional elevation of abutment 1

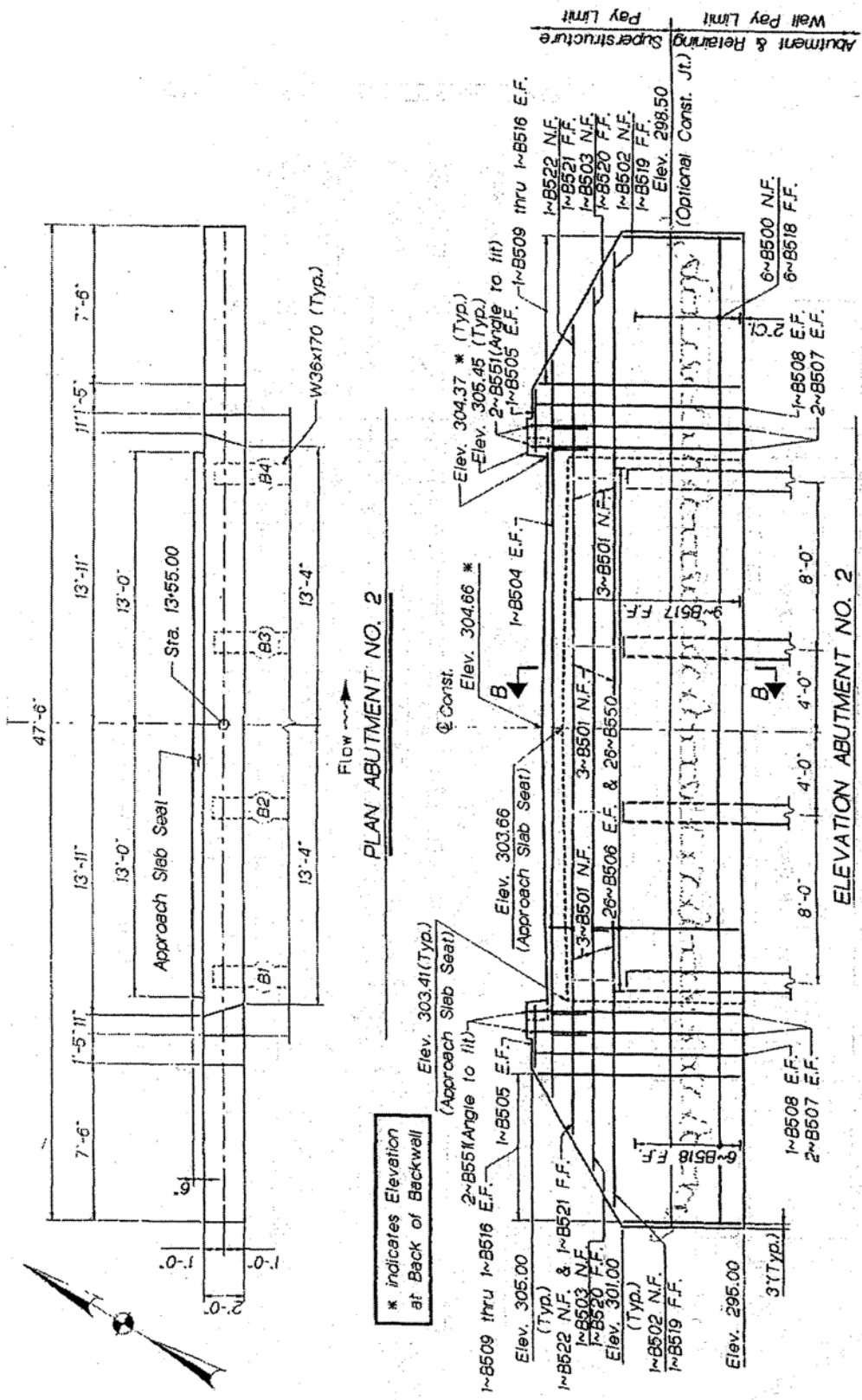

Figure 1.40 Plan and sectional elevation of abutment 2

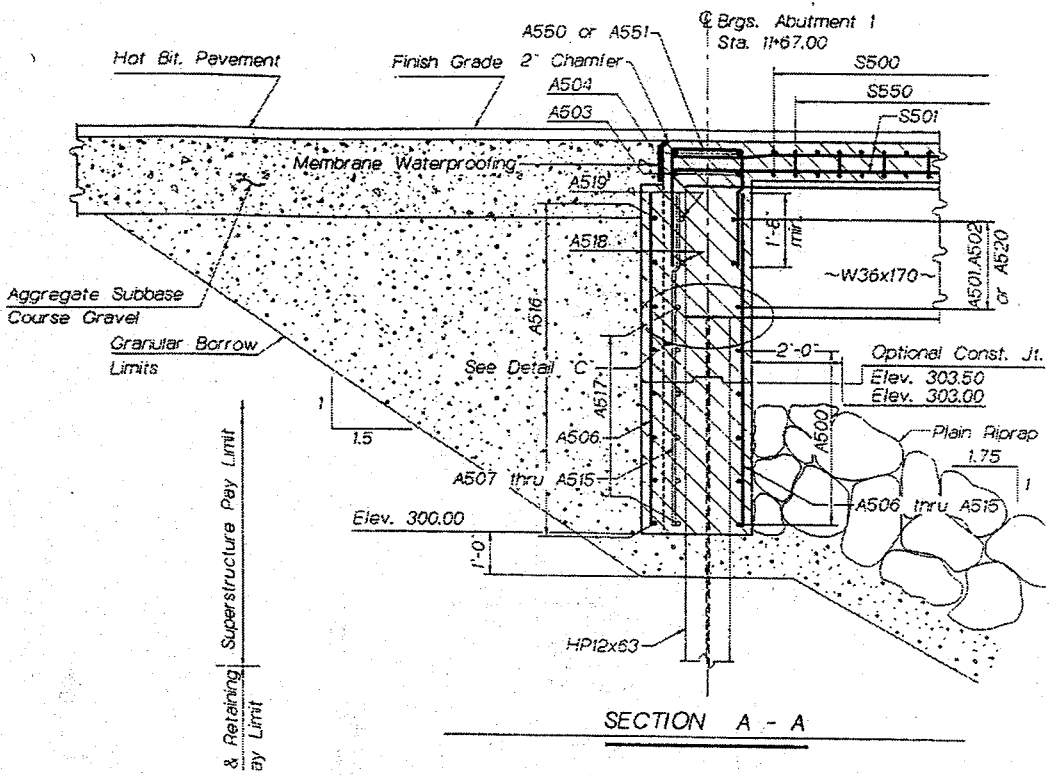

Figure 1.41 Cross sectional details of abutment 1

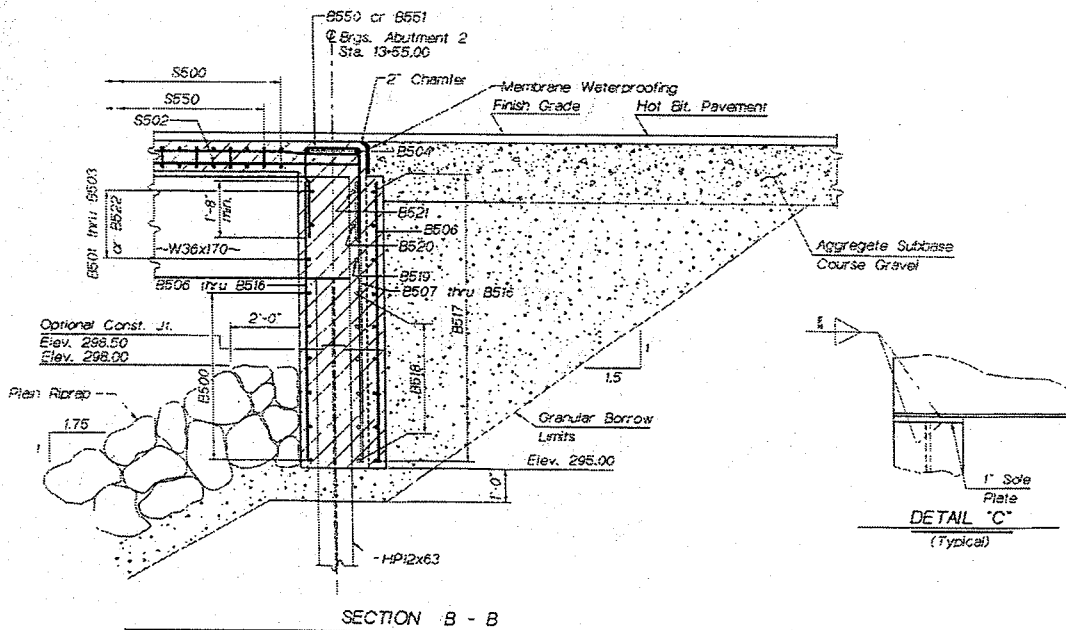

Figure 1.42 Cross sectional details of abutment 2

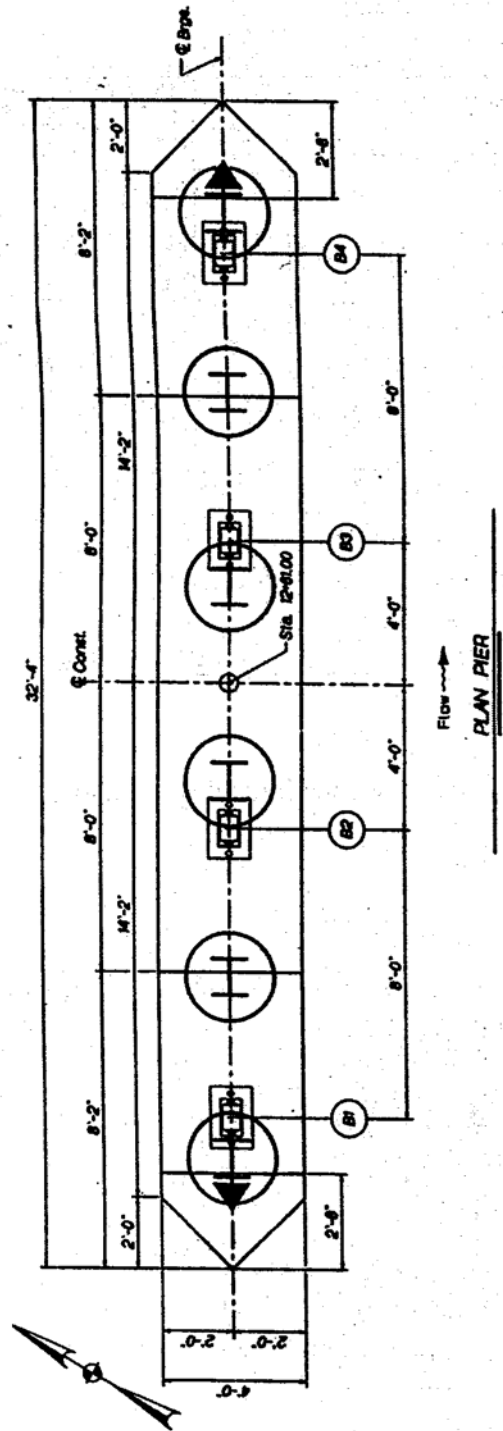

Figure 1.43 Plan view of pier

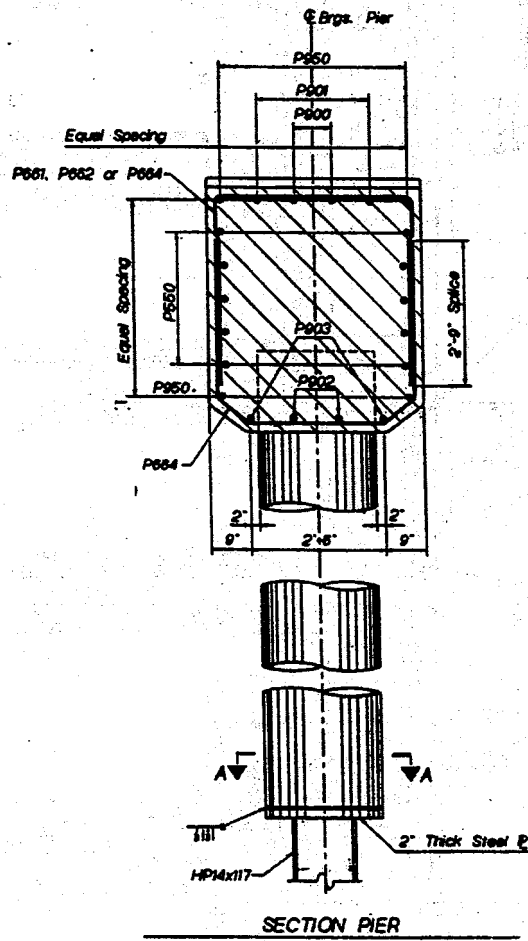
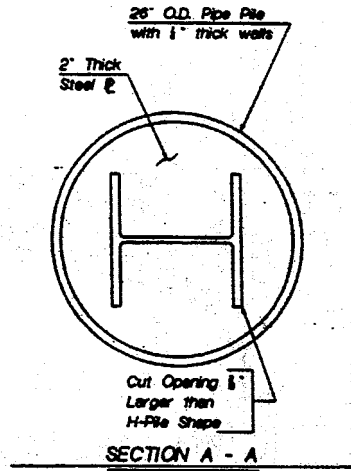
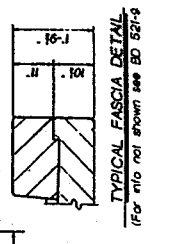
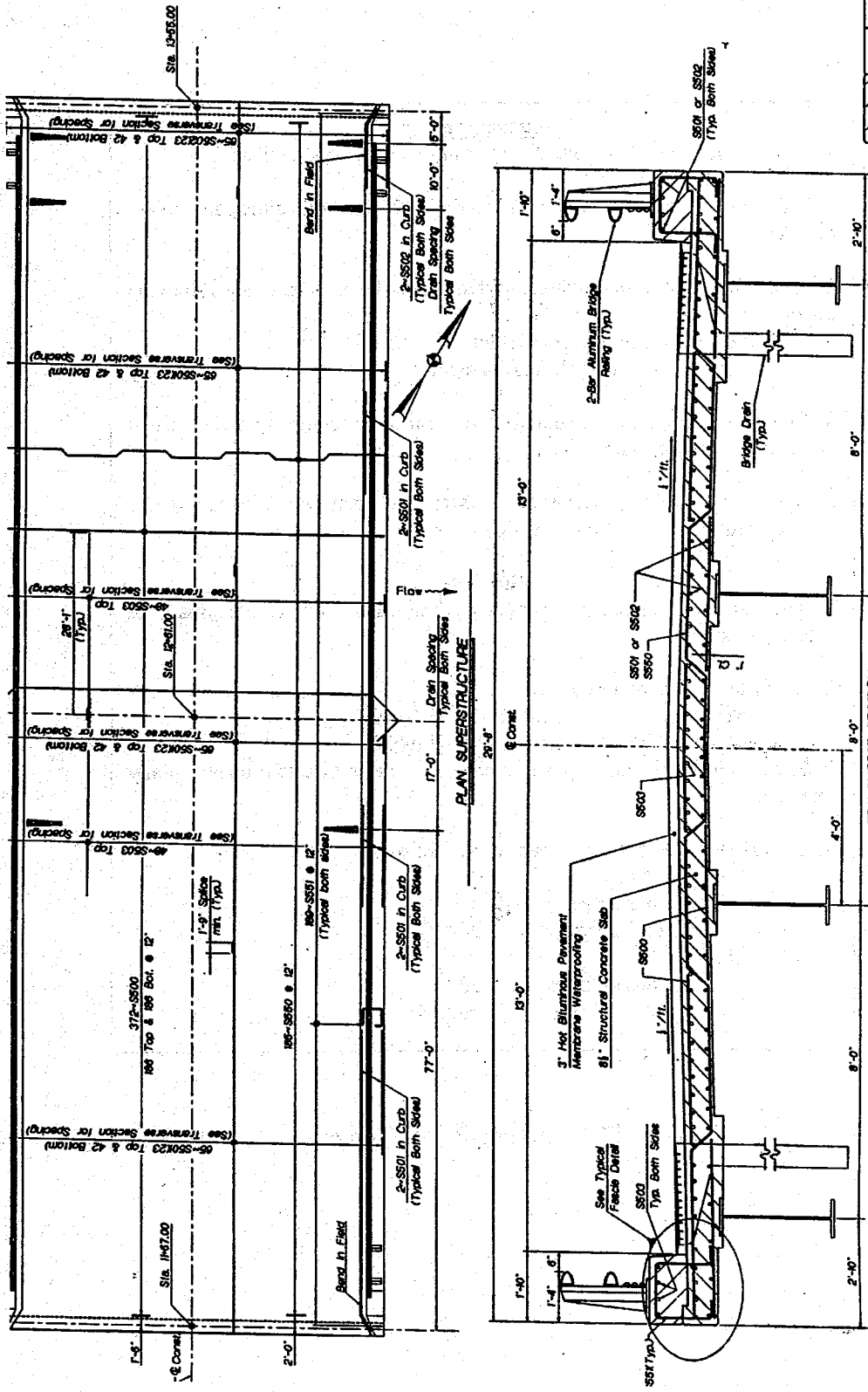

Figure 1. 45 Pier cross section



TYPICAL FASCIA DETAIL
 (For info not shown see BD 521-9)

BLOTTING TABLE

Station	Elevation (ft)																	
	-10	-20	-30	-40	-50	-60	-70	-80	-90	-100	-110	-120	-130	-140	-150	-160	-170	-180
Bottom 1	307.81	307.81	307.81	307.81	307.81	307.81	307.81	307.81	307.81	307.81	307.81	307.81	307.81	307.81	307.81	307.81	307.81	307.81
Bottom 2	307.81	307.81	307.81	307.81	307.81	307.81	307.81	307.81	307.81	307.81	307.81	307.81	307.81	307.81	307.81	307.81	307.81	307.81
Bottom 3	307.81	307.81	307.81	307.81	307.81	307.81	307.81	307.81	307.81	307.81	307.81	307.81	307.81	307.81	307.81	307.81	307.81	307.81
Bottom 4	307.81	307.81	307.81	307.81	307.81	307.81	307.81	307.81	307.81	307.81	307.81	307.81	307.81	307.81	307.81	307.81	307.81	307.81

Figure 1.46 Plan and transverse section of the superstructure

Abutment notes

1. Reinforcing steel shall have 2" cover unless otherwise indicated.
2. All reinforcing steel shall be spaced at 12" in both directions unless otherwise indicated.
3. Protective coating for concrete surfaces shall be applied to the following areas:
 - 1ft below top of backwalls on the back side.
 - Top of concrete curbs and parapets.
4. Coarse gravel aggregate subbase over lain by bituminous pavement will be used as approach slabs.
5. Membrane waterproofing shall be wrapped down over the ends of the slab to within 1" of the approach slab seats.

Pile Notes

1. The required ultimate pile capacity of each HP12x63 is 221 kips. The safety factor is 3.0.
2. Estimate of piles required:
 - Abutment No. 14-HP12x63 @ 40'
 - Abutment No. 24-HP12x63 @ 38'
3. Piles shall not be out of position shown by more than two inches in any direction.
4. Cut-off elevation for top of piles are as follows:
 - Abutment No. 1
 - Interior piles304.94
 - Exterior piles.....304.77
 - Abutment No. 2
 - Interior piles300.71
 - Exterior piles.....300.54

Figure 1.47 Abutment and pile notes

Pile notes

1. H-piles shall be driven to ledge or practical refusal. Pipe piles shall be driven 10' minimum below streambed.
2. All H-piles shall have cast steel prefabricated pointed pile tips.
3. Estimated drive lengths of piles are determined from available soil information with no allowance for uncertain pile penetration.
4. Embedment of piles in pier cap may vary between 1'-0" and 2'-0".
5. Piles marked thus \dashrightarrow shall be battered 3.5" per foot in the direction of the arrow.
6. The required ultimate pile capacity of each HP14x117 is 413 kips. The safety factor is 3.0.
7. Following are number size and estimated driven lengths of piles required for the pier:
 - 6 – HP14x117 @ 38 feet
 - 6 – 0.25"x26" O.D. steel pipe piles @ 23'
8. The top 1'-6" of pipe piles may be filled with Class A concrete.
9. Holes shall be provided in the pipe piles and H-piles to allow placement of two P902 longitudinal reinforcing bars. Holes shall not be drilled until the piles are in their final location.

Pier Notes

Reinforcing steel shall have 2 inches minimum cover unless otherwise indicated.

Design criteria

Critical AASHTO loading(1989) – Group VIII.

Buoyancy – water level assumed at Elevation 300.2 (Q50)

Stream flow – velocity of 5.2 feet per second skewed at 0 degrees to longitudinal centerline of pier.

Wind – 100 mph.

Ice – 24" thick, producing 100 psi. Ice pressure skewed at 0 degree to longitudinal centerline of pier, with water level at elevation 300.2.

Figure 1.48 Pier and pile notes

Structural steel notes

1. Bearing stiffeners shall be plumb after erection and loading of the structure.
2. Cross-frame or diaphragm connection plates may be either plumb or normal to the top flange.
3. The negative moment piece of each beam, the W36x260 shall be placed with natural mill camber down. The positive moment pieces, W36x170, shall have a camber of 2.25' at their mid-ordinates and shall be placed with camber up. It is anticipated that the positive moment W36x170 pieces will deflect 3/8" at mid-ordinate due to the weight of the steel alone.

Basic design stresses

Structural steel: A588 $F_y = 50,000$ psi

Materials

Structural steel: Unpainted A588
and ASTM A325-Type 3 high strength bolts

Figure 1.49 Structural steel notes

Superstructure notes

1. Form a 1" V-groove on the fascias at the horizontal joint between the curb and the slab.
2. Reinforcing steel shall have a minimum cover of 2" unless otherwise indicated.
3. Adjust reinforcing steel to fit around the drains in a manner approved by the engineer. Do not cut transverse reinforcing bars.
4. The superstructure slab concrete shall be placed in one continuous operation.
5. Prospective coating for concrete surfaces shall be applied to the following areas:
 - Top and face of concrete curbs.
 - Fascias down to the drip notch.
 - All exposed surfaces of concrete and posts.
6. All curb and endpost concrete shall contain a silica fume additive.

Figure 1.50 Superstructure notes

Mark	No.	Length	Loaction
Abutment No.1			
A500	5	44'-2"	Breastwall/Wings
A501	9	7'-7"	Breastwall/Wings
A502	2	7'-7"	Breastwall/Wings
A503	2	36'-8"	Breastwall/Wings
A504	2	30'-7"	Breastwall/Wings
A505	4	3'-2"	Parapets
A506	52	7'-4"	Breastwall
A507	8	8'-3"	Breastwall
A508	4	9'-1"	Breastwall
A509	4	9'-0"	Wing
A510	4	8'-5"	Wing
A511	4	7'-10"	Wing
A512	4	7'-3"	Wing
A513	4	6'-8"	Wing
A514	4	6'-1"	Wing
A515	4	5'-9"	Wing
A516	8	25'-8"	Approach slab seat
A517	12	11'-3"	Wing
A518	2	10'-10"	Wing
A519	2	9'-0"	Wing
A520	2		Wing

Mark	No.	Length	Loaction
Abutment No.2			
B500	6	47'-2"	Breastwall/Wings
B501	9	7'-8"	Breastwall/Wings
B502	2	10'-9"	Breastwall/Wings
B503	1	8'-11"	Breastwall/Wings
B504	2	34'-9"	Breastwall/Wings
B505	4	3'-0"	Parapets
B506	52	8'-0"	Breastwall
B507	4	9'-0"	Breastwall
B508	2	9'-8"	Breastwall
B509	4	9'-7"	Wing
B510	4	9'-0"	Wing
B511	4	8'-5"	Wing
B512	4	7'-10"	Wing
B513	4	7'-4"	Wing
B514	4	6'-9"	Wing
B515	4	6'-2"	Wing
B516	4	5'-7"	Wing
B517	9	25'-8"	Approach slab seat
B518	12	12'-9"	Wing
B519	2	11'-11"	Wing
B520	2	10'-2"	Wing
B521	2	8'-6"	Wing
B522	2	7'-0"	Wing

Figure 1.51a Reinforcing steel schedule

Mark	No.	Length	Loaction
Abutment No.2			
B500	6	47'-2"	Breastwall/Wings
B501	9	7'-8"	Breastwall/Wings
B502	2	10'-9"	Breastwall/Wings
B503	1	8'-11"	Breastwall/Wings
B504	2	34'-9"	Breastwall/Wings
B505	4	3'-0"	Parapets
B506	52	8'-0"	Breastwall
B507	4	9'-0"	Breastwall
B508	2	9'-8"	Breastwall
B509	4	9'-7"	Wing
B510	4	9'-0"	Wing
Pier			
P900	2	31'-2"	Cap
P901	2	29'-9"	Cap
P902	2	30'-0"	Cap
P903	2	28'-7"	Cap
Superstructure			
S500	372	29'-4"	Deck
S501	207	60'-0"	Deck & Curbs
S502	69	14'-11"	Deck
S503	96	29'-0"	Deck & Curbs

Figure 1.51 b Reinforcing steel schedule

Bent bars														
Mark	No.	Length	Type	A	B	C	D	E	F	G	H	O	R	Location
Abutment No. 1														
A550	26	7'-6"	S	--	2'-11"	1'-8"	2'-11"	--	--	--	--	--	--	Backwall
A551	4	7'-0"	S	--	2'-8"	1'-8"	2'-8"	--	--	--	--	--	--	Parapets
Abutment No. 2														
B550	26	7'-6"	S	--	2'-11"	1'-8"	2'-11"	--	--	--	--	--	--	Backwall
B551	4	7'-0"	S	--	2'-8"	1'-8"	2'-8"	--	--	--	--	--	--	Parapets
Pier														
P550	10	33'-4"	X	--	--	2'-7"	28'-2"	2'-7"	--	--	1'-10"	31'-10"	--	Cap
P660	16	9'-11"	Y	3'	9"	2'-5"	9"	3'-0"	--	--	6"	3'-8"	--	Cap
P661	28	10'-8"	S	--	3'-6"	3'-8"	3'-6"	--	--	--	--	--	--	Cap
P662	2	9'-10"	S	--	3'-6"	2'-10"	3'-6"	--	--	--	--	--	--	Cap
P663	28	3'-8"	V	--	--	--	3'-0"	8"	--	--	7"	--	--	Cap
P664	4	7'-0"	S	--	3'-1"	10"	3'-1"	--	--	--	--	--	--	Cap
P950	4	33'-4"	X	--	--	2'-7"	28'-2"	2'-7"	--	--	1'-10"	31'-10"	--	Cap
Superstructure														
S550	185	30'-6"	B	--	4'-4"	7.75"	3'-9"	3'-4"	4'-4"	--	5.5"	29'-4"	--	Deck
						X6	X3	X2						
S551	378	5'-5"	S	6"	1'-6"	1'-5"	1'-6"	--	--	6"	--	--	--	Curbs

Figure 1.51c Reinforcing steel schedule

General Notes	
1.	<p>First digit(s) following the letter of the mark indicates size of the bar:</p> <p style="margin-left: 40px;">Mark (A502) bar size-#5</p> <p style="margin-left: 40px;">Mark (P1001) bar size-#10</p> <p style="margin-left: 40px;">Mark (S603) bar size-#6</p>
2.	<p>Each truss bar, Type B, may be replaced by two straight bars (one top and one bottom) of the same bar size as the truss bar.</p>

Figure 1.51d General notes

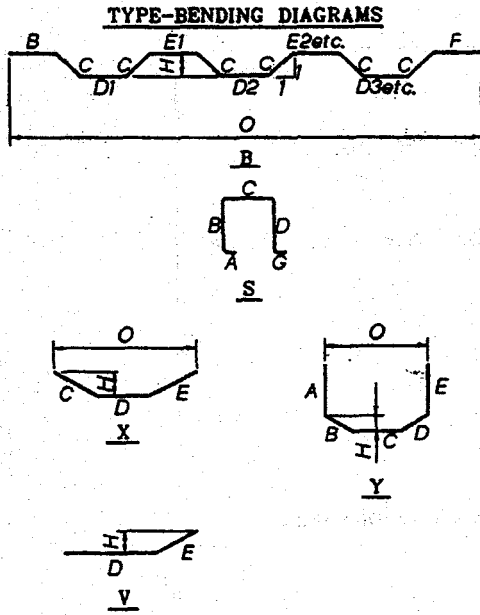

All dimensions are out to out of reinforcing bar
 Bending details and hooks shall conform to the
 recommendations of the current revision of ACI
 standard 318.

Reinforcing Bar: ASTM A615 Grade 60

Figure 1.51d Type-bending diagrams

ii) Minnesota Department of Transportation: Bridge No. 59007

This integral bridge was designed in 2000 by Minnesota Department of Transportation and proposed to span over Rock river, 1.7 km west of Edgerton in the Trunk Highway No.268. The three span bridge has a total length of 45.512 m (149.3 ft). The bridge has two lanes and four prestressed concrete girders. Design data are shown in Fig. 1.52. Figs. 1.53 and 1.54 the general, plan and elevation of the bridge. Figs. 1.55 - 1.59 show the details of superstructure, abutment and wingwall. The details of abutment diaphragm are shown in Figs.1.60 - 1.62. Fig. 1.63 shows the details of superstructure reinforcement.

Design data

1996 (and current interim) AASHTO design specifications.

Load factor design method

MS22.5 live loading

Dead load includes 0.8KN/m² allowance for future wearing course modifications.

Maximum allowable design stresses:

Reinforced concrete:

$f_c = 28$ MPa $n = 8$

$f_s = 420$ MPa reinforcement

Prestressed concrete:

$f_c = 62$ MPa $n = 1$

$f_s = 1860$ MPa for 13 mm dai. Low relaxation strands

Deck area 589m²

1280 projected A.D.T. for year 2021

operating rating MS 35.7

Construction notes

The 1995 edition of the Minnesota department of transportation "standard specifications for construction" shall govern.

The first two digits of each bark mark indicate the bar number which approximates the nominal diameter of the bar in millimeters (mm).

Bars marked with the suffix "E" shall be epoxy coated in accordance with spec. 3301.

All dimensions are in millimeter (mm) and all elevation are in meters (m), except as noted.

Figure 1.52 Design data and construction note

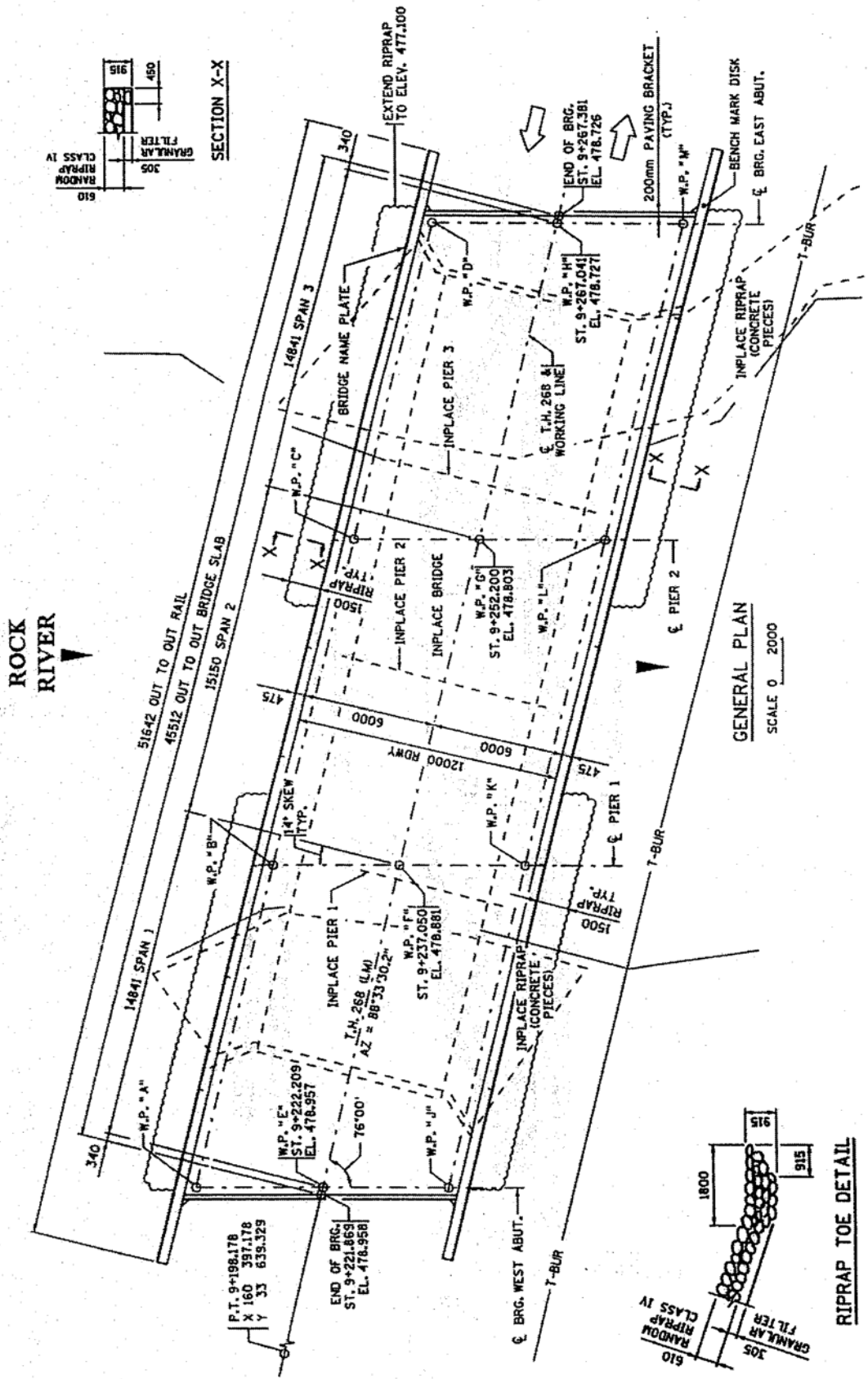
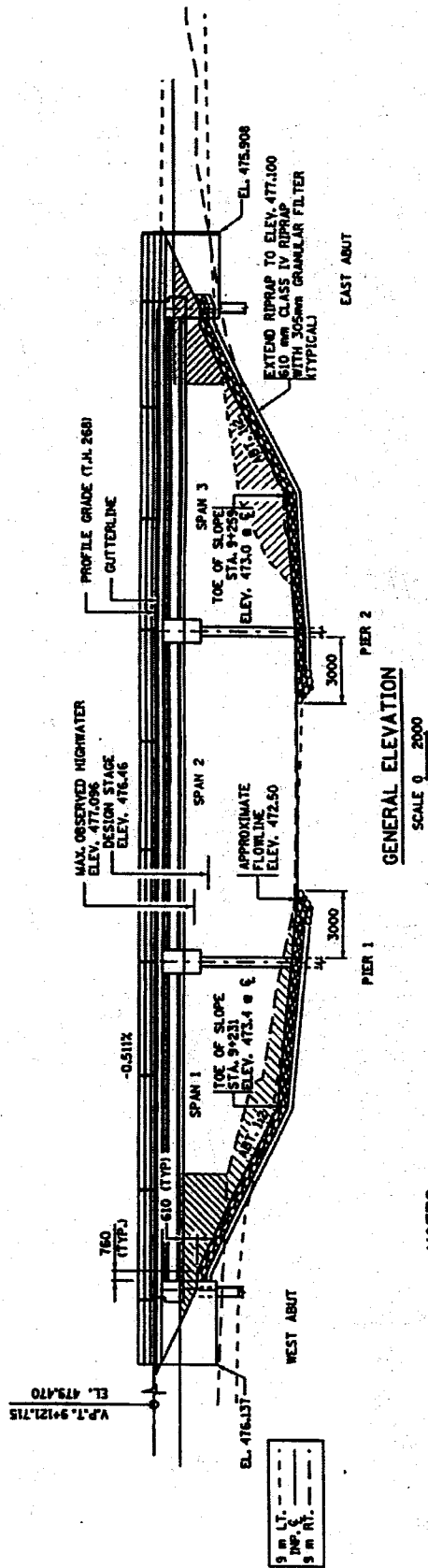

Figure 1.53 General plan



NOTES:
 APPROXIMATELY 114.9 m² OF WATERWAY AREA IS AVAILABLE BELOW ELEV. 476.37.
 MATCHED AREA TO BE REMOVED UNDER GRADING PORTION OF CONTRACT.

Figure 1.54 General elevation

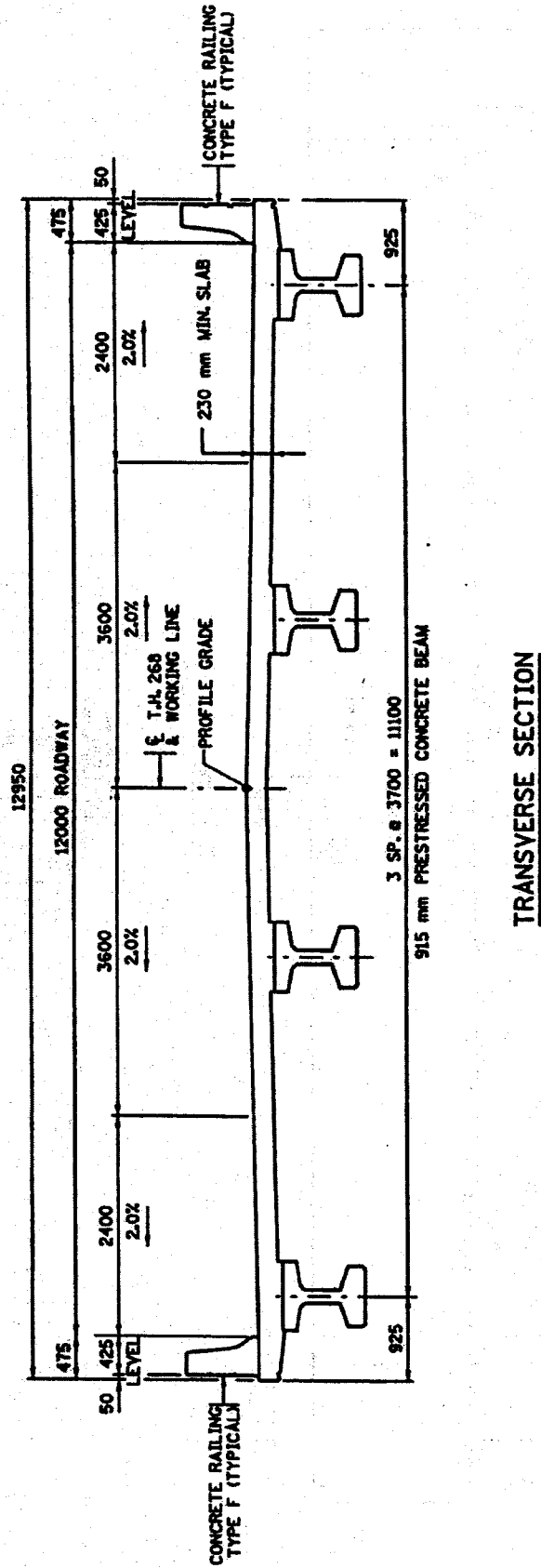

Figure 1.55 The details of superstructure

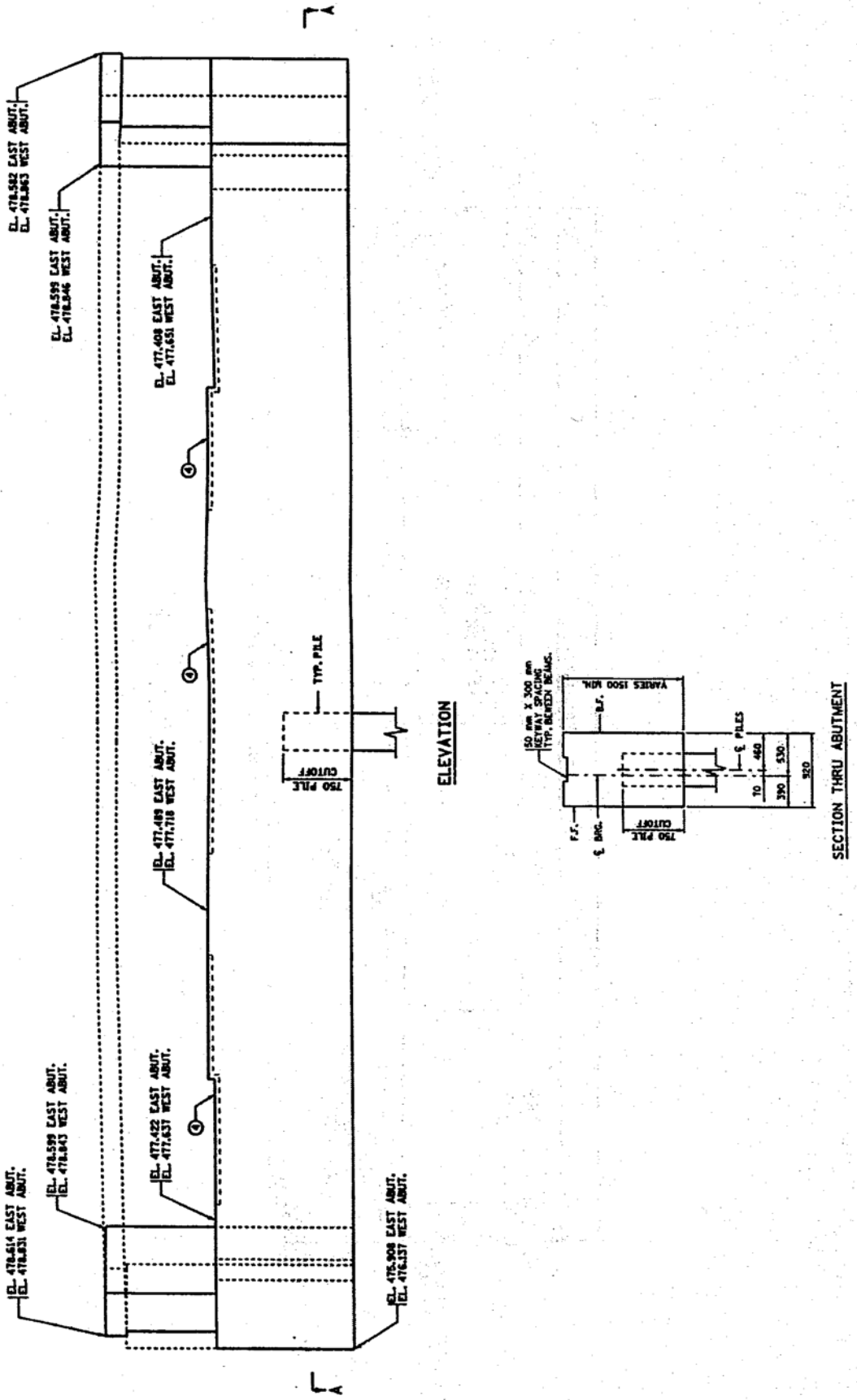
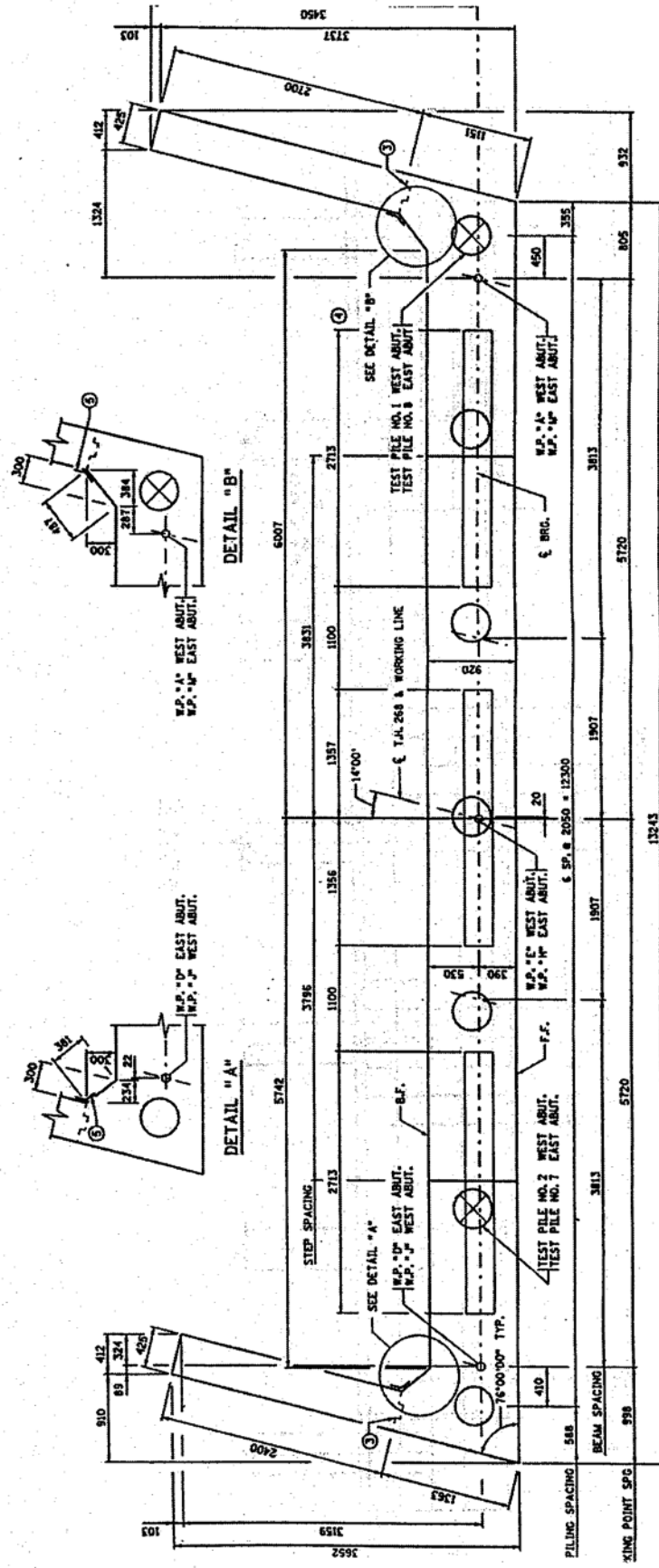

Figure 1.56a General elevation and cross section of abutment



SECTION A-A

NOTES:
 F.F. DENOTES FRONT FACE.
 B.F. DENOTES BACK FACE.

Figure 1.56b General elevation of abutment

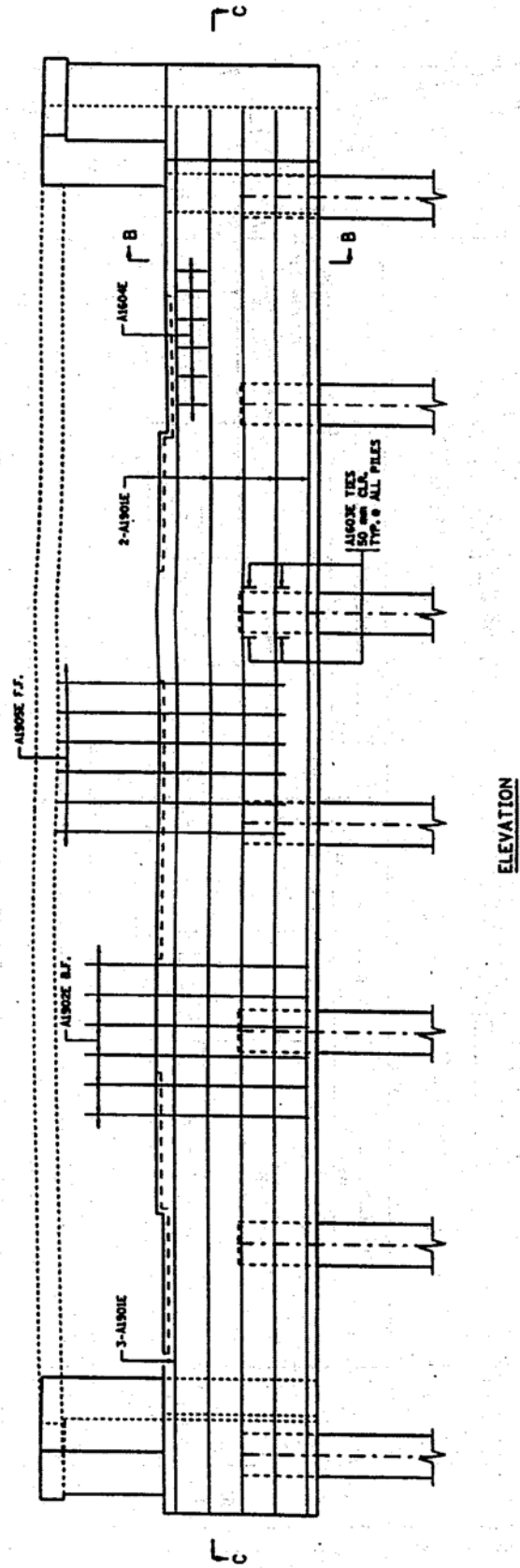

Figure 1.57a Details of abutment reinforcement

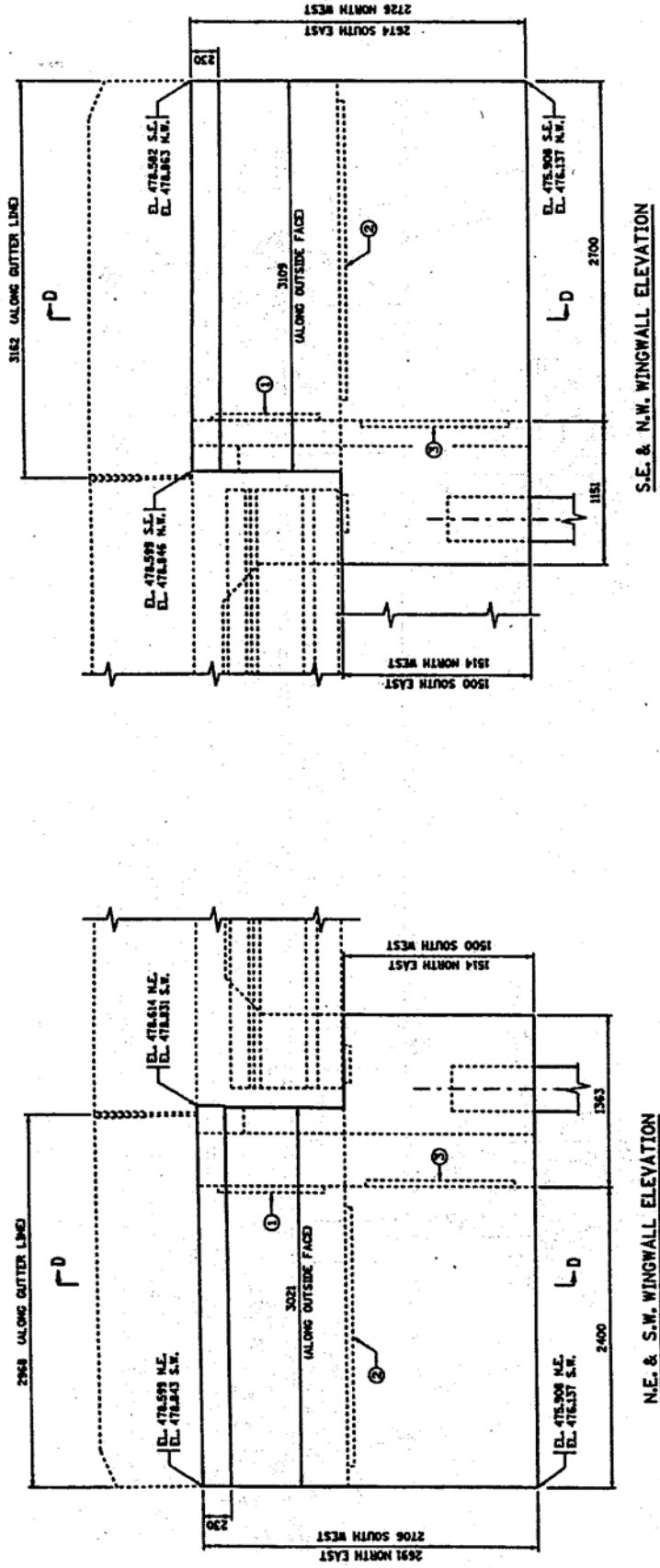
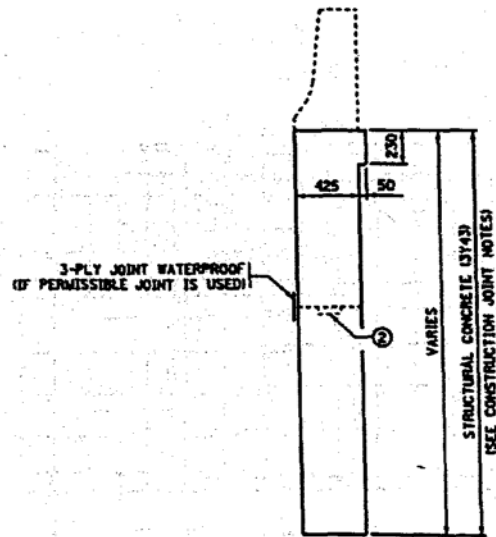

Figure 1.58a Details of abutment reinforcement



SECTION D-D

Figure 1.58b Abutment and wingwall detail section D-D

Construction joint notes:

Any portion of the wingwall may be placed with the slab and end diaphragm concrete. Use of the permissible construction joints is at the contractor's discretion with the approval of the engineer in the field.

All permissible construction joint for the abutment wingwalls and end diaphragm shall have a 50 mm x 150 mm keyway.

- ① Permissible construction joint 1. (above bridge seat)
- ② Permissible construction joint 2. (above bridge seat)
- ③ Permissible construction joint 2. (above bridge seat)

Figure 1.58c Construction joint notes

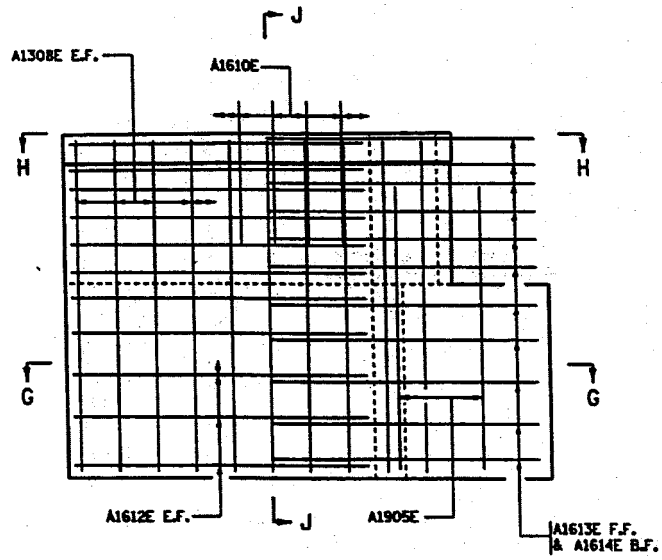

S.W. & N.E. WINGWALL EVELATION

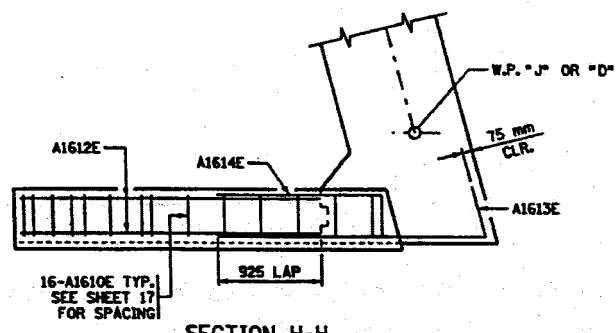

SECTION H-H

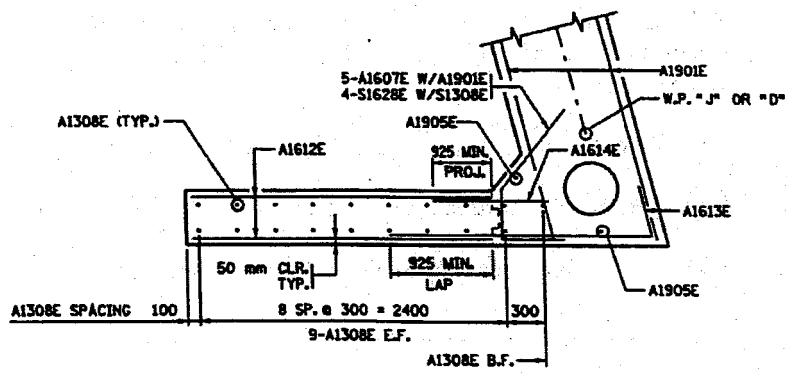

SECTION G-G

Figure 1.59a Abutment and wingwall reinforcements

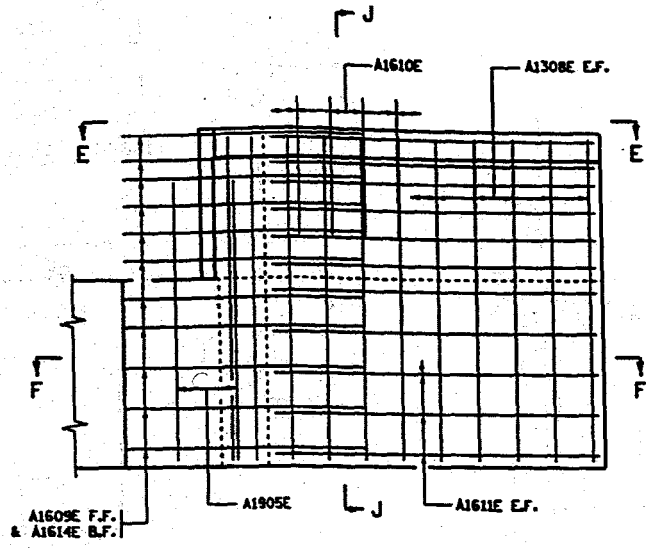

N.W. & S.E. WINGWALL ELEVATION

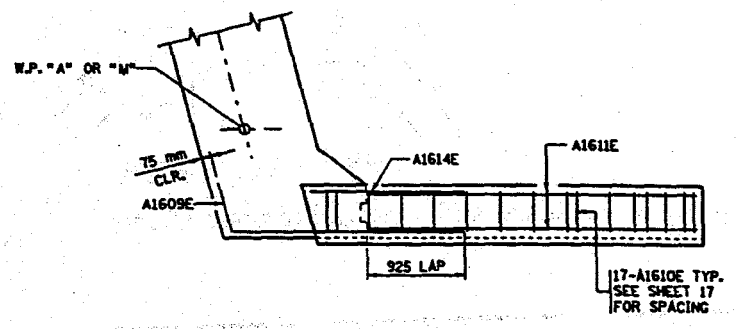

SECTION E-E

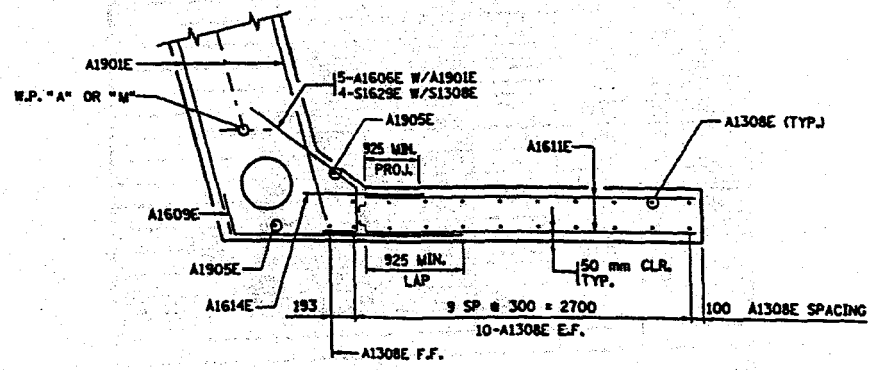

SECTION F-F

Figure 1.59b Abutment and wingwall reinforcements

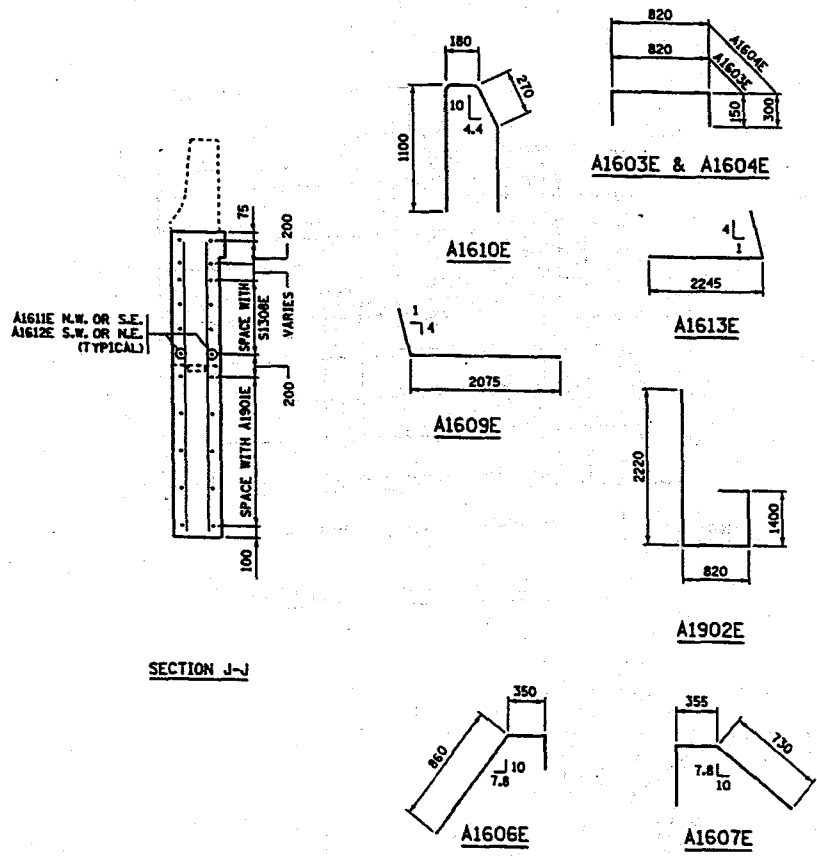

Figure 1.59c Abutment and wingwall reinforcements

Reinforcements for abutment				
BAR	NO.	LENGTH	SHAPE	LOCATION
A1901E	22	13140	—	LONGITUDINAL
A1902E	88	4740	L	STIRRUP
A1603E	56	1120	—	ABUTMENT TIES @ PILE
A1604E	108	1420	—	BRIDGE SEAT TIES
A1905E	82	2200	—	BRIDGE SEAT DOWELS
A1606E	10	1735	∧	N.W. & S.E. CORNER TIES
A1607E	10	1610	∨	S.W. & N.E. CORNER TIES
A1308E	80	2580	—	WINGWALL VERTICAL
A1609E	22	2460	∧	N.W. & S.E. CORNER DOWEL
A1610E	66	2400	—	WINGWALL VERTICAL DOWEL
A1611E	44	2650	—	N.W. & S.E. WINGWALL HORIZONTAL
A1612E	44	2350	—	S.W. & N.E. WINGWALL HORIZONTAL
A1613E	22	2640	∧	S.W. & N.E. CORNER DOWEL
A1614E	44	1425	—	ABUT. WINGWALL HORIZONTAL DOWEL B.F.

NOTES:

F.F. DENOTES FRONT FACE
 B.F. DENOTES BACK FACE
 E.F. DENOTES EACH FACE

Figure 1.59d Reinforcements for abutment

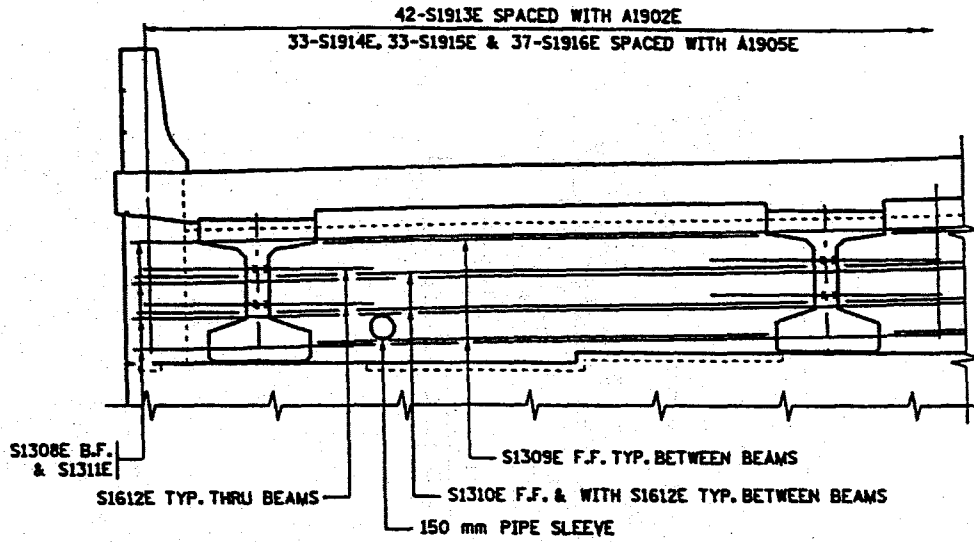

Figure 1.60 Part elevation section at abutment diaphragm

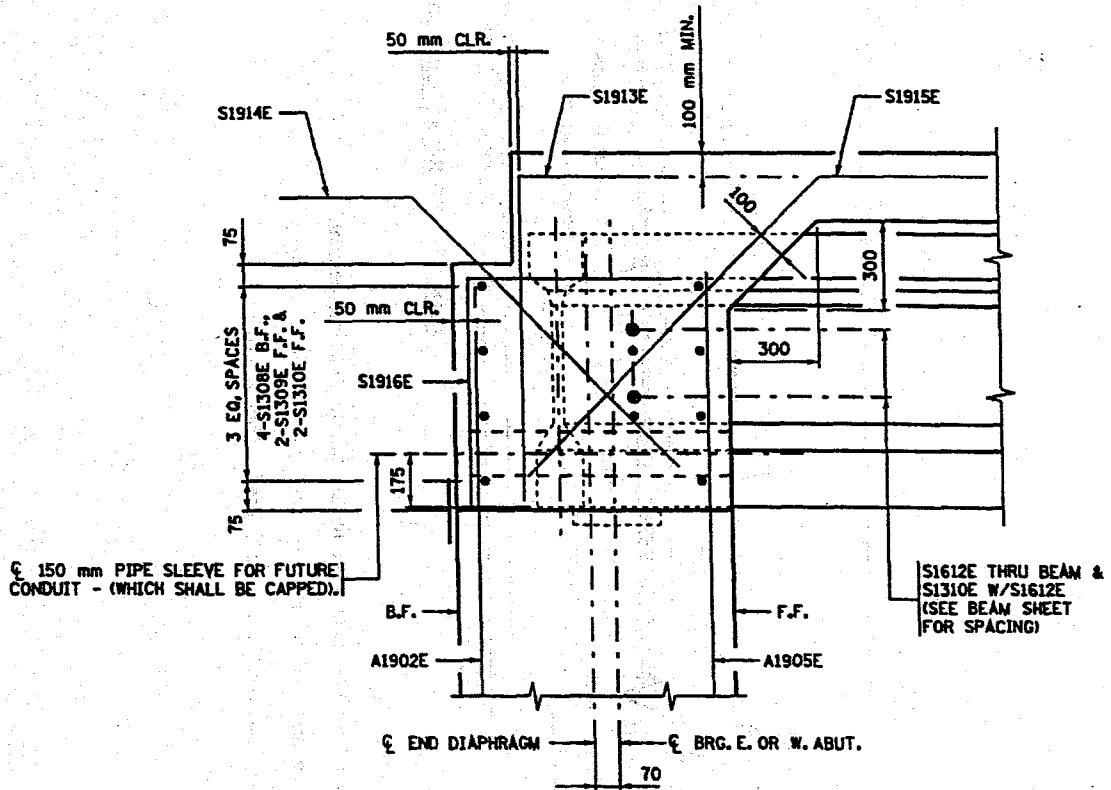
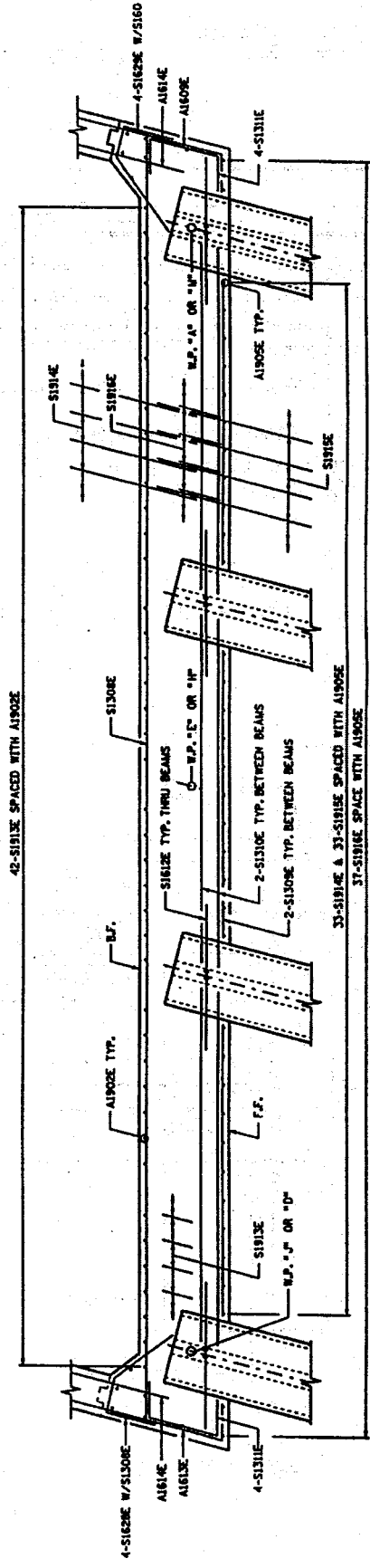

Figure 1.61 Part longitudinal section



PLAN VIEW SECTION AT ABUTMENT DIAPHRAGM

Notes:

All diaphragm bars shown are listed with the superstructure reinforcement. Diaphragm concrete and reinforcement quantities are included in the super structure quantities. Diaphragm shown to be used at abutment only.

Figure 1.62 Plan view section at abutment diaphragm

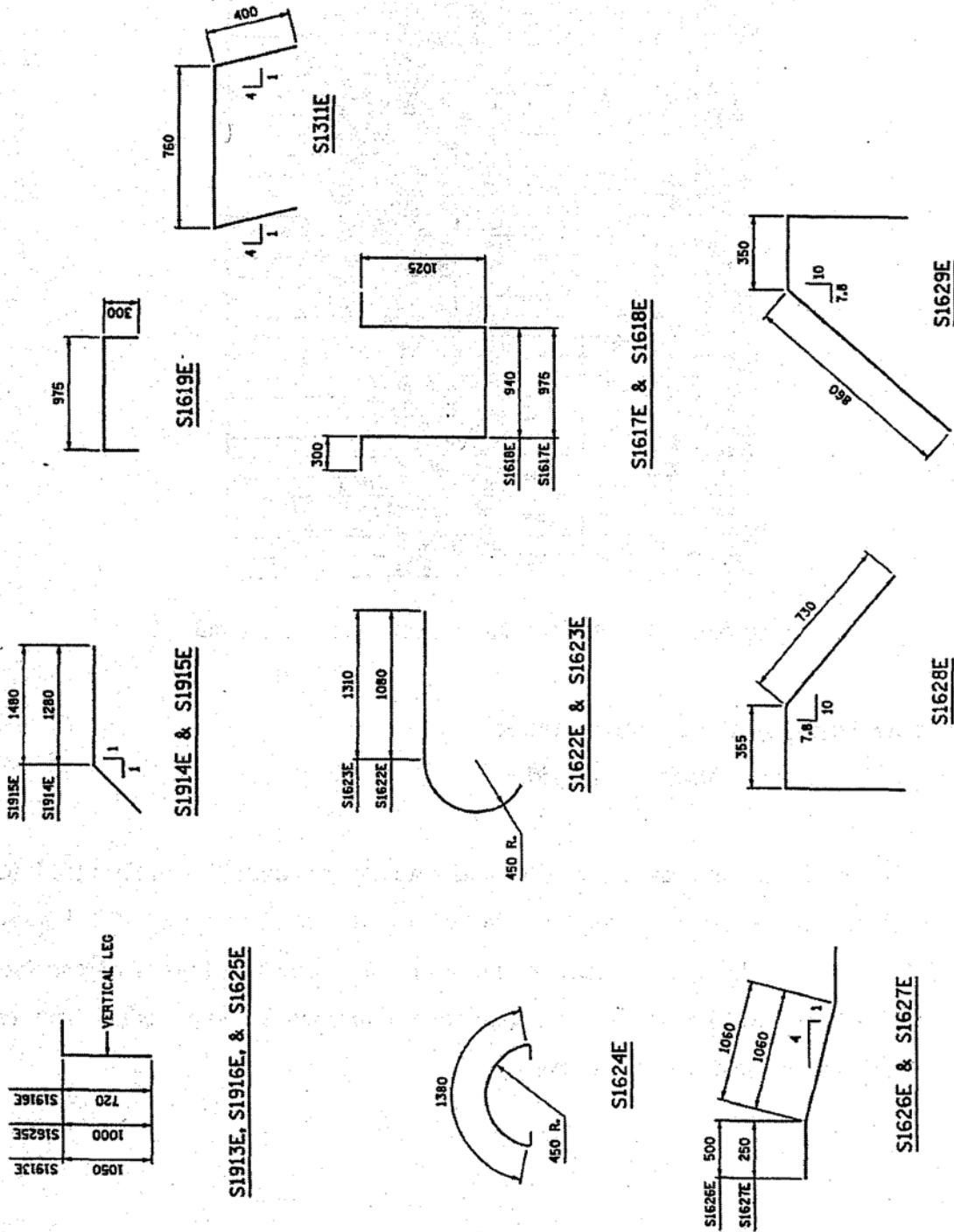

Figure 1.63a Details of superstructure reinforcement

Reinforcements for abutment				
BAR	NO.	LENGTH	SHAPE	LOCATION
S1601E	90	12000	—	SLAB LONG. TOP
S1602E	30	10610	—	SLAB LONG. TOP
S1603E	102	18000	—	SLAB LONG. BOT.
S1604E	51	10210	—	SLAB LONG. BOT.
S1905E	276	13240	—	SLAB TRANSVERSE TOP
S1906E	276	13140	—	SLAB TRANSVERSE BOT.
S2207E	108	10250	—	LONGIT. TOP OVER PIERS
S1308E	8	13140	—	ABUT. END DIAPH. HORIZ
S1309E	12	2925	—	ABUT. END DIAPH. HORIZ
S1310E	24	3555	—	ABUT. END DIAPH. HORIZ
S1311E	16	1560	—	ABUT. END DIAPH. HORIZ
S1612E	32	1525	—	ABUT. & PIER END HORIZ. THRU BEAM
S1913E	84	1500	┌	ABUT. END DIAPH. TIE
S1914E	66	1730	└	ABUT. END DIAPH. TIE
S1915E	66	1930	└	ABUT. END DIAPH. TIE
S1916E	74	1720	┌	ABUT. END DIAPH. TIE
S1617E	66	3625	U	PIER DIAPH. STIRRUP
S1618E	4	3590	U	PIER DIAPH. STIRRUP
S1619E	66	1575	┌	PIER DIAPH. TIE
S1620E	24	3555	—	PIER DIAPH. HORIZ.
S1621E	24	2925	—	PIER DIAPH. HORIZ.
S1622E	8	2240	┌	PIER DIAPH. HORIZ.
S1623E	8	2470	┌	PIER DIAPH. HORIZ.
S1624E	8	1710	└	PIER DIAPH. HORIZ.
S1625E	16	1300	┌	PIER DIAPH. VERTICAL
S1626E	8	2060	└	PIER TIE BTWN. BEAM ENDS
S1627E	8	1810	└	PIER TIE BTWN. BEAM ENDS
S1628E	8	1610	└	END DIAPH. TIE
S1629E	8	1735	└	END DIAPH. TIE

Figure 1.63b Details of superstructure reinforcement

iii) Florida Department of Transportation

a) S.R. 83 over Bluff Creek bridge

This bridge is jointless and has 10 spans with a total length 91.4 m (300 ft). It had been designed as a solid slab bridge in 1988 with a total clear width of 44 ft between curbs. The general plan and elevation of the bridge are shown in Figs. 1.64 and 1.65. Figs. 1.66 -1.69 show the details of superstructure reinforcement, intermediate bent, end abutment and drainage details respectively:

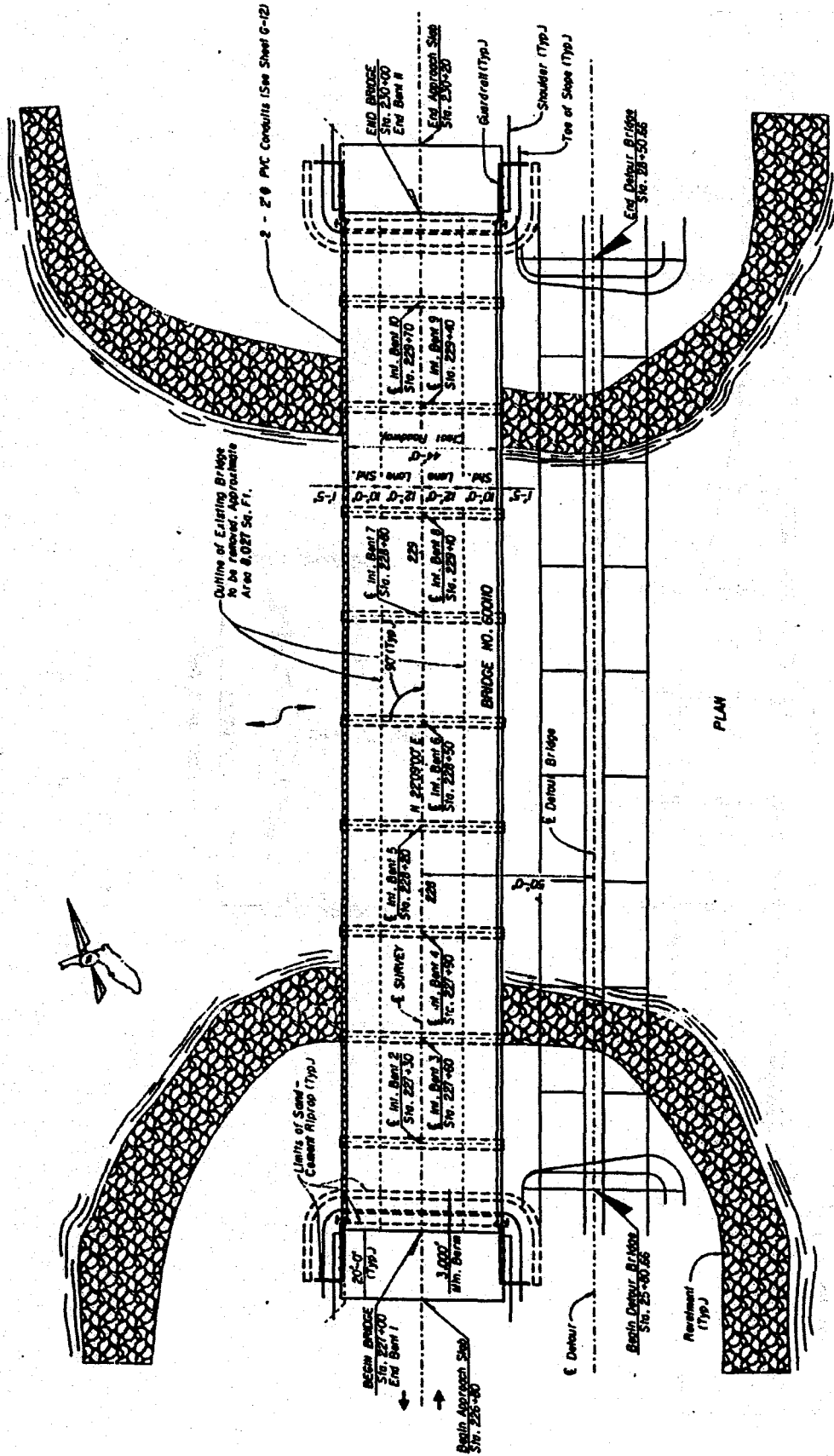

Figure 1.64 General plan

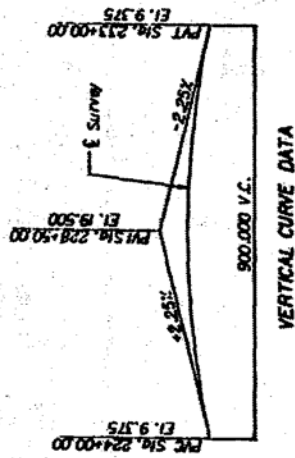
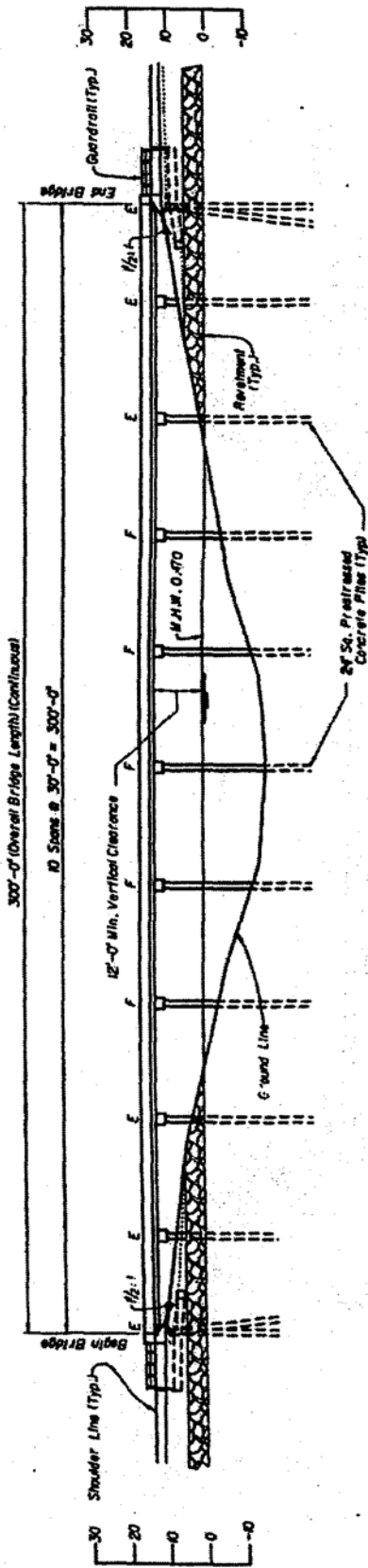
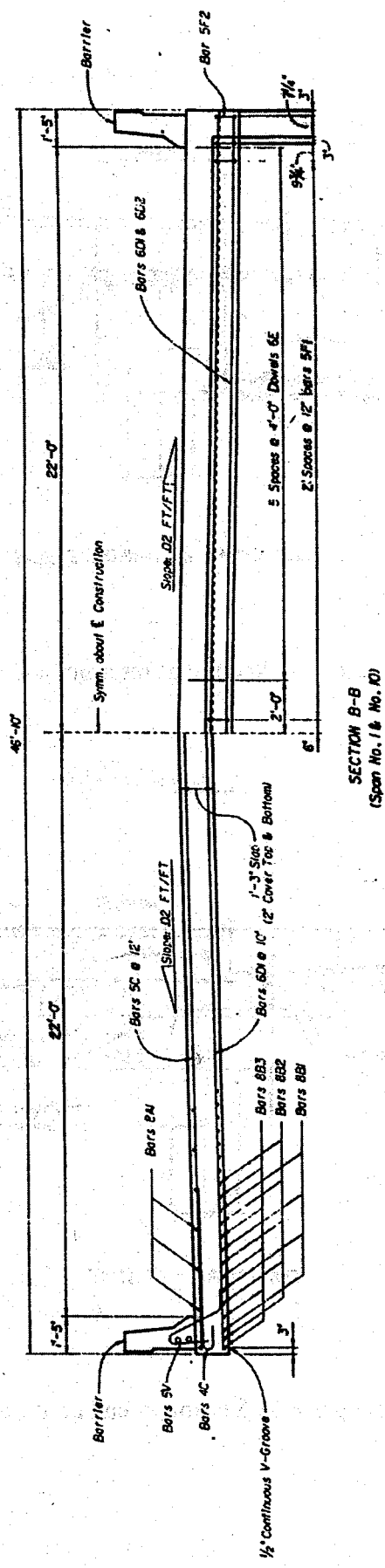

Figure 1.65 Abutment elevation



SECTION B-B
(Span No. 1 & No. 10)

Figure 1.66 The details of superstructure reinforcement

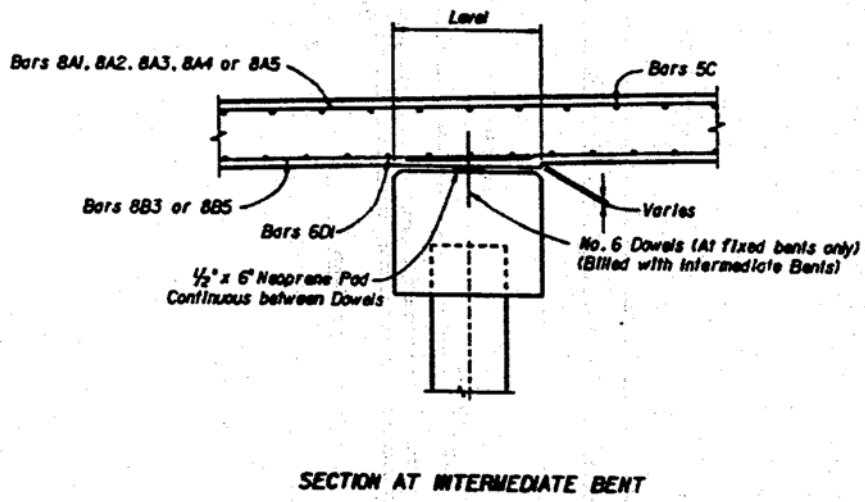

Figure 1.67 Section at intermediate bent

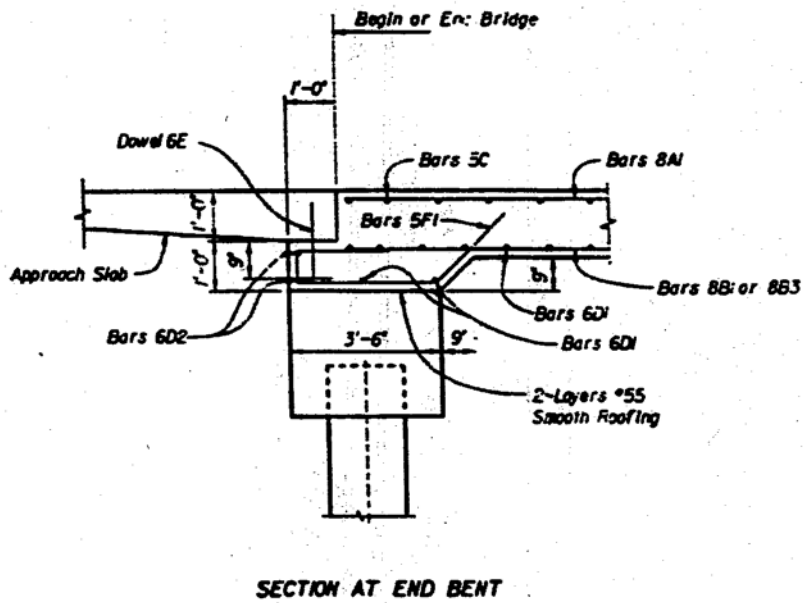

Figure 1.68 Section at end abutment

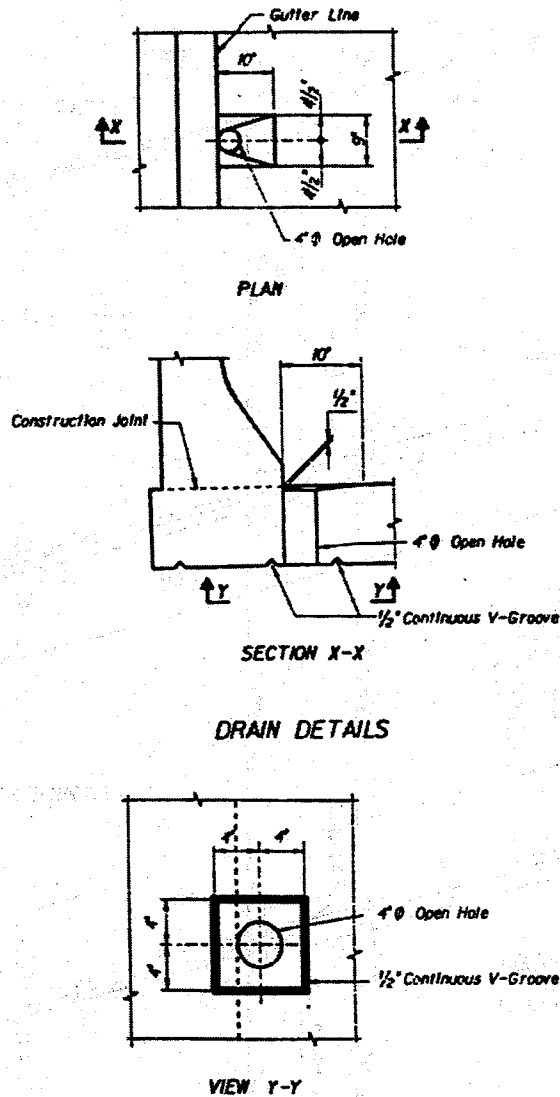

Figure 1.69 Drainage details

b) Florida Department of Transportation, S.R. 20 over Bluff Creek bridge

This 11 jointless bridge has three spans with a total length of 23.16 m (76 ft). The plan of superstructure and reinforcements in the solid slab are shown in Figs. 1.70 and 1.71. The details of the jointless bridge over the intermediate and end bents are shown in Fig. 1.72. Figs. 1.73 - 1.75 show the abutment plan, elevation and reinforcement details. The approach slab details are in Fig. 1.76.

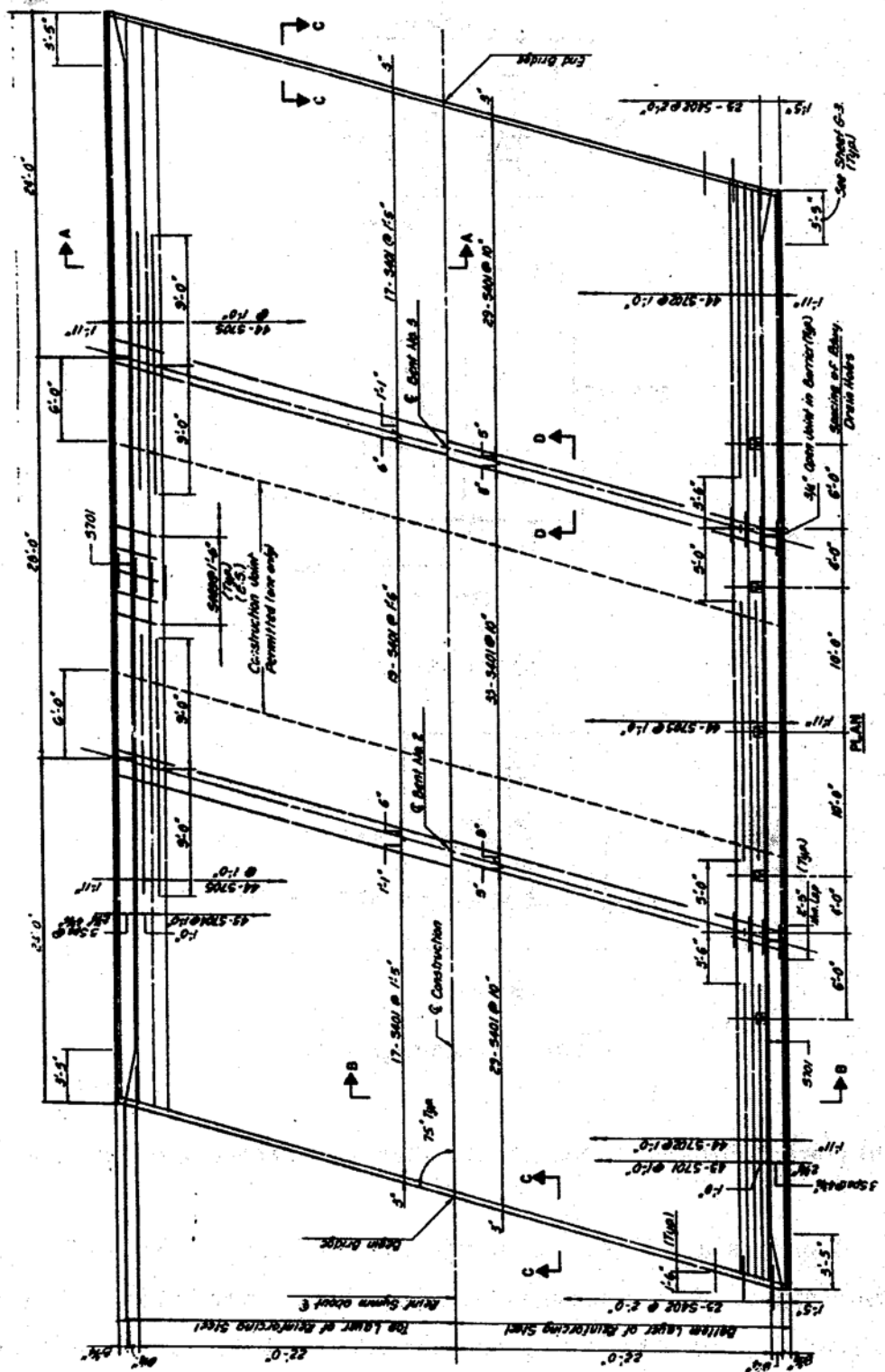

Figure 1.70 Details of Bluff Creek Bridge superstructure

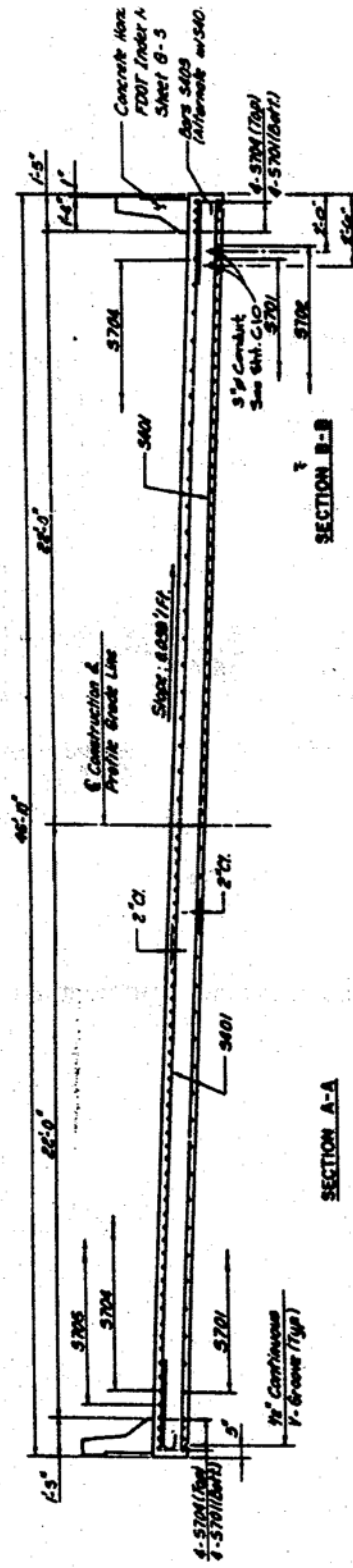

Figure 1.71 Details of Bluff Creek Bridge superstructure

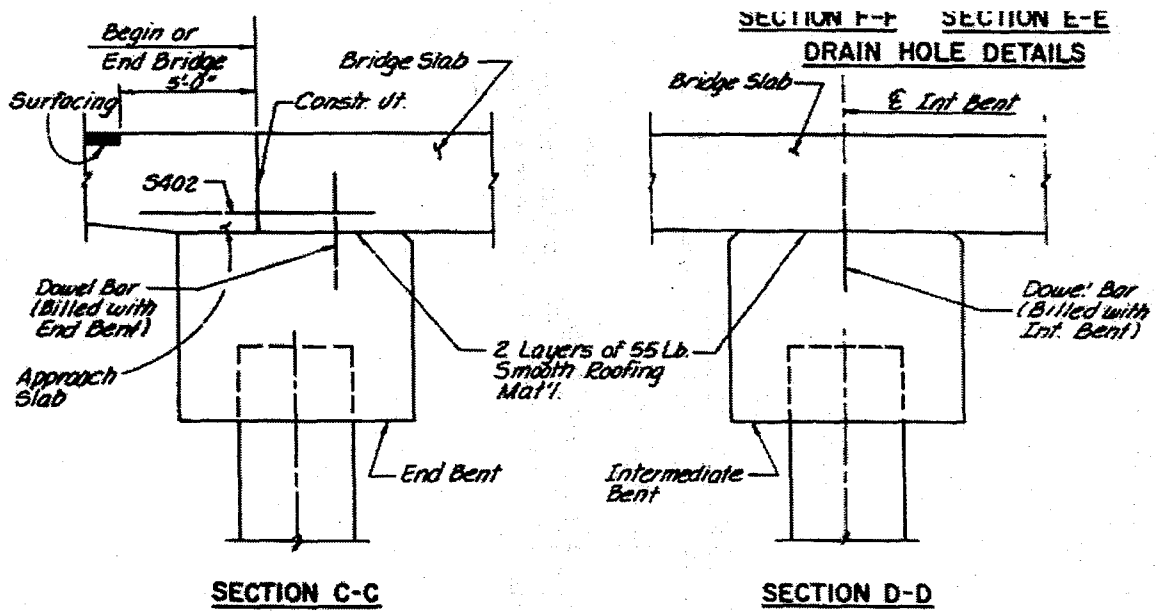

Figure 1.72 Details of the end abutment, and intermediate support

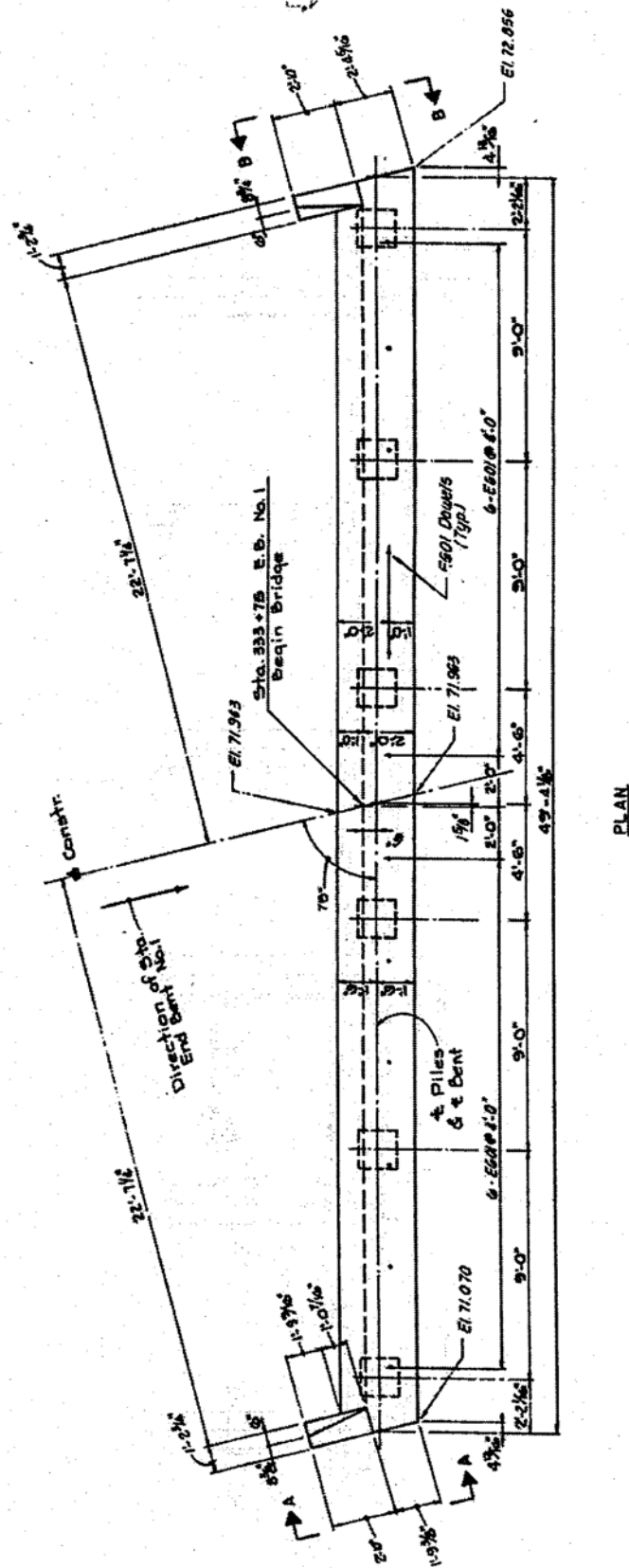

Figure 1.73 Abutment plan

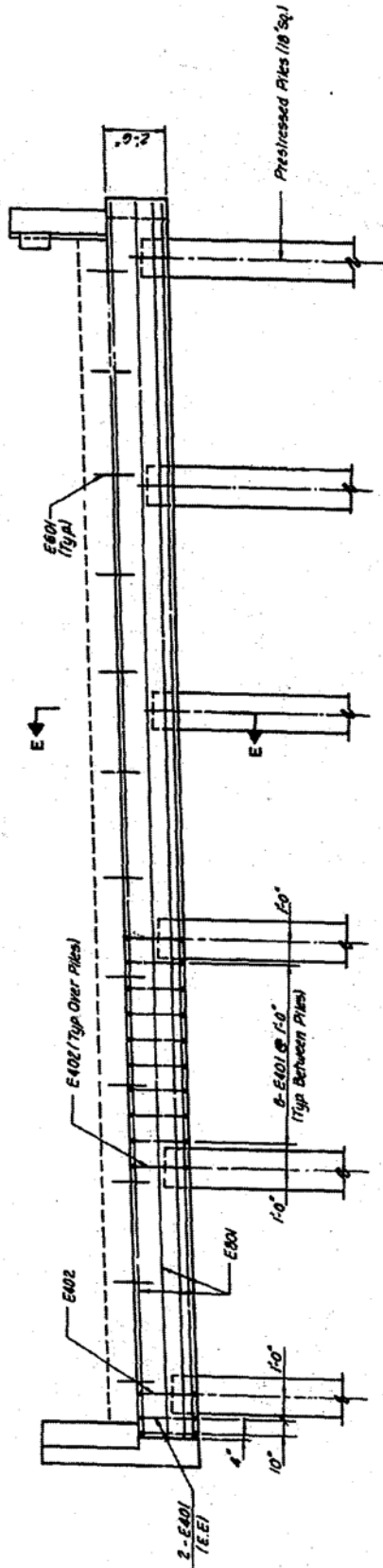

Figure 1.74 Typical interior section

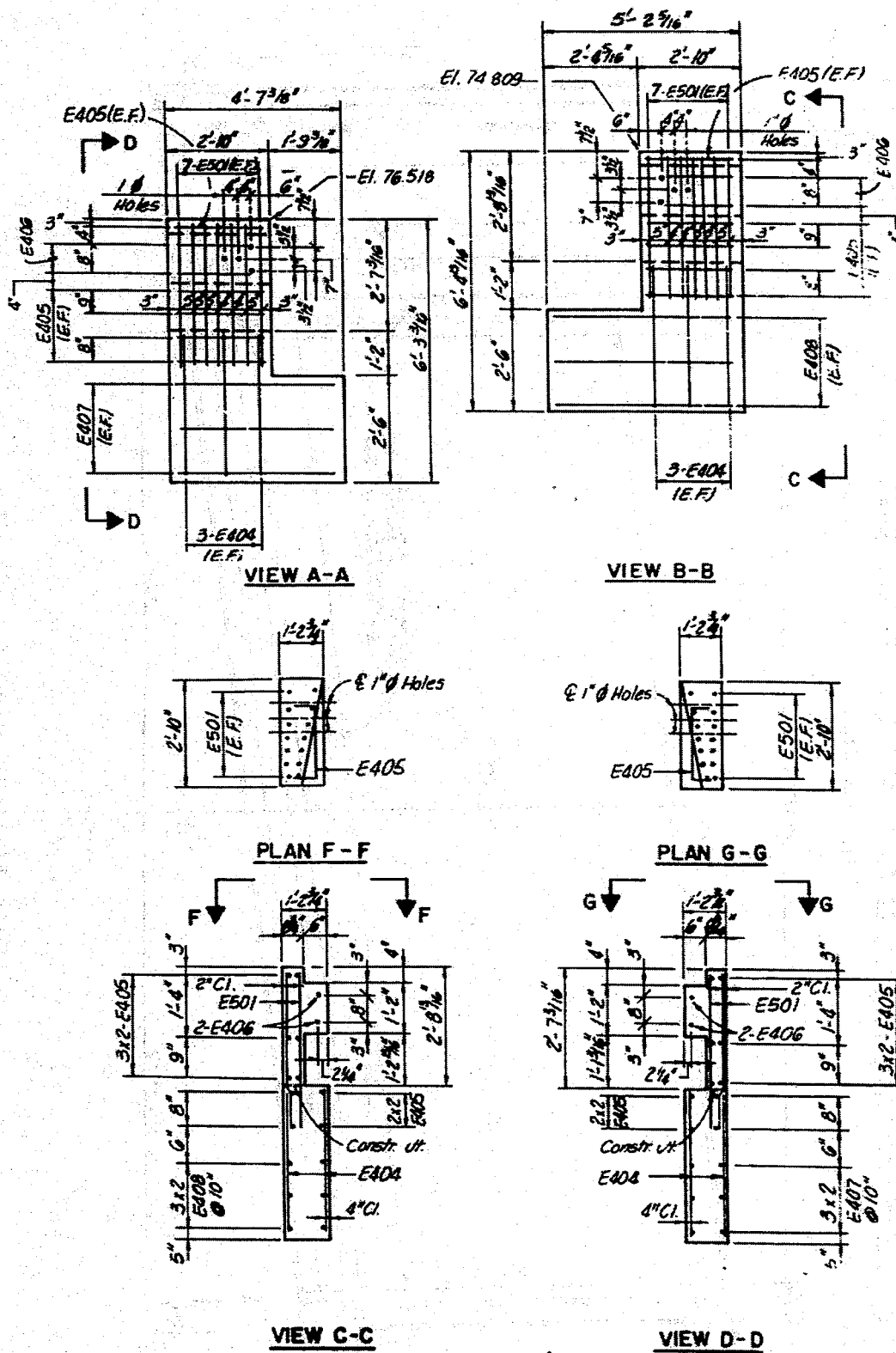

Figure 1.75 Reinforcement details

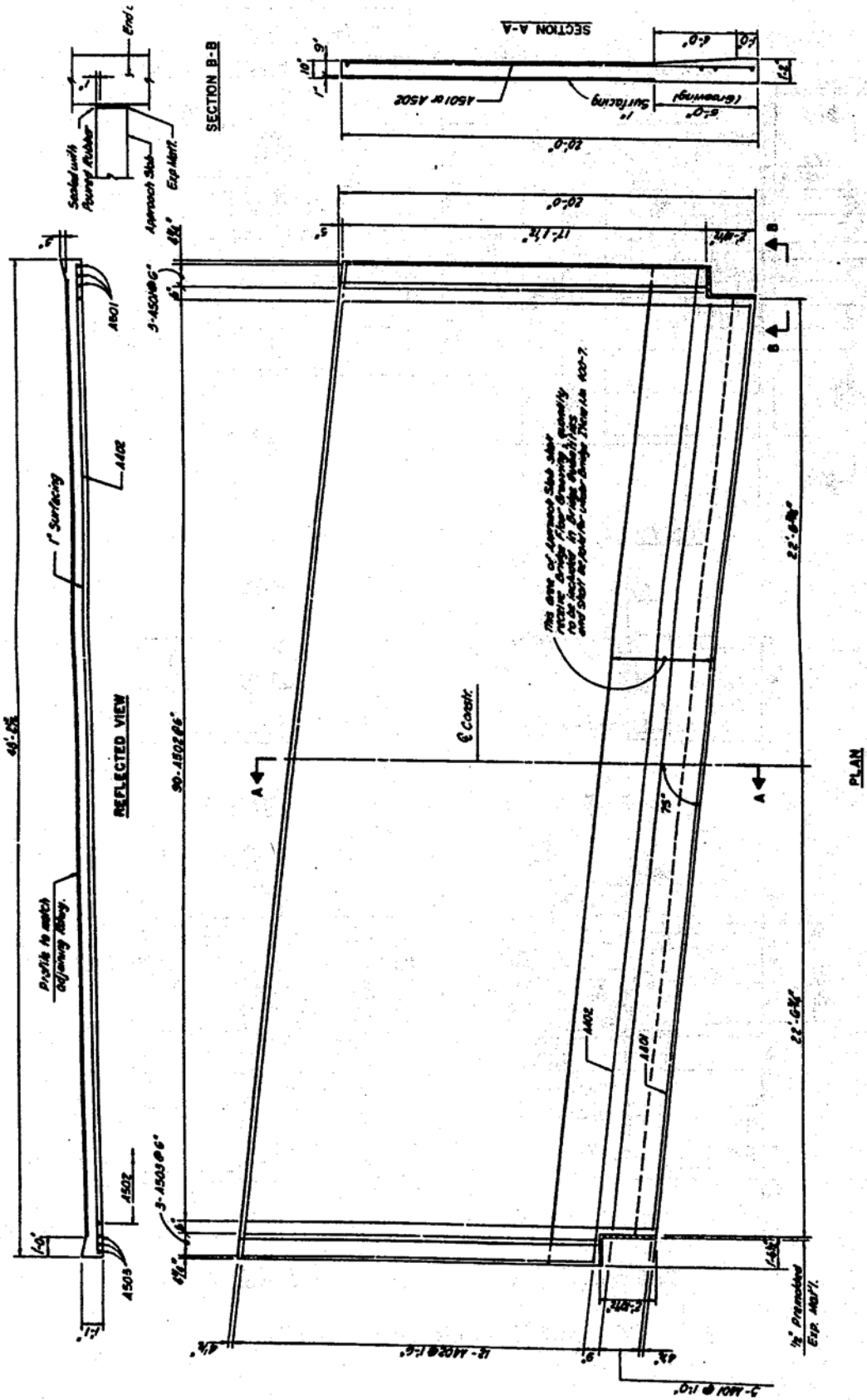

Figure 1.76 Approach slab

Section II: Analysis of Laterally Loaded Piles for Integral Abutment Bridges

2.1 Introduction

Piles in an integral abutment bridge are subjected to horizontal movement resulting from temperature and shrinkage, effects. Several methods based on linear elastic behavior, ultimate load and nonlinear p-y curve have been used to analyze laterally loaded piles.

The linear elastic procedure utilizes the subgrade modulus and the elastic continuum concept. Design procedures based on these linear concepts have been developed which are relatively easy to use. A major problem with using these procedures is the determination of an appropriate soil modulus (E_s), which varies with pile and soil properties, depth below the ground surface and the pile deflection.

Limit analysis procedures may be used to estimate the ultimate lateral pile capacity for a given set of soil and pile properties, but the deflections of piles at working loads cannot be calculated using these procedures.

The nonlinear p-y curve procedure provides the best fit between the calculated displacement of laterally loaded piles and the values measured in full scale tests. Criteria are available to describe the soil behavior in terms of the soil strength parameters Φ and c .

2.2 Soil Characterization⁽ⁱⁱ⁾

The Winkler soil model is used for the analysis of the soil pile interaction. The model assumes that the soil can be represented as a series of vertical and lateral springs along the length of the pile as shown in Fig. 2.1. Also, the model assumes that there is no interaction between the different soil springs as the pile is displaced.

The characteristics of each of the three types of springs can be described by soil resistance and displacement curves:

i) p - y curves, which describe the relationship between the lateral soil pressure (horizontal force per unit length of pile) and the corresponding lateral pile displacement

ii) f - z curves, which describe the relationship between skin friction (vertical force per unit length of pile) and the relative vertical displacement between the pile and the soil

3) q - z curves, which describe the relationship between the bearing stress (vertical force on effective pile tip area) at the pile tip and the pile tip settlement.

All three types of curves assume the soil behavior to be nonlinear. Again, the Winkler model assumes that these springs are uncoupled, which implies that motion at one spring does not affect another.

The modified Ramberg-Osgood model is used to approximate the p - y , f - z , and q - z soil resistance and displacement curves for use in the finite element solution:

$$p = \frac{k_h y}{\left[1 + \left| \frac{y}{y_u} \right|^n \right]^{\frac{1}{n}}} \quad (2.1)$$

$$y_u = \frac{P_u}{k_h} \quad (2.2)$$

Where

K_h = initial stiffness

p = generalized soil resistance

p_u = ultimate soil resistance

n = shape parameter

y = generalized displacement

Nonlinear behavior models for symmetrical or periodic loadings have been presented by a number of researchers. Fig. 2.1 and Eq. 2.1 show the modified Ramberg-Osgood curve for atypical p - y curve. Similar equations for a typical f - z curve (with f_{\max} , the maximum shear stress developed between the pile and soil, and k_v , the initial vertical stiffness) or a typical q - z curve (with q_{\max} , the maximum bearing stress at the pile tip, and

k_q , the initial point stiffness) can also be used. Fig. 2.3 shows the effect of the shape parameter, n , on the soil resistance and displacement behavior.

For the design method developed in the present study, a simplified elastic, perfectly plastic behavior will be assumed. This behavior for a typical p - y curve is shown in Fig. 2.2. The only soil spring properties needed for the design method are the ultimate resistance and the initial stiffness.

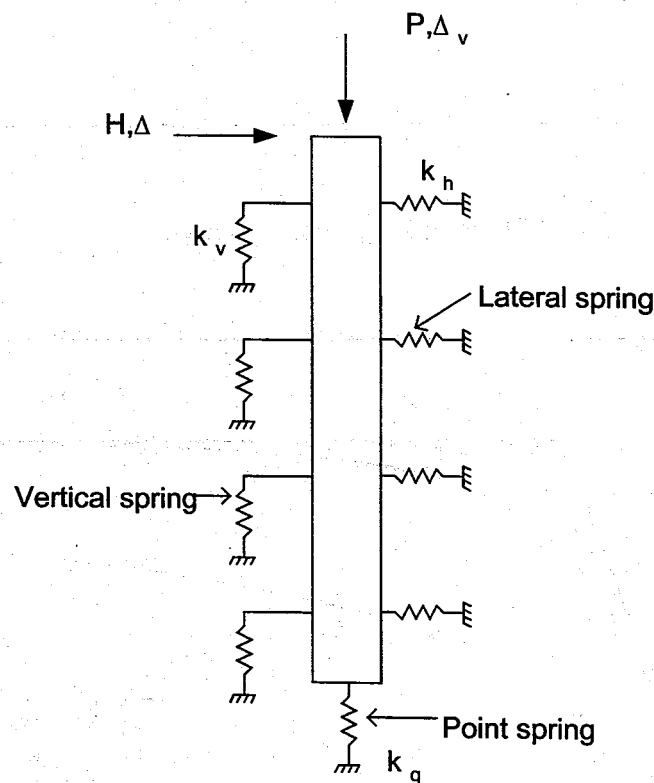

Figure 2.1 Design model of soil-pile system

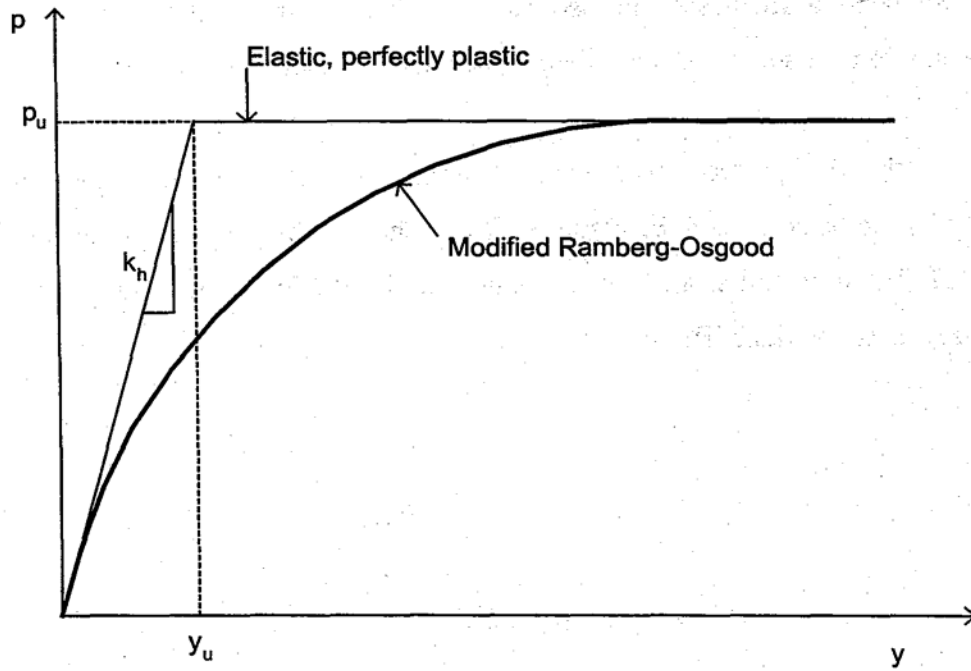

Figure 2.2 Typical p-y curve

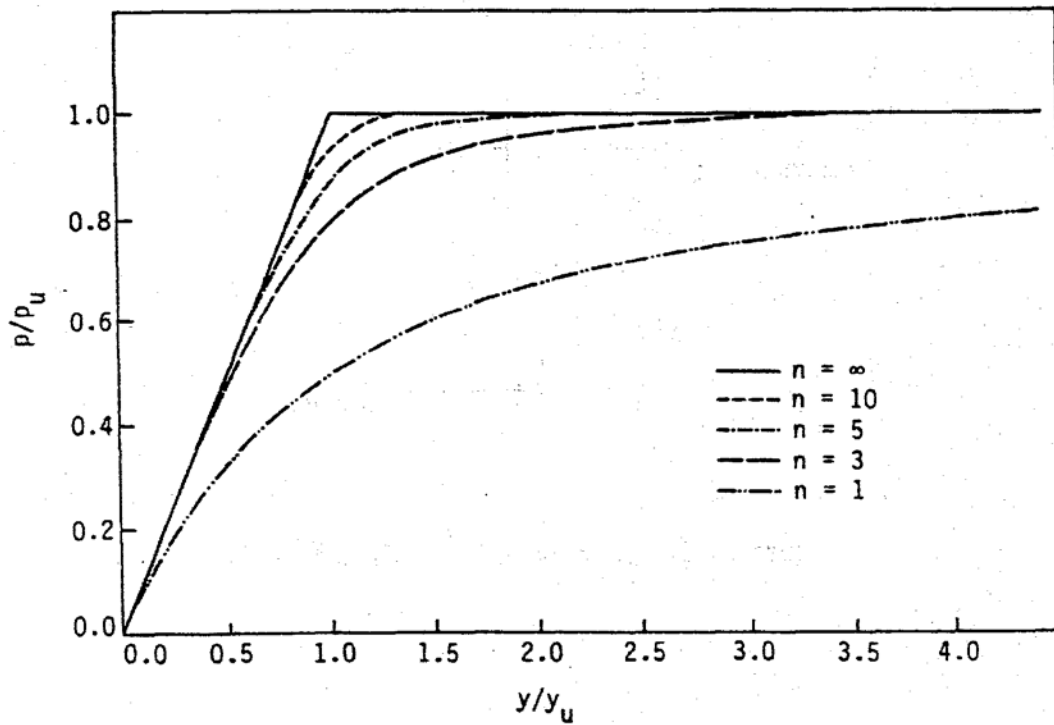

Figure 2.3 Nondimensional form of the modified Ramberg-Osgood equation.

For practical purposes, k_h is often assumed to be constant or to vary linearly with depth. For the parameters presented in Table 2.1, the subgrade-reaction moduli for clay soils are assumed to be constant within a soil layer and to vary linearly for granular soils.

Table 2.1 Parameter for p-y curve

Case	n	P_u (use lesser value)	k_h
Soft clay	1.0	$P_u = 9c_u B$	$\frac{P_u}{y_{50}}$
		$P_u = \left(3 + \frac{\gamma}{c_u} x + \frac{0.5}{B} x \right) c_u B$	y_{50}
Stiff clay	1.0	$P_u = 9c_u B$	$\frac{P_u}{y_{50}}$
		$P_u = \left(3 + \frac{\gamma}{c_u} x + \frac{0.5}{B} x \right) c_u B$	y_{50}
Very stiff clay	2.0	$P_u = 9c_u B$	$\frac{P_u}{2y_{50}}$
		$P_u = \left(3 + \frac{\gamma}{c_u} x + \frac{2.0}{B} x \right) c_u B$	$2y_{50}$
Sand	3.0	$P_u = \gamma x [B(k_p - k_a) + x k_p \tan \alpha \tan \beta + x k_o \tan \beta (\tan \phi - \tan \alpha)]$	$\frac{J \gamma x}{1.35}$
		$P_u = \gamma x [k_p^3 + 2k_p^2 k_o \tan \phi - k_a] B$	

Note:

ε_{50} = Axial strain at one-half peak stress difference from laboratory triaxial test, or use , 0.02 for soft clay, 0.01 for stiff clay, 0.005 for very stiff clay

c_u = undrained cohesion indicated for an unconsolidated, undrained laboratory test

B = pile width

γ = effective unit soil weight

x = depth from unit soil weight

ϕ = angle of internal friction

$$k_p = \tan^2 \left(45^\circ + \frac{\phi}{2} \right)$$

$$k_a = \tan^2 \left(45^\circ - \frac{\phi}{2} \right)$$

$$k_o = 1 - \sin\Phi$$

$$\alpha = \frac{\phi}{2} \text{ for dense or medium sand, } \frac{\phi}{3} \text{ for loose sand}$$

$$\beta = 45^\circ + \frac{\phi}{2}$$

$J = 200$ for loose sand, 600 for medium sand, 1500 for dense sand

y_{50} = displacement at one-half ultimate soil reaction: $2.5 B\varepsilon_{50}$ for soft and stiff clay, $2.0 B\varepsilon_{50}$ for very stiff clay

2.3 Equivalent Cantilever Idealization⁽¹¹⁾

Embedded piles can be represented, using the equivalent cantilever method, as a column with a base fixed at some distance below the ground surface (Fig. 2.4). The notation is the same for both the fixed and pinned-head conditions. The length of the actual pile embedded in the ground is represented as l , and the length above the ground is l_u . The equivalent embedded length, l_e , is the depth from the soil surface to the fixed base of the equivalent cantilever. The total length of the equivalent cantilever L equals the length l_u , plus l_e .

For a long pile embedded in soil, the horizontal displacements at the pile head have negligible effects below a certain depth. A critical length, l_c , which represents this depth, can be calculated. Beyond this length, lateral displacements and bending moments are a small percentage (about 4%) of those at the pile head. If a pile is longer than l_e , the pile behaves as if it is infinitely long. For a soil with a uniform subgrade-reaction modulus, the critical length is selected as

$$L_c = 4R \tag{2.3}$$

where R = the relative stiffness factor

$$= \sqrt[4]{\frac{EI}{k_h}} \tag{2.4}$$

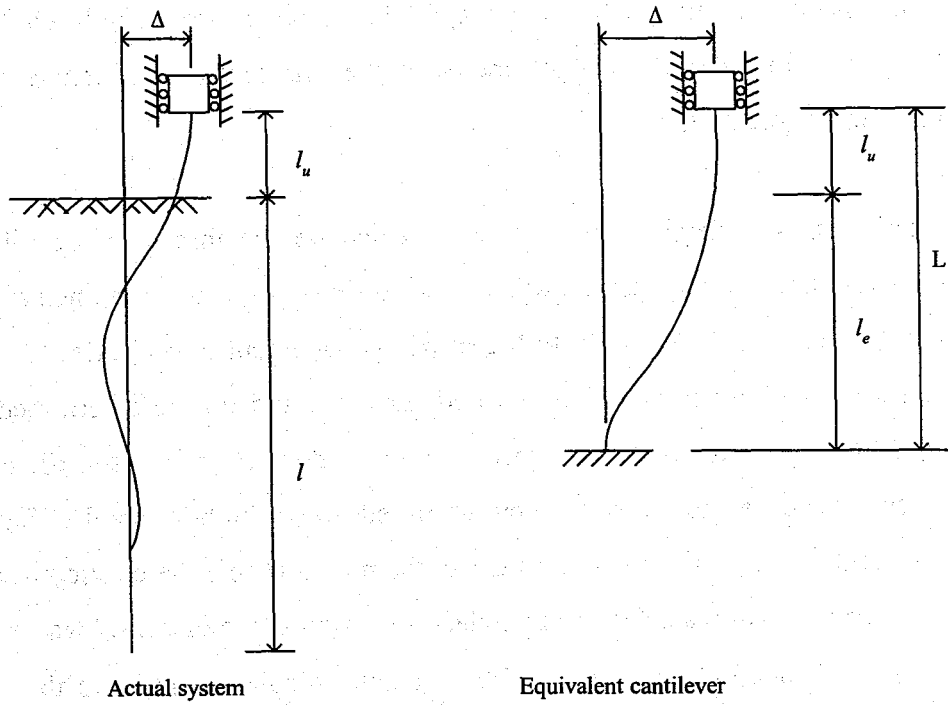

(a)

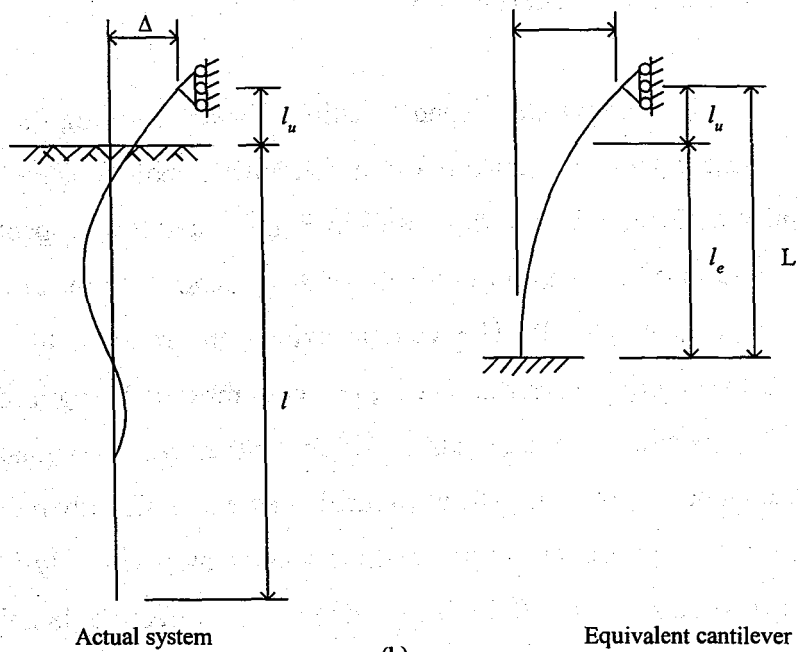

(b)

Figure 2.4 Cantilever idealization of the pile: (a) fixed-head condition (b) pinned-head condition

Most piles used in practice are longer than their critical length and behave as "flexible" piles. Note that l_c is a parameter of the pile and -soil system and is not a physically identifiable length.

Equivalent cantilevers can be used to calculate the forces in the pile and the bridge substructure. For example, an equivalent cantilever can be determined such that its maximum moment would be equal to the maximum moment in real pile. However, the complete moment diagram below the ground surface could not be determined with the same equivalent cantilever. Three different equivalencies were considered in the development of the design method. They are based on (i) the horizontal stiffness of the soil-pile system, (ii) the maximum moment in the pile, and (iii) the elastic buckling load of the pile. For each equivalency, the boundary condition at the pile head was either fixed (no rotation) or pinned (no moment). The horizontal displacement, Δ at the top of the equivalent system corresponds to the longitudinal expansion or contraction of the bridge superstructure at the integral abutment (Fig. 2.4).

Greimann et al (1987) have developed equations for determining the equivalent embedded length. These equations are plotted in a nondimensional form for fixed-head and pinned-head piles embedded in a uniform soil in Fig. 2.5 and 2.6, respectively. The horizontal axis is the ratio of the length of pile above the ground, l_u to the critical length of the soil-pile system, l_c , Eq. (2.3). The vertical axis is the ratio of the equivalent embedded length, l_e to the critical length. The equivalent embedded length, determined from Figs. 2.5 and 2.6 are added to the length of pile above the surface to obtain the total length of the equivalent cantilever. An unfilled predrilled hole significantly reduces (Figs. 2.5 and 2.6) the equivalent embedded length until the hole is approximately l_c deep, that is, l_u/l_c equals approximately one. Below that depth, the effective length remains essentially constant over the range used for most integral abutment bridges.

For piles embedded in a non-uniform soil, the equivalent soil stiffness developed in Section 2.4 is used together with Figs. 2.5 and 2.6 to determine the equivalent cantilevers.

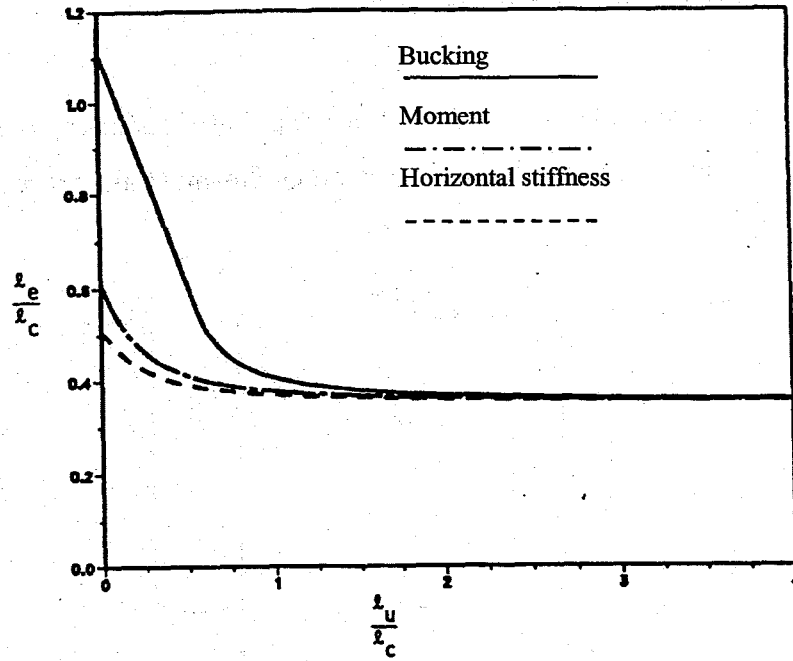

Figure 2.5 Equivalent cantilever for fixed-head piles embedded in uniform soil

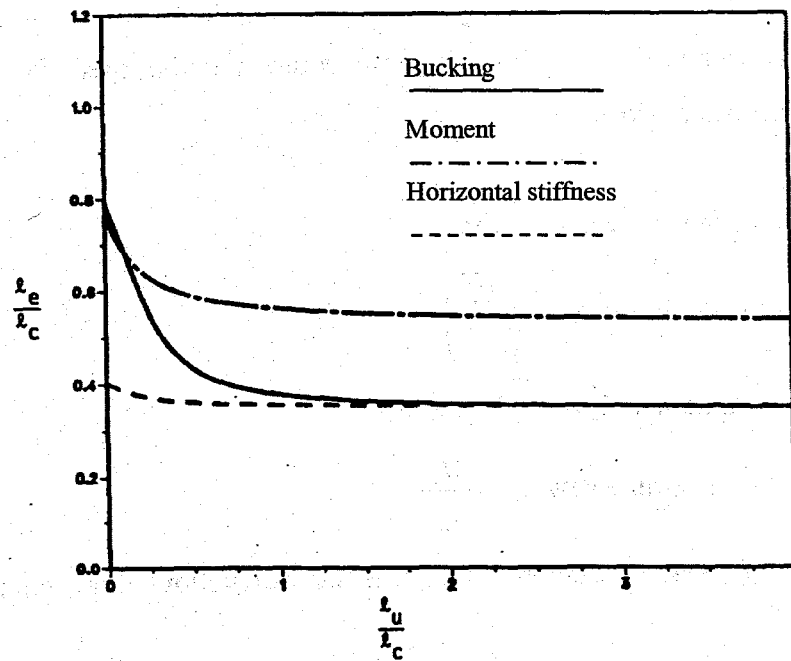

Figure 2.6 Equivalent cantilever for pinned-head piles embedded in uniform soil

2.4 Equivalent Uniform Soil Stiffness⁽¹¹⁾

For a pile embedded in a soil with a nonuniform stiffness, $k_h(x)$, an equivalent uniform soil stiffness, k_e , is determined based on Greimann et al's procedure

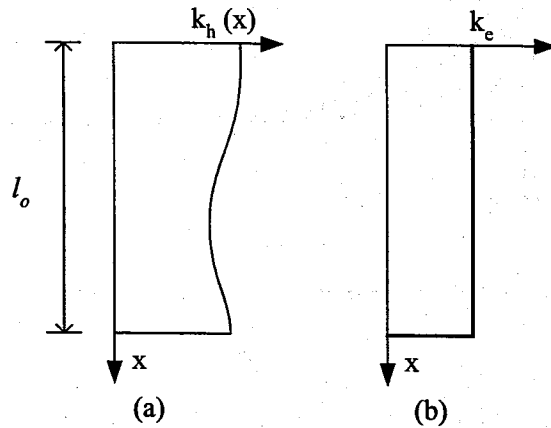

Figure 2.7 Piles in nonuniform soil: (a) actual variation of stiffness (b) equivalent uniform stiffness

It was suggested the following procedure may be used for determining the equivalent uniform stiffness:

Step i) Assume a value for the k_e

Step ii) Calculate $l_o = 2 \left(\sqrt[4]{\frac{EI}{k_e}} \right)$

Step iii) Calculate I_k using Fig. 2.8.

Step iv) Determine new $k_e = \frac{3I_k}{l_o^3}$

Step v) Repeat calculation of k_e , i.e. repeat calculations from step (ii).

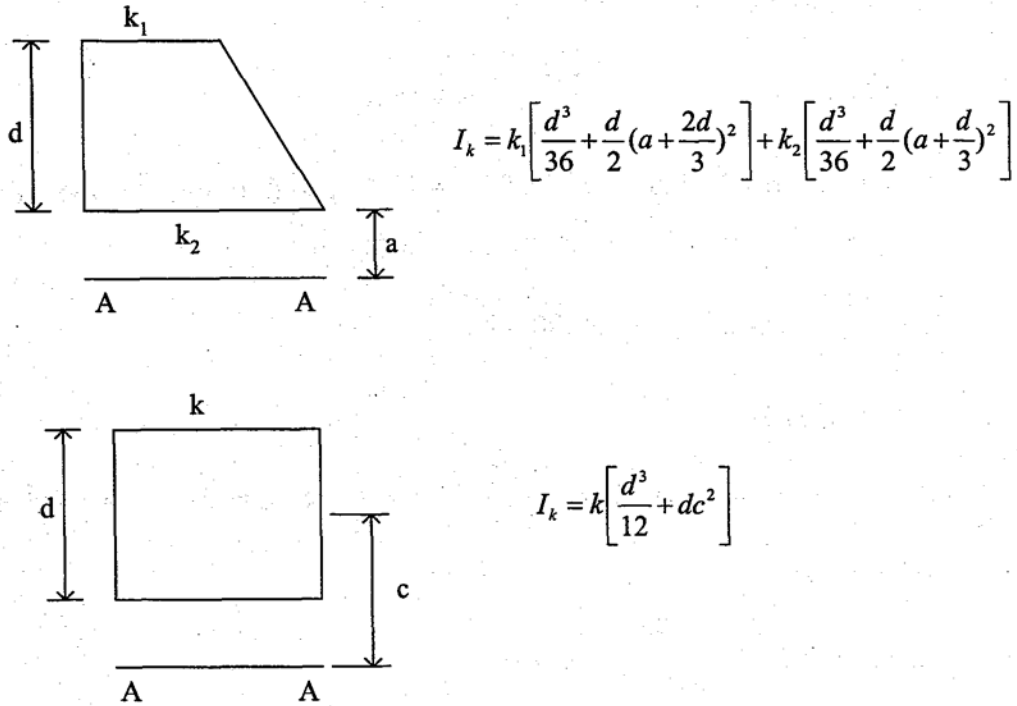

Figure 2.8 Second moment about reference line A – A

Example for computing k_e in a layered soil (Fig. 2.9):

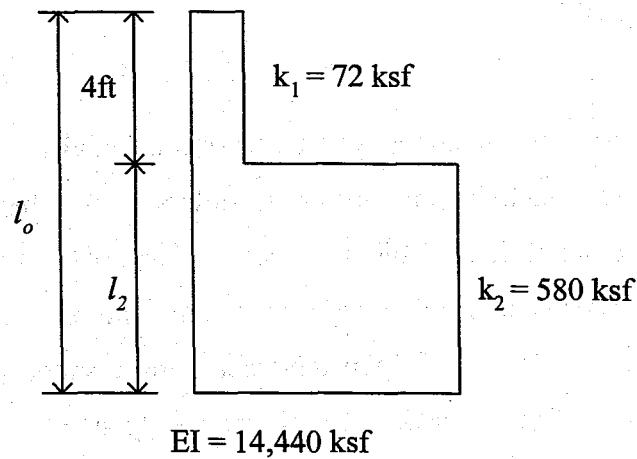

Figure 2.9 Layer soil system for determining k_e

Step i) Assume $k_e = 100$ ksf

$$\text{Step ii) Calculate } l_0 = 2 \left(\sqrt[4]{\frac{14440}{100}} \right) = 6.93 \text{ ft.}$$

Step iii) Corresponding to $l_2 = 6.93 - 4 = 2.93$ ft, so from Fig. 2.8, the second moment k_h (x) distribution about l_0 can be found as

$$I_k = 72 \left[\frac{4^3}{12} + 4(2.93 + 2)^2 \right] + 580 \left(\frac{2.93^3}{3} \right)$$
$$= 12,247 \text{ k-ft}$$

$$\text{Step iv) Determine new } k_e = \frac{3(12,247)}{6.93^3} = 110 \text{ ksf} > \text{assumed } k_e = 100 \text{ ksf}$$

Iteration II

$$\text{Step ii) } l_0 = 2 \left(\sqrt[4]{\frac{14,440}{110}} \right) = 6.77 \text{ ft}$$

$$\text{Step iii) } l_2 = 2.79 \text{ ft}$$

$$I_k = 11,492 \text{ k-ft}$$

$$\text{Step iv) } k_e = 111 \text{ ksf} \cong 110 \text{ ksf}$$

Step v) The solution converges, hence $k_e = 111$ ksf

2.5 Beam-Columns⁽²⁴⁾

While many structural members can be treated as axially loaded columns or as beams with only flexural loading, most beams and columns are subjected to some degree of both bending and axial load. This is especially true of statically indeterminate structures. Even the roller support of a simple beam can experience friction that restrains the beam longitudinally, inducing axial tension when transverse loads are applied. In this particular case, however, the secondary effects are usually small and can be neglected. Many columns can be treated as pure compression members with negligible error. If the column is a one-story member and can be treated as pinned at both ends, the only bending in the column will result from minor accidental eccentricity of the load. For many structural members, however, there will be a significant amount of both axial load

and bending, and such members are called beam-columns (Fig. 2.10). Piles in integral abutment are also subjected to some degree of both bending and axial loads and hence must be treated as beam-columns.

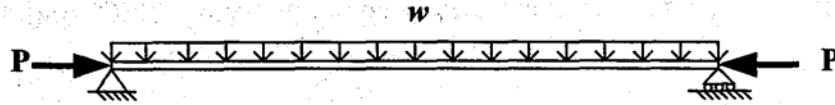

Figure 2.10 Beam-column with uniformly distributed lateral load

Steel piles are commonly used in integral abutment. The AISC requires that interaction equations need to be satisfied for members subject to both bending and axial compressive load. Eqs. 2.5 and 2.6 are recommended for small axial load and large axial load respectively. If the axial load is small, the axial load term is reduced. For large axial load, the bending term is slightly reduced. The AISC formulae are summarized as follows:

For $\frac{P_u}{\phi P_n} \geq 0.2$

$$\frac{P_u}{\phi P_n} + \frac{8}{9} \left[\frac{M_{ux}}{\phi M_{nx}} + \frac{M_{uy}}{\phi_b M_{ny}} \right] \leq 1.0 \quad (2.5)$$

For $\frac{P_u}{\phi P_n} < 0.2$

$$\frac{P_u}{2\phi P_n} + \left[\frac{M_{ux}}{\phi_b M_{nx}} + \frac{M_{uy}}{\phi_b M_{ny}} \right] \leq 1.0 \quad (2.6)$$

where P_u = factored axial compressive strength, kip

ϕP_n = design compressive strength, kips

Φ = resistance factor for compression, $\Phi_c = 0.85$

P_n = nominal compressive strength, kips

M_u = required flexural for compression: strength including second-order effects, kip-in or kip-ft

Φ_b = resistance factor for flexure = 0.90

$\Phi_b M_n$ = design flexural for compression

The design compressive strength $\Phi_b P_n$ is computed using AISC formula given by Eqs 2.7-2.10.

$$P_n = A_g F_{cr} \quad (2.7)$$

$$\text{If } \lambda \leq 1.5, \text{ then } F_{cr} = (0.66^\lambda) F_y \quad (2.8)$$

$$\text{If } \lambda > 1.5, \text{ then } F_{cr} = \frac{0.88 F_y}{\lambda} \quad (2.9)$$

Where

$$\lambda = \left[\frac{KL}{r\pi} \right]^2 \frac{F_y}{E} \quad (2.10)$$

A_g = gross area of member, in²

F_y = specified yield stress, ksi

E = modulus of elasticity, ksi

K = effective length factor

l = laterally unbarred length of member, in.

r = governing radius of gyration about the axis of buckling, in.

2.6 Pile Design⁽¹¹⁾

The piles for an integral abutment bridge are subjected to horizontal movements caused by the expansion or contraction of the bridge superstructure. To design the abutment piles properly, a rational design approach is developed to simplify the complex behavior associated with pile and soil interaction. Fundamental principles for two design alternatives that were formulated by Greimann et al (1987). Alternative I was based on elastic behavior and recommended for piles with limited ductility, such as timber, concrete, and steel sections having insufficient moment-rotation capacity. Alternative II was based on inelastic behavior involving plastic redistribution of internal forces caused

by the lateral displacement of the pile head and recommended for piles with adequate moment-rotation capacity at plastic hinge locations. Steel piles do not have to be classified as compact sections, to meet the moment-rotation requirement. A ductility criterion, expressed in terms of lateral pile head displacement, is given to evaluate whether the moment-rotation capacity, of an HP-shaped pile exceeds the moment rotation demand.

Alternative I

Alternative I accounts for the first-order stresses induced in the pile caused by thermal expansion or contraction of the superstructure. The pile is considered as an equivalent cantilever with a horizontal pile-head displacement (Δ). This displacement produces first-order elastic moments that do not take into account any plastic redistribution of internal forces. For a fixed-head pile the maximum moment is

$$M = \frac{6EI\Delta}{L^2} \quad (2.11)$$

and for a pinned-head pile is

$$M = \frac{3EI}{L^2} \quad (2.12)$$

Ductility of the pile material is not taken into account; therefore, failure is assumed to occur when the internal forces reach their yield values. Hence, unlike the plastic collapse theory where support movements do not affect member strength, Alternative I can be expected to show a drastic reduction in the pile capacity caused by the horizontal displacement, Δ .

Alternative II

Alternative II assumes that the stresses in the pile due to the longitudinal displacement of the superstructure have no significant effect on the pile capacity; however, this alternative accounts for the secondary PD effect.

Support movement and thermal stresses do not affect either the plastic collapse load or the elastic buckling load. However, the system must have sufficient ductility to develop a mechanism with the associated plastic hinge rotations. For example, steel sections must be sufficiently compact and braced to prevent both local and lateral buckling as the plastic hinge undergoes inelastic rotation.

For an equivalent cantilever with a horizontal head displacement, Δ (Fig. 2.11) the combined effects of moment, M and shear, H balance the overturning moment, $P\Delta$. For the fixed-head pile,

$$P\Delta = HL + 2M \quad (2.13)$$

and for the pinned-head pile,

$$P\Delta = HL + M \quad (2.14)$$

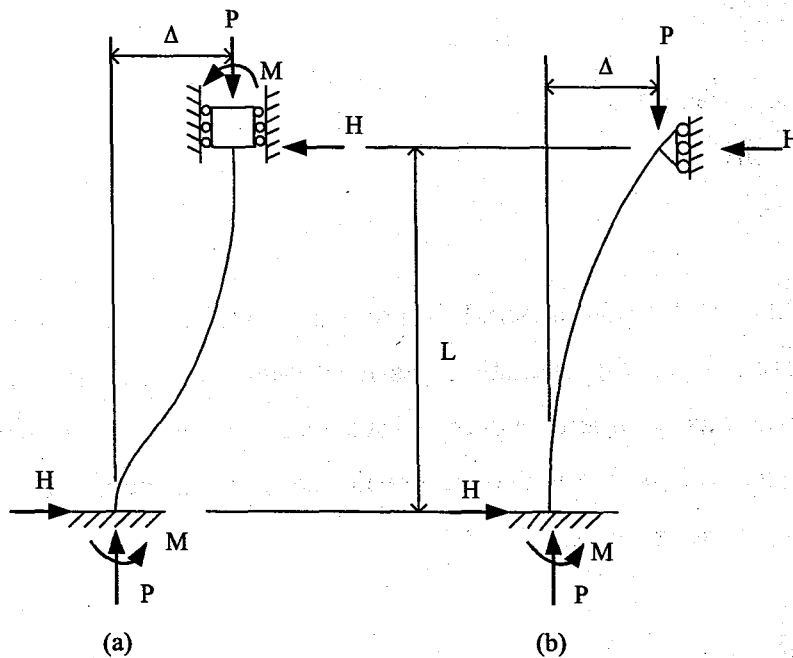

Figure 2.11 Equivalent cantilever: (a) fixed-head condition (b) pinned-head condition

For the present case, one useful and conservative bound will be to assume that the $P\Delta$ effects are resisted entirely by the moment, that is,

$$M = \frac{P\Delta}{2} \quad (2.15)$$

and

$$M = P\Delta \quad (2.16)$$

for the, fixed-head pile and pinned-head pile respectively.

The moments associated with alternative I (Eqs. 2.11 and 2.12) are not considered in the Eqs. 2.13 through 2.16. This amounts to the assumption that the pile is in a stress free state after, the thermal movement of the superstructure.

2.7 Computer Programs for Laterally Loaded Pile Analyses

2.7.1 Program COM624P⁽²⁷⁾

The program COM624, was developed at the University of Texas at Austin under the sponsorship of FHWA. This program has been used on main frame computers for several years. The first version of Program COM624P (Version 1.0) has been used and distributed by FHWA since 1990. Because of a number of inquiries by design engineers about the ultimate capacity of a pile in bending, a subroutine has been added to the version 1.0. COMP624P version 2.0 computes the ultimate capacity in bending and the variation of flexural rigidity with applied moment.

Computer program COM624P version 2.0 is used to analyze the behavior of piles or drilled shafts which are subjected to lateral loads. The p - y method of analysis is implemented in COM624P version 2.0. The deflected shape (lateral deflection) of pile is computed accurately by iteration even though the soil reaction against the pile is a nonlinear function of pile deflection. After the deflection is determined, the shear, bending moment, and soil resistance along the pile can be computed thereafter. With the availability of microcomputers, this program makes it possible for highway engineers to employ the rational p - y method for analysis of laterally loaded piles and drilled shafts. This program is available to download from FHWA website at <http://www.fliwa.dot.gov/bridge/geosoft.htm>.

Basic Theory

i) The Differential Equation

The standard differential equation for the deflection of a beam provides the basis for the analysis of most of the cases of piles under lateral loading. The only adjustment needed to the basic equation is to replace the distributed load, p with the soil modulus, E_s times the pile deflection y (with a negative sign).

However, if the axial load is relatively large or if an unsupported portion of the pile extends above the groundline, the inclusion of the effect of the axial load in the differential equation is necessary. The beam-column equation derived can be used to investigate buckling and will allow the additional lateral deflection due to axial loading, to be computed, for cases where the axial load is applied at the groundline.

The derivation of the beam-column (Fig. 2.12) was done by Hetenyi (1946). The equilibrium of moments (ignoring second-order terms) leads to the equation:

$$(M+dM)-M+P_x dy-V_v dx=0 \quad (2.17)$$

or

$$\frac{dM}{dx} + P_x \frac{dy}{dx} - V_v = 0 \quad (2.18)$$

Differentiating Eq. 2.18 with respect to x , the following equation is obtained:

$$\frac{d^2 M}{dx^2} + P_x \frac{d^2 y}{dx^2} - \frac{dV_v}{dx} = 0 \quad (2.19)$$

Using the following identities

$$\frac{d^2 M}{dx^2} = EI \frac{d^4 y}{dx^4} \quad (2.20)$$

$$\frac{dV_v}{dx} = P \quad (2.21)$$

$$P = -E_s y \quad (2.22)$$

And substituting, Eq. 2.19 becomes:

$$EI \frac{d^4 y}{dx^4} + P_x \frac{d^2 y}{dx^2} + E_s y = 0 \quad (2.23)$$

The direction of the shearing; force, V_v is shown in Fig. 2.12. The shearing force in the plane normal to the deflection line can be obtained as:

$$V_n = V_v \cos S - P_x \sin S \quad (2.24)$$

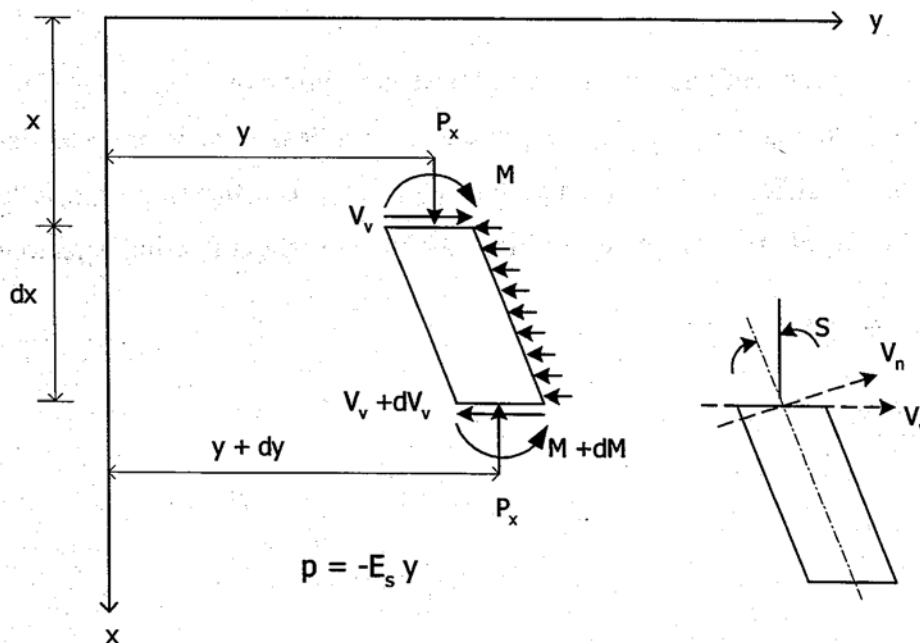

Figure 2.12 Element for beam-column (after Hetenyi, 1946)

Because S is usually small, $\cos S = 1$ and $\sin S = \tan S = dy/dx$. Thus, Eq. 2.24 is rewritten as:

$$V_n = V_v - P_x \frac{dy}{dx} \quad (2.25)$$

V_n will mostly be used in the computations, but V_v can be computed from Eq. 2.25 where dy/dx is equal to the rotation, S .

The following assumptions are made in deriving the differential equation:

- the pile has a longitudinal plane of symmetry; loads and reactions lie in that plane,
- the modulus of elasticity of the pile material is the same for tension and compression,
- transverse deflections of the pile are small,
- the pile is not subjected to dynamic loading, and
- deflections due to shearing stresses are negligible.

The sign conventions that are employed are shown in Fig. 2.13. For ease of understanding, the sign conventions are presented for a beam that is oriented like a pile. A solution of the differential equation yields values of y as a function of x . A family of curves can then be obtained as shown in Fig 2.14 by using the following equations:

$$EI \frac{d^3 y}{dx^3} = V \quad (2.26)$$

$$EI \frac{d^2 y}{dx^2} = M \quad (2.27)$$

$$\frac{dy}{dx} = S \quad (2.28)$$

where

V = shear,

M = bending moment of the pile,

S = slope of the elastic curve.

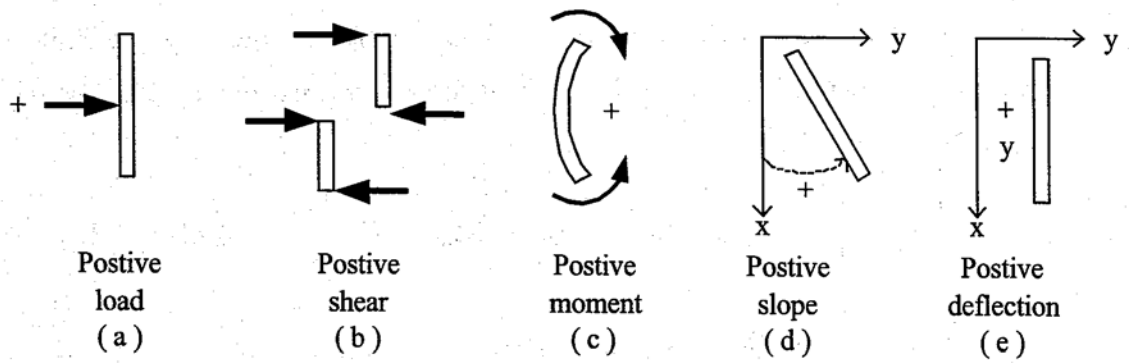
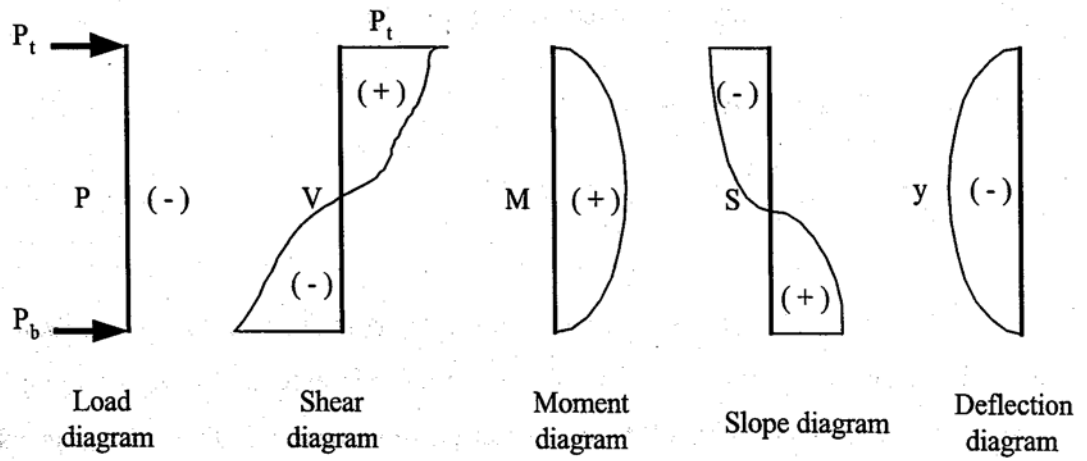

Figure 2.13 Sign conventions

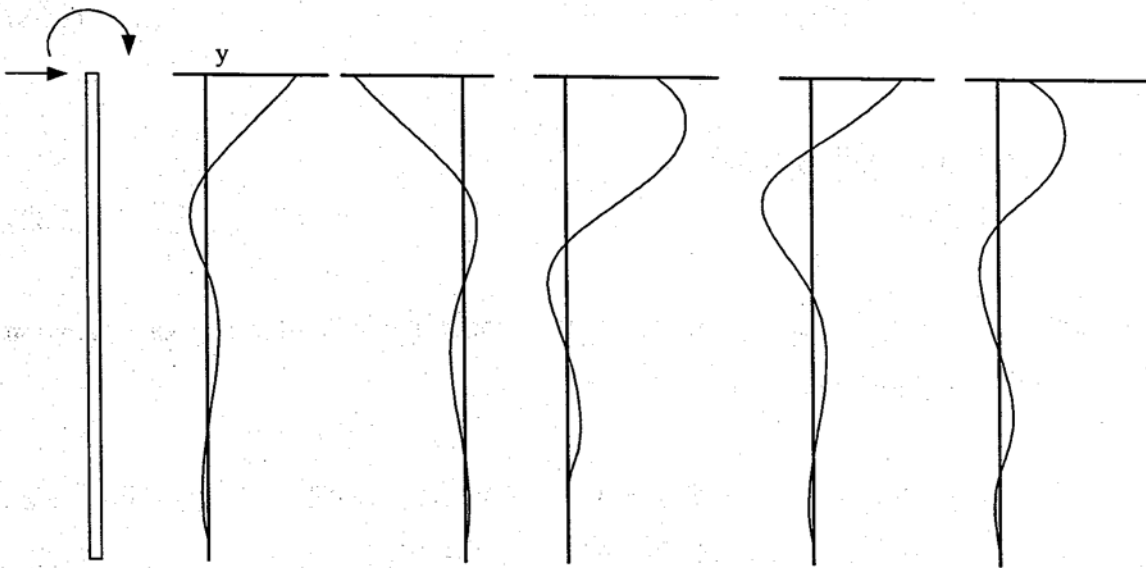

Figure 2.14 Form of the results obtained from a complete solution

ii) Solution to the Governing Differential Equation

Eq. 2.23 is rewritten as Eq. 2.29.

$$\frac{d^2 M}{dx^2} + P_x \frac{d^2 y}{dx^2} + Ky - W = 0 \quad (2.29)$$

The term W, which is exactly similar to p, is added to allow a distributed load to be placed along the pile as, for example, when the pile extends above the groundline and is subjected to a distributed load from water currents or wind. The term, k is substituted for E_S for ease in writing the equations. Eq. 2.29 can be solved readily by using finite difference techniques. The deflection of the pile for solution by the finite difference method is shown in Fig. 2.15. The finite difference expressions for the first two terms of Eq. 2.29 at point m are:

$$\left(\frac{d^2 M}{dx^2} \right)_m = [y_{m-2} R_{m-1} + y_{m-1} (-2R_m - 2R_{m-1}) + y_m (4R_m + R_{m-1} + R_{m+1}) + y_{m+1} (-2R_m - 2R_{m+1}) + y_{m+2} R_{m+1}] \frac{1}{h^4} \quad (2.30)$$

$$P_x \left(\frac{d^2 y}{dx^2} \right)_m = \frac{P_x (y_{m-1} - 2y_m + y_{m+1})}{h^2} \quad (2.31)$$

where

$$\begin{aligned} R_m &= \text{flexural rigidity at point (m)} \\ &= E_m I_m \end{aligned} \quad (2.32)$$

Eqs. 2.30 and 2.31 are substituted in Eq. 2.29 to obtain the following resulting equation (Eq. 2.33) for point m along the pile.

$$y_{m-2} R_{m-1} + y_{m-1} (-2R_{m-1} - 2R_m + P_x h^2) + y_m (R_{m-1} + 4R_m + R_{m+1} - 2P_x h^2 + k_m h^4) + y_{m+1} (-2R_m - 2R_{m+1} + P_x h^2) + y_{m+2} R_{m+1} - W_m h^4 = 0 \quad (2.33)$$

The axial force P_x producing compression is assumed to be positive.

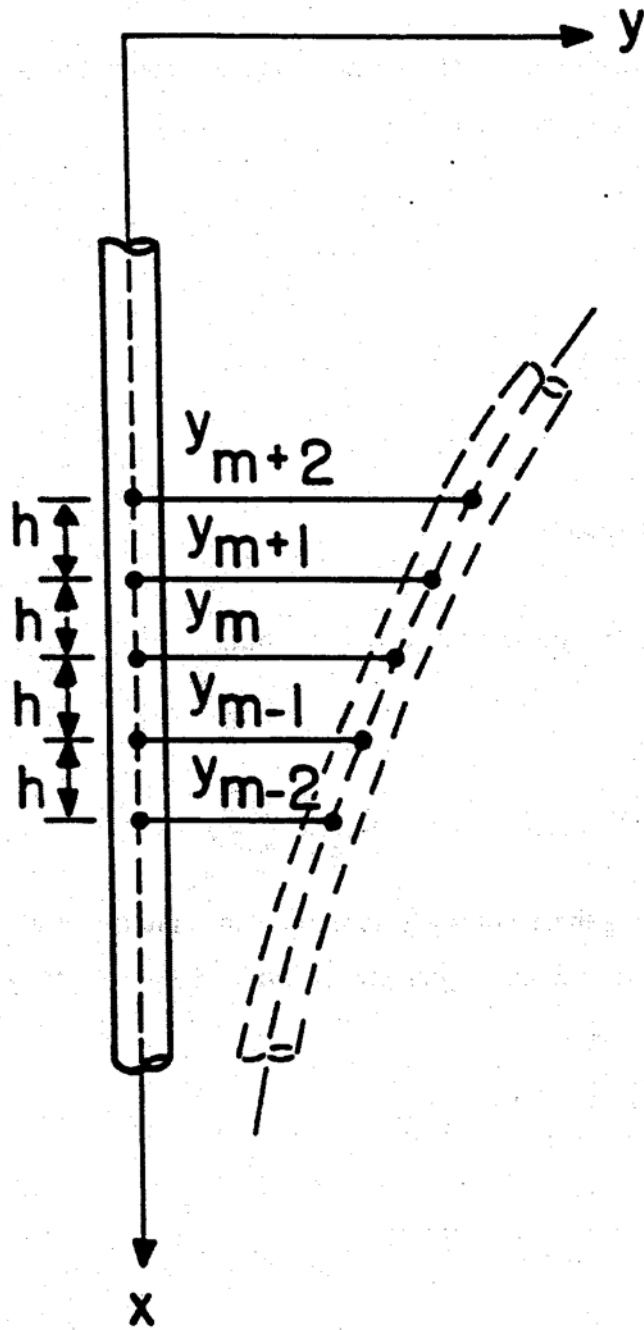

Figure 2.15 Representation of deflected pile

Applying the boundary conditions at the bottom of the pile, the solution to the differential equation in difference form is obtained (Gleser, 1953).

Using the notation shown in Fig. 2.16, the two boundary conditions at the bottom of the pile (point) are zero bending moment,

$$\left(\frac{d^2 y}{dx^2}\right)_0 = 0 \quad (2.34)$$

and zero shear,

$$R_0 \left(\frac{d^3 y}{dx^3}\right)_0 + P_x \left(\frac{dy}{dx}\right)_0 = 0 \quad (2.35)$$

For simplicity, it is assumed that:

$$R_1 = R_0 = R_1 \quad (2.36)$$

These boundary conditions are, in finite difference form,

$$y_{-1} - 2y_0 + y_1 = 0 \quad (2.37)$$

and

$$y_{-2} = y_{-1} \left\{ 2 - \frac{p_x h^2}{R_0} \right\} - y_1 \left\{ 2 - \frac{p_x h^2}{R_0} \right\} + y_2 \quad (2.38)$$

respectively. Substituting these boundary conditions in finite difference form in Eq. 2.33 where m is equal to zero, and rearranging terms, results in the following equations:

$$y_0 = a_0 y_1 - b_0 y_2 + d_0 \quad (2.39)$$

$$a_0 = \frac{2R_0 + 2R_1 - 2p_x h^2}{R_0 + R_1 + k_0 h^4 - 2p_x h^2} \quad (2.40)$$

$$b_0 = \frac{R_0 + R_1 - 2p_x h^2}{R_0 + R_1 + k_0 h^4 - 2p_x h^2} \quad (2.41)$$

$$d_0 = \frac{W_0 h^4}{R_0 + R_1 + k_0 h^4 - 2p_x h^2} \quad (2.42)$$

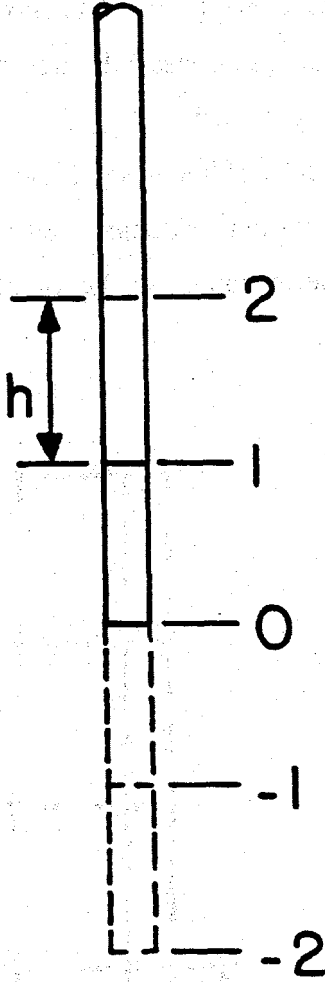

Figure 2.16 Point at bottom of pile

Eq. 2.33 can be expressed for all other values of m and the top of the pile by the following relationships:

$$y_m = a_m y_{m+1} - b_m y_{m+2} + d_m \quad (2.43)$$

$$a_m = \frac{-2b_{m-1}R_{m-1} + a_{m-2}b_{m-1}R_{m-1} + 2R_m - 2b_{m-1}R_m + 2R_{m+1} - p_x h^2(1 - b_{m-1})}{c_m} \quad (2.44)$$

$$b_m = \frac{R_{m+1}}{c_m} \quad (2.45)$$

$$d_m = \frac{W_m h^4 - d_{m-1}(a_{m-2}R_{m-1} - 2R_{m-1} - 2R_m + p_x h^2) - d_{m-2}R_{m-1}}{c_m} \quad (2.46)$$

$$c_m = R_{m-1} - 2a_{m-1}R_{m-1} - b_{m-2}R_{m-1} + a_{m-2}a_{m-1}R_{m-1} + 4R_m - 2a_{m-1}R_m + R_{m+1}k_m h^4 - P_x h^2(2 - a_{m-1}) \quad (2.47)$$

The top of the pile ($m = t$) is shown in Fig. 2.17. Four sets of boundary conditions are considered and these are designated as Cases a through d.

- a) The lateral load, P_t and the moment, M_t .
- b) The lateral load, P_t and the slope of the elastic curve, S_t .
- c) The lateral load, P_t and the rotational resistant constant, M_t/S_t :
- d) The moment (M) and the deflection (y_t) at the top of the pile are known.

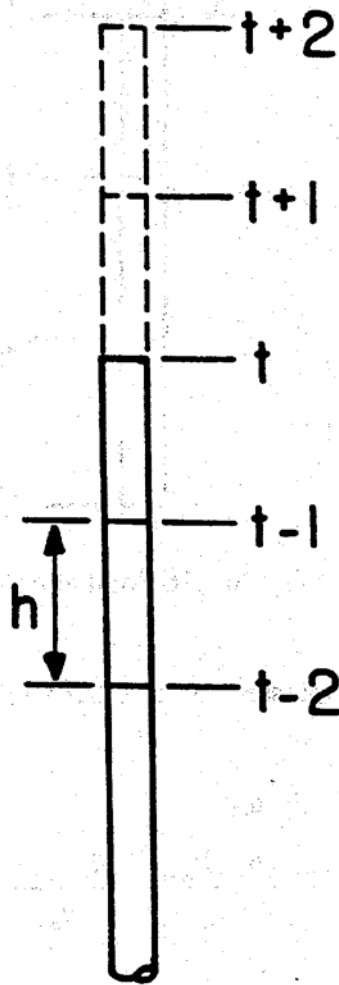

Figure 2.17 Points at top of pile

For convenience in establishing expressions for these boundary conditions at the top of pile, the following constants are defined:

$$J_1 = 2hS_t \quad (2.48)$$

$$J_2 = \frac{M_t h^2}{R_t} \quad (2.49)$$

$$J_3 = \frac{2P_t h^3}{R_t} \quad (2.50)$$

$$J_4 = \frac{hM_t}{2R_t S_t} \quad (2.51)$$

$$E = \frac{-P_x h^2}{R_t} \quad (2.52)$$

The boundary conditions for Case (a) are shown in Fig. 2.18. The difference equations for the top of the pile are shown in Eqs. 2.53 and 2.54.

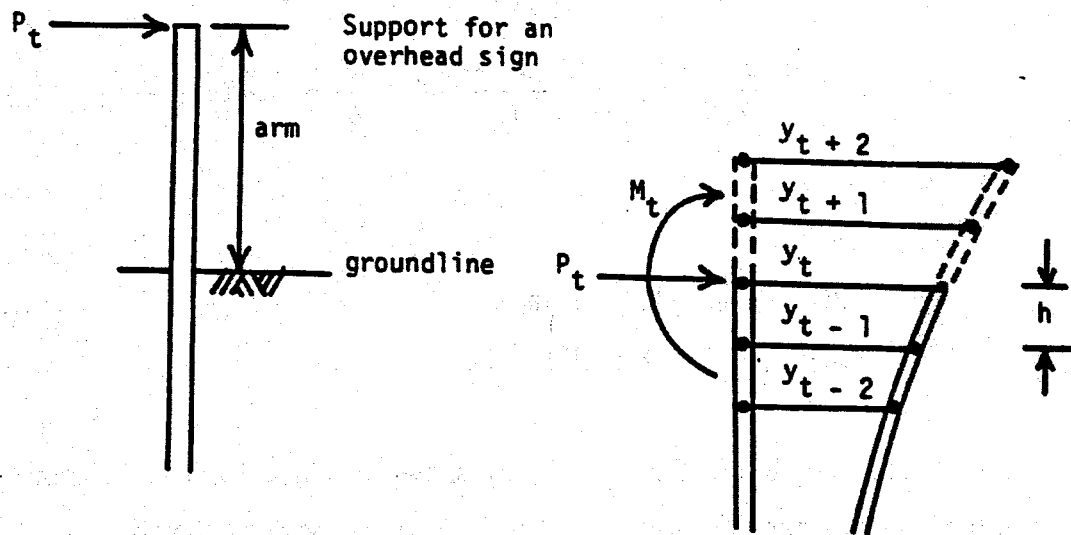

Note: P_t and M_t are known: they are shown in the positive sense

Figure 2.18 Case (a) of boundary conditions

$$\frac{R_t}{2h^3}(y_{t-2} - 2y_{t-1} + 2y_{t+1} - y_{t+2}) + \frac{P_x}{2h}(y_{t-1} - y_{t+1}) = P_t \quad (2.53)$$

$$\frac{R_t}{h_2}(y_{t-1} - 2y_t + y_{t+1}) = M_t \quad (2.54)$$

After substitutions the difference equations for the deflection at the top of the pile and at the two imaginary points above the top of the pile are:

$$y_t = \frac{Q_2}{Q_1} \quad (2.55)$$

$$y_{t+1} = \frac{J_2 + G_1 y_1 - d_{t-1}}{G_2} \quad (2.56)$$

$$y_{t+2} = \frac{a_t y_{t+1} - y_t + d_t}{b_t} \quad (2.57)$$

where

$$Q_1 = H_1 + \frac{G_1 H_2}{G_2} + \left(1 - a_t \frac{G_1}{G_2}\right) \frac{1}{b_t} \quad (2.58)$$

$$Q_2 = J_3 + \frac{a_t (J_2 - d_{t-1})}{b_t G_2} + \frac{H_2 (d_{t-1} - J_2)}{G_2} + \frac{d_t}{b_t} + d_{t-1} (2 + E - a_{t-2}) - d_{t-2} \quad (2.59)$$

$$G_1 = 2 - a_{t-1} \quad (2.60)$$

$$G_2 = 1 - b_{t-1} \quad (2.61)$$

$$H_1 = -2a_{t-1} - E a_{t-1} - b_{t-2} + a_{t-1} a_{t-2} \quad (2.62)$$

$$H_2 = -a_{t-2} b_{t-1} + 2b_{t-1} + 2 + E(1 + b_{t-1}) \quad (2.63)$$

The boundary conditions for Case (b) are shown in Fig. 2.19. The difference equations for the boundary conditions are given by Eq. 2.53 and Eq. 2.64 shown below.

$$y_{t-1} - y_{t+1} = J_1 \quad (2.64)$$

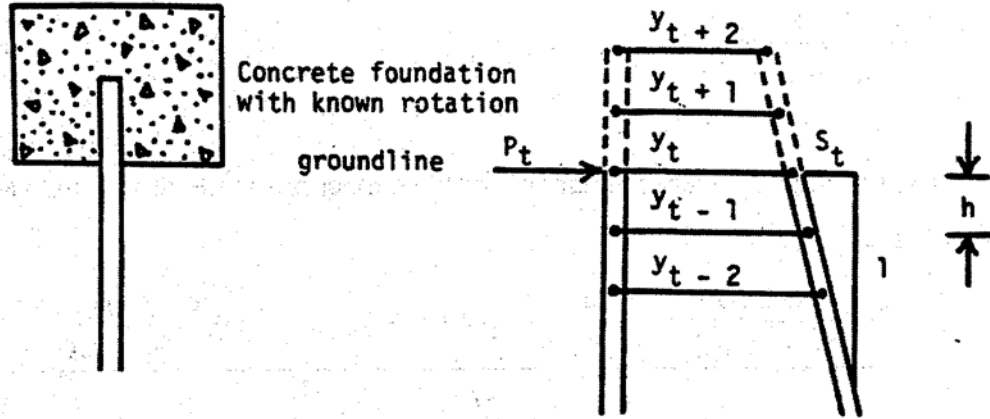

Note: P_t and S_t are shown: they are shown in the positive sense

Figure 2.19 Case (b) of boundary conditions at top of pile

The resulting difference equations for the deflections at the three points at the top of pile are:

$$y_t = \frac{Q^4}{Q^3} \quad (2.65)$$

$$y_{t+1} = \frac{a_{t-1}y_t - J_1 + d_{t-1}}{G_4} \quad (2.66)$$

$$y_{t+2} = \frac{a_t y_{t+1} - y_t + d_t}{b_t} \quad (2.67)$$

where

$$Q_3 = H_1 + \frac{H_2 a_{t-1}}{G_4} - \frac{a_t a_{t-1}}{b_t G_4} + \frac{1}{b_t} \quad (2.68)$$

$$Q_4 = J_3 + \frac{J_1 H_2}{G_4} - \frac{a_t (J_1 - d_{t-1}) - G_4 d_t + b_t d_{t-1} H_2}{b_t G_4} + d_{t-1} (2 + E - a_{t-2}) - d_{t-2} \quad (2.69)$$

$$G_4 = 1 + b_{t-1} \quad (2.70)$$

The boundary conditions for case 3 are shown by the sketches in Fig. 2.20. The difference equations for the boundary conditions are Eq. 2.53 given earlier and Eq. 2.71 shown below.

$$\frac{y_{t-1} - 2y_t + y_{t+1}}{y_{t-1} - y_{t+1}} \quad (2.71)$$

The resulting difference equations for the deflections at the three points at the top of the pile are:

$$y_t = \frac{j_3 - \frac{a_t d_{t-1}(1-J_4)}{b_t(G_2 + J_4 G_4)} + \frac{d_t}{b_t} + d_{t-1}(2+E-a_{t-2}) - d_{t-2} + \frac{d_{t-1} H_2(1-J_4)}{G_2 + J_4 G_4}}{H_1 + H_2 H_3 - \frac{a_t}{b_t} H_3 + \frac{1}{b_t}} \quad (2.72)$$

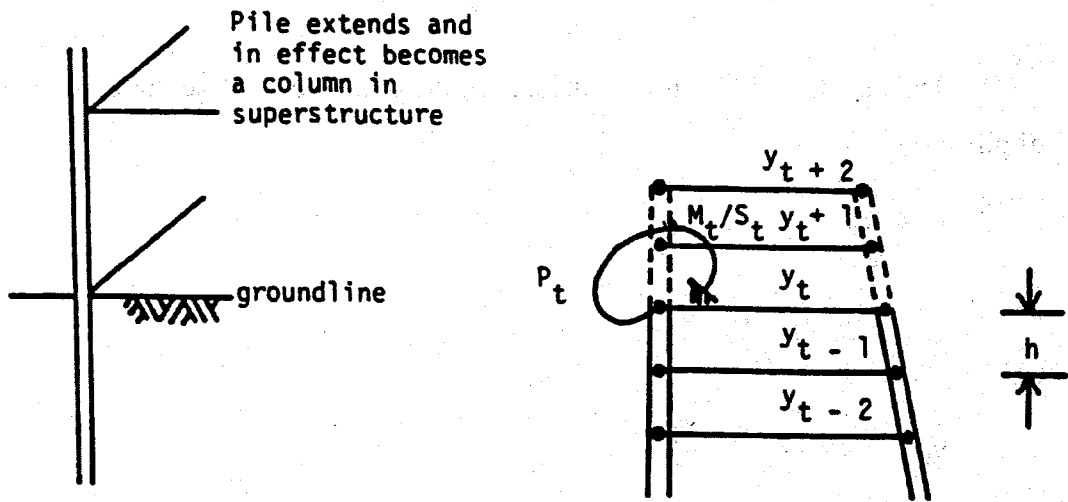

Note: P_t and M_t/S_t are known: They are shown in the positive sense

Figure 2.20 Case (c) of boundary conditions

$$y_{t+1} = \frac{y_t(G_1 + J_4 a_{t-1}) - d_{t-1}(1 - J_4)}{G_2 + J_4 G_4} \quad (2.73)$$

$$y_{t+2} = \frac{1}{b_t}(a_t y_{t+1} - y_t + d_t) \quad (2.74)$$

$$H_3 = \frac{G_1 + J_4 a_{t-1}}{G_2 + J_4 G_4} \quad (2.59)$$

The boundary conditions for Case (d) are shown by the sketches in Fig. 2.21. The difference equations are given by Eq. 2.54 given earlier and by Eq. 2.76 given below.

$$y_t = y_t \quad (2.76)$$

Using the above equations with a family of p - y curves, iteration is carried out until the solution converges to appropriate values of k at all points along the pile. Thus, the behavior of a pile under lateral load may be obtained by using COM624P.

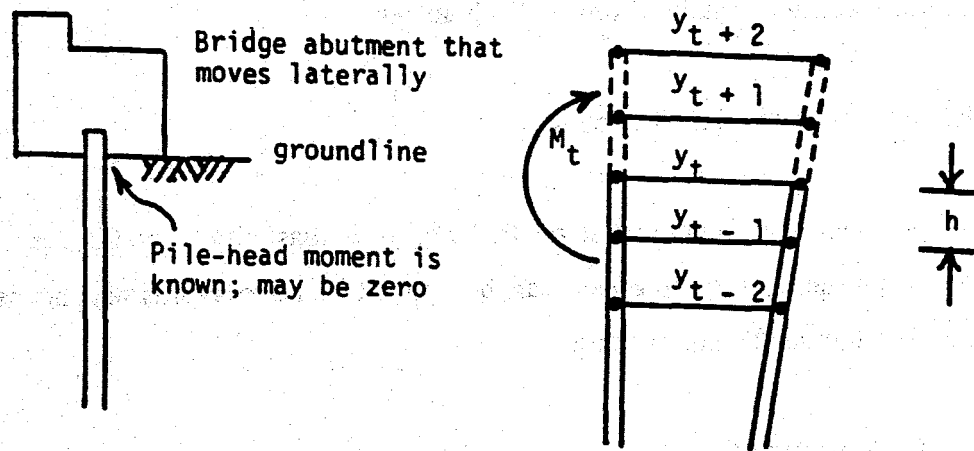

Note: M_t and Y_t are known; they are shown in the positive sense

Figure 2.21 Case (d) of boundary conditions at top of pile.

iii) Soil Response Curves (P - Y Curve)

The p - y curve describes the soil resistance, p has a function of depth and pile deflection, y . The three factors that have the most influence on a p - y curve are the soil properties, the pile geometry, and the nature of loading. The correlations that have been developed for predicting soil response have been based on the best estimate of the properties of the in-situ soil with no adjustment for the effects on soil properties influenced by the method of installation. The logic supporting this approach is that the

effects of pile installation on soil properties are principally confined to a zone of soil close to the pile wall, while a mass of soil of several diameters from the pile is stressed as lateral deflection occurs. There are instances, of course, where the method of pile installation must be considered; for example, if a pile is jetted into place, a considerable volume of soil could be removed with a significant effect on the soil response.

The principal dimension of a pile affecting the soil response is its diameter. All of the recommendations for, p - y curves include a term for the diameter of the pile; if the cross section of the pile is not circular, the width of the pile perpendicular to the direction of loading is usually taken as the diameter.

Soil Models to Determine Soil Behavior

Soil behavior can be modeled by the theory of elasticity only for very small strains. The limit-equilibrium approach can be applied to large strains and hence was employed to develop useful expressions.

Soil Models for Saturated Clay

The assumed model for estimating the ultimate soil resistance near the ground surface is shown in Fig. 2.22 (Reese, 1958). The force F_p is given by

$$F_p = C_a b H [\tan \alpha + (1 + K) \cot \alpha] + \frac{1}{2} b H^2 \gamma + C_a H^2 \sec \alpha \quad (2.77)$$

Where

C_a = average drained shear strength,

K = a reduction factor to be multiplied by C_a to yield the average sliding stress between the pile and the stiff clay, and

γ = average unit weight of soil.

(the other terms are defined in the figure)

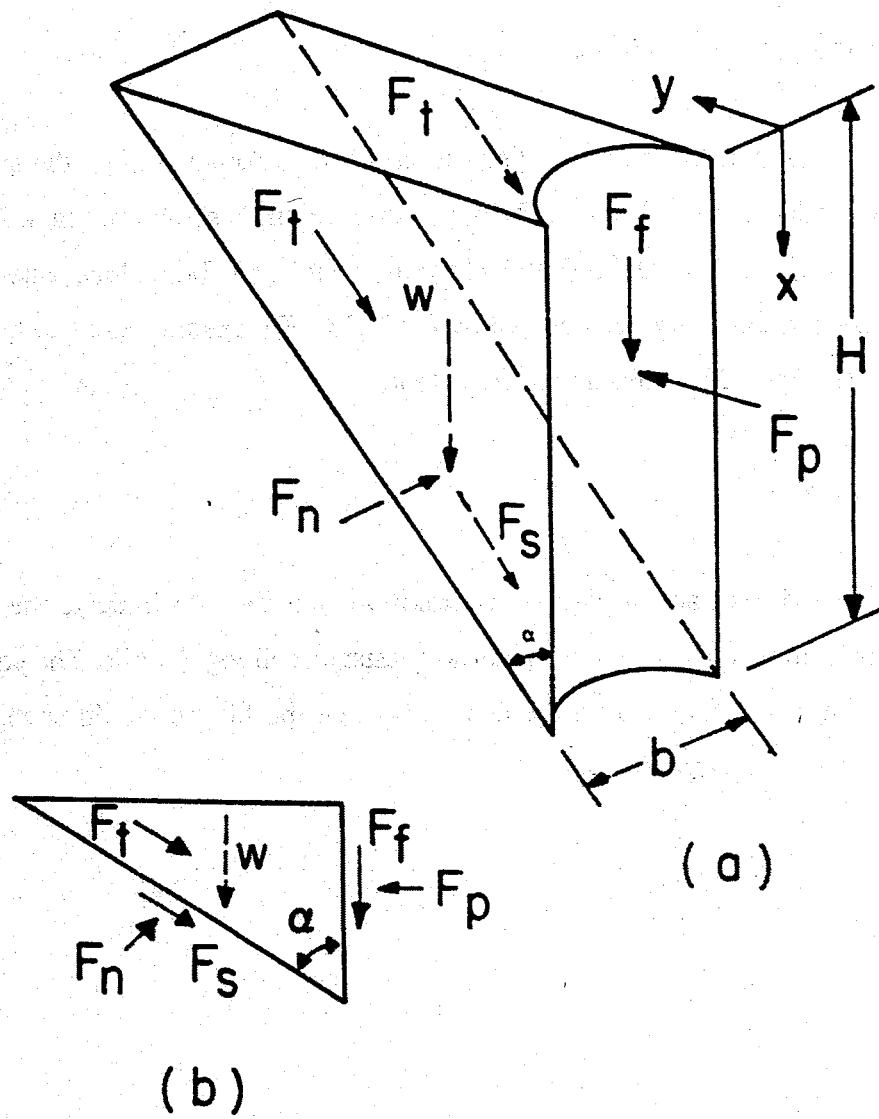

Figure 2.22 Assumed passive wedge-type failure for clay: (a) shape of wedge (b) forces acting on wedge (after Reese, 1985)

The angle α is taken as 45 degrees and K is assumed equal to zero. Differentiation of the resulting expression with respect to H yields an expression for the ultimate soil resistance as follows.

$$(P_u)C_a = 2C_a b + \gamma bH + 2.83C_a H \quad (2.78)$$

It can be reasoned that at some distance below the ground surface the soil must flow around the deflected pile. The model for such movement is shown in Fig. 2.23a. If it is assumed that blocks 1, 2, 4, and 5 fail by shear and that block 3 develops resistance by sliding, the stress conditions are represented by Fig. 2.23b. By examining a free body of a section of the pile, Fig. 2.23c, one can conclude that:

$$(P_u)C_b = 11cb \quad (2.79)$$

Eqs. 2.77 and 2.78 are, of course, approximate but they do indicate the general form of the expressions that give the ultimate soil resistance along the pile. The equations can be solved simultaneously to find the depth at which the failure would change from the wedge-type to the flow-around type.

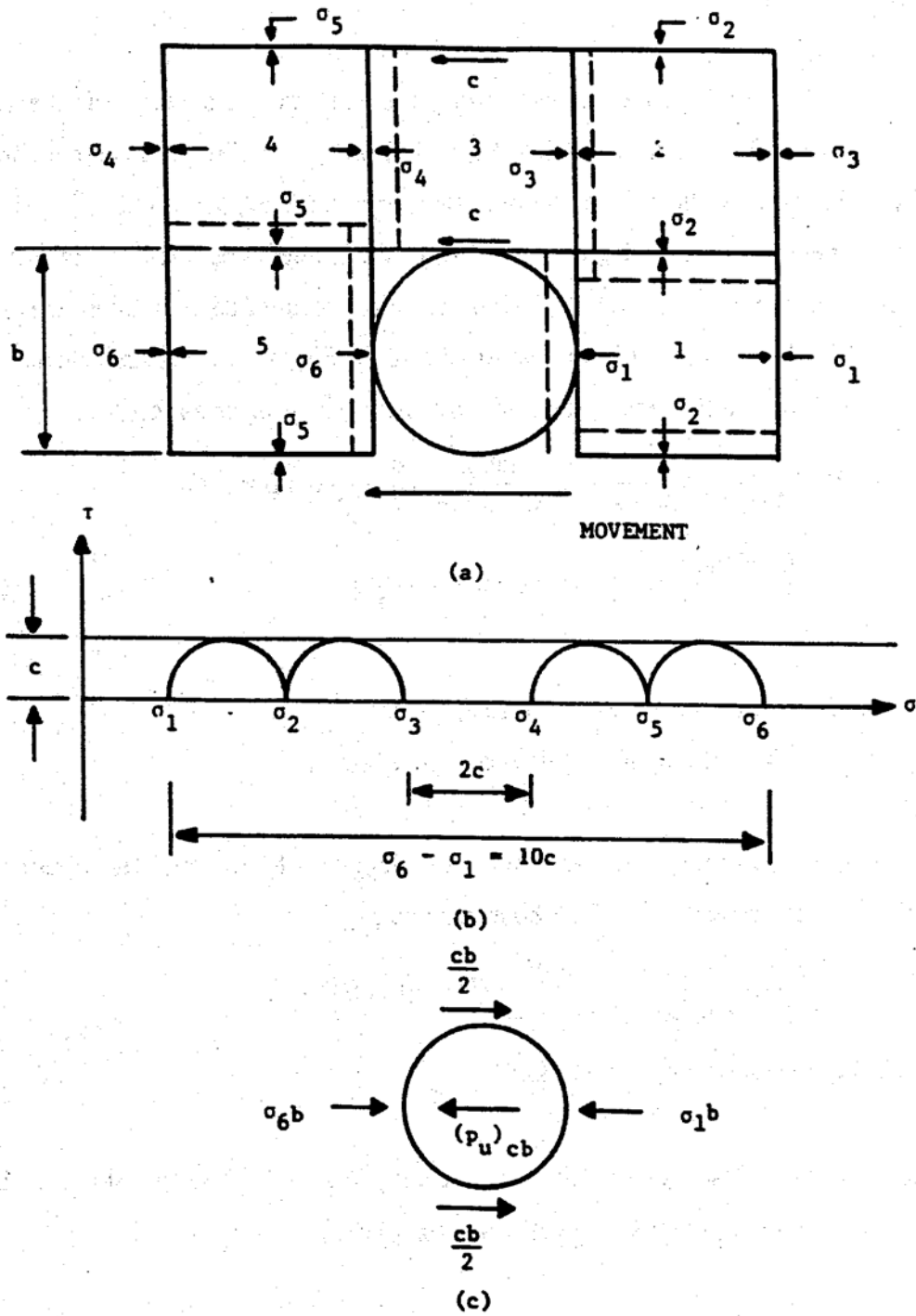

Figure 2.23 Assumed lateral flow-around type of failure for clay: (a) section through pile (b) Mohr-Coulomb diagram (c) force acting on Pile 4.5

Soil Models for Sand

The soil model for sand for computing the ultimate resistance near the ground surface is shown in Fig. 2.24a (Reese, Cox, and Koop, 1974). The total lateral force F_{pt} (Fig. 2.24c) may be computed by subtracting the active force F_a , computed using Rankine theory, from the passive force F_p , computed from the model. The force, F_p is computed by assuming that the Mohr-Coulomb failure condition is satisfied on, planes ADE, BCF, and AEFB. The directions of the forces are shown in Fig. 2.24b. No frictional force is assumed to be acting on the face of the pile. The equation for F_{pt} is as follows:

$$F_{pt} = H^2 \gamma \left[\frac{K_0 H \tan \phi \sin \beta}{3 \tan(\beta - \phi) \cos \alpha} + \frac{\tan \beta}{\tan(\beta - \phi)} \left(\frac{b}{2} + \frac{H}{3} \tan \beta \tan \alpha \right) \right. \\ \left. - \frac{K_0 H \tan \beta}{3} (\tan \phi \sin \beta - \tan \alpha) - \frac{K_a}{2} \right] \quad (2.80)$$

where

K_0 = coefficient of earth pressure at-rest,

K_a = minimum coefficient of active earth pressure.

The ultimate soil resistance per unit length of the pile is obtained by differentiating with respect to H , Eq. 2.80 and given by

$$(p_u)_{sa} = H \gamma \left[\frac{K_0 H \tan \phi \sin \beta}{\tan(\beta - \phi) \cos \alpha} + \frac{\tan \beta}{\tan(\beta - \phi)} (b + H \tan \beta \tan \alpha) \right. \\ \left. + K_0 H \tan \beta (\tan \phi \sin \beta - \tan \alpha) - K_a b \right] \quad (2.81)$$

Bowman (1958) suggested values of β from $\sim 1/3$ to $\sim 1/2$ for loose sand and up to for dense sand. The value of R is approximated as follows:

$$\beta = 45 + \frac{\phi}{2} \quad (2.82)$$

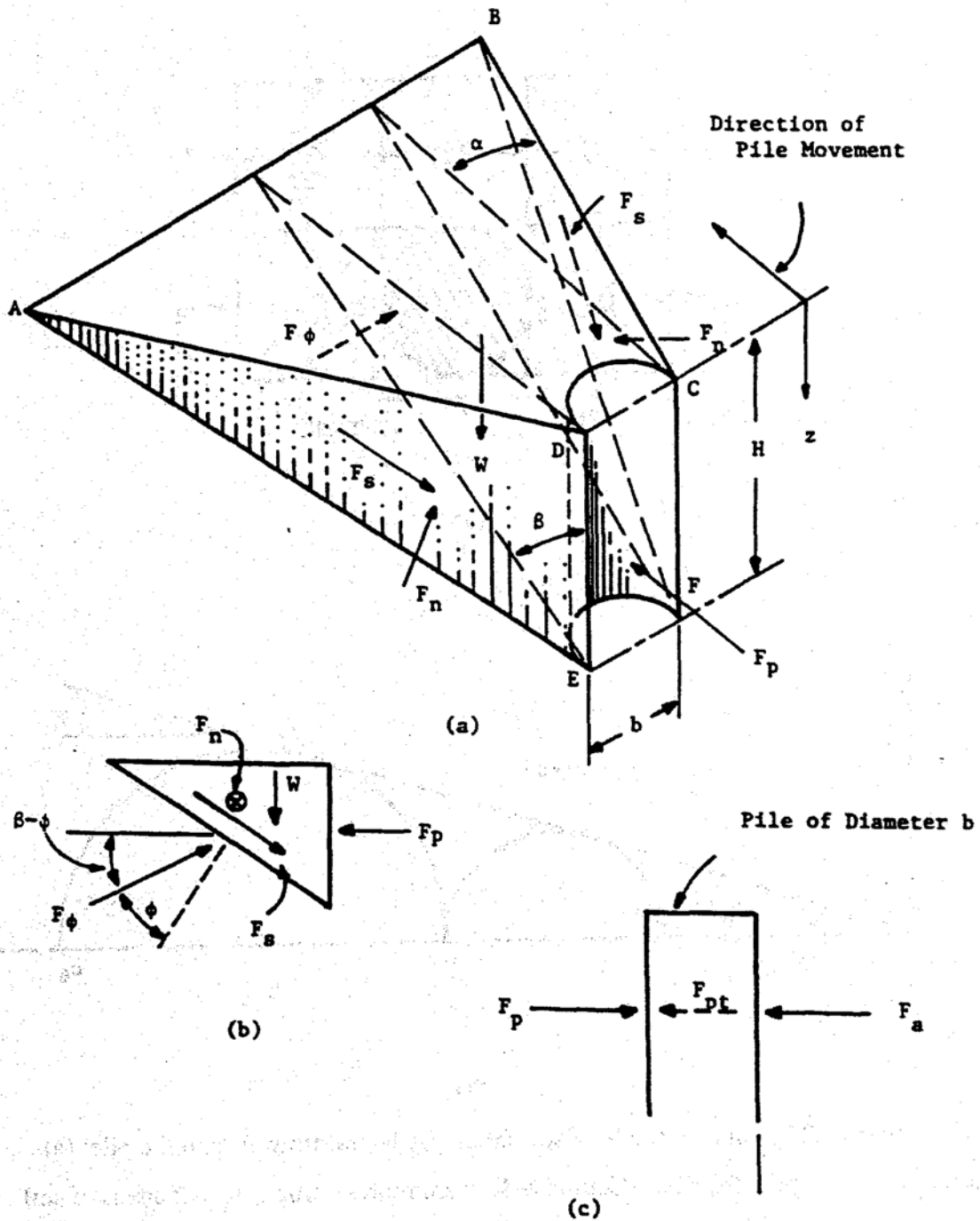
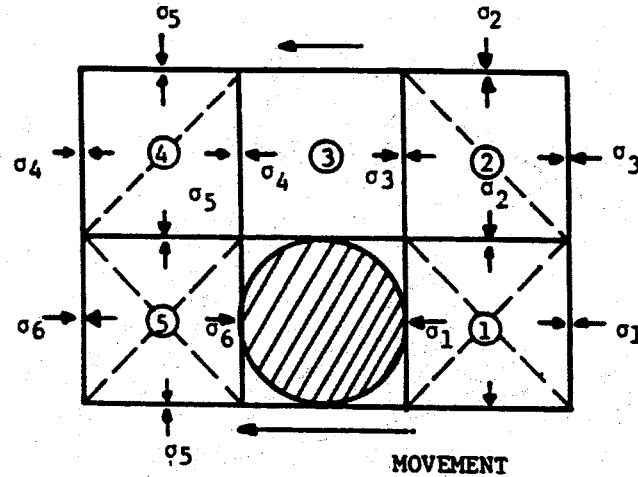
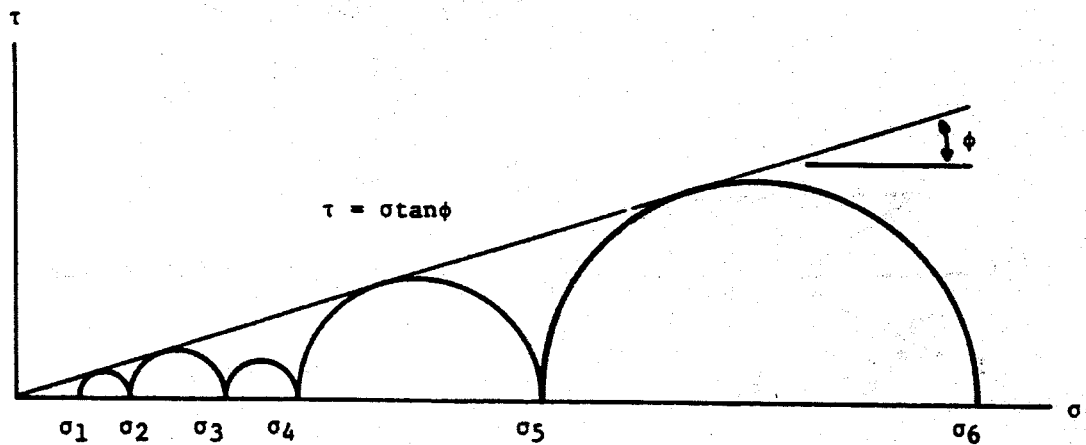

Figure 2.24 Assumed passive wedge-type failure: (a) general shape of wedge, (b) forces on wedge, (c) forces on pile (after Reese, et al, 1974)



(a)



(b)

Figure 2.25 Assumed mode of soil failure by lateral flow around the pile: (a) section through the pile (b) Mohr-Coulomb diagram representing states of stress of soil flowing around a pile.

The model for computing the ultimate soil resistance at some distance below the ground surface is shown in Fig. 2.25a. The stress σ_1 , at the back of the pile must be equal to or larger than the minimum active earth pressure; if not, the soil could fail by slumping. This assumption is based on two-dimensional behavior and is subject to some

uncertainty. Assuming the states of stress shown in Fig. 2.25b, the ultimate soil resistance for horizontal flow around the pile is

$$(p_u)_{sb} = K_a b \gamma H (\tan^2 \beta - 1) + K_0 b \gamma H \tan \Phi \tan^4 \beta \quad (2.83)$$

Eqs. 2.82 and 2.83 can be solved simultaneously to find the approximate depth at which the soil failure changes from the wedge type to the flow-around type.

Recommendations for p - y Curves

Three major experimental programs were performed for piles in different types of clay - i) soft clay below the water table, ii) stiff clay below the water table, and iii) stiff clay above the water table. In each case, the piles were subjected to short-term static loads and repeated (cyclic) loads. Fig. 2.26 shows the p - y curves for soft clay below water table. The deflection, y_{50} at one-half the ultimate soil resistance is defined in Table 2.1. The transition depth to the p - y curve is given by

$$x_r = \frac{6cb}{\gamma b + Jc} \quad (2.84)$$

For sand, a major experimental program was conducted on the behavior of laterally loaded piles in sand below the water table. The result can be used for sites with sand above the water table. The p - y curves for sand below the water table is shown in Fig. 2.27.

Procedure for computing p - y curves in sand

- i) Obtain values for the angle of internal friction ϕ , the soil unit weight γ , and pile diameter b .
- ii) Make the following preliminary computations.

$$\alpha = \frac{\phi}{2}; \beta = 45 + \frac{\phi}{2}; K_0 = 0.4; \text{ and } K_a = \tan^2 \left(45 - \frac{\phi}{2} \right) \quad (2.85)$$

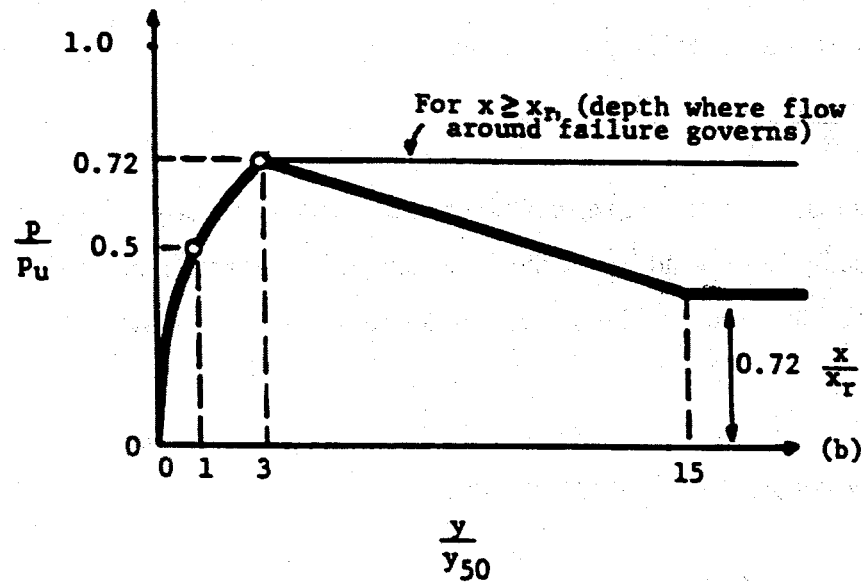
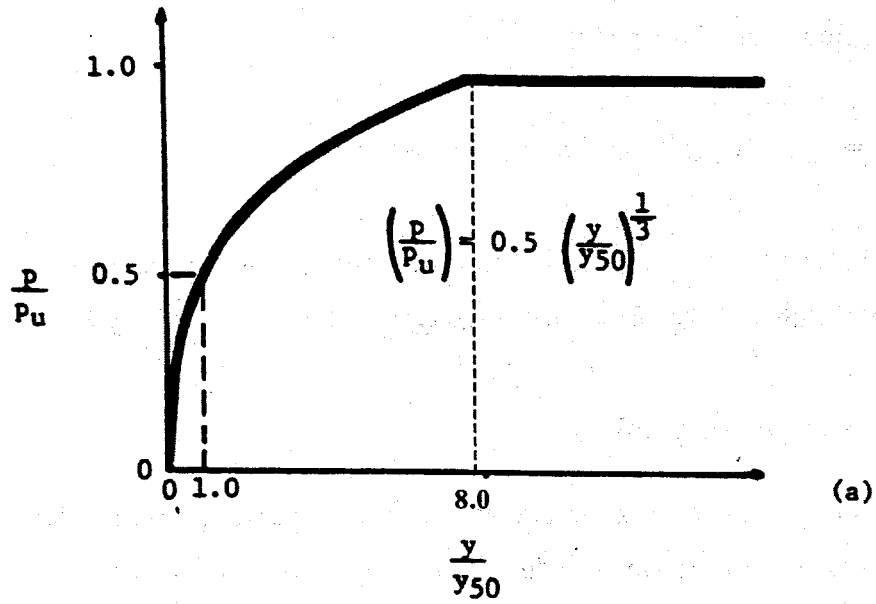

Figure 2.26 Characteristic shapes of the p - y curves for soft clay below water surface: (a) static loading (b) cyclic loading (after Matlock, 1970)

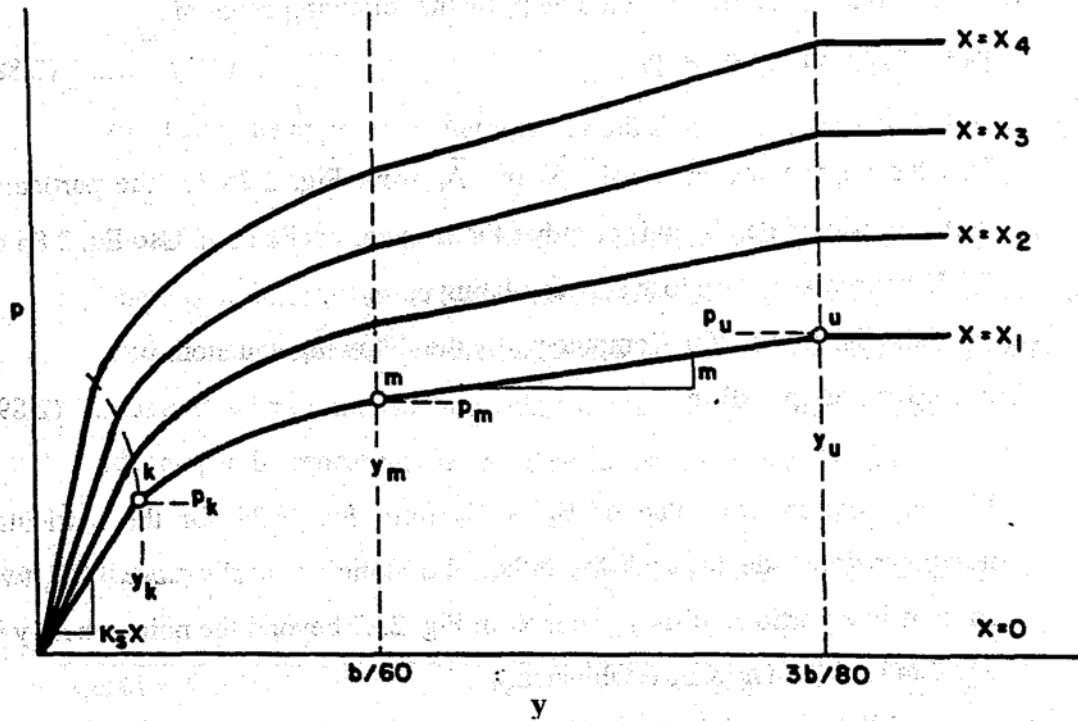

Figure 2.27 Characteristic shape of a family of p - y curves for static and cyclic loading in sand (after Reese, et al, 1974)

- iii) Compute the ultimate soil resistance per unit length of pile using the smaller of the values given by the equations below.

$$p_{st} = \gamma \left[\frac{K_0 x \tan \phi \sin \beta}{\tan(\beta - \phi) \cos \alpha} + \frac{\tan \beta}{\tan(\beta - \phi)} (b + x \tan \beta \tan \alpha) + K_0 x \tan \beta (\tan \phi \sin \beta - \tan \alpha) - K_a b \right] \quad (2.86)$$

$$p_{sd} = K_a b \gamma x (\tan^8 \beta - 1) + K_0 b \gamma x \tan \phi \tan^4 \beta \quad (2.87)$$

For the sand below the water table, the submerged unit weight γ' should be used.

- iv) In making the computations in step (iii), find the depth x_t at which there is an intersection of Eqs. 2.86 and 2.87. Eq. 2.86 is applicable for depths greater than x_t and Eq. 2.87 is for smaller than x_t .
- v) Select a depth a at which a p - y curve is desired.

vi) Establish y_u as $3b/80$. Compute p_u by the following equation:

$$p_u = \bar{A}_s p_s \quad \text{or} \quad p_u = \bar{A}_c p_s \quad (2.88)$$

Use the appropriate value of \bar{A}_s or \bar{A}_c from Fig. 2.28 for the particular nondimensional depth, and for either the static or cyclic case. Use Eq. 2.86 or 2.87, by corresponding to x_t for calculating p_s .

vii) Establish y_m as $b/60$. Compute p_m by the following equation:

$$p_m = B_s p_s \quad \text{or} \quad p_m = B_c p_s \quad (2.89)$$

Use the appropriate value of B_s or B_c from Fig. 2.29 for the particular nondimensional depth, and for either the static or cyclic case. The two straight-line portions of the p - y curve, in Fig. 2.27 beyond the point where y is equal to $b/60$, can now be established.

viii) Establish the initial straight-line portion of the p - y curve,

$$p = (kx) y \quad (2.90)$$

Use the appropriate value of k from Tables 2.2 and 2.3.

ix) Establish the parabolic section of the p - y curve,

$$p = \bar{c} y^{1/n} \quad (2.91)$$

Fit the parabola between points k and m as follows:

a) Get the slope of line between points m and u by,

$$m = \frac{p_u - p_m}{y_u - y_m} \quad (2.92)$$

b) Obtain the power of the parabolic section by,

$$n = \frac{p_m}{m y_m} \quad (2.93)$$

c) Obtain the coefficient \bar{c} as follows:

$$\bar{c} = \frac{p_m}{y_m^{1/n}} \quad (2.94)$$

d) Determine point k as,

$$y_k = \left(\frac{c}{kx} \right)^{n/n-1} \quad (2.95)$$

e) Compute appropriate number of points on the parabola by using Eq. 2.91. Note: The step by step procedure is outlined, and Fig. 2.27 is drawn, as if there is an intersection between the initial straight-line portion of the p - y curve and the parabolic portion of the curve at point k . However, in some instances there may be no intersection with the parabola. Any number of curves can be developed by repeating the above steps for each desired depth.

Table 2.2 Representative values of k for submerged sand (static and cyclic loading)

Relative density	Loose	Medium	Dense
Recommended k (psi)	20	60	125

Table 2.3 Representative values of k for sand above water table (static and cyclic loading)

Relative density	Loose	Medium	Dense
Recommended k (psi)	25	90	225

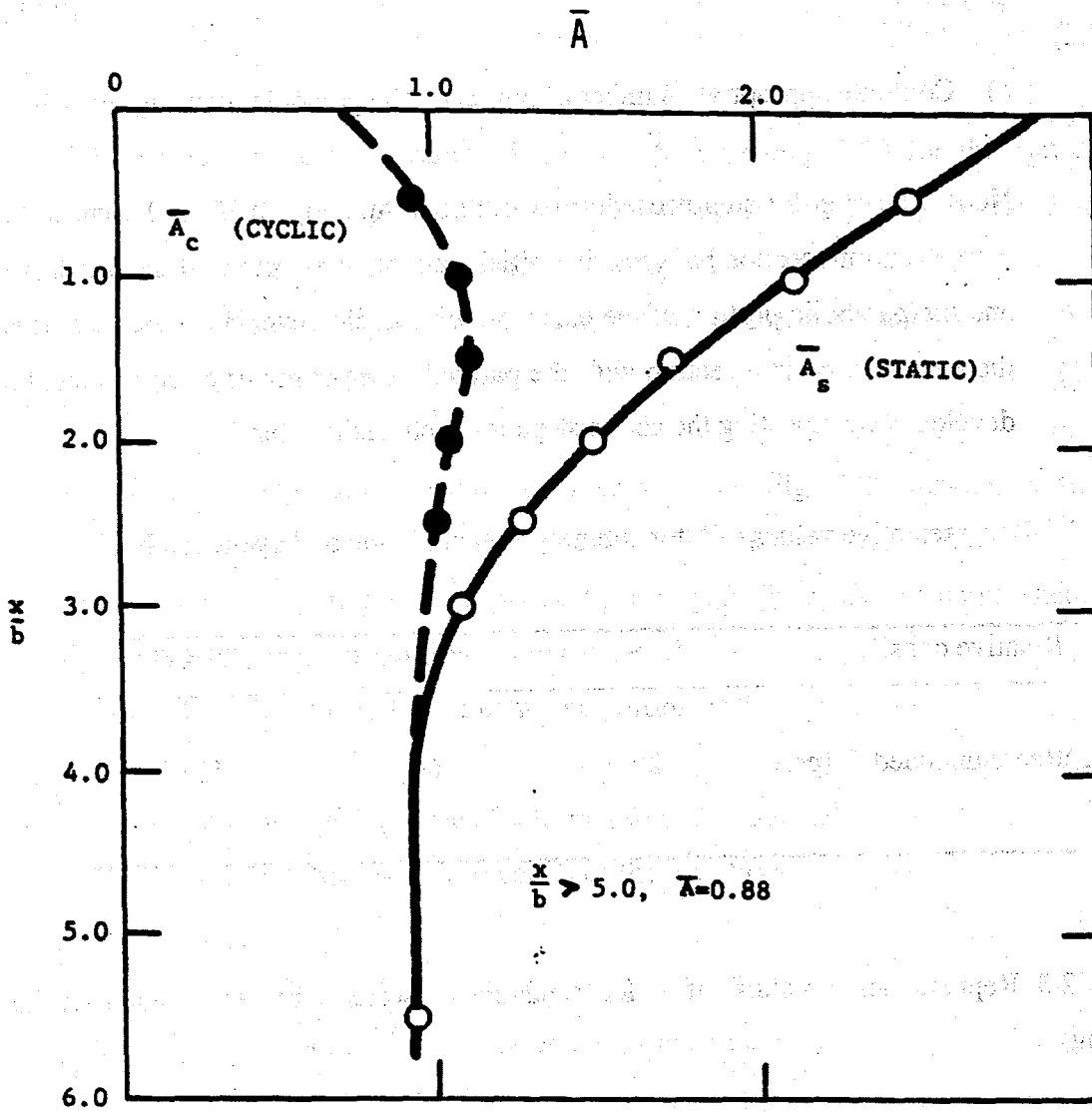

Figure 2.28 Values of coefficients \bar{A}_s or \bar{A}_c (after Reese, et al, 1974)

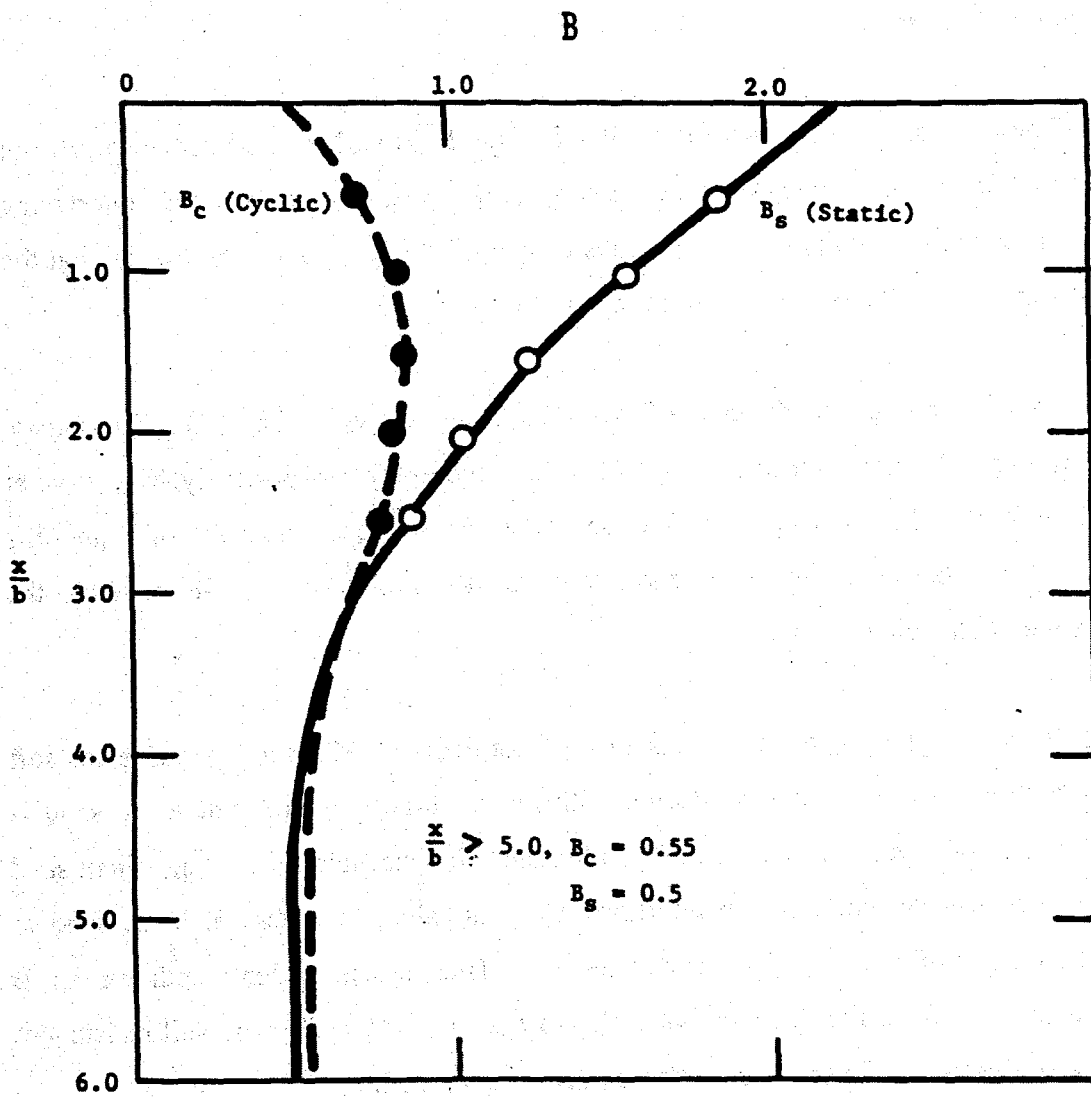

Figure 2.29 Values of coefficients B for soil resistance versus depth
(after Reese, et al, 1974)

Example p - y curves

The example problem with layered soil (Fig. 2330) is discussed in the following: a 24 in. diameter is embedded in soil consisting of an upper layer of soft clay, overlaying a layer of loose sand, which in turn overlays a layer of stiff clay. The water table is at the ground surface and the loading is assumed to be static.

Four p - y curves for the case of layered soil are shown in Fig. 2.31. The curves shown in Fig. 2.31, are for depths of 36, 72, 144 in and 288, in, respectively. The curve at a depth of 36 in. falls in the upper zone of soft clays; the curve for the depth of 72 in. falls in the sand just below the soft clay; and curves for depths of 144 and 288 in. fall in the lower zone of stiff clay.

Following the procedure suggested by Georgiadis (1983), the p - y curve for soft clay is first computed, and when dealing with the sand, an equivalent depth of sand is found such that the value of the sum of the ultimate soil resistance for the equivalent sand and the soft clay are equal at the interface. The equivalent thickness of loose sand to replace the 68 in of soft clay was found to be 74 in. Thus, the equivalent depth to point B in loose sand is 78 in. Fig. 2.32 shows a plot of the sum of the ultimate soil resistances with the equivalent thickness of the soft clay layer shown as XEQ.

An equivalent depth of stiff clay was found such that the sum of the ultimate soil resistance for the stiff clay is equal to the sum of the ultimate soil resistance of the loose sand and soft clay. In making the computation, the equivalent and actual thickness of the loose sand, 74 in and 52 in, respectively, were replaced by 45 in. of stiff clay. Thus, the actual thickness of the soft clay and loose sand of 120 in. were reduced by 75 in., leading to equivalent depths in the stiff clay of points C and D of 69 in. and 213 in., respectively.

Another point of considerable interest is that the recommendations for p - y curves for stiff clay in the presence of no free water were used for the stiff clay. This decision is

based on the assumption that the sand above the stiff clay can move downward and fill any gap that develops between the clay and pile. Furthermore, in the stiff clay experiment where free water was present, the free water moved upward along the face of the pile with each cycle of loading. The presence of soft clay and sand to a depth of 10 ft above the stiff clay is believed to suppress the hydraulic action of free water even though the sand did not serve to close the potential gaps in the stiff clay.

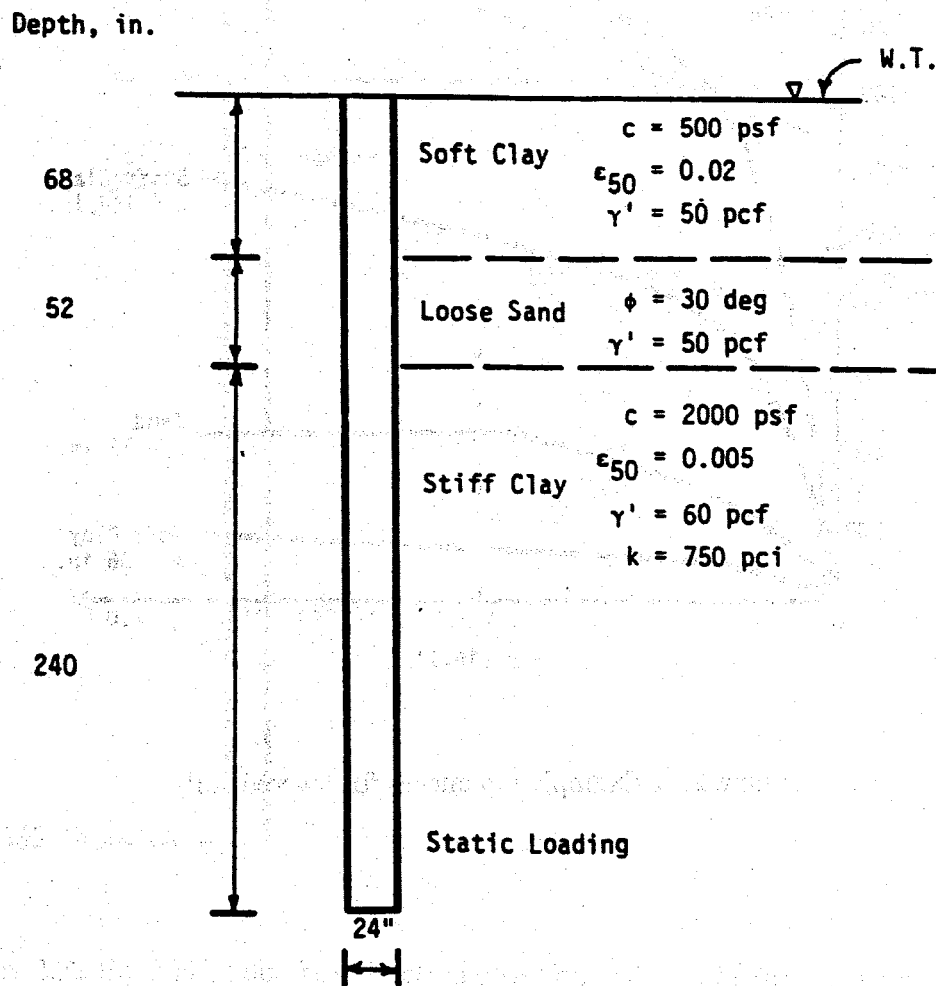

Figure 2.30 Example problem for soil response for layered soils

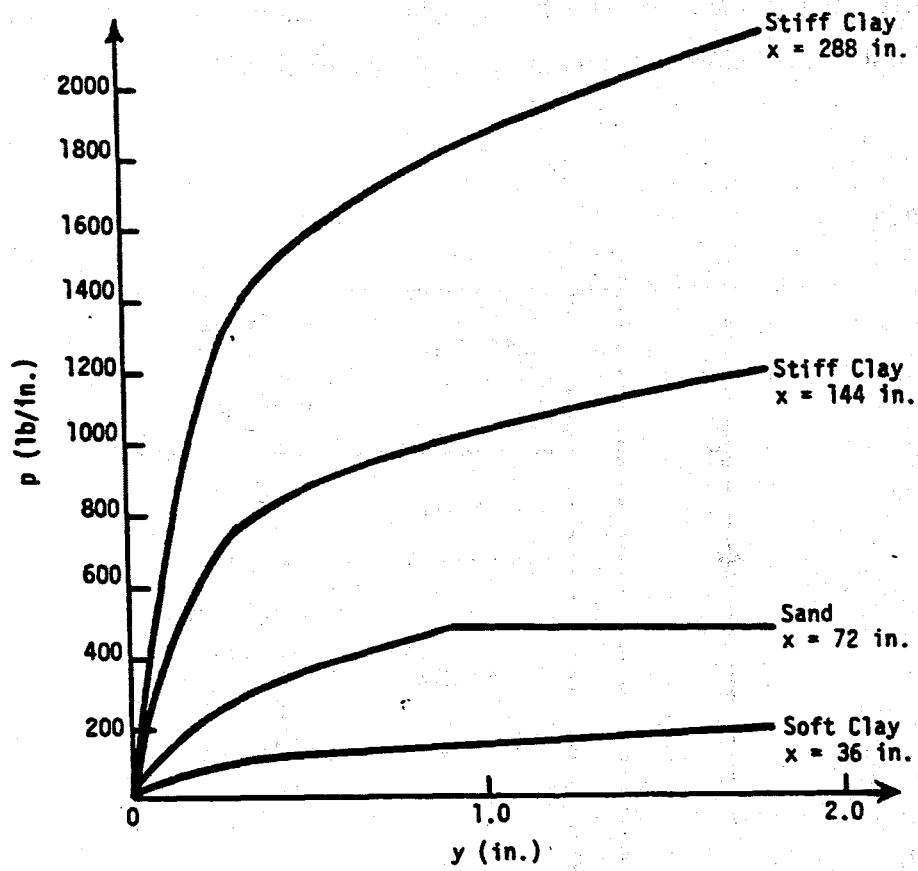

Figure 2.31 Example p - y curves for layered soils

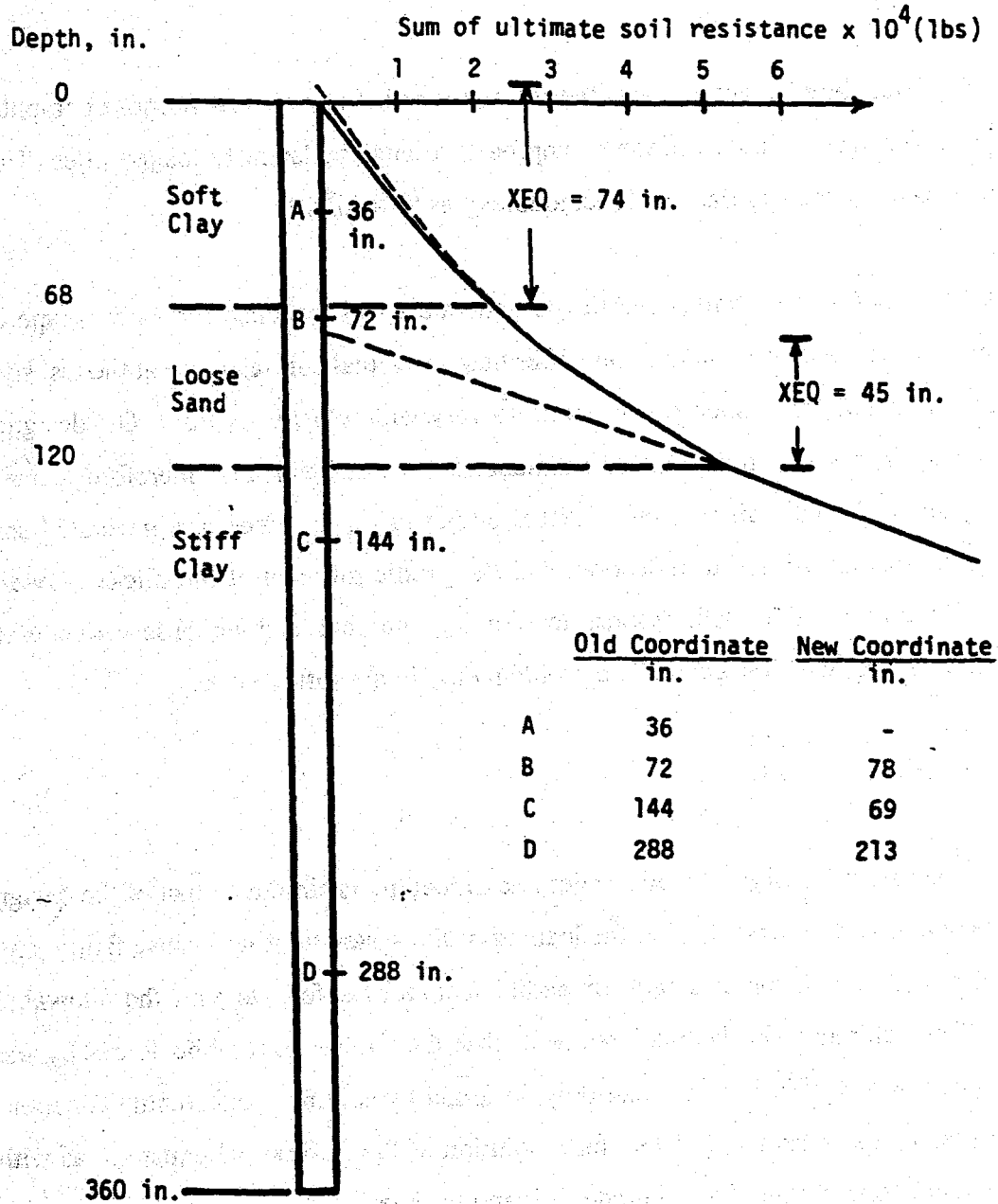

Figure 2.32 Equivalent depths of overlying soil for use in computing p - y for a layer system

LPILE has been developed by Reese (1985), and it is a special purpose computer program, which uses a finite difference approach to analyze laterally loaded piles. This program uses the same approach and methodology as COM624P.

LPILE uses various soil properties to generate a soil response for a given type of soil. This soil response was found to be stiffer than, the actual soil response at the test site; however, the actual soil response was found to vary widely between tests. The designer typically does not know the shear or moment at the pile-head and, therefore, cannot accurately solve for the soil response. LPILE output using the internally generated soil response, the design pile-head deflection, and the plastic moment at the pile-head were found to be conservative with respect to bending moment and unconservative with respect to buckling, which is generally a problem only in the softest soils.

Nonlinear Response of Soil

In a sense, the design of a pile under lateral loading is similar to that of the design of any foundation. One needs to find the loading of the system that will cause failure and then to use a global factor of safety, or partial factors of safety, to find the allowable loading. The difference for lateral loading is that the failure cannot be found by the equations of static equilibrium, but can only be found by solving a differential equation. Furthermore, as noted below, a closed-form solution of the differential equation, as with the use of a constant modulus of subgrade, is inappropriate.

Curves of soil response were computed from the results of full-scale experiments of a steel pipe pile, instrumented for the measurement of bending moment. The pile was installed into overconsolidated, clay and free water was above the ground surface. The results for static loading definitely show that the soil resistance is nonlinear with pile deflection and with depth. Thus, if the results of a linear analysis shows a tolerable level of stress in a pile and of deflection, a minor increase in the loading could cause a failure

by collapse or by excessive deflection. Therefore, a basic principle of design is that any method must consider the nonlinear response of the soil to lateral loading.

Limit States

Failure of a pile in most instances is exhibited by a bending moment that would cause the development of a plastic hinge; however, in some instances the failure could also be due to excessive deflection. Therefore, design is initiated by a decision of what constitutes a failure; or a limit state. Then, computations of LRILE are made to find the loading that, causes the limit state.

In LPILE, a global factor of safety is normally employed to find the allowable loading, the service loading, or the working loading. An approach using partial safety factors may be employed. However, the concepts employed in setting the partial factors of safety is implemented by using upper-bound and lower-bound values of the important parameters.

3.1 Superstructure

A. Design data

- Two lane integral bridge (Figs. 3.1 and 3.2) with seven AASHTO Type III bridge girders.
- Total length of 360 ft with five spans (60-80-80-80-60 ft). The coefficient of thermal expansion for concrete superstructure, $\alpha = 0.000006 / ^\circ F$ (AASHTO specification).
- Load combination and load factors corresponding to AASHTO strength I are used in design.
- Figs. 3.3 and 3.4 show the dimensions of AASHTO Girder type III and typical section of parapet respectively.

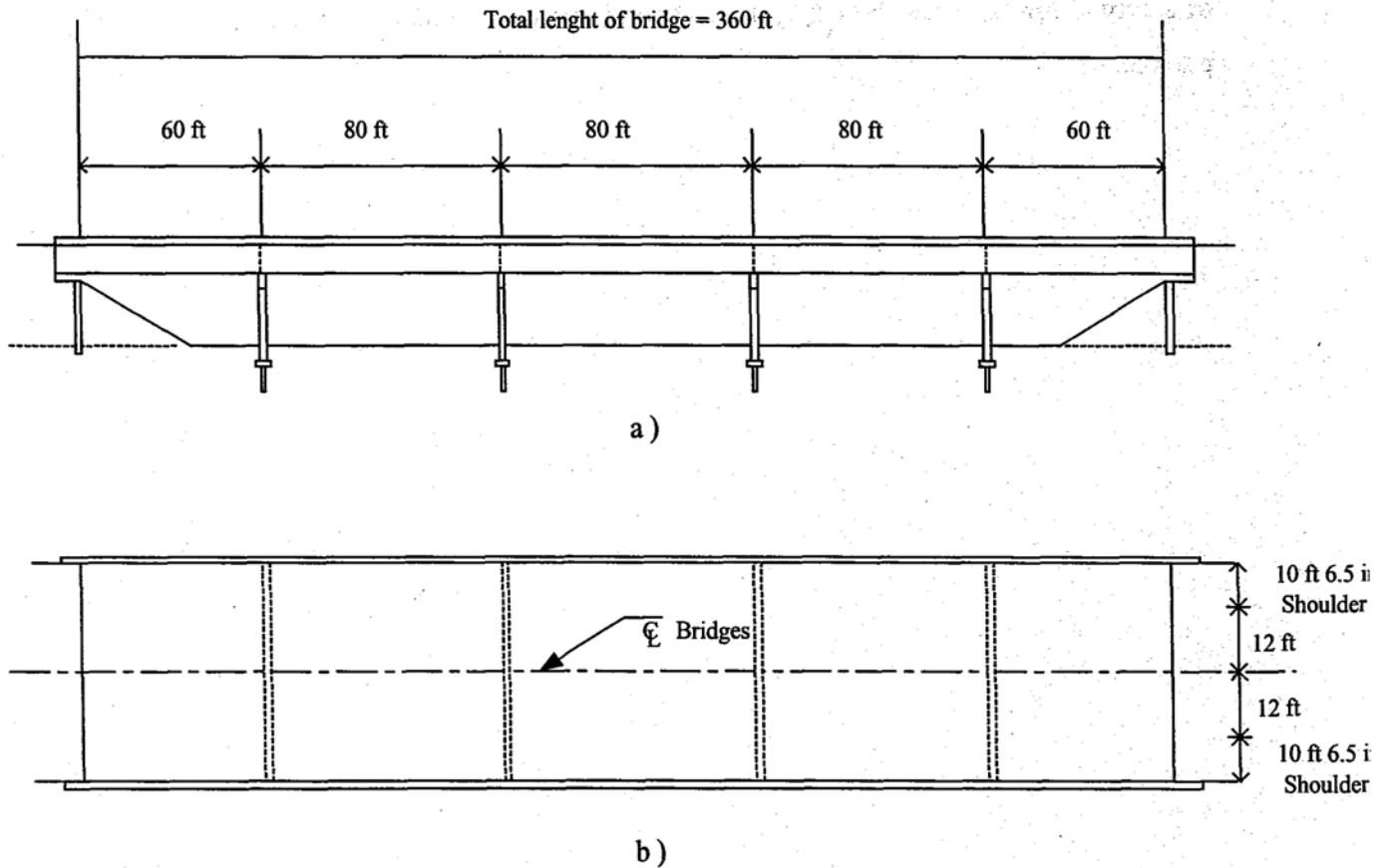

Figure 3.1 Prestressed concrete girder integral abutment bridge a) elevation , and b) plan

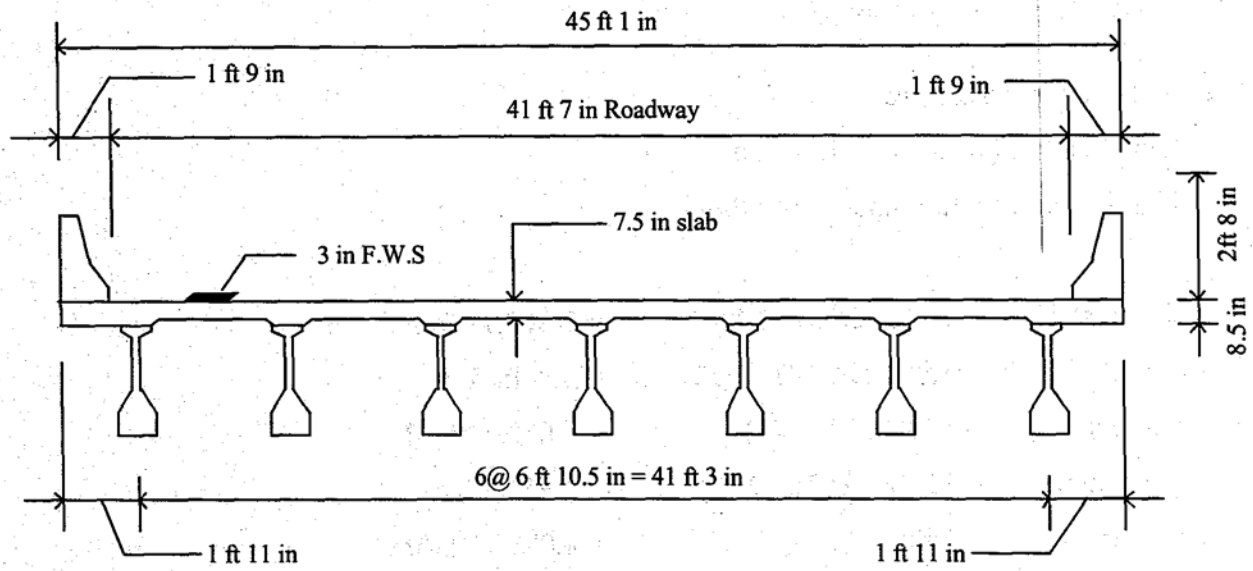

Figure 3.2 Cross section of bridge deck (Not to scale)

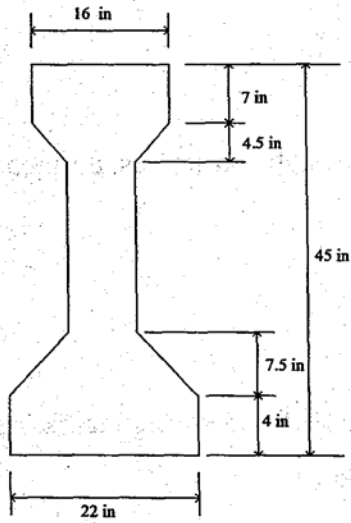

Figure 3.3 AASHTO Girder type III

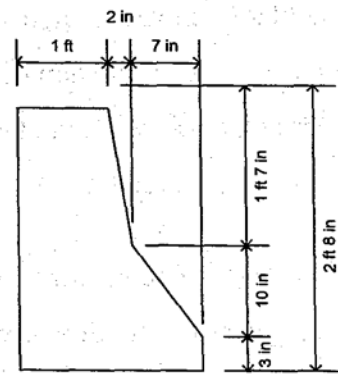

Figure 3.4 Typical section of parapet

B. Permanent loads and live loads

i) Dead load of superstructure

Unit weight of concrete = 150 lb/ft^3

Unit weight of bituminous = 140 lb/ft^3

7.5 in. slab = $150 (7.5/12)(41.25) = 3,867.19 \text{ lb/ft}$

8.5 in. slab = $150 (8.5/12)(1.92)(2) = 408 \text{ lb/ft}$

Parapet = $150(485/144)(2) = 1,610.42 \text{ lb/ft}$

2 in. haunch = $150(2/12)(16/12)(7) = 233.33 \text{ lb/ft}$

Girder = $150(560/144)(7) = 4,083.33 \text{ lb/ft}$

Total DC = $9,602.27 \text{ lb/ft}$

3 in. bituminous paving = $140(3/12)(41.58) = 1,455.31 \text{ lb/ft}$

Total DW = $1,455.31 \text{ lb/ft}$

ii) Vehicular live load (AASHTO, 3.6.1.2)

Vehicular live loading on the roadways of bridges or incidental structures, designated HL-93, shall consist of a combination of:

- a) Design truck or design tandem
- b) Design lane load

Design truck: The weights and spacing of axles and wheels for the design truck are shown in Fig. 3.5. A dynamic load allowance is considered in the design.

Design tandem: The design tandem consists of a pair of 25.0 kips axles spaced 4.0 ft apart. The transverse spacing of wheel is 6.0 ft. A dynamic load allowance is included in the design.

Design lane load: The design lane load consists of a load of 0.64 klf, uniformly distributed in the longitudinal direction. Transversely, the design lane load is assumed to be

uniformly distributed over a 10 ft width. The force effects from the design lane load are not subject to a dynamic load allowance.

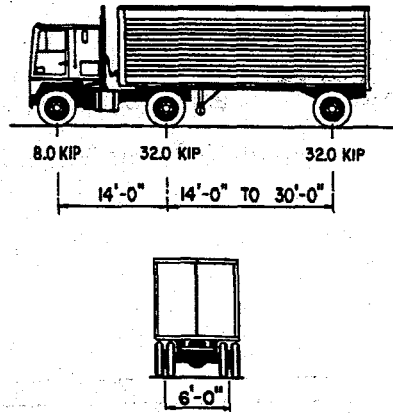

Figure 3.5 Characteristics of the design truck (AASHTO, 1998)

3.2 Temperature, Creep and Shrinkage. Effect

The horizontal displacement at each abutment due to temperature drop and shrinkage is calculated as follows:

Due to temperature drop, $\Delta_t = \alpha_t \Delta T L_b$

Due to shrinkage, $\Delta_s = \alpha_s L_b$

Creep effects are assumed to be negligible after 7 to 8 months of construction

$$\alpha_t = 0.000006 / ^\circ\text{F} \text{ (AASHTO, 5.4.2.2)}$$

$$\alpha_s = -0.0002 \text{ after 28 days, } -0.0005 \text{ after 1 year, (AASHTO, 5.4.3.2.1)}$$

FHWA suggested using shrinkage reduction of 50%.

$$\begin{aligned} \Delta &= \Delta_t + 0.5\Delta_s \\ &= (0.000006)(40)(360)(12) + (0.5)(0.0002)(360)(12) \\ &= 1.04 \text{ in.} + 0.43 \text{ in.} \\ &= 1.47 \text{ in.} \end{aligned}$$

$$\text{Displacement at each abutment} = \Delta/2 = 1.47/2 = 0.735 \text{ in.}$$

3.3 Approach Slab

A. Approach slab dimensions

The thickness of slab is assumed as 12 in. and width equal to width of deck slab (45 ft 1 in.). NJDOT recommended a minimum length of 10 ft. The length of slab in the present example, is assumed to be 20 ft (Fig. 3.6).

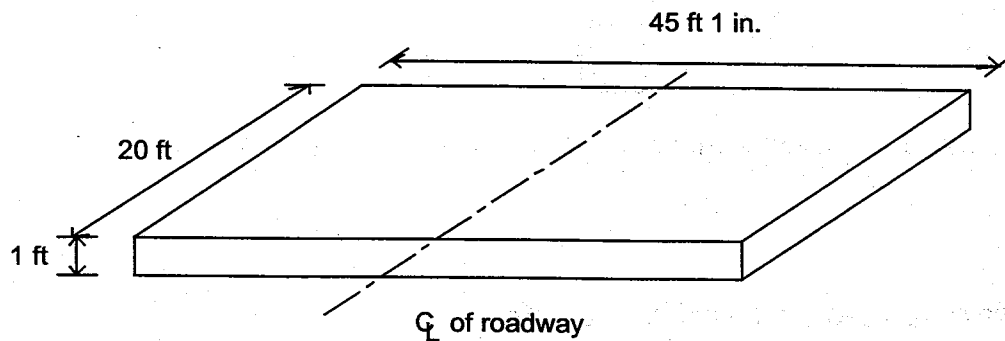

Figure 3.6 Dimensions of approach slab

B. Live load effects

Approach slab is supported by abutment at one end and sleeper slab at the other end. The design of approach slab is carried out similar to a simply supported solid slab bridge.

Equivalent width of longitudinal strip lane (AASHTO 4.6.2.3)

i) One-lane loaded

$$E = 10 + 5 \sqrt{L_1 W_1}$$

Where

E = equivalent width (in.)

L_1 = modified span length taken equal to the lesser of the actual span or 60 ft (ft)

W_1 = modified edge-to-edge width of bridge taken to be equal to lesser of the actual width or 60 ft for multilane loading, or 30 ft for single-lane loading (ft)

$$L_1 = \min \begin{cases} 20 \text{ ft} \\ 60 \text{ ft} \end{cases} = 20 \text{ ft}$$

$$W_1 = \min \begin{cases} 45.08 \text{ ft} \\ 30 \text{ ft} \end{cases} = 30 \text{ ft}$$

$$E = 10 + 5\sqrt{20(30)} = 133 \text{ in.}$$

ii) Multiple-lane loaded

$$E = 84 + 1.44 \sqrt{L_1 W_1} \leq \frac{12W}{N_L}$$

Where

NL = number of design lanes

$$= \text{INT} \left(\frac{W}{12} \right)$$

W = clear roadway width

$$L_1 = \min \begin{cases} 20 \text{ ft} \\ 60 \text{ ft} \end{cases} = 20 \text{ ft}$$

$$W_1 = \min \begin{cases} 45.08 \text{ ft} \\ 60 \text{ ft} \end{cases} = 45.08 \text{ ft}$$

$$N_L = \text{INT} \left(\frac{45.08}{12} \right) = 3 \text{ lanes}$$

$$E = 84 + 1.44 \sqrt{20(45.08)} \leq \frac{12(45.08)}{3}$$

$$= 127.24 \leq 180.32 \text{ in.}$$

Therefore, use E = 127 in.

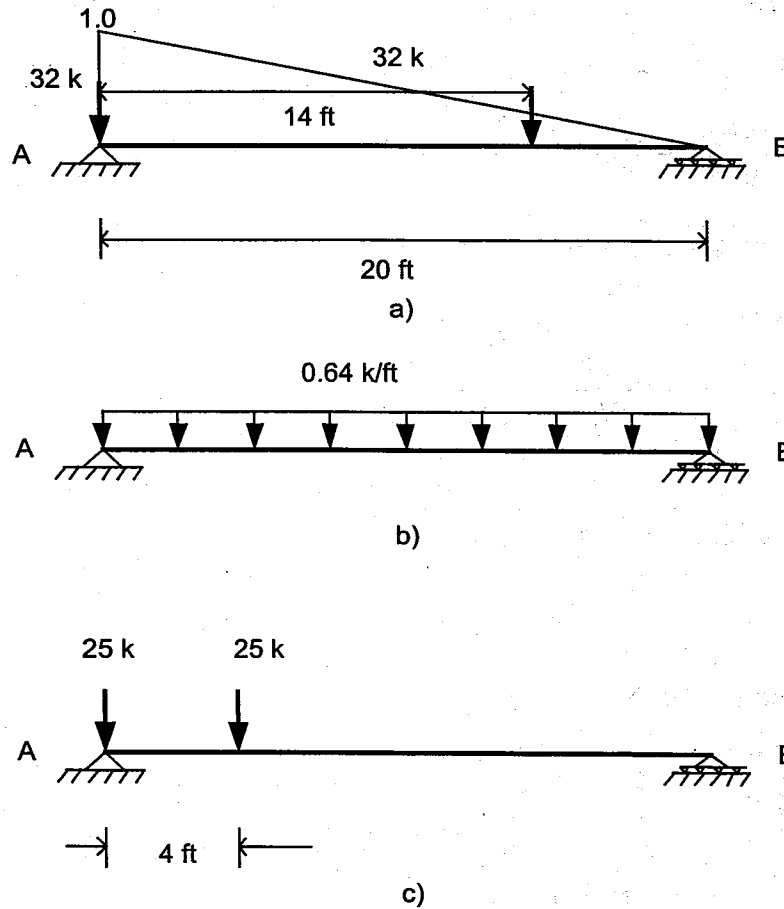

Figure 3.7 Live load placement for maximum reaction in approach slab: a) design truck, b) design tandem truck and c) design truck

Maximum shear force - Axle loads (Fig. 3.7)

Truck: (AASHTO 3.6.1.2.2)

$$V_A^{Tr} = 1(32) + 32(6)/20 = 41.6 \text{ kips}$$

Lane: (AASHTO 3.6.1.2.2)

$$V_A^{Ln} = 0.5(0.64)(20) = 6.4 \text{ kips}$$

Tandem: (AASHTO 3.6.1.2.2)

$$V_A^{Ta} = 25 + 25(16)/20 = 45 \text{ kips}$$

Impact factor = 1.33, not applied to design lane load

$$V_{LL+IM} = 45(1.33) + 6.4 = 66.25 \text{ kips}$$

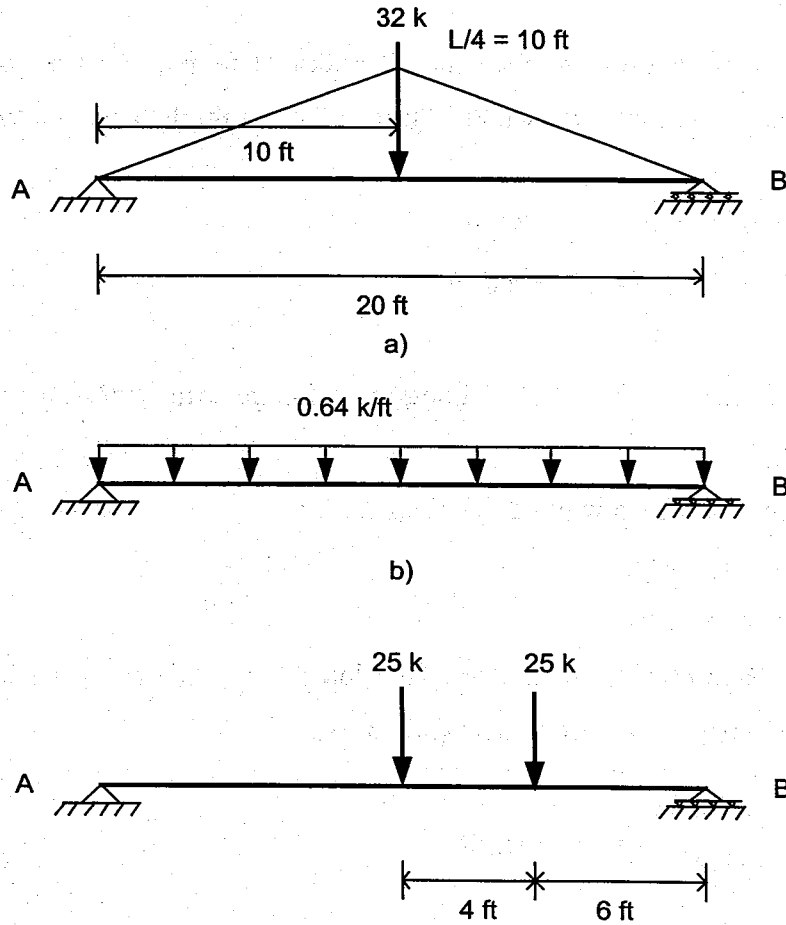

Figure 3.8 Live load placement for maximum reaction in approach slab: a) design truck, b) design tandem truck and c) design truck

Maximum bending moment at midspan Axle loads (Fig. 3.8)

Truck:

$$M_A^{Tr} = 5(32) = 160 \text{ k-ft}$$

Lane:

$$M_A^{Ln} = 0.64(0.5)(5)(20) = 32 \text{ k-ft Tandem:}$$

$$M_A^{Ta} = 5[25 + 25(6)/10] = 200 \text{ k-ft}$$

Impact factor = 1.33, not applied to design lane load

$$M_{LL+IM} = 200(1.33) + 32 = 298 \text{ k-ft}$$

Live load force effects

i) Interior strip: Shear and moment per ft width of strip is critical for multiple lanes loaded because one-lane live load strip width is greater than multiple lanes loaded. (133 in. > 127 in.)

$$V_{LL+IM} = 66.25 / (127/12) = 6.26 \text{ kip/ft} \quad M_{LL+IM} = 298 / (127/12) = 28.16 \text{ k-ft/ft}$$

ii) Edge strip: (AASHTO 4.6.2.1.4) Longitudinal edge strip width for a line of wheels is equal to the following

$$= 12 \text{ in.} + 0.5 \text{ strip width} \leq \text{full strip or } 72 \text{ in.}$$

$$= 12 + 0.5(127)$$

$$= 75.5 \text{ in.} > 72 \text{ in.}$$

Because strip width is limited to 72 in., one-lane loaded (wheel line = 0.5 lane load) with a multiple presence factor of 1.2 will be critical (Fig. 3.9)

$$V_{LL+IM} = \frac{\frac{1}{2}(66.25)(1.2)}{(72/12)} = 6.625 \text{ kip/ft}$$

$$M_{LL+IM} = \frac{\frac{1}{2}(298)(1.2)}{(72/12)} = 29.8 \text{ k-ft/ft (72/12)}$$

Interior and edge strips almost have the same values of shear and moment and therefore, the values from edge strip are used in design in the calculation.

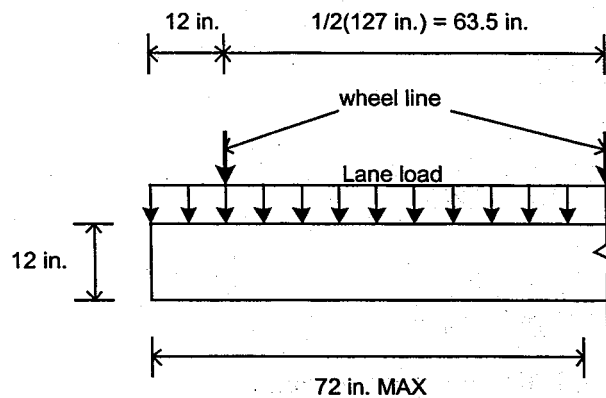

Figure 3.9 Live load placement for edge strip shear and moment for approach slab

C. Design, load

Dead load per 1 ft width

$$DC = 0.150(1)(1) = 0.150 \text{ kip/ft}^2$$

Factored dead load:

$$\gamma DC = 1.25(0.150) = 0.188 \text{ kip/ft}^2$$

Shear and moment for factored dead load are calculated as follows:

$$\Gamma V_{DC} = 0.188 (20)/2 = 1.88 \text{ kips/ft}$$

$$\gamma M_{DC} = 0.188 (20^2)/8 = 9.40 \text{ k-ft/ft}$$

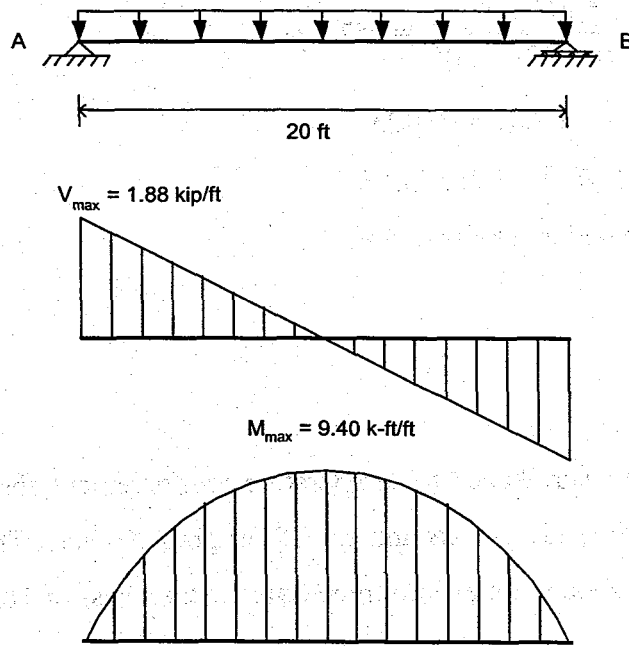

Figure 3.10 Shear and bending moment diagrams for factored dead load

Factored live load and impact load:

$$\gamma V_{LL+IM} = 1.75(6.25) = 10.94 \text{ kips/ft}$$

$$\gamma M_{LL+IM} = 1.75(29.8) = 52.15 \text{ k-ft/ft}$$

The design shear and moment are obtained as the summation of factored live load and dead loads. Fig. 3.10 is shear and bending moment diagrams of factored dead load.

$$\text{Total factored shear} = 1.88 + 10.94 = 12.82 \text{ kips/ft}$$

$$\text{Total factored moment} = 9.40 + 52.15 = 61.55 \text{ k-ft /ft}$$

D. Design of reinforcement

Main reinforcement

$$M_{\max} = 61.55 \text{ k-ft/ft}$$

Using $f'_c = 5,000 \text{ psi}$, $f_y = 60,000 \text{ psi}$

$$\text{Required } R_n = \frac{M_u}{\phi b d^2} = \frac{61.55(12,000)}{0.90(12 - 2.5)^2} = 757.8 \text{ psi}$$

From Fig. 3.11 for $R_n = 757.8 \text{ psi}$, $\rho_{\min} = 0.0125$

$$A_s = \rho b d = 0.0125(12)(9.5) = 1.425 \text{ in.}^2/\text{ft}$$

Use #10 @ 10.5 in. center to center ($A_s = 1.45 \text{ in}^2/\text{ft}$)

Transverse reinforcement

The reinforcement for shrinkage and temperature reinforcement should not be less than 0.002 times the gross area for grade 40 bars and 0.0018 for grade 60 bars. The maximum spacing of the tension reinforcement should not exceed three times the thickness or 18 in. (ACI-7.12.2.2)

$$A_s = \rho b d = 0.0018(12)(9.5) = 0.20 \text{ in}^2$$

Use #5 @ 18 in. center to center ($A_s = 0.21 \text{ in}^2/\text{ft}$)

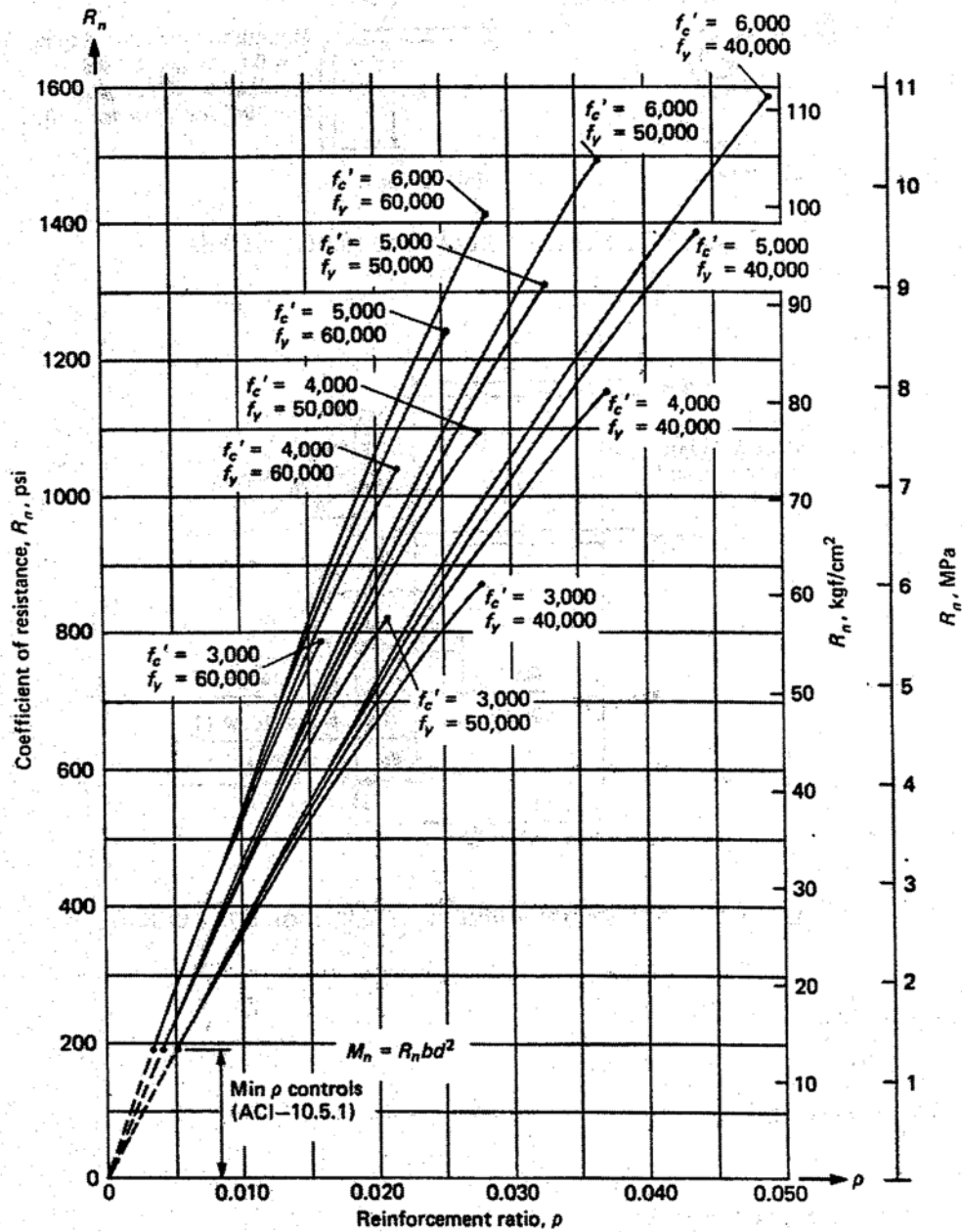

Figure 3.11 Strength curve (R_s vs ρ) for singly reinforced rectangular sections. Upper limit of curves is at $0.75 \rho_b$. (Wang and Salmon, 1997)

Hook embedment

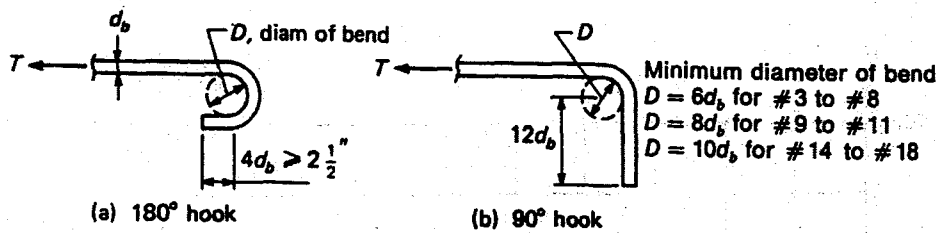

Figure 3.12 Standard hook embedment details

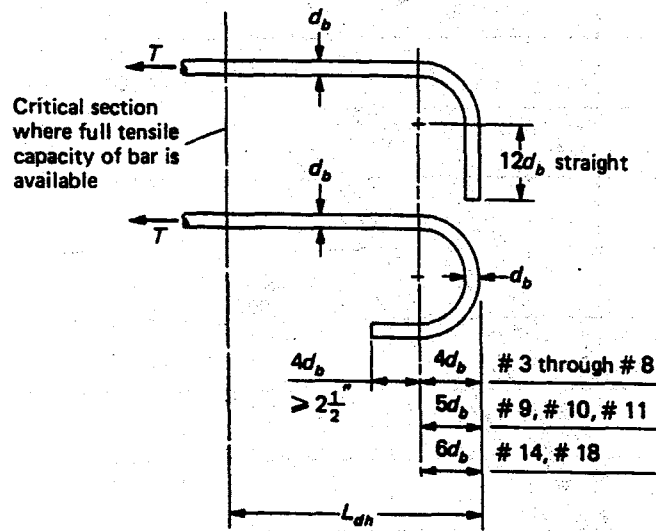

Figure 3.13 Development length L_{dh} for hook embedment

$$l_{hb} = 1200 \frac{d_b}{\sqrt{f'_c}}$$

$$l_{hb} = \lambda l_{hb} > 6d_b \text{ or } 6 \text{ in.}$$

where d_b = diameter of the hook bar

l_{hb} = basic development length for standard hook

l_{db} = total length

Using bar #9 for hook bar, $d_b = 1.128$ in.

$$l_{hb} = 1200 \frac{1.128}{\sqrt{5,000}} = 19.2 \text{ in.}$$

Using $\lambda = 1$

$$l_{db} = 19.5 \text{ in.}$$

Check $6d_b$; $6(1.128) = 6.768 \text{ in.} < l_{db}$

$$12d_b = 12(1.128) = 13.5 \text{ in.}, \quad \text{Using } l_{db} = 30 \text{ in.}$$

Check diameter of bent, D

For Fig. 3.12a, $D = 5d_b$ for reinforcement bar #9, #10 and #11

$$D = 5(1.128) = 5.64 \text{ in.}$$

The final design for hook embedment is shown in Fig. 3.14. Details of reinforcement in the approach slab are shown in Fig. 3.15.

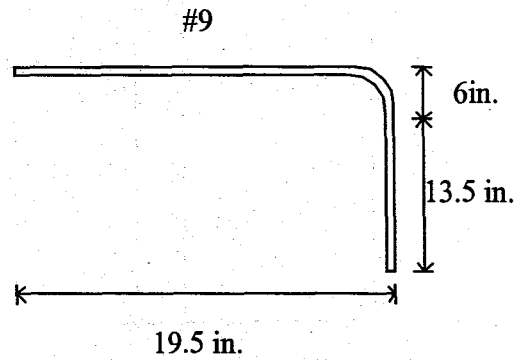

Figure 3.14 Design of hook embedment

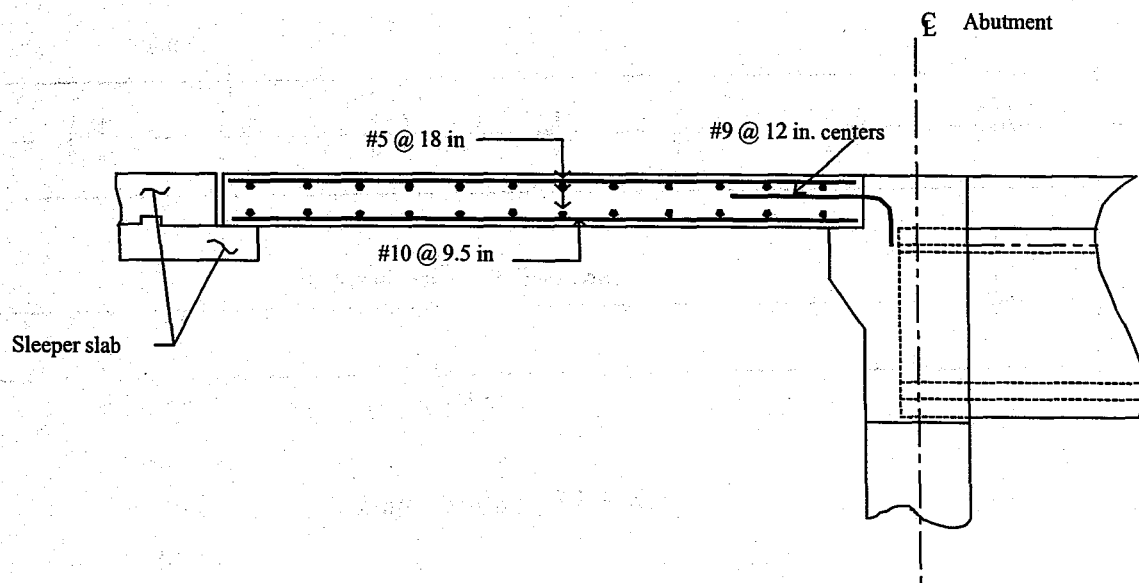

Figure 3.15 Reinforcement details of approach slab

3.4 Pile Foundation for Abutment

Primary design dimensions of abutment are shown in Fig. 3.16 and abutment plan given in Fig. 3.17. Details of abutment are discussed in section 3.4.

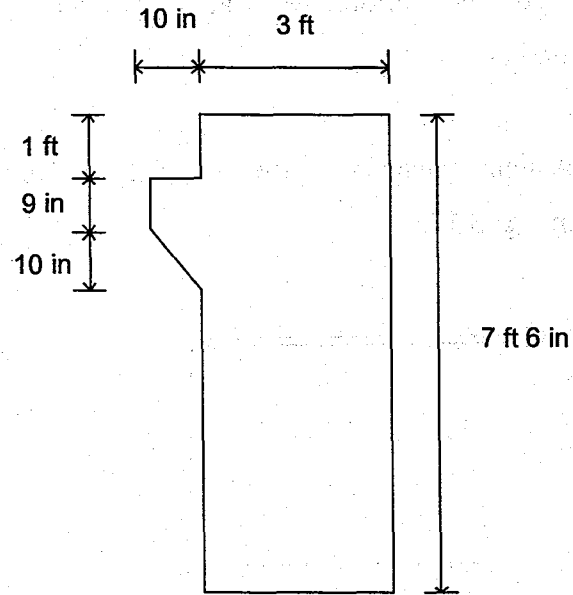

Figure 3.16 Abutment dimensions

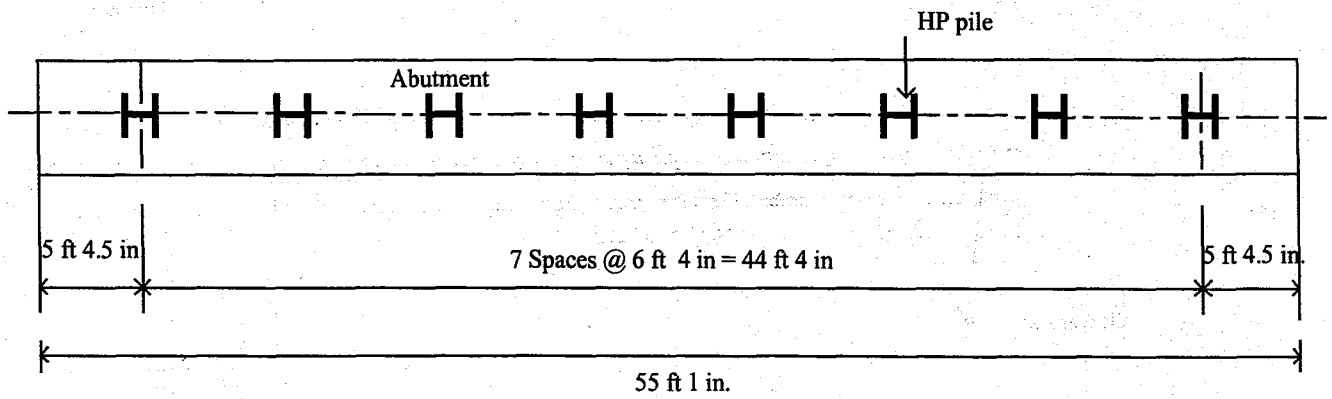

Figure 3.17 Abutment plan

A. Load on each pile

Load per pile can be determined from the following:

i) Dead load from end span

From section 3.1 B:

Dead load: DC = 9.602 kip/ft

DW = 1.455 kip/ft

Factored dead load: $\gamma_{DC} = 1.25(9.602) = 12.003$ kip/ft

$\gamma_{DW} = 1.50(1.455) = 2.182$ kip/ft

Factored dead load from each of girder at the abutment:

Due to DC = $12.003(30)/7 = 51.44$ kips

Due to DW = $2.182(30)/7 = 9.35$ kips

Total load on each girder = $51.44 + 9.35 = 60.79$ kips

SAP2000 is used to determine reactions at piles. Total load on each girder and reaction at piles are shown in Fig.3.18. Table 3.1 is a summary of factored DC and DW loads on piles.

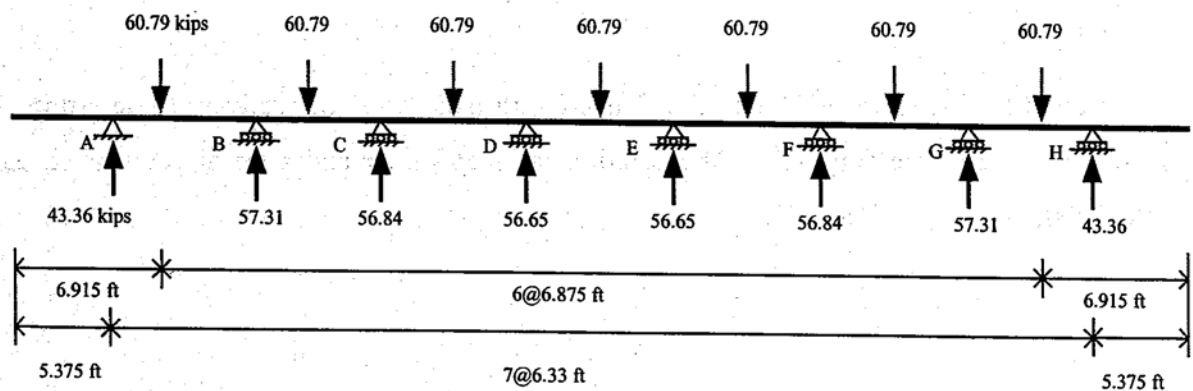

Figure 3.18 Dead load from girders and pile reactions

Table 3.1 Summary of factored loads of DC and DW load on piles (kips)

Pile	A	B	C	D	E	F	G	H
γ (DC + DW)	43.36	57.36	56.84	56.65	56.65	56.84	57.31	43.36

ii) Live load

The reaction at end span is determined from a set of wheels of the truck placed in the longitudinal direction of span. (Fig. 3.19)

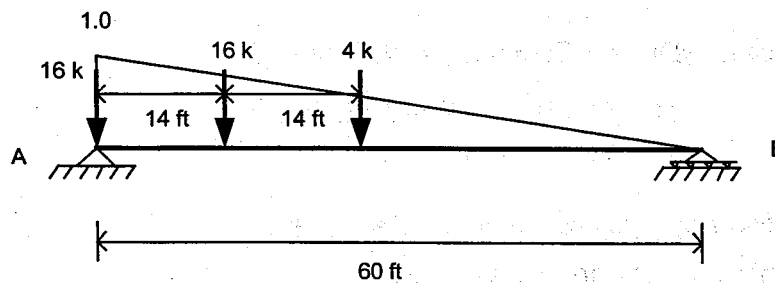

Figure 3.19 Live load placement for maximum reaction at end span
(Abutment is located at A)

$$\begin{aligned} \text{Reaction at abutment due to live load on end span, } R_A &= 16 + 16(46/60) + 4(32/60) \\ &= 30.4 \text{ kips} \end{aligned}$$

Place the wheel exterior of the axle 2 ft from curb and center of roadway to determine the reaction of the girder (Fig.3.20). The reactions at each girder and piles are calculated using SAP2000, and shown in Fig. 3.21.

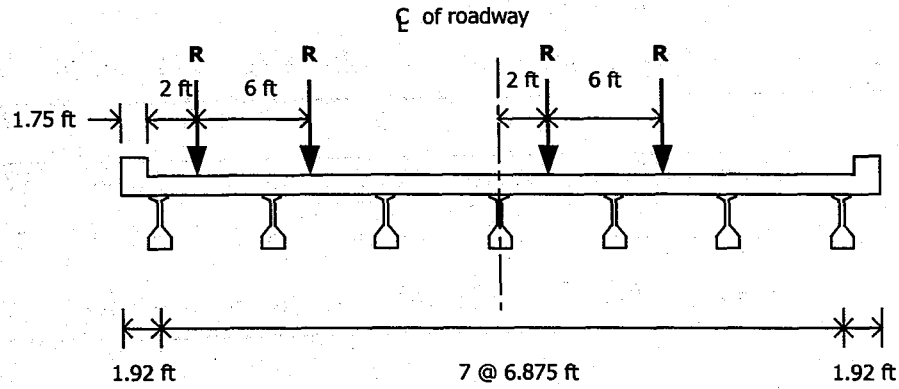

Figure 3.20 Live load on abutment

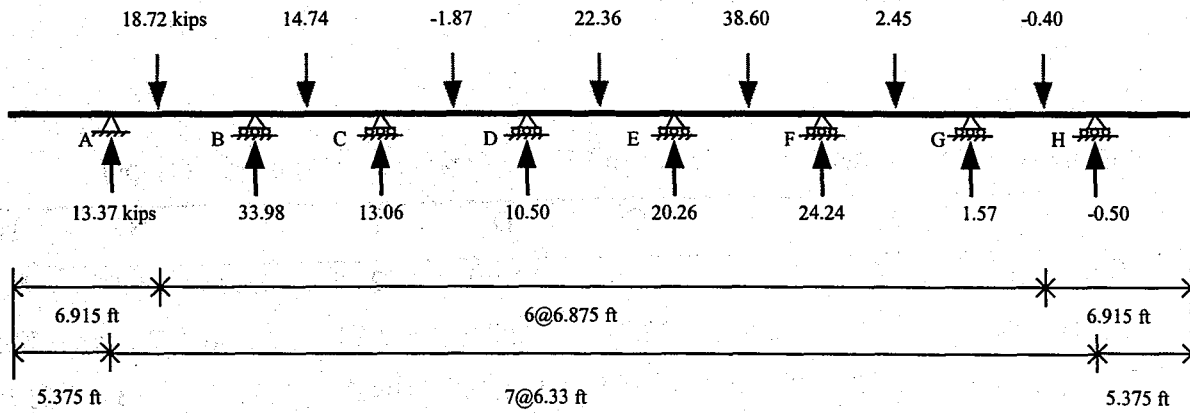

Figure 3.21 Live load from girders and pile reactions

Impact = 1.33, and load factored for live load, $\gamma = 1.75$

Table 3.2 Summary of live load on piles (kips)

Pile	A	B	C	D	E	F	G	H
LL	13.37	33.90	13.06	10.50	28.26	24.24	1.57	-0.50
LL+IM	17.78	45.09	17.37	13.97	37.59	32.24	2.09	-0.66
$\gamma(LL + IM)$	31.12	78.90	30.40	24.44	65.78	56.42	3.65	-1.16

iii) Total factored load from end span

Table 3.3 Summary of factored loads due to DC, DW and (LL+ IM) on piles (kips)

Pile	A	B	C	D	E	F	G	H
γ (DC + DW)	43.36	57.36	56.84	56.65	56.65	56.84	57.31	43.36
γ (LL + IM)	31.12	78.90	30.40	24.44	65.78	56.42	3.65	-1.16
Total	74.48	136.21	87.24	81.09	122.43	113.26	60.96	42.2

iv) Factor load from approach slab

Factored load from approach slab is 12.82 kip/ft (Section 3.3C).

Total load = $12.82(45.08) = 577.92$ kips

Load per one pile = $577.92/8 = 72.24$ kips

v) Load on pile

Table 3.4 Summary of factored loads due to DC, DW and (LL+ IM) on piles (kips)

Pile	A	B	C	D	E	F	G	H
End span	74.48	136.21	87.24	81.09	122.43	113.26	60.96	42.2
Approach slab	72.24	72.24	72.24	72.24	72.24	72.24	72.24	72.24
Total (kips)	146.72	208.45	159.48	153.33	194.67	185.5	133.2	114.44

Maximum reaction on pile at abutment = 208.45 kips.

B. Minimum pile length

Fig. 3.22 shows the soil strata. The minimum pile length required is based on the skin friction capacity of the pile. The cc-method based on total stress, is used to determine skin resistance. (AASHTO 10.7.3.3.2a) An BP14 x 117 is assumed in the design.

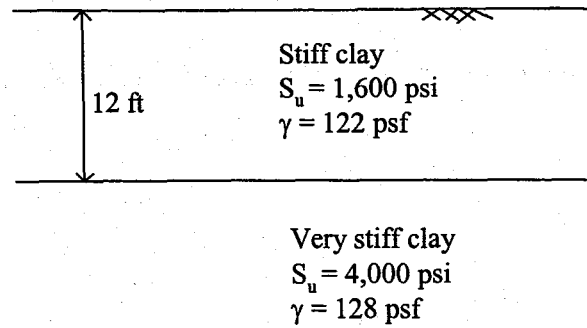

Figure 3.22 Soil strata below abutment

Section properties of HP14 x 17;

$A = 34.40 \text{ in}^2$	$d = 14.21 \text{ in.}$
$t_w = 0.805 \text{ in.}$	$b_f = 14.885 \text{ in.}$
$t_f = 0.805 \text{ in.}$	$I_y = 443.00 \text{ in.}^4$
$S_y = 59.50 \text{ in.}^3$	$r_y = 3.59 \text{ in.}$
$Z_y = 91.40 \text{ in}^3$	$h = 11.25 \text{ in.}$

Skin friction; α -Method

$$q_s = \alpha S_u$$

where f = nominal skin friction

α = adhesion factor

S_u = mean undrained shear strength

Sand layer

Skin friction on predrilled hole filled hole with medium sand layer is neglected.

Stiff clay layer

Since the top of stiff clay layer is filled with medium sand, adhesion factor obtained from Fig 3.24a for $L = \text{less than } 10B$. [$8(12) < (10)14.21$] and $S_u = 1.6 \text{ kip/ft}^2$, $\alpha = 1$.

Skin friction of stiff clay per 1 ft of pile Friction capacity = $f(L_p)$ (L_p = perimeter)

$$\begin{aligned} QS &= \alpha S_u(L_p) \\ &= 1 (1.6) [(14.21/12) + (14.885/12)] (2) \\ &= 7.76 \text{ kip/ft} \end{aligned}$$

Very stiff clay layer

Fig. 3.24b is used for finding α for this layer with $S_u = 4.0 \text{ kip/ft}^2$ and $10B < L < 20B$:

When $L = 10B$; $\alpha = 0.23$

$L = 20B$ $\alpha = 0.53$

L is assumed to be 23 ft

Thus,

$$L = 23 / B = 23(12) / 14.21 = 18.8$$

$$L \approx 20 B$$

Hence the value of $\alpha = 0.53$.

Calculate skin friction of stiff clay per 1 ft of pile

$$\begin{aligned} Q_s &= \alpha S_u (L_p) \\ &= 0.53(1.6)[(14.21/12)+(14.885/12)](2) \\ &= 10.28 \text{ kip/ft} \end{aligned}$$

The length of the embedment (neglecting bearing capacity), l_2 (Fig 3:23), into the very stiff clay is estimated by using resistance factor (AASHTO 1998, Table 10.5.5-2) $\gamma = 0.7$

$$\Phi Q_n = \Phi_{qs} \Sigma Q_s$$

$$208.45 = 0.7(7.76)(8) + 0.7(10.28)(12) (l_2)$$

$$l_2 = 22.93 \text{ ft}$$

Using $l_2 = 23 \text{ ft}$, then the total length of pile is $23 + 8 + 8 = 39 \text{ ft}$.

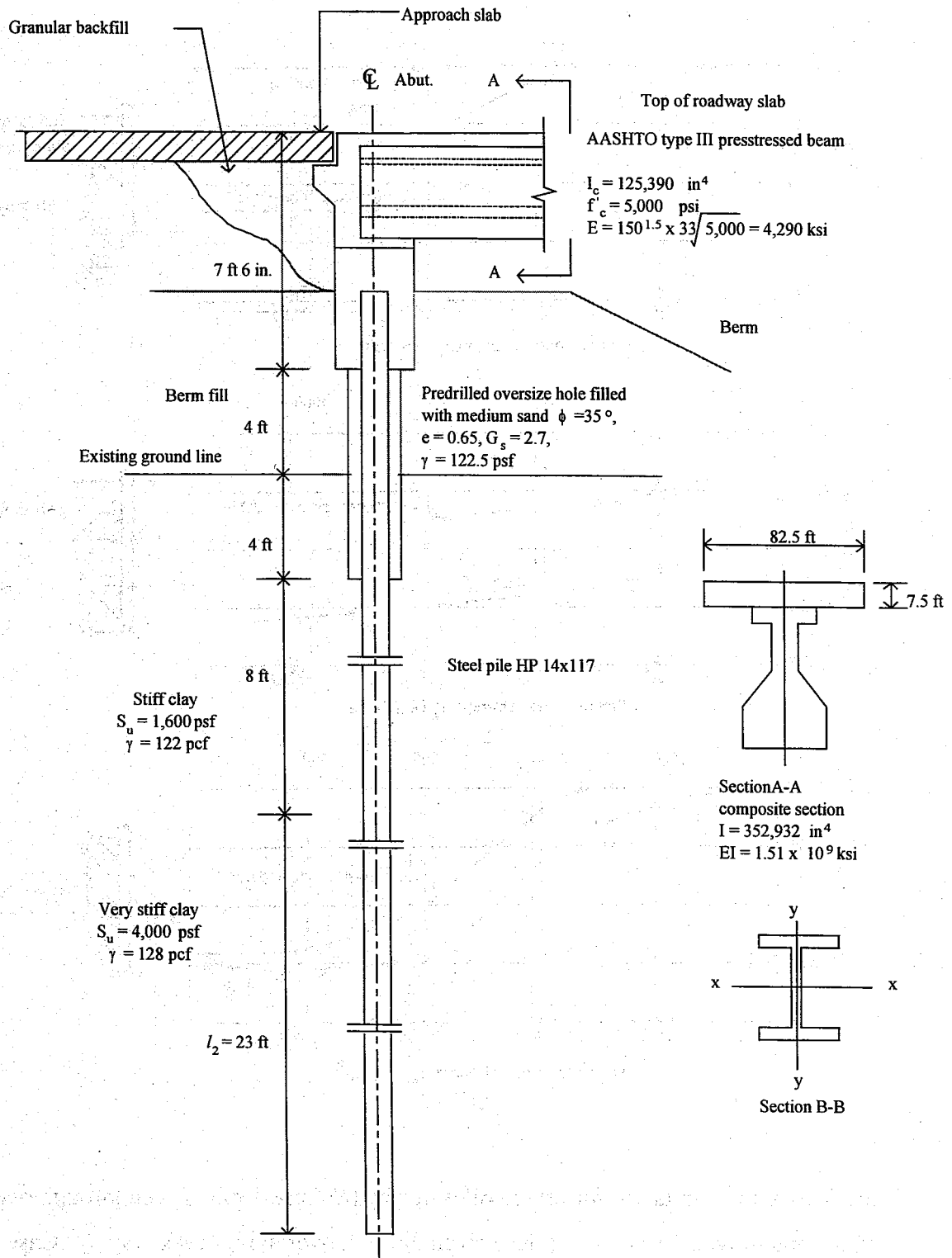

Figure 3.23 Section through abutment and soil profile

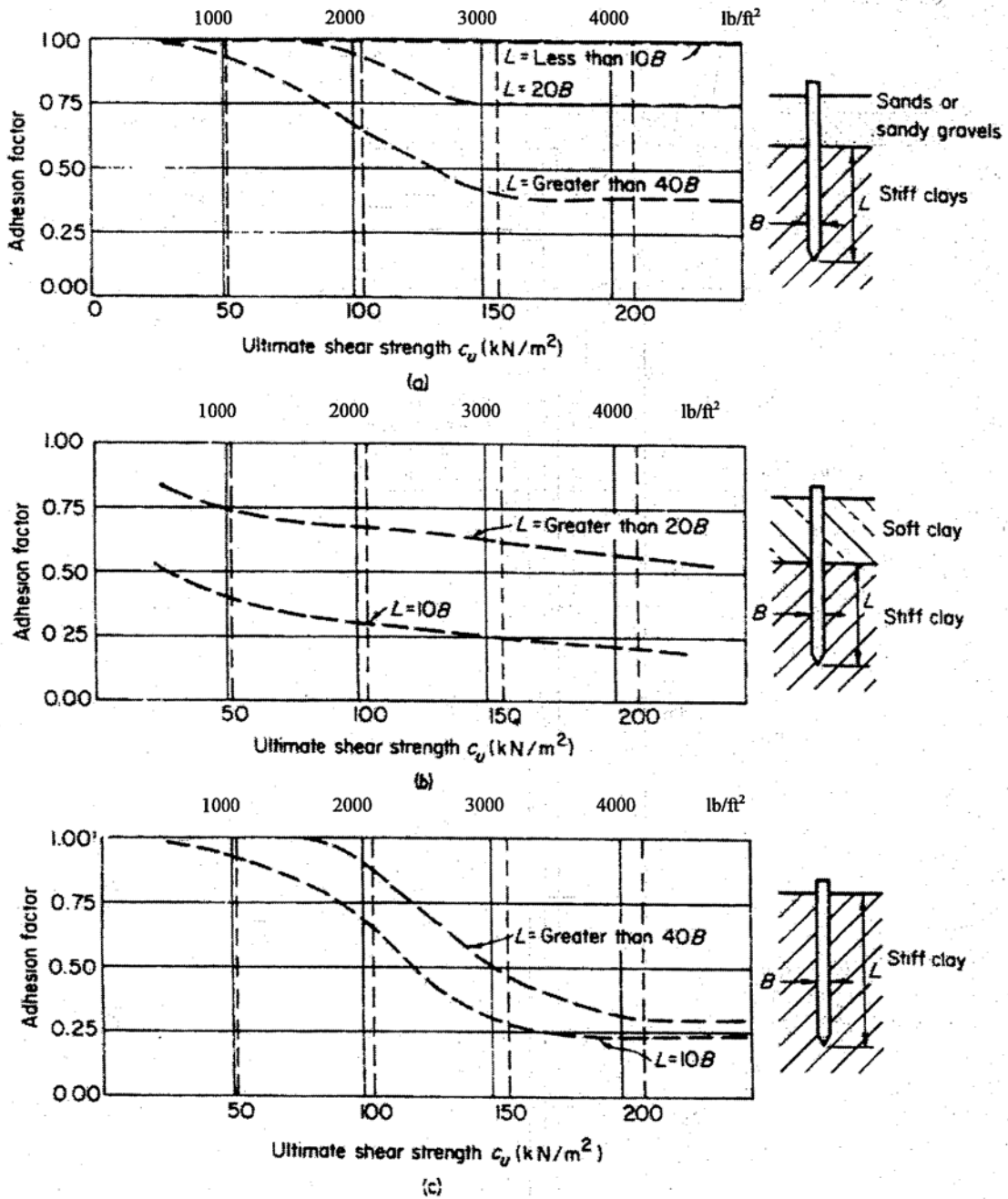

Figure 3.24 Adhesion factor for driven piles in clay (a) Case 1: pile driven through overlying sand or sand gravels. (b) Case 2: piles driven through overlying weak clay. (c) Case 3: piles without different overlying strata. (Tomlinson, 1995)

C. P-Y curve analysis

Medium sand

$$k_h = \frac{J\gamma x}{1.35} = \frac{600(122.5 - 62.4)8}{1.35} = 213,688.9 \text{ lb/ft}^2$$
$$= 213.7 \text{ kip/ft}^2$$

Stiff clay

The smaller of the following is taken as P_u .

$$P_u = 9S_u B$$

$$= 9(1.6)(14.21/12)$$

$$= 17.05 \text{ kip/ft}$$

$$P_u = \left(3 + \frac{\gamma}{S_u} x + \frac{0.5}{B} x \right) S_u B$$

$$= \left[3 + \frac{(122 - 62.4)16}{1,600} + \frac{0.5(16)}{14.21/12} \right] (1.6)(14.21/12)$$

$$= (3 + 0.60 + 6.76) 1.895$$

$$= 19.61 \text{ kip/ft}$$

Thus $P_u = 17.05 \text{ kip/ft}$

$$y_{50} = 2.5B\varepsilon_{50}$$

$$= 2.5(14.21/12)(0.01)$$

$$= 0.0296$$

$$k_h = \frac{P_u}{y_{50}} = \frac{17.05}{0.0296} = 576 \text{ kip/ft}^2$$

D. Equivalent cantilever length of pile

Case I) Medium sand in predrilled hole

Equivalent uniform soil stiffness (k_e):

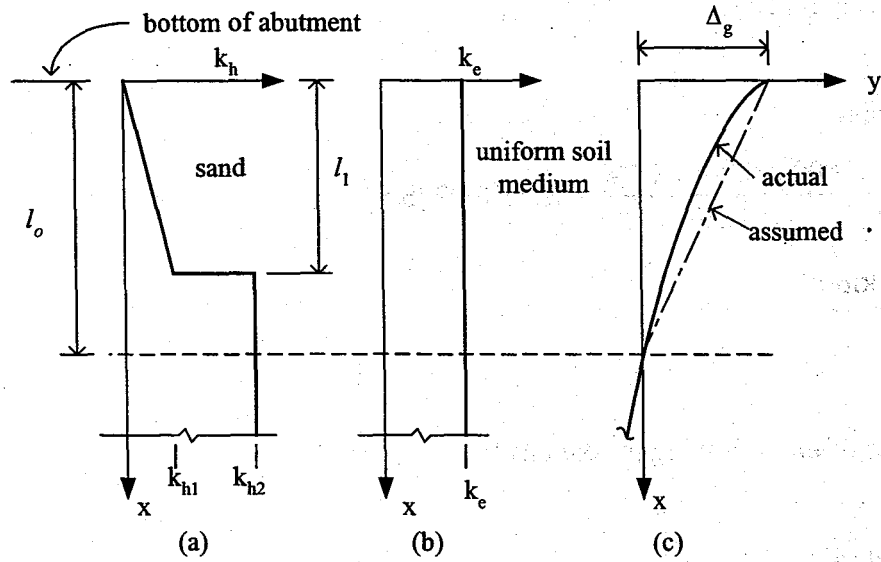

Figure 3.25 Horizontal soil stiffness and displacement: (a) the variation of horizontal soil stiffness with depth, (b) an approximation of existing soil stiffness, (c) the displaced shape

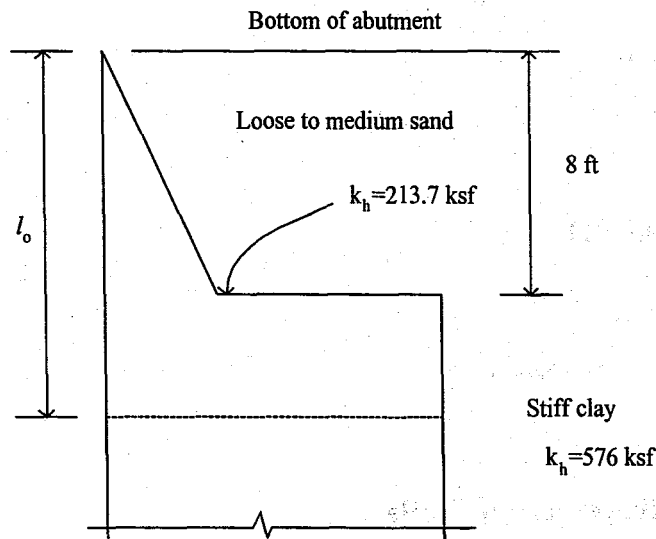

Figure 3.26 Soil stiffness

Step 1: Assume

$$k_e = 83 \text{ ksf} = 0.576 \text{ ksi}$$

Step 2: Calculate l_o

$$l_o = 2\sqrt[4]{EI/k_e}$$

$$l_o = 2\sqrt[4]{\frac{29,000(443)}{0.576}}$$

Step 3: Calculate I_k

$$\text{With } l_2 = 11.45 - 8 = 3.45 \text{ ft}$$

$$I_k = I_{k1} + I_{k2}$$

$$= k_1 \left[\frac{d^3}{36} + \frac{d}{2} \left(a + \frac{2d}{3} \right)^2 \right] + k_2 \left[\frac{d^3}{36} + \frac{d}{2} \left(a + \frac{d}{3} \right)^2 \right] + k \left[\frac{d^3}{12} + dc^2 \right]$$

$$= 0 + 213.7 \left[\frac{8^3}{36} + \frac{8}{2} \left(3.45 + \frac{8}{3} \right)^2 \right] + 576 \left[\frac{3.45^3}{12} + 3.45(1.725)^2 \right]$$

$$= 35,036.49 + 7,892.92$$

$$= 42,929.41 \text{ k-ft}$$

Step 4: Determine k_e

$$k_e = \frac{3I_k}{l_o^3}$$

$$= \frac{3(42,929.41)}{(11.45)^3}$$

$$= 85.76 \text{ ksf}$$

$$= 0.596 \text{ ksi}$$

Second Iteration

Step 2: Calculate l_o

$$l_o = 2\sqrt[4]{\frac{29,000(443)}{0.596}}$$

$$= 136.30 \text{ in.}$$

$$=11.36 \text{ ft}$$

Step 3: Calculate I_k

With $l_2 = 3.36 \text{ ft}$

$$I_k = 0 + 213.7 \left[\frac{8^3}{36} + \frac{8}{2} \left(3.36 + \frac{8}{3} \right)^2 \right] + 575.78 \left[\frac{3.36^3}{12} + 3.36(1.68)^2 \right]$$

$$= 34,069.68 + 7,271.04$$

$$= 41,340.72 \text{ k-ft}$$

Step 4 Determine k_e

$$k_e = 3(41,340.72)_{\cdot}(11.36)^3$$

$$= 84.63 \text{ ksf}$$

Step 5 The converged value, $k_e = 85 \text{ ksf} = 0.590 \text{ ksi}$

Critical length

The critical length parameter is:

$$L_c = 4 \left(\sqrt[4]{\frac{EI}{k_h}} \right)$$

$$= 4 \left(\sqrt[4]{\frac{29,000(443)}{0.590}} \right)$$

$$= 273.21 \text{ in.}$$

$$= 22.77 \text{ ft}$$

Fixed pile head is assumed and Fig. 3.27 shows cantilever idealization of a fixed-headed pile.

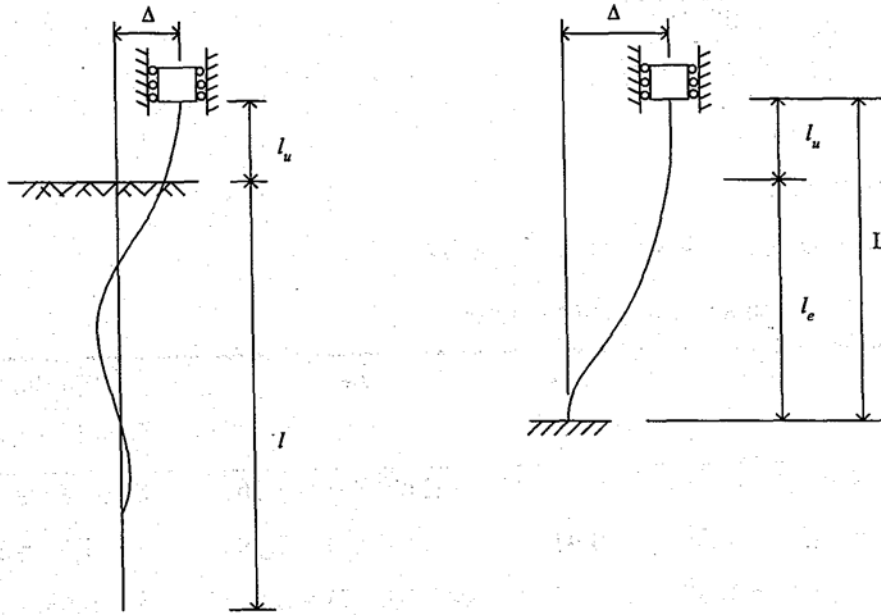

Figure 3.27 Cantilever idealization of a fixed-headed pile

In the first time, l_u is taken equal to 0. In that case, the total length, L , equals to l_e . For finding the values of l_e , the graph in Fig. 2.5 is used.

Table 3.5 Total equivalent cantilever length

	L_u/L_c	L_e/L_c (Fig. 2.4)	L_e (ft)	Total length ($L = L_u + L_e$) (ft)
Stiffness	0	0.50	0.5 (22.77) = 11.38	0 + 11.38 = 11.38
Moment	0	0.60	0.6 (22.77) = 13.66	0 + 13.66 = 13.66
Buckling	0	1.10	1.1 (22.77) = 25.04	0 + 25.04 = 25.04

Case II) Neglect medium sand in predrilled hole

$$L_e = 4 \left(\sqrt[4]{\frac{EI}{k_h}} \right)$$

$$= 4 \left(\sqrt[4]{\frac{29,000(443)}{576/144}} \right)$$

$$= 169.33 \text{ in.}$$

$$= 14.11 \text{ ft}$$

Equivalent cantilever, L_e is shown in Table 3.6.

Table 3.6 Total equivalent cantilever length

	L_u/L_c	L_e/L_c (Fig 2.4)	L_e (ft)	Total length ($L = L_u + L_e$) (ft)
Stiffness	$8/14.11 = 0.59$	0.38	$14.11(0.38) = 5.36$	$8 + 5.36 = 13.36$
Moment	$8/14.11 = 0.59$	0.41	$14.11(0.41) = 5.79$	$8 + 5.79 = 13.79$
Buckling	$8/14.11 = 0.59$	0.47	$14.11(0.47) = 6.63$	$8 + 6.63 = 14.63$

The smaller value out of the two cases I and II is used to determine the moment and horizontal force.

$$L_{\text{stiffness}} = 11.38 \text{ ft or } 137 \text{ in.}$$

$$L_{\text{moment}} = 13.66 \text{ ft or } 164 \text{ in.}$$

$$L_{\text{buckling}} = 14.63 \text{ ft or } 176 \text{ in.}$$

E. Plastic analysis

Plastic moment about weak axis

$$M_p = Z_y F_y$$

$$= 91.40 (36)$$

$$= 3,290.4 \text{ k-in.}$$

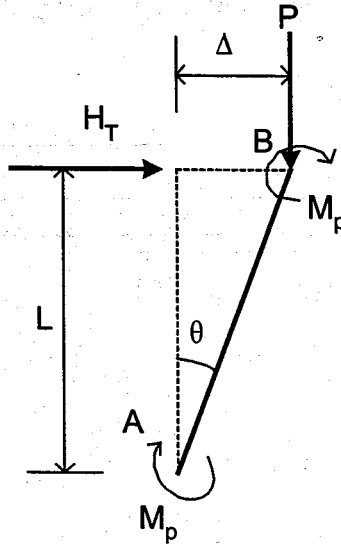

Figure 3.28 Free body diagram for lateral displacement of pile

Pile AB has displacement equal to Δ due to lateral force H_T .

$$\Delta = L \tan\theta$$

Since θ is very small,

$$\tan\theta = \theta$$

$$\Delta = L\theta$$

Using principle of virtual work,

External work = Internal work

$$H_T (\Delta) = (M_p \theta) + (M_p \theta)$$

$$H_T L\theta = 2M_p \theta$$

$$H_T = \frac{2M_p}{L_{stiffness}}$$

$$= \frac{2(3,290.4)}{137}$$

$$= 48.2 \text{ kips}$$

F. Structural analysis of bridge pile-soil system for gravity loads

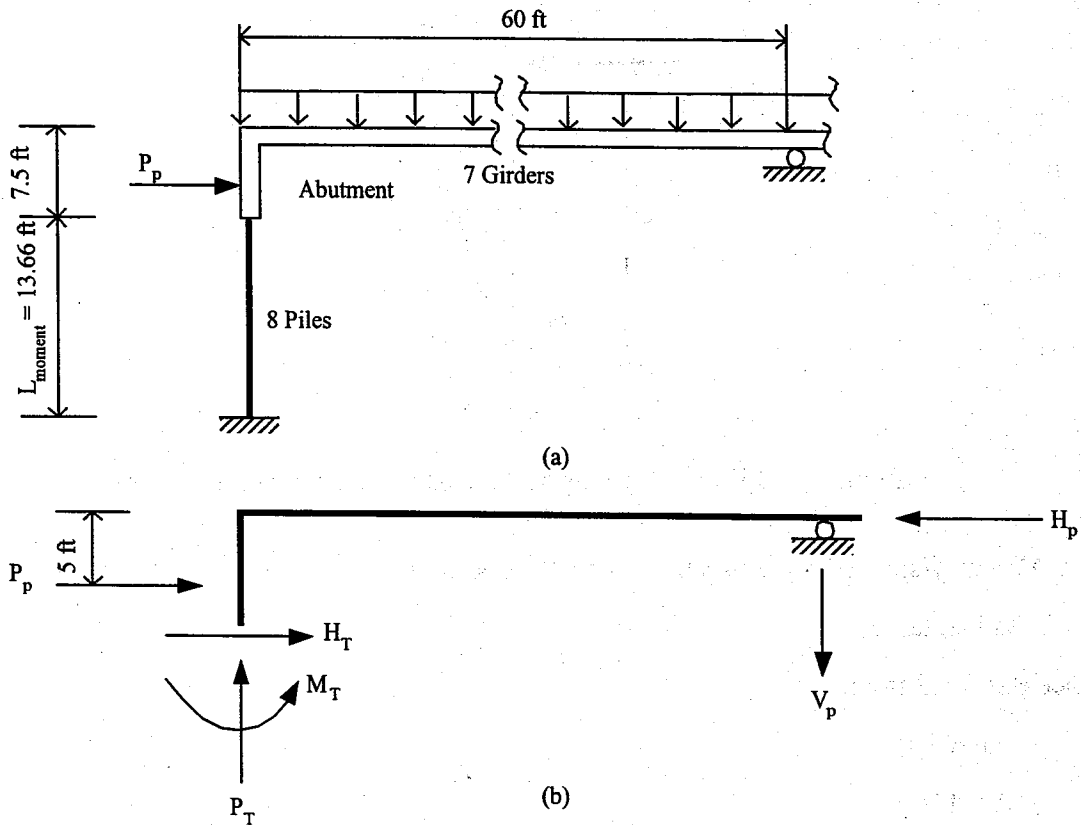

Figure 3.29 Idealized abutment foundation and girder endspan: (a) approximate structural model (b) free body diagram with passive soil pressure

Maximum reaction at girder due to factored self weight of superstructure, live load and impact is calculated by the following:

$$\gamma_{DC} \text{ of deck slab + parapet} = 1.25(3.87 + 0.41 + 1.0 + 0.23)30 = 206.62 \text{ kips}$$

$$\gamma_{DW} = 1.5[1.45(30)] = 65.25 \text{ kips}$$

Factored dead load per girder

$$\gamma_{DC} + \gamma_{DW} = (206.62 + 65.25)n = 38.84 \text{ kips}$$

$$\gamma_{(LL + IM)} = 1.75[1.33(38.60)] = 89.84 \text{ kips}$$

$$\text{Total load} = 38.84 + 89.84 = 128.68 \text{ kips}$$

The rotation at the left end is

$$\begin{aligned}\theta_w &= \frac{WL_E^2}{24EI} \\ &= \frac{128.68[60(12)]^2}{24(4,290)(359,932)} \\ &= \frac{6.67 \times 10^7}{3.70 \times 10^{10}} \\ &= 0.0018 \text{ rad}\end{aligned}$$

Since the top of the pile is rigidly connected to the integral abutment, the pile will rotate by θ_w . Then, the induced moment, M_w , in the equivalent cantilever due to vertical load is

$$\begin{aligned}M_w &= \left[\frac{4EI}{L_{moment}} \right] \theta_w \\ &= \frac{4(29,000)(443)}{164} (0.0018) \\ &= 564.01 \text{ k-in}\end{aligned}$$

G. Analysis for temperature drop and shrinkage

The horizontal displacement at each abutment due to temperature and shrinkage effect is 0.735 in. (section 3.2) and the moment induced by the lateral displacement at the top of the pile is:

$$\begin{aligned}M_T &= \frac{6E_p I_p \Delta}{L_{moment}^2} \\ &= \frac{6(29,000)(443)(0.735)}{(164)^2} \\ &= 2,108.36 \text{ k-in}\end{aligned}$$

M_T cannot exceed the plastic moment capacity of the pile, M_p and therefore $M_T = 1,906.2$ k-in.

The corresponding horizontal force is:

$$\begin{aligned} H_T &= \frac{12EI\Delta}{L_{stiffness}^3} \\ &= \frac{12(29,000)(443)(0.735)}{(137)^2} \\ &= 44.4 \text{ kip} \end{aligned}$$

H_T cannot exceed 48.2 kips, which is the shear force associated with plastic moment when L equals 137 in. Hence $H_T = 44.4$ kips.

A horizontal force is induced on the back of the abutment as the bridge expands. This force can be estimated conservatively as the passive resistance of the soil behind the abutment, P_p . Passive soil pressure for a granular material is calculated as

$$P_p = \frac{1}{2} \gamma H^2 K_p$$

where

P_p = passive soil pressure,

γ = soil unit weight,

H = height of abutment,

K_p = Rankine passive earth pressure coefficient,

$$= \tan^2\left(45 + \frac{\phi}{2}\right)$$

$$= 3.69$$

$$P_p = \frac{1}{2} (0.13)(7.5)^2 (3.69)$$

$$= 13.49 \text{ kip/ft}$$

Total passive soil pressure per pile (pile spacing = 6.33ft)

$$P_p = 13.49(6.33) = 85.4 \text{ kips}$$

Assuming that the bridge, girder end span is simply supported, the axial force in the pile, P_T , is found by summing moments about the right end (Fig.3.29b). Induced axial compression in the pile is determined from

$$P_T (60) = P_p(5) + H_T(7.5) + M_T$$

$$P_T (60) = 85.4(5) + 44.4(7.5) + 2,108.36/12$$

$$P_T = 15.60 \text{ kips}$$

The total induced axial compression in the pile is the summation of the factored load and axial force in pile due to temperature.

$$P = 208.45 + 15.60$$

$$P = 224.05 \text{ kips}$$

H. Capacity of pile as a structural member

Combined axial compression and flexure (AASHTO 1998, 6.9.2.2).

For $\frac{P_u}{\phi P_n} \geq 0.2$,

$$\frac{P_u}{\phi P_n} + \frac{8}{9} \left[\frac{M_{ux}}{\phi_b M_{nx}} + \frac{M_{uy}}{\phi_b M_{ny}} \right] \leq 1.0$$

For $\frac{P_u}{\phi P_n} < 0.2$

$$\frac{P_u}{2\phi P_n} + \left[\frac{M_{ux}}{\phi_b M_{nx}} + \frac{M_{uy}}{\phi_b M_{ny}} \right] \leq 1.0$$

P_n = nominal compressive resistance

If $\lambda \leq 2.25$, then $F_{cr} = (0.66^\lambda) F_y$

If $\lambda > 2.25$, then $F_{cr} = \frac{0.88 F_y}{\lambda}$

Where

$$\lambda = \left[\frac{KL}{r\pi} \right]^2 \frac{F_y}{E}$$

The effective length factor, K (AISC, 1998, Table C-2) is taken as 0.65 and L = L_{buckling}.

$$\begin{aligned}\lambda &= \left[\frac{0.66(176)}{3.59\pi} \right]^2 \frac{36}{29,000} \\ &= 0.131 < 2.25\end{aligned}$$

$$\begin{aligned}P_n &= A_g F_{cr} \\ &= A_s (0.66^\lambda) F_y \\ &= 34.4 (0.66^{0.131}) (36) \\ &= 1,172.8 \text{ kip} \\ \Phi P_n &= 0.9 (1,172.8) = 1,055.53 \text{ kip}\end{aligned}$$

Alternative I

The induced axial compression in the pile is summation of the factored load per pile and axial force in pile due to temperature.

$$P_u = 208.45 + 15.60 = 224.05 \text{ kips}$$

Moment at the top of the pile is the summation of the moment due to vertical load' and temperature drop and shrinkage.

$$\begin{aligned}M_u &= M_w + M_T \\ &= 564.01 + 2,108.36 \\ &= 2,672.37 \text{ k-in.}\end{aligned}$$

Check HP 14x117 section for compactness:

Compact section $\lambda < \lambda_p$

Noncompact section $\lambda_p < \lambda \leq \lambda_r$

Where

λ = width to thickness ratio,

λ_p = upper limit for compact category

λ_r = upper limit for noncompact category

Table 3.7 Width- thickness parameters

Element	λ	λ_p	λ_r
Flange	$\frac{b_f}{2t_f}$	$\frac{65}{\sqrt{F_y}}$	$\frac{141}{\sqrt{F_y - F_r}}$
	Web	$\frac{h}{t_w}$	$\frac{640}{\sqrt{F_y}}$

Where

F_r = Compressive residual stress in flange (10 ksi for rolled shapes, 16.5 ksi for welded shapes)

Flange

$$\lambda = \frac{b_f}{2t_f} = \frac{14.885}{2(0.885)} = 9.25$$

$$\lambda_p = \frac{65}{\sqrt{F_y}} = \frac{65}{\sqrt{36}} = 10.83$$

$$\lambda_r = \frac{141}{\sqrt{F_y - F_r}} = \frac{141}{\sqrt{36 - 10}} = 27.65$$

Since $\lambda < \lambda_p$ the flange is compact.

Web

$$\lambda = \frac{h}{t_w} = \frac{11.25}{0.805} = 13.98$$

$$\lambda_p = \frac{640}{\sqrt{F_y}} = \frac{640}{\sqrt{36}} = 106.7$$

$$\lambda_r = \frac{970}{\sqrt{F_y}} = \frac{970}{\sqrt{36}} = 161.7$$

Since $\lambda < \lambda_p$, the shape (web) is compact. Moment capacity based on the compact section:

$$M_p = F_y Z_y = 3,290.4 \text{ k-in}$$

$$\Phi_b M_{ny} = 0.9(3,209.4)$$

$$= 2,961.36 \text{ k-in}$$

$$\frac{P_u}{\phi P_n} = \frac{224.05}{1,055.53} = 0.212 > 0.2$$

Then using

$$\frac{P_u}{\phi P_n} + \frac{8}{9} \left[\frac{M_{ux}}{\phi_b M_{nx}} + \frac{M_{uy}}{\phi_b M_{ny}} \right] \leq 1.0$$

$$0.212 + \frac{8}{9} \left[\frac{2,672.37}{2,961.38} \right] = 1.01 \approx 1 \text{ OK}$$

Then the section does satisfy the beam column interaction equation.

Alternative II

The induced axial compression in the pile is summation of the factored load per pile and axial force in pile due to temperature.

$$P_u = 208.45 + 15.60 = 224.05 \text{ kips}$$

The moment due to thermal expansion is for the fixed-head pile equal to $P\Delta/2$.

$$M_u = M_w + \frac{P\Delta}{2}$$

$$= 564.01 + 224.05(0.735)/2$$

$$= 646.35 \text{ k-in}$$

From the calculations in Alternative I:

$$\Phi P_n = 1,055.59 \text{ kip}$$

$$\Phi_b M_{ny} = 2,961.36 \text{ k-in}$$

Check

$$\frac{P_u}{\Phi P_n} = \frac{224.05}{1,055.53} = 0.212 > 0.2$$

$$\frac{P_u}{\Phi P_n} + \frac{8}{9} \left[\frac{M_{ux}}{\Phi_b M_{nx}} + \frac{M_{uy}}{\Phi_b M_{ny}} \right] \leq 1.0$$

$$0.212 + \frac{8}{9} \left[\frac{646.35}{2,961.36} \right] = 0.212 + 0.218 = 0.43 < 1 \quad \text{OK}$$

Thus the section does satisfy load beam column interaction. equation.

1. Pile bearing capacity

Considering only the gravity load, the factored bearing resistance, Q_R is given by

$$\Phi Q_n = \Phi_{qp} Q_p + \Phi_{qs} Q_s$$

Where

$$\begin{aligned} \Phi_{qp} &= \text{resistance factor, for tip resistance (AASHTO, 1998, Table 10.5.5.2)} \\ &= 0.7\lambda_v \end{aligned}$$

$$\Phi_{qs} = \text{resistance factor, for shaft resistance}$$

$$\lambda_v = 1.0 \text{ (based on method of installation of piles)}$$

End bearing capacity,

End of pile is at very stiff clay layer with $S_u = 4,000$ psf and Q_p is given by

$$\begin{aligned} Q_p &= 9S_u A_p \\ &= 9 (4.0)(14.2/12)(14.885) \\ &= 52.88 \text{ kips} \end{aligned}$$

Skin friction capacity (by a method)

$$\begin{aligned}\text{Stiff clay } Q_s &= \alpha S_u L_p L \\ &= 1(1.6)[(14.21/12)+(14.885/12)](2)(8) \\ &= 62.07 \text{ kips}\end{aligned}$$

$$\begin{aligned}\text{Very stiff clay } Q_s &= \alpha S_u L_p L \\ &= 0.53(4.0)[(14.21/12)+(14.885/12)](2)(23) \\ &= 236.44 \text{ kips}\end{aligned}$$

$$\text{Total } Q_s = 62.07 + 236.44 = 298.51 \text{ kips}$$

$$\begin{aligned}Q_R &= \Phi Q_p + \Phi Q_s \\ &= (0.7)(52.88) + (0.7)(298.51) \\ &= 245.97 \text{ kips}\end{aligned}$$

$$\text{For 8 pile } Q_R = 8(245.97) = 1,9767.76 \text{ kips} > P_u$$

Thus, the piles have sufficiency bearing capacity.

3.5. Abutment

A. Primary design dimensions

Primary design dimensions of abutment from Section 3.3 are used here. The plan showing abutment, wingwall and approach slab and the abutment cross section are shown in Figs.3.30 and 3.31.

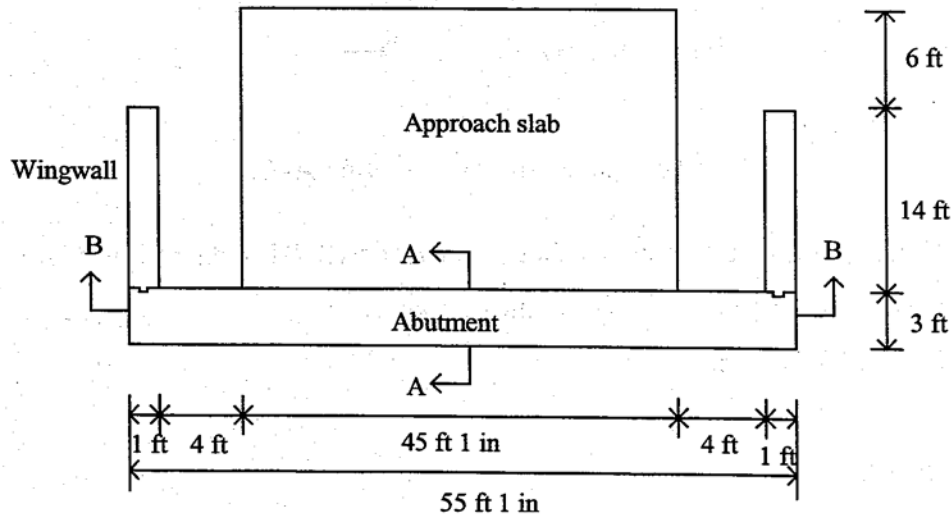

Figure 3.30 Abutment, wing wall and approach slab plan

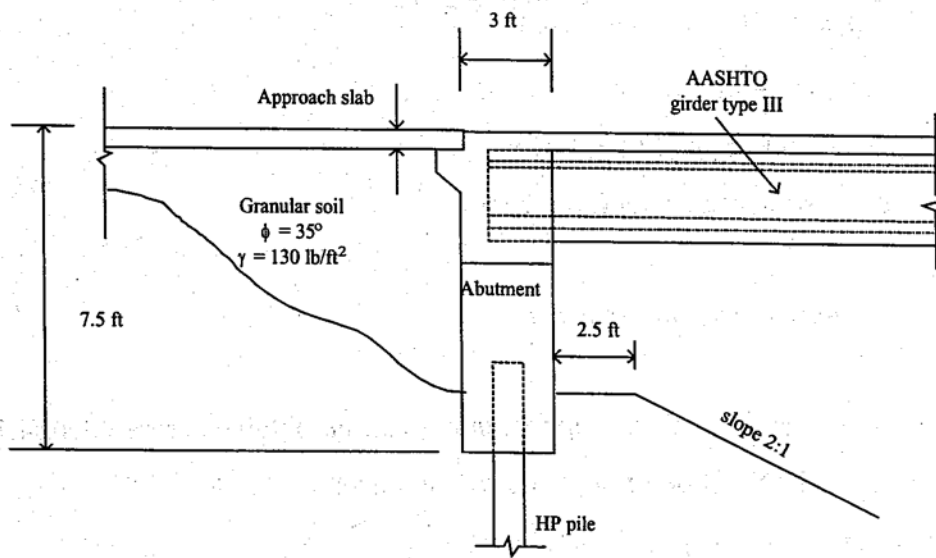

Figure 3.31 Abutment cross section

B. Design of reinforcement

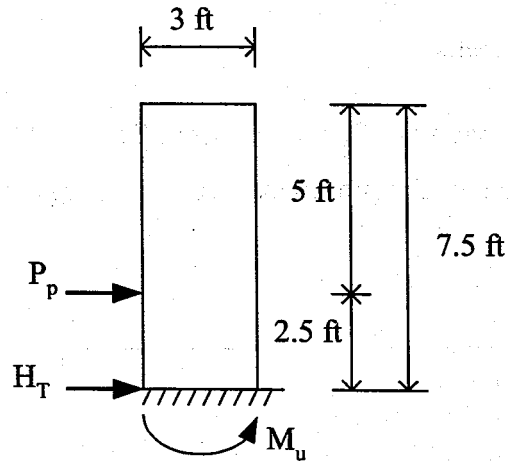

Figure 3.32 Abutment section A-A

The moment, M_u at the bottom of the abutment (Section 3 AH, Alternative I) is completed considering the gravity load and thermal movements.

$$M_u = 2,665.81 \text{ k-in.}$$

Main reinforcement

Using $f'_c = 5,000 \text{ psi}$, $f_y = 60,000 \text{ psi}$

$$\text{Required } R_n = \frac{M_u}{\phi b d^2} = \frac{2,665.81(1000)}{0.90(12)(36 - 2.5)^2} = 219.94$$

From Fig. 3.11, for $R_n = 219.94 \text{ psi}$, $\rho = 0.005$

$$A_s = \rho b d = 0.005(12)(33.5) = 2.01 \text{ in}^2$$

Using #9 @ 11 in center to center, ($A_s = 2.01 \text{ in}^2$)

Shrinkage and temperature reinforcement

Temperature and shrinkage reinforcement can be obtained from ACI-14.1.2 and 14.3.3. Using $\rho = 0.0025$ for deformed bars with diameter $> \#5$.

$$A_s = \rho b h = 0.0025(12)(33.5) = 1.00 \text{ in}^2/\text{ft}$$

Using #8 @ 9.5 in ($A_s = 1.00 \text{ in}^2$)

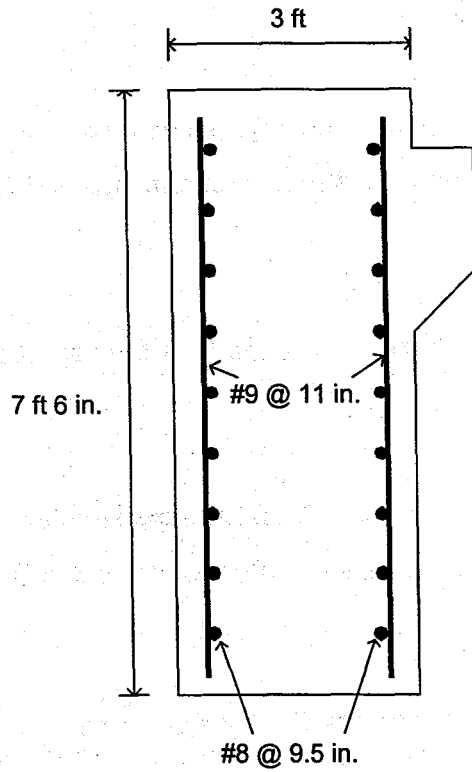

Figure 3.33 Reinforcement details in the integral abutment

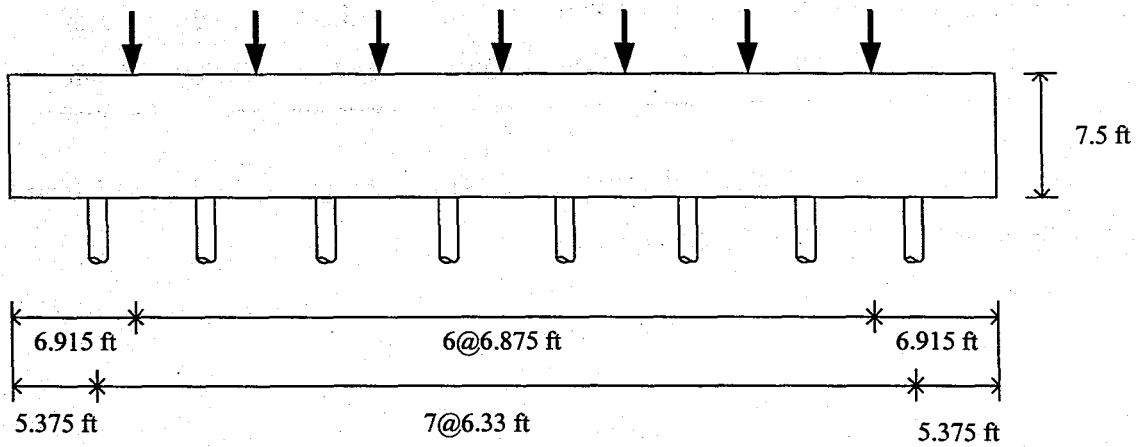

Figure 3.34 Abutment section B-B

Determine load on abutment on section B-B

Fig. 3.35 shows load diagram on abutment and w_u is summation of factored dead load of abutment and factored load from approach slab by assuming the width is equal to the width of abutment.

$$\begin{aligned} w_u &= \text{factor dead load of abutment} + \text{factored load from approach slab} \\ &= 1.25 (3.52) + 12.82 \\ &= 17.22 \text{ kip/ft} \end{aligned}$$

P_u is factored load of DC, DW, LL and IM from superstructure plus induced axial compression force due to thermal and shrinkage effect (Section 3.4G).

Table 3.8 P_u load reaction at girder

Pile	A	B	C	D	E	F	G
$\gamma(\text{DC} + \text{DW})$	60.79	60.79	60.79	60.79	60.79	60.79	60.79
Live load (Fig. 21)	18.22	14.74	-1.87	22.36	38.60	2.45	-0.40
Impact factor	24.24	19.60	-2.49	29.74	49.99	3.26	-0.53
$\gamma(\text{LL} + \text{IM})$	42.41	34.31	-4.35	52.04	87.49	5.70	-0.93
Induced axial force	15.60	15.60	15.60	15.60	15.60	15.60	15.60
Total factored load	118.9	110.7	72.04	128.43	163.88	82.09	75.46

Load, shear and bending moment distribution diagram are given in Fig. 3.35 and maximum moments are used in design abutment.

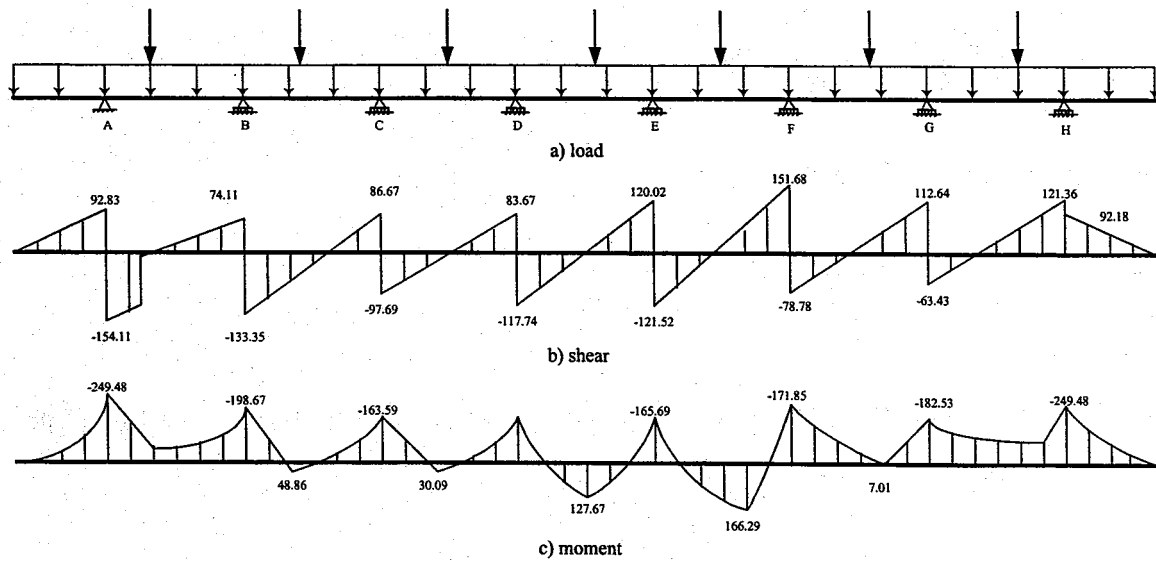

Figure 3.35 a) load on the abutment, b) shear force diagram and c) bending moment distribution diagram

Deep beam provisions of ACI-11.8 are checked below:

$$d = 0.9h = 0.9(7.5\text{ft}) = 6.75 \text{ ft} = 81 \text{ in}$$

L_n = length of clear span measured face to face of supports (Fig. 3.37)

$$\frac{L_n}{d} = \frac{5.166}{6.75} = 0.76 < 5 \quad \text{Therefore, ACI-11.8 for deep beam is applicable.}$$

Determine the flexure reinforcement;

Design positive moment, $+M_u = 166.29 \text{ kip-ft}$

$$\text{Required } R_n = \frac{M_u}{\phi b d^2} = \frac{166.29(12000)}{0.90(36)(81)^2} = 9.39 \text{ psi}$$

From Fig. 3.11, for $R_n = 9.39 \text{ psi}$, $\rho = 0.004$

$$A_s = \rho b d = 0.004 (36)(81) = 11.66 \text{ in}^2 \text{ (positive steel)}$$

Use 12 #9 bar ($A_s = 12.00 \text{ in}^2$) in uniformly placed along the two faces over a depth of 1 ft 6 in. from the bottom.

Design negative moment, $-M_u = 249.48 \text{ kip-ft}$

$$A_s = \frac{M_u}{\phi_f y j d} \geq \frac{200bd}{f_y} \geq \frac{3\sqrt{f'_c}}{\phi_f y} bd$$

$$jd = 0.2(1 + 1.5h) \quad \text{for } 1 \leq \frac{l}{h} \leq 2.5$$

$$jd = 0.5l \quad \text{for } \frac{l}{h} < 1.0$$

where

l = the effective span measured center to center of supports or 1.15 times the clear span whichever is smaller

$$l = \min \begin{cases} 1.5(5.15)(12) = 93 \text{ in.} \\ 6.33(12) = 76 \text{ in.} \end{cases}$$

$$= 76 \text{ in.}$$

$$\text{Check } \frac{l}{h} = \frac{76}{90} = 0.84 < 1$$

Determine A_s

$$A_s = \frac{M_u}{\phi_f y j d} = \frac{249.48(12,000)}{0.90(60,000)(0.5)(76)} = 1.46 \text{ in.}^2$$

$$A_s \geq \frac{200bd}{f_y} = \frac{200(36)(81)}{60,000} = 9.72 \text{ in.}^2$$

$$A_s \geq \frac{3\sqrt{f'_c}}{\phi_f y} bd = \frac{3\sqrt{5,000}}{0.90(60,000)} (36)(81) = 11.46 \text{ in.}^2$$

Hence, use nominal steel $A_s = 11.46 \text{ in.}^2$

In cases where the ratio l/h has a value equal to or less than 1.0, use nominal steel for A_{s1} is placed in the top 20% of the beam depth and provide the total A_s in the next 60% of the abutment depth.

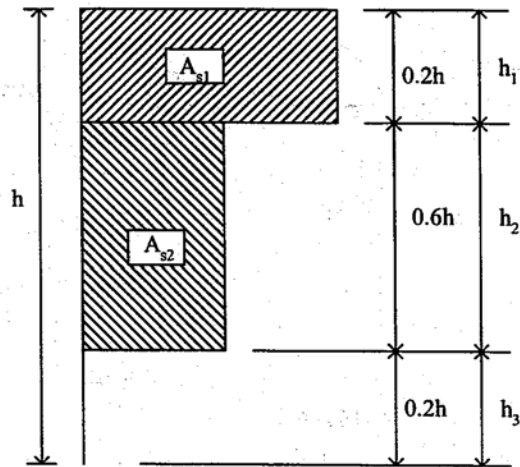

Figure 3.36 Distribution of horizontal flexure steel in continuous deep beam

The reinforcement area A_{s1} corresponds to the nominal steel.

$$A_s = 11.46 \text{ in.}^2$$

Use 12 #9 bar ($A_s = 12.0 \text{ in.}^2$) in the top of 1 ft 6 in. of the abutment on both faces of the beam.

The reinforcement area, A_{s2} is

$$A_s = 11.46 \text{ in.}^2$$

Use 12 #9 bar ($A_s = 12.0 \text{ in.}^2$) in the next 4 ft 6 in. of the abutment on both faces of the beam.

Design of shear reinforcement

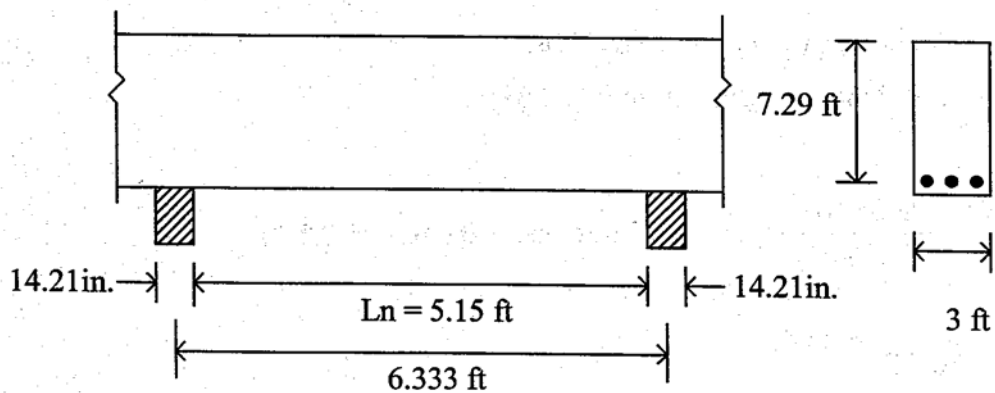

Figure 3.37 Abutment (deep beam)

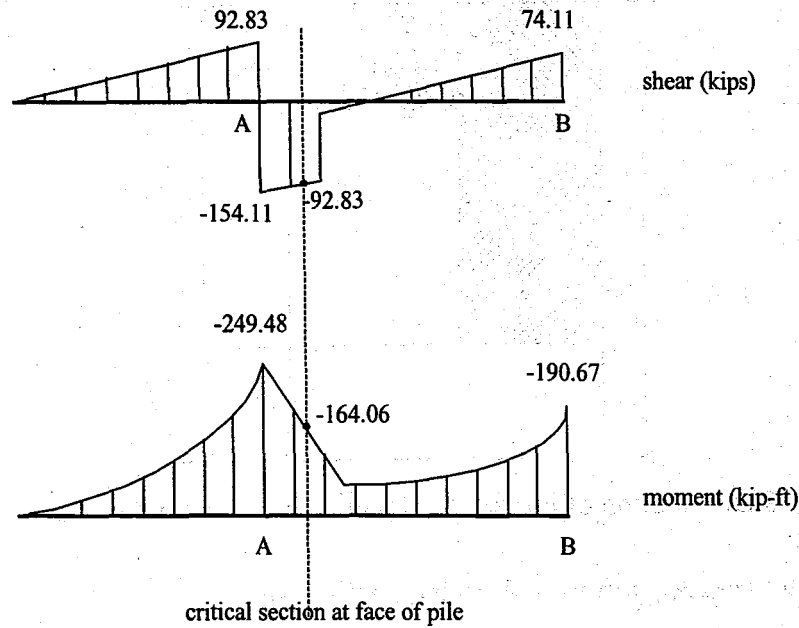

Figure 3.38 shear and moment at critical section

Critical section should be taken at the face of the support. Shear strength, V_c at critical section. ACI-11.8.3 suggests that ordinary beam expressions for V_c given in ACI-11.3 applies to continuous deep beams.

$$V_c = \left[1.9\sqrt{f'_c} + 2,500\rho_w \frac{V_u d}{M_u} \right] b_w d \leq 3.5\sqrt{f'_c} b_w d$$

$$V_u = -92.83 \text{ kips (given from Fig. 3.38)}$$

$$M_u = -164.06 \text{ kip-ft (given from Fig. 3.38)}$$

$$\frac{V_u d}{M_u} = \frac{92.38(81)}{164.06(12)} = 3.8 > 1.0 \text{ limit; use 1.0 (ACI-11.3.2.1)}$$

$$\rho_w = \frac{12}{36(81)} = 0.00411$$

$$v_c = \left[1.9\sqrt{5,000} + 2,500(0.00411)(1) \right] = 144.6 \text{ psi}$$

$$\begin{aligned}\text{upper limit } v_c &= 3.5 \sqrt{f'_c} \\ &= 3.5 \sqrt{5,000} \\ &= 247.5 \text{ psi}\end{aligned}$$

Nominal shear stress at face of support,

$$v_n = \frac{v_u}{\phi b_w d} = \frac{92.83(1,000)}{0.85(36)(81)} = 37.45 \text{ psi} < v_{c \max} \quad \text{Hence the section depth is ok 0}$$

$$\begin{aligned}\phi V_c &= 0.85(144.6)(36)(81) \\ &= 358,405.6 \text{ lbs} \\ &= 358.4 \text{ kips}\end{aligned}$$

$$V_u = \Phi V_c + V_s$$

Since $\Phi V_c > V_u$, (358.4 kips > 92.8 kips) then using minimum shear reinforcement.

Vertical shear reinforcement

The maximum permissible spacing, of vertical bars $s_v = d/5$ or 18 in.

$$s_v = \frac{81}{5} = 16.2 \text{ in. using } s_v = 16 \text{ in.}$$

$$\text{Minimum } A_v = 0.0015b_w s_v = 0.0015(36 \text{ in})16 \text{ in} = 0.864 \text{ in.}^2$$

Using #6 bars placed vertically on both faces of the beam. $A_v = 2(0.44 \text{ in.}^2) = 0.88 \text{ in.}^2$

Horizontal shear reinforcement

The maximum permissible spacing of vertical bars $s_h = d/3$ or 18 in.

$$s_v = \frac{81}{5} = 27 \text{ in. using } s_v = 16 \text{ in.}$$

$$\text{Minimum } A_h = 0.0025b_w s_v = 0.0025(36)(16) = 1.44 \text{ in.}^2$$

Using #8 bars placed vertically on both faces of the beam. $A_v = 2(0.79) = 1.58 \text{ in.}^2$

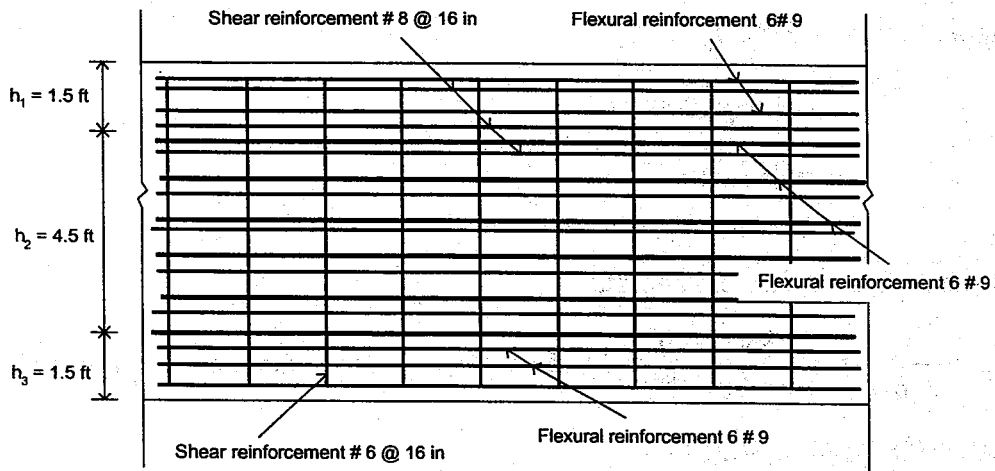

Figure 3.39 Reinforcement details of abutment

C. Design of corbel

The corbel width equals the width of the approach slab. The load on corbel per unit width of slab, $V_u = 12.82$ kip/ft

Depth of bracket, based on the maximum strength, V_n permitted by ACM 1.9.3.2.4;

$$V_{n \max} = 0.2 f'_c b_w d \leq (800) b_w d$$

Since $0.2f'_c = 1,000$ psi, then use $V_{n \max} = (800) b_w d$

$$d_{\min} = \frac{V_u}{\phi b (800)} = \frac{12,820}{0.85(12)800} = 1.57 \text{ in.}$$

With $h = 19$ in, $d \approx 17.5$ in (allowing 1-in cover)

$$\frac{a}{d} = \frac{5}{17.5} = 0.29 < 1.0 \text{ (ACI-11.9.1)}$$

Shear-friction reinforcement A_{vf} , (ACI-11.7.4.1);

$$A_{vf} = \frac{V_u}{\phi f_y \mu} = \frac{12.82}{0.85(60)1.4} = 0.18 \text{ in}^2$$

$\mu = 1.4$ for monolithically cast concrete.

Main tension reinforcement A_s .

Factored moment, $M_u = V_u a + N_{uc}(h-d)$

Where V_u = Vertical factored shear

a = distance from vertical factored shear to face of abutment

$$M_u = 12.82(5/12)$$

$$= 5.34 \text{ ft-kip}$$

$$\text{required } R_n = \frac{M_u}{\phi b d^2} = \frac{5.35(12,000)}{0.85(12)(17.5)^2} = 20.51 \text{ psi}$$

From Fig. 3.11 with $R_n = 20.51$ psi, $\rho = 0.004$

$$A_f = \rho b d = 0.004(12)(17.5) = 0.84 \text{ in.}^2$$

From ACI-11.9.3.5, the main steel requirement, A_s is the larger of the following;

$$A_s = \frac{2}{3} A_{vf} + A_n = \frac{2}{3}(0.18) + 0 = 0.12 \text{ in.}^2$$

$$A_s = A_f + A_n = 0.84 + 0 = 0.84 \text{ in.}^2$$

Use #7 @ 8.5 in. center to center ($A_s = 0.85 \text{ in.}^2/\text{ft}$)

Design of stirrups in the horizontal plane (ACI-11.9.4):

$$\text{Required } A_h = 0.5(A_s - A_n) = 0.5(0.84) = 0.42 \text{ in.}^2$$

Use 4 #3 stirrups ($A_h = 4(0.11) = 0.44 \text{ in.}^2$). The spacing of the stirrups must be within the upper two-thirds of the effective depth (ACI-11.9.4).

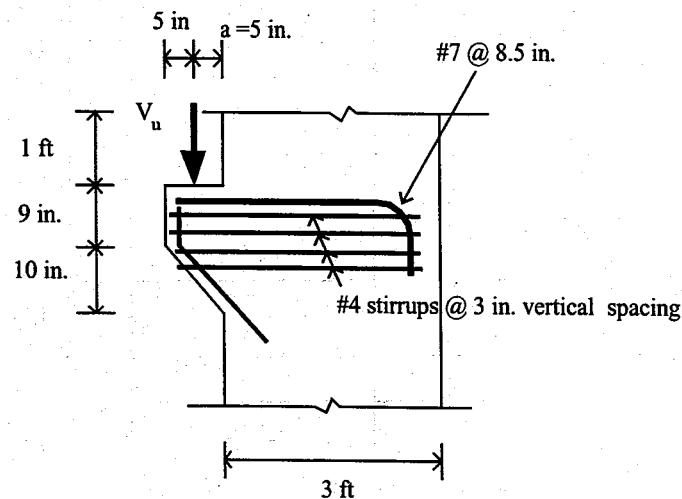

Figure 3.40 Corbel design

3.6 Wingwall

A. Wingwall cross section

New Jersey DOT recommends that wingwalls in excess of 4 meters (13 ft 1.5 in) should be supported by foundation independent of the integral abutment system. In this case, a flexible joint must be provided between the wingwall stem and the abutment backwall. The distance between the approach slab and the rear face of the U-wall should preferably be a minimum of 1.2 m (4 ft). Maine State DOT suggests using at rest condition for calculating lateral earth pressure on the wingwall. Fig. 3.41 shows the cross section of the wingwall. Elevation of approach, abutment and wingwall are given in Fig. 3.42. Fig. 3.43 shows the loading on the wingwall including 2 ft of live load surcharge on the top of the wall.

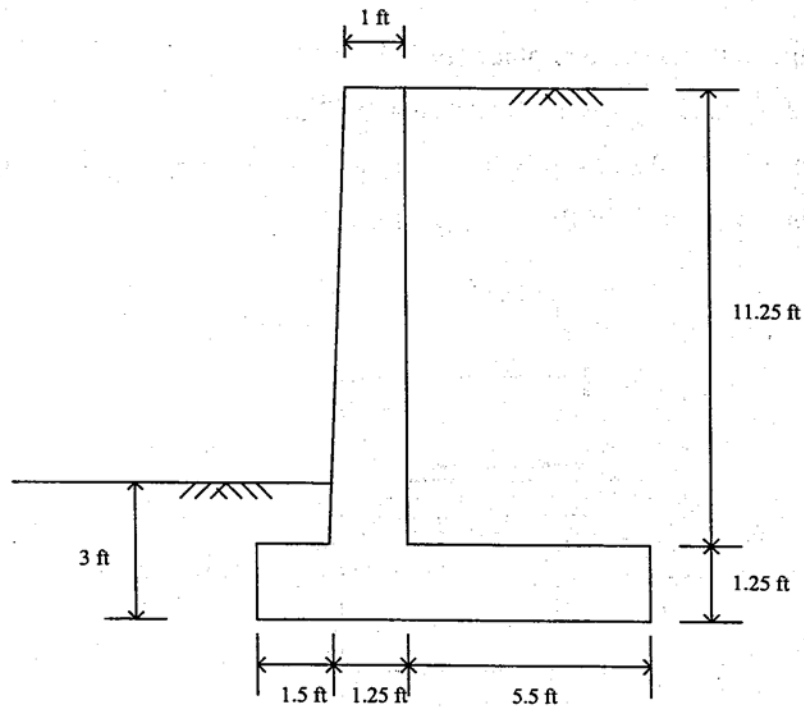

Figure 3.41 Wingwall section

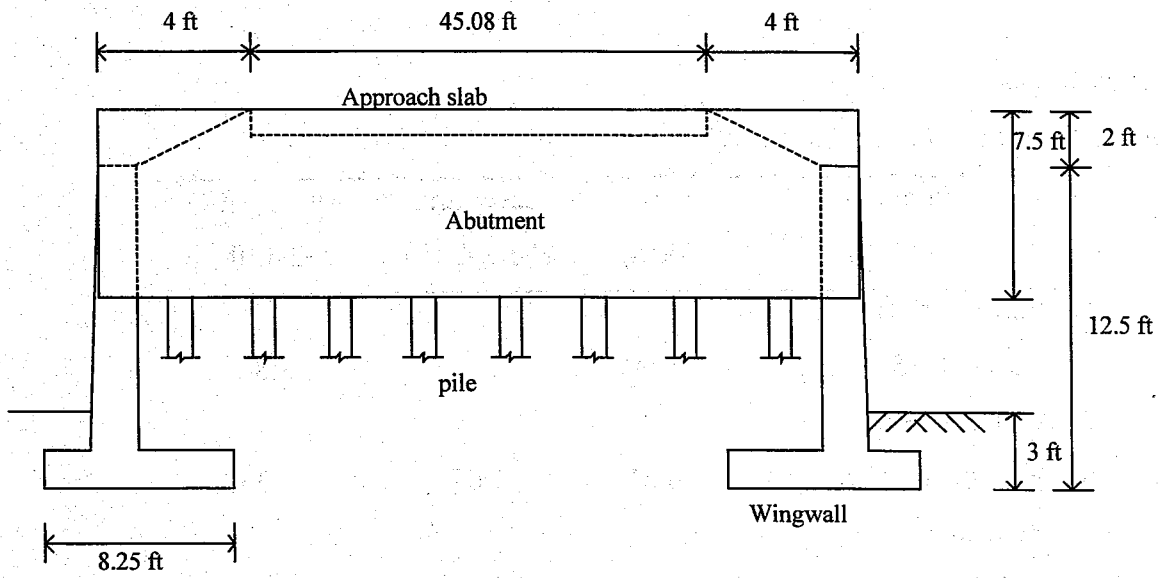

Figure 3.42 Elevation of approach slab, abutment and wingwall

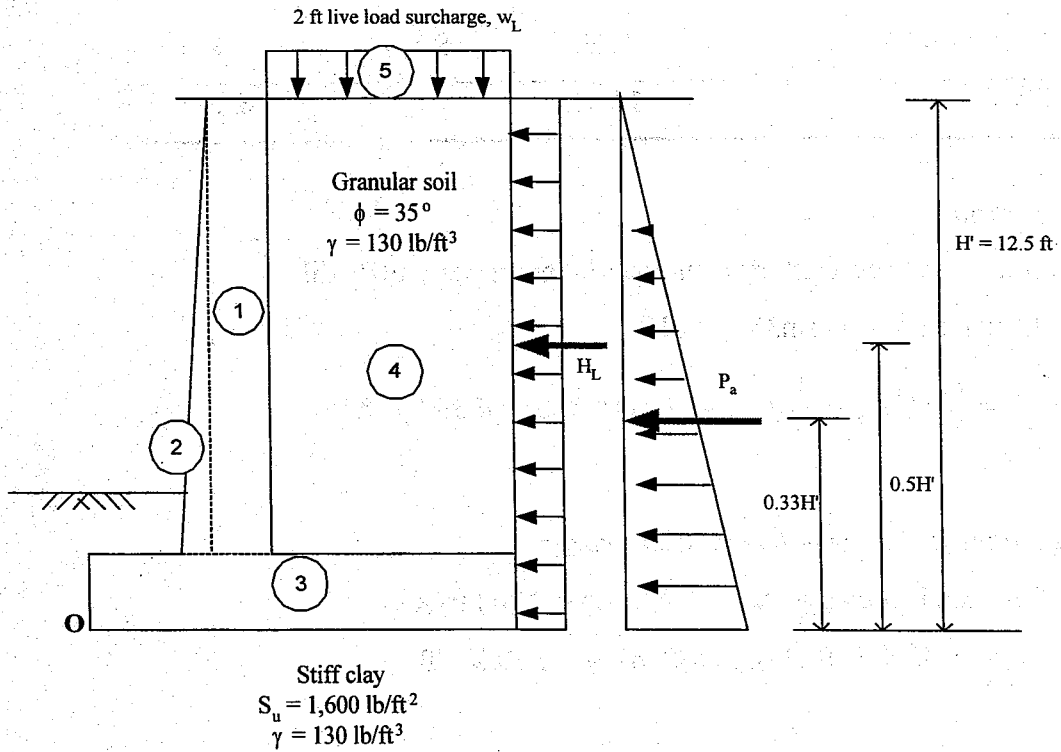

Figure 3.43 Summary of load on the wingwall

B. Loads on the wingwall

i) Vertical loads

Table 3.9 Vertical loads on wingwall

Items	V (k/ft)	Lever arm about O (ft)	M _V about O (k-ft/ft)
1. Vertical stem 1 (11.25)(1)(0.15)	1.69	2.25	3.80
2. Vertical stem 2 (0.5)(11.25)(0.25)(0.15)	0.21	1.67	0.35
3. Base slab (1.25)(8.25)(0.15)	1.55	4.125	6.38
4. Self weight of soil (11.25)(5.5)(0.13)	8.04	5.5	44.24
5. live load surcharge (2)(5.5)(0.13)	1.43	5.5	7.87
Total	12.92		62.63

At rest pressure

Rankine at rest earth pressure coefficient for granular soil

$$K_o = 1 - \sin\Phi = 1 - \sin 35 = 0.426$$

$$P_o = \frac{1}{2} \gamma H^2 K_o = \frac{1}{2} (0.13)(12.5)^2 (0.426) = 4.33 \text{ kip/ft}$$

Lateral active force due to live load surcharge

$$\text{Live load surcharge, } \omega_L = (2)(0.13) = 0.26 \text{ kip/ft}$$

$$H_L = \omega_L H K_o = (0.26)(12.5)(0.426) = 1.39 \text{ kip/ft}$$

Passive pressure in front of toe

Rankine passive earth pressure coefficient, k_p

$$K_p = \tan^2 \left(45 + \frac{\phi}{2} \right) = \tan^2 \left(45 + \frac{0}{2} \right) = 1$$

$$P_p = \frac{1}{2} K_p \gamma_2 D^2 + 2S_{u2} \sqrt{K_p} D$$

$$= 0.5(1)(0.122)(3)^2 + (2)(1.6)(\sqrt{1})(3)$$

$$= 10.15 \text{ kip/ft}$$

ii) Horizontal load

Table 3.10 Horizontal load on wingwall

Items	H (k/ft)	Arm about o (ft)	M _H about o (k-ft/ft)
1. P _o (at rest earth condition)	4.33	4.17	18.04
2. H _L (due to ω _L)	1.39	6.25	8.66
Total	5.71		26.69

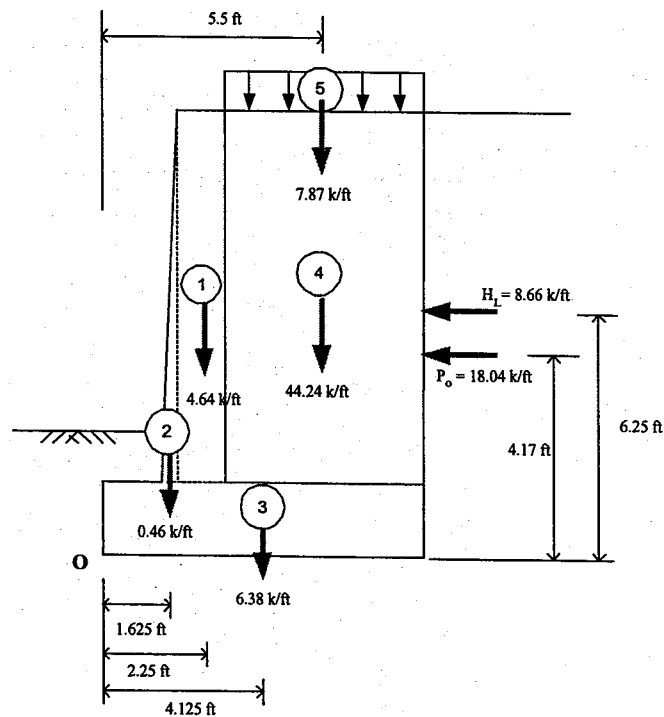

Figure 3.44 Forces on the wingwall

C. Stability and safety criteria

i) Eccentricity check

By taking moments about O (neglecting P_p),

$$\begin{aligned}\text{Location of resultant, } X_o &= (M_v - M_H) / V \\ &= (62.63 - 26.69) / 12.92 \\ &= 2.78 \text{ ft}\end{aligned}$$

$$\begin{aligned}\text{Eccentricity } e &= B/2 - X_o \\ &= 8.25 / 2 - 2.78 \\ &= 1.34 \text{ ft} \\ e_{\max} &= B/6 = 8.25/6 = 1.38 \text{ ft} \\ e &< e_{\max} \quad \text{OK}\end{aligned}$$

ii) Bearing capacity

$$\text{Factor of safety, FS} = \frac{q_u}{q_{\max}}$$

$$q_u = S_u N_c F_{cd} F_{ci} + g N_q F_{qd} F_{qi} + \frac{1}{2} \gamma_2 B N_\gamma F_{yd} F_r$$

where

q = effective stress at the level of the bottom of the foundation

B = width of foundation

L = length of foundation

N_c, N_q, N_γ = bearing capacity factors

$$N_q = \tan^2 \left(45 + \frac{\phi}{2} \right) e^{\pi \tan \phi}$$

$$N_c = (N_q - 1) \cot \phi \quad \text{for } \phi > 0$$

$$N_c = 5.14 \quad \text{for } \phi = 0$$

$$N_\gamma = 2(N_q + 1) \tan \phi$$

$F_{cs}, F_{qs}, F_{\gamma s}$ = shape factors

$$F_{cs} = 1 + \frac{BN_q}{LN_c}$$

$$F_{qs} = 1 + \frac{B}{L} \tan \Phi$$

$$F_{\gamma s} = 1 - 0.4 \frac{B}{L}$$

F_{cd}, F_{qd}, F_{yd} = depth factors

Condition i) $D_f / B \leq 1$

$$F_{cd} = 1 + 0.4 \frac{D_f}{B}$$

$$F_{qd} = 1 + 2 \tan \Phi (1 - \sin \Phi)^2 \frac{D_f}{B}$$

$$F_{yd} = 1$$

Condition ii) $D_f / B > 1$

$$F_{cd} = 1 + 0.4 \tan^{-1} \left(\frac{D_f}{B} \right)$$

$$F_{qd} = 1 + 2 \tan \Phi (1 - \sin \Phi)^2 \tan^{-1} \left(\frac{D_f}{B} \right)$$

$$F_{\gamma d} = 1$$

$F_{ci}, F_{qi}, F_{\gamma i}$ = load inclination factors

$$F_{ci} = F_{qi} = \left(1 - \frac{\beta^\circ}{90^\circ} \right)^2$$

$$F_{\gamma i} = \left(1 - \frac{\beta}{\phi} \right)^2$$

β = inclination of the load on the foundation with respect to the vertical

Since clay has $\Phi = 0$, then

$$N_q = \tan^2(45 + \frac{\phi}{2})e^{\pi \tan \Phi} = 1$$

$$N_c = 5.14$$

$$N_\gamma = 2(N_q + 1)\tan \Phi = 0$$

Effective width is used in width of foundation because of foundation has eccentric load.

$$B' = B - 2e = 8.25 - 2(1.34) = 5.56 \text{ ft}$$

$$q = \gamma_2 D = (122)(1) = 122 \text{ lb/ft}^2$$

$$F_{cd} = 1 + 0.4 \left(\frac{D}{B'} \right) = 1 + 0.4 \left(\frac{3}{5.56} \right) = 0.21$$

$$F_{qd} = 1 + 2 \tan \Phi_2 (1 - \sin \Phi_2)^2 \left(\frac{D}{B'} \right) = 1$$

$$F_{ci} = F_{qi} = \left(1 - \frac{\beta^\circ}{90^\circ} \right)^2 = 1$$

$$q_u = (1.6)(5.41)(1.22)(1) + (0.122)(3)(1)(1)(1) + 0$$

$$= 10.56 + 0.37$$

$$= 10.93 \text{ k/ft}$$

$$q_{toe} = \frac{\Sigma V}{B} \left(1 + \frac{6e}{B} \right)$$

$$= \frac{12.92}{8.25} \left(1 + \frac{6(1.34)}{8.25} \right)$$

$$= 1.57(1 + 0.97)$$

$$= 3.10 \text{ kip/ft}^2$$

$$q_{heel} = \frac{\Sigma V}{B} \left(1 - \frac{6(e)}{B} \right)$$

$$= \frac{12.92}{8.25} \left(1 - \frac{6(1.34)}{8.25} \right)$$

$$= 1.57(1 - 0.97)$$

$$= 0.047 \text{ kip/ft}^2$$

$$q_{\max} = 3.10 \text{ kip/ft}^2$$

$$FS = \frac{q_u}{q_{\max}} = \frac{10.93}{3.10} = 3.52 > 3 \quad \text{OK}$$

iii) Overturning moment

$$FS = \frac{\Sigma M_R}{\Sigma M_D}$$

where FS = factory of safety against overturning

ΣM_R = Sum of the resisting moments per unit length of wall (neglecting P_p)

ΣM_D = Sum of the driving moments (overturning moment) per unit length of wall

$$FS = \frac{\Sigma M_R}{\Sigma M_D} = \frac{62.63}{26.69} = 2.35 > 2 \quad \text{OK}$$

iv) Sliding stability

$$FS = \frac{\Sigma P_R}{\Sigma P_D}$$

ΣP_R = Sum of horizontal resisting forces per unit length of wall

ΣP_D = Sum of horizontal driving forces per unit length of wall

$$\Sigma P_R = (\Sigma V)\tan(k_1\Phi_2) + Bk_2C_{u2} + P_p$$

Let $k_1 = k_2 = 2/3$

$$\begin{aligned} \Sigma P_R &= 0 + (8.25)\left(\frac{2}{3}\right)(1.6) + 10.15 \\ &= 18.96 \text{ kip/ft} \end{aligned}$$

$$\Sigma P_D = P_o + H_L = 5.71 \text{ kip/ft}$$

$$FS = \frac{\Sigma P_R}{\Sigma P_D} = \frac{18.96}{5.71} = 3.3 > 1.5 \quad \text{OK}$$

F. Structural design

i) Design of heel cantilever

Fig 3.45 shows the forces acting on the heel.

$f'_c = 4,000 \text{ psi}$, $f_y = 60,000 \text{ psi}$

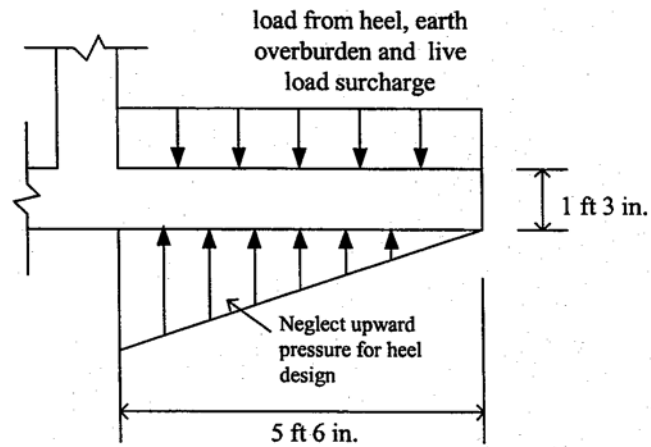

Figure 3.45 Forces acting on the heel

$$W_u = 1.25DC + 1.75(LL+IM)$$

DC = weight of heel + weight of overburden soil

$$= (5.5)(0.15) + (11.25)(0.13)$$

$$= 2.29 \text{ kip/ft}^2$$

LL = live load surcharge

$$= (2)(0.13)$$

$$= 1.56 \text{ kip/ft}^2$$

$$LL+IM = 1.33(1.56)$$

$$= 2.07 \text{ kip/ft}^2$$

$$W_u = 1.25(2.29) + 1.75(2.07) = 6.48 \text{ kip/ft}^2$$

$$V_u = W_u l = 6.48(5.5) = 16.2 \text{ kip/ft}$$

$$M_u = \frac{1}{2} W_u l^2 = \frac{1}{2} (6.48)(5.5)^2 = 98.01 \text{ kip/ft}$$

Design shear strength

$$\Phi V_c = \phi (2\sqrt{f'_c}) bd$$

$$= 0.85(2\sqrt{4,000})(12)(15 - 2.5)$$

$$= 16,128 \text{ lbs}$$

$$=16.13 \text{ kip} \approx V_u \text{ OK}$$

$$\text{Required } R_n = \frac{M_u}{\phi b d^2} = \frac{92.01(12,000)}{0.90(12)(12.5)^2} = 697 \text{ psi}$$

From Fig. 3.11, for $R_n = 697 \text{ psi}$, $\rho = 0.014$

The reinforcement, A_s , is given by

$$A_s = \rho b d = 0.014(12)(12.5) = 2.1 \text{ in}^2$$

Use #10 @ 7 in. center to center ($A_s = 2.18 \text{ in}^2/\text{ft}$)

ii) Design of toe

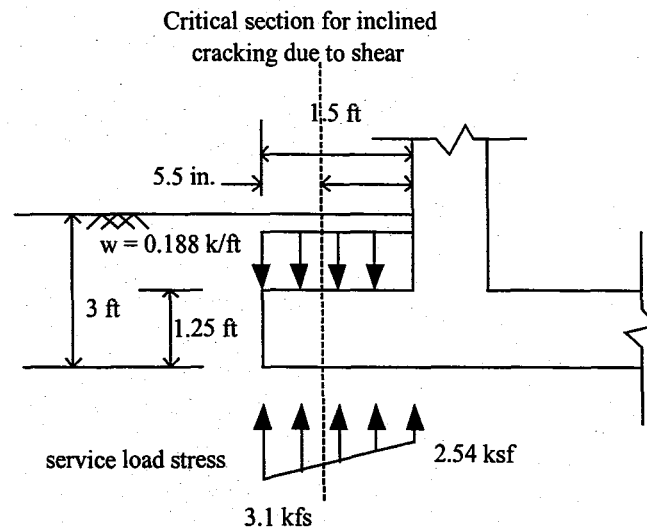

Figure 3.46 Forces acting on toe

The toe of the footing is also treated as a cantilever beam, with the critical section for moment at the front face of the wall and the critical section for shear (inclined cracking) at a distance d ($d = 15 - 2.5 = 12.5 \text{ in}$). Neglecting the soil in front of the stem,

$$V_u = 1.75 \left(\frac{3.1 + 2.54}{2} \right) \left(\frac{5.5}{12} \right) - 1.25(0.15) \left(\frac{5.5}{12} \right) = 2.26 \text{ kips}$$

$$M_u = 1.75 \left[\frac{1}{2} (3.1)(1.5)^2 \left(\frac{2}{3} \right) + \frac{1}{2} (2.54)(1.5)^2 \left(\frac{1}{3} \right) \right] - 1.25 \left[\frac{1}{2} (0.188)(1.5)^2 \right] = 5.47 \text{ k-ft/ft}$$

In general, reinforcement is based on this moment. However, this moment is less than the moment in the heel. Because the upper steel is wrapped around the toe, the steel in the heel is extended along the bottom of the footing.

Shrinkage and temperature reinforcement

Reinforcement for shrinkage and temperature is determined based on AASHTO, 1998, Article 5.10.8.1. For components less than 48 in. thick.

$$A_s \geq 0.11 A_g / f_y$$

$$A_s = 0.11(12)(15 - 2.5) / 60 = 0.275 \text{ in}^2/\text{ft}$$

Use #4 @ 8.5 in. center to center ($A_s = 0.28 \text{ in}^2/\text{ft}$)

iii) Reinforcement for wall

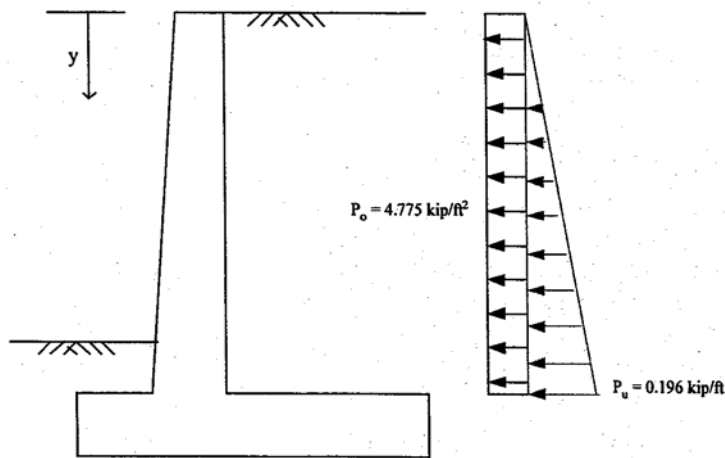

Figure 3.47 Earth pressure acting on the stem ($y = 11 \text{ ft } 3 \text{ in.}$)

The horizontal force and moment at the bottom of stem ($y = 11.25 \text{ ft}$)

For 2 ft live load surcharge, uniform factored load, w_u

$$\begin{aligned} p_{ul} &= 1.75(1.33 w_L K_o) \\ &= 1.75(1.33)(2)(130)(0.43) \\ &= 260.21 \text{ lb/ft}^2 \end{aligned}$$

For earth pressure (factored load for earth pressure, $\gamma = 1.35$)

$$\begin{aligned}
 P_{u2} &= 1.35 \left(\frac{1}{2} \gamma H^2 K_o \right) \\
 &= 1.35 \left(\frac{1}{2} \right) (130) (11.25^2) (0.43) \\
 &= 4,775.51 \text{ lb/ft}^2
 \end{aligned}$$

$$P_{uy} = P_u y + P_u \frac{y^2}{11.25^2} = 0.260y + 0.038y^2 \text{ k/ft}$$

$$M_u = \frac{P_u y^2}{2} + \frac{P_u y^3}{3l^3} = \frac{(0.260)y^2}{2} + \frac{(4.28)y^3}{3(11.25)^3} = 0.130y^2 + 0.0011y^3 \text{ k-ft/ft}$$

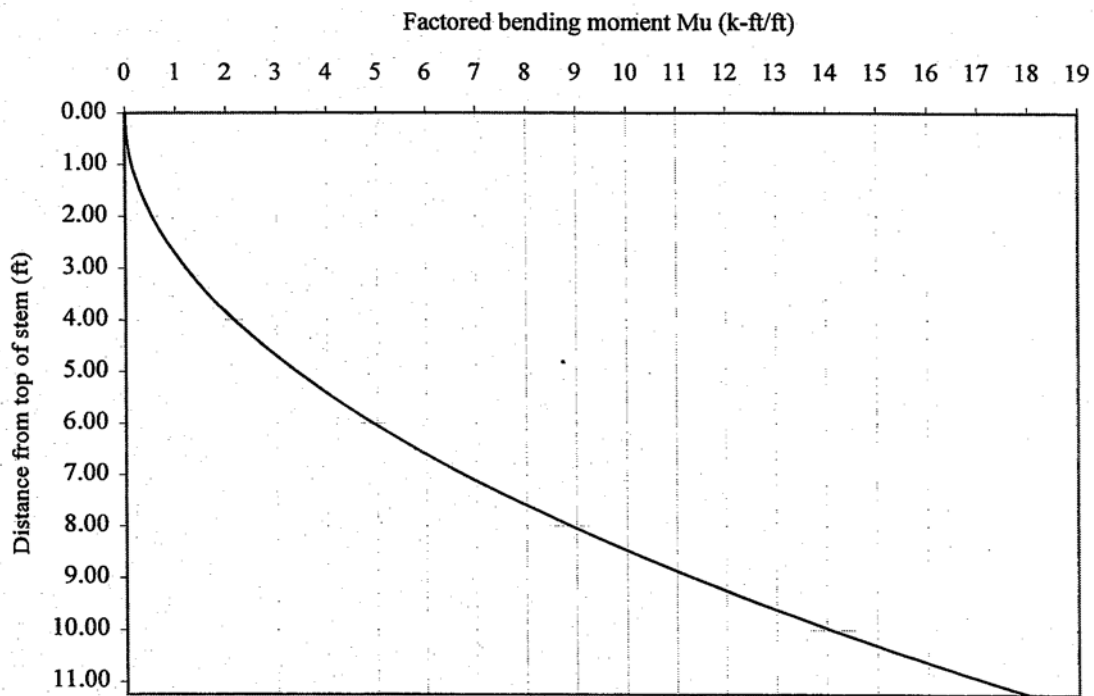

Figure 3.48 Bending moment diagram for stem

Table 3.11 Factored shear and bending moment along stem

Distance from top of wall y (ft)	Factored shear P _u (k/ft)	Factored bending moment M _u (k-ft/ft)
0.00	0.00	0.00
0.50	0.14	0.03
1.00	0.30	0.13
1.50	0.48	0.30
2.00	0.67	0.53
2.50	0.89	0.83
3.00	1.12	1.20
3.50	1.38	1.64
4.00	1.65	2.15
4.50	1.94	2.73
5.00	2.25	3.39
5.50	2.58	4.12
6.00	2.93	4.92
6.50	3.30	5.79
7.00	3.68	6.75
7.50	4.09	7.78
8.00	4.51	8.88
8.50	4.96	10.07
9.00	5.42	11.33
9.50	5.90	12.68
10.00	6.40	14.10
10.50	6.92	15.61
11.00	7.46	17.19
11.25	7.73	18.02

Design shear strength

$$\begin{aligned}
 \phi V_c &= \phi(2\sqrt{f'_c})bd \\
 &= 0.85(2\sqrt{4,000})(12)(12 - 2.5) \\
 &= 12,257 \text{ bs} \\
 &= 12.26 \text{ kip} > V_u \quad \text{OK}
 \end{aligned}$$

Vertical stem steel

$$\text{Required } R_n = \frac{M_u}{\phi b d^2} = \frac{13.97(12,000)}{0.90(12)(9.5)^2} = 156 \text{ psi}$$

From fig. 3.11, for $R_n = 156$ psi, $\rho = 0.003$

$$A_s = \rho b d = 0.003(12)(9.5) = 0.34 \text{ in}^2$$

Use #5 @ 10 in. center to center ($A_s = 0.37 \text{ in}^2/\text{ft}$)

Temperature and shrinkage reinforcement

Temperature and shrinkage reinforcement can be obtained from ACI-14.1.2 and 14.3.3. Using $\rho = 0.0020$ for deformed bar diameter $< \#5$.

$$A_s = \rho b h = 0.0020(12)(12) = 0.29 \text{ in}^2/\text{ft}$$

Since it is primarily the front face that is exposed to temperature changes, more of this reinforcement should be placed there. Thus it is suggested that about two-thirds be put in the front face and one-third in the rear face.

$$\frac{2}{3} A_s = \frac{2}{3} 0.29 = 0.193 \text{ in}^2 / \text{ft}$$

$$\frac{1}{3} A_s = \frac{1}{3} 0.29 = 0.10 \text{ in}^2 / \text{ft}$$

Use on the front face # 4 @ 12 in ($A_s = 0.20 \text{ in}^2/\text{ft}$)

Use on the rear face # 4 @ 18 in ($A_s = 0.13 \text{ in}^2/\text{ft}$)

Vertical reinforcement on the front face

Use any nominal (ACI-14.3.5) amount that is adequate for supporting the horizontal temperature and shrinkage steel in that face.

Use #4 @ 18 in

Connection between stem and footing

Development length of deformed bars, L_d

$$\frac{L_d}{d_b} = \frac{3}{40} \frac{f_y}{\sqrt{f'_c}} \frac{\alpha\beta\gamma\lambda}{\left(\frac{c + K_{tr}}{d_b}\right)}$$

α = bar location factor, for horizontal reinforcement = 1.3

β = coating factor, for uncoated reinforcement = 1.0

γ = bar size factor, for #6 and smaller = 0.8, for #7 and larger bars = 1.0

λ = lightweight aggregate concrete factor, for normal weight concrete = 1.0.

K_{tr} = transverse reinforcement index, ACI code permits using $K_{tr} = 0$.

$C = 2.5$ in (clear cover) + 0.32 (#5 bar radius) = 2.82 in.

$$\frac{c + K_{tr}}{d_d} = \frac{2.82 + 0}{0.625} = 4.51 \quad \text{However, the maximum value of 2.5 is used.}$$

$$L_d \text{ (for 5\#)} = \frac{3(0.625)}{40} \frac{60,000}{\sqrt{4,000}} \frac{1.3(1)(0.8)(1)}{2.5} = 29.6 \text{ in} = 2.5 \text{ ft.}$$

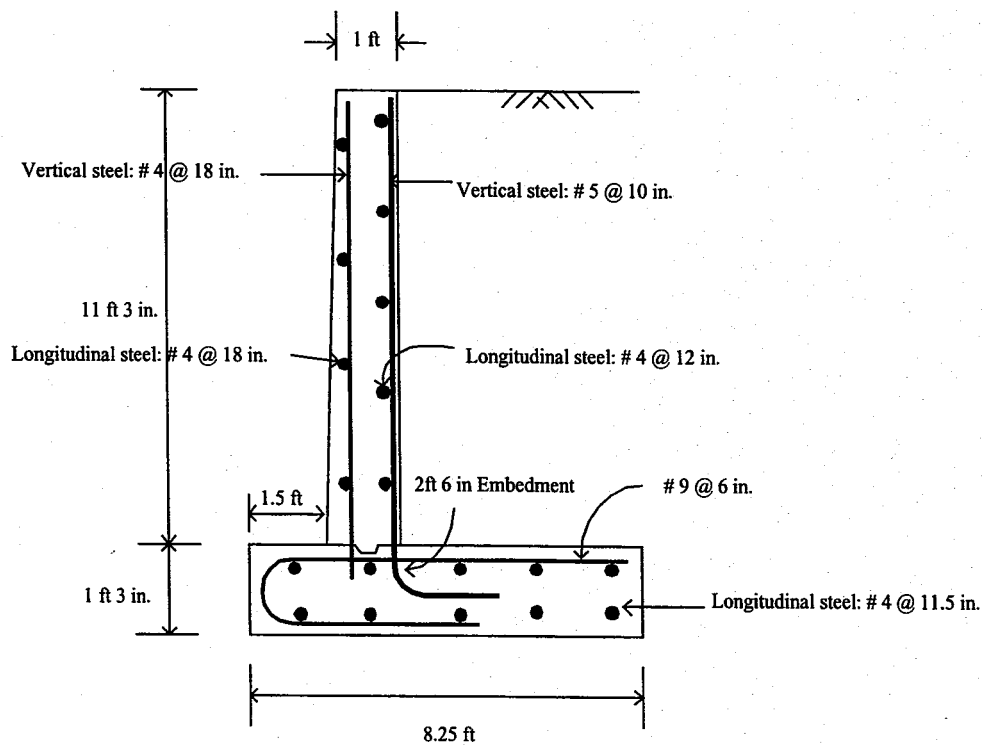

Figure 3.49 Reinforcement details for wingwall

3.7 Pier

A. Pier dimension

Fig. 3.50a shows the cross section of pier. Bent cap and pile cap plan are given in Fig. 3.50b and 3.50c.

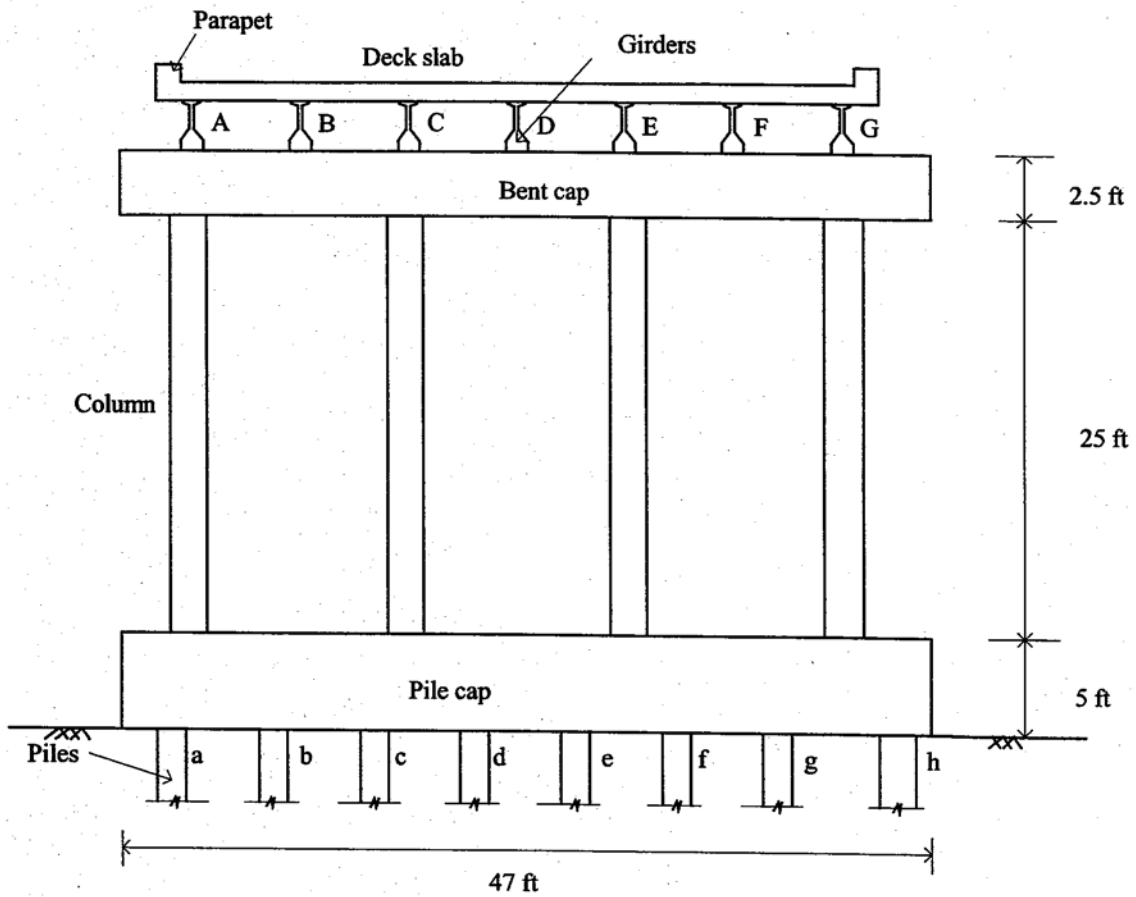

Figure 3.50a. Schematic diagram of bent cap

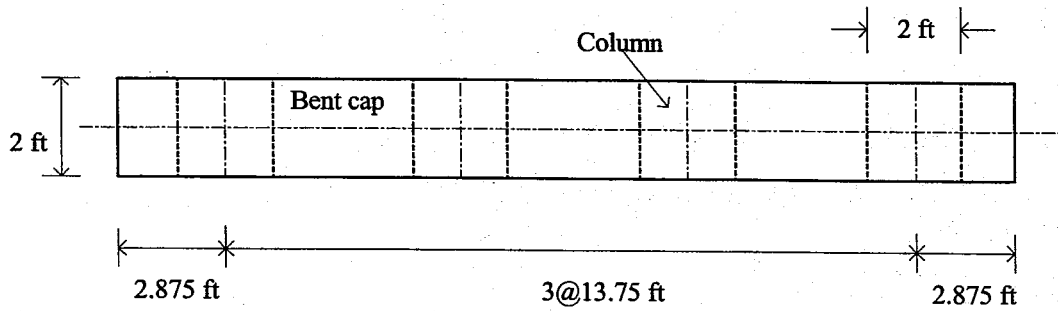

Figure 3.50b Bent cap plan

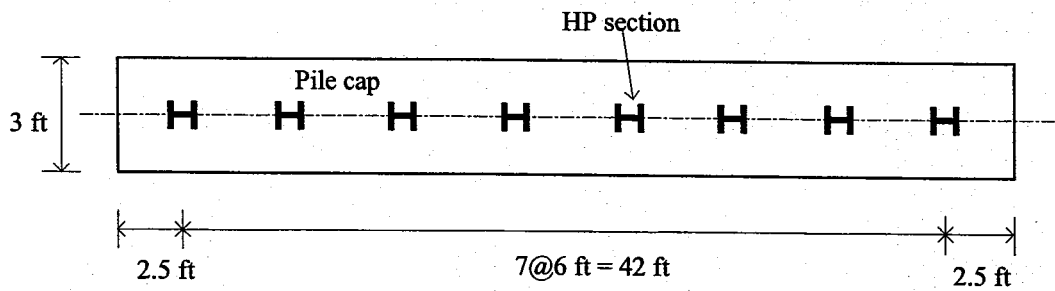

Figure 3.50c Pile cap plan

B. Loading

i) Dead load reactions

Dead loads

Self-weight of deck slab, parapet and girder DC = 9.602 kip/ft.

Self-weight of wearing surface DW = 1.455 kip/ft.

Factored dead load DC $1.25 \times 9.602 = 12.003$ kip/ft

DW $1.50 \times 1.455 = 2.182$ kip/ft.

Factored dead load on each of the girders

Due to DC = $12.003(80) / 7 = 137.2$ kips

Due to DW = $2.182(80) / 7 = 24.94$ kips

Total load on each girder = $137.20 + 24.94 = 162.14$ kips.

The loads from the girders will act on the bent cap and are shown in Fig.3.51.

Reactions at the bents due to the dead loads (Using SAP 2000)

At the exterior column bent = 232 kips

At the interior column bent = 335.49 kips

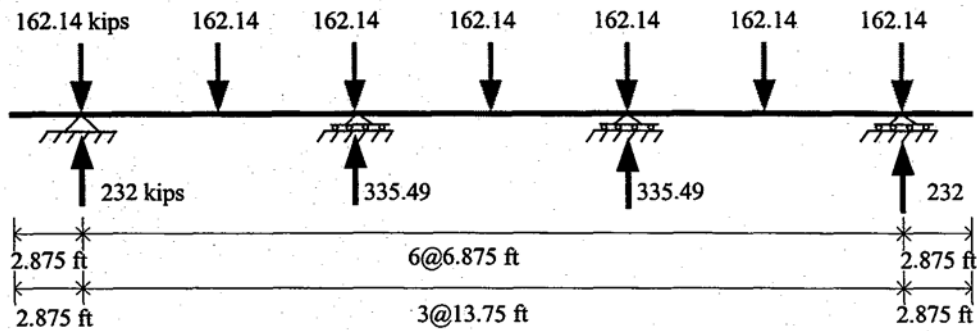

Figure 3.51. Dead load from girders acting on bent cap and the resulting reactions

ii) Live load reactions

It is assumed that one of the wheels in the rear axle of HL-93 truck is exactly on the centerline axis of the column bent (Fig.3.52).

Then reaction due to wheel loads on the column bent is given by

$$R = 16 \times 1 + (16+4)(66/80)$$

$$= 32.5 \text{ kips}$$

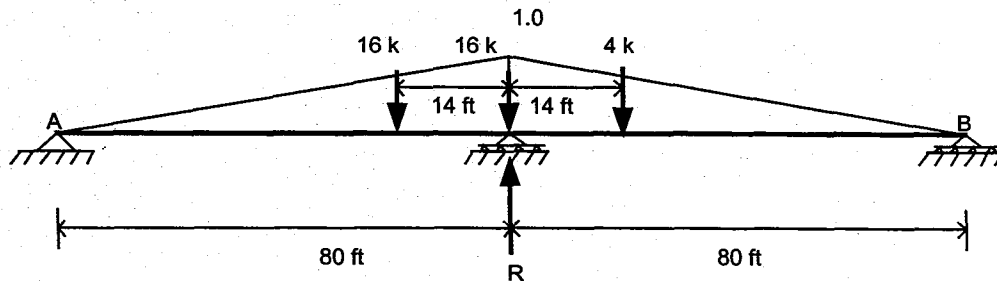

Figure 3.52 Wheel load positions for maximum reaction at bent cap

This wheel load may be placed in such a way that it could produce maximum eccentricity with reference to the centerline of the pier. Reactions at the bents (supports) due to these live loads are determined and shown in Fig. 3.53 using SAP 2000. These reaction correspond to the load transmitted to the pier bents as concentrated point loads on column bent cap.

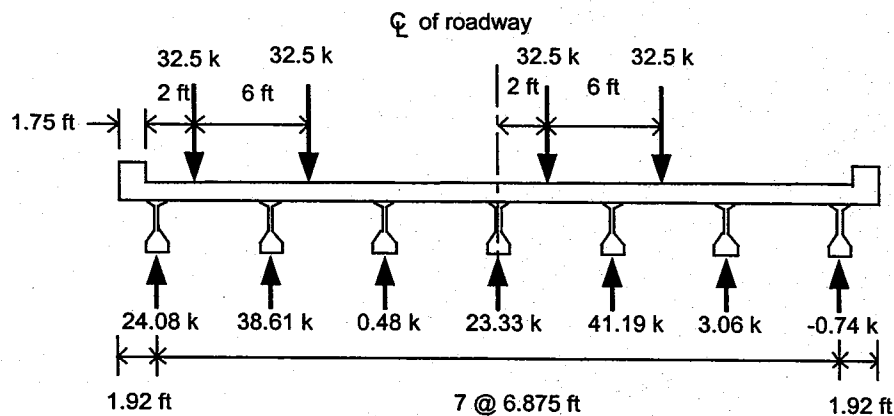

Figure 3.53 Reactions transmitted to the bent from the girders due to live load

Factored live loads including impact at girder locations on bent cap are given in Table 3.12. Fig. 3.53 shows the details of total live load effect and the corresponding reactions in girders in the bent cap. Table 3.13. show the reactions corresponding to the column locations in the bent.

Table 3.12 Live load reactions at girder points on bent cap (kips)

Live load factor = 1.75

Impact load factor = 0.33

Location	A	B	C	D	E	F	G
LL	24.08	38.61	0.48	23.33	41.19	3.06	-0.74
γ LL	42.14	67.57	0.84	40.83	72.08	5.36	-1.30
IM	13.91	22.30	0.28	13.47	23.79	17.69	-0.43
γ (LL + IM)	56.05	89.87	1.12	54.30	95.87	23.05	-1.73

Table 3.13 Reactions at the bents due to live load

Location	A	C	E	G
Reaction (kips)	94.24	86.77	127.67	9.84

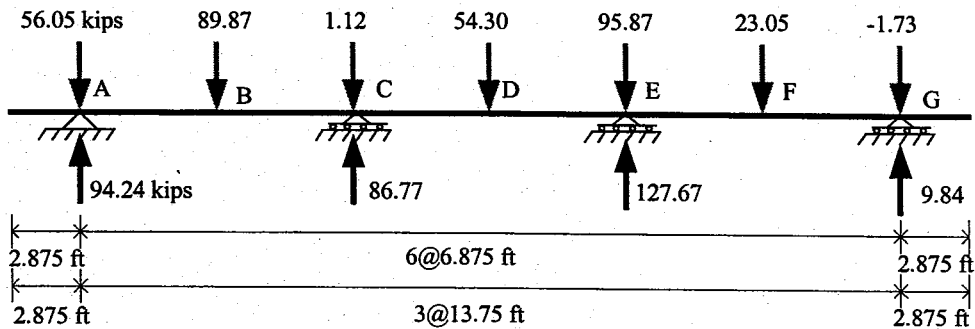

Figure 3.54 Total live load from girders and reactions at bent cap

Assume bent cap of size = 2.0 x 2.5 ft.

Self weight of bent cap = 2.0 x 2.5 x 0.15 = 0.75 kip/ft

Factored self-weight = 1.25 x 0.75 = 0.9375 kip/ft.

Summary of reactions at bent cap piers from the analyses is given in Table 3.14

Table 3.14 Summary of reactions (kips)

	A	C	E	G
γ (DC of superstructure + DW)	232.00	335.49	335.49	232.00
γ LL	94.24	86.77	127.67	9.84
γ DC of bent cap	8.71	13.32	13.32	8.71
Total (kips)	334.95	435.58	476.48	250.55

C. Bent cap

i) Bending moment

Loads considered include dead loads from super structure, live loads from moving vehicles including dynamic allowance, and self weight of the bent cap. The bending moments in the bent cap at girder locations are given in Table 3.15 (Using SAP 2000)

Bending moment diagram of typical interior pier bent due to girder reaction and DL of bent cap is shown 3.55.

Table 3.15 Bending moments at girder locations in bent cap.

Location	A	B	C	D	E	F	G
DL from SS kip-ft	-143.88	+336.40	-298.00	+270.80	-298.04	+336.40	-143.88
LL from SS kip-ft	- 72.70	+189.88	-165.39	+ 91.02	-32.72	+ 46.17	- 33.41
DL bent cap kip-ft	- 3.87	+ 9.65	- 15.43	+ 7.12	- 15.43	+ 9.65	- 3.87
	- 5.70						- 5.70
Total moment kip-ft	-226.15	+535.93	-478.82	+368.94	-346.19	+392.22	-186.86

Maximum design bending moment for bent cap = 535.93 kip-ft.

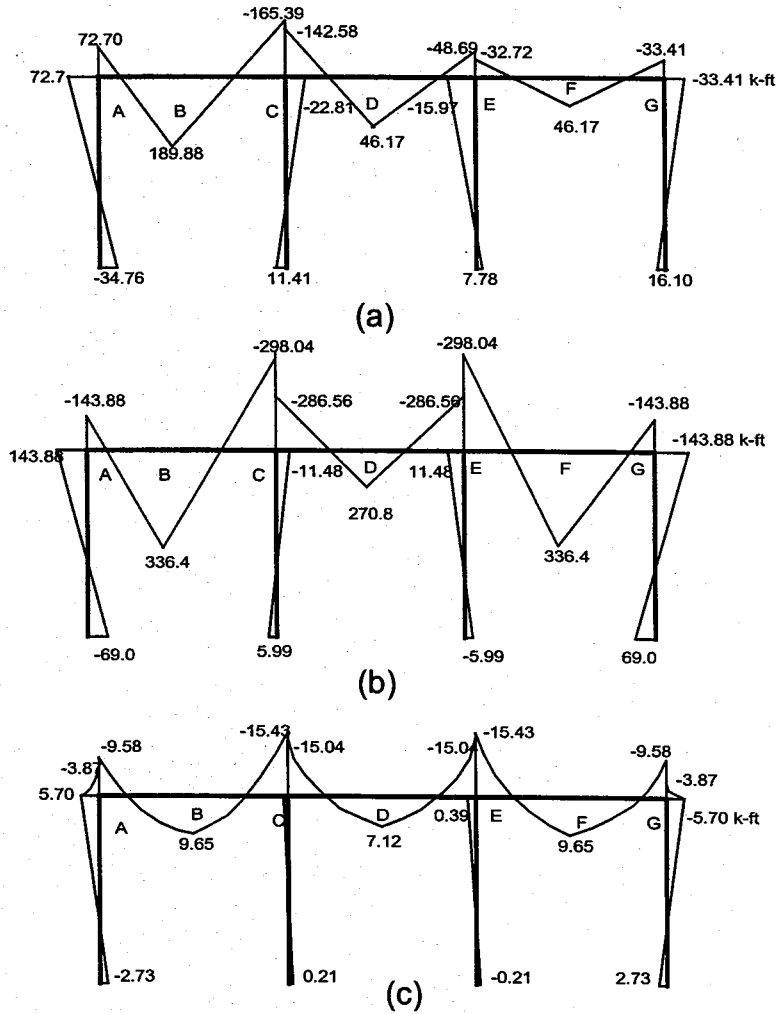

Figure 3.55 Bending moment diagram of typical interior pier bent: a) due to LL of superstructure b) due to DC of superstructure and c) due to DC of bent cap

ii) Design of bent cap for flexure

Assume $f_y = 60,000$ psi

$f_c = 5,000$ psi

$$E = 33,000 w_c^{1.5} \sqrt{f'_c}$$

where $w_c =$ unit weight of concrete $= 150$ lb/ft³

$E = 4,290$ ksi

A typical design of positive reinforcement is shown below:

$$\text{Design moment } M_n = \frac{M_u}{\phi} = \frac{(535.93)(12)}{0.90} = 7,145.74 \text{ kip-in}$$

$$\rho \text{ for balanced section } \rho_b = (\beta_1) \frac{0.85 f'_c}{f_y} \left(\frac{87,000}{f_y + 87,000} \right)$$

$$\text{and } \rho_{\min} = 0.03 \frac{f'_c}{f_y}$$

where β_1 is a constant = 0.80,

For $f_y = 60,000$ psi. and $f'_c = 5,000$ psi.

$$\rho_b = 0.0335$$

$$\rho_{\min} = 0.0025$$

$$\begin{aligned} \text{Flexural resistance factor, } R &= \frac{M_n}{bd^2} \\ &= \frac{7145.74 \times 10^3}{(24)(26.5)^2} \\ &= 423.98 \text{ psi} \end{aligned}$$

ρ corresponding to resistance factor R from table A.6.a (Design of Concrete Structures by Arthur H. Nilson) is 0.0075

$$A_{st} \text{ required} = (0.0075)(24)(26.5) = 4.77 \text{ in.}^2$$

Provide 5 #9 bars. $A_{st} \text{ provided} = 5(1) = 5.0 \text{ in.}^2$

iii) Design of negative reinforcement

$$\text{Design moment } M_n = \frac{M_u}{\phi} = \frac{(478.82)(12)}{0.90} = 6,384.3 \text{ kip-in}$$

$$\begin{aligned} \text{Flexural resistance factor, } R &= \frac{M_n}{bd^2} \\ &= \frac{6,384.3 \times 10^3}{(24)(26.5)^2} \\ &= 378.8 \text{ psi.} \end{aligned}$$

ρ corresponding to resistance factor $R = 0.0065$

$$A_{st} \text{ required} = 0.0065 (24)(26.5) = 4.134 \text{ in}^2$$

$$\text{Provide \# 8 bars } A_{st} \text{ provided} = 6(0.79) = 4.74 \text{ in}^2$$

iv) Design for Shear

The bent cap is acted upon by concentrated point loads from girders.

At section A

$$V_u \text{ at a section at a distance } d \text{ from face of support} = 111.06 \text{ kips}$$

$$M_u = -134.8 \text{ kip-ft.}$$

$$\rho = \frac{4.74}{(24)(36.5)} = 0.0074$$

Contribution of concrete to shear

$$\begin{aligned} V_c &= \left[1.9\sqrt{f'_c} + 2500 \frac{\rho_w V_u d}{M_u} \right] b_w d \\ &= \left[1.9\sqrt{5000} + 2500 \left(\frac{(0.0074)(111.06)(26.5)}{(134.8)(12)} \right) \right] \frac{24(26.5)}{1000} \\ &= 106.85 \text{ kips} \end{aligned}$$

but not to exceed,

$$\begin{aligned} V_{c \max} &= \left[3.5\sqrt{f'_c} b_w d \sqrt{1 + \frac{N_u}{500A_g}} \right] \\ &= \left[3.5(\sqrt{5000}) \left(\frac{(24)(26.5)}{1000} \right) \sqrt{1} \right] \quad \text{since } N_u = 0 \\ &= 157.4 \text{ kips} \end{aligned}$$

or

$$\begin{aligned} V_{c \max} &= 2\sqrt{f'_c} b_w d \\ &= 2 \frac{\sqrt{5000}(24)(26.5)}{1000} = 89.94 \text{ kips} \end{aligned}$$

$$\text{i.e., } V_{c \max} = 89.94 \text{ kips} < V_u = 111.06 \text{ kips}$$

Hence shear reinforcement is necessary.

$$V_s = V_u - V_{cmax}$$

$$= 111.06 - 89.94 = 21.12 \text{ kips.}$$

Provide shear reinforcement according to ACI eqn.11-15.

$$V_s = \frac{A_v f_y d}{s}$$

Spacing of U shaped web shear reinforcement s is given by

$$s = \frac{A_v f_y d}{V_s}$$

Using #3 bars $A_v = 2 \times 0.11 = 0.22 \text{ in}^2$

$$s = \frac{(0.22)(60,000)(26.5)}{(21.12)(1000)} = 16.56 \text{ in}$$

Minimum shear reinforcement requirement according to ACI eqn.11-13.

$$A_v = 50 \frac{b_w s}{f_y} \quad \text{where } b_w \text{ and } s \text{ are in in.}$$

Spacing of U shaped web shear reinforcement s is given by

$$s = \frac{A_v f_y}{50 b_w}$$

Using #3 bars $A_v = 2(0.11) = 0.22 \text{ in}^2$

$$s = \frac{(0.22)(60,000)}{(50)(30)} = 8.8 \text{ in.}$$

Provide #3 bars two legged stirrups at 8 in. center to center throughout the span.

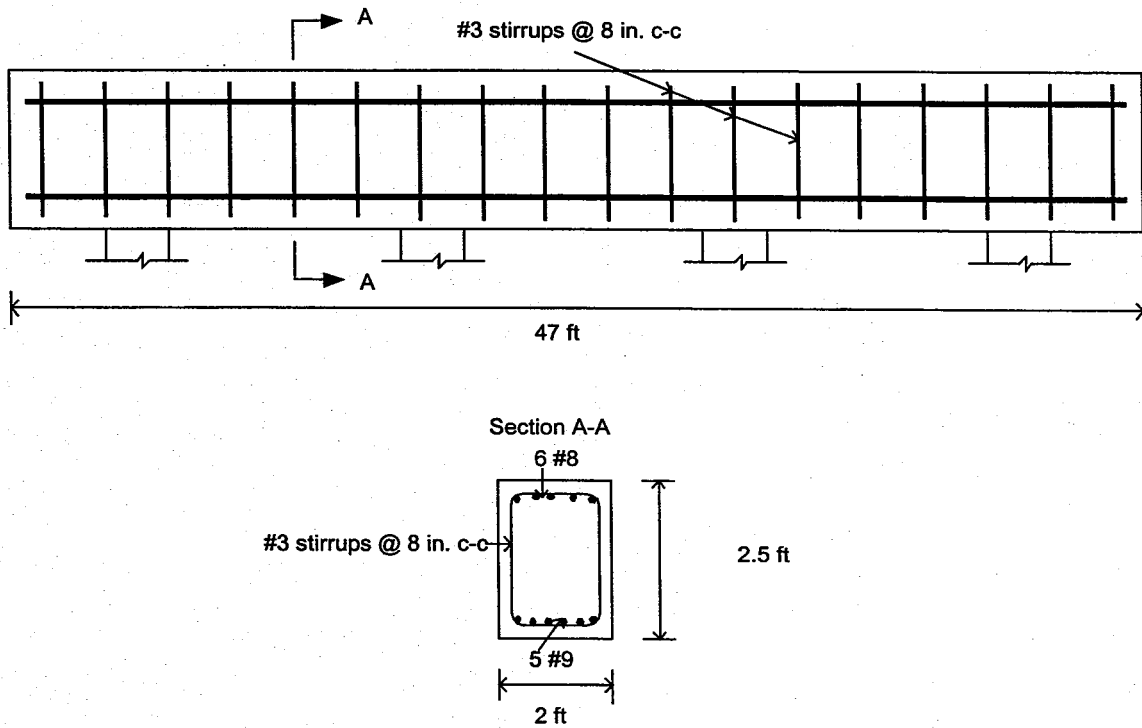

Figure 3.56 Reinforcement details for bent cap

D. Column design in the bent cap

i) Moment and axial force

The moments and axial forces acting on each column are given in Tables 3.16 and 3.17 below.

Table 3.16 Moments in the column (kips-ft)

Location	A	C	E	G
γ (DC of superstructure and DW)	143.88	-11.48	11.48	-143.88
γ LL	72.70	-22.81	-15.97	-33.41
γ DC of bent cap	5.70	-0.39	0.39	-5.70
Total	222.28	34.68	27.84	182.99

Table 3.17 Loads on each column

Location	A	C	E	G
P_u (kips)	334.95	435.58	476.48	250.55
M_u (kip-ft)	222.28	34.68	27.84	182.99

Design the section for forces at A and check for conditions for other locations.

Section A:

Axial load $P_u = 334.95$ kip

Bending moment $M_u = 222.28$ kip-ft. (2667 360 in-lb.)

Eccentricity $e = \frac{M_u}{P_u} = \frac{2,667,360}{334,950} = 7.963$ in.

Assume a 24-in. x 24-in. square column.

Assume that the reinforcement ratio $\rho = \rho' = 0.008$.

$$A_s - A_s' = 0.008 \times 24 \times 21.5 = 4.128 \text{ in}^2.$$

Radius of gyration $r = \sqrt{\frac{I}{A}}$

$$= \sqrt{\frac{(24)(24)^3}{(12)(24)(24)}}$$

$$= 6.93 \text{ in.}$$

Unsupported length of column = 29.67 ft.

Assuming both ends are fixed $k = 0.5$

Slenderness ratio $= \frac{kl}{r}$

$$= \frac{(0.5)(29.67)(12)}{6.93}$$

$$= 25.69 > 22 \text{ hence column is slender.}$$

Strength I Limit State. The lateral side sway due to wind is assumed negligible.

Actual eccentricity $e = 7.963$ in.

Minimum allowable eccentricity = (0.6 + 0.03h) from ACI (10.15)

$$= [0.6 + (0.03)(24)] = 1.32 \text{ in.} < 7.692 \text{ in.}$$

Using moment magnification method,

Using moment magnification method,

$$\begin{aligned}
 E_e &= 33,000w_c^{1.5}\sqrt{f'_c} \\
 &= 33,000 \times 0.150^{1.5}\sqrt{5} \\
 &= 4,287 \text{ ksi.}
 \end{aligned}$$

$$I_g = \frac{(1)(24)(24)^3}{12} = 27,648 \text{ in}^4.$$

$$\begin{aligned}
 EI &= \frac{\frac{1}{2.5}(E_e I_g)}{1 + \beta_d} \quad [\text{AASHTO (5.7.4.3-2)}] \\
 &= \frac{1}{2.5} \left(\frac{(4.29 \times 10^6)(27,648)}{1 + 0.5} \right) \\
 &= 31.629 \times 10^9 \text{ lb-in}^2.
 \end{aligned}$$

Euler's buckling load,

$$\begin{aligned}
 P_c &= \frac{\pi^2 EI}{(kl_u)^2} \\
 &= \frac{\pi^2 (31.629 \times 10^9)}{((0.5)(29.67)(12))^2} = 9,850 \times 10^3 \text{ kips}
 \end{aligned}$$

$C_m = 1.0$ for nonbraced column

Moment magnifier,

$$\begin{aligned}
 \delta_{ns} &= \frac{C_m}{1 - \left(\frac{P_u}{0.75P_c} \right)} / 1.0 \quad \text{ACI (10.10)} \\
 &= 1.047
 \end{aligned}$$

Magnified moment

$$\begin{aligned}
 M_c &= \delta_{ns} M_{ns} \\
 &= 1.047 (2,667,360) \\
 &= 2.794 \times 10^6 \text{ in-lb.}
 \end{aligned}$$

Assume that the reduction factor

$$\Phi = 0.70$$

Required

$$P_n = \frac{P_u}{\phi}$$

$$= 478.5 \text{ kips.}$$

$$\begin{aligned} \text{Required } M_n &= \frac{M_c}{\phi} \\ &= \frac{2.794 \times 10^6}{478.5 \times 10^3} \\ &= 3.991 \times 10^6 \text{ in-lb.} \end{aligned}$$

Hence design a non-slender column section for an axial load of $P_n = 478.5$ kips. and moment of $M_n = 3.991 \times 10^6$ in-lb.

$$\begin{aligned} \text{Eccentricity } e &= \frac{M_n}{P_n} \\ &= \frac{3.991 \times 10^6}{478.5 \times 10^3} \\ &= 8.341 \text{ in.} \end{aligned}$$

ii) Reinforcement details

A square column of 24in. x 24in. is assumed.

Percentage reinforcement, $\rho = \rho' = 0.008\%$

$$\begin{aligned} A_s = A_s' &= 0.008 \times (24 \times 21.5) \\ &= 4.128 \text{ in}^2 \end{aligned}$$

Provide five # 9 bars on each face.

$$A_s = A_s' = 5.0 \text{ in}^2$$

$$\begin{aligned} c_h &= d \times \frac{87,000}{87,000 + f_y} \\ &= 21.5 \times \frac{87,000}{87,000 + 60,000} \\ &= 12.724 \text{ in.} \end{aligned}$$

$$\begin{aligned} a_b &= \beta_1 \times c_h \\ &= (0.85 - 0.05) \times 12.724 \\ &= 10.180 \text{ in.} \end{aligned}$$

$$f_s = 0.003 \frac{(c_h - d')}{c_h} E_s$$

$$\begin{aligned}
 f_s &= 0.003 \frac{(c_h - d')}{c_h} E_s \\
 &= 0.003 \frac{(12.724 - 2.5)}{12.724} (29 \times 10^6) \\
 &= 69,906 \text{ psi} > f_y
 \end{aligned}$$

$$\therefore f_s = f_y$$

$$\begin{aligned}
 P_{nb} &= 0.85 f'_c b a_b \\
 &= 0.85 (5,000)(24)(10.180) \\
 &= 1,038.36 \times 10^3 \text{ lb.}
 \end{aligned}$$

$$M_{nb} = 0.85 f'_c b a_b \left(\frac{h}{2} - \frac{a_b}{2} \right) + A'_s f'_s \left(\frac{h}{2} - d' \right) + A_s f_y \left(d - \frac{h}{2} \right)$$

$$\begin{aligned}
 M_{nb} &= (0.85)(5,000)(24)(10.180) \left(\frac{24}{2} - \frac{10.180}{2} \right) + 5(60,000) \left(\frac{24}{2} - 2.5 \right) + \\
 &(5)(60,000) \left(21.5 - \frac{24}{2} \right) \\
 &= 12.875 \times 10^6 \text{ in-lb.}
 \end{aligned}$$

$$\begin{aligned}
 e_b &= \frac{M_{nb}}{P_{nb}} \\
 &= \frac{12.875 \times 10^6}{1038.36 \times 10^3} \\
 &= 12.40 \text{ in} > e = 8.341 \text{ in.}
 \end{aligned}$$

The failure will be in compression.

Check the adequacy of the section

$$\rho_{\text{provided}} = \frac{5.00}{24 \times 21.5} = 9.69 \times 10^{-3} \%$$

$$m = \frac{60,000}{0.85(5,000)} = 14.12$$

$$\frac{h - 2e}{2d} = \frac{24 - (2)(8.341)}{2(21.5)} = 0.170$$

$$1 - \frac{d'}{d} = 1 - \frac{2.5}{21.5} = 0.844$$

$$P_n = 0.85 f'_c b d \left[\frac{h - 2e}{2d} + \sqrt{\left(\frac{h - 2e}{2d} \right)^2 + 2m\rho \left(1 - \frac{d'}{d} \right)} \right]$$

$$= (0.85)(5,000)(24)(21.5) \left[0.170 + \sqrt{(0.170)^2 + ((2)(14.12)(9.69 \times 10^{-3})(0.884))} \right]$$

$$= 1,514.02 \times 10^3 \text{ lb.}$$

$$\Phi P_n = 0.70 (1,514.02 \times 10^3)$$

$$= 1,059.81 \times 10^3 \text{ lb.}$$

$$0.1 A_g f'_c = (0.1)(24)(24)(5,000) = 288 \times 10^3 \text{ lb.}$$

$$\Phi P_n > 0.1 A_g f'_c \quad \therefore \Phi = 0.7 \quad \text{OK.}$$

$$a = \frac{P_n}{0.85 \times f'_c \times b}$$

$$a = \frac{1,514.02 \times 10^3}{0.85(5,000)(24)} = 14.843 \text{ in}$$

$$c = \frac{a}{\beta_1} = \frac{14.843}{0.85} = 17.46 \text{ in}$$

$$f'_s = 0.003 \left(\frac{17.46 - 2.5}{2.5} \right) 29 \times 10^6$$

$$= 520,690 \text{ lb} > f_y$$

$$\text{External load} \quad P_u = 334.95 \times 10^3 \text{ lb.}$$

$$\Phi P_n = 1,059.81 \times 10^3 \text{ lb} > 334.95 \times 10^3 \text{ lb.} \quad \text{Hence OK}$$

$$M_n = 0.85 f'_c b a_b \left(\frac{h}{2} - \frac{a_b}{2} \right) + A'_s f'_s \left(\frac{h}{2} - d' \right) + A_s f_y \left(d - \frac{h}{2} \right)$$

$$= (0.85)(5,000)(24)(14.843) \left(\frac{24}{2} - \frac{14.843}{2} \right) + (5)(60,000) \left(\frac{24}{2} - 2.5 \right) + (5)(60,000) \left(21.5 - \frac{24}{2} \right)$$

$$= 12.631 \times 10^6 \text{ in-lb.}$$

$$e = \frac{M_n}{P_n} = \frac{12.631 \times 10^6}{1059.81 \times 10^3} = 11.92 \text{ in.} < 12.40 \text{ in.}$$

Since the design eccentricity is less than the eccentricity for a balanced section, the design is OK

Lateral ties: # 3 ties are used. The spacing is given by the least of the following:

- i) 48 times diameter of tie = 18 in.
- ii) 16 times diameter of longitudinal bar = 18 in.
- iii) Least lateral dimension = 24 in.

so adopt # 3 ties @ 18 in. center to center.

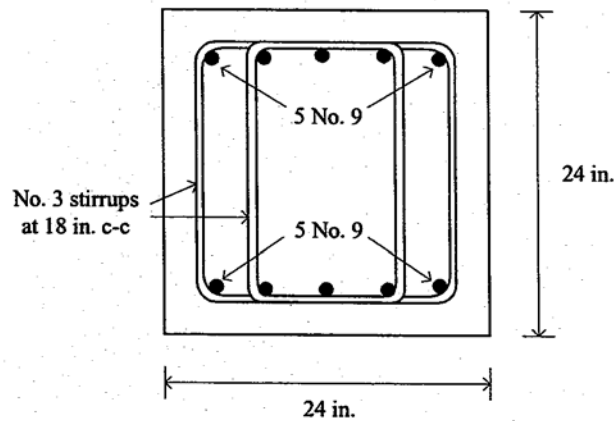

Figure 3.57 Reinforcement details of column

E. Design of pile cap

i) Reaction at pile cap

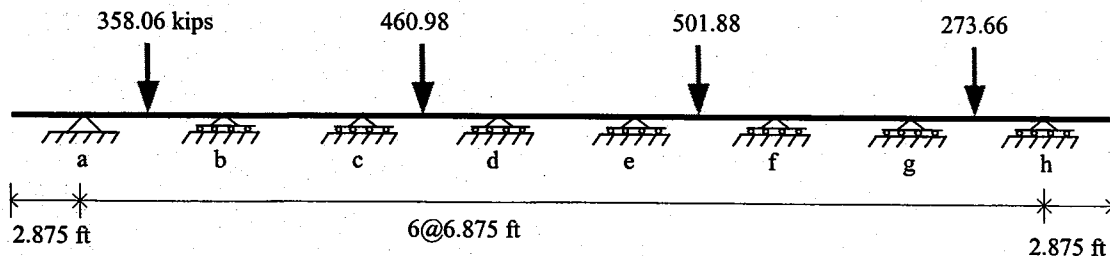

Figure 3.58 Reaction transmitted to the pile cap from the columns due to column load

Assume pile cap of size = 3.0 x 5.0 ft.

Self weight of bent cap = (2.0)(7.5)(0.15) = 2.25 kip/ft

Factored self-weight = (1.25)(2.25) = 2.8125 kip/ft.

Summary of reactions at pile cap at intermediate piers from the analyses is given in Table 3.18.

Table 3.18 Summary of reactions

Location	a	b	c	d	e	f	g	h
Due to loads from column (kips)	335.53	-11.04	324.70	149.24	168.46	374.26	-22.51	257.94
Due to bent cap DC (kips)	15.54	16.80	16.89	16.87	16.87	16.89	16.80	16.54
Total(kips)	351.07	5.76	341.59	166.11	185.33	391.15	-5.71	274.48

ii) Bending moment calculations

Loads considered include dead loads from super structure, live loads from moving vehicles including dynamic allowance, self weight of the column and pile cap. The pile cap is analyzed using SAP 2000. Maximum positive bending moment occurs at 3.875 ft. from pile E and the value is 494.11 kip-ft. Maximum negative bending moment occurs at pile *f* and the value is 223.84 kip-ft. The cap can be designed for the maximum factored bending moment 494.11 kip-ft.

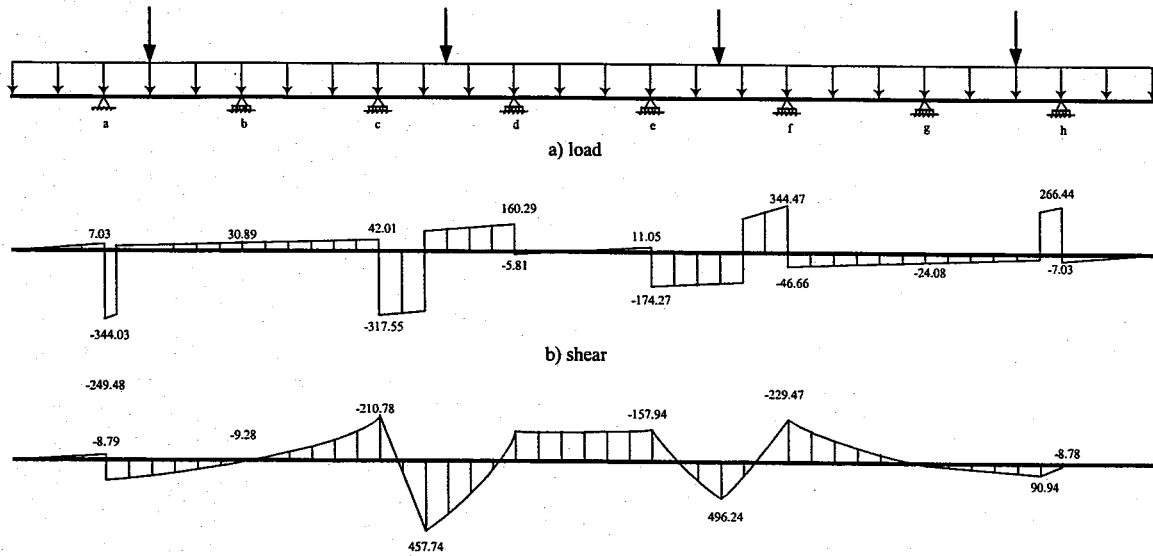

Figure 3.59 a) load on pile cap, b) shear force diagram and c) bending moment distribution diagram

iii) Determine the flexure reinforcement

Determine whether or not deep beam provisions of ACI-11.8 apply.

$$d = 0.9 h = 0.9(5\text{ft}) = 4.5 \text{ ft} = 54 \text{ in.}$$

L_n = length of clear span measured face to face of supports (Fig. 3.60)

$$\frac{L_n}{d} = \frac{58}{54} = 1.07 < 5 \text{ Therefore, ACM 1.8 for deep beam is applicable.}$$

Then deep beam theory would be applied for the pile cap design.

Design positive moment, $+M_u = 494.11 \text{ kip-ft}$

$$\text{Required } R_n = \frac{M_u}{\phi b d^2} = \frac{494.11(12000)}{0.90(24)(81)^2} = 41.84 \text{ psi}$$

From Fig. 3.11, for $R_n = 41.84 \text{ psi}$, $\rho = 0.004$

$$A_s = \rho b d = 0.004 (24)(81) = 7.776 \text{ in}^2 \text{ (positive steel)}$$

Use 10 #8 bar ($A_s = 7.90 \text{ in}^2$) uniformly placed along the two faces over a depth of 1 ft from the bottom.

Design negative moment, $-M_u = 223.84$ kip-ft

$$A_s = \frac{M_u}{\phi f_y j d} \geq \frac{200bd}{f_y} \geq \frac{3\sqrt{f'_c}}{\phi f_y} bd$$

$$j d = 0.2(l + 1.5h) \quad \text{for } 1 \leq \frac{l}{h} \leq 2.5$$

$$j d = 0.5l \quad \text{for } \frac{l}{h} < 1.0$$

where

l = the effective span measured center to center of supports or 1.15 clear span
whichever is smaller

$$l = \min. \begin{cases} 1.5(4.82)(12) = 87 \text{ in} \\ 6(12) = 72 \text{ in} \end{cases}$$

$$= 72 \text{ in.}$$

Check $\frac{l}{h} = \frac{72}{90} = 0.80 < 1$, then use nominal steel for A_{s1} and A_{s2}

Determine A_s

$$A_s = \frac{M_u}{\phi f_y j d} = \frac{223.84(12,000)}{0.90(60,000)(0.5)(72)} = 1.38 \text{ in.}^2$$

$$A_s \geq \frac{200bd}{f_y} = \frac{200(36)(54)}{60,000} = 6.3 \text{ in.}^2$$

$$A_s \geq \frac{3\sqrt{f'_c}}{\phi f_y} bd = \frac{3\sqrt{5000}}{0.90(60,000)} (36)(81) = 11.46 \text{ in.}^2$$

Hence, use nominal steel $A_s = 11.46 \text{ in.}^2$

In cases where the ratio l/h has a value equal to or less than 1.0, use nominal steel for A_{s1} is placed in the top 20% of the beam depth and provide the total A_s in the next 60% of the abutment depth.

The reinforcement area A_{s1} is nominal steel

$$A_s = 11.46 \text{ in.}^2$$

Use 12 #9 bar ($A_s = 12.0 \text{ in.}^2$) in the top of 1 ft of the abutment on both faces of the beam.

The reinforcement area A_{s2} is

$$A_s = 11.46 \text{ in.}^2$$

Use 12 #9 bar ($A_s = 12.0 \text{ in}^2$) in next 3 ft of the abutment on both faces of the beam.

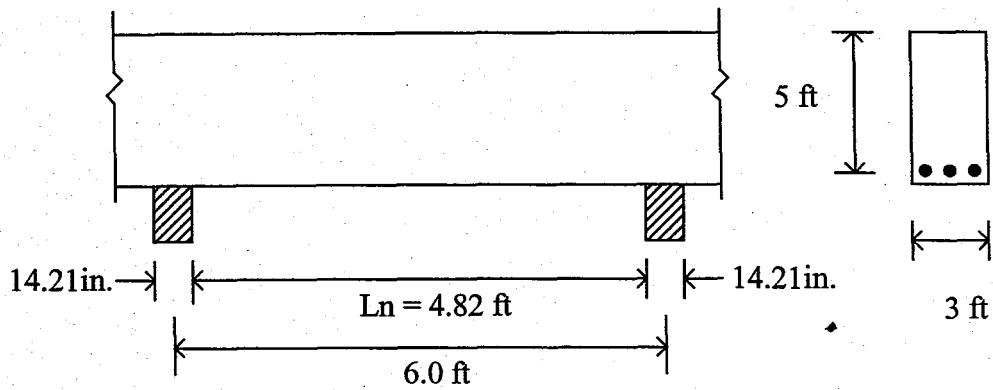

Figure 3.60 Pile cap (deep beam)

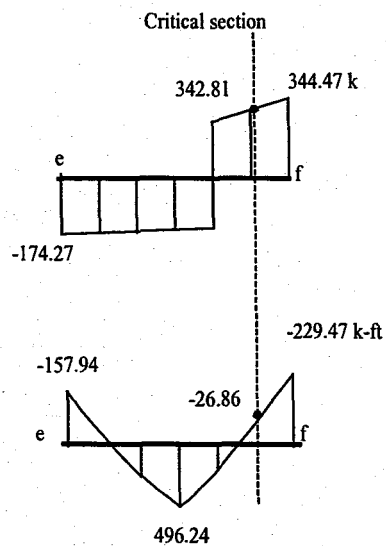

Figure 3.61 Shear and moment at critical section

Critical section should be taken at the face of the support. ACM 1.8.3 indicates that ordinary beam expressions for V_c given in ACI-11.3 applies to continuous deep beams.

V_c from ACM 1.3.1 is calculated as

$$V_c = \left[1.9\sqrt{f'_c} + 2,500\rho_w \frac{V_u d}{M_u} \right] b_w d \leq 3.5\sqrt{f'_c} b_w d$$

$$V_u = 342.81 \text{ kips (given from Fig. 3.61)}$$

$$M_u = -26.86 \text{ kip-ft (given from Fig. 3.61)}$$

$$\frac{V_u d}{M_u} = \frac{342.84(54)}{26.86(12)} = 10.1$$

However according to ACI-11.3.2.1 take $\frac{V_u d}{M_u} = 1$

$$\rho_w = \frac{11.46}{36(54)} = 0.0059$$

$$v_c = \left[1.9\sqrt{5,000} + 2,500(0.0059)(1) \right]$$

$$= 149.10 \text{ psi}$$

$$\text{upper limit } v_c = 3.5 \sqrt{f'_c}$$

$$= 3.5\sqrt{5,000}$$

$$= 247.5 \text{ psi}$$

Nominal shear stress at face of support,

$$v_n = \frac{V_u}{\phi b_w d} = \frac{342.81(1,000)}{0.85(36)(54)} < v_{c \text{ max}}, \text{ Hence the cross section adequate.}$$

$$\Phi V_c = 0.85(149.10)(36)(54)$$

$$= 246,372.84 \text{ lbs}$$

$$= 246.37 \text{ kips}$$

$$V_u = \Phi V_c + \Phi V_s$$

Since $\Phi V_c < V_u$, (246.37 kips < 342.81 kips)

Hence shear reinforcement is necessary.

Vertical shear reinforcement

$$V_s = V_u - V_{c \text{ max}}$$

$$= 342.81 - 246.37 = 96.44 \text{ kips.}$$

Provide shear reinforcement according to ACI eqn.11-15.

$$V_s = \frac{A_v f_y d}{s}$$

Spacing of U shaped web shear reinforcement s is given by

$$s = \frac{A_v f_y d}{V_s}$$

Using #4 bars $A_v = 2 (0.20) = 0.40 \text{ in}^2$

$$s = \frac{0.40(60,000)(54)}{96.44(1,000)} = 13.44 \text{ in.}$$

Provide #4 bars two legged stirrups at 13.5 in. center to center throughout the span.

Horizontal shear reinforcement (ACI 11.8.10)

The maximum permissible spacing of vertical bars $s_h = d/3$ or 18 in.

$$s_v = \frac{54}{3} = 18 \text{ in. using } s_v = 18 \text{ in.}$$

Minimum $A_h = 0.0025b_w s_v = 0.0025(36)(18) = 1.62 \text{ in.}^2$

Using #9 bars placed horizontally on both faces of the beam. $A_v = 2(1) = 2 \text{ in.}^2$

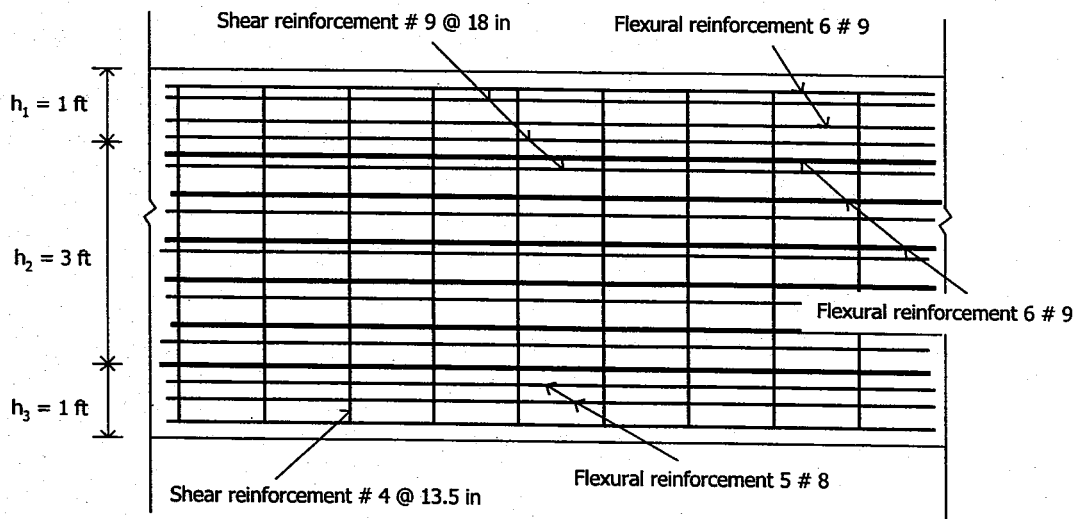

Figure 3.62 Reinforcement details of pile cap

3.8 Pile Foundation for Interior Pier

A. Load for each pile

Total load on pile cap (Fig.3.59) is determined from the following;

$$\begin{aligned} P_u &= 3.51.05 + 5.74 + 359.57 + 166.10 + 185.32 + 391.13 - 5.72 + 273.46 \\ &= 1,726.65 \text{ kips} \end{aligned}$$

Assume 8 piles to resist the load and this load to be carried equally by each of the piles. Load on each of the pile is

$$P_u = 1,726.65 / 8 = 215.83 \text{ kips}$$

B. Minimum pile length

The minimum length required is based on the skin friction capacity of vertical pile. α method is used in this design in determining the skin friction. (AASHTO 10.7.3.3.2a). For the present design, a section HP 14 x 117 section is assumed.

Section properties of HP 14 x 117;

$A = 34.40 \text{ in.}^2$	$d = 14.21 \text{ in.}$
$t_w = 0.805 \text{ in.}$	$b_f = 14.885 \text{ in.}$
$t_f = 0.805 \text{ in.}$	$I_y = 443.00 \text{ in.}^4$
$S_y = 59.50 \text{ in.}^3$	$r_y = 3.59 \text{ in.}$
$Z_y = 91.40 \text{ in.}^3$	$h = 11.25 \text{ in.}$

Fig. 3.63 shows the soil profile below the pier. Two soil layers consist of stiff clay with undrained cohesive strength, S_u equal to 1,600 psi and very stiff clay layer with S_u of 4,000 psi.

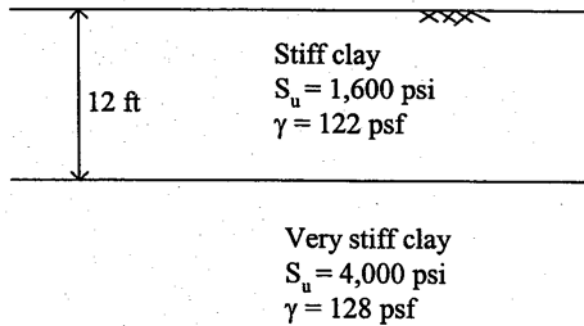

Figure 3.63 Soil profile below the pier

Skin friction; α Method

$$f = \alpha S_u$$

i) Stiff clay layer

Adhesion factor is obtained from Fig.3.11a

$$L = 12(12) = 144 \text{ in.}$$

$$10B = 10(14.21) = 142.1 \text{ in.}$$

$$20B = 20 \times 14.21 = 284.2 \text{ in.}$$

$$L \approx 20B, \text{ From Fig.3.24c. with } S_u = 1.6 \text{ kip/ft}^2, \alpha = 0.80.$$

Calculate skin friction of stiff clay layer

Friction capacity per 1 ft of pile $Q_s = f L_p$ (L_p = surface area)

$$\begin{aligned} Q_s &= \alpha C_u L_p \\ &= 0.80(1.6)[(14.21/12)+(14.885/12)](2) \\ &= 6.20 \text{ kip/ft} \end{aligned}$$

ii) Very stiff clay layer

Fig. 3.24b is used to find α for this layer by assuming $L = 23$ ft.

From Fig. 3.24b with $S_u = 4.0$ kip/ft²,

$$10B = 10(14.21) = 142.1 \text{ in.}, \quad \alpha = 0.23$$

$$20B = 20 \times 14.21 = 284.2 \text{ in.}, \quad \alpha = 0.53$$

$$L = 23(12) = 276 \text{ in.}, \quad \alpha = 0.52$$

Calculate skin friction of stiff clay per 1 ft of pile

$$\begin{aligned} Q_s &= \alpha S_u L_p \\ &= 0.52 (4.0)[(14.21/12)+(14.885/12)](2) \\ &= 10.08 \text{ kip/ft} \end{aligned}$$

The length of the embedment, l_2 , into the very stiff clay by using resistance factor (AASHTO, Table 10.5.5-2) $\Phi = 0.7$

Frictional capacity of the pile / load on each pile

$$\begin{aligned} \Phi Q_{s1} l_1 + \Phi Q_{s2} l_2 / P_u \\ (0.7)(6.20)(12) + (0.7)(10.08) l_2 / 215.83 \text{ kips} \\ l_2 / 23.21 \text{ ft.} \end{aligned}$$

Use $l_2 = 23.25$ ft, the total length of pile is $12 + 23.25 = 35.25$ ft.

Provide a total length of the pile = 48 ft.

C. Pile bearing capacity

Considering only the gravity load, the factored bearing resistance, Q_R is given by

$$\Phi Q_n = \Phi_{qp} Q_p + \Phi_{qs} Q_s$$

End bearing capacity,

End of pile is in very stiff clay layer with $S_u = 4,000$ psf and Q_p is given by

$$\begin{aligned} Q_p &= 9 S_u A_p \\ &= 9 (4.0)(14.2/12)(14.885) \\ &= 52.88 \text{ kips} \end{aligned}$$

Skin friction capacity (by α - method)

$$\begin{aligned} \text{Stiff clay } Q_s &= \alpha S_u L_p L \\ &= 0.8(1.6)[(14.21/12)+(14.885/12)](2)(12) \\ &= 74.48 \text{ kips} \end{aligned}$$

$$\begin{aligned} \text{Very stiff clay } Q_s &= \alpha S_u L_p L \\ &= 0.52(4.0)[(14.21/12)+(14.885/12)](2)(23.25) \end{aligned}$$

$$= 234.50 \text{ kips}$$

$$\text{Total } Q_s = 74.48 + 234.50 = 309 \text{ kips}$$

$$Q_R = \Phi Q_p + \Phi Q_s$$

$$= (0.7)(52.88) + (0.7)(309)$$

$$= 253.32 \text{ kips}$$

$$\text{For 8 piles, } Q_R = 8(253.32) = 2,026.56 \text{ kips} > P_u$$

Thus piles have sufficiency bearing capacity.

References

1. AASHTO, "LRFD Bridges Design Specification," 2nd ed., American Association of State Highway and Transportation Officials, Washington, DC., 1998.
2. Abenderoth, R.E., and Greimann, L.F., "The Design of Piles in Integral Abutment Bridges," Synopsis, Bridge Engineering Center, Department of Civil and Construction Engineering, Iowa State University, 1983.
3. Abenderoth, R.E., and Greimann, L.F., "Abutment Piles Design for Bridges," ASCE Journal of Structural Engineering, Vol. 115, No. 11, November, 1989.
4. AISC, "Load and Resistance Factor Design," Manual of steel construction, Volume I, Chicago, Illinois, 1998.
5. American Iron and Steel Institute, "Integral Abutments for Steel girders," Highway structures design handbook, Volume II, Chapter 5, October, 1996.
6. Colorado Dept. of Transportation, "Bridge Design Manual," Denver, Colorado.
7. Cook R.D., and Young, W.C., "Advanced Mechanics of Materials," 2nd ed., Prentice Hall, Upper Saddle River, New Jersey, 1998.
8. Das, B.M., "Principal of Foundation Engineering", International Thomson Publishing Company, New York, 1998.
9. Evans, L.T. and Duncan, J.M., "Simplified Analysis of Laterally Loaded Piles," Report No. UCB/GT/82-04, University of California, Berkeley, California, July, 1982.

10. Federal Highway Administration, "Integral, No joint Structures and Required Provisions for Movement," FHWA Technical advisory T 5140.13, January, 1980.
11. Greimann, L.F., et al, " Pile Design and Tests for Integral Abutment Bridges," Final report, Iowa DOT project HR-273 ERI project 1780, Iowa State University, Ames, Iowa, December, 1987.
12. Greimann, L.F., and Wolde-Tinsae, A.M., "Abutment Pile Design for Jointless Bridges," ASCE Journal of Structural Engineering, Vol. 114, No. 6, June, 1988.
13. Heins, C.P., and Firmage, D.A., "Design of Model Steel Highway Bridges," John Wiley & Sons, New York, 1979.
14. Jorgenson, J.L., "Behavior of Abutment Piles in an Integral Abutment in Response to Bridge Movements," Transportation Research Record 903, TRB, National Research Council, Washington, D.C., 1983, pp. 72-79.
15. Lee, H.W., and Sarsam, M.B., "Analysis of Integral Abutment Bridges," South Dakota Transportation, March, 1973.
16. Illinois Dept. of Transportation, "Bridge Design Manual," Springfield, Illinois, 1994.
17. Maine. Dept. of Transportation "Bridge Design Manual," Augusta, Maine, 1993.
18. Nawy, E.G., "Reinforced Concrete a Fundamental Approach," 4^h ed., Prentice-Hall, Inc., Upper Saddle River, New Jersey, 2000.
19. New Jersey Dept. of Transportation, "Design manual bridges and structures," Trenton, New Jersey, 1987.

20. New York Dept. of Transportation, "Bridge Design Manual," 2nd ed., Albany, New York, April, 1999.
21. Ohio Dept. of Transportation, "Bridge design manual," Columbus, Ohio, 1982.
22. Reese, L.C. et al, " Computer Program LPILE Plus Version 4.0 Technical Manual," Ensoft, Inc., Austin, Texas, 2000.
23. Reese, L.C. et al, " Computer Program LPILE Plus Version 4.0 User's Guide," Ensoft, Inc., Austin, Texas, 2000.
24. Segui, W.T., "LRFD Steel Design," 2nd ed., International Thomson Publishing Inc., California, 1999.
25. Tomlinson, MJ., "Foundation Design and Construction," 0^h ed., Longman Sicientific and Technical, New York, 1995.
26. Wang, C.K. and Salmon, C.G., "Reinforced Concrete Design," 6th ed., Addison' Wesley Educational Publishers, Inc., California, 1997.
27. Wang, S. and Reese, L.C., "COMP624P-Laterally Loaded Pile Analysis Program. for the Microcomputer Version 2.0," FHWA publication No.FHWA-SA-91-048, August, 1993.
28. Wolde-Tinsae, A.M., et al., "Skewed Bridges with Integral Abutments," Transportation Research Record 903, TRB, National Research council, Washington, D.C., 1983, pp. 86-94.