

DUAL CABLE SUPPORTS FOR WIDE INTERSECTIONS

Contract C9G79

FDOT Financial ID No. 4194971B201

FINAL REPORT

**TASK 4- Parametric Study and Recommendations
for Simplified Analysis Method**

Prepared for:

**FLORIDA DEPARTMENT OF TRANSPORTATION
CENTRAL OFFICE**

Prepared by:

**AYRES ASSOCIATES, COA 4356
Principal Investigator – Hisham Sunna, PhD, PE
Project Engineer – David Johnson, PE**

October 16, 2015

DUAL CABLE SUPPORTS FOR WIDE INTERSECTIONS

FINAL REPORT

TASK 4- Parametric Study and Recommendations for Simplified Analysis Method

AYRES ASSOCIATES

8875 Hidden River Parkway • Suite 200

Tampa, FL 33637-1035

813.978.8688 • Fax 813.978.9369

www.AyresAssociates.com

Table of Contents

	<u>Page No.</u>
Introduction	1
Task 1 – Rigorous Analysis Method	1
Task 2 – Approximate/Simplified Analysis Method	4
Task 3 – Technical Plan for Developing Approximate/Simplified Analysis Method.....	10
Task 4 – Parametric Study and Recommendations for Simplified Analysis Method.....	15

List of Appendices

Appendix A Sample Partial GTSTRUDL Input for Cable Analysis
Appendix B Span Wire Intersection Examples
Appendix C – Single Span Wire Study
Appendix D – Box Span Wire Study
Appendix E – Hanging Box Span Wire Study
Appendix F – GTStrudl Screenshots
Appendix G – Simplified Analysis Procedure
Appendix H – References

List of Figures

	<u>Page No.</u>
Figure 1 Pole-cable-light System (Source: ATLAS Manual).....	5
Figure 2 Cable-only Solution (Source: ATLAS Manual)	5
Figure 3 Pole-only Solution (Source: ATLAS Manual)	6
Figure 4 Unstable System (Source: ATLAS Manual)	7
Figure 5 Cable Tension vs. Wind Velocity – FDOT/UF Study	9
Figure 6 – Single Span Wire Intersection with 0° Skew	1
Figure 7 – Box Span Wire Intersection with 0° Skew	1
Figure 8 – Hanging Box Span Wire Intersection with 0° Skew.....	2
Figure 9 – Box Span Wire Intersection with 30° Skew	2
Figure 10 – Hanging Box Span Wire Intersection with 15° Skew	3
Figure 11 – GTS: Single Span Pole Deflection Study: No Pole Deflection vs. Tapered Pole, 0.7 & 0.4 Coefficients, with Backplates.....	1
Figure 12 – GTS: Single Span Pole Deflection Study: Straight Pole vs. Tapered Pole, 0.7 & 0.4 Coefficients, with Backplates.....	2
Figure 13 – GTS: 3 Headed Aluminum Signals, 110 mph, with Backplates	3
Figure 14 – GTS: 3 Headed Aluminum Signals, 130 mph, with Backplates	4

Figure 15 – GTS: 3 Headed Aluminum Signals, 150 mph, with Backplates	5
Figure 16 – GTS: 3 Headed Aluminum Signals, 110 mph, with Backplates	6
Figure 17 – GTS: 3 Headed Aluminum Signals, 130 mph, with Backplates	7
Figure 18 – GTS: 3 Headed Aluminum Signals, 150 mph, with Backplates	8
Figure 19 – GTS: 3 Headed Aluminum Signals, 110 mph, with Backplates	9
Figure 20 – GTS: 3 Headed Aluminum Signals, 130 mph, with Backplates	10
Figure 21 – GTS: 3 Headed Aluminum Signals, 150 mph, with Backplates	11
Figure 22 – GTS: 3 Headed Polycarbonate Signals, 110 mph, with Backplates	12
Figure 23 – GTS: 3 Headed Polycarbonate Signals, 130 mph, with Backplates	13
Figure 24 – GTS: 3 Headed Polycarbonate Signals, 150 mph, with Backplates	14
Figure 25 – GTS: 3 Headed Aluminum Signals with No Backplate, 110 mph, with Backplates	15
Figure 26 – GTS: 3 Headed Aluminum Signals with No Backplate, 130 mph, with Backplates	16
Figure 27 – GTS: 3 Headed Aluminum Signals with No Backplate, 150 mph, with Backplates	17
Figure 28 – GTS: 5 Headed Aluminum Signals, 110 mph, with Backplates	18
Figure 29 – GTS: 5 Headed Aluminum Signals, 130 mph, with Backplates	19
Figure 30 – GTS: 5 Headed Aluminum Signals, 150 mph, with Backplates	20
Figure 31 – GTS: 5 Headed Polycarbonate Signals, 110 mph, with Backplates	21
Figure 32 – GTS: 5 Headed Polycarbonate Signals, 130 mph, with Backplates	22
Figure 33 – GTS: 5 Headed Polycarbonate Signals, 150 mph, with Backplates	23
Figure 34 – GTS: Percent Change in Cable Tension between 3 Headed Aluminum Signals with and without Backplates	27
Figure 35 – ATLAS: 3 Headed Aluminum Signals, 110 mph, with Backplates	28
Figure 36 – ATLAS: 3 Headed Aluminum Signals, 130 mph, with Backplates	29
Figure 37 – ATLAS: 3 Headed Aluminum Signals, 150 mph, with Backplates	30
Figure 38 – ATLAS: 3 Headed Aluminum Signals, 110 mph, with Backplates	31
Figure 39 – ATLAS: 3 Headed Aluminum Signals, 130 mph, with Backplates	32
Figure 40 – ATLAS: 3 Headed Aluminum Signals, 150 mph, with Backplates	33
Figure 41 – ATLAS: 3 Headed Polycarbonate Signals, 110 mph, with Backplates	34
Figure 42 – ATLAS: 3 Headed Polycarbonate Signals, 130 mph, with Backplates	35
Figure 43 – ATLAS: 3 Headed Polycarbonate Signals, 150 mph, with Backplates	36
Figure 44 – ATLAS: 3 Headed Aluminum Signals without Backplates, 110 mph	37
Figure 45 – ATLAS: 3 Headed Aluminum Signals without Backplates, 130 mph	38
Figure 46 – ATLAS: 3 Headed Aluminum Signals without Backplates, 150 mph	39
Figure 47 – ATLAS: 5 Headed Aluminum Signals, 110 mph, with Backplates	40
Figure 48 – ATLAS: 5 Headed Aluminum Signals, 130 mph, with Backplates	41
Figure 49 – ATLAS: 5 Headed Aluminum Signals, 150 mph, with Backplates	42
Figure 50 – ATLAS: 5 Headed Polycarbonate Signals, 110 mph, with Backplates	43
Figure 51 – ATLAS: 5 Headed Aluminum Signals, 130 mph, with Backplates	44
Figure 52 – ATLAS: 5 Headed Aluminum Signals, 150 mph, with Backplates	45
Figure 53 – GTStrudl Pole Base Moment CSR Ratio with 3 Headed, Aluminum Traffic Signals with Backplates, 110 mph Wind Speed	3
Figure 54 – GTStrudl Pole Base Moment CSR Ratio with 3 Headed, Aluminum Traffic Signals with Backplates, 130 mph Wind Speed	4
Figure 55 – GTStrudl Pole Base Moment CSR Ratio with 3 Headed, Aluminum Traffic Signals with Backplates, 150 mph Wind Speed	5
Figure 56 – GTStrudl Pole Base Moment CSR Ratio with 3 Headed, Aluminum Traffic Signals with Backplates, 110 mph Wind Speed	6
Figure 57 – GTStrudl Pole Base Moment CSR Ratio with 3 Headed, Aluminum Traffic Signals with Backplates, 130 mph Wind Speed	7
Figure 58 – GTStrudl Pole Base Moment CSR Ratio with 3 Headed, Aluminum Traffic Signals with Backplates, 150 mph Wind Speed	8

Figure 59 – GTStrudl Pole Base Moment CSR Ratio with 3 Headed, Aluminum Traffic Signals without Backplates, 110 mph Wind Speed	9
Figure 60 – GTStrudl Pole Base Moment CSR Ratio with 3 Headed, Aluminum Traffic Signals without Backplates, 130 mph Wind Speed	10
Figure 61 – GTStrudl Pole Base Moment CSR Ratio with 3 Headed, Aluminum Traffic Signals without Backplates, 150 mph Wind Speed	11
Figure 62 – GTStrudl Pole Base Moment CSR Ratio with 3 Headed, Aluminum Traffic Signals without Backplates, 110 mph Wind Speed	12
Figure 63 – GTStrudl Pole Base Moment CSR Ratio with 3 Headed, Aluminum Traffic Signals without Backplates, 130 mph Wind Speed	13
Figure 64 – GTStrudl Pole Base Moment CSR Ratio with 3 Headed, Aluminum Traffic Signals without Backplates, 150 mph Wind Speed	14
Figure 65 – GTStrudl Pole Base Moment CSR Ratio with 5 Headed, Aluminum Traffic Signals with Backplates, 110 mph Wind Speed	15
Figure 66 – GTStrudl Pole Base Moment CSR Ratio with 5 Headed, Aluminum Traffic Signals with Backplates, 130 mph Wind Speed	16
Figure 67 – GTStrudl Pole Base Moment CSR Ratio with 5 Headed, Aluminum Traffic Signals with Backplates, 150 mph Wind Speed	17
Figure 68 – GTStrudl Pole Base Moment CSR Ratio with 5 Headed, Aluminum Traffic Signals with Backplates, 110 mph Wind Speed	18
Figure 69 – GTStrudl Pole Base Moment CSR Ratio with 5 Headed, Aluminum Traffic Signals with Backplates, 130 mph Wind Speed	19
Figure 70 – GTStrudl Pole Base Moment CSR Ratio with 5 Headed, Aluminum Traffic Signals with Backplates, 150 mph Wind Speed	20
Figure 71 – GTS: Concrete Pole CSR Ratio (30 degree Wind Angle / 30 degree Box Skew) vs. Span Length, 110 mph Wind Speed , with Backplates	25
Figure 72 – GTS: Concrete Pole CSR Ratio (30 degree Wind Angle / 30 degree Box Skew) vs. Span Length, 130 mph Wind Speed, with Backplates	26
Figure 73 – GTS: Concrete Pole CSR Ratio (30 degree Wind Angle / 30 degree Box Skew) vs. Span Length, 150 mph Wind Speed, with Backplates	27
Figure 74 – GTS: Cable Tension Results versus Span Length for Models with Concrete Poles, 110 mph Wind Speed, with Backplates	1
Figure 75 – GTS: Cable Tension Results versus Span Length for Models with Concrete Poles, 130 mph Wind Speed, with Backplates	2
Figure 76 – GTS: Cable Tension Results versus Span Length for Models with Concrete Poles, 150 mph Wind Speed, with Backplates	3
Figure 77 – GTS: Cable Tension Results versus Span Length for Models with Steel Poles, 110 mph Wind Speed, with Backplates	4
Figure 78 – GTS: Cable Tension Results versus Span Length for Models with Steel Poles, 130 mph Wind Speed, with Backplates	5
Figure 79 – GTS: Cable Tension Results versus Span Length for Models with Steel Poles, 150 mph Wind Speed, with Backplates	6
Figure 80 – GTS: Cable Tension Versus Span Length and Trend lines with Concrete Poles, 110 mph Wind Speed, with Backplates	8
Figure 81 – GTS: Cable Tension Versus Span Length and Trend lines with Concrete Poles, 130 mph Wind Speed, with Backplates	9
Figure 82 – GTS: Cable Tension Versus Span Length and Trend lines with Concrete Poles, 150 mph Wind Speed, with Backplates	10
Figure 83 – GTS: Cable Tension Versus Span Length and Trend lines with Steel Poles, 110 mph Wind Speed, with Backplates	11

Figure 84 – GTS: Cable Tension Versus Span Length and Trend lines with Steel Poles, 130 mph Wind Speed, with Backplates	12
Figure 85 – GTS: Cable Tension Versus Span Length and Trend lines with Steel Poles, 150 mph Wind Speed, with Backplates	13
Figure 86 – GTS: Cable Tension versus Number of Signals, 110 mph Wind Speed, 180 Ft. Span, with Backplates	14
Figure 87 – GTS: Cable Tension versus Number of Signals, 130 mph Wind Speed, 180 Ft. Span, with Backplates	15
Figure 88 – GTS: Cable Tension versus Number of Signals, 150 mph Wind Speed, 180 Ft. Span, with Backplates	16
Figure 89 – GTS: Cable Tension versus Number of Signals, 110 mph Wind Speed, 200 Ft. Span, with Backplates	17
Figure 90 – GTS: Cable Tension versus Number of Signals, 130 mph Wind Speed, 200 Ft. Span, with Backplates	18
Figure 91 – GTS: Cable Tension versus Number of Signals, 150 mph Wind Speed, 200 Ft. Span, with Backplates	19
Figure 92 – GTS: Cable Tension versus Number of Signals, 110 mph Wind Speed, 220 Ft. Span, with Backplates	20
Figure 93 – GTS: Cable Tension versus Number of Signals, 130 mph Wind Speed, 220 Ft. Span, with Backplates	21
Figure 94 – GTS: Cable Tension versus Number of Signals, 150 mph Wind Speed, 220 Ft. Span, with Backplates	22
Figure 95 – GTS: Cable Tension versus Number of Signals, 110 mph Wind Speed, 240 Ft. Span, with Backplates	23
Figure 96 – GTS: Cable Tension versus Number of Signals, 130 mph Wind Speed, 240 Ft. Span, with Backplates	24
Figure 97 – GTS: Cable Tension versus Number of Signals, 150 mph Wind Speed, 240 Ft. Span, with Backplates	25
Figure 98 – GTS: Cable Tension versus Number of Signals, 110 mph Wind Speed, No Skew, with Backplates	26
Figure 99 – GTS: Cable Tension versus Number of Signals, 130 mph Wind Speed, No Skew, with Backplates	27
Figure 100 – GTS: Cable Tension versus Number of Signals, 150 mph Wind Speed, No Skew, with Backplates	28
Figure 101 – GTS: Cable Tension versus Number of Signals, 110 mph Wind Speed, 15 Degree Skew, with Backplates	29
Figure 102 – GTS: Cable Tension versus Number of Signals, 130 mph Wind Speed, 15 Degree Skew, with Backplates	30
Figure 103 – GTS: Cable Tension versus Number of Signals, 150 mph Wind Speed, 15 Degree Skew, with Backplates	31
Figure 104 – GTS: Cable Tension versus Number of Signals, 110 mph Wind Speed, 30 Degree Skew, with Backplates	32
Figure 105 – GTS: Cable Tension versus Number of Signals, 130 mph Wind Speed, 30 Degree Skew, with Backplates	33
Figure 106 – GTS: Cable Tension versus Number of Signals, 150 mph Wind Speed, 30 Degree Skew, with Backplates	34
Figure 107 – GTS: Cable Tension versus Number of Signals, Hanging Box and Single Span, 110 mph Wind Speed, with Backplates	37
Figure 108 – GTS: Cable Tension versus Number of Signals, Hanging Box and Single Span, 130 mph Wind Speed, with Backplates	38

Figure 109 – GTS: Cable Tension versus Number of Signals, Hanging Box and Single Span, 150 mph Wind Speed, with Backplates	39
Figure 110 – Typical Single Span Model	1
Figure 111 – Isometric View of Typical Single Span Model	1
Figure 112 – Isometric View of Deflected Shape for Single Span Model	2
Figure 113 – Plan View of Deflected Shape for Single Span Model.....	3
Figure 114 – Elevation View of Deflected Shape for Single Span Model	4
Figure 115 – Isometric View of Typical Box Configuration Model	5
Figure 116 – Isometric View of Deflected Shape for Box Configuration Model, 90 Degree Wind Angle.....	5
Figure 117 – Plan View of Deflected Shape for Box Configuration Model, 90 Degree Wind Angle	6
Figure 118 – Elevation View of Deflected Shape for Box Configuration Model, 90 Degree Wind Angle.....	6
Figure 119 – Isometric View of Deflected Shape for Box Configuration Model, 45 Degree Wind Angle.....	7
Figure 120 – Plan View of Deflected Shape for Box Configuration Model, 45 Degree Wind Angle	7
Figure 121 – Elevation View of Deflected Shape for Box Configuration Model, 45 Degree Wind Angle.....	8
Figure 122 – Plan View of Typical Hanging Box Configuration Model.....	9
Figure 123 – Isometric View of Typical Hanging Box Configuration Model	10
Figure 124 – Plan View of Deflected Shape for Hanging Box Configuration Model, 90 Degree Wind Angle.....	11
Figure 125 – Isometric View of Deflected Shape for Hanging Box Configuration Model, 90 Degree Wind Angle	12
Figure 126 – Plan View of Deflected Shape for Hanging Box Configuration Model, 45 Degree Wind Angle.....	13
Figure 127 – Isometric View of Deflected Shape for Hanging Box Configuration Model, 45 Degree Wind Angle	14
Figure 128 – Plan View of Deflected Shape for Hanging Box Configuration Model, 30 Degree Skew, 90 Degree Wind Angle.....	15
Figure 129 – Isometric View of Deflected Shape for Hanging Box Configuration Model, 30 Degree Skew, 90 Degree Wind Angle	16
Figure 130 – GTS: Pole Base Moment Ratio (Minor Axis / Major Axis) Versus Number of Signals, Box Span, 3 Headed Aluminum Signals with Backplates, 110 mph Wind Speed1	
Figure 131 – GTS: Pole Base Moment Ratio (Minor Axis / Major Axis) Versus Number of Signals, Box Span, 3 Headed Aluminum Signals with Backplates, 130 mph Wind Speed2	
Figure 132 – GTS: Pole Base Moment Ratio (Minor Axis / Major Axis) Versus Number of Signals, Box Span, 3 Headed Aluminum Signals with Backplates, 150 mph Wind Speed3	
Figure 133 – GTS: Pole Base Moment Ratio (Minor Axis / Major Axis) Versus Number of Signals, Box Span, 3 Headed Aluminum Signals without Backplates, 110 mph Wind Speed	4
Figure 134 – GTS: Pole Base Moment Ratio (Minor Axis / Major Axis) Versus Number of Signals, Box Span, 3 Headed Aluminum Signals without Backplates, 130 mph Wind Speed	5
Figure 135 – GTS: Pole Base Moment Ratio (Minor Axis / Major Axis) Versus Number of Signals, Box Span, 3 Headed Aluminum Signals without Backplates, 150 mph Wind Speed	6
Figure 136 – GTS: Pole Base Moment Ratio (Minor Axis / Major Axis) Versus Number of Signals, Box Span, 5 Headed Aluminum Signals with Backplates, 110 mph Wind Speed7	

Figure 137 – GTS: Pole Base Moment Ratio (Minor Axis / Major Axis) Versus Number of Signals, Box Span, 5 Headed Aluminum Signals with Backplates, 130 mph Wind Speed	8
Figure 138 – GTS: Pole Base Moment Ratio (Minor Axis / Major Axis) Versus Number of Signals, Box Span, 5 Headed Aluminum Signals with Backplates, 150 mph Wind Speed	9
Figure 139 – GTStrudl Pole Base Moment CSR Ratio with 3 Headed, Aluminum Traffic Signals with Backplates, 110 mph Wind Speed, Box Span	10
Figure 140 – GTStrudl Pole Base Moment CSR Ratio with 3 Headed, Aluminum Traffic Signals with Backplates, 130 mph Wind Speed, Box Span	11
Figure 141 – GTStrudl Pole Base Moment CSR Ratio with 3 Headed, Aluminum Traffic Signals with Backplates, 150 mph Wind Speed, Box Span	12
Figure 142 – GTStrudl Pole Base Moment CSR Ratio with 3 Headed, Aluminum Traffic Signals without Backplates, 110 mph Wind Speed, Box Span	13
Figure 143 – GTStrudl Pole Base Moment CSR Ratio with 3 Headed, Aluminum Traffic Signals without Backplates, 130 mph Wind Speed, Box Span	14
Figure 144 – GTStrudl Pole Base Moment CSR Ratio with 3 Headed, Aluminum Traffic Signals without Backplates, 150 mph Wind Speed, Box Span	15
Figure 145 – GTStrudl Pole Base Moment CSR Ratio with 5 Headed, Aluminum Traffic Signals with Backplates, 110 mph Wind Speed, Box Span	16
Figure 146 – GTStrudl Pole Base Moment CSR Ratio with 5 Headed, Aluminum Traffic Signals with Backplates, 130 mph Wind Speed, Box Span	17
Figure 147 – GTStrudl Pole Base Moment CSR Ratio with 5 Headed, Aluminum Traffic Signals with Backplates, 150 mph Wind Speed, Box Span	18
Figure 148 – GTStrudl Concrete Pole Base Moment CSR Ratio (30 Degree Wind Angle And 0 Degree Box Skew Relative to 30 Degree Box Skew and 90 Degree Wind Angle) with 3 Headed, Aluminum Traffic Signals With Backplates, 110 mph Wind Speed, Box Span	19
Figure 149 – GTStrudl Concrete Pole Base Moment CSR Ratio (30 Degree Wind Angle And 0 Degree Box Skew Relative to 30 Degree Box Skew and 90 Degree Wind Angle) with 3 Headed, Aluminum Traffic Signals With Backplates, 130 mph Wind Speed, Box Span	20
Figure 150 – GTStrudl Concrete Pole Base Moment CSR Ratio (30 Degree Wind Angle And 0 Degree Skew Relative to 30 Degree Box Skew and 90 Degree Wind Angle) with 3 Headed, Aluminum Traffic Signals With Backplates, 150 mph Wind Speed, Box Span	21

List of Tables

	<u>Page No.</u>
Table 1 – GTS: Percent Change in Cable Tension between 3 Headed Aluminum and Polycarbonate Signal Heads, with Backplates	C-24
Table 2 – GTS: Percent Change in Cable Tension between 5 Headed Aluminum and Polycarbonate Signal Heads, with Backplates	C-25
Table 3 – GTS: Percent Change in Cable Tension between 3 Headed Aluminum Signals with and without Backplates, with Backplates	C-26
Table 4 – ATLAS: Percent Change in Cable Tension between 3 Headed Aluminum and Polycarbonate Signal Heads, with Backplates	C-46
Table 5 – ATLAS: Percent Change in Cable Tension between 5 Headed Aluminum and Polycarbonate Signal Heads, with Backplates	C-47
Table 6 – ATLAS: Percent Change in Cable Tension between 3 Headed Aluminum Signal Heads with and without Backplates	C-48
Table 7 – ATLAS: Excerpt of Single Force Coefficient Study, with Backplates	C-49
Table 8 – ATLAS: Legend for Single Force Coefficient Table	C-50

Table 9 – ATLAS: Number of Completed Runs for All Signal Types, Single Span	C-50
Table 10 – ATLAS vs. GTStrudl Comparison	C-51
Table 11 – GTStrudl Cable Tension Results Excerpt with 3 Headed, Aluminum Traffic Signals, with Backplates	D-1
Table 12 – GTStrudl Pole Base Moment CSR Ratio Excerpt with 3 Headed, Aluminum Traffic Signals, with Backplates.....	D-2
Table 13 – GTS: Maximum Cable Tension Box Span – Maximum Cable Tension Single Span with 3 Headed, Aluminum Traffic Signals with Backplates.....	D-21
Table 14 – GTS: Maximum Cable Tension Box Span – Maximum Cable Tension Single Span with 3 Headed, Aluminum Traffic Signals without Backplates.....	D-22
Table 15 – GTS: Maximum Cable Tension Box Span – Maximum Cable Tension Single Span with 5 Headed, Aluminum Traffic Signals with Backplates.....	D-23
Table 16 – GTS: Excerpt of Concrete Pole Moment Ratio for Skewed and Non-Skewed Box Span Configurations, with Backplates	D-24
Table 17 – ATLAS Cable Tension Results for 0 Degree Wind Angle Box Span Configurations	D-28
Table 18 – ATLAS Cable Tension Results for 45 Degree Wind Angle Box Span Configurations, with Backplates	D-28
Table 19 – ATLAS Cable Tension Results for 90 Degree Wind Angle Box Span Configurations, with Backplates	D-29
Table 20 – GTS: Cable Tension Results; Concrete Pole / Steel Pole, with Backplates.....	E-7
Table 21 – GTS: Cable Tension 15 Degree Skew / Cable Tension 0 Degree Skew, with Backplates	E-35
Table 22 – GTS: Cable Tension 30 Degree Skew / Cable Tension 0 Degree Skew, with Backplates	E-35
Table 23 – GTS: Cable Tension 30 Degree Wind Angle / Cable Tension 0 Degree Wind Angle, with Backplates	E-36
Table 24 – GTS: Cable Tension 45 Degree Wind Angle / Cable Tension 0 Degree Wind Angle, with Backplates	E-36
Table 25 – GTS: Cable Tension Ratio, Hanging Box to Single Span, with Backplates.....	E-40

List of Equations

	<u>Page No.</u>
Equation 1 – Magnification Factor for Number of Signals, Hanging Box	G-21
Equation 2 – Skew Factor, Hanging Box	G-21

Introduction

As intersections become wider due to additional through traffic and turn lanes, so does the structural demand on traffic signal support structures. For wide intersections, geometric requirements governing traffic signal placement relative to the stop bar for signal visibility and pole placement outside the clear zone have necessitated such designs as suspended or hanging box span wire configurations to meet the intersection design requirements from a geometric standpoint. Practical limits have been encountered in some span wire configurations on intersections that exceed 150 feet in width. Systems with the dual cable configuration have been used to limit deflection and signal head rotation during high winds. However, these systems are complex to analyze from a design perspective.

The objective of the contract is to develop a simplified design approach validated by a rigorous method. The Department has been using Atlas, a program developed at the University of Florida. Appendix A of the AASHTO Standard Specifications for Structural Supports for Highway Signs, Luminaires, and Traffic Signals, Sixth Edition presents two methods for the analysis of span wire systems: a simplified method that ignores lateral support deflections and a detailed method that accounts for support deflections. The methods require calculating the actual lengths of the wires for each span by 2-dimensional finite element analysis. With the wire lengths known the end user can then determine wire tensions under extreme wind cases. These methods work as presented in the case of span wires attached directly to the supporting poles, but are not readily applicable to suspended box configurations. A comprehensive study of typical, two-wire, span, and hanging box configurations using suitable software is needed with comparisons to existing software and known solutions. Also needed are recommendations for a simplified design method.

The Study consists of five tasks:

1. Identify and discuss methods and software for a rigorous structural analysis of span wire systems.
2. Identify and discuss potential approximate/simplified design methods and the necessary requirements to develop design using these methods.
3. Prepare a detailed technical plan for developing the selected approximate/simplified design method for the design of dual cable traffic signal support systems.
4. Develop the selected method and provide solutions using rigorous structural analysis, comparison to solutions using currently available software, and the recommended approximate/simplified design method.
5. Submit a report containing all the task information, a project summary, and implementation recommendations.

Task 1 – Rigorous Analysis Method

A hanging box span wire assembly analysis is a nonlinear problem; sequence of construction affects dead load forces and geometry. Sag and cable tension are related to each other and also relate to cable lengths. The rigorous analysis method will be used to compare and investigate the effects of simplifying assumptions on the accuracy of the solutions. Rigorous methods would typically include use of finite element analysis software such as STAAD,

GTSTRUDL, ADINA, etc. We have found GTSTRUDL to be particularly capable of analyzing this type of structure using its Isoparametric Cable finite element. The program also has the option of specifying either initial cable tension or sag, a useful feature that will allow flexibility in the analysis envisioned for suspended box dual cable support systems. Target cable sags or initial tensions would be specified, with possible trial and error until an acceptable solution is found. Based on connection details, signal hangers can be modeled as frame elements, and can be rigid pipe (for example), or they could be modeled as 3-d truss elements. Pivotal hangers are typically used in Florida and function as hinges. Signal heads theoretically rotate at those pivots near their point of attachment to the hangers. As such they would not transmit any moment to their connection to the hanger and the wind load can be applied as a point load at the node on the messenger cable where the signal head is attached. In that case it would be adequate to model the hanger as a truss element. If a frame element is used to model a case of a hanger with no pivot, very weak support springs may be needed at the hanger nodes (joints) to prevent structural instability in the solution – where cable elements are connected to a floating frame element. Poles should be modeled as frame elements. Following are some of the key parameters that need to be defined to perform such a rigorous analysis using GTSTRUDL.

IPCABLE Element Properties that need to be defined are:

Cross Section Area AX - effective IPCABLE element cross section area

Self Weight Load SW - This is the self weight of the IPCABLE element in units of force per unit length. SW Global Direction.

Length Factor LF - The LF factor is the ratio of the actual physical length of the IPCABLE element to the element length computed from the element nodal geometry. This factor is taken as 1.0 by default.

Elastic Modulus E - This is the effective elastic modulus (Young's Modulus) of the IPCABLE element.

A cable network (or multiple cable networks) of connected cable elements is defined in the input to the program:

Cable Network Name - Specify the name of the cable network. This name must be unique among all presently defined cable networks and cannot exceed eight characters in length.

Include IPCABLE Elements - Specify a list of IPCABLE elements to be included in the current cable network definition.

Specify Attach Joints - Specify a list of anchor joints or support joints for the new cable network. For example, the joint coordinates for these joints are not modified by the Adjust Cable Network Joint Coordinates prestressing strategy. These would be nodes on the supporting poles.

Sag Position - option if one wants the cable network being defined to be prestressed such that a specified displaced coordinate position target is satisfied at a given joint.

Coordinate Direction - X, Y, or Z button to select the displaced joint coordinate component of the Sag Position target.

Position – The Sag Position target value of the displaced joint coordinate component.

At Joint – The name of the joint at which one wants the Sag Position target to be satisfied by the prestressing process. This joint does not have to be connected to any of the elements named in the Include IPCABLE Elements list.

Tolerance - The prestress analysis attempts to satisfy the Sag Position target within this tolerance. This value has the same units as the Position value.

Initial Tension - if one wants the cable network being defined to be prestressed such that a specified cable tension target is satisfied at a given joint.

Tinit - This is the Initial Tension target tension value.

At Joint - This is the name of the joint at which one wants the Initial Tension target to be satisfied by the prestressing process. The joint must be an element incidence node of one of the IPCABLE elements in the Include IPCABLE Elements list.

Tolerance - The prestress analysis attempts to satisfy the Initial Tension target within this tolerance. This value has the same units as the Tinit value.

Prestress Algorithm - One may select between two prestress analysis strategies or algorithms: the Adjust Cable Length algorithm and the Adjust Cable Network Joint Coordinates algorithm.

Adjust Cable Length - The Adjust Cable Length algorithm modifies the actual lengths of the IPCABLE elements of the cable network. The same length adjustment is applied uniformly to all IPCABLE elements in the cable network.

Adjust Cable Network Joint Coordinates - This algorithm modifies the specified joint coordinate component of the element incidence nodes of all IPCABLE elements in the Include IPCABLE Elements list, with the exception of the joints named in the Specify Attach Joints list.

Convergence Rate - The Convergence Rate is an arbitrary factor that is used to help control the Adjust Cable Lengths prestress algorithm. A value of 1.0 is a good starting value for an Initial Tension target, while a much smaller value, such as 0.005 is more suitable for a Sag Position target. In addition, the Convergence Rate value for a Sag Position target will have a sign (+/-) that is dependent on other characteristics of the prestress analysis problem.

Prestress Analysis Control Data:

The cable prestress analysis iteratively searches for IPCABLE element lengths that satisfy either specified Initial Tension or Sag Position targets associated with specific groups of IPCABLE elements called cable networks. Cable prestress analysis iteration consists of a nonlinear analysis followed by an adjustment of IPCABLE element lengths or joint coordinates so that the next nonlinear analysis produces a solution that is closer to the specified targets.

Maximum Number of Prestress Iterations - Specifies the maximum number of times the cable prestress analysis can make prestressing adjustments to the cable networks. If this number of prestress adjustments is exceeded, the cable prestress analysis is terminated.

Prestress Analysis Convergence Tolerance - The cable prestress analysis stops when the prestressing adjustments get to within this tolerance of the Sag Position or Initial Tension target.

Nonlinear Analysis Control Data:

These data are used to specify the parameter values that control the intermediate nonlinear analyses.

Maximum Number of Equilibrium Iterations - A nonlinear analysis consists of a series of equilibrium correction iterations. This parameter specifies the number of such iterations permitted for each nonlinear analysis. If this number of iterations is exceeded by a nonlinear analysis, that analysis and the entire cable prestress analysis are terminated.

Convergence Tolerance - Each intermediate nonlinear analysis execution must be convergent in order for the cable prestress analysis to continue to the normal desired convergence. Nonlinear analysis convergence is determined by the Convergence Tolerance parameter. When the Displacement or Equilibrium convergence check is less than this tolerance, convergence of the nonlinear analysis is indicated.

Prestress Loading Condition - Is used to select or specify the independent loading condition that will be activated for the cable prestress analysis execution. One may specify an as yet undefined loading condition that will be defined automatically prior to the cable prestress analysis execution, in which case the only applied load will be the IPCABLE SW load.

Appendix A shows example input statements used to define the parameters discussed above to build a dual cable support problem for analysis by GTSTRUDL. Complete test cases will be developed in Task 4.

Task 2 – Approximate/Simplified Analysis Method

Typical software used in Florida for analysis and design of span wire includes FDOT Strain Pole Program (Strain v. 3.0, 2009), which analyzes only single-point attachment, and The University of Florida Bridge Software Institute's ATLAS Program (current version is 6.04). The latter analyzes single point, dual point, as well as suspended box systems, with various degrees of reliability that will be discussed later. Methods used by other states tend to be basic, black-box type programs.

One option to perform the analysis of this type of structure is to employ C# or Visual Basic interface models in GTSTRUDL of typical symmetric and skewed box configurations. Alternatively, the GTSTRUDL input files could be provided designers to modify for their problem. This would require a working knowledge by the designer of the GTSTRUDL software as well as a software license. An annual license of GTSTRUDL or similar finite element program for commercial use would cost many times more than ATLAS, which consultants typically currently use. Thus, it may be worth seeking an option that enables one to eliminate the need for GTSTRUDL or similar finite element program while providing a reliable solution that is suitable for the office.

Another option is to develop a simplified procedure for use with the ATLAS software program. ATLAS has been successfully used for many years for the analysis of span wire systems. Input is achieved through a Graphic User Interface (GUI) that generates an input file. Users have

generally been confident using the program for both analysis and design of single-span wire, although the accuracy of the suspended box analysis has been questioned.

ATLAS accounts for pole deflections, so in essence it meets the definition of the “Detailed Method” as described in Appendix A of AASHTO LTS-6. The general solution process for the cable systems functions is to iterate between: 1) Cable only solutions (Shape Finding) and 2) Pole solutions (Pole deflection due to cable forces).

The cable solution portion takes a standard pole-cable-light system as shown in Figures 1-3 and converts it into two problems.

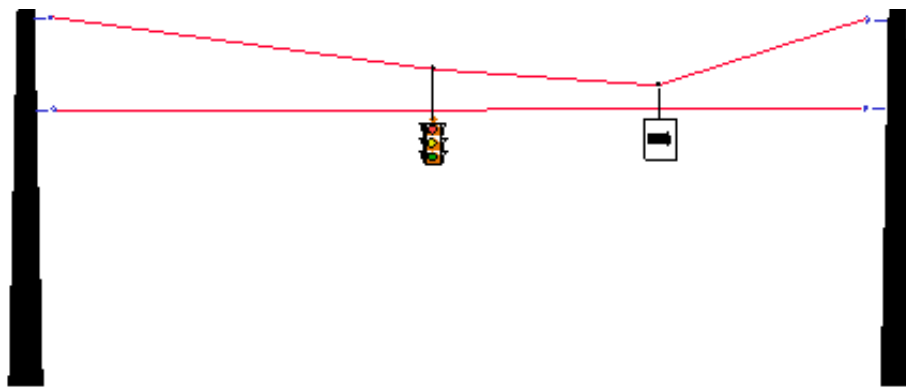

Figure 1 Pole-cable-light System (Source: ATLAS Manual)

The first problem is the cable only solution as shown below in Figure 2.



Figure 2 Cable-only Solution (Source: ATLAS Manual)

The second problem is the solution of just the poles due to the cable tensions from the cable only solution (Figure 3).

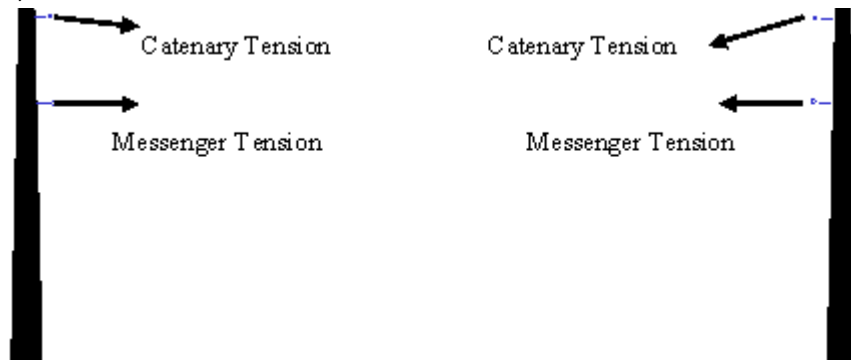

Figure 3 Pole-only Solution (Source: ATLAS Manual)

Due to the cable tensions, the poles deflect. The pole deflection causes the fixed supports in the cable problem to be moved and a new cable solution is required. The solution cycles between these two problems until the pole movement does not change the support locations for the cable problem. Then the entire structure is put back together and a standard finite element solution is run in order to recover the hanger forces.

The gravity solution is accomplished first. For this solution, the dead weights of the signals and signs are used as loads. Then the cable tensions are adjusted so that the specified clearance is achieved. This is done in a single cycle. Next, the wind plus gravity loads are applied and the cycling process repeated. In the wind case, the first cycle takes the longest because it finds the approximate position of the light. Subsequent cycles are much faster because they begin from the previous cycle position.

The latest version of ATLAS includes the ability for slack cables. The wind loading changes with the angle of the signal heads. As a result, the solution scheme tries to find a signal head position that satisfies equilibrium. In doing so, because of the C_D , drag coefficient, and C_L , lift coefficient, there is a solution between 0 and 90 degrees for a straight-on wind. Uplift is taken as zero at 90 degrees.

When the wind is other than perpendicular to the cable, shown in Figure 4, the solution becomes less stable. In fact, if the wind is applied in the plane of the cables, there is a wind magnitude at which the system becomes unstable and the light moves vertically. Due to this instability, for whatever angle the wind is specified, the program currently reduces the in-plane component to maintain stability. This will produce the largest cable and pole forces for the specified wind. The portion of wind removed would just cause instability in the system at which point the cable forces reduce to zero. The variation of the lift coefficient, C_L , with the angle may be a reason the program solution is unstable. It would be worthwhile to determine a bound on

C_D and C_L – or perhaps a combined force coefficient that would simplify the solution and result in a more stable one.

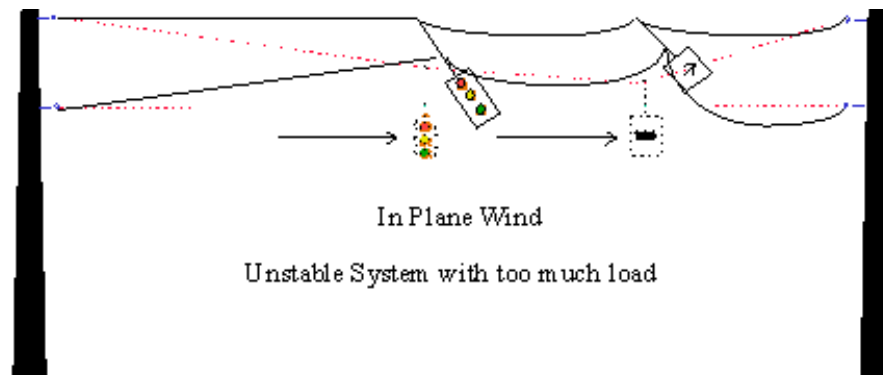

Figure 4 Unstable System (Source: ATLAS Manual)

In a current layout of ATLAS GUI, the user defines a box configuration in the grids and wind speeds and angles as they are applied to the box.

The following approximations and simplified analysis method are being considered.

1. Use of a single force coefficient

The value of the coefficient would be calibrated by performing multiple runs of rigorous analysis for different spans, wind speeds, and number of signal heads. A program user input box would be required for implementation of this coefficient in ATLAS. A beta version 6.05 allows for manual input of C_D and C_L .

2. In a box configuration, use a single-span analysis to design the pole, using a 90 degree angle of wind.

In order to evaluate the approximation, we would perform a parametric study using GTSTRUDL models of several typical box configurations. From the parametric study we would derive a series of empirical relations that would bracket the magnitudes of the wind loads for subsequent use in the single-span system. We would construct models with various internal angles in a trapezoidal shape corresponding to skewed intersections, and apply the three wind speeds of 110, 130, and 150 mph at angles of 15, 45, 60, and 90 degrees. These equivalent wind loads (or corresponding ATLAS input speeds) are then tabularized or graphed such that the designer would choose one out of a table per design wind speed. Each table would have a combination of geometry angles and wind-load angles. The magnitude of this equivalent wind load would vary per span depending on the box configuration and original wind-load angle applied to the box. If such wind speeds are applied to the box system at oblique angles, then resultant wind loads (speeds) that would be applied to the “replacement” of the box model, i.e. the replacement single-span model, will not necessarily be a prescribed design wind speed (i.e. 110, 130, or 150 mph).

This approach makes it necessary to develop GTSTRUDL models that represent several typical box configurations and subsequently use them to (1) validate the ATLAS replacement single-span model, including a sensitivity analysis and (2) derive a relationship between the wind load at oblique angle applied in the box and an equivalent wind load at 90 degrees applied in the replacement single-span model. However, it is evident that for a box system, wind at an oblique angle may produce higher moment in the supporting pole than for a single-span system. It is quite possible that wind applied at 45 degrees in the box would produce greater pole base moments than wind applied perpendicular to a single-span system.

3. For a hanging box configuration, and using the parametric study, develop the relationship between messenger tension on a single-span system and catenary tension on a hanging box. Note that for a single-span in a dual cable system, as wind velocity increases messenger cable tension also increases while catenary cable tension decreases (although to a lesser degree), as demonstrated in Ron Cook's research on the "Development of Hurricane Resistant Traffic Support System" at the University of Florida (Figure 5).

For hanging box configurations, it may be necessary to limit the design options for the simplified method being developed, for example, to rectangular boxes. However, this will only be determined once the parametric study is carried out. Task 3 will develop the steps for systematically carrying out this parametric study.

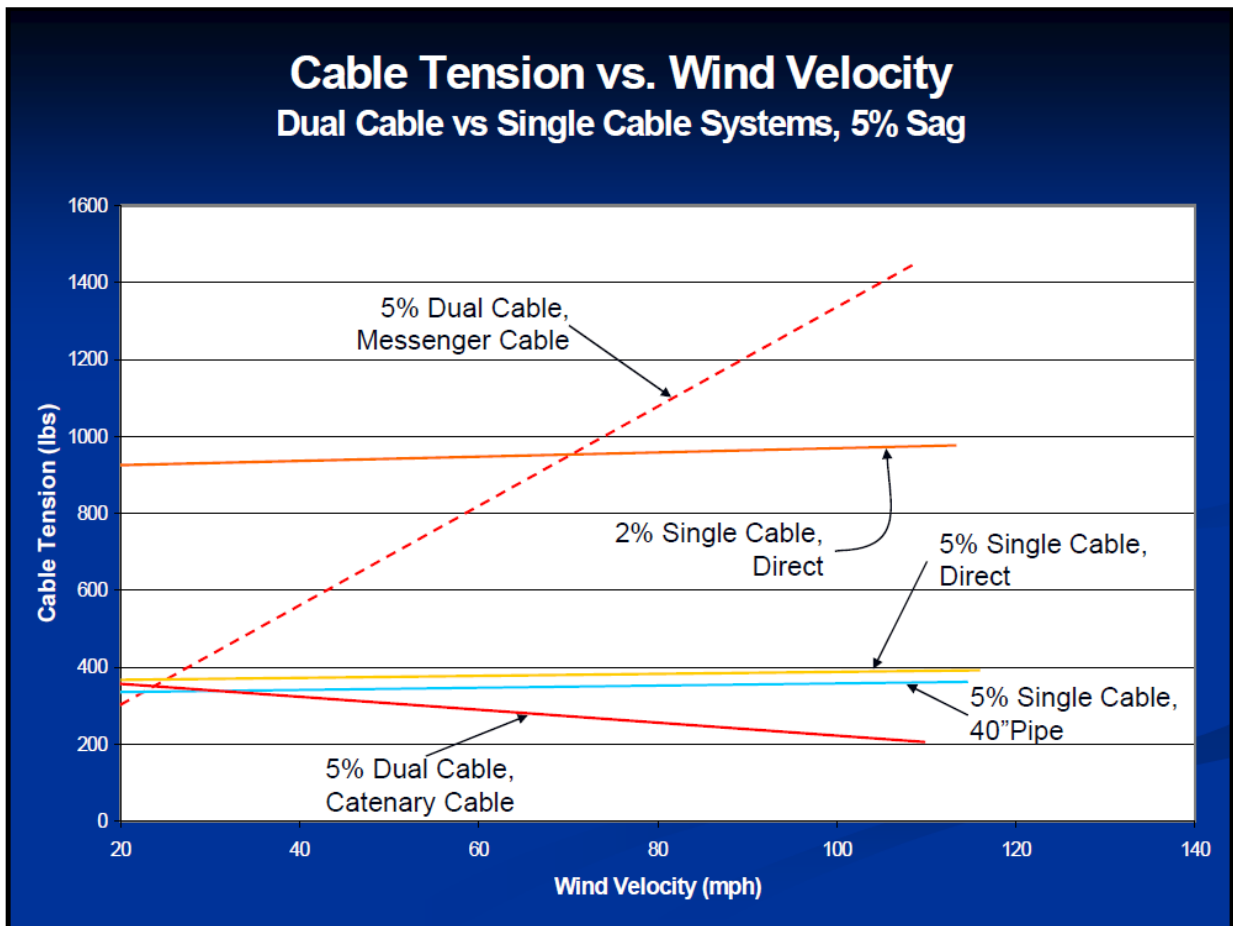

Figure 5 Cable Tension vs. Wind Velocity – FDOT/UF Study

IMPLEMENTATION TECHNICAL ISSUES

Following are some issues that would need to be considered in implementing the simplifications/approximate analysis method described above.

- If the ATLAS GUI is to be maintained while replacing the box span analysis with single-span analysis, two options were suggested in discussions between FDOT and the Bridge Software Institute that maintains ATLAS:

Option 1: The user could input only one span for analysis and wind load is applied at only 90 degrees; the user should know an equivalent wind speed (using an empirical equation or a table that approximate an equivalent wind load at 90 degrees, which would result in maximum resultant forces at the pole base of the box configuration). Basically, four separate single-span analyses should be performed consecutively per a box system. This equivalent wind load would depend on the geometry, i.e., angles between the two adjacent spans, and applied wind load/angle. The user would assemble the solutions and summarize the analysis and forces to be used in the design. It is also possible, with the cooperation of the Bridge Software Institute, to restructure the ATLAS output for this analysis to match the intent and enable an automated summary of the results.

Option 2: The user can still define a box in GUI and apply the wind load at an oblique angle only for the box model (For single-span model, wind is applied only at 90 degrees). Then ATLAS performs four consecutive single-span analyses using an equivalent wind load per span (which is calculated internally based on the recommendations of the parametric study being performed in this report) applied at 90 degrees. The results of the four single-span analyses are internally compared, and design forces are automatically selected for the worst case. This would require more programming by BSI. Note that for both options it would be sensible to turn off the design mode in ATLAS.

- For poles with different heights due to terrain it may be necessary to conservatively use the tallest pole in the analysis and design. This would be realistic as typically in an intersection the same type strain pole is selected for all corners.
- For counties with the lowest prescribed wind speeds it may be desirable to limit the number of signal heads, possibly using an artificially higher drag or force coefficient. Also it may be found reasonable to limit design to aluminum heads (no polycarbonate option).
- In addition to construction plans, what guides the design and construction currently are Design Standard 17727, Signal Cable and Span Wire Installation Details – which includes the proprietary pivotal hanger – and Standard Specifications Section 634. The latter identifies perpendicular span, diagonal span, box span, and special design span as possible configurations. The messenger wire tension per 100 feet of length is prescribed for standard cable sizes of 3/8, 7/16, and 1/2-inch wire. The contractor is to submit the method of providing the required tension in the messenger wire to the engineer for approval. The catenary wire is to be tensioned to provide a 5%, plus or minus 0.5% sag. For a suspended box, there is an additional offset cable between pole and corner that is not addressed in the Specifications, and is not necessarily the same size as the catenary or messenger wires.

The parametric study to be carried out in Task 4 should clue us on whether it can be dealt with as a continuation of the catenary wire for analysis purposes, allowing a similar treatment to the box span using a single-span model, and whether separate designs are needed for the hanging box catenary and messenger cables.

- Note that a hanging box span wire assembly analysis is a nonlinear problem; sequence of construction affects dead load forces and geometry. Sag and cable tension are related to each other and also relate to cable lengths. Unstressed cable lengths may be helpful to the contractor to obtain required sag and adjusted coordinates before mounting signal heads and hardware. Equilibrium and intended geometry have to agree. Using the equivalent single-span model does not explicitly solve the suspended box geometry and therefore this information would not be available in the simplified/approximate method. However, there should be sufficient conservatism in the analysis that will allow for somewhat higher tension in the cables due to contractor manipulation in the field without resulting in failure.
- Design should use standard hardware and fittings as much as possible. Fabricators should be consulted for availability of extra-high-strength (EHS) wires. As a comparison, a 3/8-inch utility grade wire delivers 11,500 pounds minimum breaking strength, whereas EHS wire of the same size delivers 15,400 pounds.

Task 3 – Technical Plan for Developing Approximate/Simplified Analysis Method

To develop a simplified design approach validated by a rigorous method, will require a complete understanding of the variable interrelationships given realistic geometric constraints. These relationships will be interpreted through a series of parametric studies for typical two pole, box, and hanging box span wire configurations. See Appendix B for example sketches. To aid in the validation of the simplified analysis method, the rigorous / complex analysis results will be compared to existing software (ATLAS) and known solutions. While a simplified design approach for typical two pole and box span wire configurations can potentially be achieved through basic methods such as neglecting pole deflection, a hanging box configuration is not as straight forward given its non-linear nature. Through the use of the parametric studies' data, empirical relationships will possibly be found which will conservatively achieve a simplified design approach for all geometric cases.

GTStrudl vs. ATLAS Modeling

To fully understand the comparison between the results from the finite element software program GTStrudl and ATLAS, a discussion of the differences of the programs will be necessary. Some differences were deliberately chosen for analysis accuracy while other differences are inherent between the two programs. Although a more analogous comparison could be achieved, the ultimate goal of the GTStrudl analysis is to create a baseline for the most accurate design results. While the major differences are discussed here, it should be noted that there are likely many fundamental differences in the internal analysis process between the two programs, however with ATLAS being a “black box” program, these details cannot adequately be discussed here.

- Pole Section Properties – The assumption chosen for GTStrudl modeling is to use a stepped pole with constant cross-section properties every foot. This assumption will

produce similar results to a tapered pole. ATLAS simplifies this procedure by using equivalent, constant cross-section properties from the pole base to the messenger cable height and from the messenger cable height to the top of the pole. The equivalent section from ATLAS produces a higher deflection than the actual pole which yields conservative results for the pole design but un-conservative results for the cable design.

- Initial Messenger Sag – An initial 1% sag will be used for the messenger cable for GTStrudl modeling. ATLAS does not include any initial sag in the messenger cable.
- Minimum Vertical Clearance – A point of interest related to ATLAS is how the program calculates the pole height. The minimum vertical clear distance is measured from the ground to the center of gravity of the controlling traffic signal. The design measurement is taken from the ground to the bottom of the controlling traffic signal. This difference if not aware to the designer would cause ATLAS to compute a shorter pole height in addition to lower connection points for both cables to the pole. This leads to lower design forces calculated for the strain poles and smaller deflections which will in turn affect the design tension in the cables. Therefore, the minimum vertical clearance input within ATLAS will be increased by a value of half the height of the controlling traffic signal.
- Drag and Uplift Coefficients – ATLAS is able to iteratively calculate the angle of the pivotal traffic signals and use this angle to compute the drag and uplift coefficients. GTStrudl does not have the capability to compute the rotation angle and determine the drag and uplift coefficients, therefore constant drag and uplift coefficients will be necessary to complete the complex analysis.
- Limit for Applied Wind Load – Directly related to the traffic signal angle computation capabilities of ATLAS, the program will gradually increase the wind speed until the wind speed input value is achieved or an instability occurs. If an instability is reached, a design is given in the output for the highest wind speed possible. A true comparison with the complex analysis results will not be possible if an instability occurs because GTStrudl will not experience the same type of instability. Therefore, the inputted design wind speed will be reached for the complex analysis and not ATLAS which will in turn change the design element forces.

Simplifying Assumptions

The following assumptions were made to simplify the parametric analysis and reduce the number of variables in the analysis:

- Neglect wind on poles – The moment at the pole base is at most ~ 3% of the controlling moment caused by the catenary wire and messenger wire tension pull on the pole. Additionally, the moment due to the wind on pole will be about the other principal axis of the pole when compared to the moment from the wire tensions in the controlling load cases.
- Use Type P-VIII Concrete Strain Pole or Type PS-X Steel Strain Pole – Due to the emphasis of this project on wide intersections, the largest pole sections will be used for

analysis. Type P-VIII Concrete Pole will be the default strain pole chosen, and Type PS-X Steel Pole will be used where the Type P-VIII is inadequate for the design forces. ATLAS currently has limitations for Steel Strain Pole types. The only input option is to vary the concrete strength for a steel section. The default steel strain pole ($f'_c = 6,000$ psi) typically produces cable tension results similar to the Type VII Concrete Pole. Although oversizing the strain pole causes smaller deflections in the pole thereby increasing the cable tension, the longest spans will require use of these poles which will eliminate the conservatism of this assumption. It should also be noted that the smaller the span length, the bigger the percentage change in cable tension becomes.

- Use traffic signals only, no signs – Numerous standard traffic signals and signs exist, so only traffic signals will be analyzed to simplify the analysis process and facilitate the development of formulas or identifying patterns.
- Use 12" traffic light heads – The current standard signal design calls for 12" heads. 8" heads will still be required for analyzing existing strain poles, but for the purpose of this study we will only look at the current design standard. The results can still conservatively be used for the 8" heads. It should be noted that the projected area difference per head is 0.66 ft.² between the 8" and 12" head, and the weight difference between the 8" and 12" head is 3.5 lbs. for polycarbonate and 3.0 lbs. for aluminum.
- Use 2 Types of Light Signals – To limit the number of traffic signal types, the analysis will only consider a 3 light and 5 light, linear traffic signal.
- Use 5" backplate (when applicable) – Standard backplate sizes include 5" and 8". The 5" backplate size will be used to maintain a constant dead load and projected area for backplates throughout the analysis.
- Use Pivotal Hangers – The current signal design calls for pivotal hangers, therefore the analysis will focus on this type of hanger. The values of $C_D = 0.7$ and $C_L = 0.4$ will be used in the analyses since the FDOT Structures Manual, Volume 3, "FDOT Modifications to Standard Specifications for Structural Supports for Highway Signs, Luminaires, and Traffic Signals", Sixth Edition (LTS-6) recommends using these values for pivotal traffic signals in Sections 3.6.7 and 3.6.8. Additionally, a two-inch hanger will be used during all analyses.
- Use ½" Diameter Cable for Catenary and Messenger Cables – The largest standard diameter cable is ½". Utilizing a constant diameter cable throughout the analysis will simplify the process and will not change the overall design elements greatly considering the relatively low weight of the cables themselves compared to the dead load and wind loads for the traffic signals.

Parametric Study Variables

The parametric studies will focus on a multitude of variables and test their full practical range to determine the impact of each variable on the overall design element results and the variables interrelationships. Such information will be required to develop a simplified design procedure that is applicable for every span wire configuration. This study will be undertaken for a single span, box, and hanging box configurations. The results of the parametric studies will be

presented in tabular and graphical form to effectively show the impacts of each changing variable and interrelationships within the appropriate range of values. The following are the variables included in the parametric studies with their range of values. Additional values will be included if the study warrants additional investigation.

- Design Basic Wind Speeds – 110, 130, and 150 MPH in 20 MPH per Table 2.4.1-2 of the Structures Design Guidelines (SDG).
- Wind Angle - 0° to 90° in 30° increments plus 45° angle. A comparison will be made with the analysis of various wind angles and the AASHTO wind load combinations as stated below.
 - Load Case 1 = 0.2*Wind Parallel + 1.0*Wind Perpendicular
 - Load Case 2 = 0.3*Wind Parallel + 0.6*Wind Perpendicular
- Wire to Wire Angle at Pole Connection – 60° to 120° in 15° increments (Box and Hanging Box Configuration). See Appendix B for examples.
- Cable Angle at Eyebolt – 70° to 110° in 20° increments (Box Configuration).
- Span Lengths – 100 to 240 ft. in 20 ft. increments.
- Number of Signals – 5 to 23 in increments of 2. Signals will be spaced every 10 ft. apart starting at the centerline of the span. The maximum number of signals possible will also be analyzed for longer spans.
- Single Force Coefficient – The drag coefficient (C_D) will vary from 0.5 to 0.9 in increments of 0.1 while the uplift coefficient (C_L) will be kept at 0. The original ATLAS C_D and C_L values will also be used in ATLAS.
- Backplates – With or Without. The backplate will change the dead load and projected area for wind of the traffic signal.
- Signal Head Material – Aluminum or Polycarbonate. The weight of an aluminum signal head is 11 lbs. while the weight of a polycarbonate signal head is only 7.5 lbs. Therefore, the weight of a 3 light traffic signal can differ by 10.5 lbs. and the weight of a 5 light traffic signal can differ by 17.5 lbs. based solely on the material of the signal head's material.
- Initial Cable Tension – 1.0 to 1.4 kips in 0.1 kip increments.
- The rotation angle of signals for the pivotal hangers in the rigorous solution will be assumed to be 45 degrees for the 110 mph wind speed, 55 degrees for the 130 mph wind speed, and 60 degrees for the 150 mph wind speed. A rotation angle is required for the rigorous analysis since loads are being directly inputted as concentrated loads. ATLAS automatically iterates to find the rotation angles for each signal.

Interpretation of the Results

Given the parametric studies data, a series of simplifications will be explored to eliminate the need for a complex analysis. A list of simplifying analysis methods that will be explored follows. More methods will be investigated if the parametric studies data warrants it.

1. Use of a Single Force Coefficient –

The single force coefficient or the effective drag coefficient with the uplift coefficient set to zero, will be determined through running the aforementioned studies for the single span, box, and hanging box configurations. To develop baseline values, ATLAS can be used with the original drag and uplift coefficients the program internally calculates to determine the appropriate applied loads to use for the GTStrudl analysis. The single force coefficient will vary from 0.6 to 0.9 and be compared to the forces taken from the ATLAS output using the original C_D and C_L values. ATLAS will also be run with the varying single force coefficient since a new beta version (6.05) allows for manual input of C_D and C_L .

2. In a box configuration, use a single span analysis to design the pole using a 90 degree angle of wind –

To fully evaluate the simplification of using a single-span analysis to design the pole for a box configuration, multiple models with varying geometry will be required in conjunction with the variables discussed in the parametric studies. From the parametric studies, a series of empirical relations would then be used to set a bracket on equivalent wind load magnitudes for subsequent use in a single span system. The magnitude of this equivalent design wind speed would vary per span depending on the box configuration and original wind-load angle applied to the box. If such wind speeds are applied to the box system at oblique angles, then resultant wind loads (speeds) that would be applied to the “replacement” of the box model, i.e. the replacement single-span model, will not necessarily be a prescribed design wind speed (i.e. 110, 130, or 150 mph).

3. For a hanging box configuration, develop a relationship between messenger tension on a single span system and catenary tension on a hanging box.

For a single span, dual cable system, as wind velocity increases messenger cable tension also increases while catenary cable tension decreases (although to a lesser degree), as demonstrated in Ron Cook’s research on the “Development of Hurricane Resistant Traffic Support System” at the University of Florida (Figure 5). If a relationship can be proven through the parametric studies, an empirical formula will be developed to determine the cable tension in a hanging box through analysis of a single span system. For hanging box configurations, it may be necessary to limit the design options for the simplified method being developed, for example, to rectangular boxes.

4. Neglect Pole Deflection by determining an empirical relationship for cable tension given a set of geometric constraints for the span wire configuration.

Various models of single span, box, and hanging box configurations will be analyzed with and without pole deflection to determine if pole deflection can be neglected by using an equivalent wind speed or altering another variable. Neglecting the pole deflection would reduce the analysis to the cables only problem and create a simplified analysis.

Task 4 – Parametric Study and Recommendations for Simplified Analysis Method

A series of parametric studies was completed, through use of Finite Element Analysis (FEA) Program GTStrudl, in order to isolate key variables and to determine their relative importance to the complex, dual cable span wire system with flexible strain poles. The studies included three separate dual cable systems: single span, box, and hanging box configurations. The results of this multi-pronged parametric study were then interpreted to develop an approximate / simplified analysis method that would not require numerous iterations and/or FEA methods. Furthermore, the existing FDOT program ATLAS was directly compared to the GTStrudl results to determine the accuracy and viability of the program for analysis and design.

The rigorous analysis method via GTStrudl uses an iterative approach to solve the dual cable system. The model involves cable networks consisting of IPCABLE elements that allow the user to define the member properties of the cable. These cable networks are attached to joints on the pole's frame elements using pin supports.

Loads were applied as concentrated loads at each signal location and cable to pole connection point (except cable self-weight which is directly connected to the IPCABLE element and is automatically applied as a uniform load). The surface areas for the wind load calculations for traffic signals were taken from the ATLAS manual to eliminate any additional differences between programs. One difference between ATLAS and the rigorous method's wind load calculations is how each calculates the surface area for signals located on spans parallel to the wind direction. For the rigorous method, the surface area for the signals on the span parallel to the wind load is taken as the surface area of the signal minus the backplate. ATLAS uses the same surface area for wind load calculations in both directions regardless of backplate. Direct wind loading to the poles was ignored because the resulting increase in base moment for the poles was determined to be negligible for the purposes of this study. The tributary area method was used to convert distributed loads (such as wind loads on the cables) to adjacent nodes as concentrated loads.

The program requires an iterative solution due to the fact that cable tension, sag, and the supporting pole deflection are inter-related. As the cable tension increases, the pole's flexible frame elements deflect laterally, reducing the cable tension. The program iterates until it converges on a solution. The user is required to define an initial sag or an initial tension to the cable networks. To accurately model the dual cable system, the single span and box configurations used the FDOT specified 5% times the span length for the catenary cable sag during the full Dead Load only load case. Instead of a user defined initial sag, the messenger cable initial state was defined through use of an initial tension (as defined by FDOT Standard Specifications 634-3.3) for single span and box configurations.

The hanging box model required a different approach since no guidance is given to the allowable amount of initial sag or initial tension. The approach taken was to specify an initial tension that produced a maximum sag of 2.5% times the span length (pole to pole) for all cable networks. An initial cable sag for all cable networks was not possible due to the dependent

relationship of the cable networks. Simply stated, the program oftentimes will not be able to find a solution where all spans deflect exactly 2.5% times the span length at the same time, especially given more complex configurations. Since a user defined initial tension is used to determine if the vertical deflection of the Dead Load only case is less than the assumed allowable limit, the iterative process falls to the user. Therefore, the user is responsible to assign and balance initial cable tensions to not only limit vertical deflection of the cables, but also maintain reasonable lateral deflection in both directions. Due to high vertical deflections with the Dead Load Only Case, a “rise” or a positive vertical slope to the diagonal catenary cables connecting to the poles had to be included in the model. Analysis showed that a 3 foot rise for the catenary cable for all configurations provided an efficient design while producing slightly conservative results. A drop value of 3 feet for the messenger cable was used to limit vertical deflections for the Dead plus Wind Load Case. Once the user is satisfied with the vertical and lateral deflections of the hanging box system, the program finishes the analysis to produce final cable tensions and deflections for all load cases, similar to the single span and box configurations.

While performing the parametric study, changes had to be made to some of the study parameters and assumptions outlined in the Task 3 Report. These changes are described below.

- No initial messenger sag was specified during the Dead Load only case. FDOT specified initial cable tension formula was used instead.
- AASHTO wind load combination comparisons were not explored since the study did not lend itself well to employing these load combinations. A simplified analysis procedure was developed without the use of these load combinations.
- Wire to Wire Angle at Pole Connection and Cable Angle at Eyebolt were found to be dependent of each other to minimize lateral displacements for hanging boxes. Skews of 0 degrees, 15 degrees, and 30 degrees for the box and hanging box were investigated.
- Maximum number of signals was controlled by the span length (based on the signal spacing of 10 ft.) in addition to the allowable cable tension. Once the allowable cable tension was exceeded for all permutations given a set number of signals and span length, the configuration’s analysis was considered complete.
- Span lengths for hanging boxes were started at 180 feet since the majority of the hanging boxes are used for spans greater than 180 feet.
- Varying initial cable tensions for all configurations was determined to be unnecessary. Sag of the catenary cable and a constant messenger initial cable tension was used for single span and box configurations, while hanging box configurations used an assumed sag percentage of 2.5% and manual iteration to determine the initial cable tension for each cable network.
- A small study comparing messenger cable tensions with fixed and pivotal hangers for a single span was conducted. Given the present use of fixed hangers on signs and signals and the potential for a switch to fixed hangers for the design standard for signals, an understanding of the impact of the hanger type was deemed crucial.

Single Span Parametric Study Results

The results that were tracked for the single span parametric study were primarily the maximum cable tension, which always occurred at the ends of the messenger cables. Since the loading was always symmetric, both ends experienced the same tension for all analyses. Pole base moments were also tracked when necessary. Screenshots of a typical single span model in GTStrudl and its deflected shape can be seen in Figures 110 to 114.

The purpose of the first study was to determine the effect of pole deflections of a single span configuration using the rigorous analysis method. In addition to investigating neglecting pole deflection, using a simplified straight pole with the same member properties as the base of the tapered pole was examined. Concrete Pole Type P-VIII was the only pole type used for all single span and box configurations. It should be noted that steel strain poles deflect more than the concrete pole types which will decrease the cable tension when compared to concrete strain poles but increase the cable tension difference between “no pole deflection” and “flexible pole”. Therefore, the Concrete Pole Type P-VIII will produce conservative results if a different pole type is used. Span lengths of 100 feet and 200 feet were analyzed with varying wind speeds (110 mph, 130 mph, and 150 mph) along with 5 signals and 9 signals applied symmetrically to the span. The results of the study, illustrated in Figure 11 in Appendix C, show that neglecting pole deflection can increase the cable tension by a varying amount which depends primarily on the span length. The 100 foot span length produced an increases in cable tension from 16.6% to 21.3%, meanwhile the 200 foot span increased the cable tension from 8.0% to 11.4%. Increasing the number of signals and/or increasing the wind speed caused a greater change in maximum cable tension albeit the difference is a relatively small one. Given the large variance for the span length, smaller variances in numerous variables, and a multitude of other potential variables not considered in this mini-study, the option to neglect pole deflection to simplify design procedures will not produce a design to a sufficient level of accuracy.

Comparing the tapered pole results to the straight pole results, the change in cable tension is much smaller than neglecting the pole deflection all together. Figure 12 shows the 100 foot span length produced an increases in cable tension from 1.9% to 2.6%, meanwhile the 200 foot span increased the cable tension from 0.1% to 1.6%. Therefore, the overall results support a simplification of the tapered pole section to a straight section. The conservative assumption to use the base pole properties could be followed for design purposes, or member properties of a slightly narrower section could be used to produce similar results to the fully tapered beam as modeled in this study.

Next, the effect of fixed vs. pivotal hangers was explored. Single span with varying lengths (100' – 180'), number of signals (5 – 13), and wind speed (110 mph, 130 mph, 150 mph) were analyzed with the two types of hangers. By only changing the modeled behavior of the hanger (i.e. using the same projected area and drag and uplift coefficients) a maximum change in messenger cable tension was found to be 7%. When the coefficients are changed from 0.7 for drag and 0.4 for uplift to 1.2 for drag and 0 for uplift, in addition to increasing the projected area for drag, the effect on cable tension is very pronounced. The applied wind load on each signal increased by 2.4 (110 mph wind speed) to 3.4 (150 mph wind speed) times the wind load using a pivotal hanger for a 3 headed signal with 5” backplate. This increase in wind load per signal

and change in hanger behavior resulted in an increase in messenger cable tension by 1.5 (110 mph) to 1.8 (150 mph) times the cable tension for pivotal hangers. Therefore, pivotal hangers were found to result in a much lower cable tension overall.

The primary objectives of the larger single span study were to:

- 1) Build a database of values to use as a baseline to compare to the Box and Hanging Box Configurations.
- 2) Recognize trends in the results to assist in the development of a simplified analysis procedure.
- 3) Eliminate variables that produced negligible effects on the final cable tension values.
- 4) Compare GTStrudl results with ATLAS to determine if ATLAS is producing an accurate and consistent solution.

Due to the sheer amount of results, the numbers were plotted graphically in a couple of different ways to facilitate the identification of overall trends. GTStrudl results are shown in Figures 13-34 and Tables 1-3. ATLAS results are shown in Figures 35-52 and Tables 4-9. The first method the information was displayed is to plot number of signals versus maximum cable tension which can be seen in Figures 13-15. These plots show results for using the 3 headed aluminum traffic signal, however the same results and plots were created for all traffic signal types (3 headed, 5 headed, and aluminum or polycarbonate). Not all plots are included in Appendix C due to the similarity of results and necessity to limit the amount of results shown in Appendix C. There are a number of trends that can be seen graphically. First, as the span length increases, so does the cable tension. Furthermore, no curves intersect each other which is to be expected. Secondly, as the number of signals is increased given a certain span length, the cable tension increases but not a linear rate. The rate of increase in cable tension begins to decrease as the number of signals reach the upper limit, and the shape of the curves begin to look logarithmic instead of linear. Finally, as the wind speed increases, the cable tension increases and the gaps between individual span length curves increase. This can be seen by flipping back and forth between Figures 13-15. This gap widening between the curves can be explained by the relationship between wind speed and wind force which is to the second power. Therefore, as the wind speed increases, the wind force will increase at a higher rate. The second way the information was displayed was to plot span length versus maximum cable tension which can be seen in Figures 16-18. These curves look similar to the curves shown in Figures 13-15 with the exception that the logarithmic trends are muted and a predominant linear trend is revealed. Since a linear plot is more useful for a simplified analysis procedure, this type of plot will be used when comparing all signal types. These curves are plotted with linear trend lines in Figures 19-21. The coefficient of determination (R^2) trend line value shows a strong correlation with values between 0.96 and 1.00. Since the curves have a slight taper to them, the trend lines for the span lengths in the middle of the curve would produce a slightly unconservative cable tension value. However, using a small safety factor could easily absorb this discrepancy. Wind speed has a negligible effect on the trend line R^2 values.

The next step in the analysis is to compare the 3 headed aluminum traffic signal with the 3 headed polycarbonate traffic signal. The only aspect of the input that changes with the head material type is the dead load per signal. Results can be seen in Figures 22-33. The differences due to changing the signal head material is negligible for the curves and the trend lines correlation values. The percent change in cable tension was calculated in tabular form as well (See Table 1). The largest 10 values were highlighted in red to aid in the visualization of trends. The maximum percent increase in cable tension of 0.25 kips or 1.4% was seen in the

240 foot span with 150 mph winds and the maximum number of signals. The trends show that increasing the span length, number of signals, and wind speed increases the discrepancy between signal types. The cable tensions are higher with the polycarbonate head because at high wind speeds, the dead load helps to reduce the lateral deflection of the cables.

A similar comparison was conducted with traffic signals using 5 heads. Results for the 5 headed signals for aluminum can be seen in Figures 28-30 while the results for polycarbonate can be seen in Figures 31-33. Cable Tensions increase across all runs as expected, but the overall shape of the curves and the strong correlation to a linear trend line are nearly identical to the 3 headed signal type. The change in the material type between aluminum and polycarbonate, also produces little difference with the maximum value of 0.41 kips or 2.1% (See Table 2). Once again, this value occurs with the 240 foot span, 150 mph, and the maximum number of signals. Given the low change in cable tension between material types, an assumption to always use polycarbonate traffic heads for design purposes will yield an accurate and slightly conservative result.

The final comparison for the single span GTStrudl study is to look at the impact of backplates on the traffic signals. In Figure 34, the most apparent trends for the signals without backplates are the lower cable tensions throughout and the smaller gaps between each curve when compared to signals with backplates. Both of these trends are logical since the backplate consists of little dead load and a large surface area for wind loading. The wind force is the primary variable responsible for this difference in gaps between the curves, so the larger the surface area on each signal, the larger these gaps will become. The percent change in cable tension was calculated in tabular form as shown in Table 3. Increasing the span length decreases the difference in cable tension with and without backplates given for a given number of signals which shows the non-linear relationship between span length and cable tension. Increasing the number of signals and/or increasing the wind speed creates a larger difference between using signals with backplates and without backplates. The percent increase in cable tension ranges from 36.2% with a 240 foot span, 5 signals, 110 mph wind speed to the largest increase of 53.8% which occurs with a 140 foot span, maximum number of signals of 13, and 150 mph. This means that changing the total surface area of all signals has a greater impact on cable tension than does changing the span length initially, but at a certain point the span length begins to dominate the effect of the wind load. This behavior described can best be seen graphically. Values for percent change in cable tension for a span length of 200 feet was plotted to see the overall impact of backplates as the number of signals increases (See Figure 34). The slope of this curve shows that as the number of signals is increased, the rate of change reaches a maximum value at 7 signals and begins to decrease afterwards. Therefore, the cable tension will increase less and less as the number of signals increase above 7 signals.

ATLAS results for default drag and uplift coefficients can be seen in Figures 35-52 and Tables 4-10. The first signal type discussed in the GTStrudl study, 3 headed aluminum signals, is shown in Figures 35-40. Plotting number of signals versus the maximum cable tension shows much more inconsistency when compared to GTStrudl. This inconsistency gets worse with the increase of wind speed. By changing the plot to span length versus cable tension, some of these inconsistencies are removed, however the the severity and number of fluctuations increase substantially as the wind speed increases to 130 mph and worse yet at 150 mph. The reason for these inconsistencies is based on how ATLAS iterates during analysis. ATLAS steps up the wind speed until the inputted wind speed value is reached. If instability (where at least one signal reaches a 90 degree rotation angle) occurs, the program automatically finishes the run and provides the cable tensions at this wind speed instead of the inputted value. Combine this with the fact that the program will produce inconsistent final wind speeds with different

inputted wind speed values, and the accuracy of the final cable tension values given can be called into question.

As an example, a 240 foot span with 5 signals and 130 mph inputted design wind speed produces a maximum cable tension of 8.6 kips at a final wind speed of 117 mph. If the design wind speed for the same configuration is increased to 150 mph, the maximum cable tension increases to 10.8 kips and the final wind speed is now able to reach 142 mph. Sometimes increasing the wind speed can actually cause a solution to converge that did not at lower wind speeds. For example, a 240 foot span with 11 signals will produce a maximum cable tension of 10.3 kips for 110 mph design wind speed that converges and reaches 110 mph. If we change the design wind speed to 130 mph, the program only reaches a wind speed of 97 mph which produces a cable tension of 10.0 kips. Change the design wind speed again to 150 mph and now the program converges once more. The wind speed reaches the inputted value of 150 mph and the cable tension is 15.5 kips. Examples like these can be found throughout the study, regardless of signal head material type, number of heads per traffic signal, and with or without a backplate. The polycarbonate signal produces more inconsistencies than aluminum since there is less dead load to limit the deflection caused by the wind load (see Figures 41-43). Comparing the percent change in cable tension when changing material types yield wildly inconsistent results as well (See Table 4). Changing the signal type to 5 heads causes additional inconsistencies. Results for the 5 headed aluminum signals can be seen in Figures 47-49, while the results for the 5 headed polycarbonate can be seen in Figures 50-52. The percent change between the 5 headed signal runs based on material can be found in Table 5. The polycarbonate results with 13 signals actually only ran with a span length of 140 feet. The rest of the span lengths would not finish the analysis without crashing. Once again, comparing the percent change in cable tension between aluminum and polycarbonate produced different but equally poor results to that of the 3 headed signal analysis (See Table 4). Removing the backplate greatly improves the smoothness of the curves with overlapping of the curves only occurring at 150 mph (See Figures 44-46). The smoothness correlates with the vast majority of runs reaching their inputted design wind speeds. However as the total wind load increased (increased number of signals, increased wind speed, increased span length), the level of instability increased similar to the configurations with backplates. Comparing the percent change in cable tension with and without backplates produces slightly better results with more of the trends from the rigorous analysis emerging (Table 6).

Although results were not consistent using the default coefficients, the single force coefficient was analyzed using the Beta version of ATLAS (V 6.05). A range of values from 0.5 to 0.9 was analyzed in addition to using the combination of 0.7 coefficient for drag and 0.4 for uplift. One benefit of using a single force coefficient (specifically for drag) for analysis is that the possibility for instability is much lower since this method is effectively eliminating uplift on the traffic signals. However, it is still possible to achieve instability at high wind speeds since a few runs with a single force coefficient did not reach the inputted design wind speed of 150 mph. Interpolation and/or extrapolation was used to strengthen the trends seen between default coefficient results and the single force coefficient results. Table 7 and 8 show an excerpt from the 3 headed aluminum traffic signal analysis data. The single force value that best fits the interpolated or extrapolated is highlighted with a shade of blue. Dark blue was used for single force coefficient values that were conservative to the estimated default coefficient value, while light blue was unconservative. If the default coefficient run reached the inputted design wind speed, then this exact value was compared to the single force coefficient results and the closest match was highlighted in green (conservative best fit value) or yellow (unconservative best fit value). If an accurate interpolation or extrapolation could not be achieved with the given configuration of span length and number of signals, then a single force coefficient result was not

highlighted. A number of trends were found using this method. Although a single force coefficient did not provide the best fit across all signal types and configurations, the single force coefficient of 0.7 did provide the best fit over a majority of the cases with backplates. The best fit single force coefficient match with the lowest number of signals (across all signal types) was typically 0.6. As the number of signals increased, the best fit single force coefficient results was 0.7 and at times 0.8 and rarely 0.9. The single force coefficient of 0.8 provided the best fit over a majority of the cases without backplates.

To compare ATLAS and GTStrudl, only the runs that reached the final design wind speed for ATLAS were used. Although this drastically decreased the sample size for the default coefficient results, all the comparisons could be considered equal based on wind speed. The number of runs that reached the inputted design speed are shown in Table 9. Given the fact that the 0.7/0.4 coefficient combination was a conservative upper bound for the default coefficient results, the accuracy of both the default coefficients and the 0.7/0.4 coefficients was compared to the GTStrudl results (See Table 10). To further elaborate on Table 10 in Appendix C, a minimum and maximum percent change in cable tension were shown to illustrate the range of differences for each signal type. A negative value means the ATLAS result was greater than the GTStrudl result and thus conservative. A positive value means the ATLAS result was less than the GTStrudl result and unconservative. Therefore, the optimum values in Table 10 would be a small range between the minimum and maximum columns, and all percent changes would be negative and as close to 0 as possible. As shown in the table, the default coefficient results can be both unconservative and conservative with a minimum range of 21% for the 3 headed, aluminum signal with backplate, and a maximum range of 34% for the 3 headed, aluminum signal without backplate. The 0.7/0.4 coefficients results have a minimum range for the 5 headed, aluminum signal with backplate of 43%, and a maximum range of 57% for the 3 headed, aluminum signal with backplate. All values are conservative as indicated by the maximum percent change values being negative. The minimum percent change values below -30 indicates highly conservative values. Additionally, the following overlying trends were found when comparing ATLAS with default coefficient values and GTStrudl results:

- Trends for 3 Headed, Aluminum or Polycarbonate Signals with Backplate
 - Default Coefficients Comparison to GTStrudl
 - As span length and wind speed increases, discrepancy between ATLAS and GTStrudl increases.
 - As the number of signals increases discrepancy between ATLAS and GTStrudl decreases.
 - ATLAS' accuracy improves with lower span lengths, lower wind speeds, and higher number of signals.
 - 0.7/0.4 Coefficients Comparison to GTStrudl
 - As the number of signals and wind speed increases, discrepancy between ATLAS and GTStrudl increases.
 - As the hspan length increases, discrepancy between ATLAS and GTStrudl decreases.
 - ATLAS' accuracy improves with higher span lengths, lower wind speeds, and lower number of signals.
- Trends for 3 Headed, Aluminum Signal without Backplate
 - Default Coefficients Comparison to GTStrudl
 - Cable tension increases quicker with ATLAS than GTStrudl as the number of signals increases and wind speed increases.

- Cable tension increases quicker with GTStrudl than ATLAS as span length increases.
- Trends for 5 Headed, Aluminum or Polycarbonate Signals with Backplate.
 - Default Coefficients Comparison to GTStrudl
 - Cable tension increases quicker with ATLAS than GTStrudl as wind speed increases.
 - Typically cable tension increases quicker with GTStrudl than ATLAS as span length increases.
 - 0.7/0.4 Coefficients Comparison to GTStrudl
 - Cable tension increases quicker with ATLAS than GTStrudl as wind speed increases.
 - Typically cable tension increases quicker with GTStrudl than ATLAS as span length increases.

Box Span Configuration Parametric Study Results

The results that were tracked for the box span configuration parametric study were: maximum cable tension which always occurred at the end of the messenger cables and maximum pole base moments. Pole base moments controlled in the majority of the cases. In addition to the analyses conducted with the single span configuration, additional wind angles and box skew angles were analyzed. Screenshots of typical box configuration models in GTStrudl and their deflected shapes can be seen in Figures 115-121 in Appendix F.

The primary objectives of the box span study were to:

- 1) Compare results to the single span study.
- 2) Recognize trends in the results to assist in the development of a simplified analysis procedure.
- 3) Eliminate variables that provided negligible effect on the final cable tension values.
- 4) Compare GTStrudl results with ATLAS to determine if ATLAS is producing an accurate and consistent solution.

Since all models were created symmetrically, the first step was to verify behavior in both x- and y-directions was identical. Wind angles of 0 degrees and 90 degrees were compared with a 3 headed, aluminum traffic signals with the entire range of span lengths (100 to 240 feet), wind speed (110 mph, 130 mph, 150 mph), and number of signals (5 to 15 signals). Aluminum traffic signals were selected prior to the development of the single span study results. An excerpt of the maximum cable tension results can be seen in Table 11. Comparing wind angles of 0 degrees and 90 degrees shows identical cable tension results which verifies the symmetrical behavior of the model. Comparing the 30 degree and 45 degree wind angles with the 90 degree wind angle shows that the 90 degree wind angle will always control the cable design. The pole base performance ratio or Combined Stress Ratio (CSR) can also be compared to determine the controlling wind angle. An excerpt of the pole base moments can be seen in Table 12. As expected, the 45 degree wind angle produces the highest CSR ratio for any wind angle. To better compare the pole base moment CSR ratio of the 90 degree wind angle (also

the single span results) and the CSR ratio of the 45 degree wind angle, a column labeled “Ratio” was created with the results highlighted in “red” in the table. This “Ratio” column was then plotted graphically (see Figures 53-58). Similarly to the maximum cable tension graphs, the pole moment CSR ratio was plotted versus number of signals and versus span length. Plotting linear trendlines to each curve on the CSR Ratio versus Span Length graphs produced R^2 values between 0.99 and 1.00. These high R^2 values show a very strong relationship which is favorable for use in the simplified analysis procedure method. The same graphs were produced for 3 headed, aluminum traffic signals with no backplate (see Figures 59-64) and 5 headed, aluminum signals with backplates (see Figures 65 – 70). In this portion of the study polycarbonate headed traffic signals were not included; the difference in cable tension between signal head material type is small and quantified in the single span results. The 3 headed signals with no backplates show a much different picture with 110 mph wind speed. All curves are practically flat. The 130 mph wind speed curves begin to look similar to the results seen with the backplate for 110 mph. The same can be said for the 150 mph wind speed curves without backplate and the 130 mph wind speed curves with backplate for the 3 headed traffic signals. Trend lines show a strong correlation with values between 0.99 and 1.00. The 5 headed, aluminum traffic signal with backplates closely resembled the 3 headed, aluminum traffic signal with backplates graphs. The largest differences appear in the 150 mph wind speed curves. The 13 signal and 15 signal curves actually increased slightly as the span length increased. Additionally, the trendline curves for the 9 signals, 11 signals, and 13 signals curves were low. However, these curves were fairly flat and the estimated trendline value would not be significantly different from the actual value.

Given the strong linear correlation between the box span base pole moments with a 90 degree wind angle and the controlling 45 degree wind angle, verifying a relationship between the box span cable tension results and the single span cable tension results would prove very useful. The comparison of the box span and single span cable tension results are shown in Tables 13 – 15. The maximum cable tensions were found to be identical between all configurations. This discovery comes as no surprise considering the cables are each connected to the pole separately, and the pole’s behavior in the x-direction and the y-direction is independent. This information allows for a designer to design the cables of a box span configuration as separate single span units. The poles would then be designed with the given design cable tensions in biaxial bending. Further discussion of this simplified analysis method will be discussed in the “Recommendations and Conclusions” section.

The box analysis also included skews of 15 degrees and 30 degrees. Maximum cable tensions were found to be identical for all skews for the same reasons as discussed in the previous paragraph. Pole base moment ratio curves showed a similar relationship to the pole base moment ratios for the runs with wind angles of 30 degrees and 45 degrees (see Table 16). Therefore, the 30 degree skew resulted in the largest base pole moments. A 45 degree box skew configuration was not analyzed based on the low likelihood of a such a design being required. If a 45 degree skew configuration were analyzed, there is a strong likelihood of these base pole moments controlling the design of the pole. On a related note, the ratio between the pole base moment’s ratio of the 30 degree skewed box and the square box with a 30 degree wind angle are shown in Figures 71-73. Ratios ranged from 0.89 to 0.95 for 110 mph wind speeds, 0.96 to 1.02 for 130 mph wind speeds, and 1.02 to 1.08 for 150 mph wind speeds. Linear trendlines also confirm a strong correlation with R^2 values of 0.99 to 1.00. To summarize these findings, as the wind speed increases and/or the span length decreases, the pole base moment ratio for the 30 degree wind angle case increases quicker than the pole base moment ratio for the 30 degree box skew case.

The ATLAS results were more inconsistent for the box span configuration than the single span configuration. The vast majority of runs crashed the program. A few more configurations finished the analysis and provided an output with the updated ATLAS V6.05, however very little changed overall. Since the 100 ft. long box span (for 90 degree wind angle and 45 degree wind angle) resulted in the greatest number of completed runs, an 80 ft. long box span was investigated to determine if a shorter span length produced a greater chance of convergence. Unfortunately, the number of completed runs for the 80 ft. long box span was more comparable to the longer spans than the 100 ft. long box span results. Using similar logic, 3 signals were analyzed to determine if the number of signals was causing the instability. While more runs with 3 signals proceeded to completion relative to higher number of signals (7 and 9 signals), a trend was not found for any configuration. Another surprising result was encountered in the differences seen between the 0 and 90 degree wind angle runs. There was very little overlap for configurations that proceeded to completion between the two wind angles. Part of this difference can be attributed to the constant orientation of the signals regardless of the design wind angle. The seemingly random pattern of configurations that completed runs for the single span analysis was also seen in the box span configurations. An excerpt from the ATLAS results for 3 wind angles (0 degree, 45 degree, 90 degree) can be viewed in Tables 17 - 19.

Very little information could be gleaned from comparing the GTStrudl and ATLAS results due to the lack of usable data from ATLAS. The few ATLAS runs that did finish with the inputted design wind speed, produced a larger percent difference than the single span. No trends could be interpolated or extrapolated from this comparison due to the small sample size. For all intents and purposes, the small sample size of ATLAS data was inconsistent, and largely different when compared to GTStrudl for all ATLAS versions (V6.04, V6.05, and revised V6.05) and uplift and drag coefficients tested.

Hanging Box Span Configuration Parametric Study Results

The results that were tracked for the hanging box span configuration parametric study were maximum cable tensions which always occurred at the end of the messenger cable(s) connecting to the pole(s). The cable tension controlled the design in all cases. Similar variables were focused on for both the hanging box and box configurations. Screenshots of typical hanging box configuration models in GTStrudl and its deflected shape can be seen in Figures 122-129.

The primary objectives of the hanging box span study were to:

- 1) Compare results to the single span study.
- 2) Recognize trends in the results to facilitate the development of a simplified analysis procedure.
- 3) Eliminate variables that provided negligible effect on the final cable tension results.
- 4) Compare GTStrudl results with ATLAS to determine if ATLAS is producing an accurate and consistent solution.

Some inherent differences between the hanging box models and the single span models or the box models are the pole height, interdependency of adjacent cables, initial cable sag, initial cable tension, and pole material type. The pole height for hanging box models will be greater than the single span models because of the requirement for a drop value for the messenger

cables and a rise value for the catenary cables. The fact that the cables are interdependent in the hanging box model creates a more difficult problem to solve. Geometry can no longer be determined without regard to the force combinations at joints where multiple cables meet (inner box corners). An inability to balance forces at these four corners causes large and unrealistic lateral deflections for the entire structure. Initial cable sag was limited to 2.5% times the span length for hanging box spans whereas the single span and box spans were set to 5% of the span length. Due to the inherent instability of the system, specifying initial cable tensions was required for the GTStrudl analysis. Manually specifying an initial cable tension that also maintained initial cable sag within the assumed limits produced higher initial cable tensions than seen for the single span and box span configurations. Finally, the pole material type for longer spans as seen on typical hanging box configurations generally require steel strain poles due to the larger flexural capacity and the increased deflections seen in the steel poles as compared to the concrete poles. The larger deflections reduce the cable tensions which improves efficiency of the cable design.

Considering that all single span and box span analyses to this point have been conducted with a concrete pole (Type P-VIII), a limited study of the hanging box configurations with concrete poles was conducted. The models consisted of wind applied perpendicular to the main cable span with varying span lengths (180 ft. to 240 ft.), varying wind speeds (110 mph, 130 mph, 150 mph), and varying number of 3 headed, aluminum traffic signals per span (5 to 13). These models were run with the concrete pole and subsequently compared to the steel poles (Type PS10) to determine the effect the pole material has on the maximum cable tension results. Controlling cable tension results for the concrete poles can be seen in Figures 74-76, and results for the steel poles can be seen in Figures 77-79. The results were compared by dividing the cable tension results for the concrete pole by the cable tension results for the steel pole (Table 20). The 10 highest ratios are highlighted in red and the 10 lowest ratios are highlighted in green to assist in identifying any trends. While the 220 foot span resulted in the majority of the highest ratios and the lowest ratios tended to be with the 110 mph wind speed, no strong correlations were found given this information. Ratios ranged from 1.00 to 1.25. Trend lines and corresponding R^2 values were added to the concrete pole results and the steel pole results. The concrete results and trend lines can be seen in Figures 80-82, and the steel results and trend lines can be seen in Figures 83-85. While results are fairly consistent, a couple of outliers result in R^2 values that are much lower than single span and box span configurations. These outliers are less pronounced in the concrete pole results and more pronounced in the steel pole results. The primary factor that can be attributed to the fluctuation in cable tension, besides the inherent instability of the structure, is from the initial cable tension. The manually inputted initial cable tensions were determined from a trial and error basis and best fit results. This presents a level of variability in the cable tension values not seen in the single span and box analysis. R^2 values for the concrete pole analyses range from 0.86 to 0.99 meanwhile the R^2 values for the steel pole analyses range from 0.01 to 0.93. The majority of the outliers had a span length of 220 ft., however not all permutations of 220 feet produced outlying data.

Similar to the box span models, the behavior in both x- and y-directions was identical when comparing wind angles of 0 degree and 90 degrees with a variety of span lengths, wind speeds, and number of signals using a 3 headed, aluminum traffic signals and steel strain poles. Therefore, only wind angles of 30 degrees, 45 degrees, and 90 degrees were analyzed. Results show the largest cable tensions always occur with the 45 degree wind angle followed closely by the 30 degree wind angle results. These controlling cable tensions always occurred in one of the diagonal, messenger cables. Both wind angle results follow similar curves to the 90 degree results albeit much closer together as can be seen in Figures 86-97. Fluctuations can be seen with 9 and 11 signals in the larger span lengths. The magnitude of these

fluctuations increases as the span length increases and the wind speed increases. Removing these few fluctuations would produce smooth curves while providing little cause for concern. A conservative approach would be to include a safety factor to these curves to account for the fluctuations seen.

The results for hanging box skews of 15 degrees and 30 degrees look very similar to the wind angle results. Plotting cable tension versus number of signals was chosen for the skew comparison to better compare to the wind angle results. Hanging box results with no skew can be seen in Figures 98-100, while hanging box results with skews can be seen in Figures 101-106. As seen with the wind angle results, the fluctuations increase as the span length and wind speed increases. Additionally, the highest skew produces the highest cable tensions and the highest number of fluctuations. Therefore, one can postulate that increasing the complexity of the hanging box geometry will produce an increasingly unstable structure. Smooth curves can once again be created by removing the outliers, and a safety factor can be included that accounts for the level of instability based on the skew angle or level of complexity. To directly compare the maximum cable tensions between the skewed hanging box configurations and the non-skewed hanging box configurations, ratios of the cable tension of the skewed configurations divided by the cable tension of the non-skewed configurations were created (See Tables 21 and 22). Ratios for the 15 degree skew hanging boxes vary from 0.90 to 1.25. Ratios below 1.00 are due to the fluctuations discussed previously. Ratios for the 30 degree skew hanging boxes vary from 1.15 to 1.36. A theory to entertain is the possibility that the cable tension ratios for varying wind angles and the skewed box configurations are related. To test this theory, ratios for the wind angles were created in tabular form (See Tables 23 and 24). The range of ratios for the 30 degree wind angle varies from 1.06 to 1.18. Comparing this range to the range of 1.15 to 1.36 for the 30 degree hanging box skew, shows very little correlation between the two. Moreover, comparing the 10 highest ratios and 10 lowest ratios also shows little common ground besides the fluctuations previously noted for 9 and 11 signals.

To compare the single span results with the hanging box results, only the concrete pole results for the hanging box were used. The difference in behavior of the steel pole, hanging box models compared with the concrete pole, hanging box models has already been isolated and discussed above. Hanging box results and single span results were plotted on the same chart in Figures 107-109. As expected, cable tensions for the hanging box models are always greater than the single span models. A direct comparison of the cable tensions in the form of a ratio can be seen in Table 25. The range of ratios is from 1.15 to 1.40. The following trends can be seen: the ratio slightly increases as the wind speed and span length increases, and the ratio increases as the number of signals increases. Considering the cable tensions are greater than the single span cable tensions and always control the design, using a higher strength cable for the messenger cable could have numerous beneficial results. The data shows that a simplified analysis procedure is possible for a hanging box with simplified geometry. The details of this simplified analysis procedure will be discussed later. The messenger cable for the hanging box models was the primary load carrying members as seen in the single span and box span models. Catenary cable tension remained relatively constant for all configurations. Therefore, no correlation was found between the catenary cable tension of the hanging box models and the messenger cable tension for the single span models.

An important discovery was that – given steel strain poles, 3 headed signals with 5 signals or less per span, a wind speed of 130 mph or less, and a skew of 15 degrees or less – all messenger cable tensions were less than the allowable 11.08 kips (for ½” diameter cable). This information was determined by comparing all results and the removal of outlying data.

ATLAS provided little results for the hanging box configurations using any program version or uplift and drag coefficients values. All runs for span lengths 180 ft. to 240 ft. crashed the program, therefore not enough data was able to be extracted from the program to adequately compare to the GTStrudl results.

Recommendations and Conclusion

Simplified Analysis Procedure

Single Span –

The simplified analysis procedure for single span, dual cable strain pole systems includes a design procedure for each structural element: messenger cable, catenary cable, and strain pole. The design of the messenger cable is based on a number of charts or trend line equations developed from the charts. If the trend line equations are to be used, a conservative safety factor of 1.1 shall be used with the final maximum cable tension value produced from the equations since the equations have been shown to produce an unconservative, maximum percent difference from the actual values of 7.4%. The specific chart / equation to be used will depend on the signal type and design wind speed. Examples of these charts and the basis for the trend line equations can be seen in Figures 19-33. The parametric study only provides data for single spans with the following type of signal: 3 headed signal with backplate, 3 headed signal without backplate, and 5 headed signal with backplate. The parametric study determined that using only polycarbonate traffic signal heads is rational for design purposes. Additional research is warranted if design charts and equations for other signal types and signs are desired. The catenary cable design is unnecessary as the largest cable force found for any load case was found to be less than the maximum allowable cable tension of the smallest cable in the standard specification of 3/8" diameter. The strain pole design will use the maximum messenger cable tension found in the messenger cable design procedure and a constant 1.8 kip force for the catenary cable. The largest catenary cable tension found for any configuration in the parametric study was 1.76 kips. While the catenary cable tensions were found to be as low as 0.85 kips in the study, this increase in cable tension will produce a relatively small increase in base pole moment. Given these cable tensions, the strain pole design and drilled shaft foundation can be completed by hand or with existing FDOT approved MathCAD design spreadsheets as done presently. Cable tensions may be conservatively applied horizontally to the vertical axis of the pole as the slight drape in cables produces an insignificant change in the horizontal force component.

The limitations to this simplified analysis method should be understood prior to application. The parametric study in which this method was developed only looked at the use of a Type P-VIII concrete strain pole. Using a smaller concrete strain pole or using a steel strain pole will produce greater lateral pole deflections which will decrease the maximum cable tensions. The exact amount the cable tension will decrease will be dependent on the specific variables for each single span configuration. The study only analyzed a limited number of traffic signal types and no signs. No combination of different signal types was explored. Fixed hangers may not be used with the simplified analysis primarily due to the increased projected area, higher drag coefficient, and lack of uplift when compared to the pivotal hangers. While signs were not analyzed, the primary data input is the dead load, surface area, and hanger type. Comparing, a three headed aluminum signal with backplate, which weighs approximately 57 lbs and has a surface area of 8.72 square feet, and a 2 foot by 3 foot sign which weighs approximately 50 lbs and has a surface area of 6 square feet, shows the possibility for substituting a sign for a signal

with a fixed hanger. It would take a sign with dimensions of 3' x 3' to approach a surface area greater than the 3 headed signal with backplate or a situation that would produce unconservative results when substituting a sign for a signal. Finally, single spans that span the intersection diagonally shall be carefully reviewed prior to use of this method. The orientation of the signal heads could potentially produce cable tensions greater than provided in this method.

ATLAS could still be used as another design option for the single span dual cable systems provided that the program undergoes a thorough investigation into the inconsistent behavior with various configurations. The user shall also understand the current version of the program can produce unconservative results using the built-in default coefficients. The largest unconservative difference between ATLAS and the FEA results was found to be 21%. The use of the constant force coefficients of 0.7 for drag and 0.4 for uplift will produce conservative results for all configurations. The maximum cable tensions found for the 0.7/0.4 constant force coefficients were found to be anywhere from 5% to 46% greater than the FEA solution. The added benefit of using the constant force coefficients is the increased likelihood of the final wind speed reaching the inputted design wind speed.

Box Span –

The simplified analysis procedure for the box span configuration is based on the single span analysis procedure. The messenger cable design is identical to that described for the single span. Similar to the single span procedure, the catenary cable does not require a specific design process. The maximum catenary cable force for any load case was still well below the maximum allowable cable tension for the 3/8" diameter cable. The catenary cable tension to use for the pole design shall be 1.9 kips since the largest catenary cable tension found for the dead plus wind load case was 1.83 kips. Although the catenary cable force was typically found to be approximately 1.0 kip, this additional force will not significantly increase the pole base moments for the strain pole design. The pole design will be similar to the single span analysis with a few notable differences. After solving for the pole base moment about the major axis, the minor axis' pole base moment needs to be determined. The minor axis' pole base moment can be considered a fraction of the major axis' pole base moment. Figures 130-138 were developed to determine the corresponding fraction to multiply by the major axis' base pole moment given the box span configuration details. The chart to use is based on the wind speed and the signal type. The user then selects the number of signals and span length to find the correct ratio to use. For example, boxes with 3 headed, aluminum traffic signals with backplates range from 0.31 to 0.59, boxes with 3 headed, aluminum traffic signals without backplates range from 0.36 to 0.65, and 5 headed, aluminum traffic signals with backplates range from 0.25 to 0.55. Next, a magnification factor needs to be applied to both moments to account for the controlling 45 degree wind angle for box span configurations (assuming no box skew). Similar to the process to lookup the ratio to use to calculate the minor axis' pole base moment, charts are provided to determine the magnification factor to be applied to both moments (See Figures 139-147). A modification factor will be required for skewed box configurations. The extent of the skew angle for box span configurations in this study was restricted to 3 headed, aluminum traffic signals with a 15 degree and 30 degree skew. Although limited research was conducted as a part of this study, trends were found that could lead to possible modification factors. For example, comparing the base pole moment ratio for a 30 degree wind angle with no box span skew and a 30 degree box span skew with a perpendicular wind angle, produced smooth and consistent curves. Figures 148-150 show a complicated relationship based on the wind angle between a typical box configuration with no skew and a skewed box. As the wind speed increases, the pole moment ratio increases quicker for the 30 degree wind angle when compared to the 30

degree skewed box. Although the relationship is complex, the range of values is small. The range of values for 110 mph wind speed is 0.89 to 0.95, the range of values for 130 mph wind speed is 0.96 to 1.03, and the range of values for 150 mph is 1.02 to 1.07. Although, neither of these scenarios are likely to produce the greatest base pole moment with the given wind angle, the consistent relationship found between the wind angle and skew angle justifies additional investigation. Currently, this simplified analysis method is limited to box configurations with no skew. Simplifying these modification factors further by using one average value or one conservative value may also be warranted.

The ATLAS program versions to date are not recommended for use on box span configurations. The combination of inconsistent behavior and the inability of the program to analyze the majority of the box span configurations conclusively showed that the program is not capable of reliable box span analysis given the variables analyzed in this parametric study. A combination of ATLAS for the single span analysis and the simplified analysis method detailed for the box span configuration could be used to analyze box span configurations. However, the issues discussed previously for the ATLAS analysis for a single span configuration should be understood prior to use of the program.

Hanging Box Span –

The simplified analysis procedure for the hanging box span configuration is based on the single span analysis procedure. This method should only be used for similar geometric configurations analyzed in the parametric study or in other words, symmetrical and semi-symmetrical configurations with little deviation between pole locations. Limited trends were identified relative to skewed hanging boxes within the study. Extrapolation of the data beyond what is presented here is not justified given the complex behavior of the hanging box and the large number of variables to be considered. Additional research is necessary if this method is desired to be further developed. All other geometric configurations not covered in the parametric study would require a rigorous analysis through use of a finite element analysis program such as GTStrudl. A MathCAD design spreadsheet and accompanying Excel macro were created to expedite the process of creating a GTStrudl input file for such a purpose.

The messenger cable design shall follow the single span procedure with the following additions. A magnification factor is required to account for the increase in cable tension for the diagonal cables connected to the poles. The magnification factor was found to be primarily based on the number of signals per span. Variation in magnification factor between various span lengths given a constant number of signals was small enough to ignore. Equation 1 in Appendix G, provides a conservative magnification factor based on the number of signals per span. The only instance that this equation provides a slightly conservative result is for 11 signals with a 240 foot span length, however this configuration produced outlying data and was therefore ignored. An additional magnification factor is required to account for the increase in cable tension for the controlling wind angle of 45 degrees. Values varied from 1.1 to 1.2 for a 45 degree wind angle. However, the higher values were taken from outlying data. Therefore, a constant magnification factor of 1.15 produces the most consistent and conservative messenger cable tensions. This method assumes all messenger cable tensions are equal for design purposes. Although conservative, the cost increase for a possibly thicker cable is relatively small in comparison to the total construction cost. If a more efficient design is desired, a reduction factor to the inner box messenger cables can be estimated by balancing the forces at all four corners of the box. A skew factor is required for configurations with a skew greater than 0 degrees. Similar to the box span simplified analysis method, limited data was created as part

of the parametric study for this purpose. Skews of 15 degrees and 30 degrees were analyzed with 3 headed aluminum traffic signals for various span lengths, wind speeds, and number of signals. The values for skew factor were plotted and a trend line was created to extrapolate out to a maximum skew angle of 45 degrees. The equation for this trend line can be found in Appendix G, Equation 2. This skew factor equation should provide an accurate estimate for skew angles less than 30 degrees and a conservative estimate for skew angles greater than 45 degrees. Similar equations could be developed for other signals types and combinations of signal types with additional research. A reduction factor for the use of the steel strain pole type PS10 instead of the concrete pole Type P-VIII was investigated. Messenger cable tension ratios for concrete poles divided by ratios for steel poles varied from 1.00 to 1.25. In general, longer span lengths produced greater differences between concrete poles and steel poles. Looking closer at the data revealed that the majority of values are close to 1.00 for every span length and every number of signals per span analyzed. Furthermore, the wind speed did not have a significant impact on the ratio. Therefore, no reduction factor was included and the results for a hanging box configuration with steel strain poles may produce a conservative result by as much as 25%.

The catenary cable design is not required if a 0.5" diameter cable is used. The largest cable tension for all load cases and configurations in the study was 7.13 kips. Controlling values found for all catenary cables for the dead plus wind load case varied from 1.8 kips to 4.92 kips. Although a smaller cable may be possible, the relatively small increase in cost relative to the total construction cost did not warrant any further investigation.

The pole design is straight forward with no additional factors to consider. The pole shall be designed as a typical cantilevered pole with a drilled shaft foundation using the maximum messenger cable tension and a 5 kip catenary cable tension. Some smaller values for the catenary cable tension were encountered however the larger cable tensions did not increase the pole base moments significantly. Biaxial bending analysis will be required depending on the geometry of the hanging box and the pole orientation relative to the diagonal cables.

Other Recommendations –

- Additional research is warranted to further develop the simplified analysis procedure for single span, box, and hanging box configurations to encompass various signal types, signs, combination of signals and signs, pole sizes, and skews.
- ASTM A475 extra high strength grade cables are recommended to be added to the design standards. Analysis for the single span and hanging box showed the messenger cable usually controlled the design of the structure versus the strain pole. The hanging box in particular required much higher initial cable tensions than the other configurations due to the smaller sag allowed and the interdependency of adjacent cables to one another. Additionally, extra high strength grade cables are being commercially produced and are readily available. The incremental cost increase of a higher strength cable would not significantly increase the total cost of construction, and in certain cases a smaller diameter strand could be used.

Conclusion –

The rigorous analysis from GTStrudl produced consistent and expected results for all configurations. These results were used to develop trends by isolating key variables. The trends were further refined to develop charts and equations that could be used for a simplified analysis procedure. The premise behind the simplified analysis procedure was to develop conservative and reliable results for analyzing single span configurations within the boundaries of the parametric study. An analysis for each structural element (messenger cable, catenary cable, and strain poles) was created. The box and hanging box simplified analysis procedures are unique but are both based on the simplified analysis for the single span. Modification factors are included for variables such as skew, wind angle, hanger tie, and pole type. Due to the sheer number of variables present in any span wire configuration, the information developed is still somewhat limited. If a span wire intersection is encountered that does not fall within the scope of this project (whether that be due to signal type, presence of signs, geometric data, etc.), a rigorous solution may be necessary. A MathCAD spreadsheet and Microsoft Excel Macro were created to expedite the process for developing GTStrudl input files for single span, box, and hanging box configurations. Furthermore, the spreadsheet and macro could be modified to create input files for finite element analysis software other than GTStrudl. A valuable piece of information extracted from the hanging box analyses was the fact that all messenger cable tensions were less than the allowable 11.08 kips (for 1/2" diameter cable) given steel strain poles, a maximum span length of 240 feet, 3 headed signals with 5 signals or less per span, pivotal hangers, a wind speed of 130 mph or less, and a skew of 15 degrees or less. Therefore, a rigorous analysis may not be required for a hanging box configuration that meets these requirements. In conclusion, the rigorous parametric study produced a plethora of valuable data that provides a foundation for the development of a simplified analysis procedure for each span wire configuration analyzed.

ATLAS produced unreliable results with the program's default drag and uplift coefficients. The single span results were inconsistent and unconservative at times when compared to the rigorous solutions. If ATLAS is used for single span configurations, a thorough understanding of the program's behavior is recommended. One option for single span analysis using ATLAS that greatly reduces the inherent instability within the system is to use a single force constant coefficient of 0.7 for signals with backplates and 0.8 for signals without backplates. The elimination of the uplift coefficient provides consistent and accurate results. The box and hanging box configurations produced very little data regardless of the value for the drag and uplift coefficients, and the program typically crashed. The few results that were produced were not reliable.

Traffic signals supported by span wires and strain poles are inherently unstable in certain wind conditions. This project found that using GTStrudl with constant rotation angles and constant drag and lift coefficients for the analysis of signals produced consistent, predictable results that may be used for design and/or analysis. On the other hand, the ATLAS program V6.04 did not always find reasonable solutions that could be used for design/analysis. While this is a concern for designers, it is also a reminder that traffic signals on span wires swing and rotate at large angles when exposed to high wind speeds which can cause instability. In fact, the Atlas

program may be a fair predictor of system instability. With this knowledge, span wires should be designed in accordance with AASHTO using a sufficient safety factor to account for instability. Even with the AASHTO design safety factors, certain wind conditions below the design wind speed may cause instability and loading conditions not accounted for in design.

Appendices

Appendix A – Sample GTStrudl Inputs for Cable Analysis

Single Span Configuration

STRUDL '1' '11'

\$\$

\$\$

\$\$

UNITS INCHES LBS DEG FAH
JOINT COORDINATES GLOBAL

1	0	0	0
2	0	12	0
3	0	24	0
4	0	36	0
5	0	48	0
6	0	60	0
7	0	72	0
8	0	84	0
9	0	96	0
10	0	108	0
11	0	120	0
12	0	132	0
13	0	144	0
14	0	156	0
15	0	168	0
16	0	180	0
17	0	192	0
18	0	204	0
19	0	216	0
20	0	228	0
21	0	240	0
22	0	252	0
23	0	264	0
24	0	276	0
25	0	288	0
26	0	300	0
27	0	312	0
28	0	324	0
29	0	336	0
30	0	348	0
31	0	360	0
32	0	372	0
33	0	384	0
34	0	396	0
35	0	408	0
36	0	420	0
37	2400	0	0
38	2400	12	0
39	2400	24	0
40	2400	36	0
41	2400	48	0

42	2400	60	0
43	2400	72	0
44	2400	84	0
45	2400	96	0
46	2400	108	0
47	2400	120	0
48	2400	132	0
49	2400	144	0
50	2400	156	0
51	2400	168	0
52	2400	180	0
53	2400	192	0
54	2400	204	0
55	2400	216	0
56	2400	228	0
57	2400	240	0
58	2400	252	0
59	2400	264	0
60	2400	276	0
61	2400	288	0
62	2400	300	0
63	2400	312	0
64	2400	324	0
65	2400	336	0
66	2400	348	0
67	2400	360	0
68	2400	372	0
69	2400	384	0
70	2400	396	0
71	2400	408	0
72	2400	420	0
200	720	408	0
201	840	408	0
202	960	408	0
203	1080	408	0
204	1200	408	0
205	1320	408	0
206	1440	408	0
207	1560	408	0
208	1680	408	0
209	720	276	0
210	840	276	0
211	960	276	0
212	1080	276	0
213	1200	276	0
214	1320	276	0
215	1440	276	0
216	1560	276	0
217	1680	276	0

TYPE SPACE FRAME
MEMBER INCIDENCES

1	1	2
2	2	3
3	3	4
4	4	5
5	5	6
6	6	7
7	7	8
8	8	9
9	9	10
10	10	11
11	11	12
12	12	13
13	13	14
14	14	15
15	15	16
16	16	17
17	17	18
18	18	19
19	19	20
20	20	21
21	21	22
22	22	23
23	23	24
24	24	25
25	25	26
26	26	27
27	27	28
28	28	29
29	29	30
30	30	31
31	31	32
32	32	33
33	33	34
34	34	35
35	35	36
36	37	38
37	38	39
38	39	40
39	40	41
40	41	42
41	42	43
42	43	44
43	44	45
44	45	46
45	46	47
46	47	48
47	48	49
48	49	50

49	50	51
50	51	52
51	52	53
52	53	54
53	54	55
54	55	56
55	56	57
56	57	58
57	58	59
58	59	60
59	60	61
60	61	62
61	62	63
62	63	64
63	64	65
64	65	66
65	66	67
66	67	68
67	68	69
68	69	70
69	70	71
70	71	72

TYPE SPACE TRUSS
MEMBER INCIDENCES

900	200	209
901	201	210
902	202	211
903	203	212
904	204	213
905	205	214
906	206	215
907	207	216
908	208	217

UNITS INCHES KIPS DEG FAH

MEMBER PROPERTIES PRISMATIC AX 365.9 AY 365.9 -
AZ 365.9 IX 17300 IY 17300 -
IZ 17300 SY 1603 SZ 1603 -
YD 21.59 ZD 21.59 YC 10.79 -
ZC 10.79
1 36

MEMBER PROPERTIES PRISMATIC AX 360.4 AY 360.4 -
AZ 360.4 IX 16790 IY 16790 -

IZ 16790 SY 1567 SZ 1567 -
YD 21.43 ZD 21.43 YC 10.71 -
ZC 10.71
2 37

MEMBER PROPERTIES PRISMATIC AX 354.9 AY 354.9 -
AZ 354.9 IX 16290 IY 16290 -
IZ 16290 SY 1532 SZ 1532 -
YD 21.27 ZD 21.27 YC 10.63 -
ZC 10.63
3 38

MEMBER PROPERTIES PRISMATIC AX 349.4 AY 349.4 -
AZ 349.4 IX 15790 IY 15790 -
IZ 15790 SY 1497 SZ 1497 -
YD 21.1 ZD 21.1 YC 10.55 -
ZC 10.55
4 39

MEMBER PROPERTIES PRISMATIC AX 344 AY 344 -
AZ 344 IX 15310 IY 15310 -
IZ 15310 SY 1463 SZ 1463 -
YD 20.94 ZD 20.94 YC 10.47 -
ZC 10.47
5 40

MEMBER PROPERTIES PRISMATIC AX 338.6 AY 338.6 -
AZ 338.6 IX 14840 IY 14840 -
IZ 14840 SY 1429 SZ 1429 -
YD 20.78 ZD 20.78 YC 10.39 -
ZC 10.39
6 41

MEMBER PROPERTIES PRISMATIC AX 333.3 AY 333.3 -
AZ 333.3 IX 14390 IY 14390 -
IZ 14390 SY 1396 SZ 1396 -
YD 20.62 ZD 20.62 YC 10.31 -
ZC 10.31
7 42

MEMBER PROPERTIES PRISMATIC AX 328 AY 328 -
AZ 328 IX 13940 IY 13940 -
IZ 13940 SY 1363 SZ 1363 -
YD 20.46 ZD 20.46 YC 10.23 -
ZC 10.23
8 43

MEMBER PROPERTIES PRISMATIC AX 322.8 AY 322.8 -
AZ 322.8 IX 13500 IY 13500 -
IZ 13500 SY 1331 SZ 1331 -
YD 20.29 ZD 20.29 YC 10.15 -
ZC 10.15

9 44

MEMBER PROPERTIES PRISMATIC AX 317.6 AY 317.6 -
AZ 317.6 IX 13070 IY 13070 -
IZ 13070 SY 1299 SZ 1299 -
YD 20.13 ZD 20.13 YC 10.07 -
ZC 10.07
10 45

MEMBER PROPERTIES PRISMATIC AX 312.4 AY 312.4 -
AZ 312.4 IX 12660 IY 12660 -
IZ 12660 SY 1268 SZ 1268 -
YD 19.97 ZD 19.97 YC 9.985 -
ZC 9.985
11 46

MEMBER PROPERTIES PRISMATIC AX 307.3 AY 307.3 -
AZ 307.3 IX 12250 IY 12250 -
IZ 12250 SY 1237 SZ 1237 -
YD 19.81 ZD 19.81 YC 9.904 -
ZC 9.904
12 47

MEMBER PROPERTIES PRISMATIC AX 302.2 AY 302.2 -
AZ 302.2 IX 11850 IY 11850 -
IZ 11850 SY 1207 SZ 1207 -
YD 19.65 ZD 19.65 YC 9.822 -
ZC 9.822
13 48

MEMBER PROPERTIES PRISMATIC AX 297.2 AY 297.2 -
AZ 297.2 IX 11470 IY 11470 -
IZ 11470 SY 1177 SZ 1177 -
YD 19.48 ZD 19.48 YC 9.742 -
ZC 9.742
14 49

MEMBER PROPERTIES PRISMATIC AX 292.2 AY 292.2 -
AZ 292.2 IX 11090 IY 11090 -
IZ 11090 SY 1148 SZ 1148 -
YD 19.32 ZD 19.32 YC 9.661 -
ZC 9.661
15 50

MEMBER PROPERTIES PRISMATIC AX 287.3 AY 287.3 -
AZ 287.3 IX 10720 IY 10720 -
IZ 10720 SY 1119 SZ 1119 -
YD 19.16 ZD 19.16 YC 9.579 -
ZC 9.579
16 51

MEMBER PROPERTIES PRISMATIC AX 282.4 AY 282.4 -
A-6

AZ 282.4 IX 10360 IY 10360 -
IZ 10360 SY 1091 SZ 1091 -
YD 19 ZD 19 YC 9.498 -
ZC 9.498
17 52

MEMBER PROPERTIES PRISMATIC AX 277.5 AY 277.5 -
AZ 277.5 IX 10010 IY 10010 -
IZ 10010 SY 1063 SZ 1063 -
YD 18.84 ZD 18.84 YC 9.418 -
ZC 9.418
18 53

MEMBER PROPERTIES PRISMATIC AX 272.7 AY 272.7 -
AZ 272.7 IX 9672 IY 9672 -
IZ 9672 SY 1036 SZ 1036 -
YD 18.67 ZD 18.67 YC 9.337 -
ZC 9.337
19 54

MEMBER PROPERTIES PRISMATIC AX 267.9 AY 267.9 -
AZ 267.9 IX 9340 IY 9340 -
IZ 9340 SY 1009 SZ 1009 -
YD 18.51 ZD 18.51 YC 9.256 -
ZC 9.256
20 55

MEMBER PROPERTIES PRISMATIC AX 263.2 AY 263.2 -
AZ 263.2 IX 9016 IY 9016 -
IZ 9016 SY 982.8 SZ 982.8 -
YD 18.35 ZD 18.35 YC 9.175 -
ZC 9.175
21 56

MEMBER PROPERTIES PRISMATIC AX 258.5 AY 258.5 -
AZ 258.5 IX 8701 IY 8701 -
IZ 8701 SY 956.9 SZ 956.9 -
YD 18.19 ZD 18.19 YC 9.094 -
ZC 9.094
22 57

MEMBER PROPERTIES PRISMATIC AX 253.8 AY 253.8 -
AZ 253.8 IX 8395 IY 8395 -
IZ 8395 SY 931.5 SZ 931.5 -
YD 18.03 ZD 18.03 YC 9.013 -
ZC 9.013
23 58

MEMBER PROPERTIES PRISMATIC AX 249.2 AY 249.2 -
AZ 249.2 IX 8096 IY 8096 -
IZ 8096 SY 906.5 SZ 906.5 -
YD 17.86 ZD 17.86 YC 8.932 -

ZC 8.932

24 59

MEMBER PROPERTIES PRISMATIC AX 244.7 AY 244.7 -

AZ 244.7 IX 7806 IY 7806 -

IZ 7806 SY 882 SZ 882 -

YD 17.7 ZD 17.7 YC 8.851 -

ZC 8.851

25 60

MEMBER PROPERTIES PRISMATIC AX 240.1 AY 240.1 -

AZ 240.1 IX 7523 IY 7523 -

IZ 7523 SY 857.9 SZ 857.9 -

YD 17.54 ZD 17.54 YC 8.77 -

ZC 8.77

26 61

MEMBER PROPERTIES PRISMATIC AX 235.7 AY 235.7 -

AZ 235.7 IX 7248 IY 7248 -

IZ 7248 SY 834.3 SZ 834.3 -

YD 17.38 ZD 17.38 YC 8.688 -

ZC 8.688

27 62

MEMBER PROPERTIES PRISMATIC AX 231.2 AY 231.2 -

AZ 231.2 IX 6981 IY 6981 -

IZ 6981 SY 811.1 SZ 811.1 -

YD 17.22 ZD 17.22 YC 8.607 -

ZC 8.607

28 63

MEMBER PROPERTIES PRISMATIC AX 226.8 AY 226.8 -

AZ 226.8 IX 6721 IY 6721 -

IZ 6721 SY 788.3 SZ 788.3 -

YD 17.05 ZD 17.05 YC 8.527 -

ZC 8.527

29 64

MEMBER PROPERTIES PRISMATIC AX 222.5 AY 222.5 -

AZ 222.5 IX 6469 IY 6469 -

IZ 6469 SY 766 SZ 766 -

YD 16.89 ZD 16.89 YC 8.446 -

ZC 8.446

30 65

MEMBER PROPERTIES PRISMATIC AX 218.1 AY 218.1 -

AZ 218.1 IX 6224 IY 6224 -

IZ 6224 SY 744.1 SZ 744.1 -

YD 16.73 ZD 16.73 YC 8.364 -

ZC 8.364

31 66

MEMBER PROPERTIES PRISMATIC AX 213.9 AY 213.9 -
AZ 213.9 IX 5985 IY 5985 -
IZ 5985 SY 722.6 SZ 722.6 -
YD 16.57 ZD 16.57 YC 8.284 -
ZC 8.284
32 67

MEMBER PROPERTIES PRISMATIC AX 209.6 AY 209.6 -
AZ 209.6 IX 5754 IY 5754 -
IZ 5754 SY 701.5 SZ 701.5 -
YD 16.41 ZD 16.41 YC 8.203 -
ZC 8.203
33 68

MEMBER PROPERTIES PRISMATIC AX 205.5 AY 205.5 -
AZ 205.5 IX 5530 IY 5530 -
IZ 5530 SY 680.9 SZ 680.9 -
YD 16.24 ZD 16.24 YC 8.122 -
ZC 8.122
34 69

MEMBER PROPERTIES PRISMATIC AX 201.3 AY 201.3 -
AZ 201.3 IX 5312 IY 5312 -
IZ 5312 SY 660.6 SZ 660.6 -
YD 16.08 ZD 16.08 YC 8.04 -
ZC 8.04
35 70

MEMBER PROPERTIES PIPE OD 7.5000000E-01 THI 2.5000000E-01
900 TO 908

STATUS SUPPORT -

1 37

TYPE SPACE TRUSS
ELEMENT INCIDENCES

100	35	200
101	200	201
102	201	202

103	202	203
104	203	204
105	204	205
106	205	206
107	206	207
108	207	208
109	208	71
110	24	209
111	209	210
112	210	211
113	211	212
114	212	213
115	213	214
116	214	215
117	215	216
118	216	217
119	217	60

UNITS KIPS INCHES
CONSTANTS

E 4415.0 1 TO 70
E 29000.0 900 TO 908
E 24500.0 100 TO 119

UNITS INCHES LBS

ELEMENT PROPERTIES

100	TO	109	TYPE 'IPCABLE' AX	0.15	SW	0.0433	DIR	-Y	LF	0.9998
110	TO	119	TYPE 'IPCABLE' AX	0.15	SW	0.0433	DIR	-Y	LF	0.9998

PRINT MEMBER PROPERTIES

UNITS INCHES KIPS

LOAD 1 'SUPERIMPOSED LOADS (CABLE SELF WEIGHT + APPLIED DL)'

\$\$\$---cable unit weight (SW) is specified in cable properties

JOINT LOADS

209	FORCE Y	-0.0622
210	FORCE Y	-0.0622
211	FORCE Y	-0.0622
212	FORCE Y	-0.0622
213	FORCE Y	-0.0622
214	FORCE Y	-0.0622
215	FORCE Y	-0.0622
216	FORCE Y	-0.0622
217	FORCE Y	-0.0622

UNITS INCHES KIPS
DEFINE CABLE NETWORK 1
INCLUDE ELEMENTS 100 101 102 103 104 105 106 107 108 109
ATTACH JOINTS 35 71
SAG COORDINATE Y 288 JOINT 204
ADJUST COORDS Y
CONVERGENCE RATE -0.01
END

DEFINE CABLE NETWORK 2
INCLUDE ELEMENTS 110 111 112 113 114 115 116 117 118 119
ATTACH JOINTS 24 60
INITIAL TENSION 1.29 JOINTS 24 60
ADJUST LENGTHS
CONVERGENCE RATE 0.5
END

CABLE PRESTRESS ANALYSIS DATA
CONVERGENCE TOLERANCE GEOMETRY 0.0005
CONVERGENCE TOLERANCE DISPLACEMENT 1.0E-4
MAXIMUM NUMBER OF GEOMETRY ITERATIONS 200
MAXIMUM NUMBER OF EQUILIBRIUM ITERATIONS 1000
LOAD 1
END

PERFORM CABLE GEOMETRY ANALYSIS

LOAD LIST ALL
LOAD COMBINATION 'SW+DL' COMBINE 1 1.0
COMBINE 'SW+DL'
UNITS KIPS

LIST CABLE ANALYSIS RESULTS ELEMENTS 100 TO 119

\$----- SIGNAL LOAD CASE 2 (SW+DL+WL Z-direction) -----

UNITS KIPS

CHANGES

LOAD 1

ADDITIONS

UNITS INCH KIPS DEG FAH

JOINT LOADS

35	FORCE X	0.0000	FORCE Z	0.0651		
200	FORCE X	0.0000	FORCE Z	0.0759		
201	FORCE X	0.0000	FORCE Z	0.0217		
202	FORCE X	0.0000	FORCE Z	0.0217		
203	FORCE X	0.0000	FORCE Z	0.0217		
204	FORCE X	0.0000	FORCE Z	0.0217		
205	FORCE X	0.0000	FORCE Z	0.0217		
206	FORCE X	0.0000	FORCE Z	0.0217		
207	FORCE X	0.0000	FORCE Z	0.0217		
208	FORCE X	0.0000	FORCE Z	0.0759		
71	FORCE X	0.0000	FORCE Z	0.0651		
24	FORCE X	0.0000	FORCE Z	0.0651	FORCE Y	0.0000
209	FORCE X	0.0000	FORCE Z	0.2240	FORCE Y	0.1470
210	FORCE X	0.0000	FORCE Z	0.1700	FORCE Y	0.1470
211	FORCE X	0.0000	FORCE Z	0.1700	FORCE Y	0.1470
212	FORCE X	0.0000	FORCE Z	0.1700	FORCE Y	0.1470
213	FORCE X	0.0000	FORCE Z	0.1700	FORCE Y	0.1470
214	FORCE X	0.0000	FORCE Z	0.1700	FORCE Y	0.1470
215	FORCE X	0.0000	FORCE Z	0.1700	FORCE Y	0.1470
216	FORCE X	0.0000	FORCE Z	0.1700	FORCE Y	0.1470
217	FORCE X	0.0000	FORCE Z	0.2240	FORCE Y	0.1470
60	FORCE X	0.0000	FORCE Z	0.0651	FORCE Y	0.0000

LOAD LIST 1

NONLINEAR ANALYSIS CONTINUE

LOAD COMBINATION 'SW+DL+WL' COMBINE 1 1.3

COMBINE 'SW+DL+WL'

LOAD LIST 'SW+DL' 'SW+DL+WL'

OUTPUT BY MEMBER

UNITS INCHES KIPS

LIST CABLE ANALYSIS RESULTS ELEMENTS 100 TO 119

LIST STRESSES ELEMENTS 100 TO 119

LIST FORCES MEMBERS 1 36

Box Configuration

STRU DL '1' '11'

\$\$

\$\$

\$\$

UNITS INCHES LBS DEG FAH
JOINT COORDINATES GLOBAL

1	0	0	0
2	0	12	0
3	0	24	0
4	0	36	0
5	0	48	0
6	0	60	0
7	0	72	0
8	0	84	0
9	0	96	0
10	0	108	0
11	0	120	0
12	0	132	0
13	0	144	0
14	0	156	0
15	0	168	0
16	0	180	0
17	0	192	0
18	0	204	0
19	0	216	0
20	0	228	0
21	0	240	0
22	0	252	0
23	0	264	0
24	0	276	0
25	0	288	0
26	0	300	0
27	0	312	0
28	0	324	0
29	0	336	0
30	0	348	0
31	0	360	0
32	0	372	0
33	0	384	0
34	0	396	0
35	0	408	0
36	0	420	0
37	0	432	0
38	1920	0	0
39	1920	12	0

40	1920	24	0
41	1920	36	0
42	1920	48	0
43	1920	60	0
44	1920	72	0
45	1920	84	0
46	1920	96	0
47	1920	108	0
48	1920	120	0
49	1920	132	0
50	1920	144	0
51	1920	156	0
52	1920	168	0
53	1920	180	0
54	1920	192	0
55	1920	204	0
56	1920	216	0
57	1920	228	0
58	1920	240	0
59	1920	252	0
60	1920	264	0
61	1920	276	0
62	1920	288	0
63	1920	300	0
64	1920	312	0
65	1920	324	0
66	1920	336	0
67	1920	348	0
68	1920	360	0
69	1920	372	0
70	1920	384	0
71	1920	396	0
72	1920	408	0
73	1920	420	0
74	1920	432	0
75	1920	0	1920
76	1920	12	1920
77	1920	24	1920
78	1920	36	1920
79	1920	48	1920
80	1920	60	1920
81	1920	72	1920
82	1920	84	1920
83	1920	96	1920
84	1920	108	1920
85	1920	120	1920
86	1920	132	1920
87	1920	144	1920
88	1920	156	1920
89	1920	168	1920
90	1920	180	1920
91	1920	192	1920

92	1920	204	1920
93	1920	216	1920
94	1920	228	1920
95	1920	240	1920
96	1920	252	1920
97	1920	264	1920
98	1920	276	1920
99	1920	288	1920
100	1920	300	1920
101	1920	312	1920
102	1920	324	1920
103	1920	336	1920
104	1920	348	1920
105	1920	360	1920
106	1920	372	1920
107	1920	384	1920
108	1920	396	1920
109	1920	408	1920
110	1920	420	1920
111	1920	432	1920
112	0	-0	1920
113	0	12	1920
114	0	24	1920
115	0	36	1920
116	0	48	1920
117	0	60	1920
118	0	72	1920
119	0	84	1920
120	0	96	1920
121	0	108	1920
122	0	120	1920
123	0	132	1920
124	0	144	1920
125	0	156	1920
126	0	168	1920
127	0	180	1920
128	0	192	1920
129	0	204	1920
130	0	216	1920
131	0	228	1920
132	0	240	1920
133	0	252	1920
134	0	264	1920
135	0	276	1920
136	0	288	1920
137	0	300	1920
138	0	312	1920
139	0	324	1920
140	0	336	1920
141	0	348	1920
142	0	360	1920
143	0	372	1920

144	0	384	1920
145	0	396	1920
146	0	408	1920
147	0	420	1920
148	0	432	1920
200	240	420	0
201	360	420	0
202	480	420	0
203	600	420	0
204	720	420	0
205	840	420	0
206	960	420	0
207	1080	420	0
208	1200	420	0
209	1320	420	0
210	1440	420	0
211	1560	420	0
212	1680	420	0
213	1920	420	240
214	1920	420	360
215	1920	420	480
216	1920	420	600
217	1920	420	720
218	1920	420	840
219	1920	420	960
220	1920	420	1080
221	1920	420	1200
222	1920	420	1320
223	1920	420	1440
224	1920	420	1560
225	1920	420	1680
226	240	420	1920
227	360	420	1920
228	480	420	1920
229	600	420	1920
230	720	420	1920
231	840	420	1920
232	960	420	1920
233	1080	420	1920
234	1200	420	1920
235	1320	420	1920
236	1440	420	1920
237	1560	420	1920
238	1680	420	1920
239	0	420	240
240	0	420	360
241	0	420	480
242	0	420	600
243	0	420	720
244	0	420	840
245	0	420	960

246	0	420	1080
247	0	420	1200
248	0	420	1320
249	0	420	1440
250	0	420	1560
251	0	420	1680

400	240	312	0
401	360	312	0
402	480	312	0
403	600	312	0
404	720	312	0
405	840	312	0
406	960	312	0
407	1080	312	0
408	1200	312	0
409	1320	312	0
410	1440	312	0
411	1560	312	0
412	1680	312	0
413	1920	312	240
414	1920	312	360
415	1920	312	480
416	1920	312	600
417	1920	312	720
418	1920	312	840
419	1920	312	960
420	1920	312	1080
421	1920	312	1200
422	1920	312	1320
423	1920	312	1440
424	1920	312	1560
425	1920	312	1680
426	240	312	1920
427	360	312	1920
428	480	312	1920
429	600	312	1920
430	720	312	1920
431	840	312	1920
432	960	312	1920
433	1080	312	1920
434	1200	312	1920
435	1320	312	1920
436	1440	312	1920
437	1560	312	1920
438	1680	312	1920
439	0	312	240
440	0	312	360
441	0	312	480
442	0	312	600
443	0	312	720
444	0	312	840

445	0	312	960
446	0	312	1080
447	0	312	1200
448	0	312	1320
449	0	312	1440
450	0	312	1560
451	0	312	1680

TYPE SPACE FRAME
MEMBER INCIDENCES

1	1	2
2	2	3
3	3	4
4	4	5
5	5	6
6	6	7
7	7	8
8	8	9
9	9	10
10	10	11
11	11	12
12	12	13
13	13	14
14	14	15
15	15	16
16	16	17
17	17	18
18	18	19
19	19	20
20	20	21
21	21	22
22	22	23
23	23	24
24	24	25
25	25	26
26	26	27
27	27	28
28	28	29
29	29	30
30	30	31
31	31	32
32	32	33
33	33	34
34	34	35
35	35	36
36	36	37
37	38	39
38	39	40
39	40	41

40	41	42
41	42	43
42	43	44
43	44	45
44	45	46
45	46	47
46	47	48
47	48	49
48	49	50
49	50	51
50	51	52
51	52	53
52	53	54
53	54	55
54	55	56
55	56	57
56	57	58
57	58	59
58	59	60
59	60	61
60	61	62
61	62	63
62	63	64
63	64	65
64	65	66
65	66	67
66	67	68
67	68	69
68	69	70
69	70	71
70	71	72
71	72	73
72	73	74
73	75	76
74	76	77
75	77	78
76	78	79
77	79	80
78	80	81
79	81	82
80	82	83
81	83	84
82	84	85
83	85	86
84	86	87
85	87	88
86	88	89
87	89	90
88	90	91
89	91	92
90	92	93
91	93	94

92	94	95
93	95	96
94	96	97
95	97	98
96	98	99
97	99	100
98	100	101
99	101	102
100	102	103
101	103	104
102	104	105
103	105	106
104	106	107
105	107	108
106	108	109
107	109	110
108	110	111
109	112	113
110	113	114
111	114	115
112	115	116
113	116	117
114	117	118
115	118	119
116	119	120
117	120	121
118	121	122
119	122	123
120	123	124
121	124	125
122	125	126
123	126	127
124	127	128
125	128	129
126	129	130
127	130	131
128	131	132
129	132	133
130	133	134
131	134	135
132	135	136
133	136	137
134	137	138
135	138	139
136	139	140
137	140	141
138	141	142
139	142	143
140	143	144
141	144	145
142	145	146
143	146	147

144 147 148

TYPE SPACE TRUSS
MEMBER INCIDENCES

900	200	400
901	201	401
902	202	402
903	203	403
904	204	404
905	205	405
906	206	406
907	207	407
908	208	408
909	209	409
910	210	410
911	211	411
912	212	412
913	213	413
914	214	414
915	215	415
916	216	416
917	217	417
918	218	418
919	219	419
920	220	420
921	221	421
922	222	422
923	223	423
924	224	424
925	225	425
926	226	426
927	227	427
928	228	428
929	229	429
930	230	430
931	231	431
932	232	432
933	233	433
934	234	434
935	235	435
936	236	436
937	237	437
938	238	438
939	239	439
940	240	440
941	241	441
942	242	442
943	243	443
944	244	444

945	245	445
946	246	446
947	247	447
948	248	448
949	249	449
950	250	450
951	251	451

UNITS INCHES KIPS DEG FAH

MEMBER PROPERTIES PRISMATIC AX 371.5 AY 371.5 -
 AZ 371.5 IX 17830 IY 17830 -
 IZ 17830 SY 1640 SZ 1640 -
 YD 21.75 ZD 21.75 YC 10.88 -
 ZC 10.88
 1 37 73 109

MEMBER PROPERTIES PRISMATIC AX 365.9 AY 365.9 -
 AZ 365.9 IX 17300 IY 17300 -
 IZ 17300 SY 1603 SZ 1603 -
 YD 21.59 ZD 21.59 YC 10.79 -
 ZC 10.79
 2 38 74 110

MEMBER PROPERTIES PRISMATIC AX 360.4 AY 360.4 -
 AZ 360.4 IX 16790 IY 16790 -
 IZ 16790 SY 1567 SZ 1567 -
 YD 21.43 ZD 21.43 YC 10.71 -
 ZC 10.71
 3 39 75 111

MEMBER PROPERTIES PRISMATIC AX 354.9 AY 354.9 -
 AZ 354.9 IX 16290 IY 16290 -
 IZ 16290 SY 1532 SZ 1532 -
 YD 21.27 ZD 21.27 YC 10.63 -
 ZC 10.63
 4 40 76 112

MEMBER PROPERTIES PRISMATIC AX 349.4 AY 349.4 -
 AZ 349.4 IX 15790 IY 15790 -
 IZ 15790 SY 1497 SZ 1497 -
 YD 21.1 ZD 21.1 YC 10.55 -
 ZC 10.55
 5 41 77 113

MEMBER PROPERTIES PRISMATIC AX 344 AY 344 -
 AZ 344 IX 15310 IY 15310 -
 IZ 15310 SY 1463 SZ 1463 -
 YD 20.94 ZD 20.94 YC 10.47 -
 ZC 10.47
 6 42 78 114

MEMBER PROPERTIES PRISMATIC AX 338.6 AY 338.6 -
AZ 338.6 IX 14840 IY 14840 -
IZ 14840 SY 1429 SZ 1429 -
YD 20.78 ZD 20.78 YC 10.39 -
ZC 10.39
7 43 79 115

MEMBER PROPERTIES PRISMATIC AX 333.3 AY 333.3 -
AZ 333.3 IX 14390 IY 14390 -
IZ 14390 SY 1396 SZ 1396 -
YD 20.62 ZD 20.62 YC 10.31 -
ZC 10.31
8 44 80 116

MEMBER PROPERTIES PRISMATIC AX 328 AY 328 -
AZ 328 IX 13940 IY 13940 -
IZ 13940 SY 1363 SZ 1363 -
YD 20.46 ZD 20.46 YC 10.23 -
ZC 10.23
9 45 81 117

MEMBER PROPERTIES PRISMATIC AX 322.8 AY 322.8 -
AZ 322.8 IX 13500 IY 13500 -
IZ 13500 SY 1331 SZ 1331 -
YD 20.29 ZD 20.29 YC 10.15 -
ZC 10.15
10 46 82 118

MEMBER PROPERTIES PRISMATIC AX 317.6 AY 317.6 -
AZ 317.6 IX 13070 IY 13070 -
IZ 13070 SY 1299 SZ 1299 -
YD 20.13 ZD 20.13 YC 10.07 -
ZC 10.07
11 47 83 119

MEMBER PROPERTIES PRISMATIC AX 312.4 AY 312.4 -
AZ 312.4 IX 12660 IY 12660 -
IZ 12660 SY 1268 SZ 1268 -
YD 19.97 ZD 19.97 YC 9.985 -
ZC 9.985
12 48 84 120

MEMBER PROPERTIES PRISMATIC AX 307.3 AY 307.3 -
AZ 307.3 IX 12250 IY 12250 -
IZ 12250 SY 1237 SZ 1237 -
YD 19.81 ZD 19.81 YC 9.904 -
ZC 9.904
13 49 85 121

MEMBER PROPERTIES PRISMATIC AX 302.2 AY 302.2 -
AZ 302.2 IX 11850 IY 11850 -

IZ 11850 SY 1207 SZ 1207 -
YD 19.65 ZD 19.65 YC 9.822 -
ZC 9.822
14 50 86 122

MEMBER PROPERTIES PRISMATIC AX 297.2 AY 297.2 -
AZ 297.2 IX 11470 IY 11470 -
IZ 11470 SY 1177 SZ 1177 -
YD 19.48 ZD 19.48 YC 9.742 -
ZC 9.742
15 51 87 123

MEMBER PROPERTIES PRISMATIC AX 292.2 AY 292.2 -
AZ 292.2 IX 11090 IY 11090 -
IZ 11090 SY 1148 SZ 1148 -
YD 19.32 ZD 19.32 YC 9.661 -
ZC 9.661
16 52 88 124

MEMBER PROPERTIES PRISMATIC AX 287.3 AY 287.3 -
AZ 287.3 IX 10720 IY 10720 -
IZ 10720 SY 1119 SZ 1119 -
YD 19.16 ZD 19.16 YC 9.579 -
ZC 9.579
17 53 89 125

MEMBER PROPERTIES PRISMATIC AX 282.4 AY 282.4 -
AZ 282.4 IX 10360 IY 10360 -
IZ 10360 SY 1091 SZ 1091 -
YD 19 ZD 19 YC 9.498 -
ZC 9.498
18 54 90 126

MEMBER PROPERTIES PRISMATIC AX 277.5 AY 277.5 -
AZ 277.5 IX 10010 IY 10010 -
IZ 10010 SY 1063 SZ 1063 -
YD 18.84 ZD 18.84 YC 9.418 -
ZC 9.418
19 55 91 127

MEMBER PROPERTIES PRISMATIC AX 272.7 AY 272.7 -
AZ 272.7 IX 9672 IY 9672 -
IZ 9672 SY 1036 SZ 1036 -
YD 18.67 ZD 18.67 YC 9.337 -
ZC 9.337
20 56 92 128

MEMBER PROPERTIES PRISMATIC AX 267.9 AY 267.9 -
AZ 267.9 IX 9340 IY 9340 -
IZ 9340 SY 1009 SZ 1009 -
YD 18.51 ZD 18.51 YC 9.256 -
ZC 9.256

21 57 93 129

MEMBER PROPERTIES PRISMATIC AX 263.2 AY 263.2 -
AZ 263.2 IX 9016 IY 9016 -
IZ 9016 SY 982.8 SZ 982.8 -
YD 18.35 ZD 18.35 YC 9.175 -
ZC 9.175
22 58 94 130

MEMBER PROPERTIES PRISMATIC AX 258.5 AY 258.5 -
AZ 258.5 IX 8701 IY 8701 -
IZ 8701 SY 956.9 SZ 956.9 -
YD 18.19 ZD 18.19 YC 9.094 -
ZC 9.094
23 59 95 131

MEMBER PROPERTIES PRISMATIC AX 253.8 AY 253.8 -
AZ 253.8 IX 8395 IY 8395 -
IZ 8395 SY 931.5 SZ 931.5 -
YD 18.03 ZD 18.03 YC 9.013 -
ZC 9.013
24 60 96 132

MEMBER PROPERTIES PRISMATIC AX 249.2 AY 249.2 -
AZ 249.2 IX 8096 IY 8096 -
IZ 8096 SY 906.5 SZ 906.5 -
YD 17.86 ZD 17.86 YC 8.932 -
ZC 8.932
25 61 97 133

MEMBER PROPERTIES PRISMATIC AX 244.7 AY 244.7 -
AZ 244.7 IX 7806 IY 7806 -
IZ 7806 SY 882 SZ 882 -
YD 17.7 ZD 17.7 YC 8.851 -
ZC 8.851
26 62 98 134

MEMBER PROPERTIES PRISMATIC AX 240.1 AY 240.1 -
AZ 240.1 IX 7523 IY 7523 -
IZ 7523 SY 857.9 SZ 857.9 -
YD 17.54 ZD 17.54 YC 8.77 -
ZC 8.77
27 63 99 135

MEMBER PROPERTIES PRISMATIC AX 235.7 AY 235.7 -
AZ 235.7 IX 7248 IY 7248 -
IZ 7248 SY 834.3 SZ 834.3 -
YD 17.38 ZD 17.38 YC 8.688 -
ZC 8.688
28 64 100 136

MEMBER PROPERTIES PRISMATIC AX 231.2 AY 231.2 -
A-25

AZ 231.2 IX 6981 IY 6981 -
IZ 6981 SY 811.1 SZ 811.1 -
YD 17.22 ZD 17.22 YC 8.607 -
ZC 8.607
29 65 101 137

MEMBER PROPERTIES PRISMATIC AX 226.8 AY 226.8 -
AZ 226.8 IX 6721 IY 6721 -
IZ 6721 SY 788.3 SZ 788.3 -
YD 17.05 ZD 17.05 YC 8.527 -
ZC 8.527
30 66 102 138

MEMBER PROPERTIES PRISMATIC AX 222.5 AY 222.5 -
AZ 222.5 IX 6469 IY 6469 -
IZ 6469 SY 766 SZ 766 -
YD 16.89 ZD 16.89 YC 8.446 -
ZC 8.446
31 67 103 139

MEMBER PROPERTIES PRISMATIC AX 218.1 AY 218.1 -
AZ 218.1 IX 6224 IY 6224 -
IZ 6224 SY 744.1 SZ 744.1 -
YD 16.73 ZD 16.73 YC 8.364 -
ZC 8.364
32 68 104 140

MEMBER PROPERTIES PRISMATIC AX 213.9 AY 213.9 -
AZ 213.9 IX 5985 IY 5985 -
IZ 5985 SY 722.6 SZ 722.6 -
YD 16.57 ZD 16.57 YC 8.284 -
ZC 8.284
33 69 105 141

MEMBER PROPERTIES PRISMATIC AX 209.6 AY 209.6 -
AZ 209.6 IX 5754 IY 5754 -
IZ 5754 SY 701.5 SZ 701.5 -
YD 16.41 ZD 16.41 YC 8.203 -
ZC 8.203
34 70 106 142

MEMBER PROPERTIES PRISMATIC AX 205.5 AY 205.5 -
AZ 205.5 IX 5530 IY 5530 -
IZ 5530 SY 680.9 SZ 680.9 -
YD 16.24 ZD 16.24 YC 8.122 -
ZC 8.122
35 71 107 143

MEMBER PROPERTIES PRISMATIC AX 201.3 AY 201.3 -
AZ 201.3 IX 5312 IY 5312 -
IZ 5312 SY 660.6 SZ 660.6 -
YD 16.08 ZD 16.08 YC 8.04 -

ZC 8.04

36 72 108 144

MEMBER PROPERTIES PIPE OD 7.5000000E-01 THI 2.5000000E-01

900 TO 951

STATUS SUPPORT -

1 38 75 112

TYPE SPACE TRUSS
ELEMENT INCIDENCES

300	36	200
301	200	201
302	201	202
303	202	203
304	203	204
305	204	205
306	205	206
307	206	207
308	207	208
309	208	209
310	209	210
311	210	211
312	211	212
313	212	73
314	73	213
315	213	214
316	214	215
317	215	216
318	216	217
319	217	218
320	218	219
321	219	220
322	220	221
323	221	222
324	222	223
325	223	224
326	224	225
327	225	110
328	147	226
329	226	227
330	227	228

331	228	229
332	229	230
333	230	231
334	231	232
335	232	233
336	233	234
337	234	235
338	235	236
339	236	237
340	237	238
341	238	110
342	36	239
343	239	240
344	240	241
345	241	242
346	242	243
347	243	244
348	244	245
349	245	246
350	246	247
351	247	248
352	248	249
353	249	250
354	250	251
355	251	147

400	27	400
401	400	401
402	401	402
403	402	403
404	403	404
405	404	405
406	405	406
407	406	407
408	407	408
409	408	409
410	409	410
411	410	411
412	411	412
413	412	64
414	64	413
415	413	414
416	414	415
417	415	416
418	416	417
419	417	418
420	418	419
421	419	420
422	420	421
423	421	422
424	422	423
425	423	424

426	424	425
427	425	101
428	138	426
429	426	427
430	427	428
431	428	429
432	429	430
433	430	431
434	431	432
435	432	433
436	433	434
437	434	435
438	435	436
439	436	437
440	437	438
441	438	101
442	27	439
443	439	440
444	440	441
445	441	442
446	442	443
447	443	444
448	444	445
449	445	446
450	446	447
451	447	448
452	448	449
453	449	450
454	450	451
455	451	138

UNITS KIPS INCHES

CONSTANTS

E 4415.0 1 TO 144

E 29000.0 900 TO 951

E 24500.0 300 TO 355 400 TO 455

UNITS INCHES LBS

ELEMENT PROPERTIES

300	TO	313	TYPE 'IPCABLE'	AX	0.15	SW	0.0433	DIR	-Y	LF	0.9998
314	TO	327	TYPE 'IPCABLE'	AX	0.15	SW	0.0433	DIR	-Y	LF	0.9998
328	TO	341	TYPE 'IPCABLE'	AX	0.15	SW	0.0433	DIR	-Y	LF	0.9998
342	TO	355	TYPE 'IPCABLE'	AX	0.15	SW	0.0433	DIR	-Y	LF	0.9998
400	TO	413	TYPE 'IPCABLE'	AX	0.15	SW	0.0433	DIR	-Y	LF	0.9998
414	TO	427	TYPE 'IPCABLE'	AX	0.15	SW	0.0433	DIR	-Y	LF	0.9998
428	TO	441	TYPE 'IPCABLE'	AX	0.15	SW	0.0433	DIR	-Y	LF	0.9998
442	TO	455	TYPE 'IPCABLE'	AX	0.15	SW	0.0433	DIR	-Y	LF	0.9998

PRINT MEMBER PROPERTIES

UNITS INCHES KIPS

LOAD 1 'SUPERIMPOSED LOADS (CABLE SELF WEIGHT + APPLIED DL)'

\$\$\$---cable unit weight (SW) is specified in cable properties

JOINT LOADS

400 FORCE Y -0.082
401 FORCE Y -0.082
402 FORCE Y -0.082
403 FORCE Y -0.082
404 FORCE Y -0.082
405 FORCE Y -0.082
406 FORCE Y -0.082
407 FORCE Y -0.082
408 FORCE Y -0.082
409 FORCE Y -0.082
410 FORCE Y -0.082
411 FORCE Y -0.082
412 FORCE Y -0.082
413 FORCE Y -0.082
414 FORCE Y -0.082
415 FORCE Y -0.082
416 FORCE Y -0.082
417 FORCE Y -0.082
418 FORCE Y -0.082
419 FORCE Y -0.082
420 FORCE Y -0.082
421 FORCE Y -0.082
422 FORCE Y -0.082
423 FORCE Y -0.082
424 FORCE Y -0.082
425 FORCE Y -0.082
426 FORCE Y -0.082
427 FORCE Y -0.082
428 FORCE Y -0.082
429 FORCE Y -0.082
430 FORCE Y -0.082
431 FORCE Y -0.082
432 FORCE Y -0.082
433 FORCE Y -0.082
434 FORCE Y -0.082
435 FORCE Y -0.082
436 FORCE Y -0.082
437 FORCE Y -0.082
438 FORCE Y -0.082
439 FORCE Y -0.082
440 FORCE Y -0.082
441 FORCE Y -0.082
442 FORCE Y -0.082
443 FORCE Y -0.082

444 FORCE Y -0.082
445 FORCE Y -0.082
446 FORCE Y -0.082
447 FORCE Y -0.082
448 FORCE Y -0.082
449 FORCE Y -0.082
450 FORCE Y -0.082
451 FORCE Y -0.082

\$\$\$---cable unit weight (SW) is specified in cable properties

UNITS INCHES KIPS

DEFINE CABLE NETWORK 1

INCLUDE ELEMENTS 300 301 302 303 304 305 306 307 308 309 310
311 312 313
ATTACH JOINTS 36 73
SAG COORDINATE Y 324 JOINT 206
ADJUST COORDS Y
CONVERGENCE RATE -0.01
END

DEFINE CABLE NETWORK 2

INCLUDE ELEMENTS 314 315 316 317 318 319 320 321 322 323 324
325 326 327
ATTACH JOINTS 73 110
SAG COORDINATE Y 324 JOINT 219
ADJUST COORDS Y
CONVERGENCE RATE -0.01
END

DEFINE CABLE NETWORK 3

INCLUDE ELEMENTS 328 329 330 331 332 333 334 335 336 337 338
339 340 341
ATTACH JOINTS 147 110
SAG COORDINATE Y 324 JOINT 232
ADJUST COORDS Y
CONVERGENCE RATE -0.01
END

DEFINE CABLE NETWORK 4

INCLUDE ELEMENTS 342 343 344 345 346 347 348 349 350 351 352
353 354 355
ATTACH JOINTS 36 147
SAG COORDINATE Y 324 JOINT 245
ADJUST COORDS Y
CONVERGENCE RATE -0.01
END

DEFINE CABLE NETWORK 5

INCLUDE ELEMENTS 400 401 402 403 404 405 406 407 408 409 410
411 412 413
ATTACH JOINTS 27 64
INITIAL TENSION 1.032 JOINTS 27 64
ADJUST LENGTHS
CONVERGENCE RATE 0.5
END

DEFINE CABLE NETWORK 6
INCLUDE ELEMENTS 414 415 416 417 418 419 420 421 422 423 424
425 426 427
ATTACH JOINTS 64 101
INITIAL TENSION 1.032 JOINTS 64 101
ADJUST LENGTHS
CONVERGENCE RATE 0.5
END

DEFINE CABLE NETWORK 7
INCLUDE ELEMENTS 428 429 430 431 432 433 434 435 436 437 438
439 440 441
ATTACH JOINTS 138 101
INITIAL TENSION 1.032 JOINTS 138 101
ADJUST LENGTHS
CONVERGENCE RATE 0.5
END

DEFINE CABLE NETWORK 8
INCLUDE ELEMENTS 442 443 444 445 446 447 448 449 450 451 452
453 454 455
ATTACH JOINTS 27 138
INITIAL TENSION 1.032 JOINTS 27 138
ADJUST LENGTHS
CONVERGENCE RATE 0.5
END

CABLE PRESTRESS ANALYSIS DATA
CONVERGENCE TOLERANCE GEOMETRY 0.0005
CONVERGENCE TOLERANCE DISPLACEMENT 1.0E-4
MAXIMUM NUMBER OF GEOMETRY ITERATIONS 200
MAXIMUM NUMBER OF EQUILIBRIUM ITERATIONS 1000
LOAD 1
END

PERFORM CABLE GEOMETRY ANALYSIS

LOAD LIST ALL
LOAD COMBINATION 'SW+DL' COMBINE 1 1.0
COMBINE 'SW+DL'

UNITS KIPS

LIST CABLE ANALYSIS RESULTS ELEMENTS 300 TO 355 400 TO 455

\$----- SIGNAL LOAD CASE 2 (SW+DL+WL Z-direction) -----

UNITS KIPS

CHANGES

LOAD 1

ADDITIONS

UNITS INCH KIPS DEG FAH

JOINT LOADS

36 FORCE X 7.33E-19 FORCE Z 0.012
73 FORCE X 7.33E-19 FORCE Z 0.012
110 FORCE X 7.33E-19 FORCE Z 0.012
147 FORCE X 7.33E-19 FORCE Z 0.012
200 FORCE X 0 FORCE Z 0.018
201 FORCE X 0 FORCE Z 0.012
202 FORCE X 0 FORCE Z 0.012
203 FORCE X 0 FORCE Z 0.012
204 FORCE X 0 FORCE Z 0.012
205 FORCE X 0 FORCE Z 0.012
206 FORCE X 0 FORCE Z 0.012
207 FORCE X 0 FORCE Z 0.012
208 FORCE X 0 FORCE Z 0.012
209 FORCE X 0 FORCE Z 0.012
210 FORCE X 0 FORCE Z 0.012
211 FORCE X 0 FORCE Z 0.012
212 FORCE X 0 FORCE Z 0.018
213 FORCE X 1.1E-18 FORCE Z 0
214 FORCE X 7.33E-19 FORCE Z 0
215 FORCE X 7.33E-19 FORCE Z 0
216 FORCE X 7.33E-19 FORCE Z 0
217 FORCE X 7.33E-19 FORCE Z 0
218 FORCE X 7.33E-19 FORCE Z 0
219 FORCE X 7.33E-19 FORCE Z 0
220 FORCE X 7.33E-19 FORCE Z 0
221 FORCE X 7.33E-19 FORCE Z 0
222 FORCE X 7.33E-19 FORCE Z 0

223 FORCE X 7.33E-19 FORCE Z 0
 224 FORCE X 7.33E-19 FORCE Z 0
 225 FORCE X 1.1E-18 FORCE Z 0
 226 FORCE X 0 FORCE Z 0.018
 227 FORCE X 0 FORCE Z 0.012
 228 FORCE X 0 FORCE Z 0.012
 229 FORCE X 0 FORCE Z 0.012
 230 FORCE X 0 FORCE Z 0.012
 231 FORCE X 0 FORCE Z 0.012
 232 FORCE X 0 FORCE Z 0.012
 233 FORCE X 0 FORCE Z 0.012
 234 FORCE X 0 FORCE Z 0.012
 235 FORCE X 0 FORCE Z 0.012
 236 FORCE X 0 FORCE Z 0.012
 237 FORCE X 0 FORCE Z 0.012
 238 FORCE X 0 FORCE Z 0.018
 239 FORCE X 1.1E-18 FORCE Z 0
 240 FORCE X 7.33E-19 FORCE Z 0
 241 FORCE X 7.33E-19 FORCE Z 0
 242 FORCE X 7.33E-19 FORCE Z 0
 243 FORCE X 7.33E-19 FORCE Z 0
 244 FORCE X 7.33E-19 FORCE Z 0
 245 FORCE X 7.33E-19 FORCE Z 0
 246 FORCE X 7.33E-19 FORCE Z 0
 247 FORCE X 7.33E-19 FORCE Z 0
 248 FORCE X 7.33E-19 FORCE Z 0
 249 FORCE X 7.33E-19 FORCE Z 0
 250 FORCE X 7.33E-19 FORCE Z 0
 251 FORCE X 1.1E-18 FORCE Z 0
 400 FORCE X 5.6E-18 FORCE Z 0.194 FORCE Y 0.1
 401 FORCE X 5.6E-18 FORCE Z 0.188 FORCE Y 0.1
 402 FORCE X 5.6E-18 FORCE Z 0.188 FORCE Y 0.1
 403 FORCE X 5.6E-18 FORCE Z 0.188 FORCE Y 0.1
 404 FORCE X 5.6E-18 FORCE Z 0.188 FORCE Y 0.1
 405 FORCE X 5.6E-18 FORCE Z 0.188 FORCE Y 0.1
 406 FORCE X 5.6E-18 FORCE Z 0.188 FORCE Y 0.1
 407 FORCE X 5.6E-18 FORCE Z 0.188 FORCE Y 0.1
 408 FORCE X 5.6E-18 FORCE Z 0.188 FORCE Y 0.1
 409 FORCE X 5.6E-18 FORCE Z 0.188 FORCE Y 0.1
 410 FORCE X 5.6E-18 FORCE Z 0.188 FORCE Y 0.1
 411 FORCE X 5.6E-18 FORCE Z 0.188 FORCE Y 0.1
 412 FORCE X 5.6E-18 FORCE Z 0.194 FORCE Y 0.1
 413 FORCE X 1.18E-17 FORCE Z 0.0915 FORCE Y 0.0523
 414 FORCE X 1.15E-17 FORCE Z 0.0915 FORCE Y 0.0523
 415 FORCE X 1.15E-17 FORCE Z 0.0915 FORCE Y 0.0523
 416 FORCE X 1.15E-17 FORCE Z 0.0915 FORCE Y 0.0523
 417 FORCE X 1.15E-17 FORCE Z 0.0915 FORCE Y 0.0523
 418 FORCE X 1.15E-17 FORCE Z 0.0915 FORCE Y 0.0523
 419 FORCE X 1.15E-17 FORCE Z 0.0915 FORCE Y 0.0523
 420 FORCE X 1.15E-17 FORCE Z 0.0915 FORCE Y 0.0523
 421 FORCE X 1.15E-17 FORCE Z 0.0915 FORCE Y 0.0523
 422 FORCE X 1.15E-17 FORCE Z 0.0915 FORCE Y 0.0523

423 FORCE X 1.15E-17 FORCE Z 0.0915 FORCE Y 0.0523
 424 FORCE X 1.15E-17 FORCE Z 0.0915 FORCE Y 0.0523
 425 FORCE X 1.18E-17 FORCE Z 0.0915 FORCE Y 0.0523
 426 FORCE X 5.6E-18 FORCE Z 0.194 FORCE Y 0.1
 427 FORCE X 5.6E-18 FORCE Z 0.188 FORCE Y 0.1
 428 FORCE X 5.6E-18 FORCE Z 0.188 FORCE Y 0.1
 429 FORCE X 5.6E-18 FORCE Z 0.188 FORCE Y 0.1
 430 FORCE X 5.6E-18 FORCE Z 0.188 FORCE Y 0.1
 431 FORCE X 5.6E-18 FORCE Z 0.188 FORCE Y 0.1
 432 FORCE X 5.6E-18 FORCE Z 0.188 FORCE Y 0.1
 433 FORCE X 5.6E-18 FORCE Z 0.188 FORCE Y 0.1
 434 FORCE X 5.6E-18 FORCE Z 0.188 FORCE Y 0.1
 435 FORCE X 5.6E-18 FORCE Z 0.188 FORCE Y 0.1
 436 FORCE X 5.6E-18 FORCE Z 0.188 FORCE Y 0.1
 437 FORCE X 5.6E-18 FORCE Z 0.188 FORCE Y 0.1
 438 FORCE X 5.6E-18 FORCE Z 0.194 FORCE Y 0.1
 439 FORCE X 1.18E-17 FORCE Z 0.0915 FORCE Y 0.0523
 440 FORCE X 1.15E-17 FORCE Z 0.0915 FORCE Y 0.0523
 441 FORCE X 1.15E-17 FORCE Z 0.0915 FORCE Y 0.0523
 442 FORCE X 1.15E-17 FORCE Z 0.0915 FORCE Y 0.0523
 443 FORCE X 1.15E-17 FORCE Z 0.0915 FORCE Y 0.0523
 444 FORCE X 1.15E-17 FORCE Z 0.0915 FORCE Y 0.0523
 445 FORCE X 1.15E-17 FORCE Z 0.0915 FORCE Y 0.0523
 446 FORCE X 1.15E-17 FORCE Z 0.0915 FORCE Y 0.0523
 447 FORCE X 1.15E-17 FORCE Z 0.0915 FORCE Y 0.0523
 448 FORCE X 1.15E-17 FORCE Z 0.0915 FORCE Y 0.0523
 449 FORCE X 1.15E-17 FORCE Z 0.0915 FORCE Y 0.0523
 450 FORCE X 1.15E-17 FORCE Z 0.0915 FORCE Y 0.0523
 451 FORCE X 1.18E-17 FORCE Z 0.0915 FORCE Y 0.0523
 27 FORCE X 7.33E-19 FORCE Z 0.012 FORCE Y 0
 64 FORCE X 7.33E-19 FORCE Z 0.012 FORCE Y 0
 101 FORCE X 7.33E-19 FORCE Z 0.012 FORCE Y 0
 138 FORCE X 7.33E-19 FORCE Z 0.012 FORCE Y 0

LOAD LIST 1
 NONLINEAR ANALYSIS CONTINUE
 LOAD COMBINATION 'SW+DL+WL' COMBINE 1 1.3
 COMBINE 'SW+DL+WL'

LOAD LIST 'SW+DL' 'SW+DL+WL'

OUTPUT BY MEMBER

UNITS INCHES KIPS

LIST CABLE ANALYSIS RESULTS ELEMENTS 300 TO 355 400 TO 455

LIST STRESSES ELEMENTS 300 TO 355 400 TO 455

LIST FORCES MEMBERS 1 37 73 109

Hanging Box Configuration

STRUDL '1' '11'

\$\$

\$\$

\$\$

UNITS FEET LBS DEG FAH
JOINT COORDINATES GLOBAL

1	0	0	0
2	0	0	1
3	0	0	2
4	0	0	3
5	0	0	4
6	0	0	5
7	0	0	6
8	0	0	7
9	0	0	8
10	0	0	9
11	0	0	10
12	0	0	11
13	0	0	12
14	0	0	13
15	0	0	14
16	0	0	15
17	0	0	16
18	0	0	17
19	0	0	18
20	0	0	19
21	0	0	20
22	0	0	21
23	0	0	22
24	0	0	23
25	0	0	24
26	0	0	25
27	0	0	26
28	0	0	27
29	0	0	28
30	0	0	29
31	0	0	30
32	0	0	31
33	0	0	32
34	0	0	33
35	0	0	34
36	0	0	35
37	0	0	36
38	240	0	0
39	240	0	1
40	240	0	2

41	240	0	3
42	240	0	4
43	240	0	5
44	240	0	6
45	240	0	7
46	240	0	8
47	240	0	9
48	240	0	10
49	240	0	11
50	240	0	12
51	240	0	13
52	240	0	14
53	240	0	15
54	240	0	16
55	240	0	17
56	240	0	18
57	240	0	19
58	240	0	20
59	240	0	21
60	240	0	22
61	240	0	23
62	240	0	24
63	240	0	25
64	240	0	26
65	240	0	27
66	240	0	28
67	240	0	29
68	240	0	30
69	240	0	31
70	240	0	32
71	240	0	33
72	240	0	34
73	240	0	35
74	240	0	36
75	240	240	0
76	240	240	1
77	240	240	2
78	240	240	3
79	240	240	4
80	240	240	5
81	240	240	6
82	240	240	7
83	240	240	8
84	240	240	9
85	240	240	10
86	240	240	11
87	240	240	12
88	240	240	13
89	240	240	14
90	240	240	15
91	240	240	16
92	240	240	17

93	240	240	18
94	240	240	19
95	240	240	20
96	240	240	21
97	240	240	22
98	240	240	23
99	240	240	24
100	240	240	25
101	240	240	26
102	240	240	27
103	240	240	28
104	240	240	29
105	240	240	30
106	240	240	31
107	240	240	32
108	240	240	33
109	240	240	34
110	240	240	35
111	240	240	36
112	0	240	-0
113	0	240	1
114	0	240	2
115	0	240	3
116	0	240	4
117	0	240	5
118	0	240	6
119	0	240	7
120	0	240	8
121	0	240	9
122	0	240	10
123	0	240	11
124	0	240	12
125	0	240	13
126	0	240	14
127	0	240	15
128	0	240	16
129	0	240	17
130	0	240	18
131	0	240	19
132	0	240	20
133	0	240	21
134	0	240	22
135	0	240	23
136	0	240	24
137	0	240	25
138	0	240	26
139	0	240	27
140	0	240	28
141	0	240	29
142	0	240	30
143	0	240	31
144	0	240	32

145	0	240	33
146	0	240	34
147	0	240	35
148	0	240	36
200	20	20	32
201	220	20	32
202	220	220	32
203	20	220	32
204	90	20	32
205	100	20	32
206	110	20	32
207	120	20	32
208	130	20	32
209	140	20	32
210	150	20	32
211	220	90	32
212	220	100	32
213	220	110	32
214	220	120	32
215	220	130	32
216	220	140	32
217	220	150	32
218	150	220	32
219	140	220	32
220	130	220	32
221	120	220	32
222	110	220	32
223	100	220	32
224	90	220	32
225	20	150	32
226	20	140	32
227	20	130	32
228	20	120	32
229	20	110	32
230	20	100	32
231	20	90	32
400	20	20	29
401	220	20	29
402	220	220	29
403	20	220	29
404	90	20	29
405	100	20	29
406	110	20	29
407	120	20	29
408	130	20	29
409	140	20	29
410	150	20	29
411	220	90	29
412	220	100	29
413	220	110	29
414	220	120	29

415	220	130	29
416	220	140	29
417	220	150	29
418	150	220	29
419	140	220	29
420	130	220	29
421	120	220	29
422	110	220	29
423	100	220	29
424	90	220	29
425	20	150	29
426	20	140	29
427	20	130	29
428	20	120	29
429	20	110	29
430	20	100	29
431	20	90	29

TYPE SPACE FRAME
MEMBER INCIDENCES

1	1	2
2	2	3
3	3	4
4	4	5
5	5	6
6	6	7
7	7	8
8	8	9
9	9	10
10	10	11
11	11	12
12	12	13
13	13	14
14	14	15
15	15	16
16	16	17
17	17	18
18	18	19
19	19	20
20	20	21
21	21	22
22	22	23
23	23	24
24	24	25
25	25	26
26	26	27
27	27	28
28	28	29
29	29	30

30	30	31
31	31	32
32	32	33
33	33	34
34	34	35
35	35	36
36	36	37
37	38	39
38	39	40
39	40	41
40	41	42
41	42	43
42	43	44
43	44	45
44	45	46
45	46	47
46	47	48
47	48	49
48	49	50
49	50	51
50	51	52
51	52	53
52	53	54
53	54	55
54	55	56
55	56	57
56	57	58
57	58	59
58	59	60
59	60	61
60	61	62
61	62	63
62	63	64
63	64	65
64	65	66
65	66	67
66	67	68
67	68	69
68	69	70
69	70	71
70	71	72
71	72	73
72	73	74
73	75	76
74	76	77
75	77	78
76	78	79
77	79	80
78	80	81
79	81	82
80	82	83
81	83	84

82	84	85
83	85	86
84	86	87
85	87	88
86	88	89
87	89	90
88	90	91
89	91	92
90	92	93
91	93	94
92	94	95
93	95	96
94	96	97
95	97	98
96	98	99
97	99	100
98	100	101
99	101	102
100	102	103
101	103	104
102	104	105
103	105	106
104	106	107
105	107	108
106	108	109
107	109	110
108	110	111
109	112	113
110	113	114
111	114	115
112	115	116
113	116	117
114	117	118
115	118	119
116	119	120
117	120	121
118	121	122
119	122	123
120	123	124
121	124	125
122	125	126
123	126	127
124	127	128
125	128	129
126	129	130
127	130	131
128	131	132
129	132	133
130	133	134
131	134	135
132	135	136
133	136	137

134	137	138
135	138	139
136	139	140
137	140	141
138	141	142
139	142	143
140	143	144
141	144	145
142	145	146
143	146	147
144	147	148

TYPE SPACE TRUSS
MEMBER INCIDENCES

900	200	400
901	201	401
902	202	402
903	203	403
904	204	404
905	205	405
906	206	406
907	207	407
908	208	408
909	209	409
910	210	410
911	211	411
912	212	412
913	213	413
914	214	414
915	215	415
916	216	416
917	217	417
918	218	418
919	219	419
920	220	420
921	221	421
922	222	422
923	223	423
924	224	424
925	225	425
926	226	426
927	227	427
928	228	428
929	229	429
930	230	430
931	231	431

UNITS INCHES KIPS DEG FAH

MEMBER PROPERTIES PRISMATIC AX 25.09 AY 25.09 -
AZ 25.09 IX 212 IY 212 -
IZ 212 SY 15.66 SZ 15.66 -
YD 27.07 ZD 27.07 YC 13.53 -
ZC 13.53
1

MEMBER PROPERTIES PRISMATIC AX 24.95 AY 24.95 -
AZ 24.95 IX 209.1 IY 209.1 -
IZ 209.1 SY 15.53 SZ 15.53 -
YD 26.93 ZD 26.93 YC 13.47 -
ZC 13.47
2

MEMBER PROPERTIES PRISMATIC AX 24.82 AY 24.82 -
AZ 24.82 IX 206.2 IY 206.2 -
IZ 206.2 SY 15.39 SZ 15.39 -
YD 26.79 ZD 26.79 YC 13.4 -
ZC 13.4
3

MEMBER PROPERTIES PRISMATIC AX 24.69 AY 24.69 -
AZ 24.69 IX 203.3 IY 203.3 -
IZ 203.3 SY 15.26 SZ 15.26 -
YD 26.65 ZD 26.65 YC 13.33 -
ZC 13.33
4

MEMBER PROPERTIES PRISMATIC AX 24.56 AY 24.56 -
AZ 24.56 IX 200.5 IY 200.5 -
IZ 200.5 SY 15.13 SZ 15.13 -
YD 26.51 ZD 26.51 YC 13.26 -
ZC 13.26
5

MEMBER PROPERTIES PRISMATIC AX 24.43 AY 24.43 -
AZ 24.43 IX 197.7 IY 197.7 -
IZ 197.7 SY 14.99 SZ 14.99 -
YD 26.37 ZD 26.37 YC 13.19 -
ZC 13.19
6

MEMBER PROPERTIES PRISMATIC AX 24.3 AY 24.3 -
AZ 24.3 IX 194.9 IY 194.9 -
IZ 194.9 SY 14.86 SZ 14.86 -
YD 26.23 ZD 26.23 YC 13.12 -
ZC 13.12
7

MEMBER PROPERTIES PRISMATIC AX 24.17 AY 24.17 -
AZ 24.17 IX 192.1 IY 192.1 -

IZ 192.1 SY 14.73 SZ 14.73 -
YD 26.09 ZD 26.09 YC 13.05 -
ZC 13.05
8

MEMBER PROPERTIES PRISMATIC AX 24.04 AY 24.04 -
AZ 24.04 IX 189.4 IY 189.4 -
IZ 189.4 SY 14.6 SZ 14.6 -
YD 25.95 ZD 25.95 YC 12.98 -
ZC 12.98
9

MEMBER PROPERTIES PRISMATIC AX 23.9 AY 23.9 -
AZ 23.9 IX 186.7 IY 186.7 -
IZ 186.7 SY 14.47 SZ 14.47 -
YD 25.81 ZD 25.81 YC 12.91 -
ZC 12.91
10

MEMBER PROPERTIES PRISMATIC AX 23.77 AY 23.77 -
AZ 23.77 IX 184 IY 184 -
IZ 184 SY 14.34 SZ 14.34 -
YD 25.67 ZD 25.67 YC 12.84 -
ZC 12.84
11

MEMBER PROPERTIES PRISMATIC AX 23.64 AY 23.64 -
AZ 23.64 IX 181.3 IY 181.3 -
IZ 181.3 SY 14.21 SZ 14.21 -
YD 25.53 ZD 25.53 YC 12.77 -
ZC 12.77
12

MEMBER PROPERTIES PRISMATIC AX 23.51 AY 23.51 -
AZ 23.51 IX 178.7 IY 178.7 -
IZ 178.7 SY 14.08 SZ 14.08 -
YD 25.39 ZD 25.39 YC 12.7 -
ZC 12.7
13

MEMBER PROPERTIES PRISMATIC AX 23.38 AY 23.38 -
AZ 23.38 IX 176.1 IY 176.1 -
IZ 176.1 SY 13.95 SZ 13.95 -
YD 25.25 ZD 25.25 YC 12.63 -
ZC 12.63
14

MEMBER PROPERTIES PRISMATIC AX 23.25 AY 23.25 -
AZ 23.25 IX 173.5 IY 173.5 -
IZ 173.5 SY 13.82 SZ 13.82 -
YD 25.11 ZD 25.11 YC 12.56 -
ZC 12.56

15

MEMBER PROPERTIES PRISMATIC AX 23.12 AY 23.12 -
AZ 23.12 IX 171 IY 171 -
IZ 171 SY 13.69 SZ 13.69 -
YD 24.97 ZD 24.97 YC 12.48 -
ZC 12.48

16

MEMBER PROPERTIES PRISMATIC AX 22.99 AY 22.99 -
AZ 22.99 IX 168.4 IY 168.4 -
IZ 168.4 SY 13.57 SZ 13.57 -
YD 24.83 ZD 24.83 YC 12.41 -
ZC 12.41

17

MEMBER PROPERTIES PRISMATIC AX 22.85 AY 22.85 -
AZ 22.85 IX 165.9 IY 165.9 -
IZ 165.9 SY 13.44 SZ 13.44 -
YD 24.69 ZD 24.69 YC 12.34 -
ZC 12.34

18

MEMBER PROPERTIES PRISMATIC AX 22.72 AY 22.72 -
AZ 22.72 IX 163.4 IY 163.4 -
IZ 163.4 SY 13.31 SZ 13.31 -
YD 24.55 ZD 24.55 YC 12.28 -
ZC 12.28

19

MEMBER PROPERTIES PRISMATIC AX 22.59 AY 22.59 -
AZ 22.59 IX 161 IY 161 -
IZ 161 SY 13.19 SZ 13.19 -
YD 24.41 ZD 24.41 YC 12.21 -
ZC 12.21

20

MEMBER PROPERTIES PRISMATIC AX 22.46 AY 22.46 -
AZ 22.46 IX 158.5 IY 158.5 -
IZ 158.5 SY 13.06 SZ 13.06 -
YD 24.27 ZD 24.27 YC 12.14 -
ZC 12.14

21

MEMBER PROPERTIES PRISMATIC AX 22.33 AY 22.33 -
AZ 22.33 IX 156.1 IY 156.1 -
IZ 156.1 SY 12.94 SZ 12.94 -
YD 24.13 ZD 24.13 YC 12.07 -
ZC 12.07

22

MEMBER PROPERTIES PRISMATIC AX 22.2 AY 22.2 -

AZ 22.2 IX 153.7 IY 153.7 -
IZ 153.7 SY 12.82 SZ 12.82 -
YD 23.99 ZD 23.99 YC 11.99 -
ZC 11.99
23

MEMBER PROPERTIES PRISMATIC AX 22.07 AY 22.07 -
AZ 22.07 IX 151.4 IY 151.4 -
IZ 151.4 SY 12.69 SZ 12.69 -
YD 23.85 ZD 23.85 YC 11.92 -
ZC 11.92
24

MEMBER PROPERTIES PRISMATIC AX 21.94 AY 21.94 -
AZ 21.94 IX 149 IY 149 -
IZ 149 SY 12.57 SZ 12.57 -
YD 23.71 ZD 23.71 YC 11.85 -
ZC 11.85
25

MEMBER PROPERTIES PRISMATIC AX 21.8 AY 21.8 -
AZ 21.8 IX 146.7 IY 146.7 -
IZ 146.7 SY 12.45 SZ 12.45 -
YD 23.57 ZD 23.57 YC 11.78 -
ZC 11.78
26

MEMBER PROPERTIES PRISMATIC AX 21.67 AY 21.67 -
AZ 21.67 IX 144.4 IY 144.4 -
IZ 144.4 SY 12.33 SZ 12.33 -
YD 23.43 ZD 23.43 YC 11.72 -
ZC 11.72
27

MEMBER PROPERTIES PRISMATIC AX 21.54 AY 21.54 -
AZ 21.54 IX 142.1 IY 142.1 -
IZ 142.1 SY 12.21 SZ 12.21 -
YD 23.29 ZD 23.29 YC 11.65 -
ZC 11.65
28

MEMBER PROPERTIES PRISMATIC AX 21.41 AY 21.41 -
AZ 21.41 IX 139.9 IY 139.9 -
IZ 139.9 SY 12.09 SZ 12.09 -
YD 23.15 ZD 23.15 YC 11.57 -
ZC 11.57
29

MEMBER PROPERTIES PRISMATIC AX 21.28 AY 21.28 -
AZ 21.28 IX 137.7 IY 137.7 -
IZ 137.7 SY 11.97 SZ 11.97 -
YD 23.01 ZD 23.01 YC 11.5 -

ZC 11.5
30

MEMBER PROPERTIES PRISMATIC AX 21.15 AY 21.15 -
AZ 21.15 IX 135.5 IY 135.5 -
IZ 135.5 SY 11.85 SZ 11.85 -
YD 22.87 ZD 22.87 YC 11.43 -
ZC 11.43
31

MEMBER PROPERTIES PRISMATIC AX 21.02 AY 21.02 -
AZ 21.02 IX 133.3 IY 133.3 -
IZ 133.3 SY 11.73 SZ 11.73 -
YD 22.73 ZD 22.73 YC 11.36 -
ZC 11.36
32

MEMBER PROPERTIES PRISMATIC AX 20.89 AY 20.89 -
AZ 20.89 IX 131.1 IY 131.1 -
IZ 131.1 SY 11.61 SZ 11.61 -
YD 22.59 ZD 22.59 YC 11.29 -
ZC 11.29
33

MEMBER PROPERTIES PRISMATIC AX 20.75 AY 20.75 -
AZ 20.75 IX 129 IY 129 -
IZ 129 SY 11.49 SZ 11.49 -
YD 22.45 ZD 22.45 YC 11.23 -
ZC 11.23
34

MEMBER PROPERTIES PRISMATIC AX 20.62 AY 20.62 -
AZ 20.62 IX 126.9 IY 126.9 -
IZ 126.9 SY 11.37 SZ 11.37 -
YD 22.31 ZD 22.31 YC 11.15 -
ZC 11.15
35

MEMBER PROPERTIES PRISMATIC AX 20.49 AY 20.49 -
AZ 20.49 IX 124.8 IY 124.8 -
IZ 124.8 SY 11.26 SZ 11.26 -
YD 22.17 ZD 22.17 YC 11.09 -
ZC 11.09
36

MEMBER PROPERTIES PRISMATIC AX 25.09 AY 25.09 -
AZ 25.09 IX 212 IY 212 -
IZ 212 SY 15.66 SZ 15.66 -
YD 27.07 ZD 27.07 YC 13.53 -
ZC 13.53
37

MEMBER PROPERTIES PRISMATIC AX 24.95 AY 24.95 -
AZ 24.95 IX 209.1 IY 209.1 -
IZ 209.1 SY 15.53 SZ 15.53 -
YD 26.93 ZD 26.93 YC 13.47 -
ZC 13.47

38

MEMBER PROPERTIES PRISMATIC AX 24.82 AY 24.82 -
AZ 24.82 IX 206.2 IY 206.2 -
IZ 206.2 SY 15.39 SZ 15.39 -
YD 26.79 ZD 26.79 YC 13.4 -
ZC 13.4

39

MEMBER PROPERTIES PRISMATIC AX 24.69 AY 24.69 -
AZ 24.69 IX 203.3 IY 203.3 -
IZ 203.3 SY 15.26 SZ 15.26 -
YD 26.65 ZD 26.65 YC 13.33 -
ZC 13.33

40

MEMBER PROPERTIES PRISMATIC AX 24.56 AY 24.56 -
AZ 24.56 IX 200.5 IY 200.5 -
IZ 200.5 SY 15.13 SZ 15.13 -
YD 26.51 ZD 26.51 YC 13.26 -
ZC 13.26

41

MEMBER PROPERTIES PRISMATIC AX 24.43 AY 24.43 -
AZ 24.43 IX 197.7 IY 197.7 -
IZ 197.7 SY 14.99 SZ 14.99 -
YD 26.37 ZD 26.37 YC 13.19 -
ZC 13.19

42

MEMBER PROPERTIES PRISMATIC AX 24.3 AY 24.3 -
AZ 24.3 IX 194.9 IY 194.9 -
IZ 194.9 SY 14.86 SZ 14.86 -
YD 26.23 ZD 26.23 YC 13.12 -
ZC 13.12

43

MEMBER PROPERTIES PRISMATIC AX 24.17 AY 24.17 -
AZ 24.17 IX 192.1 IY 192.1 -
IZ 192.1 SY 14.73 SZ 14.73 -
YD 26.09 ZD 26.09 YC 13.05 -
ZC 13.05

44

MEMBER PROPERTIES PRISMATIC AX 24.04 AY 24.04 -
AZ 24.04 IX 189.4 IY 189.4 -

IZ 189.4 SY 14.6 SZ 14.6 -
YD 25.95 ZD 25.95 YC 12.98 -
ZC 12.98
45

MEMBER PROPERTIES PRISMATIC AX 23.9 AY 23.9 -
AZ 23.9 IX 186.7 IY 186.7 -
IZ 186.7 SY 14.47 SZ 14.47 -
YD 25.81 ZD 25.81 YC 12.91 -
ZC 12.91
46

MEMBER PROPERTIES PRISMATIC AX 23.77 AY 23.77 -
AZ 23.77 IX 184 IY 184 -
IZ 184 SY 14.34 SZ 14.34 -
YD 25.67 ZD 25.67 YC 12.84 -
ZC 12.84
47

MEMBER PROPERTIES PRISMATIC AX 23.64 AY 23.64 -
AZ 23.64 IX 181.3 IY 181.3 -
IZ 181.3 SY 14.21 SZ 14.21 -
YD 25.53 ZD 25.53 YC 12.77 -
ZC 12.77
48

MEMBER PROPERTIES PRISMATIC AX 23.51 AY 23.51 -
AZ 23.51 IX 178.7 IY 178.7 -
IZ 178.7 SY 14.08 SZ 14.08 -
YD 25.39 ZD 25.39 YC 12.7 -
ZC 12.7
49

MEMBER PROPERTIES PRISMATIC AX 23.38 AY 23.38 -
AZ 23.38 IX 176.1 IY 176.1 -
IZ 176.1 SY 13.95 SZ 13.95 -
YD 25.25 ZD 25.25 YC 12.63 -
ZC 12.63
50

MEMBER PROPERTIES PRISMATIC AX 23.25 AY 23.25 -
AZ 23.25 IX 173.5 IY 173.5 -
IZ 173.5 SY 13.82 SZ 13.82 -
YD 25.11 ZD 25.11 YC 12.56 -
ZC 12.56
51

MEMBER PROPERTIES PRISMATIC AX 23.12 AY 23.12 -
AZ 23.12 IX 171 IY 171 -
IZ 171 SY 13.69 SZ 13.69 -
YD 24.97 ZD 24.97 YC 12.48 -
ZC 12.48

52

MEMBER PROPERTIES PRISMATIC AX 22.99 AY 22.99 -
AZ 22.99 IX 168.4 IY 168.4 -
IZ 168.4 SY 13.57 SZ 13.57 -
YD 24.83 ZD 24.83 YC 12.41 -
ZC 12.41

53

MEMBER PROPERTIES PRISMATIC AX 22.85 AY 22.85 -
AZ 22.85 IX 165.9 IY 165.9 -
IZ 165.9 SY 13.44 SZ 13.44 -
YD 24.69 ZD 24.69 YC 12.34 -
ZC 12.34

54

MEMBER PROPERTIES PRISMATIC AX 22.72 AY 22.72 -
AZ 22.72 IX 163.4 IY 163.4 -
IZ 163.4 SY 13.31 SZ 13.31 -
YD 24.55 ZD 24.55 YC 12.28 -
ZC 12.28

55

MEMBER PROPERTIES PRISMATIC AX 22.59 AY 22.59 -
AZ 22.59 IX 161 IY 161 -
IZ 161 SY 13.19 SZ 13.19 -
YD 24.41 ZD 24.41 YC 12.21 -
ZC 12.21

56

MEMBER PROPERTIES PRISMATIC AX 22.46 AY 22.46 -
AZ 22.46 IX 158.5 IY 158.5 -
IZ 158.5 SY 13.06 SZ 13.06 -
YD 24.27 ZD 24.27 YC 12.14 -
ZC 12.14

57

MEMBER PROPERTIES PRISMATIC AX 22.33 AY 22.33 -
AZ 22.33 IX 156.1 IY 156.1 -
IZ 156.1 SY 12.94 SZ 12.94 -
YD 24.13 ZD 24.13 YC 12.07 -
ZC 12.07

58

MEMBER PROPERTIES PRISMATIC AX 22.2 AY 22.2 -
AZ 22.2 IX 153.7 IY 153.7 -
IZ 153.7 SY 12.82 SZ 12.82 -
YD 23.99 ZD 23.99 YC 11.99 -
ZC 11.99

59

MEMBER PROPERTIES PRISMATIC AX 22.07 AY 22.07 -
A-51

AZ 22.07 IX 151.4 IY 151.4 -
IZ 151.4 SY 12.69 SZ 12.69 -
YD 23.85 ZD 23.85 YC 11.92 -
ZC 11.92
60

MEMBER PROPERTIES PRISMATIC AX 21.94 AY 21.94 -
AZ 21.94 IX 149 IY 149 -
IZ 149 SY 12.57 SZ 12.57 -
YD 23.71 ZD 23.71 YC 11.85 -
ZC 11.85
61

MEMBER PROPERTIES PRISMATIC AX 21.8 AY 21.8 -
AZ 21.8 IX 146.7 IY 146.7 -
IZ 146.7 SY 12.45 SZ 12.45 -
YD 23.57 ZD 23.57 YC 11.78 -
ZC 11.78
62

MEMBER PROPERTIES PRISMATIC AX 21.67 AY 21.67 -
AZ 21.67 IX 144.4 IY 144.4 -
IZ 144.4 SY 12.33 SZ 12.33 -
YD 23.43 ZD 23.43 YC 11.72 -
ZC 11.72
63

MEMBER PROPERTIES PRISMATIC AX 21.54 AY 21.54 -
AZ 21.54 IX 142.1 IY 142.1 -
IZ 142.1 SY 12.21 SZ 12.21 -
YD 23.29 ZD 23.29 YC 11.65 -
ZC 11.65
64

MEMBER PROPERTIES PRISMATIC AX 21.41 AY 21.41 -
AZ 21.41 IX 139.9 IY 139.9 -
IZ 139.9 SY 12.09 SZ 12.09 -
YD 23.15 ZD 23.15 YC 11.57 -
ZC 11.57
65

MEMBER PROPERTIES PRISMATIC AX 21.28 AY 21.28 -
AZ 21.28 IX 137.7 IY 137.7 -
IZ 137.7 SY 11.97 SZ 11.97 -
YD 23.01 ZD 23.01 YC 11.5 -
ZC 11.5
66

MEMBER PROPERTIES PRISMATIC AX 21.15 AY 21.15 -
AZ 21.15 IX 135.5 IY 135.5 -
IZ 135.5 SY 11.85 SZ 11.85 -
YD 22.87 ZD 22.87 YC 11.43 -

ZC 11.43
67

MEMBER PROPERTIES PRISMATIC AX 21.02 AY 21.02 -
AZ 21.02 IX 133.3 IY 133.3 -
IZ 133.3 SY 11.73 SZ 11.73 -
YD 22.73 ZD 22.73 YC 11.36 -
ZC 11.36
68

MEMBER PROPERTIES PRISMATIC AX 20.89 AY 20.89 -
AZ 20.89 IX 131.1 IY 131.1 -
IZ 131.1 SY 11.61 SZ 11.61 -
YD 22.59 ZD 22.59 YC 11.29 -
ZC 11.29
69

MEMBER PROPERTIES PRISMATIC AX 20.75 AY 20.75 -
AZ 20.75 IX 129 IY 129 -
IZ 129 SY 11.49 SZ 11.49 -
YD 22.45 ZD 22.45 YC 11.23 -
ZC 11.23
70

MEMBER PROPERTIES PRISMATIC AX 20.62 AY 20.62 -
AZ 20.62 IX 126.9 IY 126.9 -
IZ 126.9 SY 11.37 SZ 11.37 -
YD 22.31 ZD 22.31 YC 11.15 -
ZC 11.15
71

MEMBER PROPERTIES PRISMATIC AX 20.49 AY 20.49 -
AZ 20.49 IX 124.8 IY 124.8 -
IZ 124.8 SY 11.26 SZ 11.26 -
YD 22.17 ZD 22.17 YC 11.09 -
ZC 11.09
72

MEMBER PROPERTIES PRISMATIC AX 25.09 AY 25.09 -
AZ 25.09 IX 212 IY 212 -
IZ 212 SY 15.66 SZ 15.66 -
YD 27.07 ZD 27.07 YC 13.53 -
ZC 13.53
73

MEMBER PROPERTIES PRISMATIC AX 24.95 AY 24.95 -
AZ 24.95 IX 209.1 IY 209.1 -
IZ 209.1 SY 15.53 SZ 15.53 -
YD 26.93 ZD 26.93 YC 13.47 -
ZC 13.47
74

MEMBER PROPERTIES PRISMATIC AX 24.82 AY 24.82 -
AZ 24.82 IX 206.2 IY 206.2 -
IZ 206.2 SY 15.39 SZ 15.39 -
YD 26.79 ZD 26.79 YC 13.4 -
ZC 13.4

75

MEMBER PROPERTIES PRISMATIC AX 24.69 AY 24.69 -
AZ 24.69 IX 203.3 IY 203.3 -
IZ 203.3 SY 15.26 SZ 15.26 -
YD 26.65 ZD 26.65 YC 13.33 -
ZC 13.33

76

MEMBER PROPERTIES PRISMATIC AX 24.56 AY 24.56 -
AZ 24.56 IX 200.5 IY 200.5 -
IZ 200.5 SY 15.13 SZ 15.13 -
YD 26.51 ZD 26.51 YC 13.26 -
ZC 13.26

77

MEMBER PROPERTIES PRISMATIC AX 24.43 AY 24.43 -
AZ 24.43 IX 197.7 IY 197.7 -
IZ 197.7 SY 14.99 SZ 14.99 -
YD 26.37 ZD 26.37 YC 13.19 -
ZC 13.19

78

MEMBER PROPERTIES PRISMATIC AX 24.3 AY 24.3 -
AZ 24.3 IX 194.9 IY 194.9 -
IZ 194.9 SY 14.86 SZ 14.86 -
YD 26.23 ZD 26.23 YC 13.12 -
ZC 13.12

79

MEMBER PROPERTIES PRISMATIC AX 24.17 AY 24.17 -
AZ 24.17 IX 192.1 IY 192.1 -
IZ 192.1 SY 14.73 SZ 14.73 -
YD 26.09 ZD 26.09 YC 13.05 -
ZC 13.05

80

MEMBER PROPERTIES PRISMATIC AX 24.04 AY 24.04 -
AZ 24.04 IX 189.4 IY 189.4 -
IZ 189.4 SY 14.6 SZ 14.6 -
YD 25.95 ZD 25.95 YC 12.98 -
ZC 12.98

81

MEMBER PROPERTIES PRISMATIC AX 23.9 AY 23.9 -
AZ 23.9 IX 186.7 IY 186.7 -

IZ 186.7 SY 14.47 SZ 14.47 -
YD 25.81 ZD 25.81 YC 12.91 -
ZC 12.91
82

MEMBER PROPERTIES PRISMATIC AX 23.77 AY 23.77 -
AZ 23.77 IX 184 IY 184 -
IZ 184 SY 14.34 SZ 14.34 -
YD 25.67 ZD 25.67 YC 12.84 -
ZC 12.84
83

MEMBER PROPERTIES PRISMATIC AX 23.64 AY 23.64 -
AZ 23.64 IX 181.3 IY 181.3 -
IZ 181.3 SY 14.21 SZ 14.21 -
YD 25.53 ZD 25.53 YC 12.77 -
ZC 12.77
84

MEMBER PROPERTIES PRISMATIC AX 23.51 AY 23.51 -
AZ 23.51 IX 178.7 IY 178.7 -
IZ 178.7 SY 14.08 SZ 14.08 -
YD 25.39 ZD 25.39 YC 12.7 -
ZC 12.7
85

MEMBER PROPERTIES PRISMATIC AX 23.38 AY 23.38 -
AZ 23.38 IX 176.1 IY 176.1 -
IZ 176.1 SY 13.95 SZ 13.95 -
YD 25.25 ZD 25.25 YC 12.63 -
ZC 12.63
86

MEMBER PROPERTIES PRISMATIC AX 23.25 AY 23.25 -
AZ 23.25 IX 173.5 IY 173.5 -
IZ 173.5 SY 13.82 SZ 13.82 -
YD 25.11 ZD 25.11 YC 12.56 -
ZC 12.56
87

MEMBER PROPERTIES PRISMATIC AX 23.12 AY 23.12 -
AZ 23.12 IX 171 IY 171 -
IZ 171 SY 13.69 SZ 13.69 -
YD 24.97 ZD 24.97 YC 12.48 -
ZC 12.48
88

MEMBER PROPERTIES PRISMATIC AX 22.99 AY 22.99 -
AZ 22.99 IX 168.4 IY 168.4 -
IZ 168.4 SY 13.57 SZ 13.57 -
YD 24.83 ZD 24.83 YC 12.41 -
ZC 12.41

89

MEMBER PROPERTIES PRISMATIC AX 22.85 AY 22.85 -
AZ 22.85 IX 165.9 IY 165.9 -
IZ 165.9 SY 13.44 SZ 13.44 -
YD 24.69 ZD 24.69 YC 12.34 -
ZC 12.34

90

MEMBER PROPERTIES PRISMATIC AX 22.72 AY 22.72 -
AZ 22.72 IX 163.4 IY 163.4 -
IZ 163.4 SY 13.31 SZ 13.31 -
YD 24.55 ZD 24.55 YC 12.28 -
ZC 12.28

91

MEMBER PROPERTIES PRISMATIC AX 22.59 AY 22.59 -
AZ 22.59 IX 161 IY 161 -
IZ 161 SY 13.19 SZ 13.19 -
YD 24.41 ZD 24.41 YC 12.21 -
ZC 12.21

92

MEMBER PROPERTIES PRISMATIC AX 22.46 AY 22.46 -
AZ 22.46 IX 158.5 IY 158.5 -
IZ 158.5 SY 13.06 SZ 13.06 -
YD 24.27 ZD 24.27 YC 12.14 -
ZC 12.14

93

MEMBER PROPERTIES PRISMATIC AX 22.33 AY 22.33 -
AZ 22.33 IX 156.1 IY 156.1 -
IZ 156.1 SY 12.94 SZ 12.94 -
YD 24.13 ZD 24.13 YC 12.07 -
ZC 12.07

94

MEMBER PROPERTIES PRISMATIC AX 22.2 AY 22.2 -
AZ 22.2 IX 153.7 IY 153.7 -
IZ 153.7 SY 12.82 SZ 12.82 -
YD 23.99 ZD 23.99 YC 11.99 -
ZC 11.99

95

MEMBER PROPERTIES PRISMATIC AX 22.07 AY 22.07 -
AZ 22.07 IX 151.4 IY 151.4 -
IZ 151.4 SY 12.69 SZ 12.69 -
YD 23.85 ZD 23.85 YC 11.92 -
ZC 11.92

96

MEMBER PROPERTIES PRISMATIC AX 21.94 AY 21.94 -

AZ 21.94 IX 149 IY 149 -
IZ 149 SY 12.57 SZ 12.57 -
YD 23.71 ZD 23.71 YC 11.85 -
ZC 11.85
97

MEMBER PROPERTIES PRISMATIC AX 21.8 AY 21.8 -
AZ 21.8 IX 146.7 IY 146.7 -
IZ 146.7 SY 12.45 SZ 12.45 -
YD 23.57 ZD 23.57 YC 11.78 -
ZC 11.78
98

MEMBER PROPERTIES PRISMATIC AX 21.67 AY 21.67 -
AZ 21.67 IX 144.4 IY 144.4 -
IZ 144.4 SY 12.33 SZ 12.33 -
YD 23.43 ZD 23.43 YC 11.72 -
ZC 11.72
99

MEMBER PROPERTIES PRISMATIC AX 21.54 AY 21.54 -
AZ 21.54 IX 142.1 IY 142.1 -
IZ 142.1 SY 12.21 SZ 12.21 -
YD 23.29 ZD 23.29 YC 11.65 -
ZC 11.65
100

MEMBER PROPERTIES PRISMATIC AX 21.41 AY 21.41 -
AZ 21.41 IX 139.9 IY 139.9 -
IZ 139.9 SY 12.09 SZ 12.09 -
YD 23.15 ZD 23.15 YC 11.57 -
ZC 11.57
101

MEMBER PROPERTIES PRISMATIC AX 21.28 AY 21.28 -
AZ 21.28 IX 137.7 IY 137.7 -
IZ 137.7 SY 11.97 SZ 11.97 -
YD 23.01 ZD 23.01 YC 11.5 -
ZC 11.5
102

MEMBER PROPERTIES PRISMATIC AX 21.15 AY 21.15 -
AZ 21.15 IX 135.5 IY 135.5 -
IZ 135.5 SY 11.85 SZ 11.85 -
YD 22.87 ZD 22.87 YC 11.43 -
ZC 11.43
103

MEMBER PROPERTIES PRISMATIC AX 21.02 AY 21.02 -
AZ 21.02 IX 133.3 IY 133.3 -
IZ 133.3 SY 11.73 SZ 11.73 -
YD 22.73 ZD 22.73 YC 11.36 -

ZC 11.36
104

MEMBER PROPERTIES PRISMATIC AX 20.89 AY 20.89 -
AZ 20.89 IX 131.1 IY 131.1 -
IZ 131.1 SY 11.61 SZ 11.61 -
YD 22.59 ZD 22.59 YC 11.29 -
ZC 11.29
105

MEMBER PROPERTIES PRISMATIC AX 20.75 AY 20.75 -
AZ 20.75 IX 129 IY 129 -
IZ 129 SY 11.49 SZ 11.49 -
YD 22.45 ZD 22.45 YC 11.23 -
ZC 11.23
106

MEMBER PROPERTIES PRISMATIC AX 20.62 AY 20.62 -
AZ 20.62 IX 126.9 IY 126.9 -
IZ 126.9 SY 11.37 SZ 11.37 -
YD 22.31 ZD 22.31 YC 11.15 -
ZC 11.15
107

MEMBER PROPERTIES PRISMATIC AX 20.49 AY 20.49 -
AZ 20.49 IX 124.8 IY 124.8 -
IZ 124.8 SY 11.26 SZ 11.26 -
YD 22.17 ZD 22.17 YC 11.09 -
ZC 11.09
108

MEMBER PROPERTIES PRISMATIC AX 25.09 AY 25.09 -
AZ 25.09 IX 212 IY 212 -
IZ 212 SY 15.66 SZ 15.66 -
YD 27.07 ZD 27.07 YC 13.53 -
ZC 13.53
109

MEMBER PROPERTIES PRISMATIC AX 24.95 AY 24.95 -
AZ 24.95 IX 209.1 IY 209.1 -
IZ 209.1 SY 15.53 SZ 15.53 -
YD 26.93 ZD 26.93 YC 13.47 -
ZC 13.47
110

MEMBER PROPERTIES PRISMATIC AX 24.82 AY 24.82 -
AZ 24.82 IX 206.2 IY 206.2 -
IZ 206.2 SY 15.39 SZ 15.39 -
YD 26.79 ZD 26.79 YC 13.4 -
ZC 13.4
111

MEMBER PROPERTIES PRISMATIC AX 24.69 AY 24.69 -
AZ 24.69 IX 203.3 IY 203.3 -
IZ 203.3 SY 15.26 SZ 15.26 -
YD 26.65 ZD 26.65 YC 13.33 -
ZC 13.33
112

MEMBER PROPERTIES PRISMATIC AX 24.56 AY 24.56 -
AZ 24.56 IX 200.5 IY 200.5 -
IZ 200.5 SY 15.13 SZ 15.13 -
YD 26.51 ZD 26.51 YC 13.26 -
ZC 13.26
113

MEMBER PROPERTIES PRISMATIC AX 24.43 AY 24.43 -
AZ 24.43 IX 197.7 IY 197.7 -
IZ 197.7 SY 14.99 SZ 14.99 -
YD 26.37 ZD 26.37 YC 13.19 -
ZC 13.19
114

MEMBER PROPERTIES PRISMATIC AX 24.3 AY 24.3 -
AZ 24.3 IX 194.9 IY 194.9 -
IZ 194.9 SY 14.86 SZ 14.86 -
YD 26.23 ZD 26.23 YC 13.12 -
ZC 13.12
115

MEMBER PROPERTIES PRISMATIC AX 24.17 AY 24.17 -
AZ 24.17 IX 192.1 IY 192.1 -
IZ 192.1 SY 14.73 SZ 14.73 -
YD 26.09 ZD 26.09 YC 13.05 -
ZC 13.05
116

MEMBER PROPERTIES PRISMATIC AX 24.04 AY 24.04 -
AZ 24.04 IX 189.4 IY 189.4 -
IZ 189.4 SY 14.6 SZ 14.6 -
YD 25.95 ZD 25.95 YC 12.98 -
ZC 12.98
117

MEMBER PROPERTIES PRISMATIC AX 23.9 AY 23.9 -
AZ 23.9 IX 186.7 IY 186.7 -
IZ 186.7 SY 14.47 SZ 14.47 -
YD 25.81 ZD 25.81 YC 12.91 -
ZC 12.91
118

MEMBER PROPERTIES PRISMATIC AX 23.77 AY 23.77 -
AZ 23.77 IX 184 IY 184 -

IZ 184 SY 14.34 SZ 14.34 -
YD 25.67 ZD 25.67 YC 12.84 -
ZC 12.84
119

MEMBER PROPERTIES PRISMATIC AX 23.64 AY 23.64 -
AZ 23.64 IX 181.3 IY 181.3 -
IZ 181.3 SY 14.21 SZ 14.21 -
YD 25.53 ZD 25.53 YC 12.77 -
ZC 12.77
120

MEMBER PROPERTIES PRISMATIC AX 23.51 AY 23.51 -
AZ 23.51 IX 178.7 IY 178.7 -
IZ 178.7 SY 14.08 SZ 14.08 -
YD 25.39 ZD 25.39 YC 12.7 -
ZC 12.7
121

MEMBER PROPERTIES PRISMATIC AX 23.38 AY 23.38 -
AZ 23.38 IX 176.1 IY 176.1 -
IZ 176.1 SY 13.95 SZ 13.95 -
YD 25.25 ZD 25.25 YC 12.63 -
ZC 12.63
122

MEMBER PROPERTIES PRISMATIC AX 23.25 AY 23.25 -
AZ 23.25 IX 173.5 IY 173.5 -
IZ 173.5 SY 13.82 SZ 13.82 -
YD 25.11 ZD 25.11 YC 12.56 -
ZC 12.56
123

MEMBER PROPERTIES PRISMATIC AX 23.12 AY 23.12 -
AZ 23.12 IX 171 IY 171 -
IZ 171 SY 13.69 SZ 13.69 -
YD 24.97 ZD 24.97 YC 12.48 -
ZC 12.48
124

MEMBER PROPERTIES PRISMATIC AX 22.99 AY 22.99 -
AZ 22.99 IX 168.4 IY 168.4 -
IZ 168.4 SY 13.57 SZ 13.57 -
YD 24.83 ZD 24.83 YC 12.41 -
ZC 12.41
125

MEMBER PROPERTIES PRISMATIC AX 22.85 AY 22.85 -
AZ 22.85 IX 165.9 IY 165.9 -
IZ 165.9 SY 13.44 SZ 13.44 -
YD 24.69 ZD 24.69 YC 12.34 -
ZC 12.34

126

MEMBER PROPERTIES PRISMATIC AX 22.72 AY 22.72 -
AZ 22.72 IX 163.4 IY 163.4 -
IZ 163.4 SY 13.31 SZ 13.31 -
YD 24.55 ZD 24.55 YC 12.28 -
ZC 12.28

127

MEMBER PROPERTIES PRISMATIC AX 22.59 AY 22.59 -
AZ 22.59 IX 161 IY 161 -
IZ 161 SY 13.19 SZ 13.19 -
YD 24.41 ZD 24.41 YC 12.21 -
ZC 12.21

128

MEMBER PROPERTIES PRISMATIC AX 22.46 AY 22.46 -
AZ 22.46 IX 158.5 IY 158.5 -
IZ 158.5 SY 13.06 SZ 13.06 -
YD 24.27 ZD 24.27 YC 12.14 -
ZC 12.14

129

MEMBER PROPERTIES PRISMATIC AX 22.33 AY 22.33 -
AZ 22.33 IX 156.1 IY 156.1 -
IZ 156.1 SY 12.94 SZ 12.94 -
YD 24.13 ZD 24.13 YC 12.07 -
ZC 12.07

130

MEMBER PROPERTIES PRISMATIC AX 22.2 AY 22.2 -
AZ 22.2 IX 153.7 IY 153.7 -
IZ 153.7 SY 12.82 SZ 12.82 -
YD 23.99 ZD 23.99 YC 11.99 -
ZC 11.99

131

MEMBER PROPERTIES PRISMATIC AX 22.07 AY 22.07 -
AZ 22.07 IX 151.4 IY 151.4 -
IZ 151.4 SY 12.69 SZ 12.69 -
YD 23.85 ZD 23.85 YC 11.92 -
ZC 11.92

132

MEMBER PROPERTIES PRISMATIC AX 21.94 AY 21.94 -
AZ 21.94 IX 149 IY 149 -
IZ 149 SY 12.57 SZ 12.57 -
YD 23.71 ZD 23.71 YC 11.85 -
ZC 11.85

133

MEMBER PROPERTIES PRISMATIC AX 21.8 AY 21.8 -

AZ 21.8 IX 146.7 IY 146.7 -
IZ 146.7 SY 12.45 SZ 12.45 -
YD 23.57 ZD 23.57 YC 11.78 -
ZC 11.78
134

MEMBER PROPERTIES PRISMATIC AX 21.67 AY 21.67 -
AZ 21.67 IX 144.4 IY 144.4 -
IZ 144.4 SY 12.33 SZ 12.33 -
YD 23.43 ZD 23.43 YC 11.72 -
ZC 11.72
135

MEMBER PROPERTIES PRISMATIC AX 21.54 AY 21.54 -
AZ 21.54 IX 142.1 IY 142.1 -
IZ 142.1 SY 12.21 SZ 12.21 -
YD 23.29 ZD 23.29 YC 11.65 -
ZC 11.65
136

MEMBER PROPERTIES PRISMATIC AX 21.41 AY 21.41 -
AZ 21.41 IX 139.9 IY 139.9 -
IZ 139.9 SY 12.09 SZ 12.09 -
YD 23.15 ZD 23.15 YC 11.57 -
ZC 11.57
137

MEMBER PROPERTIES PRISMATIC AX 21.28 AY 21.28 -
AZ 21.28 IX 137.7 IY 137.7 -
IZ 137.7 SY 11.97 SZ 11.97 -
YD 23.01 ZD 23.01 YC 11.5 -
ZC 11.5
138

MEMBER PROPERTIES PRISMATIC AX 21.15 AY 21.15 -
AZ 21.15 IX 135.5 IY 135.5 -
IZ 135.5 SY 11.85 SZ 11.85 -
YD 22.87 ZD 22.87 YC 11.43 -
ZC 11.43
139

MEMBER PROPERTIES PRISMATIC AX 21.02 AY 21.02 -
AZ 21.02 IX 133.3 IY 133.3 -
IZ 133.3 SY 11.73 SZ 11.73 -
YD 22.73 ZD 22.73 YC 11.36 -
ZC 11.36
140

MEMBER PROPERTIES PRISMATIC AX 20.89 AY 20.89 -
AZ 20.89 IX 131.1 IY 131.1 -
IZ 131.1 SY 11.61 SZ 11.61 -
YD 22.59 ZD 22.59 YC 11.29 -

ZC 11.29
141

MEMBER PROPERTIES PRISMATIC AX 20.75 AY 20.75 -
AZ 20.75 IX 129 IY 129 -
IZ 129 SY 11.49 SZ 11.49 -
YD 22.45 ZD 22.45 YC 11.23 -
ZC 11.23
142

MEMBER PROPERTIES PRISMATIC AX 20.62 AY 20.62 -
AZ 20.62 IX 126.9 IY 126.9 -
IZ 126.9 SY 11.37 SZ 11.37 -
YD 22.31 ZD 22.31 YC 11.15 -
ZC 11.15
143

MEMBER PROPERTIES PRISMATIC AX 20.49 AY 20.49 -
AZ 20.49 IX 124.8 IY 124.8 -
IZ 124.8 SY 11.26 SZ 11.26 -
YD 22.17 ZD 22.17 YC 11.09 -
ZC 11.09
144

MEMBER PROPERTIES PIPE OD 7.5000000E-01 THI 2.5000000E-01
900 TO 931

STATUS SUPPORT -

1 38 75 112

TYPE SPACE TRUSS
ELEMENT INCIDENCES

300	200	204
301	204	205
302	205	206
303	206	207
304	207	208
305	208	209
306	209	210
307	210	201
308	201	211
309	211	212
310	212	213
311	213	214

312	214	215
313	215	216
314	216	217
315	217	202
316	202	218
317	218	219
318	219	220
319	220	221
320	221	222
321	222	223
322	223	224
323	224	203
324	203	225
325	225	226
326	226	227
327	227	228
328	228	229
329	229	230
330	230	231
331	231	200
332	36	200
333	73	201
334	110	202
335	147	203
400	400	404
401	404	405
402	405	406
403	406	407
404	407	408
405	408	409
406	409	410
407	410	401
408	401	411
409	411	412
410	412	413
411	413	414
412	414	415
413	415	416
414	416	417
415	417	402
416	402	418
417	418	419
418	419	420
419	420	421
420	421	422
421	422	423
422	423	424
423	424	403
424	403	425
425	425	426
426	426	427

427	427	428
428	428	429
429	429	430
430	430	431
431	431	400
432	27	400
433	64	401
434	101	402
435	138	403

UNITS KIPS INCHES
CONSTANTS

E 29000 1 TO 144
E 29000 900 TO 931
E 24500 300 TO 335 400 TO 435

UNITS INCHES LBS

ELEMENT PROPERTIES

300 TO 307	TYPE 'IPCABLE'	AX	0.15	SW	0.0433	DIR	-Z	LF	0.9998
308 TO 315	TYPE 'IPCABLE'	AX	0.15	SW	0.0433	DIR	-Z	LF	0.9998
316 TO 323	TYPE 'IPCABLE'	AX	0.15	SW	0.0433	DIR	-Z	LF	0.9998
324 TO 331	TYPE 'IPCABLE'	AX	0.15	SW	0.0433	DIR	-Z	LF	0.9998
332	TYPE 'IPCABLE'	AX	0.15	SW	0.0433	DIR	-Z	LF	0.9998
333	TYPE 'IPCABLE'	AX	0.15	SW	0.0433	DIR	-Z	LF	0.9998
334	TYPE 'IPCABLE'	AX	0.15	SW	0.0433	DIR	-Z	LF	0.9998
335	TYPE 'IPCABLE'	AX	0.15	SW	0.0433	DIR	-Z	LF	0.9998
400 TO 407	TYPE 'IPCABLE'	AX	0.15	SW	0.0433	DIR	-Z	LF	0.9998
408 TO 415	TYPE 'IPCABLE'	AX	0.15	SW	0.0433	DIR	-Z	LF	0.9998
416 TO 423	TYPE 'IPCABLE'	AX	0.15	SW	0.0433	DIR	-Z	LF	0.9998
424 TO 431	TYPE 'IPCABLE'	AX	0.15	SW	0.0433	DIR	-Z	LF	0.9998
432	TYPE 'IPCABLE'	AX	0.15	SW	0.0433	DIR	-Z	LF	0.9998
433	TYPE 'IPCABLE'	AX	0.15	SW	0.0433	DIR	-Z	LF	0.9998
434	TYPE 'IPCABLE'	AX	0.15	SW	0.0433	DIR	-Z	LF	0.9998
435	TYPE 'IPCABLE'	AX	0.15	SW	0.0433	DIR	-Z	LF	0.9998

PRINT MEMBER PROPERTIES

UNITS INCHES LBS

LOAD 1 'SUPERIMPOSED LOADS (CABLE SELF WEIGHT + APPLIED DL)'

\$\$\$---cable unit weight (SW) is specified in cable properties

JOINT LOADS

404	FORCE	Z	-52.9
405	FORCE	Z	-52.9
406	FORCE	Z	-52.9
407	FORCE	Z	-52.9

408 FORCE Z -52.9
 409 FORCE Z -52.9
 410 FORCE Z -52.9
 411 FORCE Z -52.9
 412 FORCE Z -52.9
 413 FORCE Z -52.9
 414 FORCE Z -52.9
 415 FORCE Z -52.9
 416 FORCE Z -52.9
 417 FORCE Z -52.9
 418 FORCE Z -52.9
 419 FORCE Z -52.9
 420 FORCE Z -52.9
 421 FORCE Z -52.9
 422 FORCE Z -52.9
 423 FORCE Z -52.9
 424 FORCE Z -52.9
 425 FORCE Z -52.9
 426 FORCE Z -52.9
 427 FORCE Z -52.9
 428 FORCE Z -52.9
 429 FORCE Z -52.9
 430 FORCE Z -52.9
 431 FORCE Z -52.9

\$\$\$---cable unit weight (SW) is specified in cable properties

UNITS FEET KIPS

DEFINE CABLE NETWORK 1

INCLUDE ELEMENTS 300 301 302 303 304 305 306 307
 ATTACH JOINTS 200 201
 INITIAL TENSION 2.9 JOINTS 200 201
 ADJUST LENGTHS
 CONVERGENCE RATE 0.5
 END

DEFINE CABLE NETWORK 2

INCLUDE ELEMENTS 308 309 310 311 312 313 314 315
 ATTACH JOINTS 201 202
 INITIAL TENSION 2.9 JOINTS 201 202
 ADJUST LENGTHS
 CONVERGENCE RATE 0.5
 END

DEFINE CABLE NETWORK 3

INCLUDE ELEMENTS 316 317 318 319 320 321 322 323
 ATTACH JOINTS 202 203
 INITIAL TENSION 2.9 JOINTS 202 203
 ADJUST LENGTHS
 CONVERGENCE RATE 0.5
 END

```

DEFINE CABLE NETWORK 4
INCLUDE ELEMENTS 324 325 326 327 328 329 330 331
ATTACH JOINTS 203 200
INITIAL TENSION 2.9 JOINTS 203 200
ADJUST LENGTHS
CONVERGENCE RATE 0.5
END

```

```

DEFINE CABLE NETWORK 5
INCLUDE ELEMENTS 332
ATTACH JOINTS 36 200
INITIAL TENSION 4.14 JOINTS 36 200
ADJUST LENGTHS
CONVERGENCE RATE 0.5
END

```

```

DEFINE CABLE NETWORK 6
INCLUDE ELEMENTS 333
ATTACH JOINTS 73 201
INITIAL TENSION 4.14 JOINTS 73 201
ADJUST LENGTHS
CONVERGENCE RATE 0.5
END

```

```

DEFINE CABLE NETWORK 7
INCLUDE ELEMENTS 334
ATTACH JOINTS 110 202
INITIAL TENSION 4.14 JOINTS 110 202
ADJUST LENGTHS
CONVERGENCE RATE 0.5
END

```

```

DEFINE CABLE NETWORK 8
INCLUDE ELEMENTS 335
ATTACH JOINTS 147 203
INITIAL TENSION 4.14 JOINTS 147 203
ADJUST LENGTHS
CONVERGENCE RATE 0.5
END

```

```

DEFINE CABLE NETWORK 9
INCLUDE ELEMENTS 400 401 402 403 404 405 406 407
ATTACH JOINTS 400 401
INITIAL TENSION 2.9 JOINTS 400 401
ADJUST LENGTHS
CONVERGENCE RATE 0.5
END

```

```

DEFINE CABLE NETWORK 10
INCLUDE ELEMENTS 408 409 410 411 412 413 414 415

```

```

ATTACH JOINTS      401  402
INITIAL TENSION   2.9 JOINTS      401  402
ADJUST LENGTHS
  CONVERGENCE RATE 0.5
END

```

```

DEFINE CABLE NETWORK 11
INCLUDE ELEMENTS   416  417  418  419  420  421  422  423
ATTACH JOINTS     402  403
INITIAL TENSION   2.9 JOINTS      402  403
ADJUST LENGTHS
  CONVERGENCE RATE 0.5
END

```

```

DEFINE CABLE NETWORK 12
INCLUDE ELEMENTS   424  425  426  427  428  429  430  431
ATTACH JOINTS     403  400
INITIAL TENSION   2.9 JOINTS      403  400
ADJUST LENGTHS
  CONVERGENCE RATE 0.5
END

```

```

DEFINE CABLE NETWORK 13
INCLUDE ELEMENTS   432
ATTACH JOINTS     27  400
INITIAL TENSION   4.14 JOINTS      27  400
ADJUST LENGTHS
  CONVERGENCE RATE 0.5
END

```

```

DEFINE CABLE NETWORK 14
INCLUDE ELEMENTS   433
ATTACH JOINTS     64  401
INITIAL TENSION   4.14 JOINTS      64  401
ADJUST LENGTHS
  CONVERGENCE RATE 0.5
END

```

```

DEFINE CABLE NETWORK 15
INCLUDE ELEMENTS   434
ATTACH JOINTS     101  402
INITIAL TENSION   4.14 JOINTS      101  402
ADJUST LENGTHS
  CONVERGENCE RATE 0.5
END

```

```

DEFINE CABLE NETWORK 16
INCLUDE ELEMENTS   435
ATTACH JOINTS     138  403
INITIAL TENSION   4.14 JOINTS      138  403
ADJUST LENGTHS
  CONVERGENCE RATE 0.5

```

END

CABLE PRESTRESS ANALYSIS DATA

CONVERGENCE TOLERANCE GEOMETRY 0.0005
CONVERGENCE TOLERANCE DISPLACEMENT 1.0E-4
MAXIMUM NUMBER OF GEOMETRY ITERATIONS 200
MAXIMUM NUMBER OF EQUILIBRIUM ITERATIONS 1000

LOAD 1
END

PERFORM CABLE GEOMETRY ANALYSIS

LOAD LIST ALL

LOAD COMBINATION 'SW+DL' COMBINE 1 1.0
COMBINE 'SW+DL'
UNITS KIPS

LIST CABLE ANALYSIS RESULTS ELEMENTS 300 TO 335 400 TO 435

LIST DISPLACEMENT JOINTS 200 TO 215 400 TO 415

\$----- SIGNAL LOAD CASE 2 (SW+DL+WL Z-direction) -----

UNITS KIPS
CHANGES
LOAD 1

ADDITIONS

UNITS INCH LBS DEG FAH

JOINT LOADS

35 FORCE X 1.39E-15 FORCE Y 22.8
73 FORCE X 1.39E-15 FORCE Y 22.8
110 FORCE X 1.39E-15 FORCE Y 22.8
147 FORCE X 1.39E-15 FORCE Y 22.8
200 FORCE X 6.28E-15 FORCE Y 103
201 FORCE X 6.28E-15 FORCE Y 103
202 FORCE X 6.28E-15 FORCE Y 103
203 FORCE X 6.28E-15 FORCE Y 103

204 FORCE X 0 FORCE Y 91.1
 205 FORCE X 0 FORCE Y 22.8
 206 FORCE X 0 FORCE Y 22.8
 207 FORCE X 0 FORCE Y 22.8
 208 FORCE X 0 FORCE Y 22.8
 209 FORCE X 0 FORCE Y 22.8
 210 FORCE X 0 FORCE Y 91.1
 211 FORCE X 5.58E-15 FORCE Y 0
 212 FORCE X 1.39E-15 FORCE Y 0
 213 FORCE X 1.39E-15 FORCE Y 0
 214 FORCE X 1.39E-15 FORCE Y 0
 215 FORCE X 1.39E-15 FORCE Y 0
 216 FORCE X 1.39E-15 FORCE Y 0
 217 FORCE X 5.58E-15 FORCE Y 0
 218 FORCE X 0 FORCE Y 91.1
 219 FORCE X 0 FORCE Y 22.8
 220 FORCE X 0 FORCE Y 22.8
 221 FORCE X 0 FORCE Y 22.8
 222 FORCE X 0 FORCE Y 22.8
 223 FORCE X 0 FORCE Y 22.8
 224 FORCE X 0 FORCE Y 91.1
 225 FORCE X 5.58E-15 FORCE Y 0
 226 FORCE X 1.39E-15 FORCE Y 0
 227 FORCE X 1.39E-15 FORCE Y 0
 228 FORCE X 1.39E-15 FORCE Y 0
 229 FORCE X 1.39E-15 FORCE Y 0
 230 FORCE X 1.39E-15 FORCE Y 0
 231 FORCE X 5.58E-15 FORCE Y 0
 27 FORCE X 1.39E-15 FORCE Y 22.8 FORCE Z 0
 64 FORCE X 1.39E-15 FORCE Y 22.8 FORCE Z 0
 101 FORCE X 1.39E-15 FORCE Y 22.8 FORCE Z 0
 138 FORCE X 1.39E-15 FORCE Y 22.8 FORCE Z 0
 400 FORCE X 6.28E-15 FORCE Y 103 FORCE Z 0
 401 FORCE X 6.28E-15 FORCE Y 103 FORCE Z 0
 402 FORCE X 6.28E-15 FORCE Y 103 FORCE Z 0
 403 FORCE X 6.28E-15 FORCE Y 103 FORCE Z 0
 404 FORCE X 4.65E-15 FORCE Y 247 FORCE Z 154
 405 FORCE X 4.65E-15 FORCE Y 178 FORCE Z 154
 406 FORCE X 4.65E-15 FORCE Y 178 FORCE Z 154
 407 FORCE X 4.65E-15 FORCE Y 178 FORCE Z 154
 408 FORCE X 4.65E-15 FORCE Y 178 FORCE Z 154
 409 FORCE X 4.65E-15 FORCE Y 178 FORCE Z 154
 410 FORCE X 4.65E-15 FORCE Y 247 FORCE Z 154
 411 FORCE X 1.51E-14 FORCE Y 75.9 FORCE Z 75.1
 412 FORCE X 1.09E-14 FORCE Y 75.9 FORCE Z 75.1
 413 FORCE X 1.09E-14 FORCE Y 75.9 FORCE Z 75.1
 414 FORCE X 1.09E-14 FORCE Y 75.9 FORCE Z 75.1
 415 FORCE X 1.09E-14 FORCE Y 75.9 FORCE Z 75.1
 416 FORCE X 1.09E-14 FORCE Y 75.9 FORCE Z 75.1
 417 FORCE X 1.51E-14 FORCE Y 75.9 FORCE Z 75.1
 418 FORCE X 4.65E-15 FORCE Y 247 FORCE Z 154
 419 FORCE X 4.65E-15 FORCE Y 178 FORCE Z 154

420 FORCE X 4.65E-15 FORCE Y 178 FORCE Z 154
421 FORCE X 4.65E-15 FORCE Y 178 FORCE Z 154
422 FORCE X 4.65E-15 FORCE Y 178 FORCE Z 154
423 FORCE X 4.65E-15 FORCE Y 178 FORCE Z 154
424 FORCE X 4.65E-15 FORCE Y 247 FORCE Z 154
425 FORCE X 1.51E-14 FORCE Y 75.9 FORCE Z 75.1
426 FORCE X 1.09E-14 FORCE Y 75.9 FORCE Z 75.1
427 FORCE X 1.09E-14 FORCE Y 75.9 FORCE Z 75.1
428 FORCE X 1.09E-14 FORCE Y 75.9 FORCE Z 75.1
429 FORCE X 1.09E-14 FORCE Y 75.9 FORCE Z 75.1
430 FORCE X 1.09E-14 FORCE Y 75.9 FORCE Z 75.1
431 FORCE X 1.51E-14 FORCE Y 75.9 FORCE Z 75.1

LOAD LIST 1
NONLINEAR ANALYSIS CONTINUE
LOAD COMBINATION 'SW+DL+WL' COMBINE 1 1.3
COMBINE 'SW+DL+WL'

LOAD LIST 'SW+DL' 'SW+DL+WL'
OUTPUT BY MEMBER

UNITS INCHES KIPS

LIST CABLE ANALYSIS RESULTS ELEMENTS 300 TO 335 400 TO 435

LIST STRESSES ELEMENTS 300 TO 335 400 TO 435

LIST FORCES MEMBERS 1 37 73 109

LIST DISPLACEMENT JOINTS 200 TO 215 400 TO 415

Appendix B – Span Wire Intersection Examples

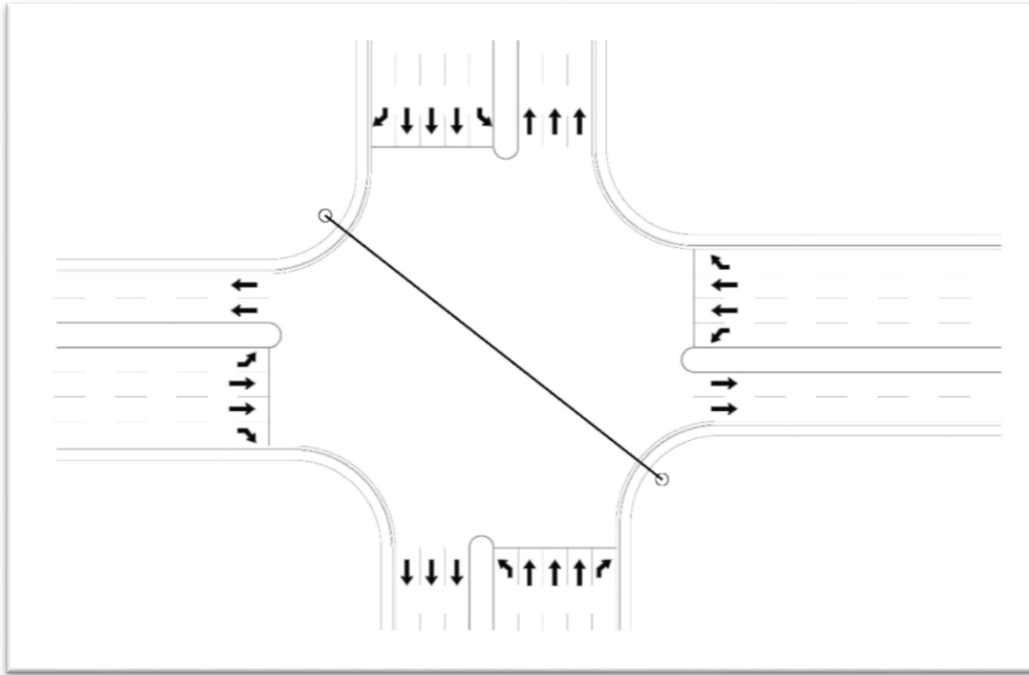

Figure 6 – Single Span Wire Intersection with 0° Skew

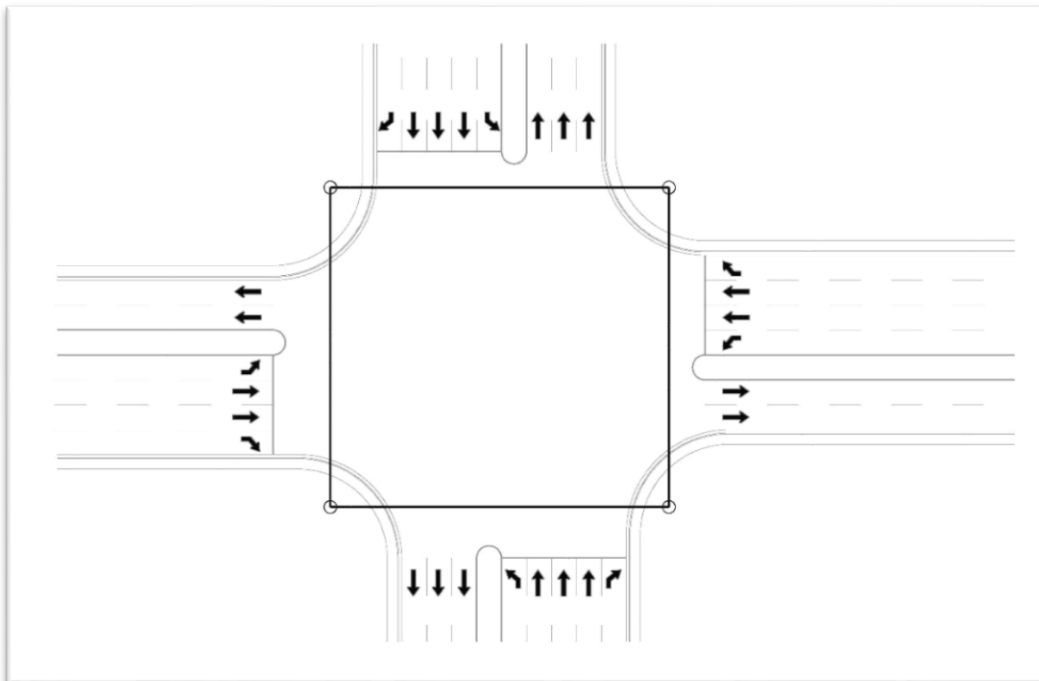

Figure 7 – Box Span Wire Intersection with 0° Skew

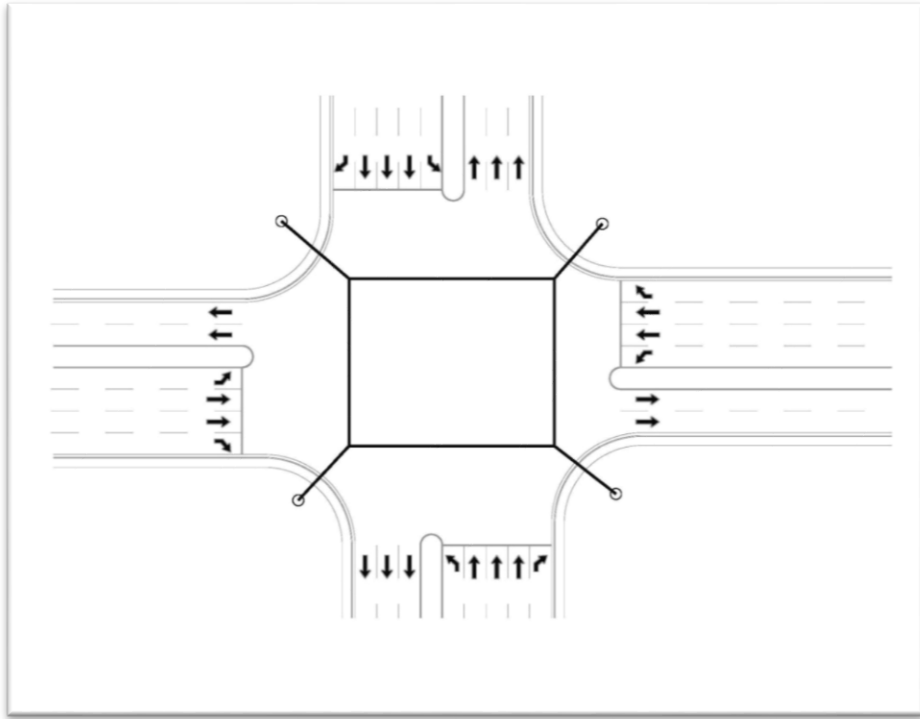

Figure 8 – Hanging Box Span Wire Intersection with 0° Skew

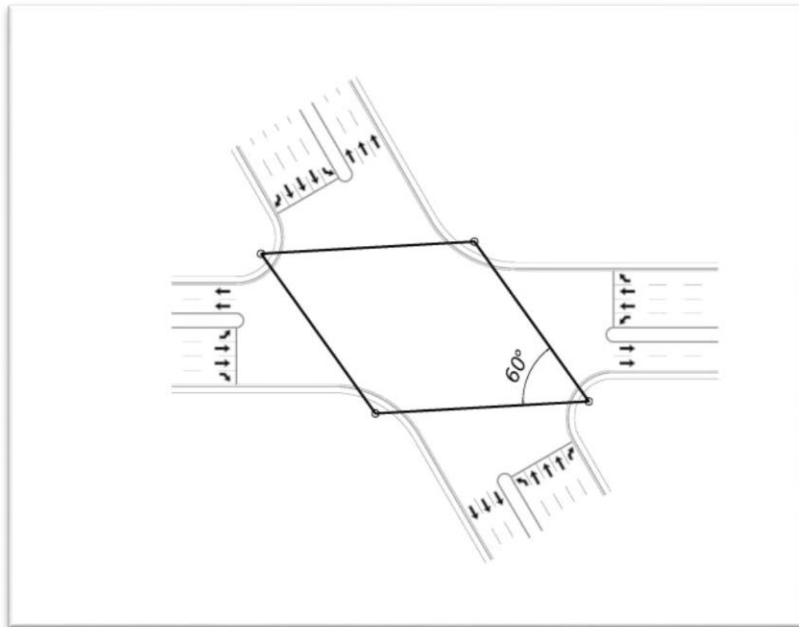

Figure 9 – Box Span Wire Intersection with 30° Skew

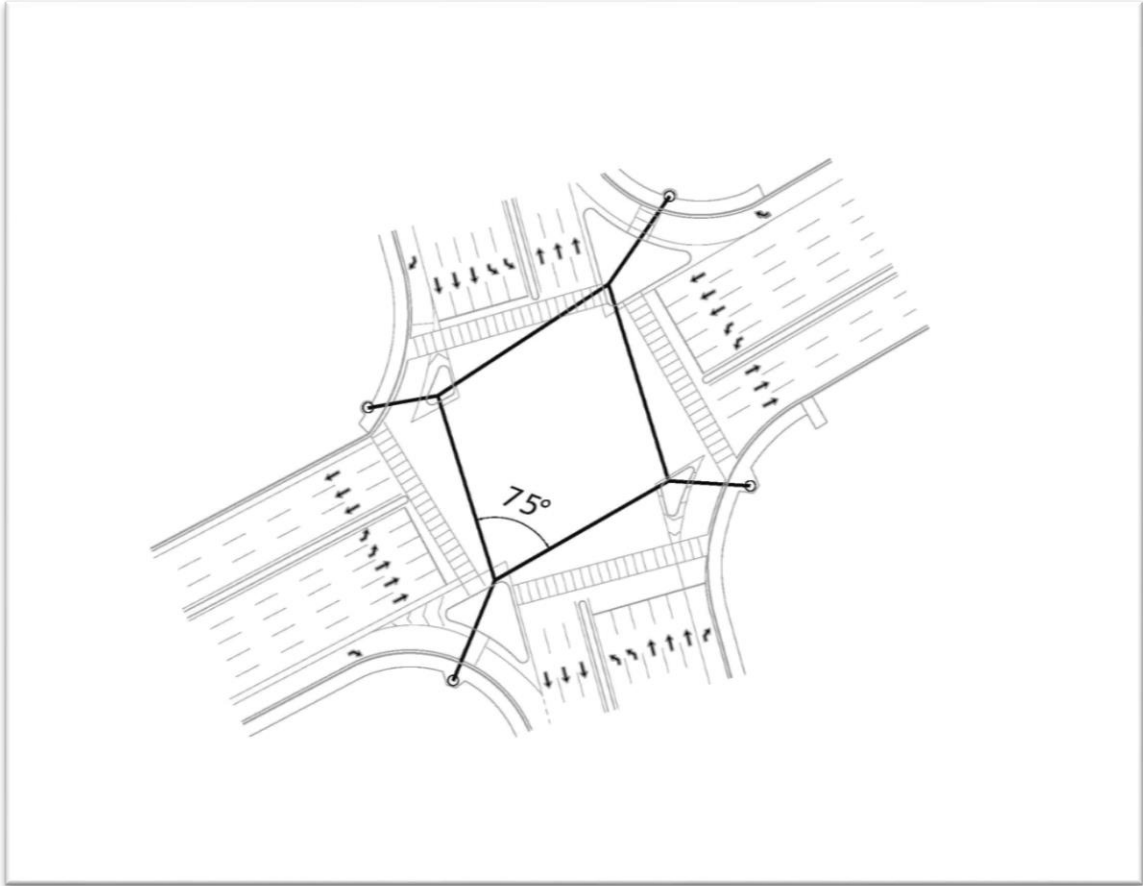

Figure 10 – Hanging Box Span Wire Intersection with 15° Skew

Appendix C – Single Span Wire Study

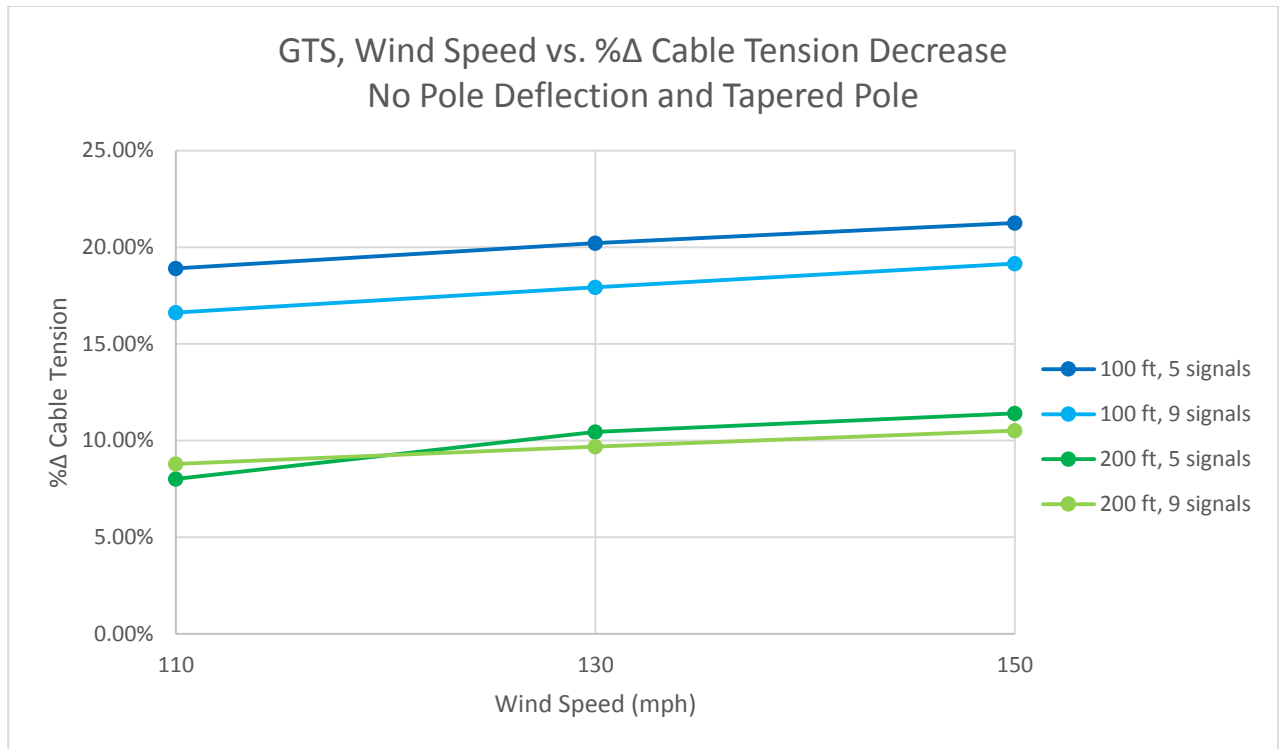

Figure 11 – GTS: Single Span Pole Deflection Study: No Pole Deflection vs. Tapered Pole, 0.7 & 0.4 Coefficients, with Backplates

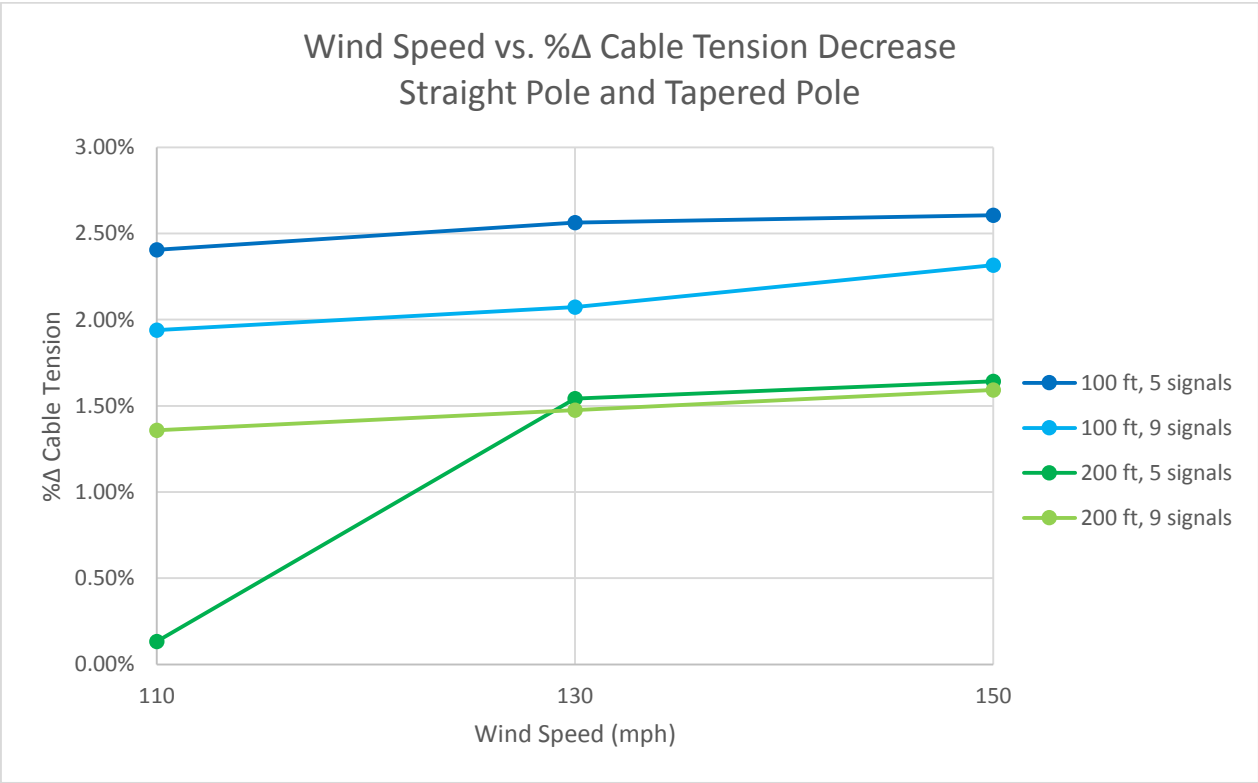

Figure 12 – GTS: Single Span Pole Deflection Study: Straight Pole vs. Tapered Pole, 0.7 & 0.4 Coefficients, with Backplates

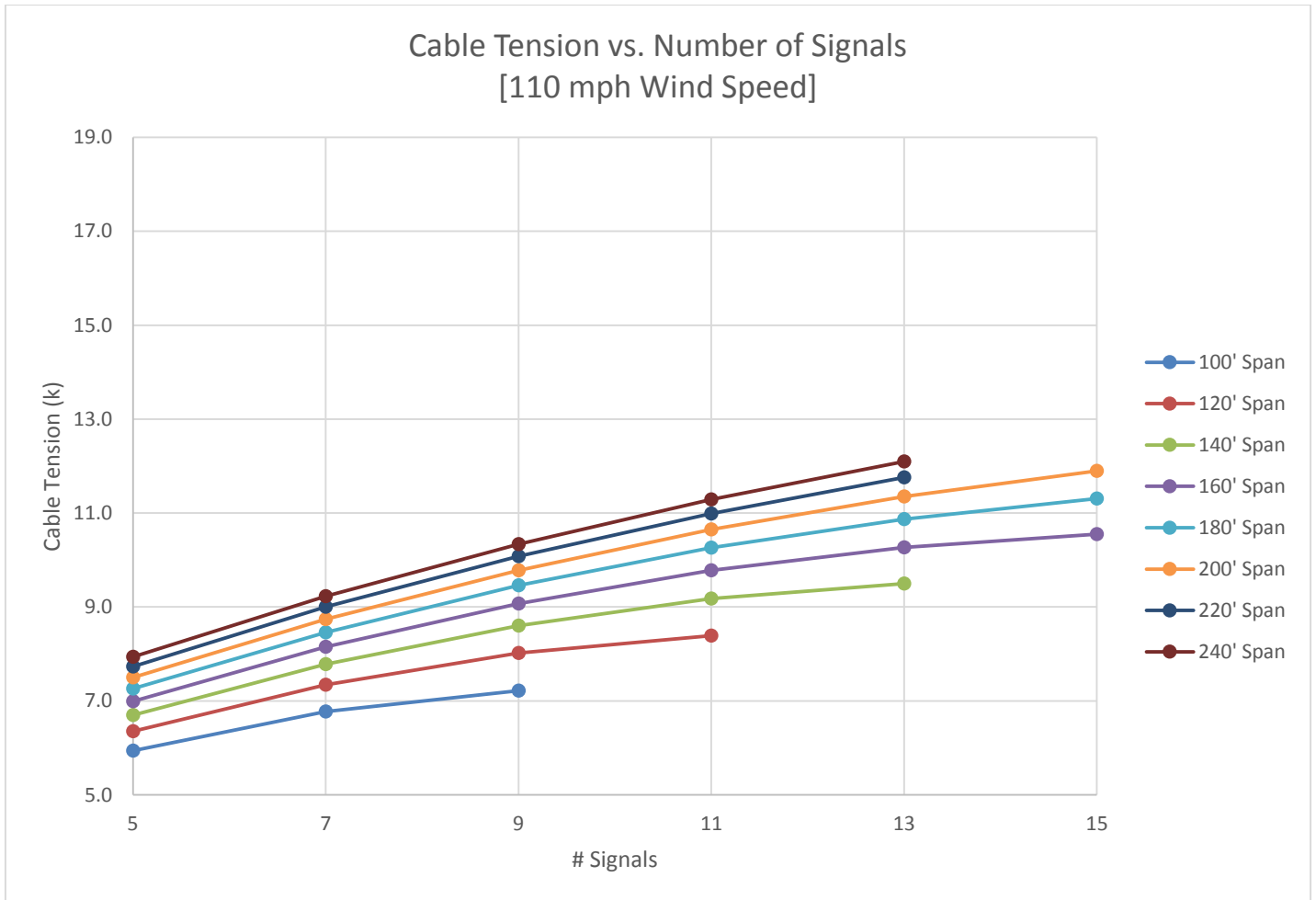

Figure 13 – GTS: 3 Headed Aluminum Signals, 110 mph, with Backplates

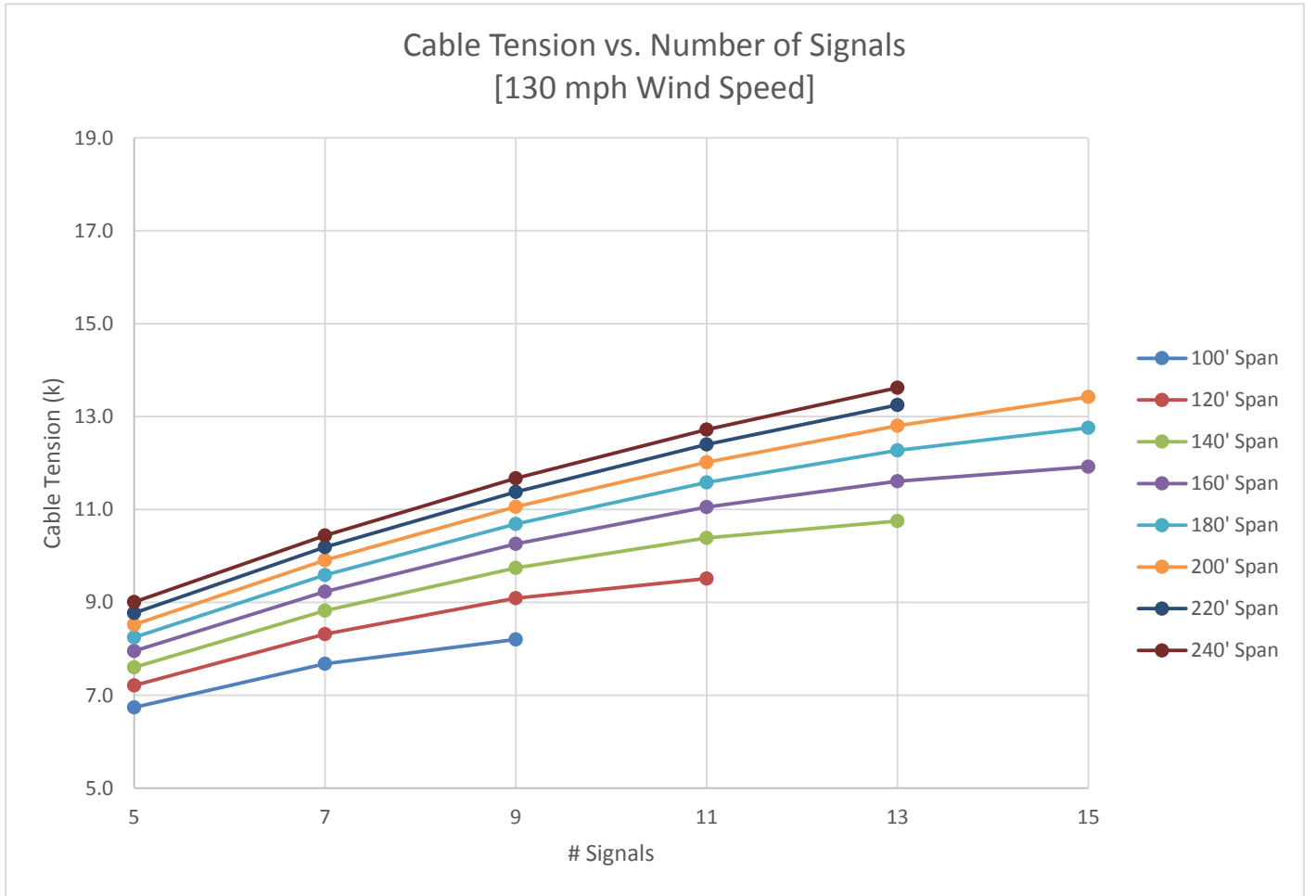

Figure 14 – GTS: 3 Headed Aluminum Signals, 130 mph, with Backplates

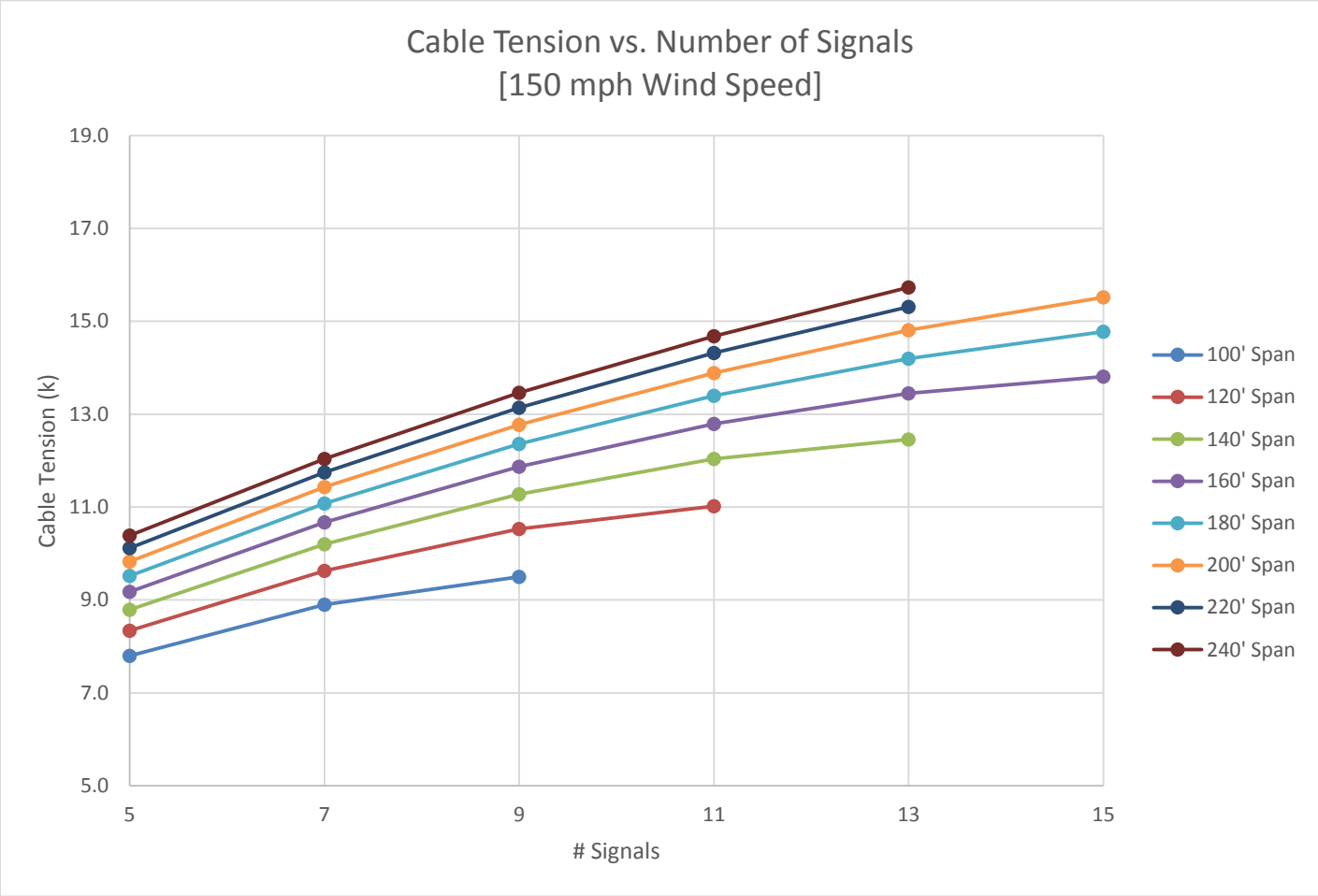

Figure 15 – GTS: 3 Headed Aluminum Signals, 150 mph, with Backplates

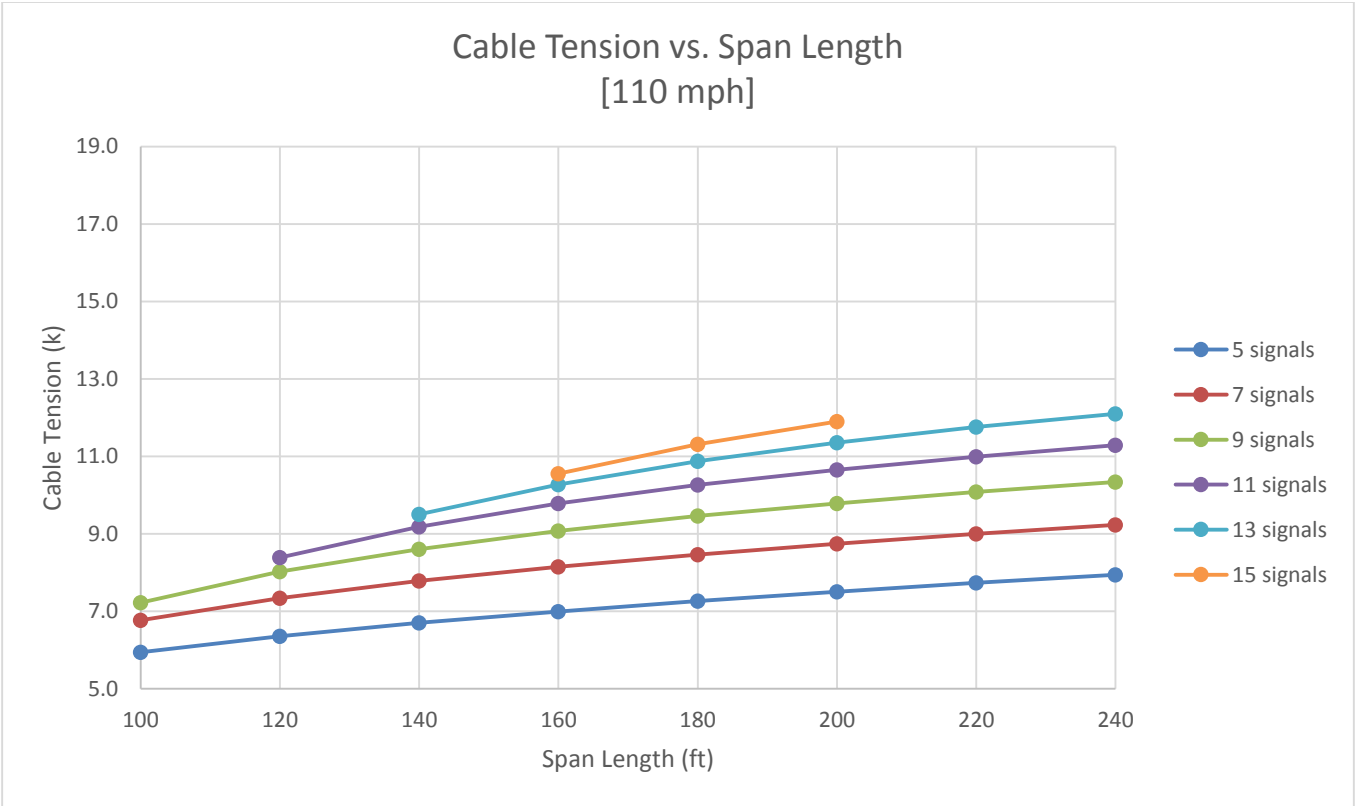

Figure 16 – GTS: 3 Headed Aluminum Signals, 110 mph, with Backplates

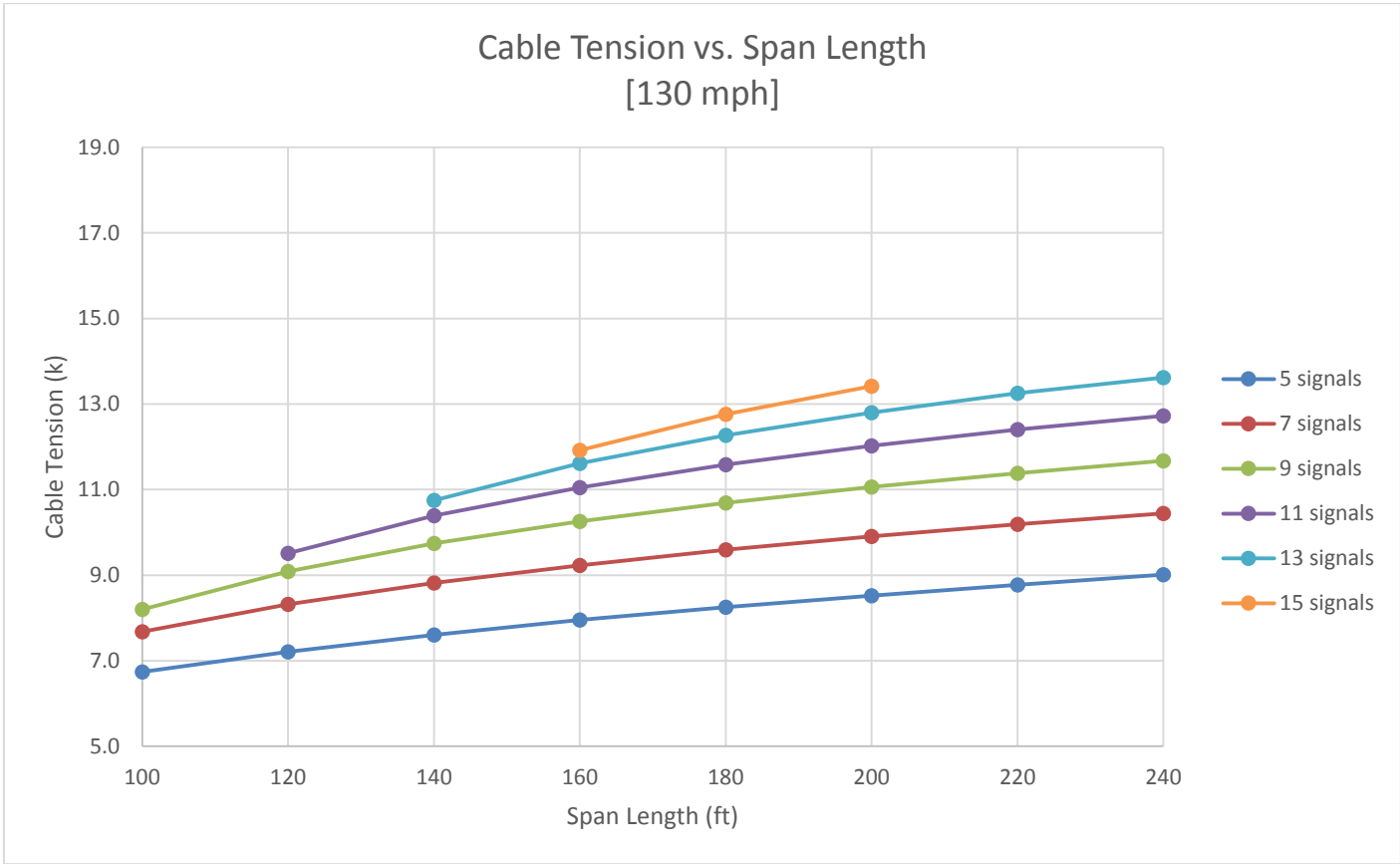

Figure 17 – GTS: 3 Headed Aluminum Signals, 130 mph, with Backplates

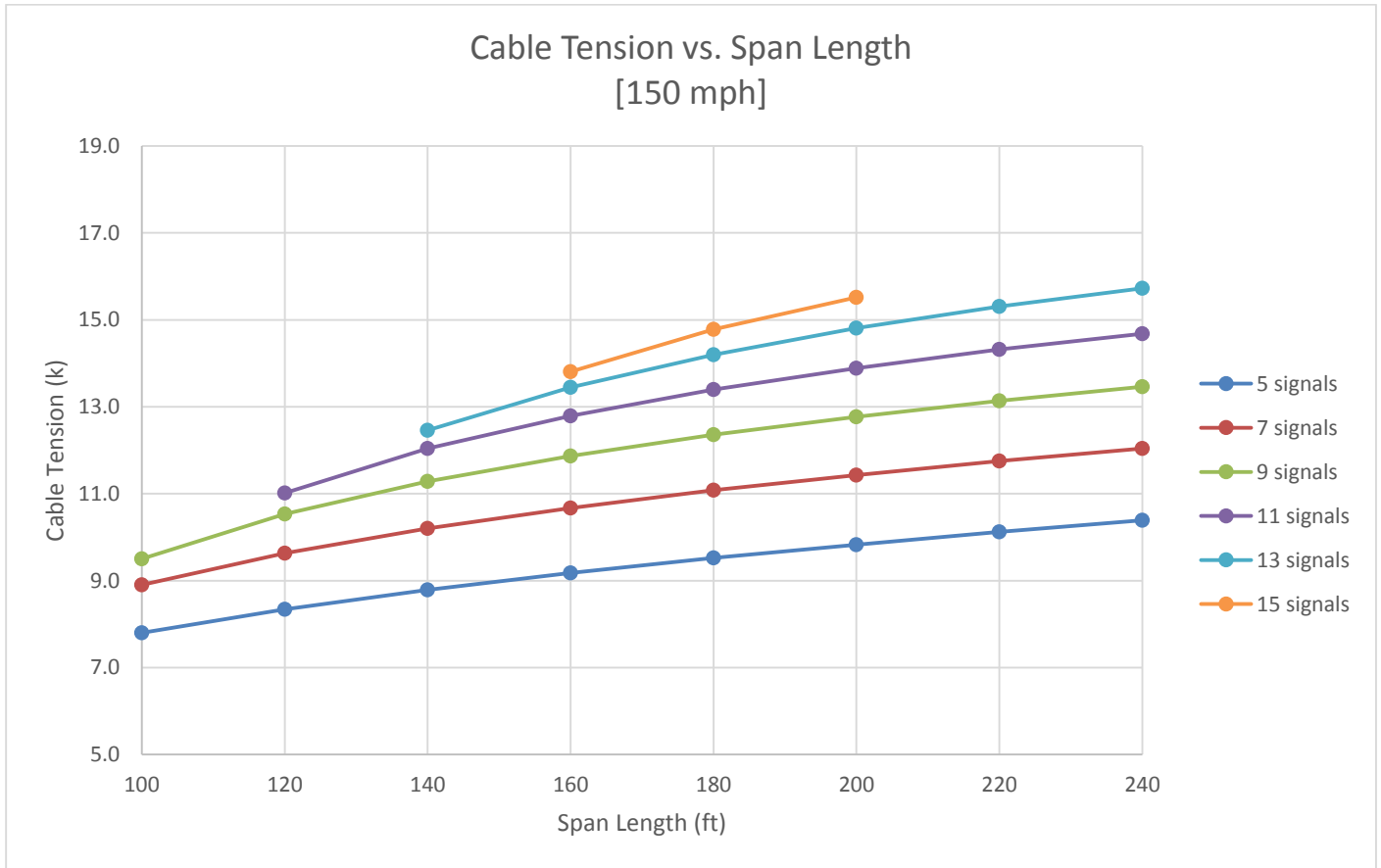

Figure 18 – GTS: 3 Headed Aluminum Signals, 150 mph, with Backplates

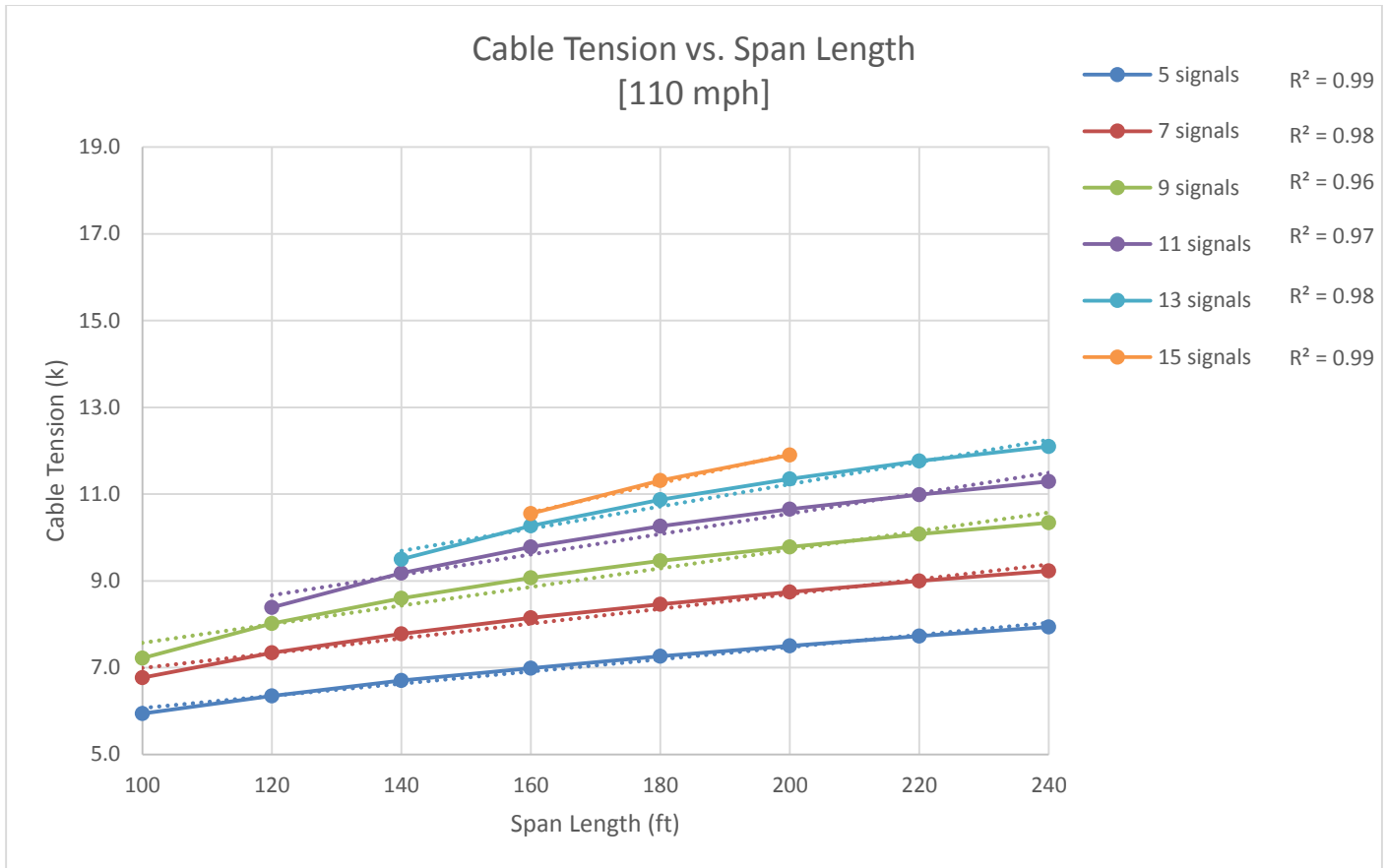

Figure 19 – GTS: 3 Headed Aluminum Signals, 110 mph, with Backplates

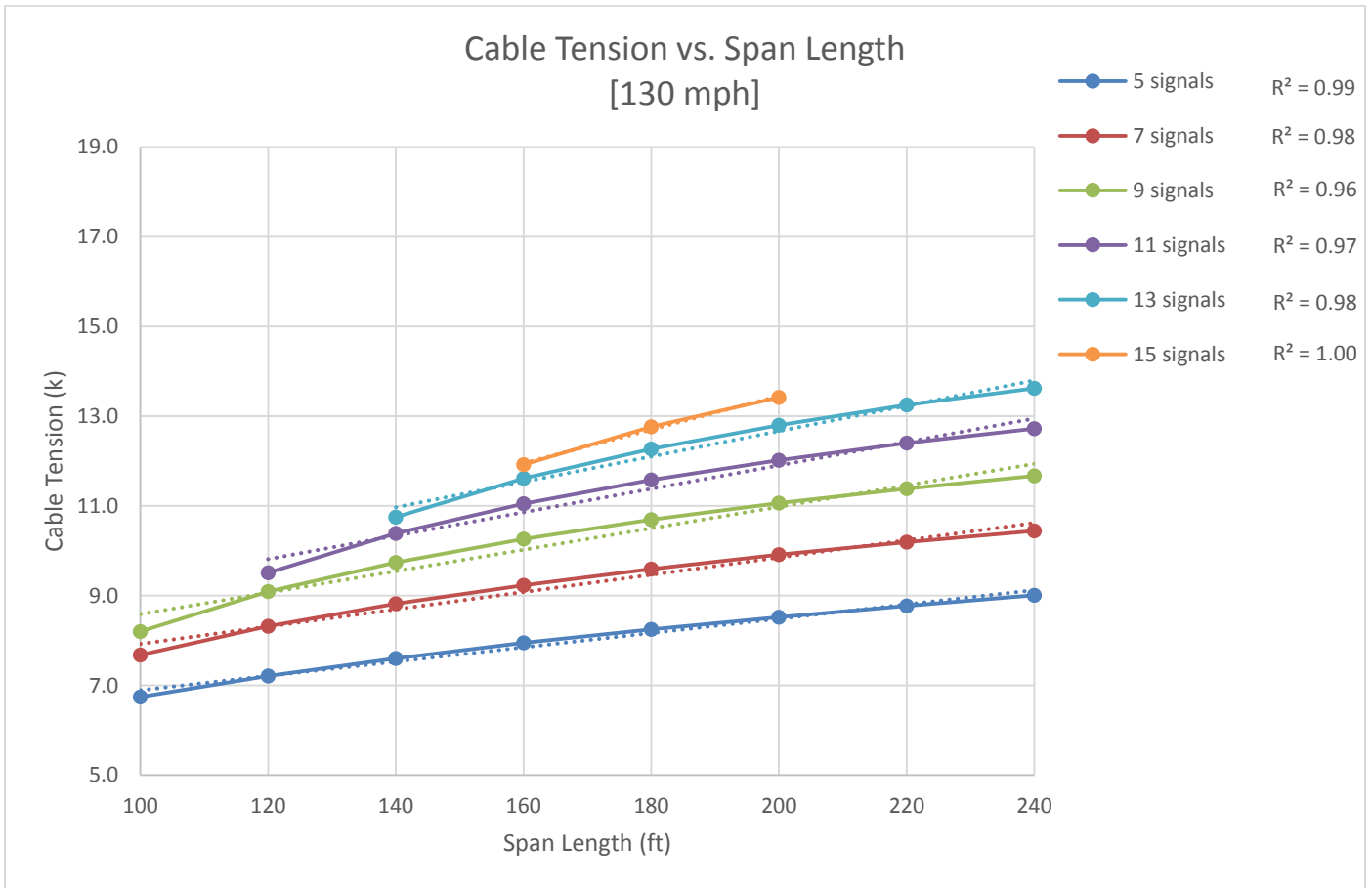

Figure 20 – GTS: 3 Headed Aluminum Signals, 130 mph, with Backplates

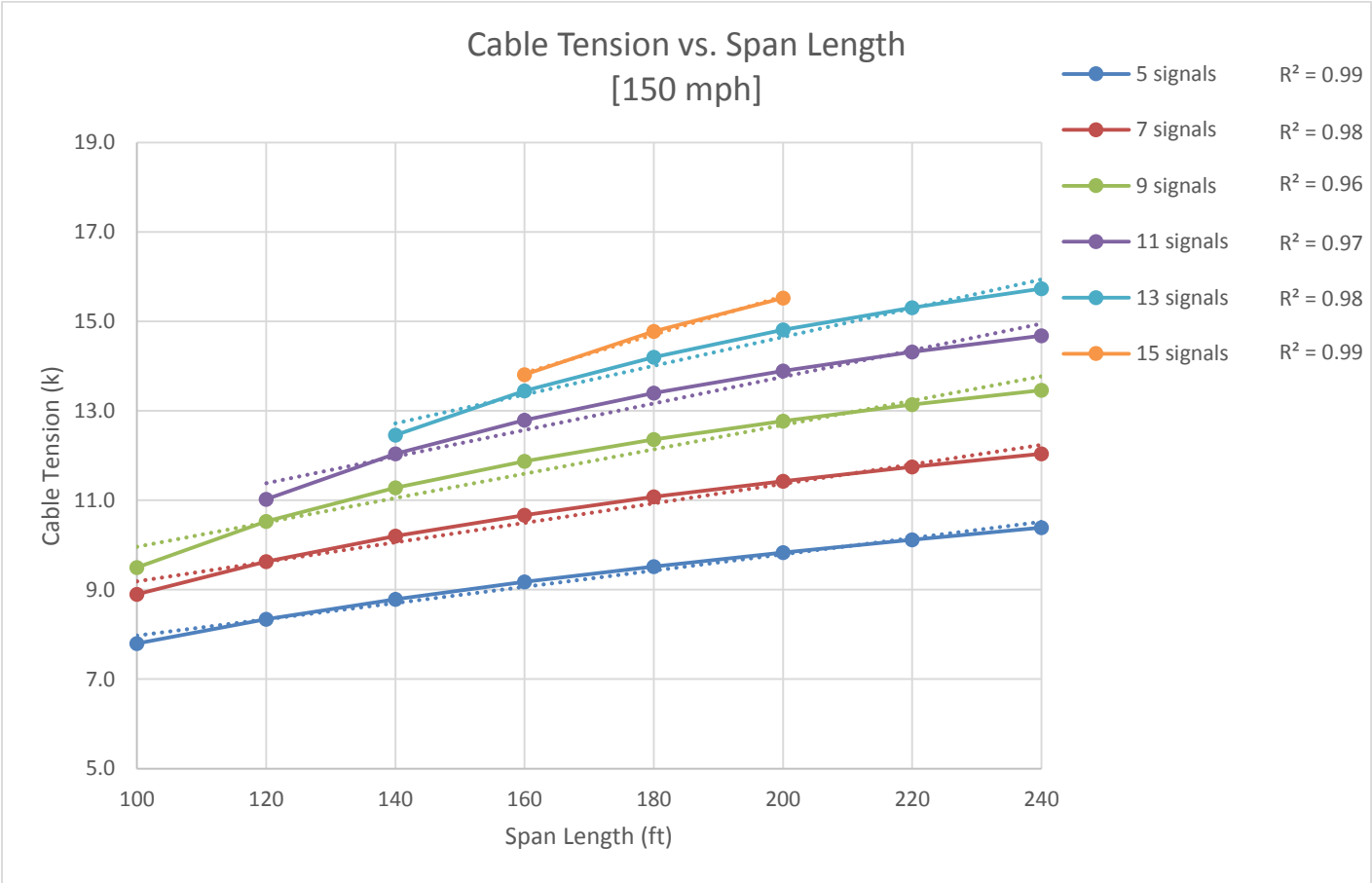

Figure 21 – GTS: 3 Headed Aluminum Signals, 150 mph, with Backplates

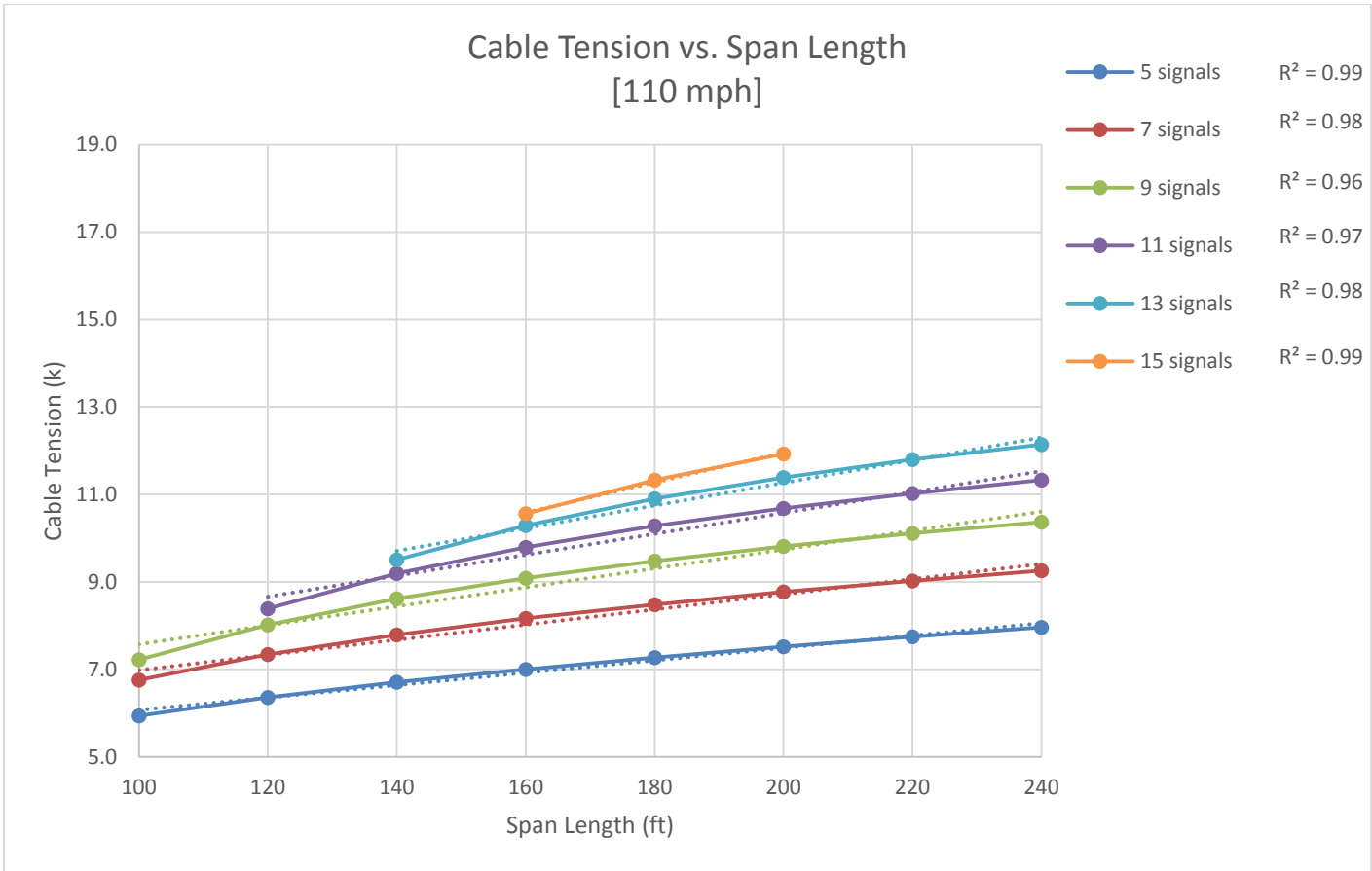

Figure 22 – GTS: 3 Headed Polycarbonate Signals, 110 mph, with Backplates

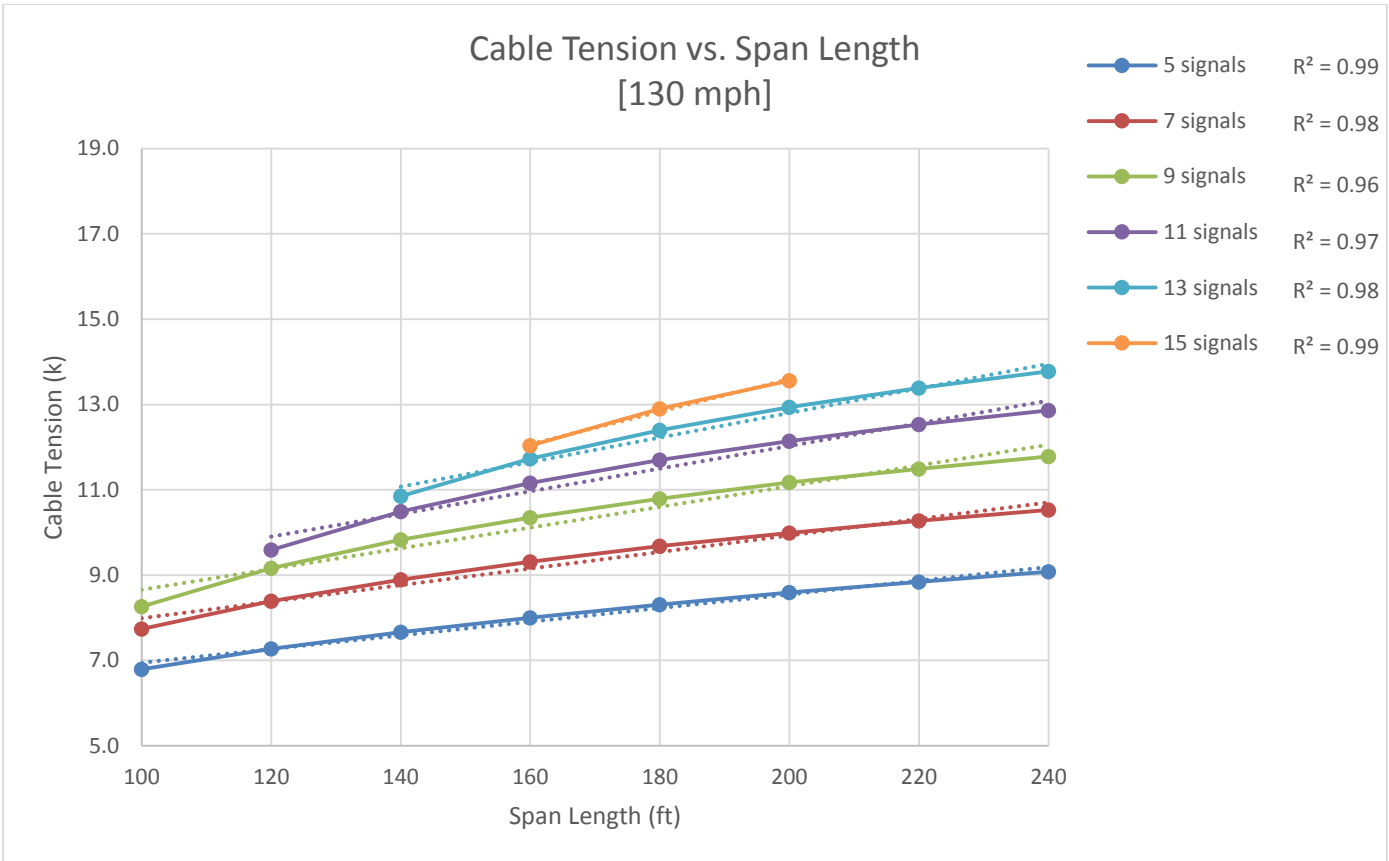

Figure 23 – GTS: 3 Headed Polycarbonate Signals, 130 mph, with Backplates



Figure 24 – GTS: 3 Headed Polycarbonate Signals, 150 mph, with Backplates

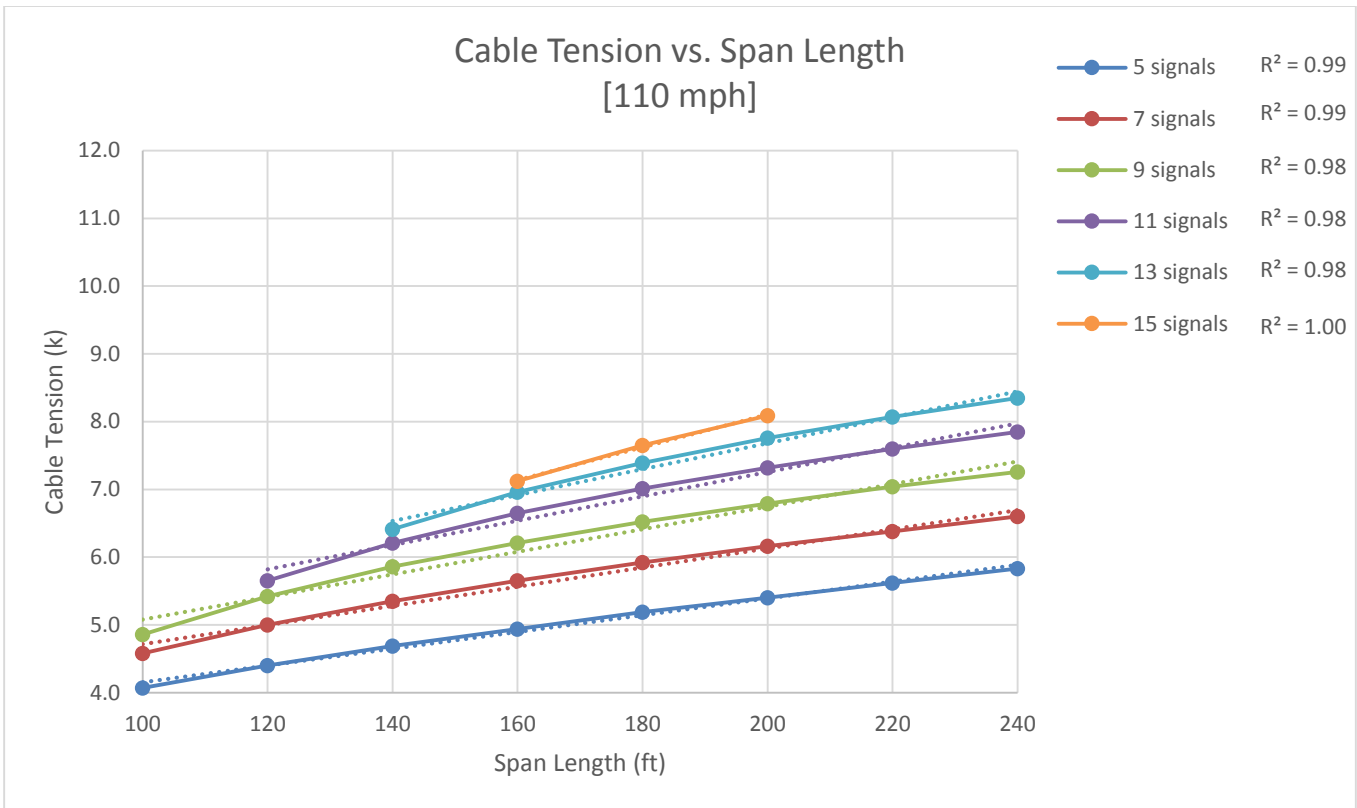

Figure 25 – GTS: 3 Headed Aluminum Signals with No Backplate, 110 mph, with Backplates

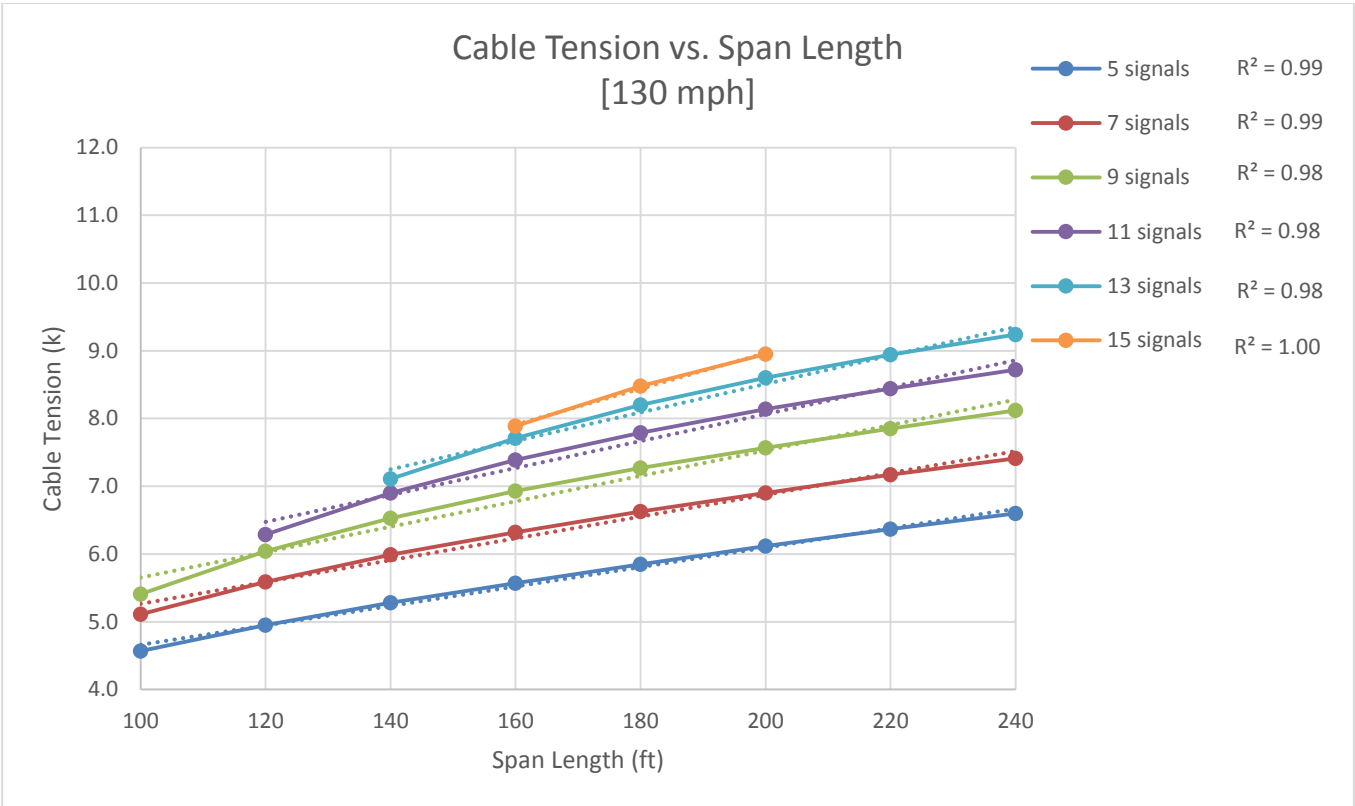

Figure 26 – GTS: 3 Headed Aluminum Signals with No Backplate, 130 mph, with Backplates

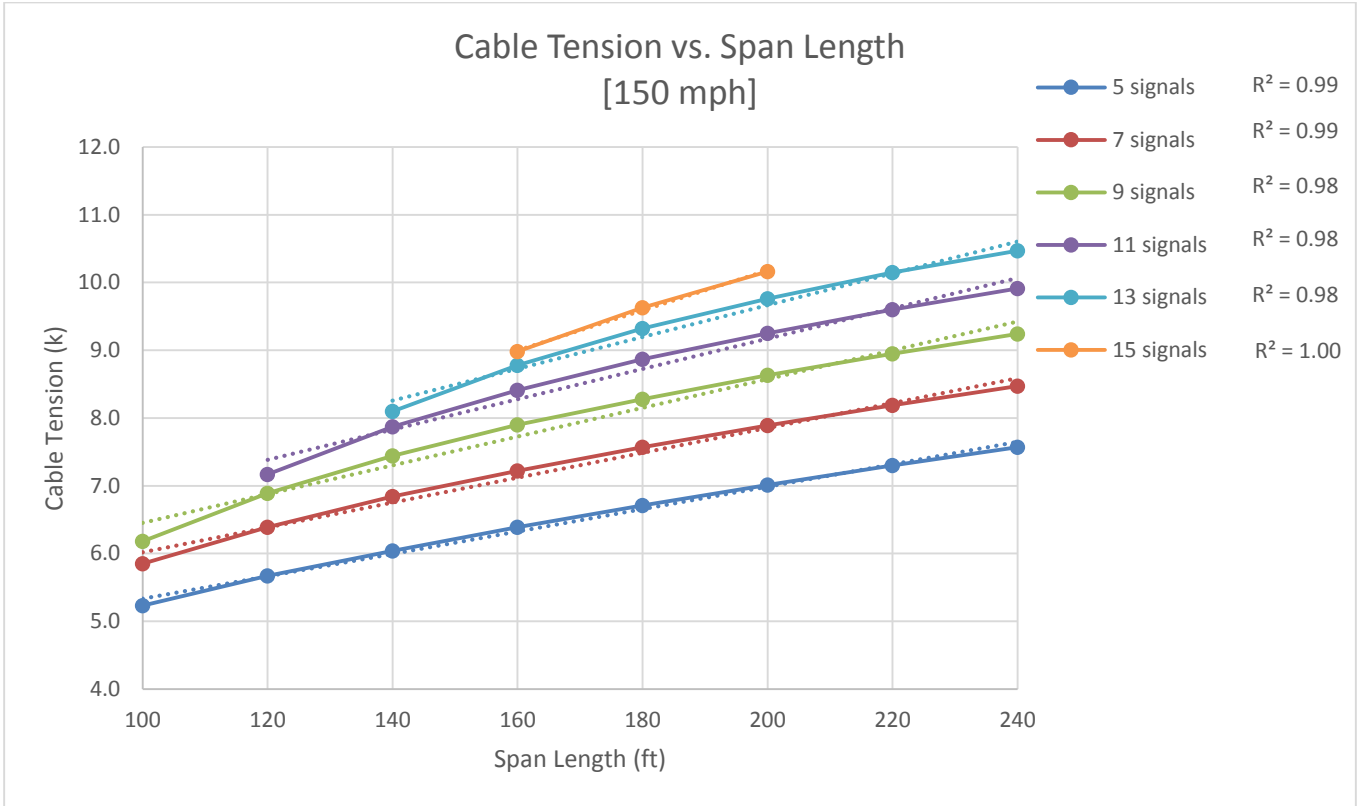

Figure 27 – GTS: 3 Headed Aluminum Signals with No Backplate, 150 mph, with Backplates

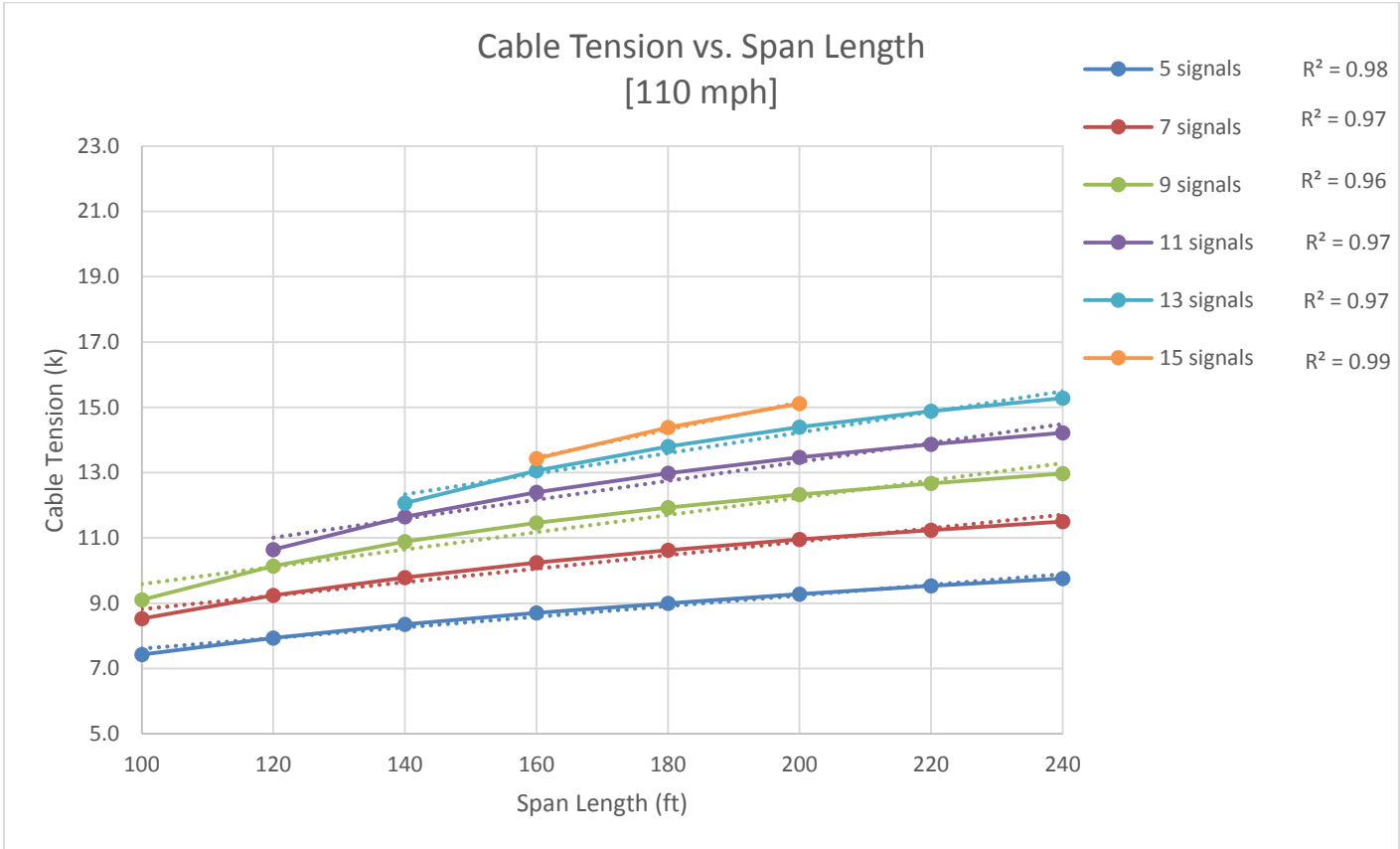

Figure 28 – GTS: 5 Headed Aluminum Signals, 110 mph, with Backplates

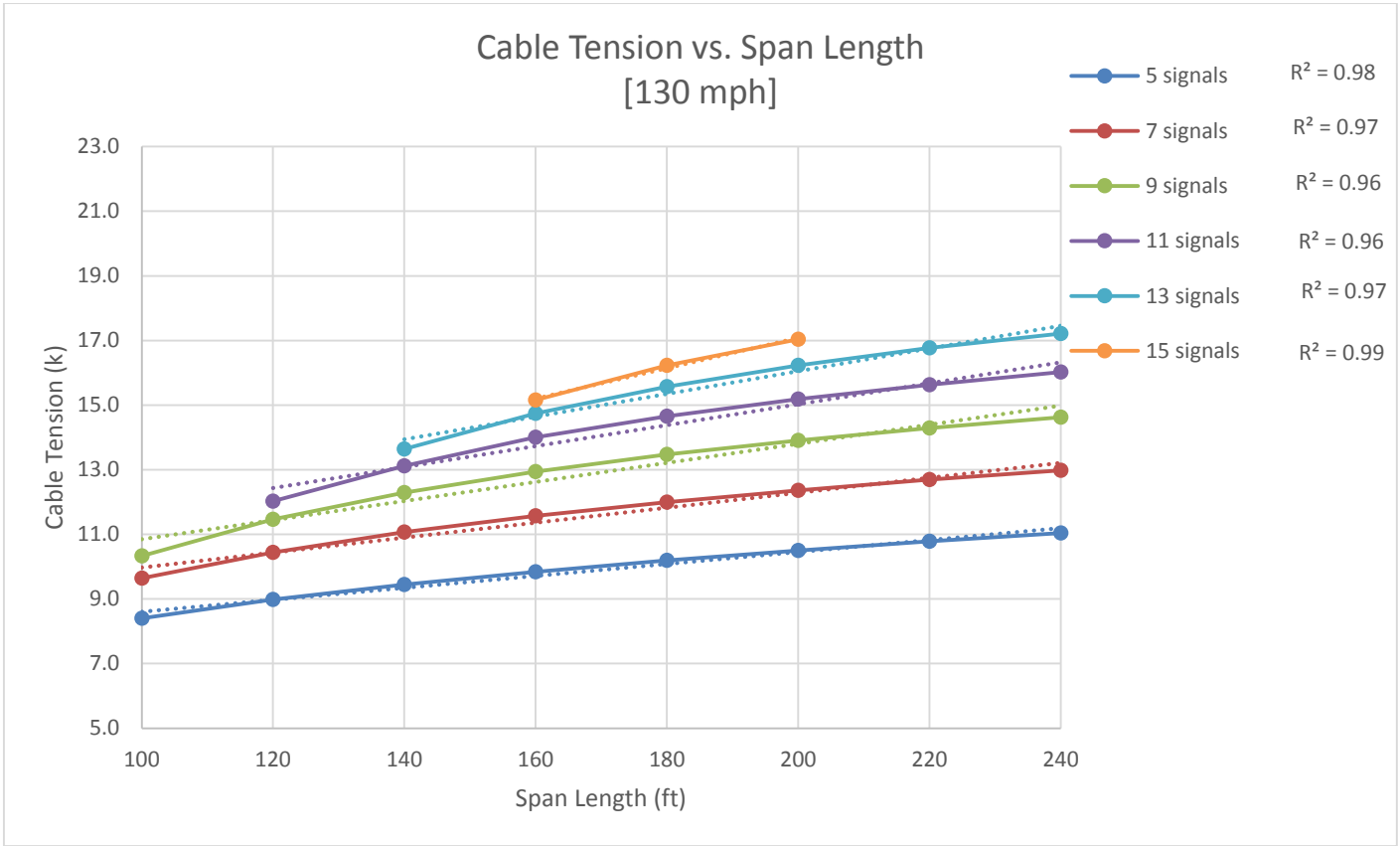

Figure 29 – GTS: 5 Headed Aluminum Signals, 130 mph, with Backplates

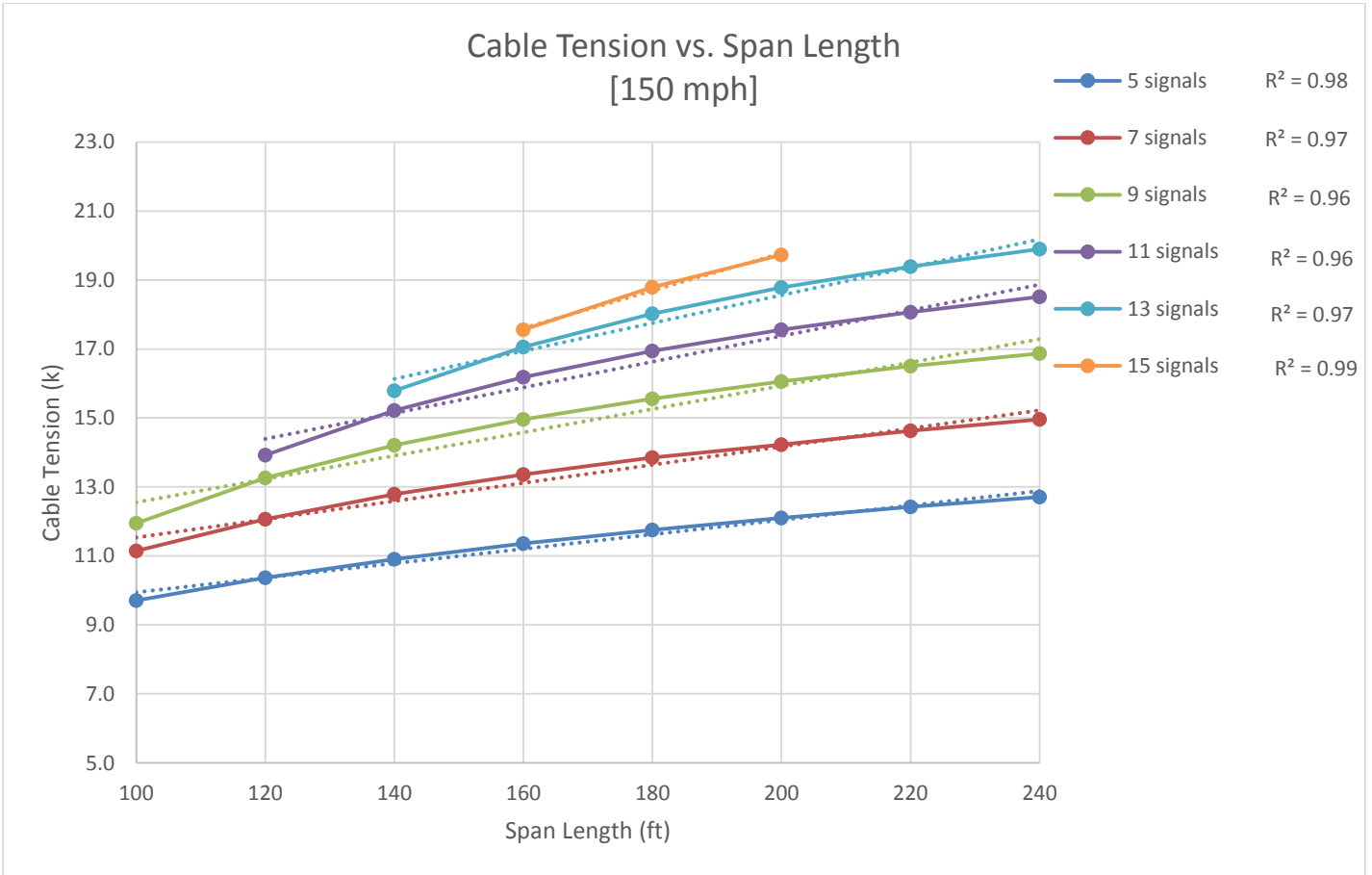

Figure 30 – GTS: 5 Headed Aluminum Signals, 150 mph, with Backplates

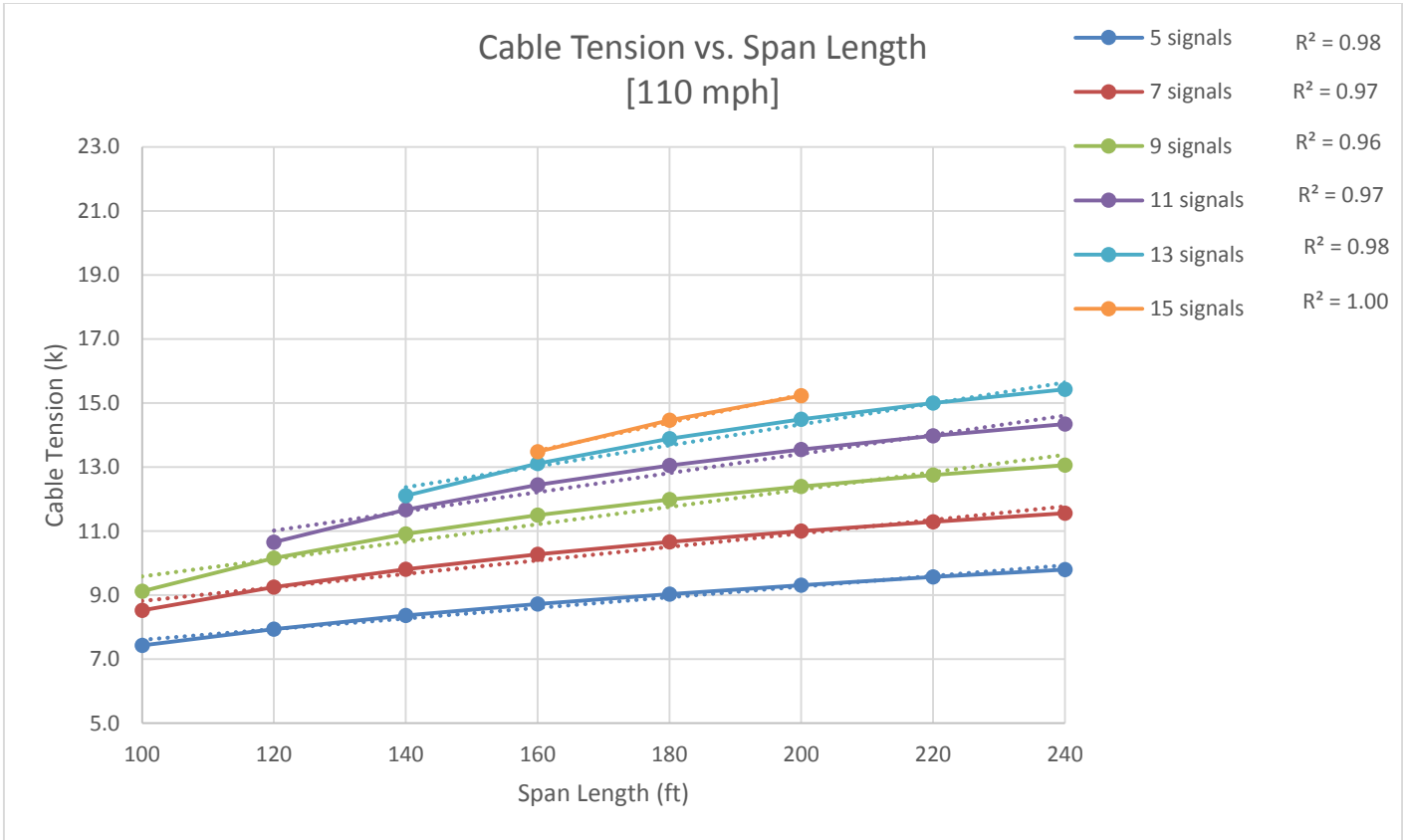

Figure 31 – GTS: 5 Headed Polycarbonate Signals, 110 mph, with Backplates

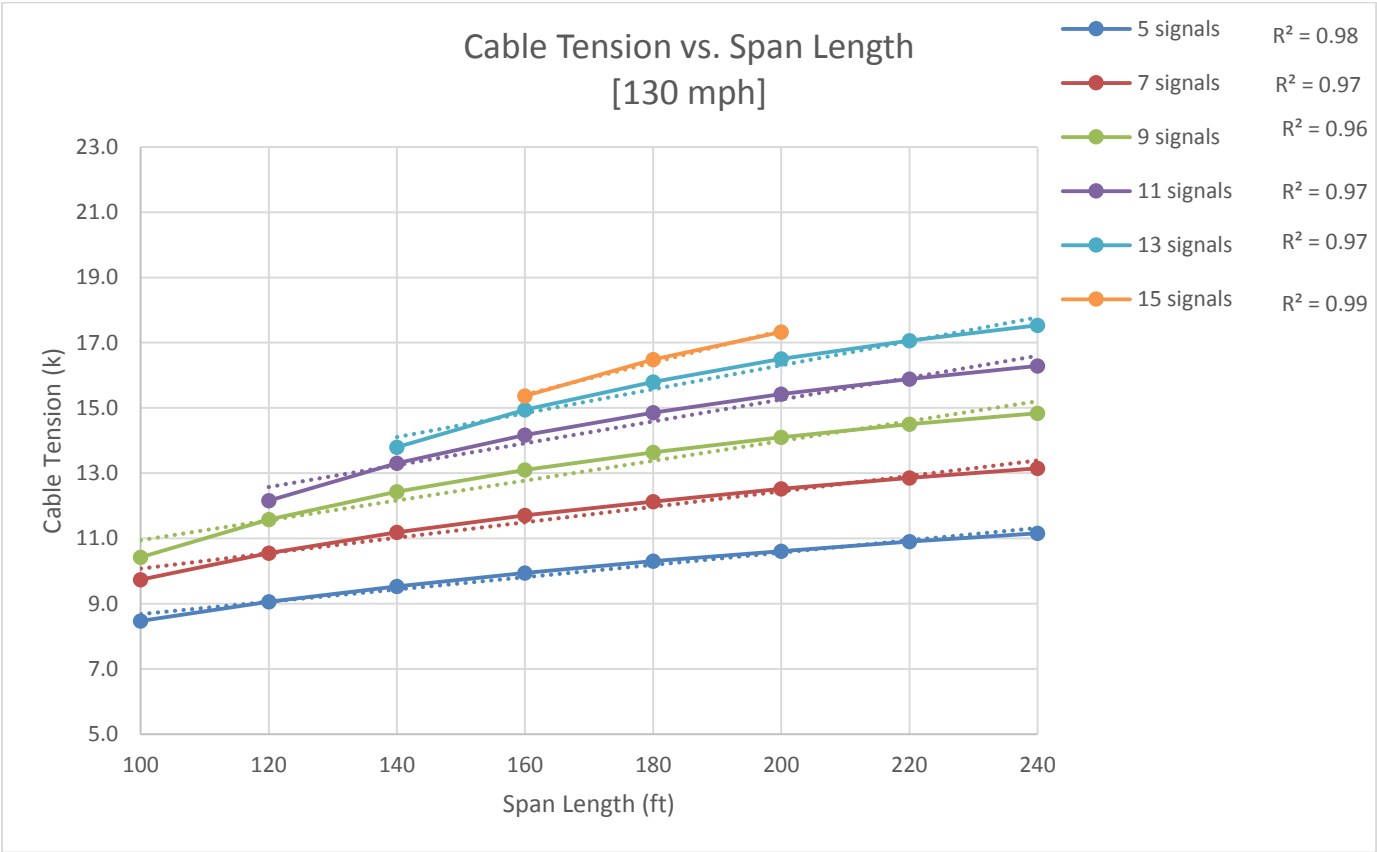

Figure 32 – GTS: 5 Headed Polycarbonate Signals, 130 mph, with Backplates

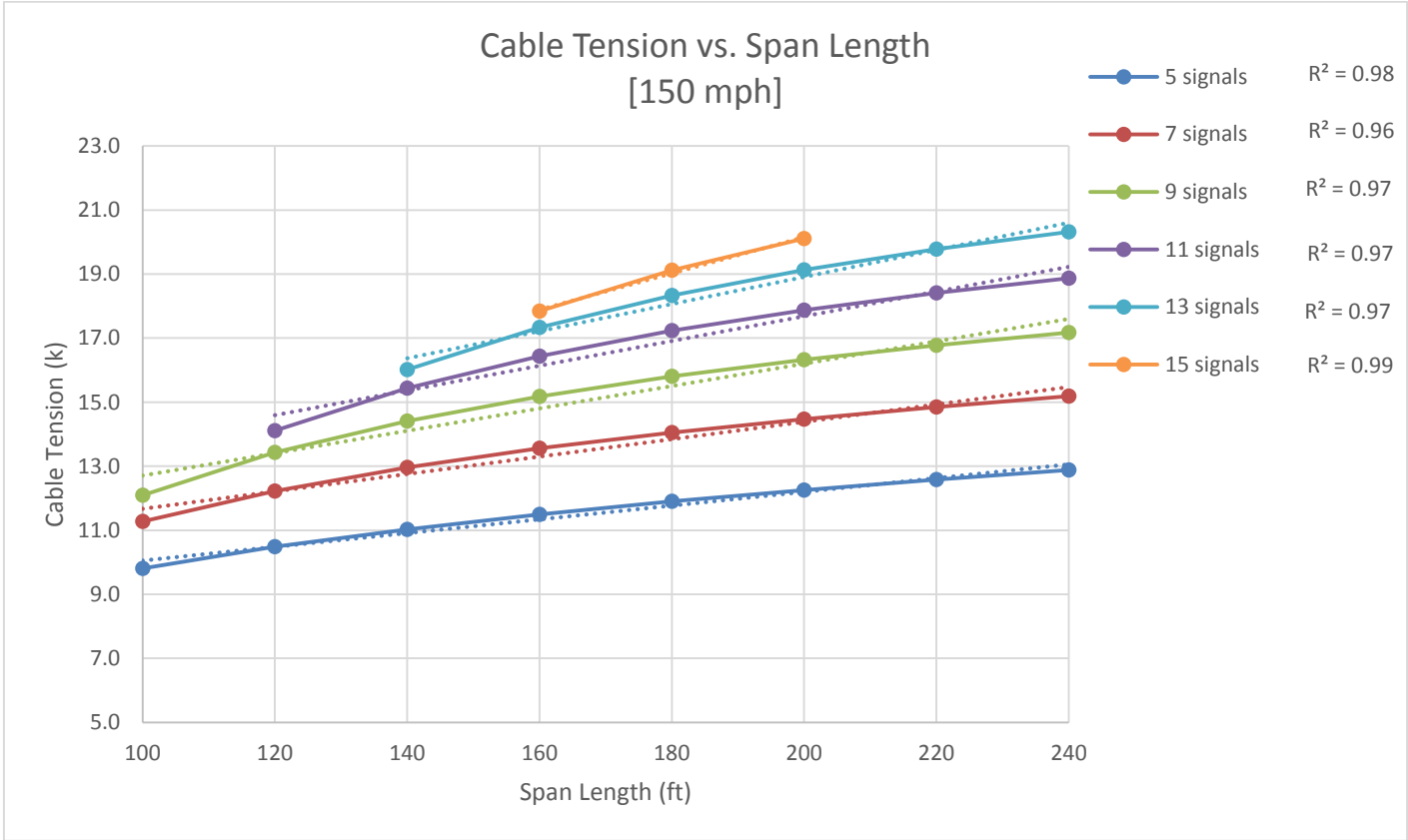

Figure 33 – GTS: 5 Headed Polycarbonate Signals, 150 mph, with Backplates

%Δ 3 Head Signal, Material							
Span	Wind Speed	5 Signals	7 Signals	9 Signals	11 Signals	13 Signals	15 Signals
100ft	110mph	0.0%	-0.1%	0.0%			
	130mph	0.7%	0.8%	0.7%			
	150mph	1.2%	1.0%	1.1%			
120ft	110mph	0.2%	0.0%	0.0%	0.0%		
	130mph	0.8%	0.8%	0.8%	0.8%		
	150mph	1.0%	1.0%	1.0%	1.2%		
140ft	110mph	0.1%	0.1%	0.2%	0.1%	0.1%	
	130mph	0.8%	0.8%	0.9%	1.0%	0.9%	
	150mph	0.9%	1.1%	1.1%	1.2%	1.2%	
160ft	110mph	0.1%	0.2%	0.2%	0.1%	0.2%	0.1%
	130mph	0.6%	0.9%	0.9%	1.0%	1.0%	1.0%
	150mph	0.9%	1.1%	1.1%	1.3%	1.3%	1.3%
180ft	110mph	0.1%	0.2%	0.2%	0.2%	0.3%	0.2%
	130mph	0.7%	0.9%	0.9%	1.0%	1.1%	1.1%
	150mph	0.9%	1.1%	1.1%	1.2%	1.3%	1.3%
200ft	110mph	0.3%	0.3%	0.3%	0.3%	0.4%	0.3%
	130mph	0.8%	0.8%	1.0%	1.0%	1.1%	1.0%
	150mph	1.0%	1.1%	1.3%	1.3%	1.3%	1.4%
220ft	110mph	0.3%	0.2%	0.3%	0.3%	0.3%	
	130mph	0.8%	0.8%	1.0%	1.0%	1.1%	
	150mph	1.0%	1.1%	1.2%	1.3%	1.4%	
240ft	110mph	0.3%	0.3%	0.3%	0.4%	0.3%	
	130mph	0.8%	0.9%	0.9%	1.1%	1.2%	
	150mph	0.9%	1.1%	1.2%	1.4%	1.4%	

Table 1 – GTS: Percent Change in Cable Tension between 3 Headed Aluminum and Polycarbonate Signal Heads, with Backplates

%Δ 5 Head Signal, Material							
Span	Wind Speed	5 Signals	7 Signals	9 Signals	11 Signals	13 Signals	15 Signals
100ft	110mph	0.0%	-0.1%	0.2%			
	130mph	0.8%	0.9%	0.9%			
	150mph	1.0%	1.2%	1.2%			
120ft	110mph	0.1%	0.1%	0.1%	0.1%		
	130mph	0.9%	1.1%	1.0%	1.1%		
	150mph	1.2%	1.2%	1.3%	1.4%		
140ft	110mph	0.1%	0.2%	0.2%	0.2%	0.2%	
	130mph	0.8%	1.1%	1.1%	1.4%	1.2%	
	150mph	1.1%	1.3%	1.4%	1.4%	1.5%	
160ft	110mph	0.2%	0.3%	0.3%	0.3%	0.4%	0.4%
	130mph	1.0%	1.2%	1.2%	1.2%	1.4%	1.4%
	150mph	1.2%	1.5%	1.5%	1.6%	1.6%	1.6%
180ft	110mph	0.3%	0.4%	0.4%	0.5%	0.6%	0.6%
	130mph	1.1%	1.1%	1.3%	1.4%	1.5%	1.5%
	150mph	1.3%	1.4%	1.6%	1.7%	1.7%	1.8%
200ft	110mph	0.3%	0.5%	0.5%	0.6%	0.7%	0.7%
	130mph	1.0%	1.3%	1.4%	1.5%	1.7%	1.7%
	150mph	1.2%	1.7%	1.7%	1.8%	1.9%	1.9%
220ft	110mph	0.4%	0.4%	0.6%	0.7%	0.8%	
	130mph	1.0%	1.3%	1.5%	1.7%	1.7%	
	150mph	1.3%	1.5%	1.7%	1.9%	2.0%	
240ft	110mph	0.4%	0.5%	0.7%	0.8%	1.0%	
	130mph	1.1%	1.3%	1.5%	1.7%	1.9%	
	150mph	1.3%	1.5%	1.8%	1.9%	2.1%	

Table 2 – GTS: Percent Change in Cable Tension between 5 Headed Aluminum and Polycarbonate Signal Heads, with Backplates

%Δ 3 Head Aluminum							
Span	Wind Speed	5 Signals	7 Signals	9 Signals	11 Signals	13 Signals	15 Signals
100ft	110mph	45.9%	47.8%	48.6%			
	130mph	47.5%	50.3%	51.6%			
	150mph	49.1%	52.1%	53.7%			
120ft	110mph	44.3%	46.8%	48.0%	48.5%		
	130mph	45.7%	48.8%	50.5%	51.2%		
	150mph	47.1%	50.7%	52.8%	53.7%		
140ft	110mph	42.9%	45.4%	46.8%	47.8%	48.2%	
	130mph	43.9%	47.2%	49.2%	50.6%	51.2%	
	150mph	45.5%	49.1%	51.6%	53.0%	53.8%	
160ft	110mph	41.5%	44.2%	46.1%	47.1%	47.6%	48.2%
	130mph	42.7%	46.0%	48.1%	49.5%	50.6%	51.1%
	150mph	43.7%	47.8%	50.3%	52.1%	53.2%	53.8%
180ft	110mph	39.9%	42.9%	45.1%	46.4%	47.1%	47.8%
	130mph	41.0%	44.6%	47.0%	48.7%	49.6%	50.5%
	150mph	41.9%	46.4%	49.3%	51.1%	52.4%	53.5%
200ft	110mph	38.9%	41.9%	44.0%	45.5%	46.3%	47.1%
	130mph	39.2%	43.6%	46.1%	47.7%	48.8%	49.9%
	150mph	40.2%	44.9%	48.0%	50.2%	51.7%	52.8%
220ft	110mph	37.5%	41.1%	43.2%	44.6%	45.7%	
	130mph	37.7%	42.1%	45.0%	46.9%	48.2%	
	150mph	38.6%	43.5%	46.8%	49.2%	50.8%	
240ft	110mph	36.2%	39.8%	42.4%	43.8%	44.9%	
	130mph	36.5%	40.9%	43.7%	45.9%	47.4%	
	150mph	37.3%	42.1%	45.7%	48.1%	50.2%	

Table 3 – GTS: Percent Change in Cable Tension between 3 Headed Aluminum Signals with and without Backplates, with Backplates

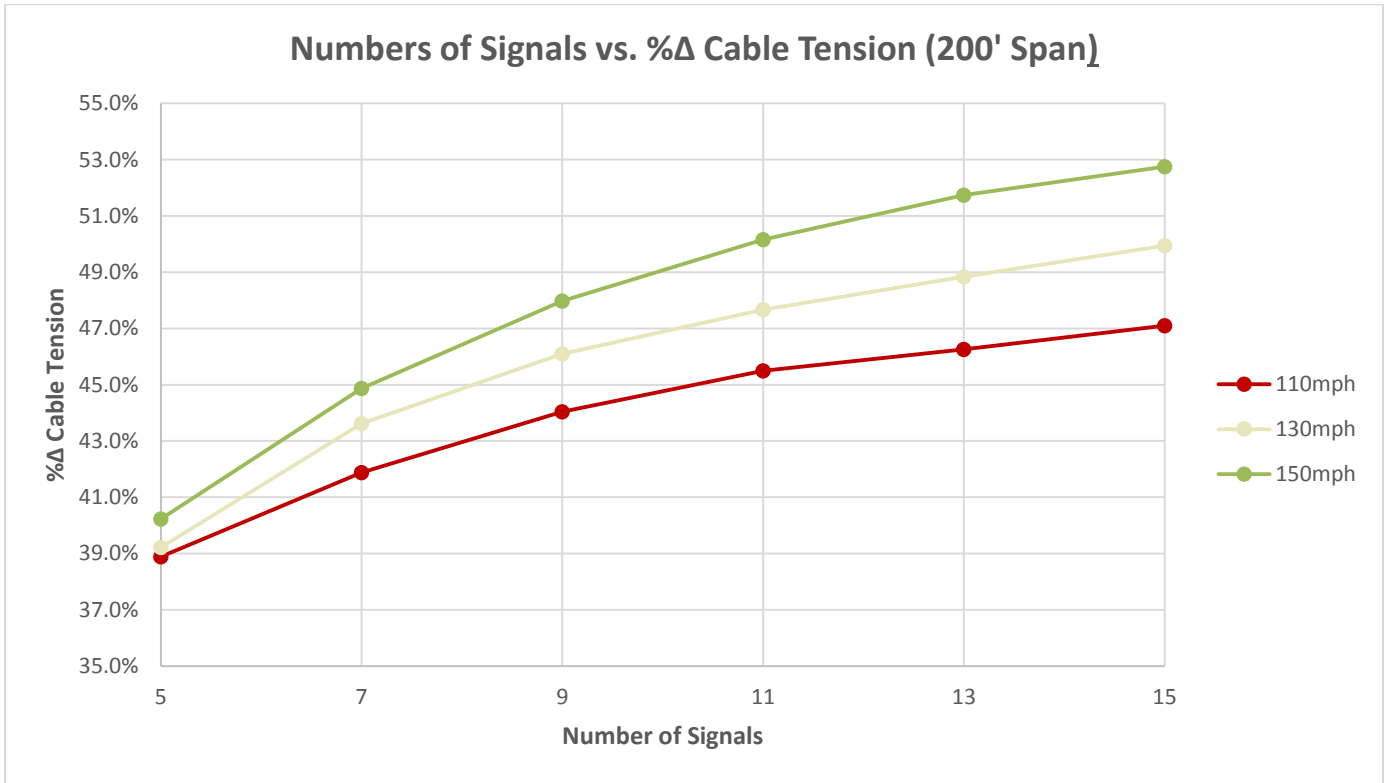

Figure 34 – GTS: Percent Change in Cable Tension between 3 Headed Aluminum Signals with and without Backplates

Cable Tension vs. Number of Signals [110 mph Wind Speed, Default Coefficient Values]

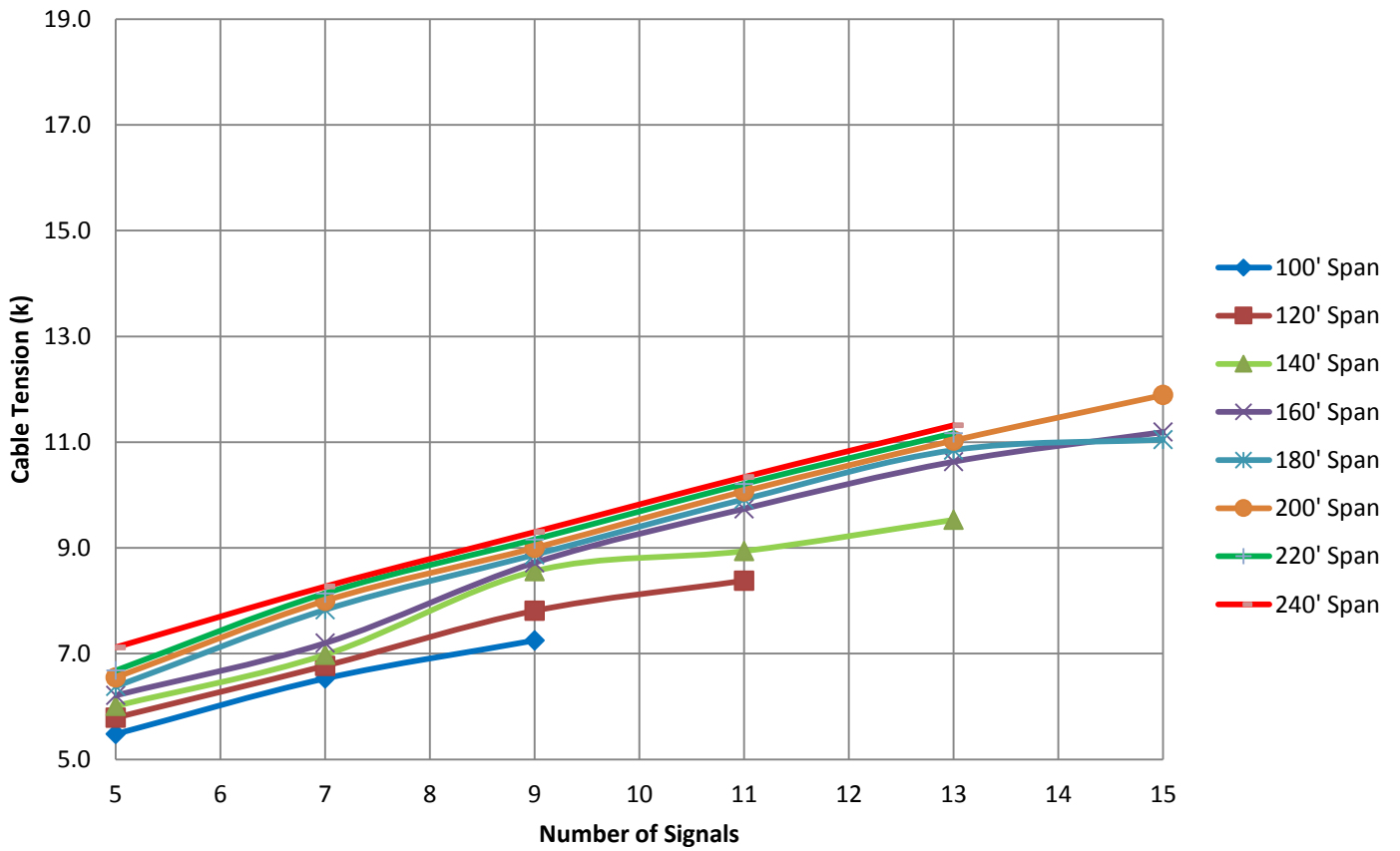

Figure 35 – ATLAS: 3 Headed Aluminum Signals, 110 mph, with Backplates

Cable Tension vs. Number of Signals [130 mph Wind Speed, Default Coefficient Values]

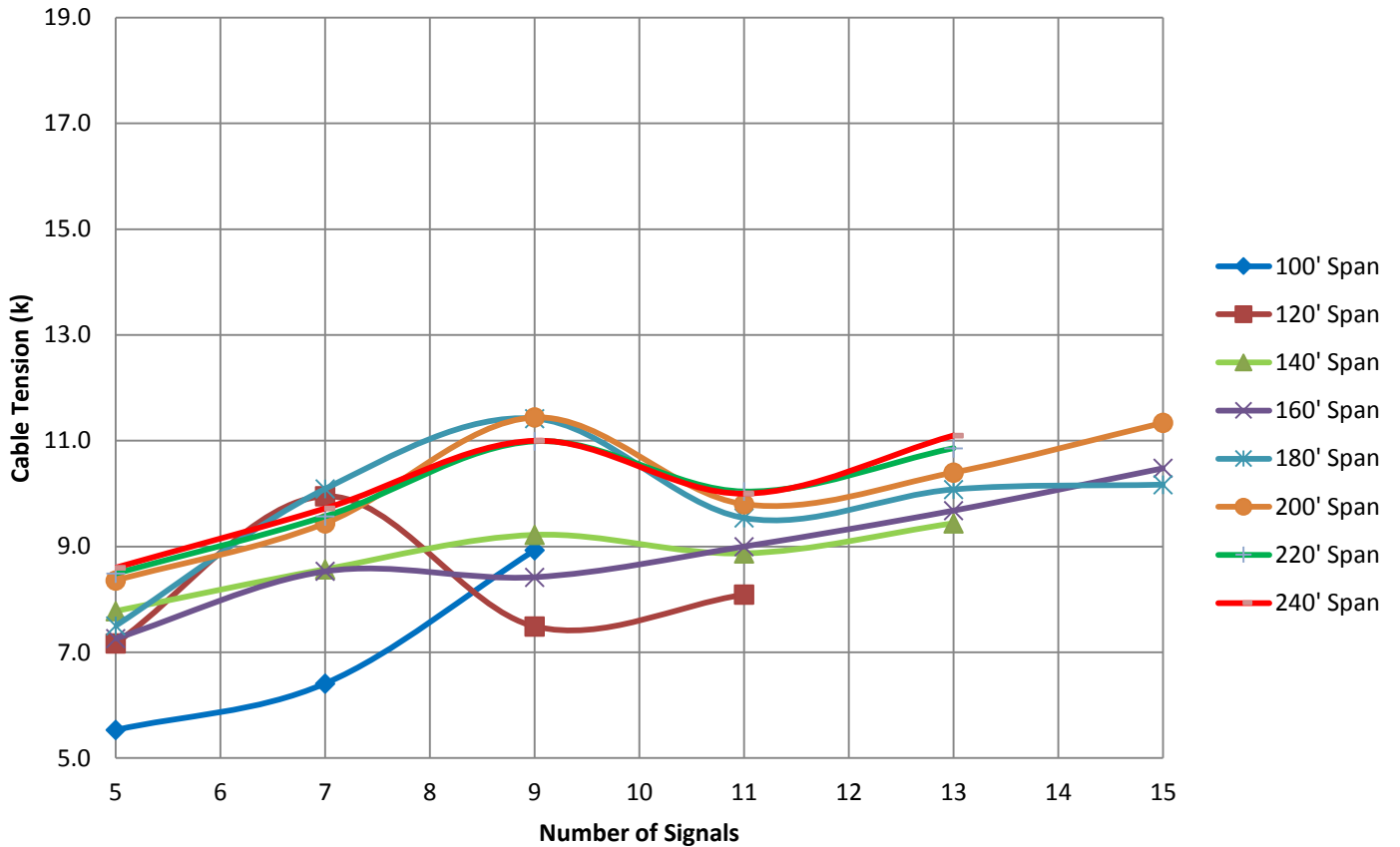

Figure 36 – ATLAS: 3 Headed Aluminum Signals, 130 mph, with Backplates

Cable Tension vs. Number of Signals [150 mph Wind Speed, Default Coefficient Values]

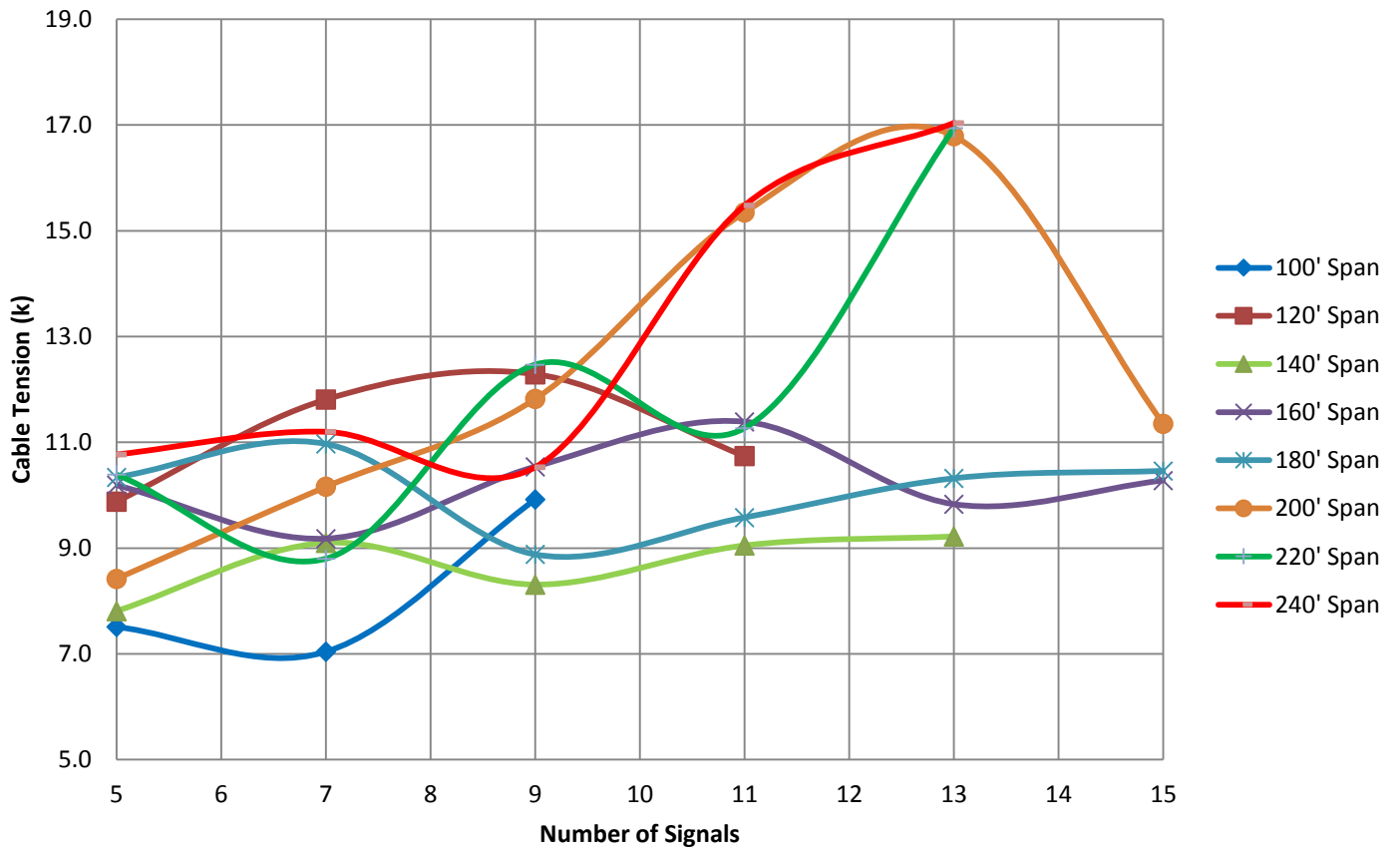

Figure 37 – ATLAS: 3 Headed Aluminum Signals, 150 mph, with Backplates

Cable Tension vs. Span Length [110 mph Wind Speed, Default Coefficient Values]

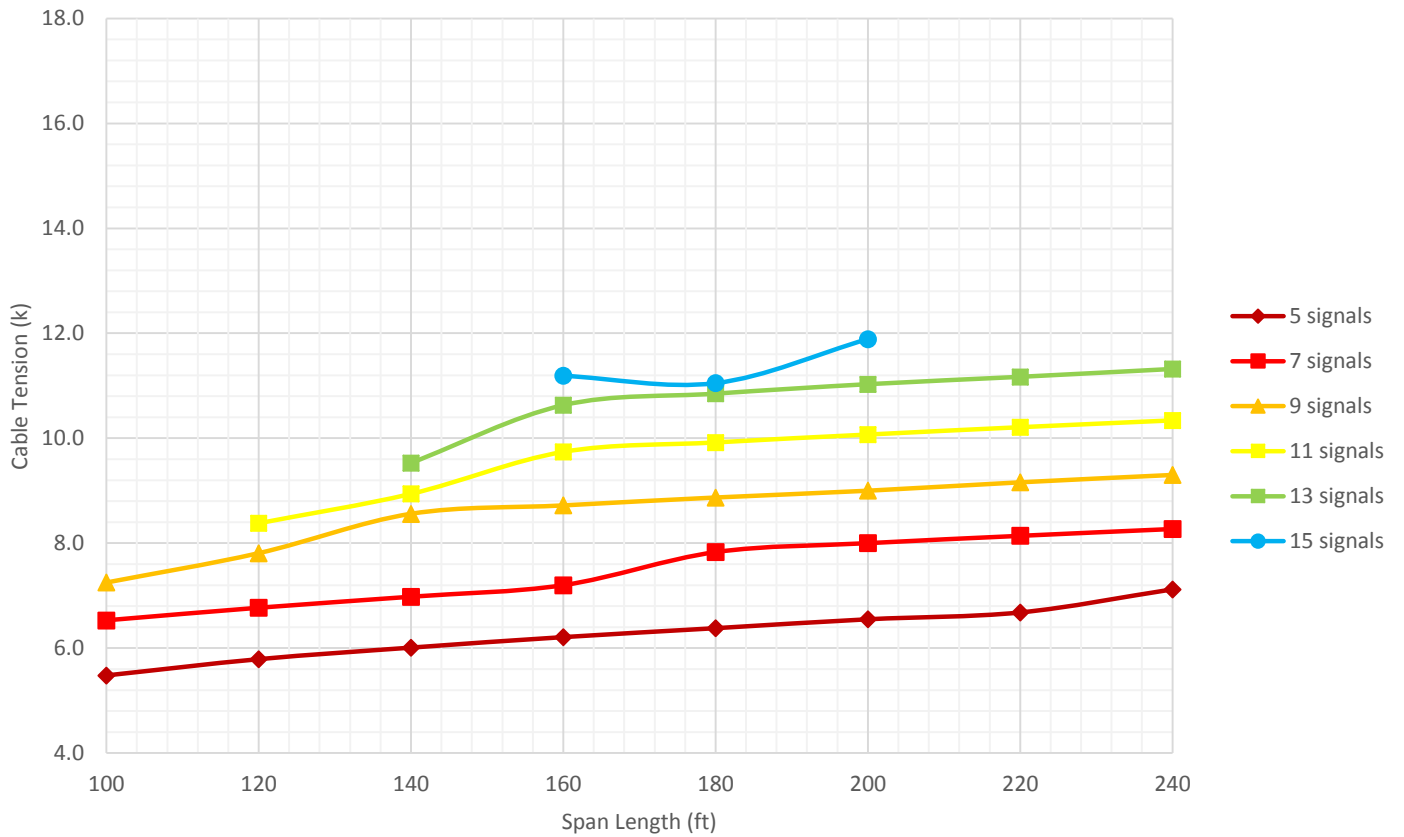

Figure 38 – ATLAS: 3 Headed Aluminum Signals, 110 mph, with Backplates

Cable Tension vs. Span Length [130 mph Wind Speed, Default Coefficient Values]

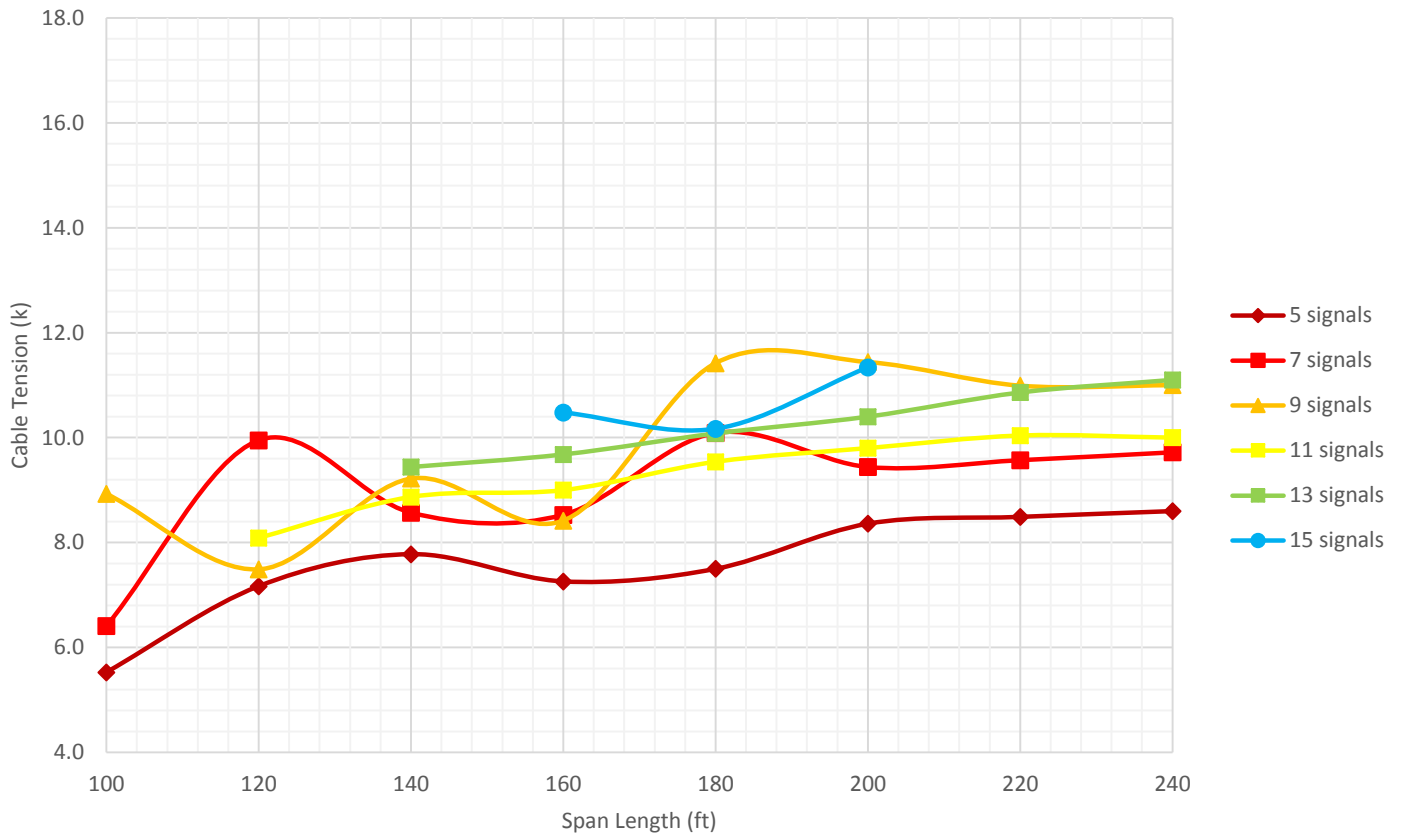

Figure 39 – ATLAS: 3 Headed Aluminum Signals, 130 mph, with Backplates

Cable Tension vs. Span Length [150 mph Wind Speed, Default Coefficient Values]

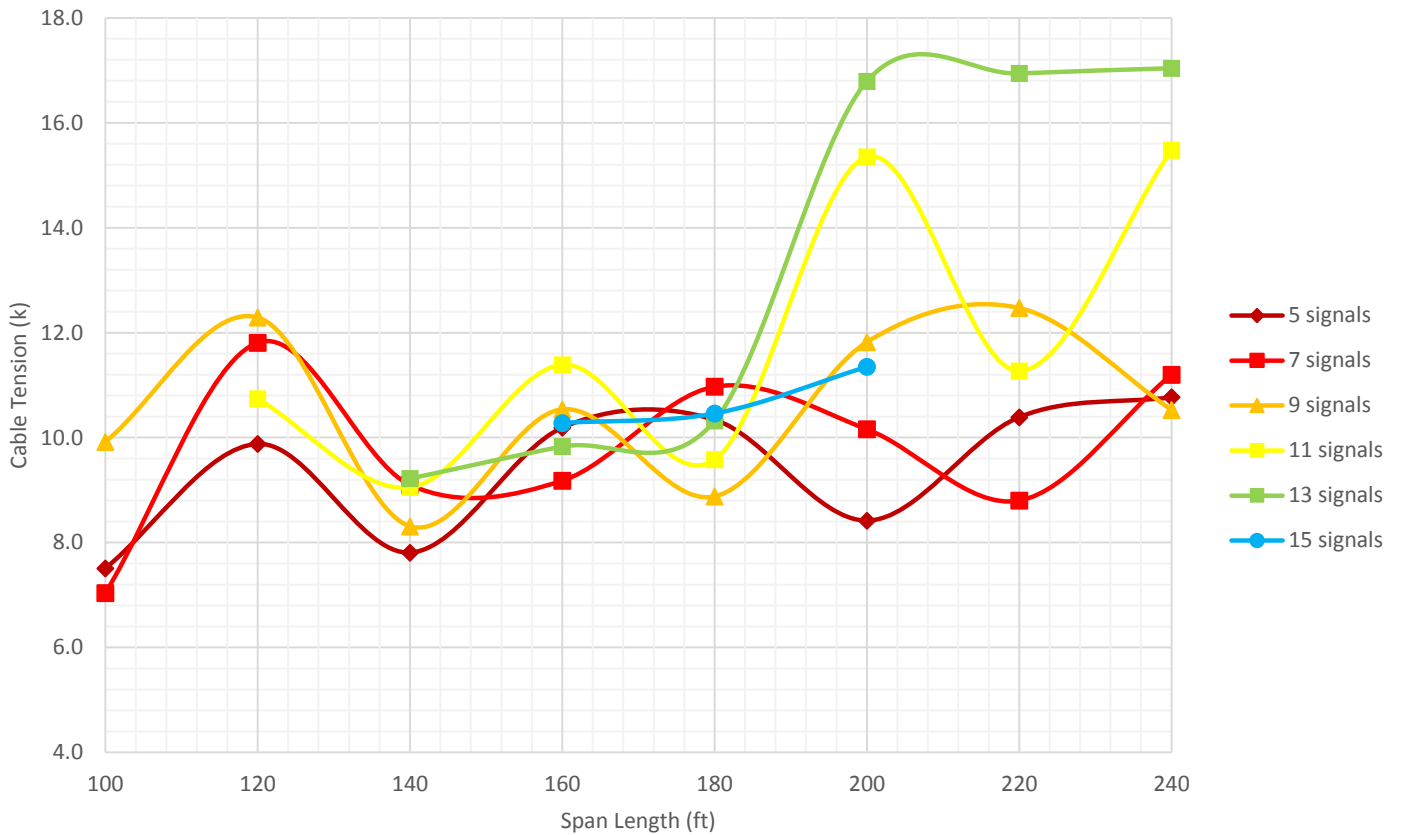

Figure 40 – ATLAS: 3 Headed Aluminum Signals, 150 mph, with Backplates

Cable Tension vs. Span Length [110 mph Wind Speed, Default Coefficient Values]

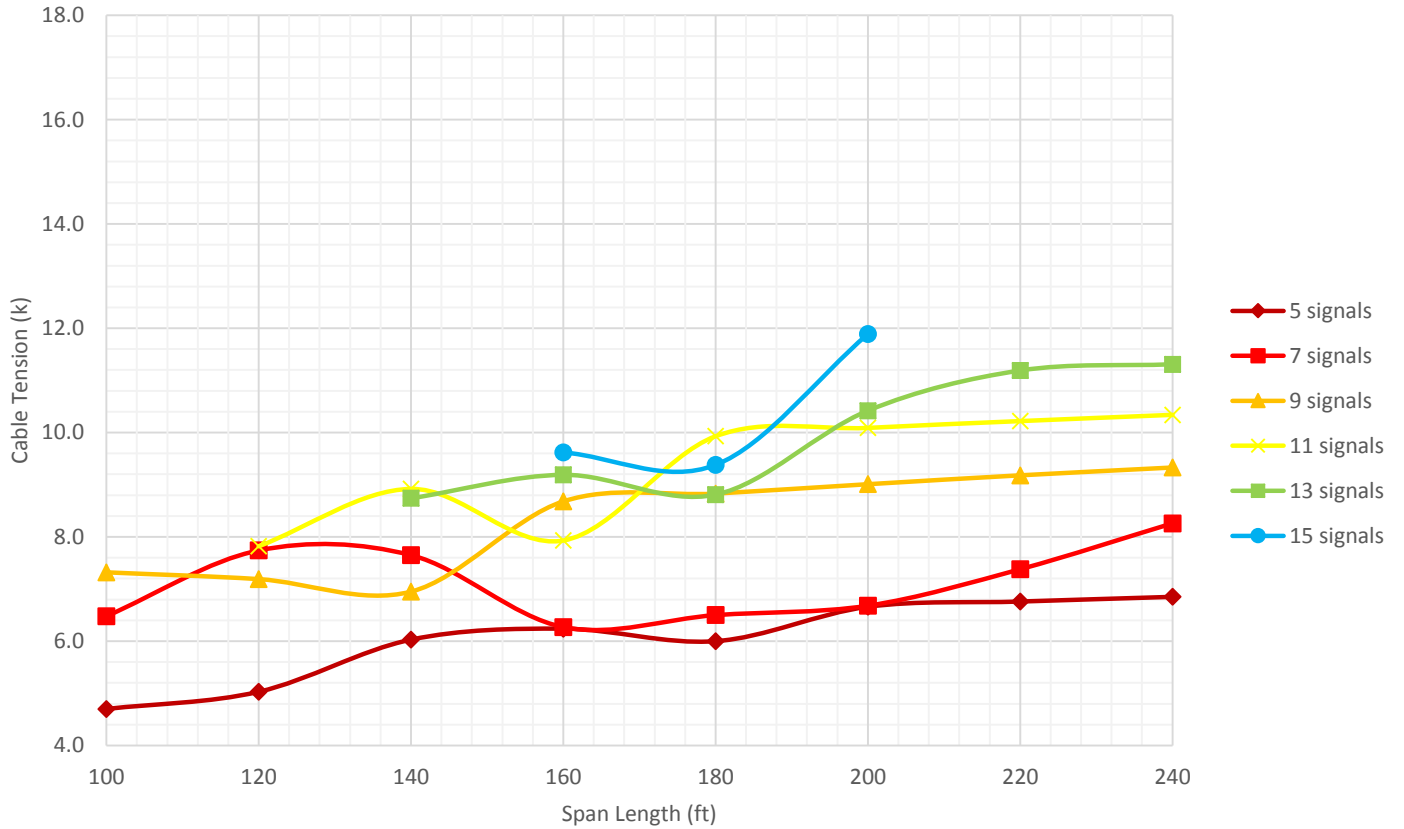

Figure 41 – ATLAS: 3 Headed Polycarbonate Signals, 110 mph, with Backplates

Cable Tension vs. Span Length [130 mph Wind Speed, Default Coefficient Values]

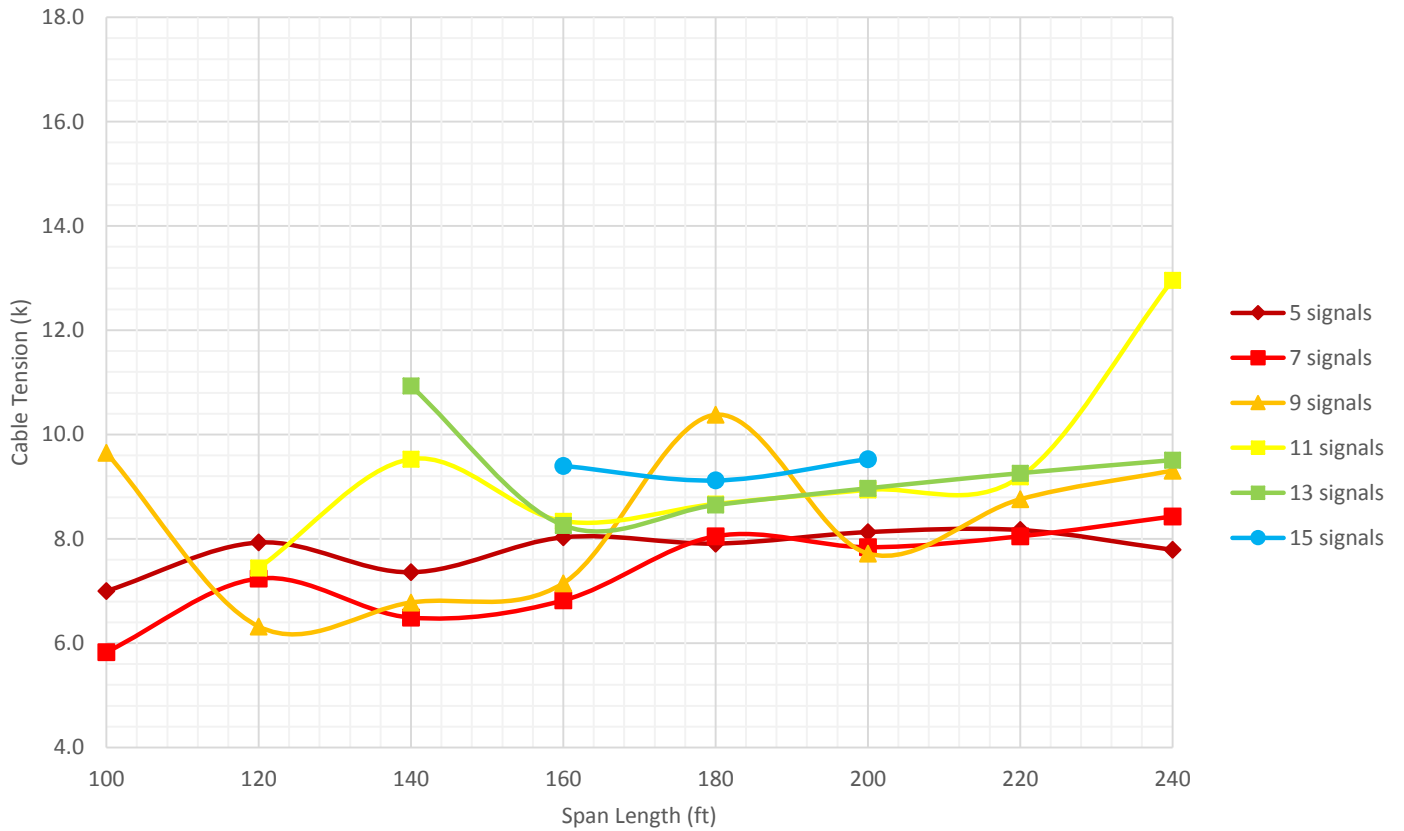

Figure 42 – ATLAS: 3 Headed Polycarbonate Signals, 130 mph, with Backplates

Cable Tension vs. Span Length [150 mph Wind Speed, Default Coefficient Values]

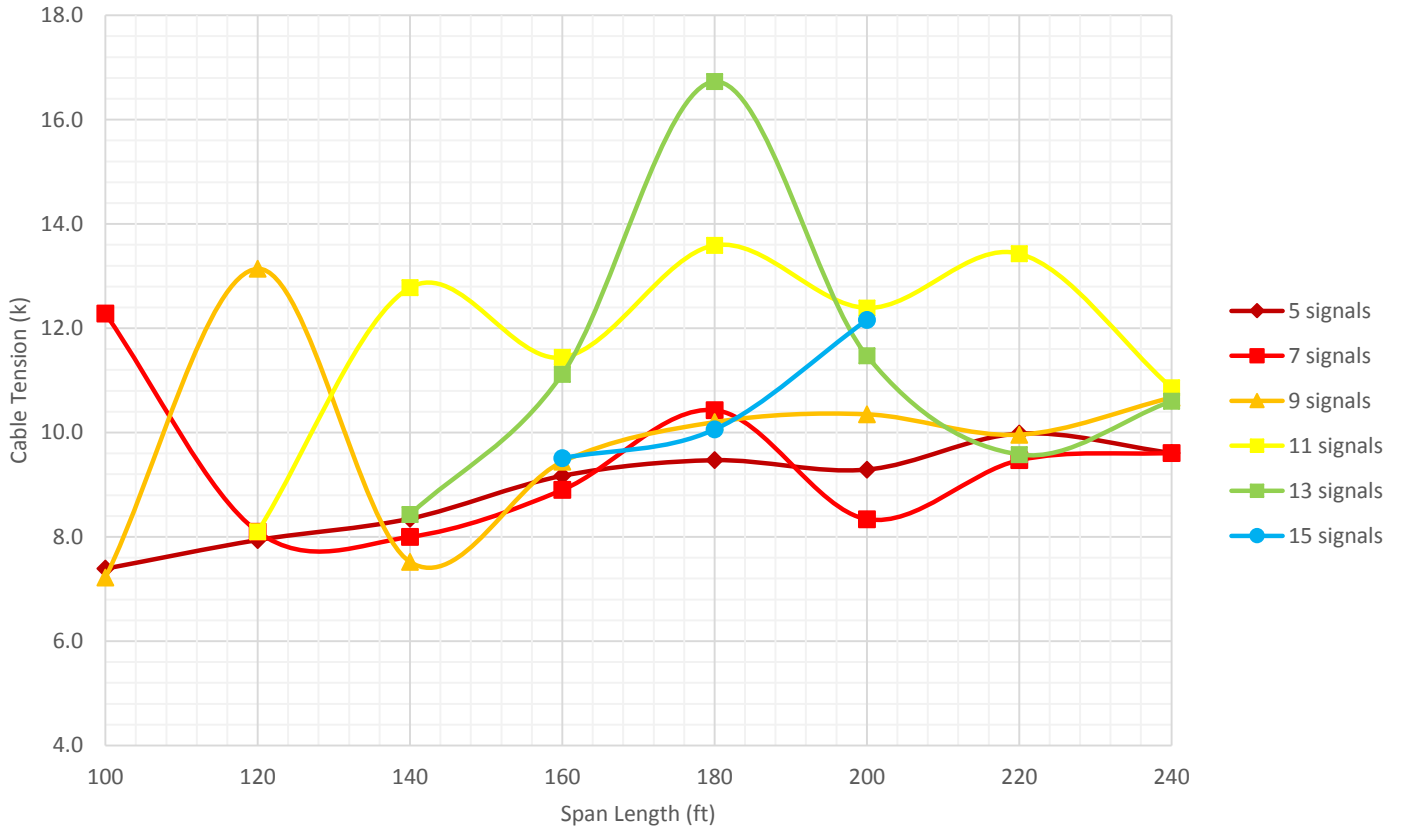

Figure 43 – ATLAS: 3 Headed Polycarbonate Signals, 150 mph, with Backplates

Cable Tension vs. Span Length [110 mph Wind Speed, Default Coefficient Values]

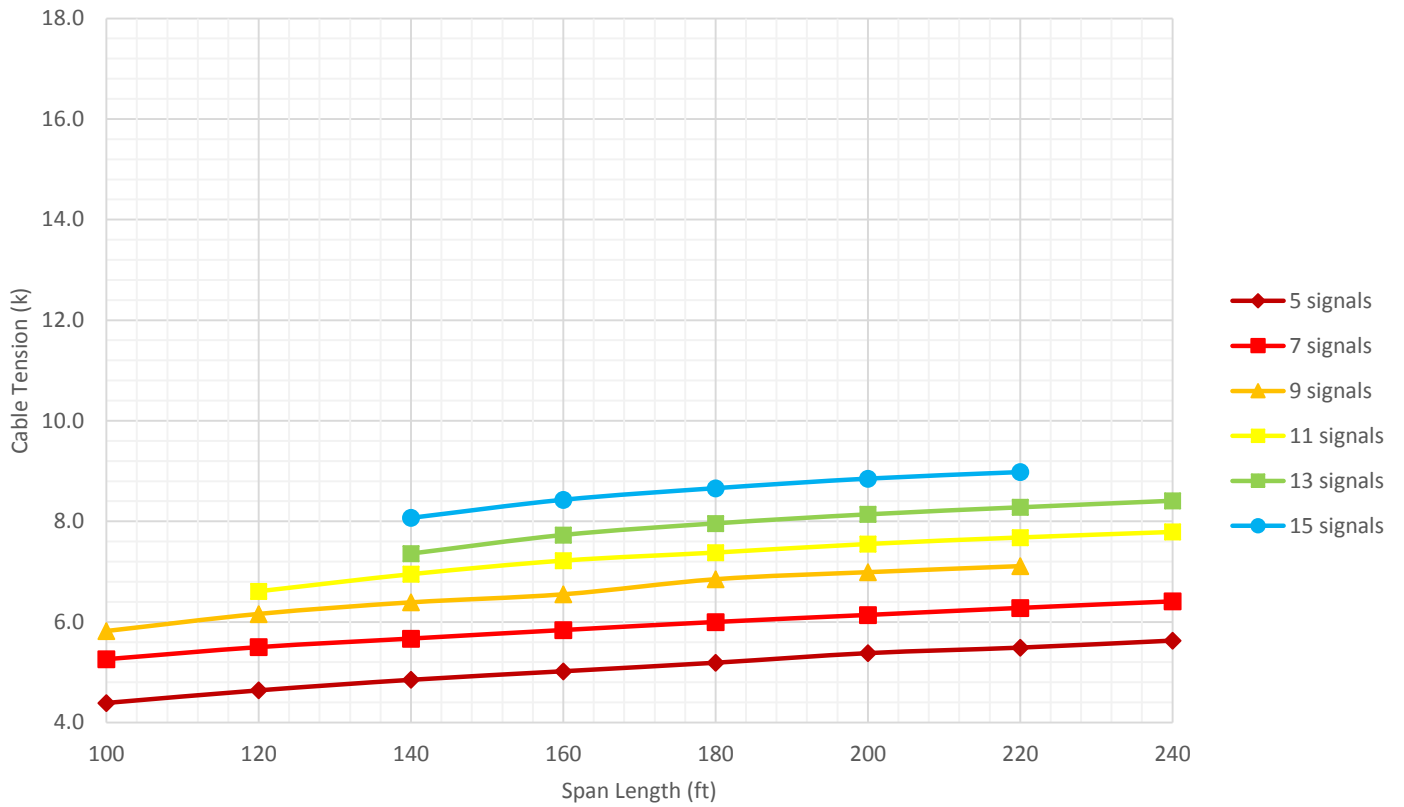

Figure 44 – ATLAS: 3 Headed Aluminum Signals without Backplates, 110 mph

Cable Tension vs. Span Length [130 mph Wind Speed, Default Coefficient Values]

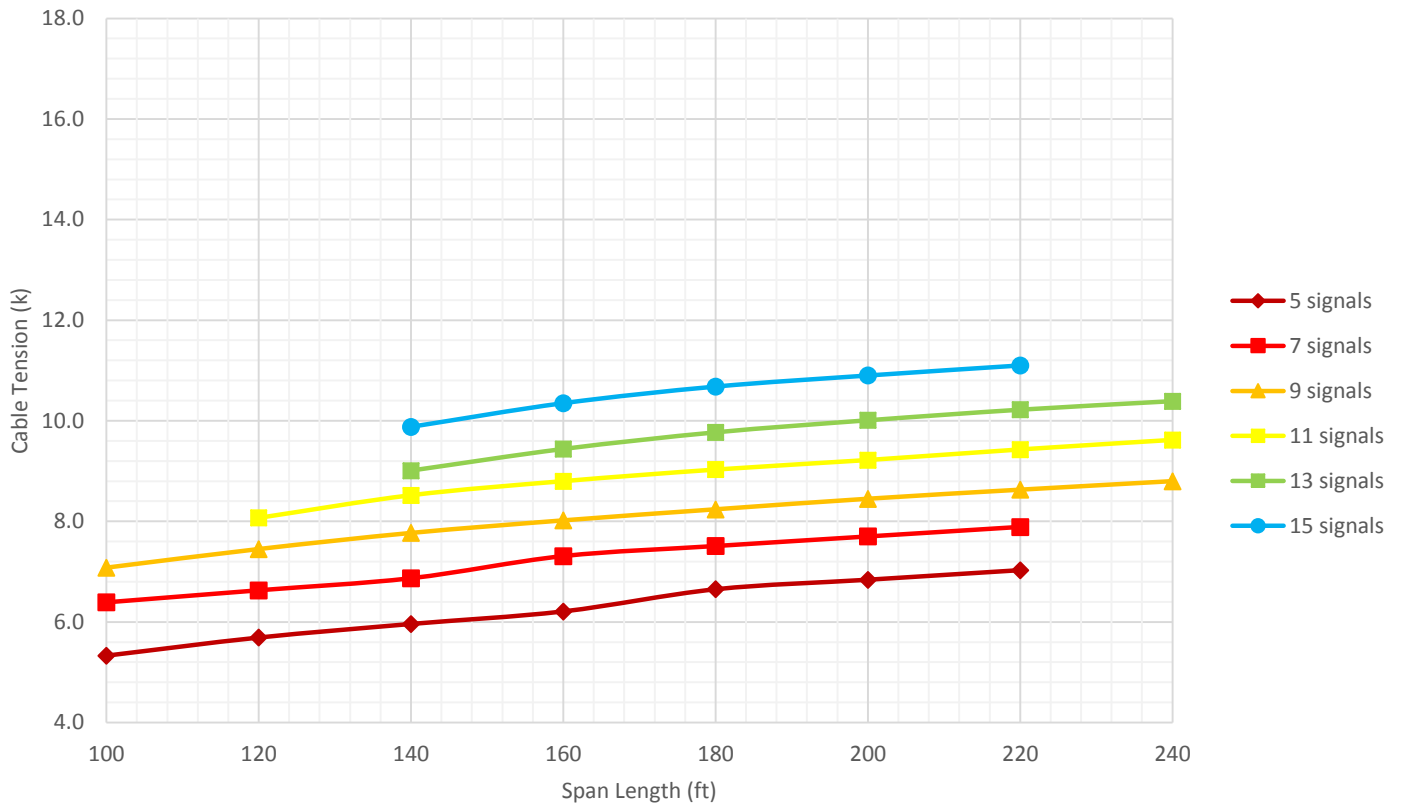

Figure 45 – ATLAS: 3 Headed Aluminum Signals without Backplates, 130 mph

Cable Tension vs. Span Length [150 mph Wind Speed, Default Coefficient Values]

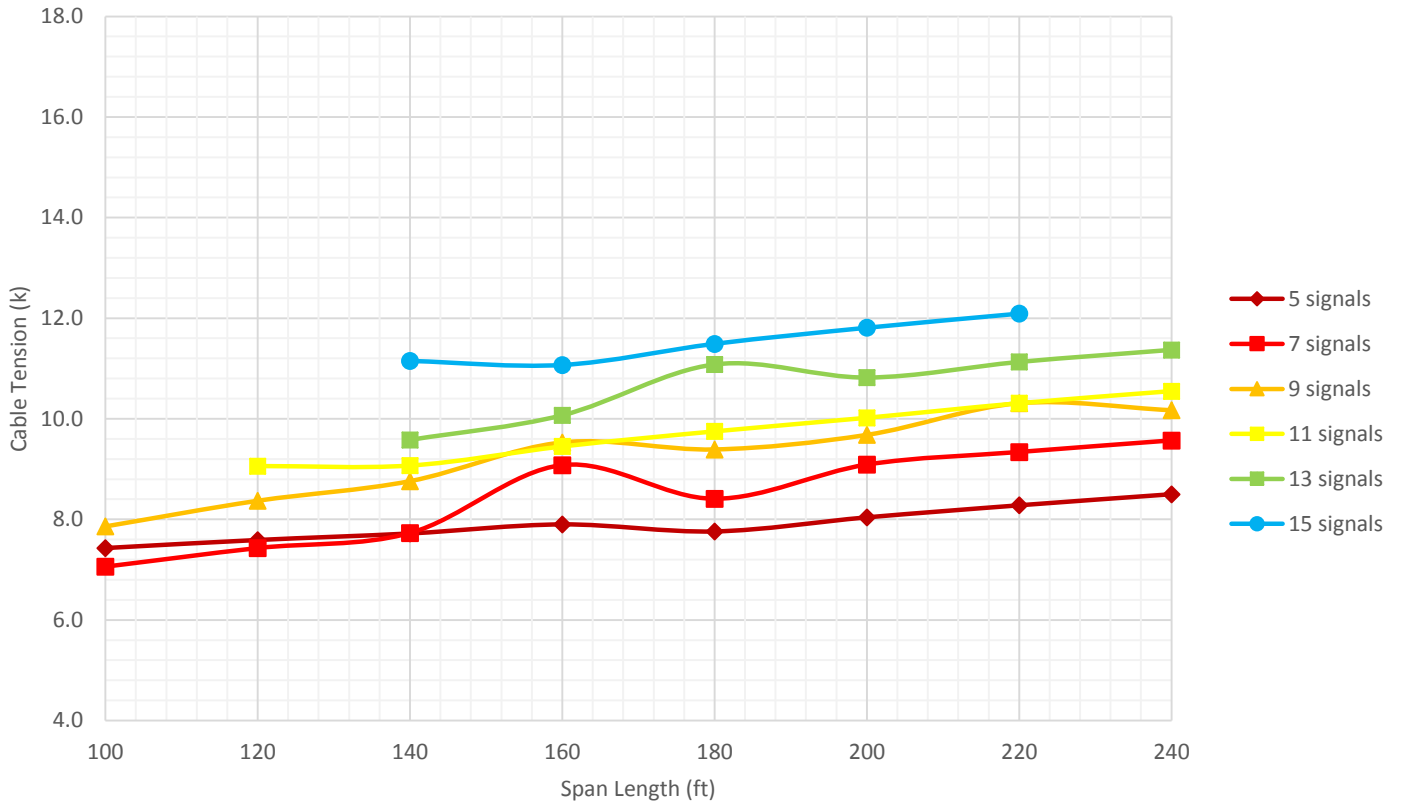

Figure 46 – ATLAS: 3 Headed Aluminum Signals without Backplates, 150 mph

Cable Tension vs. Span Length [110 mph Wind Speed, Default Coefficient Values]

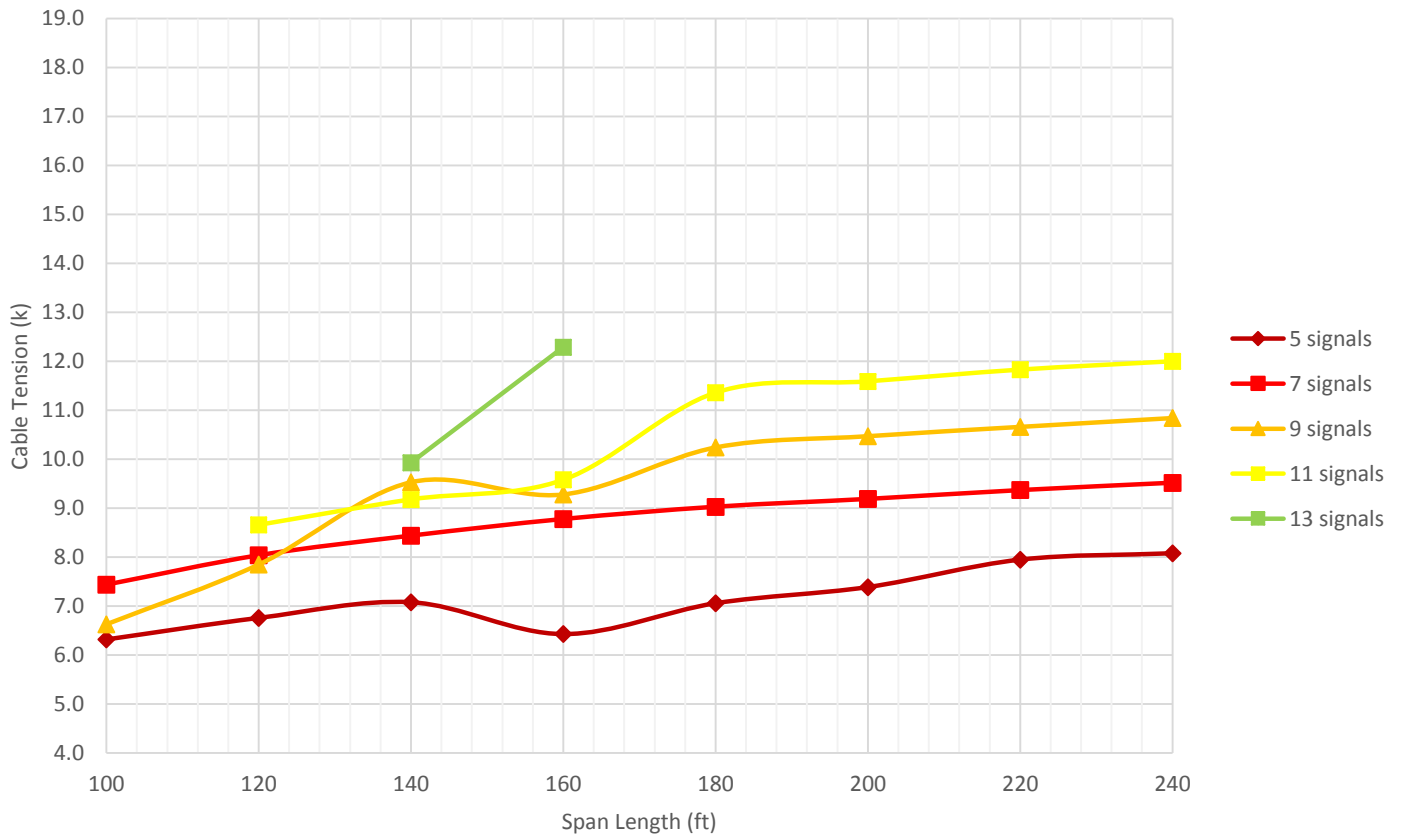

Figure 47 – ATLAS: 5 Headed Aluminum Signals, 110 mph, with Backplates

Cable Tension vs. Span Length [130 mph Wind Speed, Default Coefficient Values]

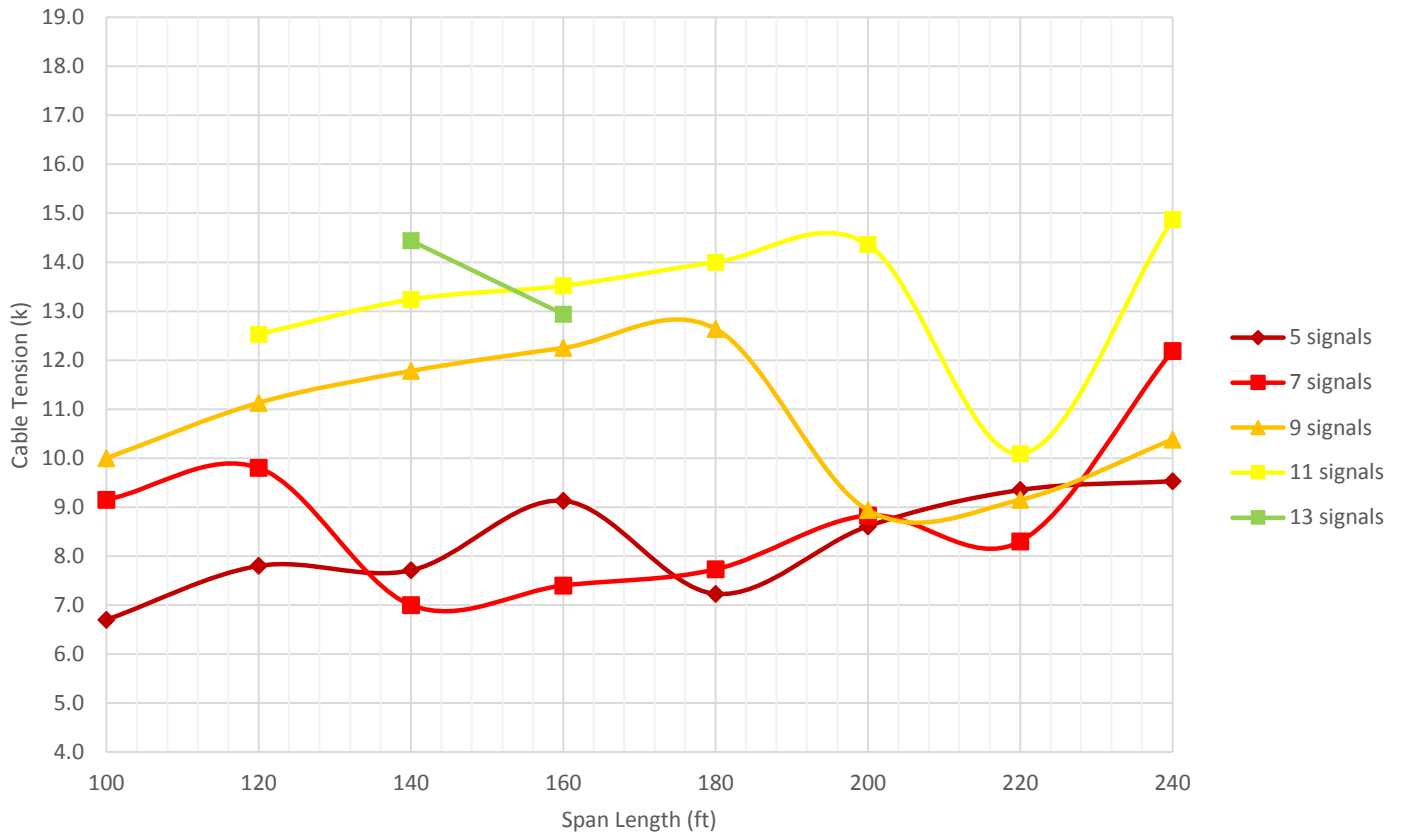

Figure 48 – ATLAS: 5 Headed Aluminum Signals, 130 mph, with Backplates

Cable Tension vs. Span Length [150 mph Wind Speed, Default Coefficient Values]

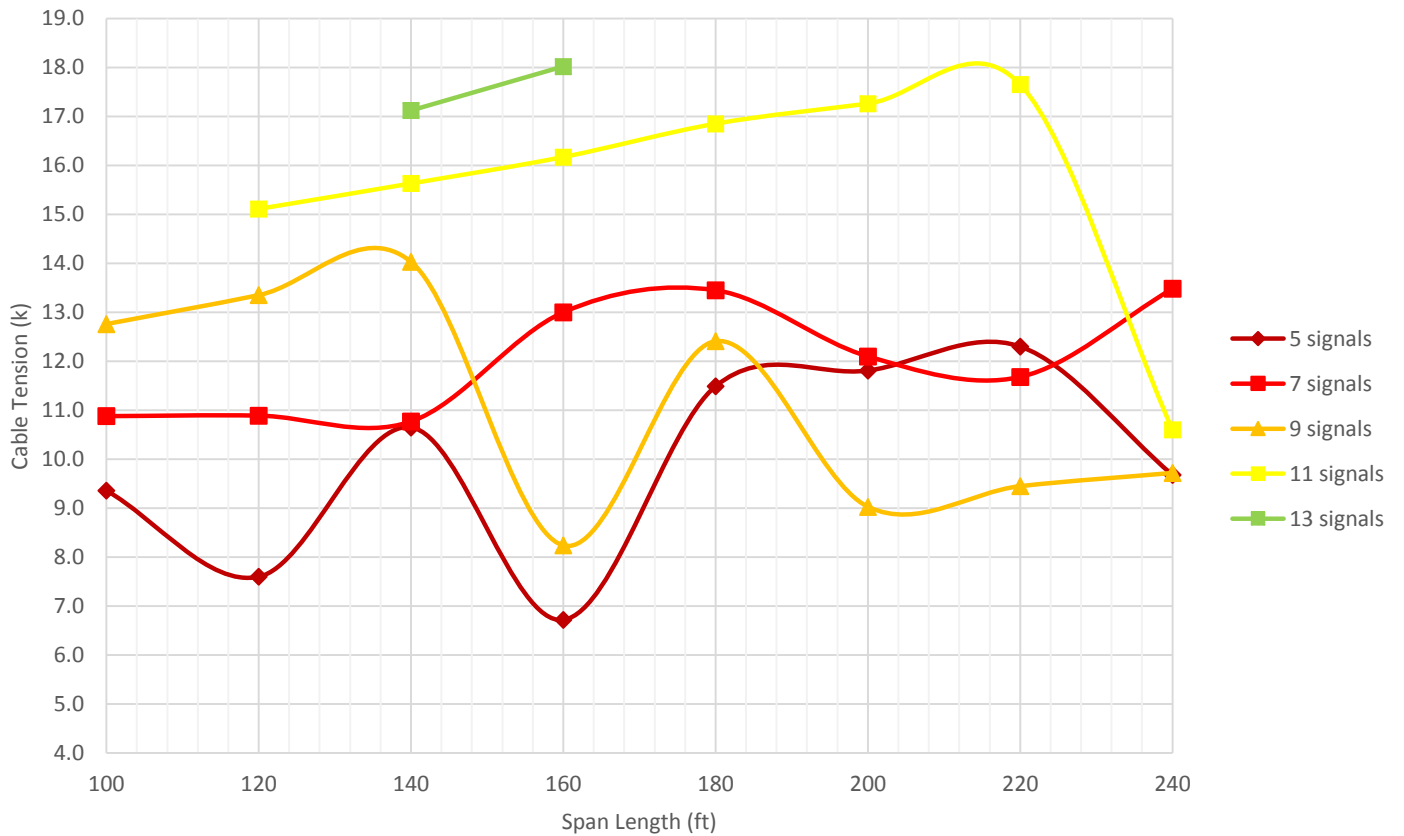

Figure 49 – ATLAS: 5 Headed Aluminum Signals, 150 mph, with Backplates

Cable Tension vs. Span Length [110 mph Wind Speed, Default Coefficient Values]

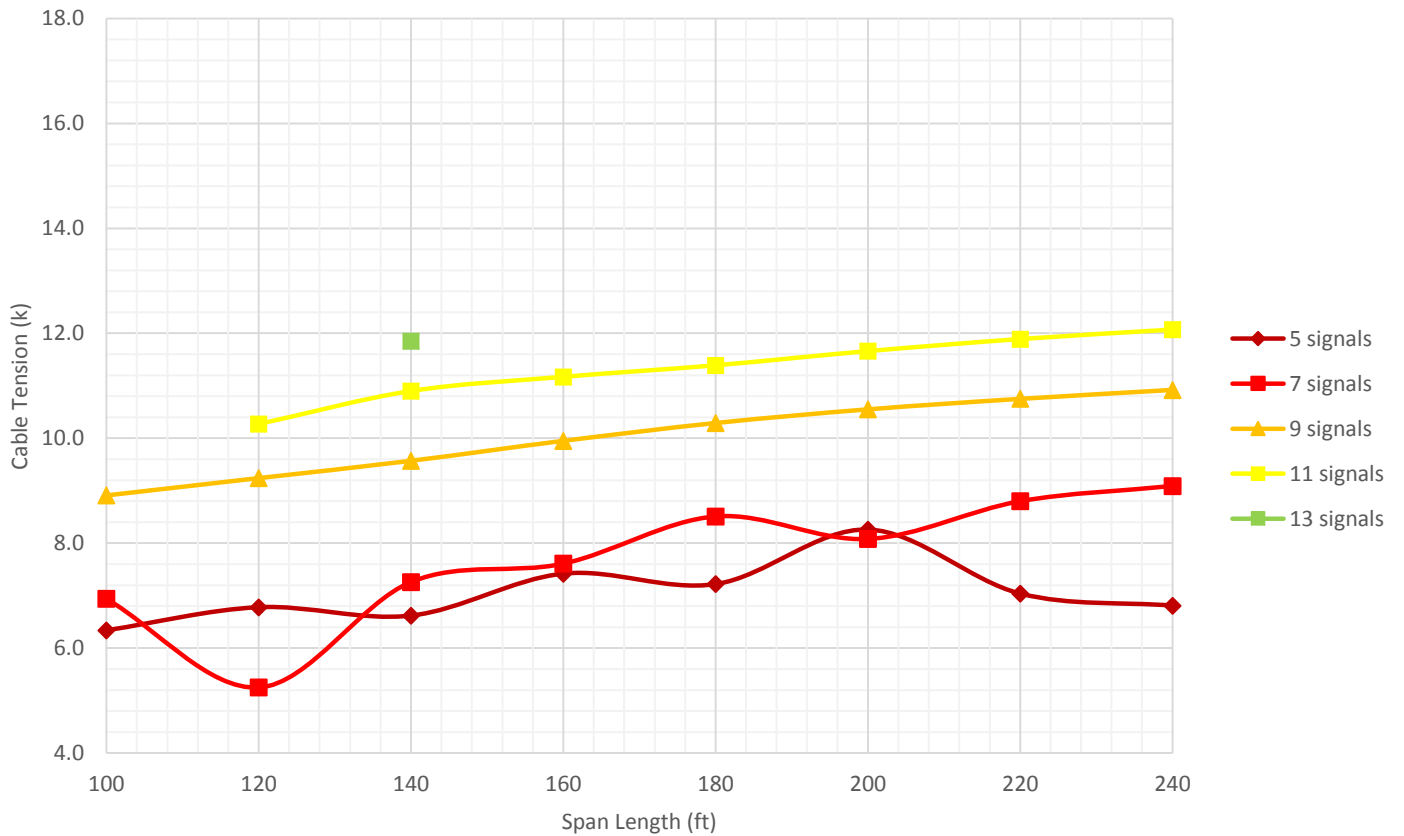

Figure 50 – ATLAS: 5 Headed Polycarbonate Signals, 110 mph, with Backplates

Cable Tension vs. Span Length [130 mph Wind Speed, Default Coefficient Values]

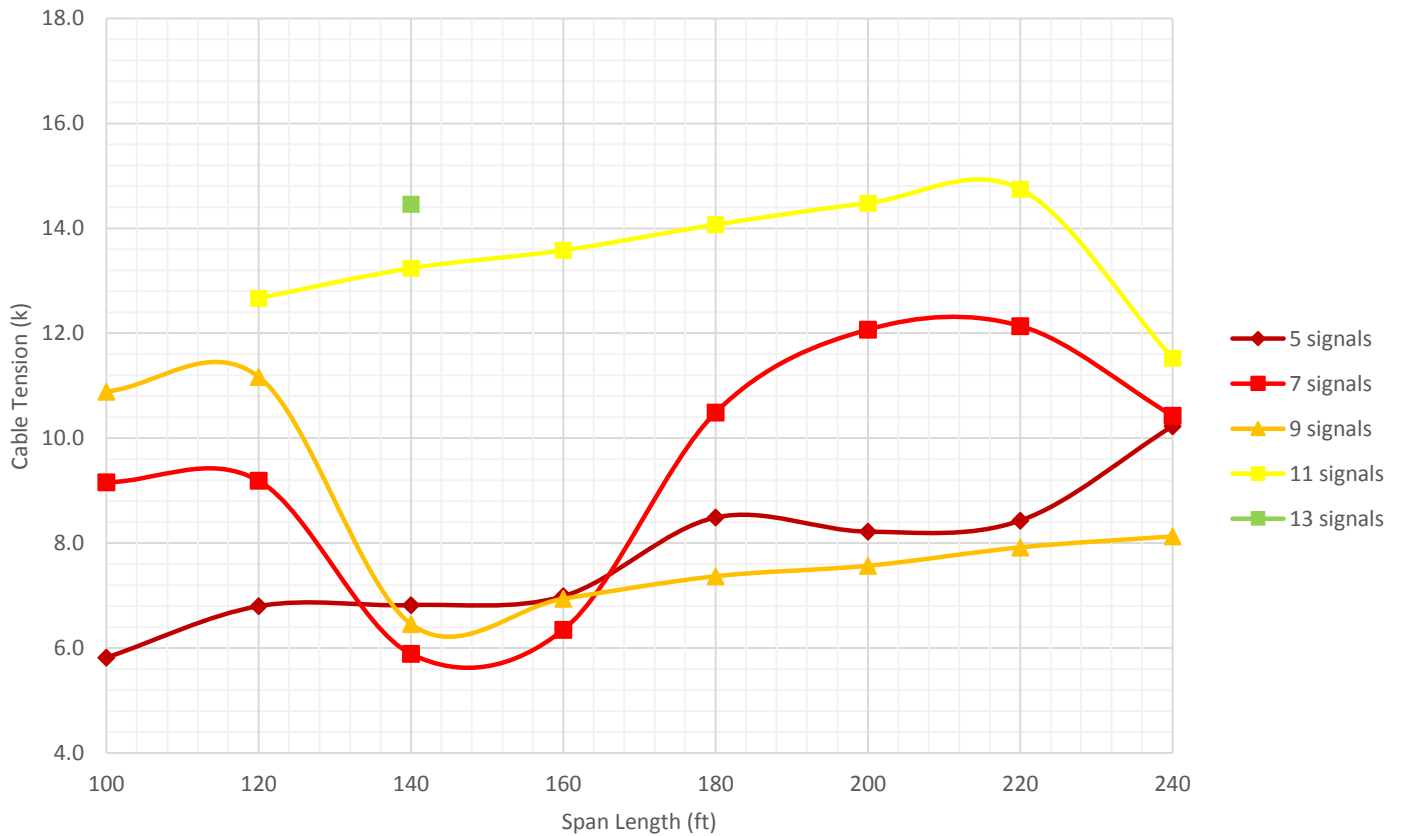

Figure 51 – ATLAS: 5 Headed Aluminum Signals, 130 mph, with Backplates

Cable Tension vs. Span Length [150 mph Wind Speed, Default Coefficient Values]

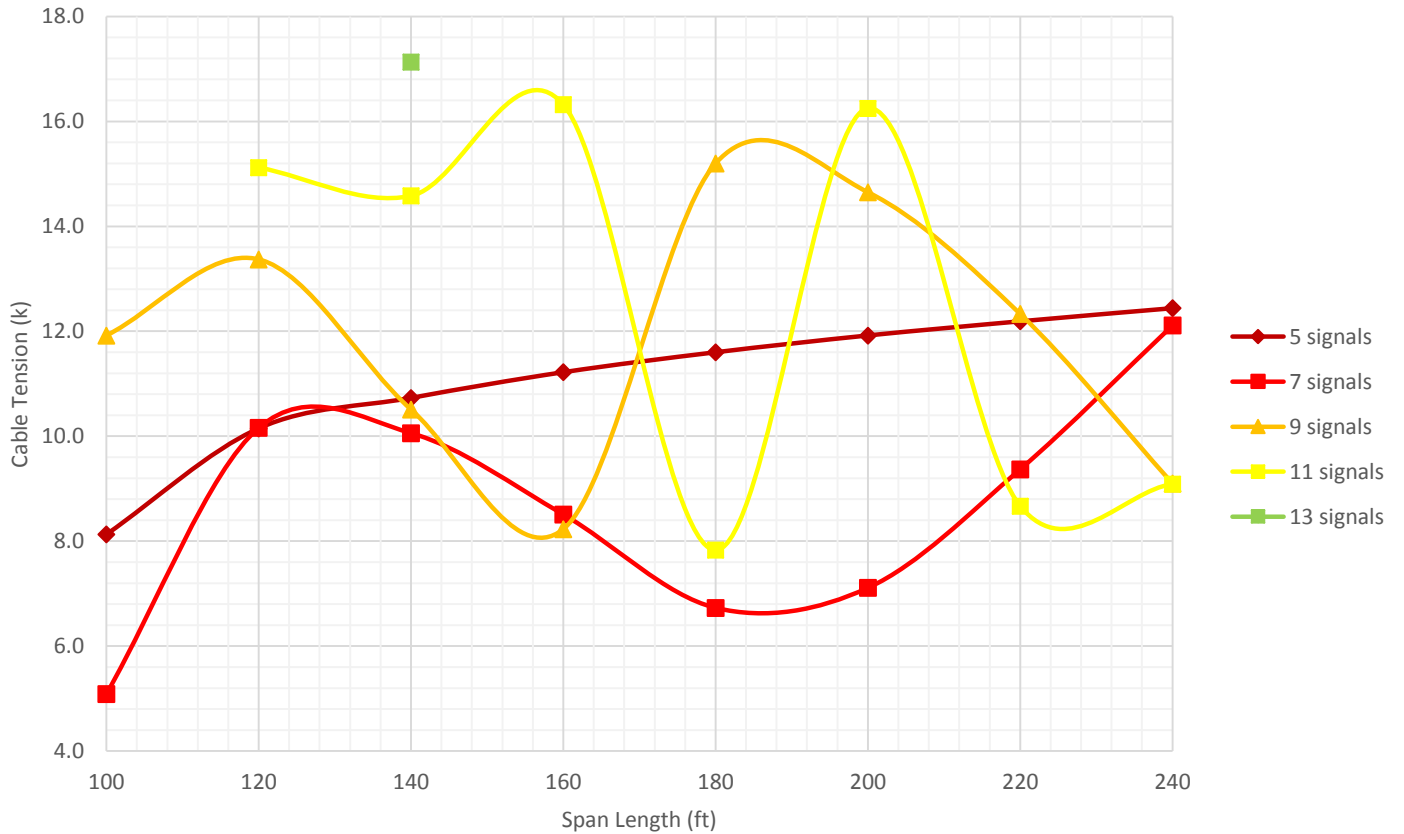

Figure 52 – ATLAS: 5 Headed Aluminum Signals, 150 mph, with Backplates

Span	Wind Speed	%Δ 3 Head Signal, Material (Default Coefficient)					
		5 signals	7 signals	9 signals	11 signals	13 signals	15 signals
100ft	110mph	16.6%	0.8%	-1.0%			
	130mph	-21.0%	9.9%	-7.5%			
	150mph	1.6%	-42.7%	37.4%			
120ft	110mph	15.1%	-12.5%	8.6%	7.2%		
	130mph	-9.6%	37.4%	18.5%	8.7%		
	150mph	24.4%	45.8%	-6.5%	32.6%		
140ft	110mph	-0.3%	-8.8%	23.2%	0.2%	9.0%	
	130mph	5.7%	32.0%	36.0%	-6.9%	-13.6%	
	150mph	-6.5%	13.8%	10.5%	-29.2%	9.4%	
160ft	110mph	-0.5%	14.8%	0.5%	22.8%	15.7%	16.3%
	130mph	-9.6%	25.1%	17.8%	7.9%	17.2%	11.5%
	150mph	11.1%	3.1%	11.7%	-0.4%	-11.6%	8.1%
180ft	110mph	6.3%	20.5%	0.5%	-0.1%	23.2%	17.8%
	130mph	-5.2%	25.3%	10.0%	10.0%	16.5%	11.5%
	150mph	9.2%	5.2%	-12.9%	-29.5%	-38.3%	4.0%
200ft	110mph	-1.7%	19.8%	-0.1%	-0.2%	5.9%	0.0%
	130mph	2.8%	20.4%	48.2%	9.6%	15.9%	19.0%
	150mph	-9.4%	21.8%	14.2%	23.9%	46.4%	-6.7%
220ft	110mph	-1.2%	10.3%	-0.2%	-0.1%	-0.2%	
	130mph	3.9%	18.9%	25.5%	9.2%	17.3%	
	150mph	4.1%	-7.1%	25.2%	-16.1%	76.8%	
240ft	110mph	3.9%	0.1%	-0.3%	0.0%	0.1%	
	130mph	10.4%	15.3%	18.2%	-22.8%	16.7%	
	150mph	12.1%	16.5%	-1.3%	42.5%	60.8%	

Table 4 – ATLAS: Percent Change in Cable Tension between 3 Headed Aluminum and Polycarbonate Signal Heads, with Backplates

Span	Wind Speed	%Δ 5 Head Signal, Material (Default Coefficient)					
		5 signals	7 signals	9 signals	11 signals	13 signals	15 signals
100ft	110mph	-0.3%	7.2%	-25.6%			
	130mph	15.1%	-0.1%	-8.2%			
	150mph	15.1%	113.8%	7.0%			
120ft	110mph	-0.3%	53.1%	-15.0%	-15.7%		
	130mph	14.7%	6.6%	-0.4%	-1.1%		
	150mph	-25.1%	7.2%	-0.1%	-0.1%		
140ft	110mph	6.9%	16.3%	-0.4%	-15.8%		
	130mph	13.0%	18.8%	82.4%	0.0%		
	150mph	-0.7%	7.1%	33.5%	7.2%		
160ft	110mph	-13.3%	15.4%	-6.7%	-14.2%		
	130mph	30.6%	16.5%	76.5%	-0.4%		
	150mph	-40.1%	52.8%	0.1%	-0.9%		
180ft	110mph	-2.2%	6.1%	-0.5%	-0.3%		
	130mph	-14.8%	-26.3%	71.5%	-0.5%		
	150mph	-0.9%	99.9%	-18.4%	115.2%		
200ft	110mph	-10.5%	13.7%	-0.8%	-0.6%		
	130mph	4.7%	-26.8%	18.1%	-0.8%		
	150mph	-0.9%	70.2%	-38.4%	6.2%		
220ft	110mph	12.9%	6.5%	-0.8%	-0.5%		
	130mph	10.9%	-31.6%	15.5%	-31.6%		
	150mph	0.9%	24.7%	-23.4%	103.6%		
240ft	110mph	18.6%	4.7%	-0.7%	-0.6%		
	130mph	-6.8%	16.9%	27.7%	29.0%		
	150mph	-22.2%	11.3%	6.8%	16.6%		

Table 5 – ATLAS: Percent Change in Cable Tension between 5 Headed Aluminum and Polycarbonate Signal Heads, with Backplates

%Δ 3 Head Aluminum							
Span	Wind Speed	5 Signals	7 Signals	9 Signals	11 Signals	13 Signals	15 Signals
100ft	110mph	24.8%	24.1%	24.6%			
	130mph	3.8%	0.3%	26.1%			
	150mph	1.1%	-0.3%	26.2%			
120ft	110mph	24.8%	23.1%	26.8%	26.8%		
	130mph	26.0%	50.1%	0.5%	0.2%		
	150mph	30.2%	59.0%	46.8%	18.5%		
140ft	110mph	23.9%	23.1%	34.0%	28.6%	29.5%	
	130mph	30.5%	24.7%	18.7%	4.1%	4.8%	
	150mph	1.2%	17.7%	-5.1%	-0.2%	-3.8%	
160ft	110mph	23.7%	23.3%	33.1%	34.9%	37.5%	38.7%
	130mph	16.9%	20.3%	5.0%	2.3%	2.5%	6.1%
	150mph	29.0%	1.1%	10.6%	20.5%	-2.4%	-7.8%
180ft	110mph	22.9%	30.5%	32.4%	34.4%	36.3%	31.1%
	130mph	16.3%	38.0%	38.6%	5.6%	3.2%	-1.7%
	150mph	33.2%	30.4%	-5.4%	-1.7%	-6.9%	-5.5%
200ft	110mph	21.7%	30.3%	31.4%	33.4%	35.5%	37.3%
	130mph	25.7%	25.7%	35.4%	6.3%	3.9%	6.2%
	150mph	4.7%	11.8%	22.1%	53.2%	55.2%	-1.2%
220ft	110mph	21.7%	29.6%	31.0%	32.9%	34.9%	
	130mph	24.1%	24.3%	27.3%	6.5%	6.3%	
	150mph	25.5%	-5.8%	21.0%	9.3%	52.2%	
240ft	110mph	26.5%	29.0%	30.8%	32.7%	34.6%	
	130mph	22.3%	23.2%	25.0%	4.0%	6.8%	
	150mph	26.7%	17.0%	3.5%	46.7%	49.9%	

Table 6 – ATLAS: Percent Change in Cable Tension between 3 Headed Aluminum Signal Heads with and without Backplates

Span	Wind Speed	9 Signals									11 Signals									13 Signals								
		Default	0.5	0.6	0.7	0.8	0.9	0.7/0.4	Default	0.5	0.6	0.7	0.8	0.9	0.7/0.4	Default	0.5	0.6	0.7	0.8	0.9	0.7/0.4						
100ft	110mph	7.3	6.4	7.2	7.9	8.5	9.1	9.1																				
	130mph	8.9	8.1	9.0	9.8	10.6	11.4	11.4																				
	150mph	9.9	9.8	10.8	11.9	12.8	13.8	13.8																				
120ft	110mph	7.8	7.0	7.8	8.5	9.2	9.9	9.9	8.4	7.3	8.2	9.0	9.7	10.5	10.4													
	130mph	7.5	8.8	9.7	10.7	11.5	12.4	12.5	8.1	9.2	10.3	11.3	12.2	13.1	13.1													
	150mph	12.3	10.6	11.8	12.9	13.9	15.0	15.0	10.7	11.2	12.4	13.6	14.8	15.9	15.9													
140ft	110mph	8.6	7.3	8.1	8.9	9.7	10.4	10.5	8.9	7.8	8.7	9.6	10.4	11.2	12.2	9.5	8.1	9.1	10.0	10.8	11.7	11.7						
	130mph	9.2	9.2	10.2	11.2	12.1	13.0	13.2	8.9	9.8	11.0	12.0	13.0	14.0	14.1	9.4	10.2	11.4	12.5	13.6	14.6	14.7						
	150mph	8.3	11.2	12.4	13.6	14.7	15.7	16.0	9.1	12.0	13.3	14.6	15.8	17.0	17.2	9.2	12.5	13.9	15.2	16.5	17.7	17.9						
160ft	110mph	8.7	7.5	8.4	9.2	10.0	10.7	10.9	9.7	8.1	9.0	9.9	10.8	11.6	11.8	10.6	8.5	9.5	10.5	11.4	12.3	12.4						
	130mph	8.4	9.5	10.6	11.6	12.5	13.4	13.7	9.0	10.3	11.4	12.5	13.6	14.6	14.8	9.7	10.8	12.1	13.3	14.4	15.5	15.7						
	150mph	10.5	11.6	12.9	14.1	15.2	16.3	15.5	11.4	12.5	13.9	15.2	16.5	17.7	7.6	9.8	13.2	14.7	16.2	17.5	18.8	19.1						
180ft	110mph	8.9	7.7	8.6	9.4	10.2	11.0	11.2	9.9	8.3	9.3	10.2	11.1	12.0	12.2	10.9	8.8	9.9	10.9	11.8	11.9	12.2						
	130mph	11.4	9.8	10.9	11.9	12.8	13.8	14.1	9.5	10.6	11.8	12.9	14.0	15.0	15.4	10.1	11.2	12.5	13.8	15.0	15.2	15.6						
	150mph	8.9	11.9	13.2	14.4	15.6	16.7	17.4	9.6	12.9	14.4	15.7	17.0	18.3	18.7	10.3	13.7	15.3	16.8	17.3	18.7	19.2						
200ft	110mph	9.0	7.8	8.7	9.6	10.4	11.2	11.4	10.1	8.5	9.5	10.4	11.3	12.2	12.5	11.0	9.0	10.1	11.1	12.1	13.1	13.4						
	130mph	11.4	10.0	11.1	12.1	13.1	14.0	14.4	9.8	10.8	12.0	13.2	14.3	15.4	15.8	10.4	11.5	12.9	14.1	15.3	16.5	16.9						
	150mph	11.8	12.2	13.5	14.7	15.9	17.0	8.0	15.4	13.2	14.7	16.1	17.4	18.7	19.3	16.8	14.1	15.7	17.2	18.7	20.1	20.7						
220ft	110mph	9.2	8.0	8.9	9.7	10.5	11.3	11.6	10.2	8.6	9.6	10.6	11.5	12.4	12.7	11.2	9.2	10.3	11.3	12.3	13.3	13.7						
	130mph	11.0	10.1	11.3	12.3	13.3	14.2	10.8	10.0	11.0	12.3	13.4	14.6	15.6	16.1	10.9	11.7	13.1	14.4	15.6	16.8	17.3						
	150mph	12.5	12.4	13.7	15.0	16.2	17.3	9.2	11.3	13.5	15.0	16.4	17.7	19.0	18.4	16.9	14.4	16.1	17.6	19.1	20.5	21.2						
240ft	110mph	9.3	8.0	9.0	9.8	10.6	11.4	11.8	10.3	8.7	9.7	10.7	11.6	12.5	12.9	11.3	9.3	10.4	11.5	12.5	13.5	13.9						
	130mph	11.0	10.3	11.4	12.5	13.5	14.4	8.4	10.0	11.2	12.4	13.6	14.7	15.8	16.4	11.1	11.9	13.3	14.6	15.9	17.1	17.7						
	150mph	10.5	12.6	13.9	15.2	16.4	17.5	11.4	15.5	13.7	15.2	16.6	18.0	19.3	18.8	17.0	14.7	16.3	17.9	19.4	20.8	21.6						

Table 7 – ATLAS: Excerpt of Single Force Coefficient Study, with Backplates

Legend	
	Actual Closest Answer (conservative)
	Actual Closest Answer (unconservative)
	Projected Closest Answer (conservative)
	Projected Closest Answer (unconservative)

Table 8 – ATLAS: Legend for Single Force Coefficient Table

Traffic Signal Type (# Heads, Head Material, backplate)	Runs Completed	
	Default	0.7/0.4
3 head, aluminum, backplate	28	90
3 head, polycarbonate, backplate	14	71
5 head, aluminum, backplate	54	99
5 head, polycarbonate, backplate	43	92
3 head, aluminum, no backplate	89	Not run

* Total Number of Runs Possible = 120

Table 9 – ATLAS: Number of Completed Runs for All Signal Types, Single Span

Traffic Signal Type (# Heads, Head Material, backplate)	Default		0.7/0.4	
	Min. Δ	Max. Δ	Min. Δ	Max. Δ
3 head, aluminum, backplate	-10.6%	10.4%	-45.5%	-12.0%
3 head, polycarbonate, backplate	-16.8%	10.0%	-44.8%	-15.1%
5 head, aluminum, backplate	-8.5%	17.2%	-37.7%	-5.4%
5 head, polycarbonate, backplate	-7.2%	20.8%	-36.8%	-13.0%
3 head, aluminum, no backplate	-30.9%	3.4%	X	X

Note – Positive values indicate ATLAS values that are less than GTStrudl results. Negative values indicate ATLAS values that are greater than GTStrudl results.

Table 10 – ATLAS vs. GTStrudl Comparison

Appendix D – Box Span Wire Study

Span	Wind Speed	5 Signals				7 Signals				9 Signals			
		90 deg	0 deg	45 deg	30 deg	90 deg	0 deg	45 deg	30 deg	90 deg	0 deg	45 deg	30 deg
100ft	110mph	5.9	5.9	5.0	5.6	6.8	6.8	5.7	6.4	7.2	7.2	6.2	6.9
	130mph	6.7	6.7	5.8	6.5	7.7	7.7	6.7	7.4	8.2	8.2	7.2	8.0
	150mph	7.8	7.8	6.9	7.6	8.9	8.9	8.0	8.7	9.5	9.5	8.6	9.4
120ft	110mph	6.4	6.4	5.4	6.0	7.3	7.3	6.2	6.9	8.0	8.0	6.8	7.6
	130mph	7.2	7.2	6.2	6.9	8.3	8.3	7.2	8.0	9.1	9.1	7.9	8.8
	150mph	8.3	8.3	7.4	8.1	9.6	9.6	8.6	9.4	10.5	10.5	9.5	10.3
140ft	110mph	6.7	6.7	5.6	6.3	7.8	7.8	6.6	7.3	8.6	8.6	7.3	8.1
	130mph	7.6	7.6	6.5	7.3	8.8	8.8	7.6	8.5	9.7	9.7	8.5	9.4
	150mph	8.8	8.8	7.7	8.5	10.2	10.2	9.1	9.9	11.3	11.3	10.1	11.0
160ft	110mph	7.0	7.0	5.9	6.6	8.2	8.2	6.9	7.7	9.1	9.1	7.7	8.6
	130mph	8.0	8.0	6.8	7.6	9.2	9.2	8.0	8.8	10.3	10.3	8.9	9.8
	150mph	9.2	9.2	8.0	8.9	10.7	10.7	9.4	10.4	11.9	11.9	10.5	11.6
180ft	110mph	7.3	7.3	6.1	6.8	8.5	8.5	7.1	8.0	9.5	9.5	8.0	8.9
	130mph	8.3	8.3	7.0	7.8	9.6	9.6	8.2	9.2	10.7	10.7	9.2	10.2
	150mph	9.5	9.5	8.3	9.2	11.1	11.1	9.7	10.7	12.4	12.4	10.9	12.0
200ft	110mph	7.5	7.5	6.3	7.0	8.7	8.7	7.4	8.2	9.8	9.8	8.2	9.2
	130mph	8.5	8.5	7.3	8.1	9.9	9.9	8.5	9.4	11.1	11.1	9.5	10.6
	150mph	9.8	9.8	8.6	9.5	11.4	11.4	10.0	11.0	12.8	12.8	11.3	12.4
220ft	110mph	7.7	7.7	6.5	7.2	9.0	9.0	7.6	8.5	10.1	10.1	8.5	9.5
	130mph	8.8	8.8	7.5	8.3	10.2	10.2	8.7	9.7	11.4	11.4	9.7	10.9
	150mph	10.1	10.1	8.8	9.7	11.8	11.8	10.3	11.3	13.1	13.1	11.5	12.7
240ft	110mph	7.9	7.9	6.7	7.4	9.2	9.2	7.8	8.7	10.3	10.3	8.7	9.7
	130mph	9.0	9.0	7.7	8.5	10.4	10.4	8.9	9.9	11.7	11.7	10.0	11.1
	150mph	10.4	10.4	9.0	10.0	12.0	12.0	10.5	11.6	13.5	13.5	11.8	13.0

Table 11 – GTStrudl Cable Tension Results Excerpt with 3 Headed, Aluminum Traffic Signals, with Backplates

Span	Wind Speed	5 Signals				7 Signals				9 Signals			
		90 deg	45 deg	30 deg	Ratio	90 deg	45 deg	30 deg	Ratio	90 deg	45 deg	30 deg	Ratio
100ft	110mph	0.55	0.68	0.66	1.23	0.62	0.77	0.75	1.24	0.67	0.83	0.81	1.25
	130mph	0.59	0.79	0.76	1.33	0.67	0.89	0.87	1.34	0.71	0.96	0.93	1.35
	150mph	0.65	0.93	0.91	1.43	0.73	1.06	1.03	1.45	0.78	1.14	1.11	1.46
120ft	110mph	0.60	0.73	0.71	1.21	0.68	0.83	0.81	1.22	0.74	0.91	0.89	1.23
	130mph	0.64	0.84	0.82	1.31	0.73	0.96	0.93	1.32	0.79	1.05	1.02	1.34
	150mph	0.71	1.00	0.97	1.41	0.79	1.14	1.11	1.44	0.86	1.25	1.21	1.45
140ft	110mph	0.65	0.77	0.76	1.19	0.74	0.89	0.87	1.20	0.81	0.97	0.95	1.21
	130mph	0.69	0.89	0.86	1.29	0.78	1.02	0.99	1.31	0.85	1.12	1.09	1.32
	150mph	0.75	1.05	1.02	1.40	0.85	1.21	1.17	1.42	0.92	1.33	1.29	1.44
160ft	110mph	0.69	0.81	0.80	1.18	0.78	0.93	0.91	1.19	0.86	1.03	1.00	1.19
	130mph	0.73	0.93	0.90	1.27	0.83	1.07	1.03	1.29	0.90	1.18	1.14	1.30
	150mph	0.80	1.10	1.07	1.38	0.90	1.26	1.22	1.41	0.98	1.39	1.35	1.43
180ft	110mph	0.73	0.85	0.83	1.17	0.83	0.97	0.95	1.17	0.91	1.07	1.05	1.18
	130mph	0.77	0.97	0.94	1.25	0.87	1.11	1.07	1.27	0.95	1.22	1.18	1.29
	150mph	0.84	1.14	1.11	1.36	0.94	1.31	1.27	1.39	1.02	1.45	1.40	1.41
200ft	110mph	0.77	0.89	0.87	1.16	0.87	1.01	0.99	1.16	0.96	1.11	1.09	1.16
	130mph	0.81	1.01	0.98	1.24	0.91	1.14	1.11	1.25	1.00	1.26	1.22	1.27
	150mph	0.88	1.19	1.15	1.34	0.98	1.35	1.31	1.37	1.07	1.49	1.45	1.40
220ft	110mph	0.81	0.92	0.90	1.14	0.91	1.04	1.02	1.15	1.00	1.15	1.13	1.15
	130mph	0.85	1.04	1.01	1.23	0.95	1.18	1.15	1.24	1.04	1.30	1.26	1.25
	150mph	0.92	1.22	1.19	1.33	1.02	1.39	1.35	1.36	1.11	1.53	1.49	1.38
240ft	110mph	0.84	0.96	0.94	1.13	0.95	1.08	1.06	1.13	1.04	1.19	1.16	1.14
	130mph	0.89	1.08	1.05	1.21	0.99	1.22	1.18	1.22	1.08	1.33	1.29	1.24
	150mph	0.96	1.26	1.23	1.31	1.06	1.43	1.38	1.34	1.15	1.57	1.52	1.36

Note – The “Ratio” column is the 45 degree wind angle pole moment CSR ratio / 90 degree wind angle pole moment CSR ratio.

Table 12 – GTStrudl Pole Base Moment CSR Ratio Excerpt with 3 Headed, Aluminum Traffic Signals, with Backplates

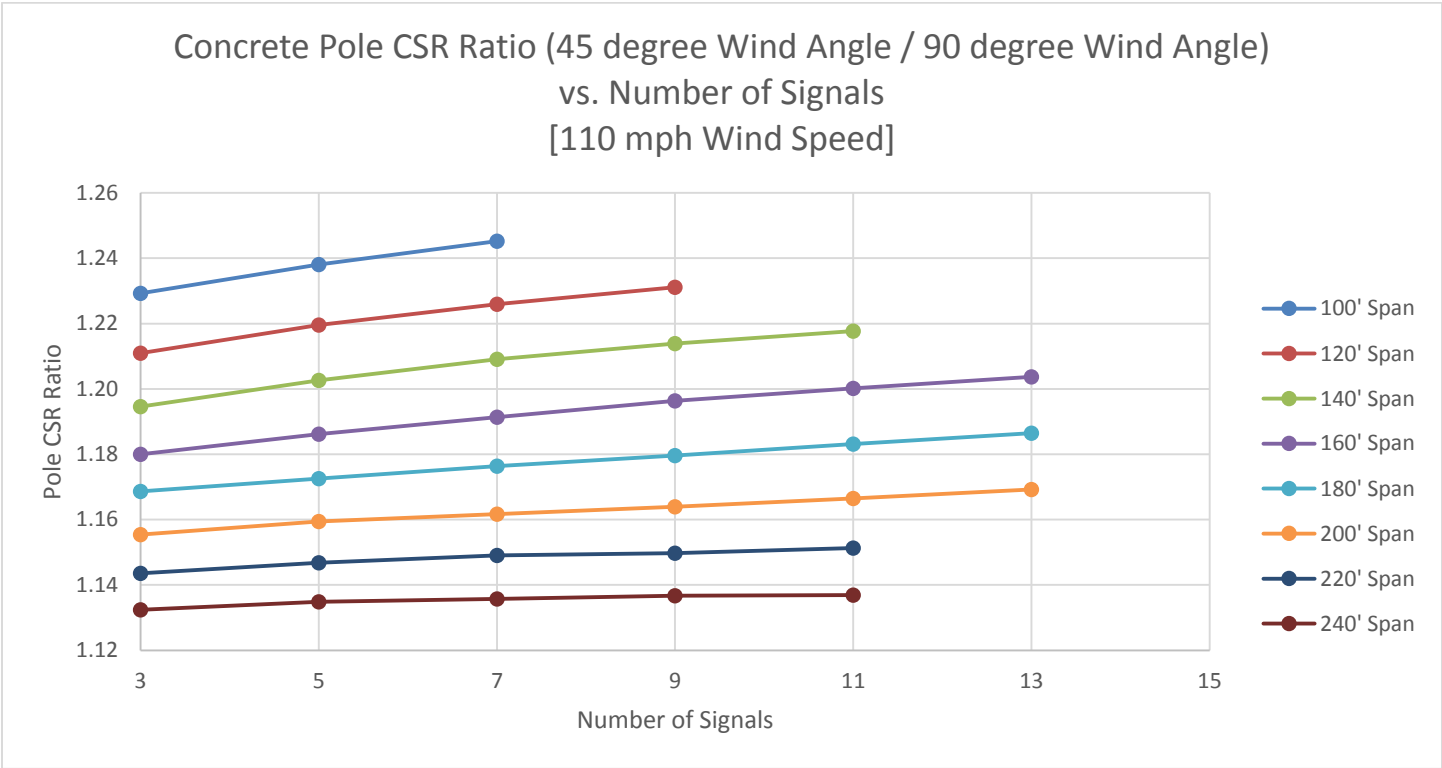

Figure 53 – GTStrudl Pole Base Moment CSR Ratio with 3 Headed, Aluminum Traffic Signals with Backplates, 110 mph Wind Speed

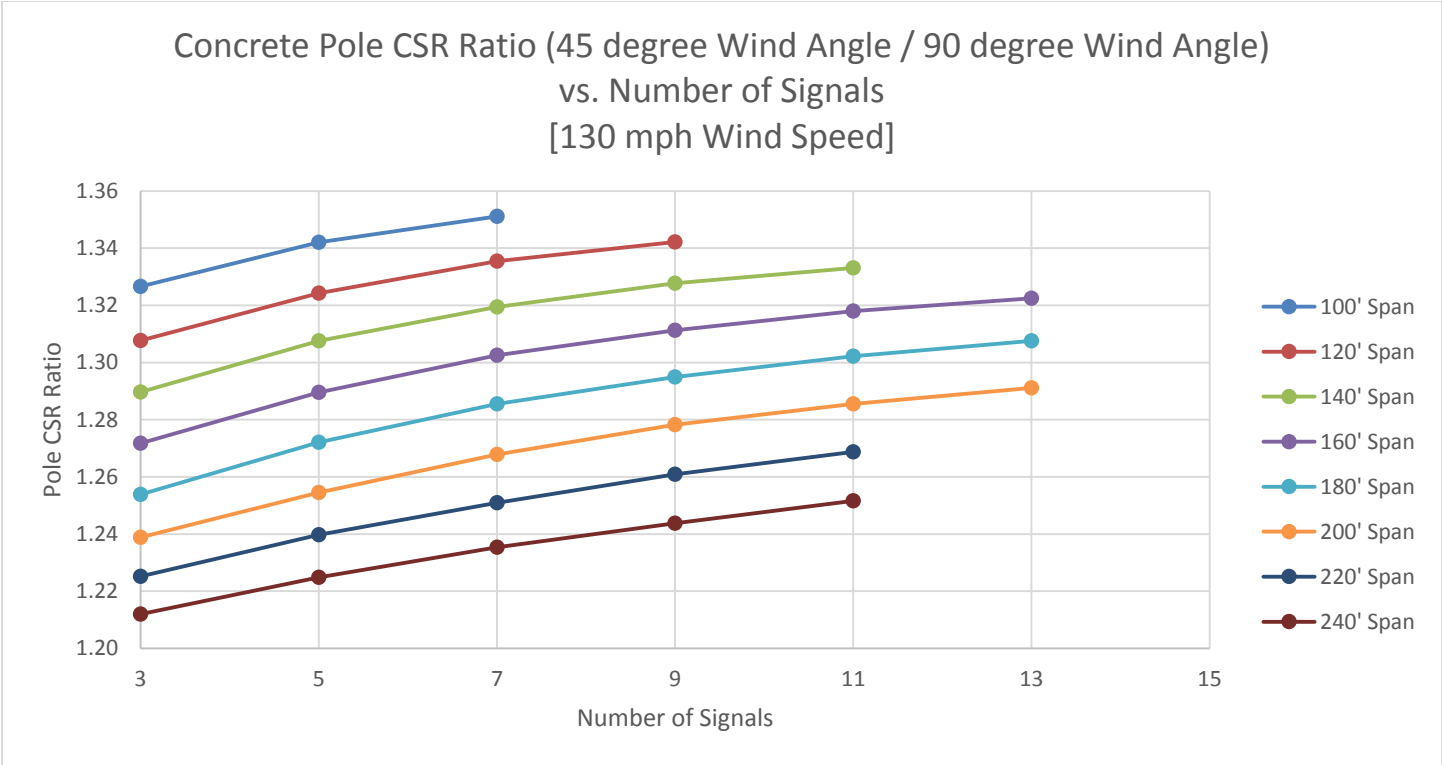

Figure 54 – GTStrudl Pole Base Moment CSR Ratio with 3 Headed, Aluminum Traffic Signals with Backplates, 130 mph Wind Speed

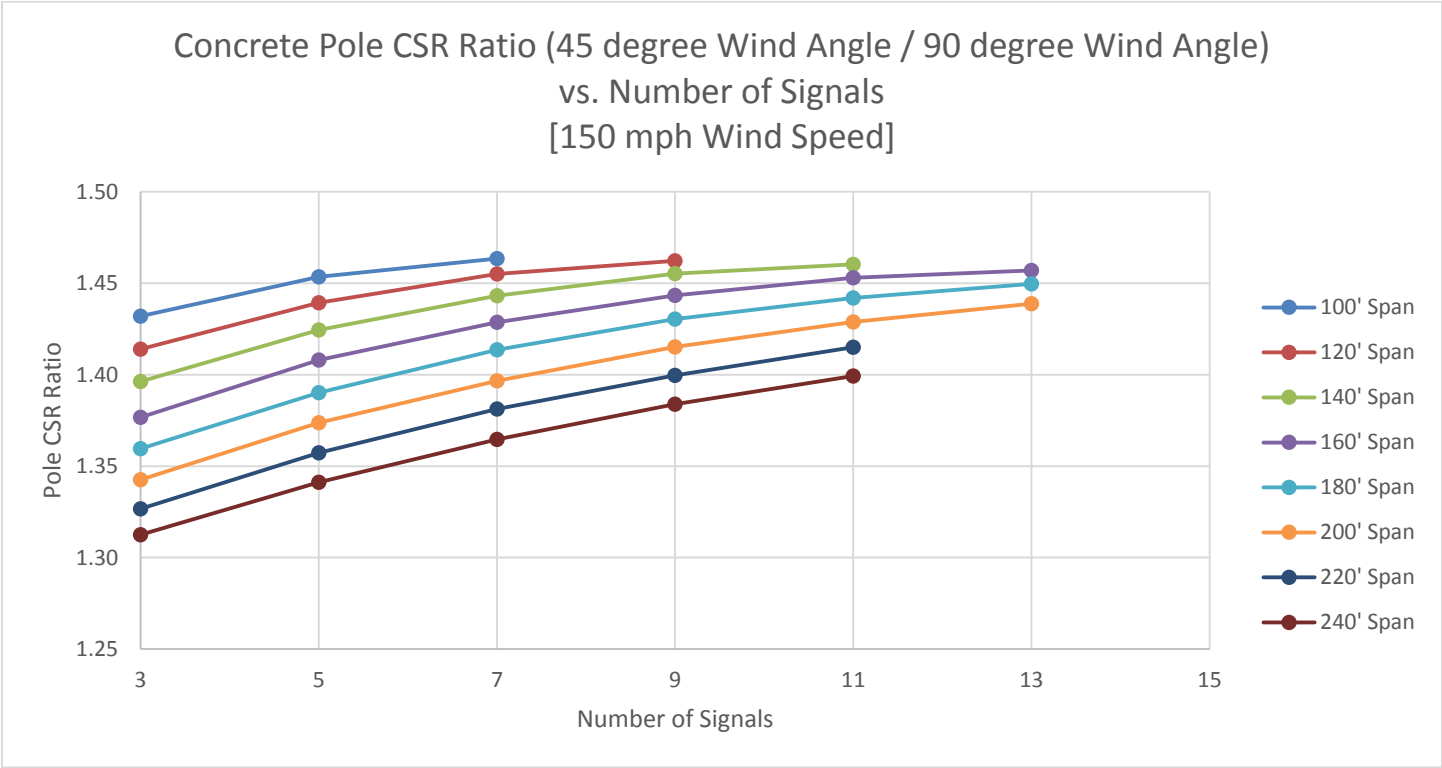

Figure 55 – GTStrudl Pole Base Moment CSR Ratio with 3 Headed, Aluminum Traffic Signals with Backplates, 150 mph Wind Speed

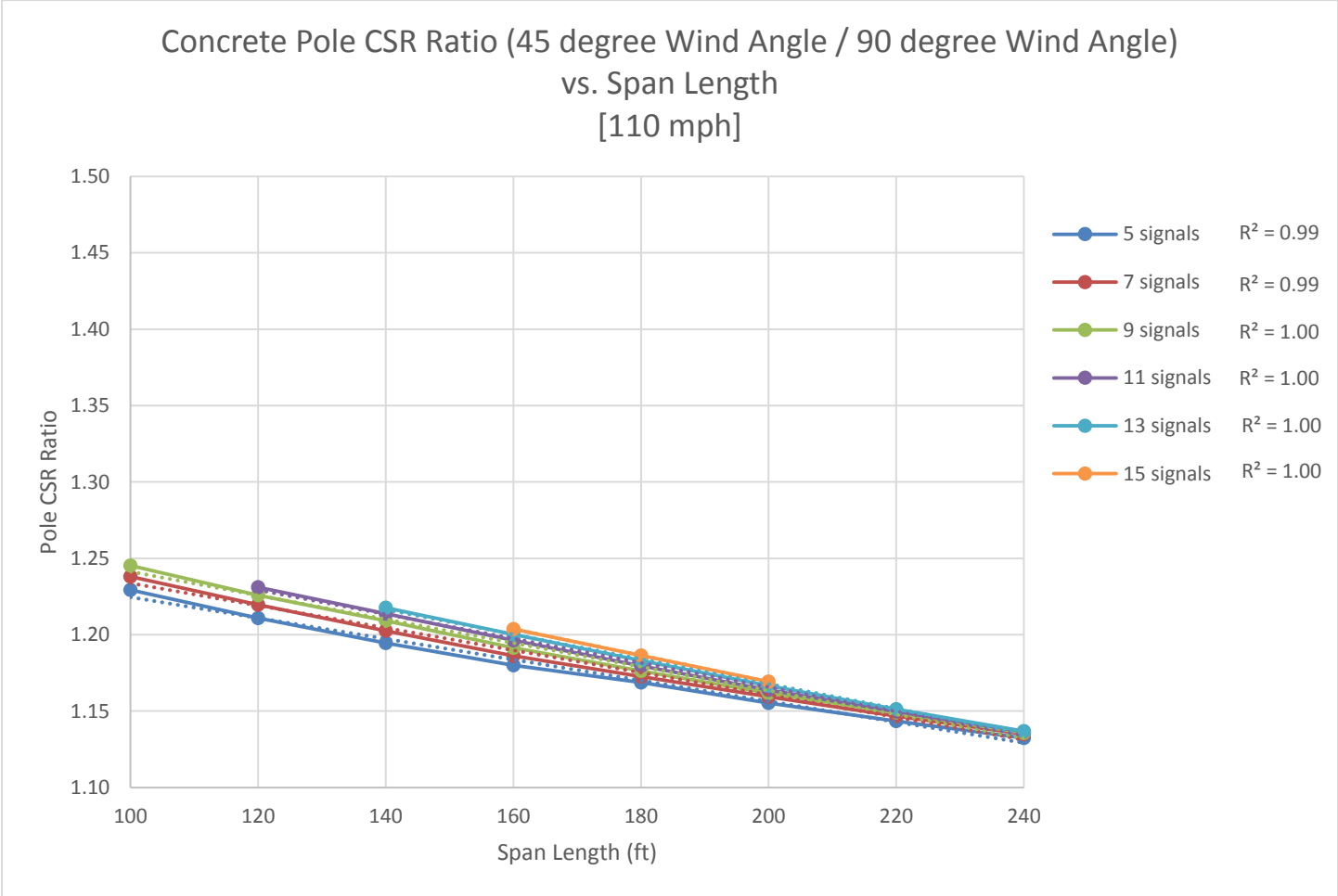

Figure 56 – GTStrudl Pole Base Moment CSR Ratio with 3 Headed, Aluminum Traffic Signals with Backplates, 110 mph Wind Speed

Concrete Pole CSR Ratio (45 degree Wind Angle / 90 degree Wind Angle)
vs. Span Length
[130 mph]

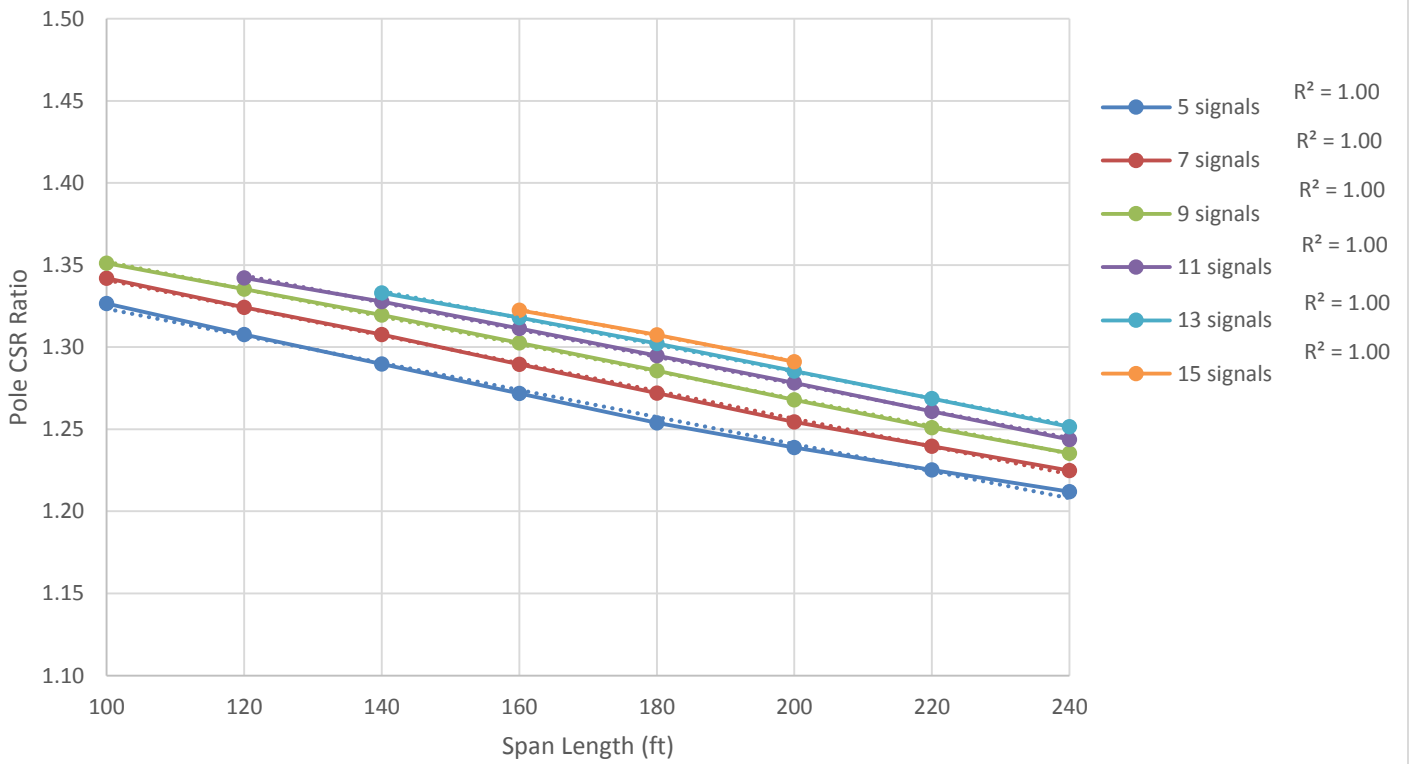

Figure 57 – GTStrudl Pole Base Moment CSR Ratio with 3 Headed, Aluminum Traffic Signals with Backplates, 130 mph Wind Speed

Concrete Pole CSR Ratio (45 degree Wind Angle / 90 degree Wind Angle)
vs. Span Length
[150 mph]

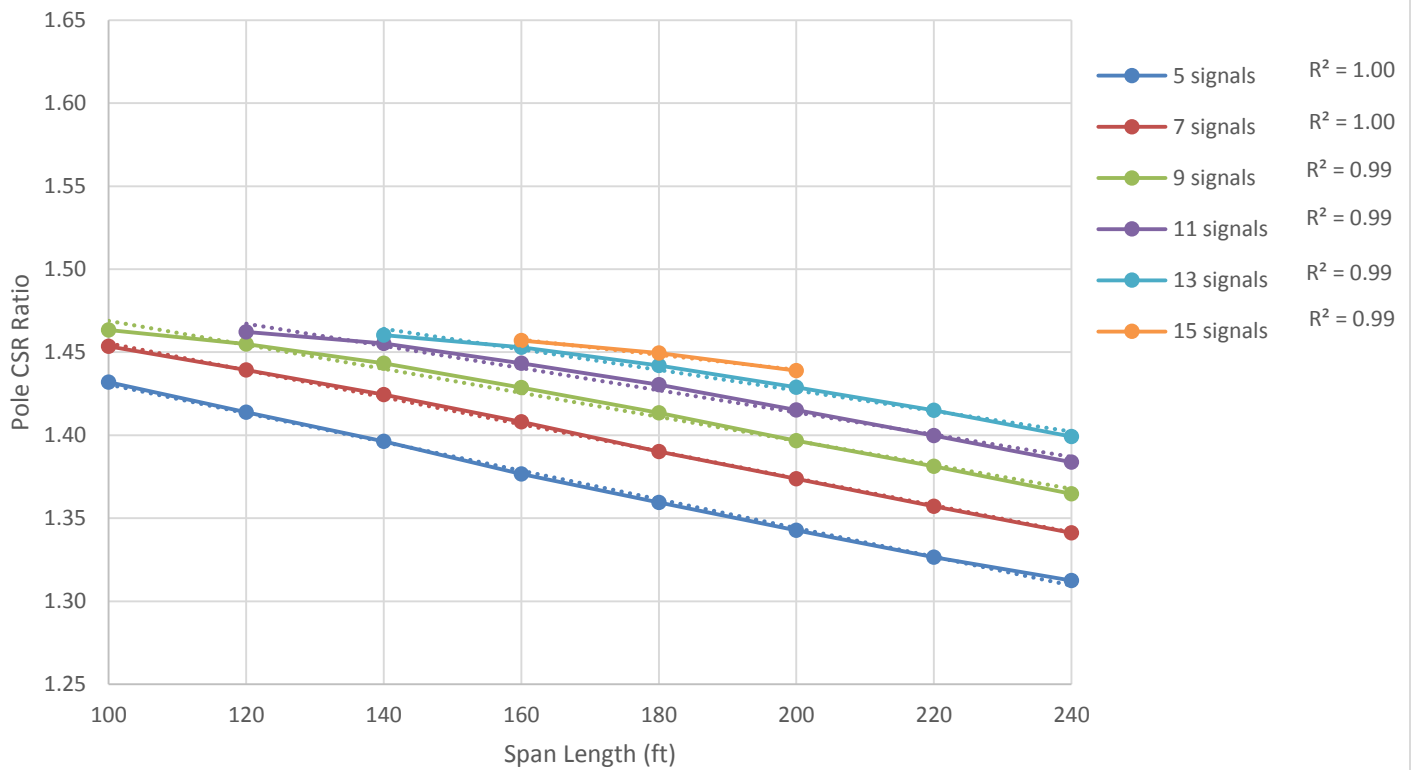

Figure 58 – GTStrudl Pole Base Moment CSR Ratio with 3 Headed, Aluminum Traffic Signals with Backplates, 150 mph Wind Speed

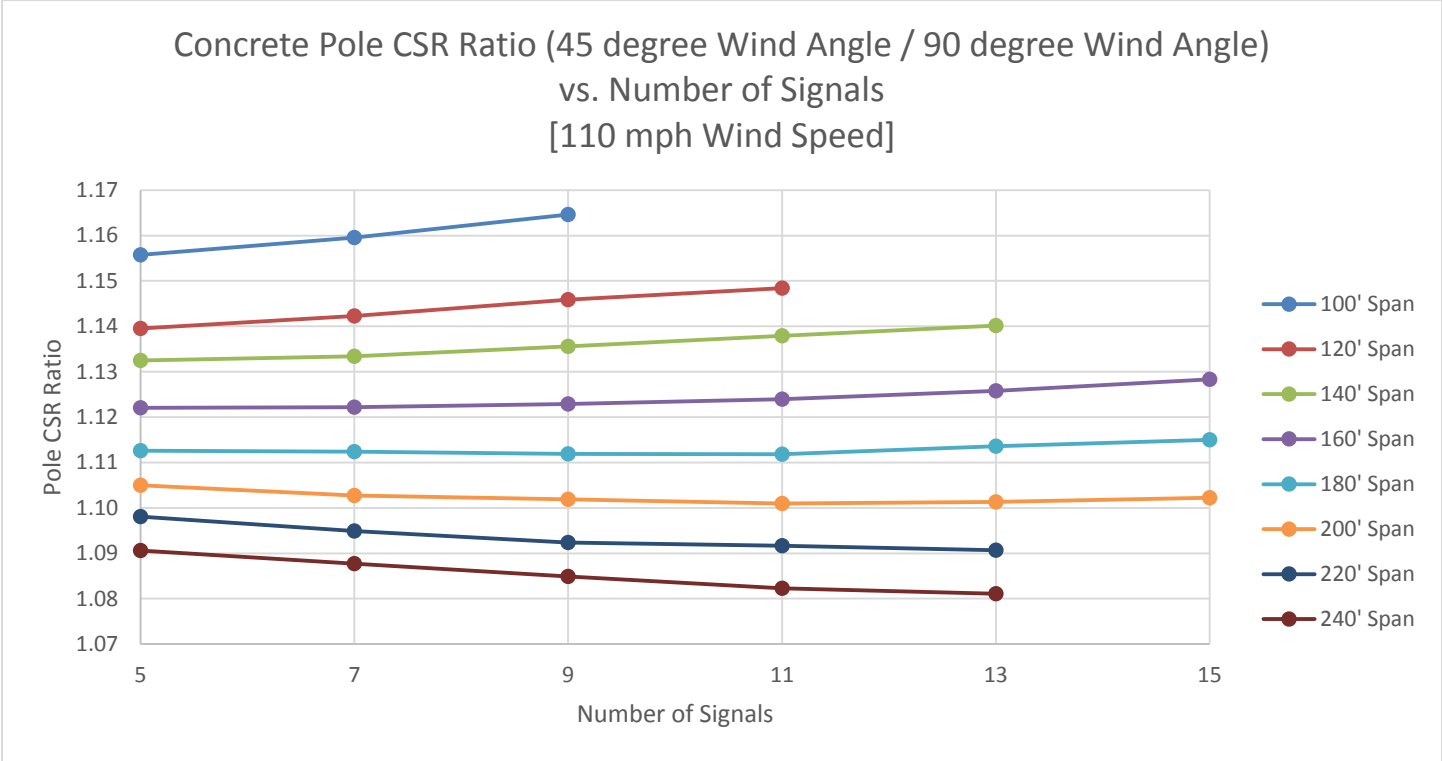

Figure 59 – GTStrudl Pole Base Moment CSR Ratio with 3 Headed, Aluminum Traffic Signals without Backplates, 110 mph Wind Speed

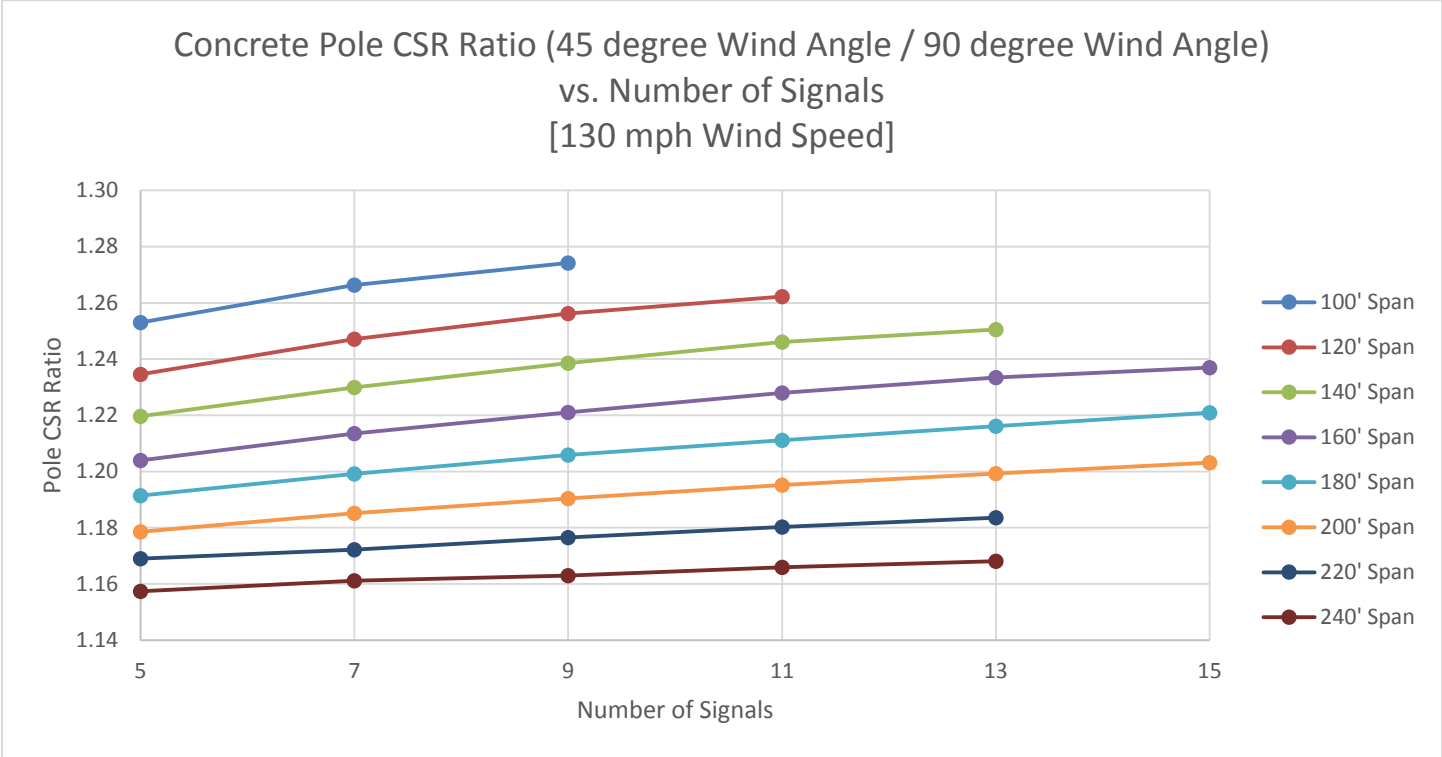

Figure 60 – GTStrudl Pole Base Moment CSR Ratio with 3 Headed, Aluminum Traffic Signals without Backplates, 130 mph Wind Speed

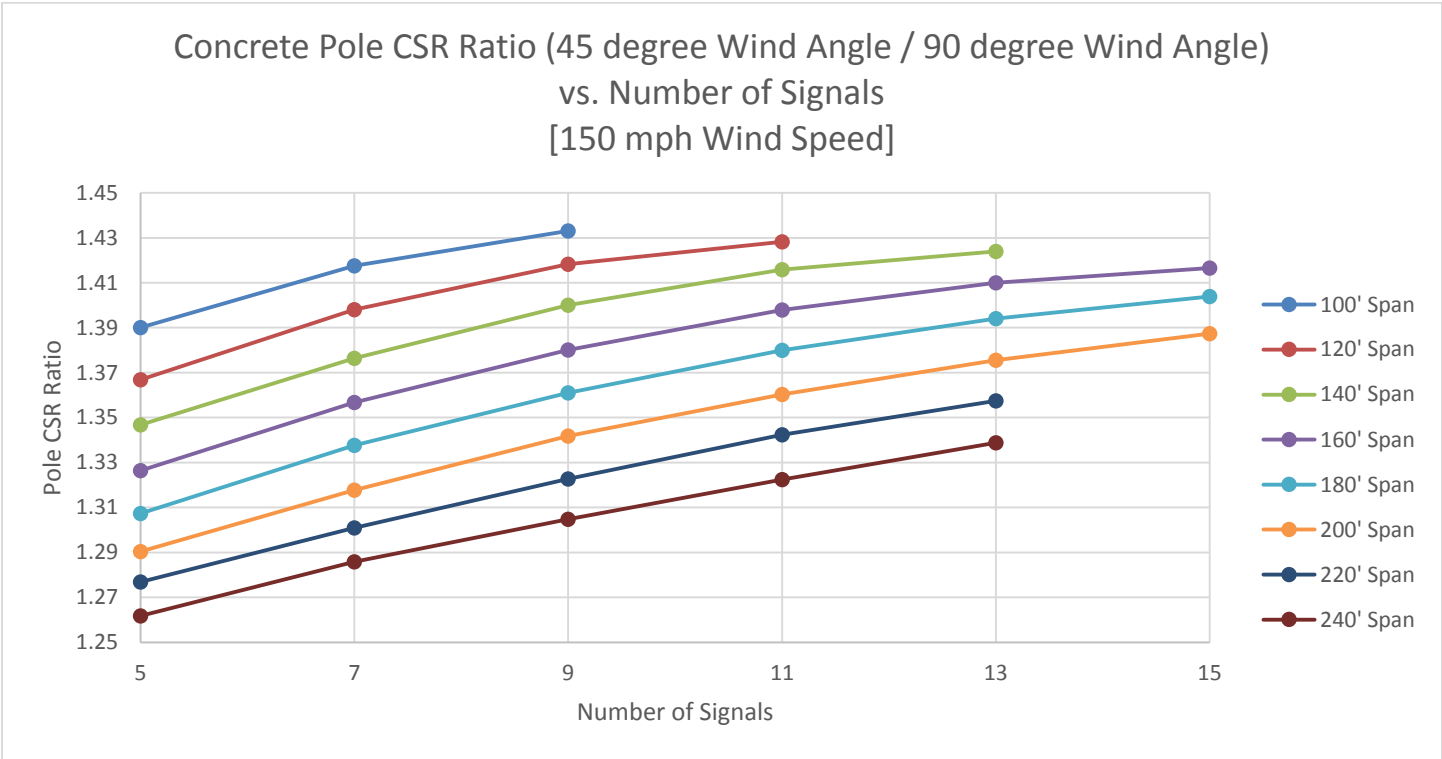

Figure 61 – GTStrudl Pole Base Moment CSR Ratio with 3 Headed, Aluminum Traffic Signals without Backplates, 150 mph Wind Speed

Concrete Pole CSR Ratio (45 degree Wind Angle / 90 degree Wind Angle)
vs. Span Length
[110 mph]

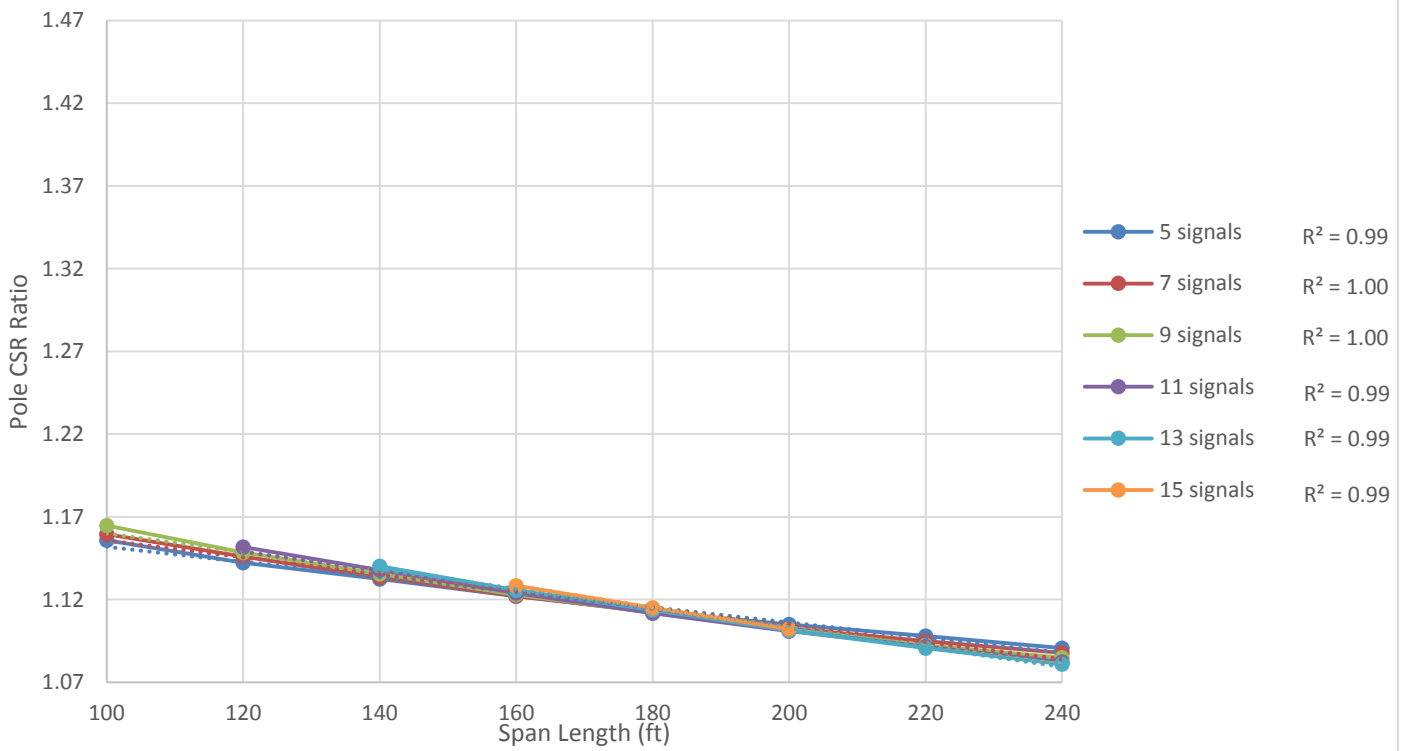

Figure 62 – GTStrudl Pole Base Moment CSR Ratio with 3 Headed, Aluminum Traffic Signals without Backplates, 110 mph Wind Speed

Concrete Pole CSR Ratio (45 degree Wind Angle / 90 degree Wind Angle)
vs. Span Length
[130 mph]

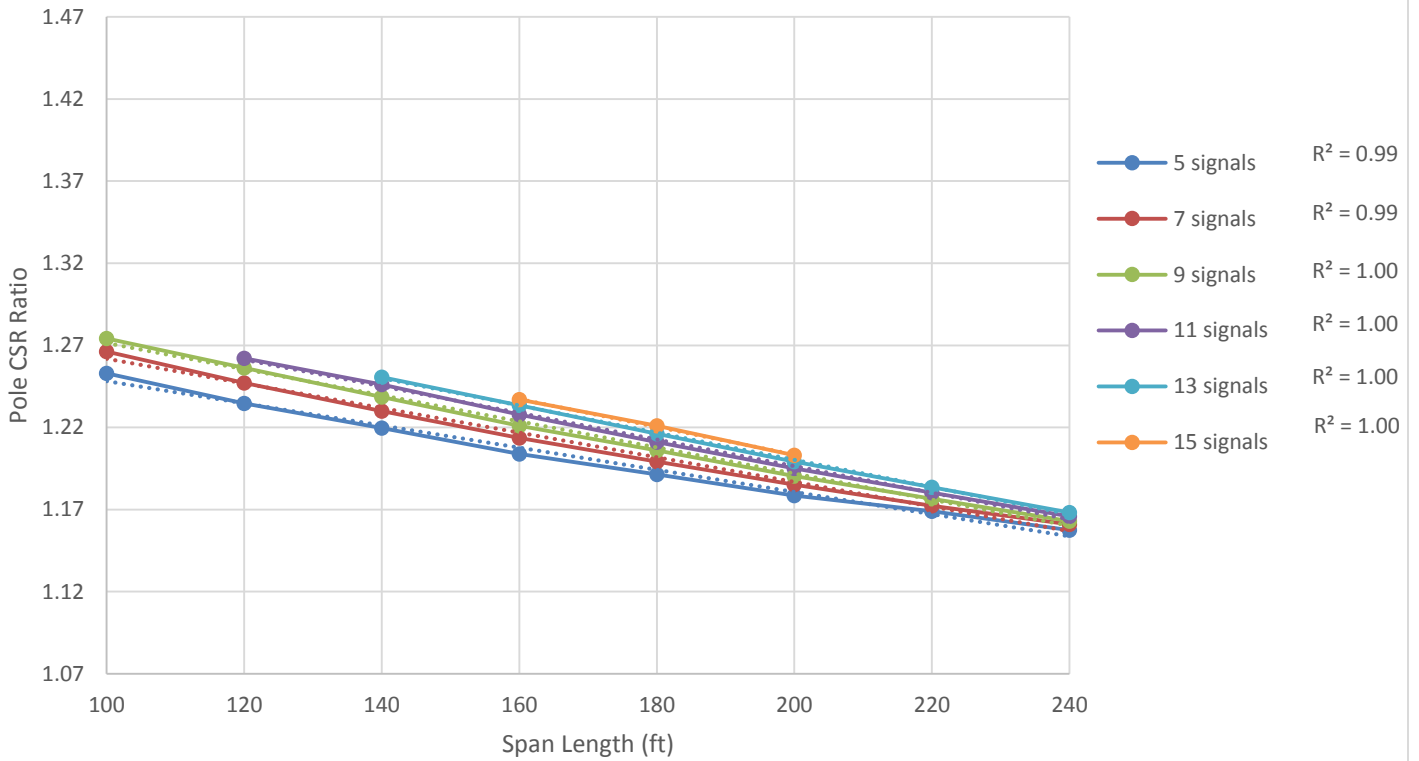

Figure 63 – GTStrudl Pole Base Moment CSR Ratio with 3 Headed, Aluminum Traffic Signals without Backplates, 130 mph Wind Speed

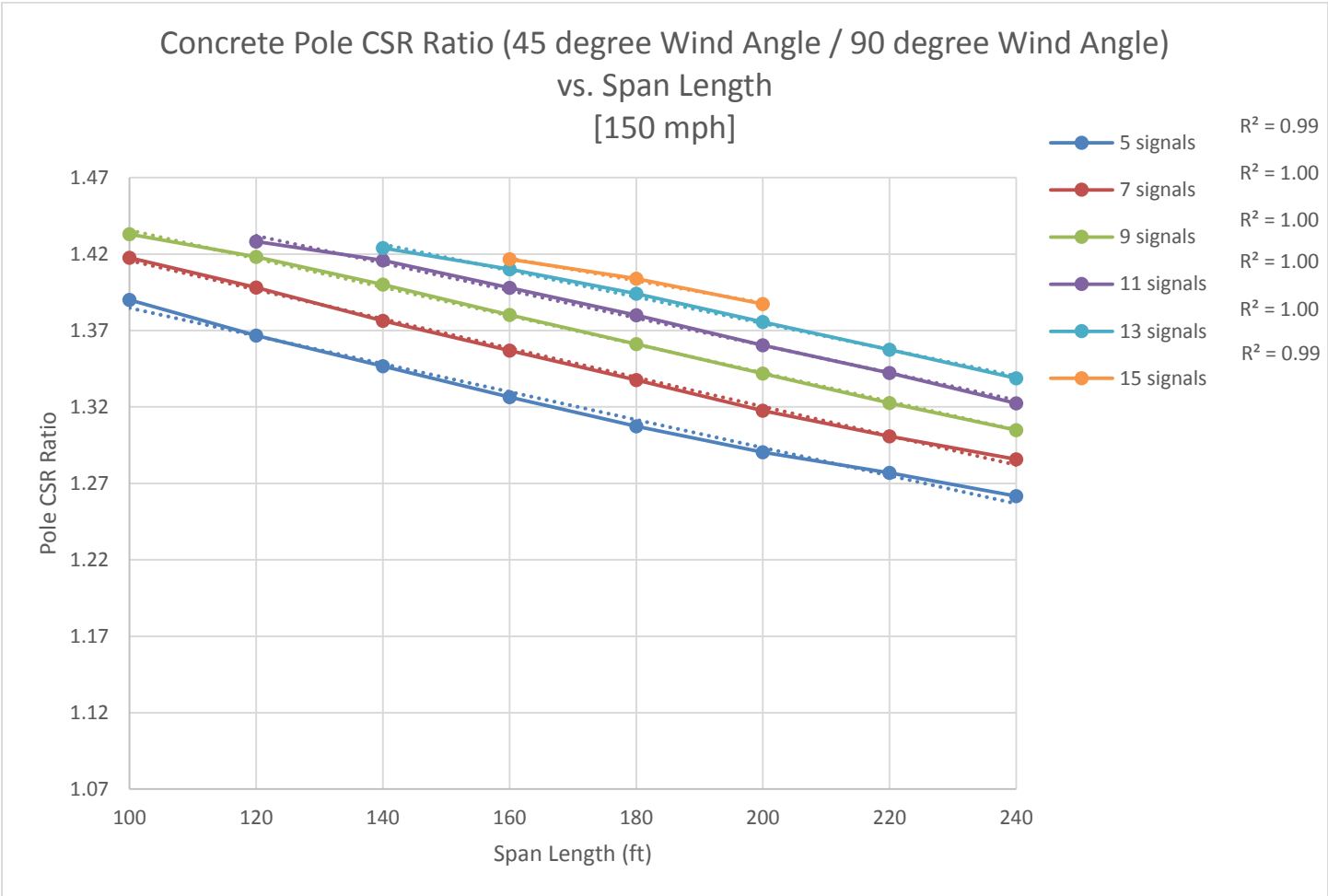

Figure 64 – GTStrudl Pole Base Moment CSR Ratio with 3 Headed, Aluminum Traffic Signals without Backplates, 150 mph Wind Speed

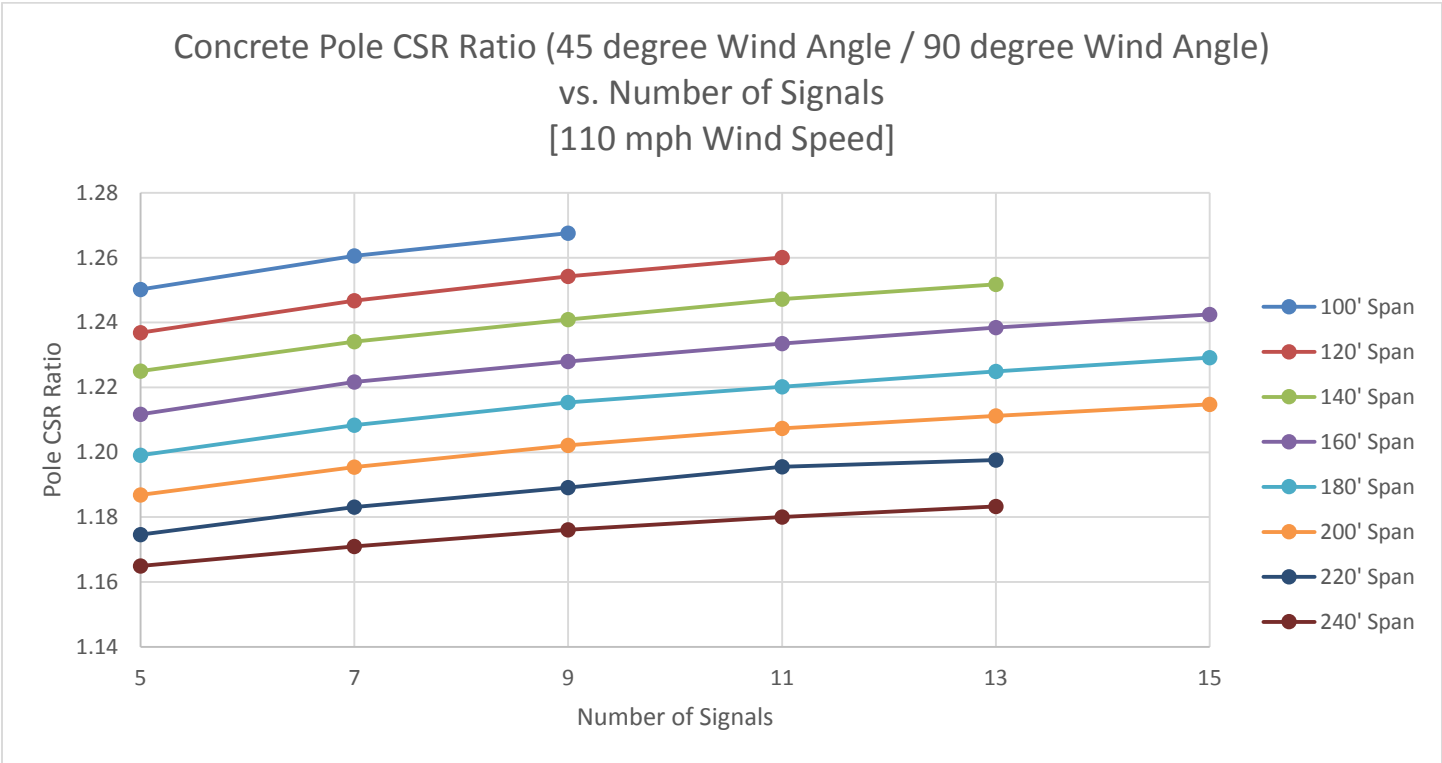

Figure 65 – GTStrudl Pole Base Moment CSR Ratio with 5 Headed, Aluminum Traffic Signals with Backplates, 110 mph Wind Speed

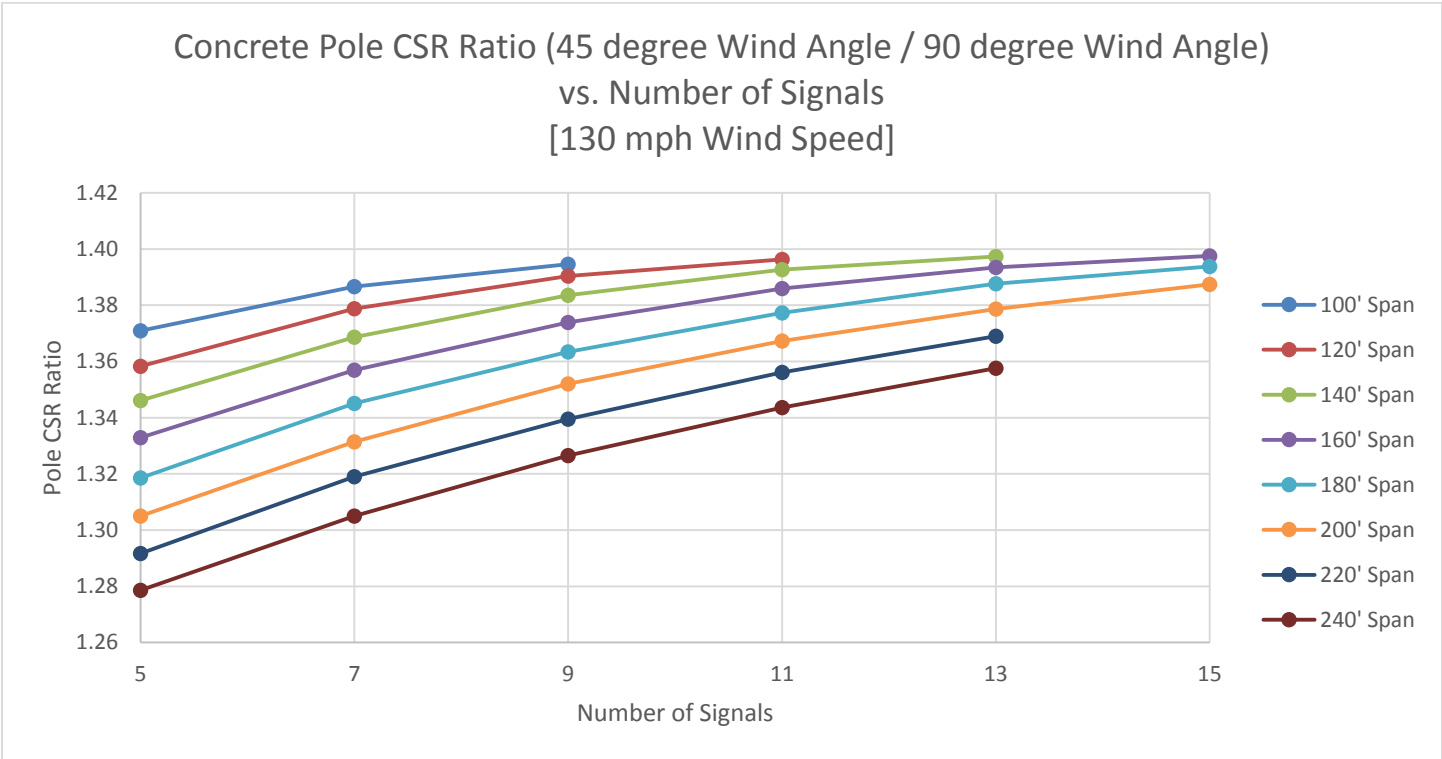

Figure 66 – GTStrudl Pole Base Moment CSR Ratio with 5 Headed, Aluminum Traffic Signals with Backplates, 130 mph Wind Speed

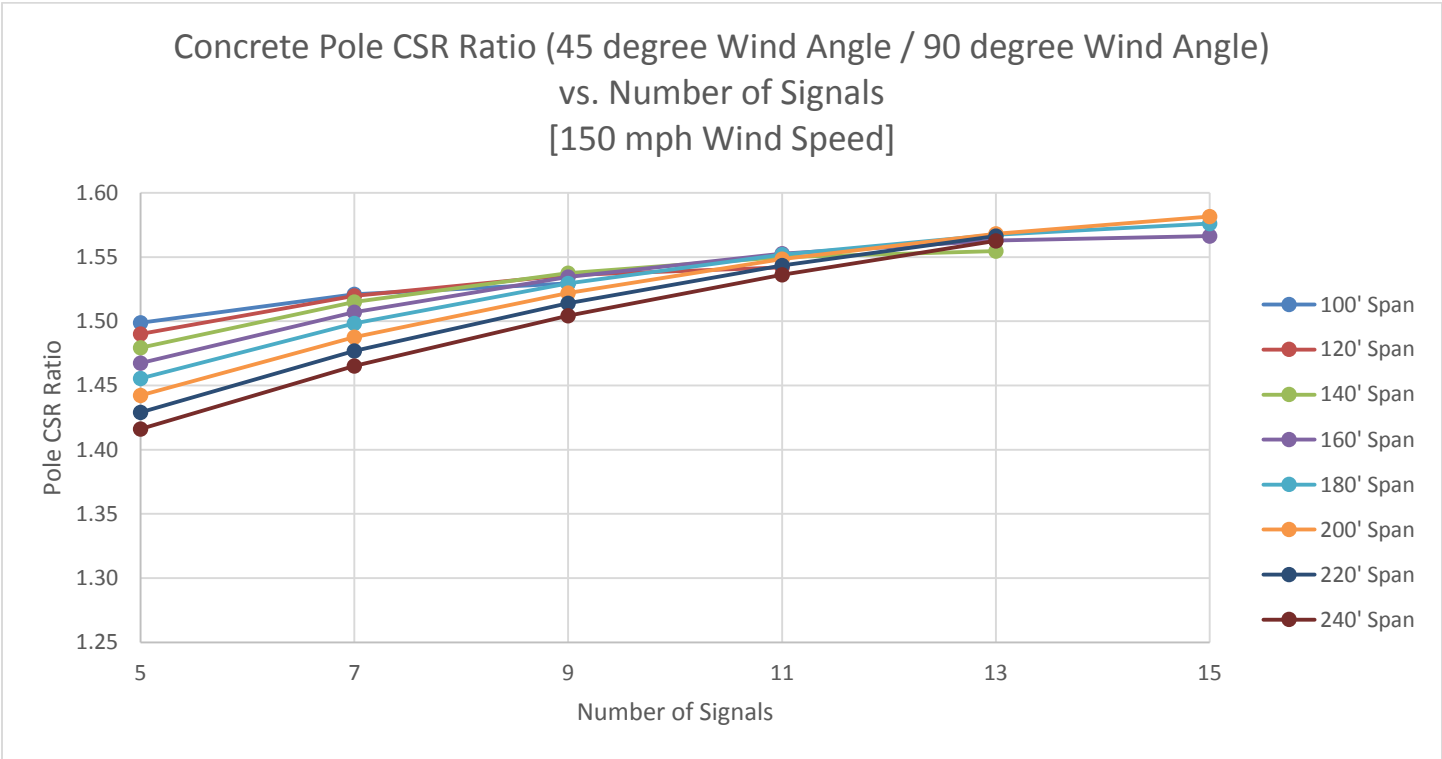

Figure 67 – GTStrudl Pole Base Moment CSR Ratio with 5 Headed, Aluminum Traffic Signals with Backplates, 150 mph Wind Speed

Concrete Pole CSR Ratio (45 degree Wind Angle / 90 degree Wind Angle)
vs. Span Length
[110 mph]

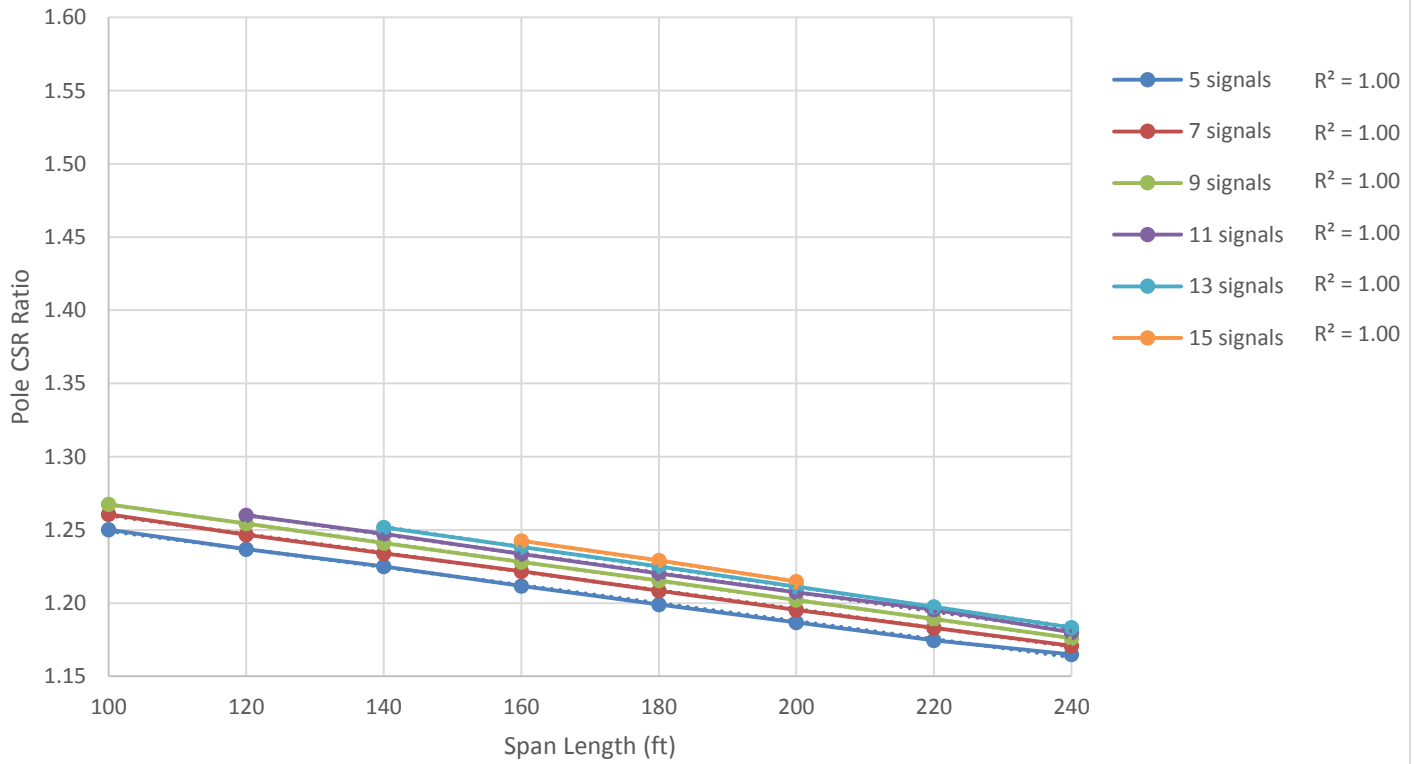

Figure 68 – GTStrudl Pole Base Moment CSR Ratio with 5 Headed, Aluminum Traffic Signals with Backplates, 110 mph Wind Speed

Concrete Pole CSR Ratio (45 degree Wind Angle / 90 degree Wind Angle)
vs. Span Length
[130 mph]

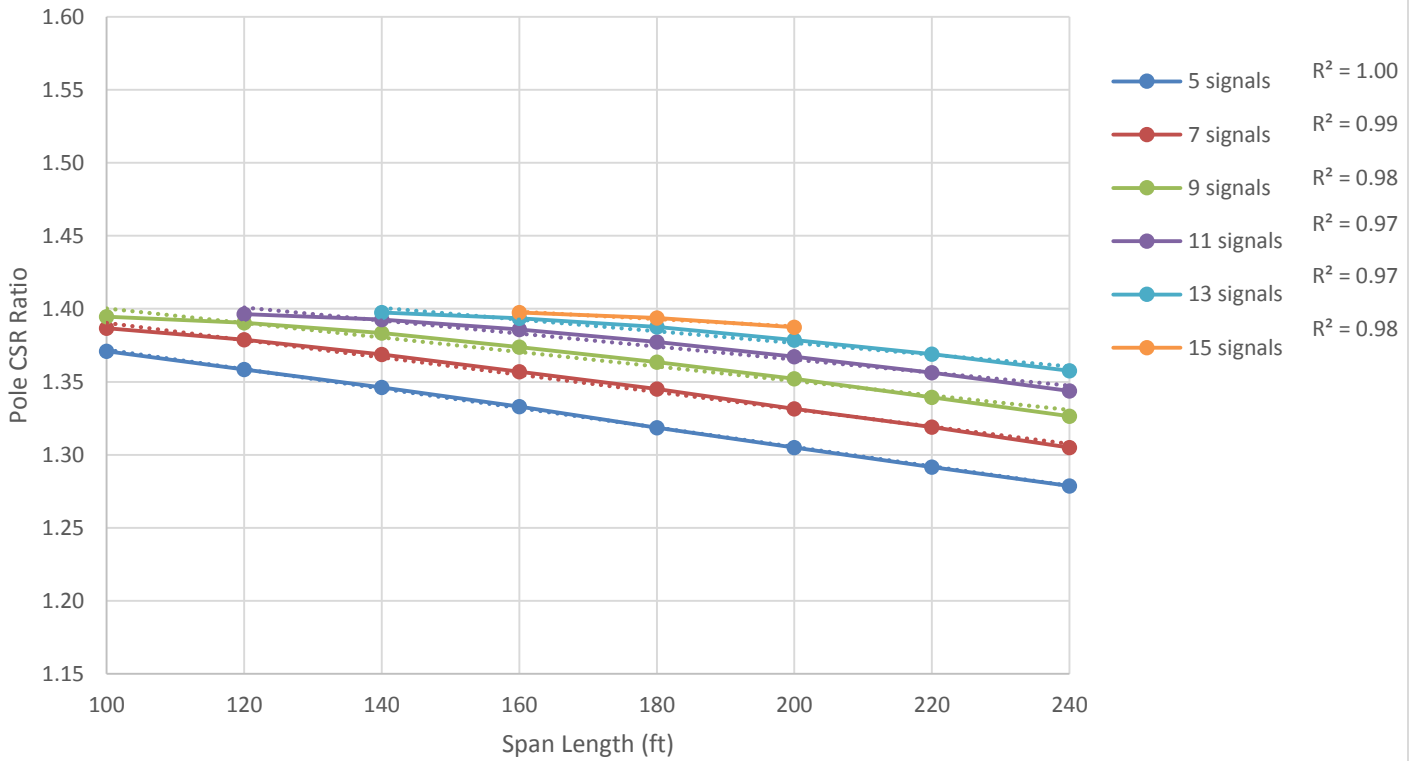

Figure 69 – GTStrudl Pole Base Moment CSR Ratio with 5 Headed, Aluminum Traffic Signals with Backplates, 130 mph Wind Speed

Concrete Pole CSR Ratio (45 degree Wind Angle / 90 degree Wind Angle)
vs. Span Length
[150 mph]

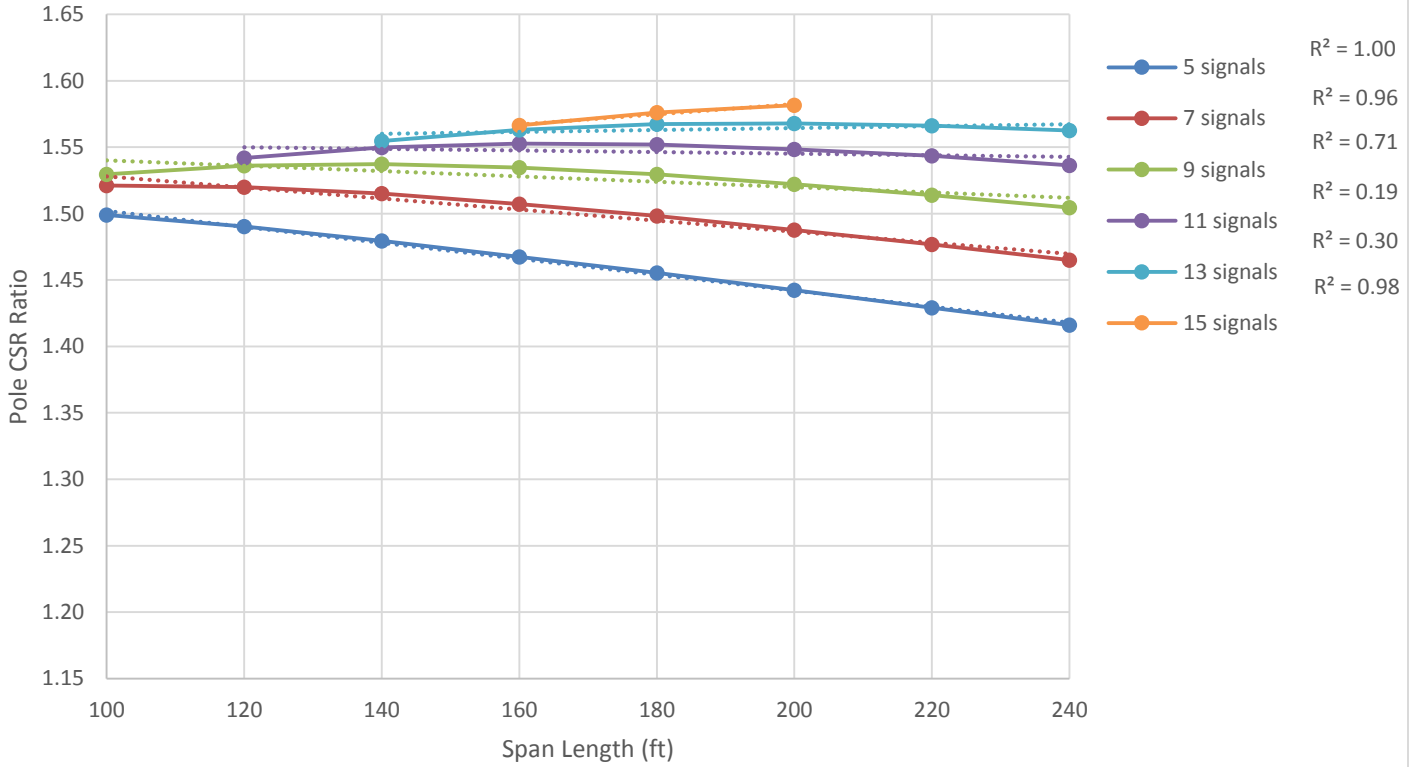

Figure 70 – GTStrudl Pole Base Moment CSR Ratio with 5 Headed, Aluminum Traffic Signals with Backplates, 150 mph Wind Speed

3 Headed Aluminum With Backplate							
Span	Wind Speed	5 Signals	7 Signals	9 Signals	11 Signals	13 Signals	15 Signals
100ft	110mph	0.00	0.00	0.00			
	130mph	0.00	0.00	0.00			
	150mph	0.00	0.00	0.00			
120ft	110mph	0.00	0.00	0.00	0.00		
	130mph	0.00	0.00	0.00	0.00		
	150mph	0.00	0.00	0.00	0.00		
140ft	110mph	0.00	0.00	0.00	0.00	0.00	
	130mph	0.00	0.00	0.00	0.00	0.00	
	150mph	0.00	0.00	0.00	0.00	0.00	
160ft	110mph	0.00	0.00	0.00	0.00	0.00	0.00
	130mph	0.00	0.00	0.00	0.00	0.00	0.00
	150mph	0.00	0.00	0.00	0.00	0.00	0.00
180ft	110mph	0.00	0.00	0.00	0.00	0.00	0.00
	130mph	0.00	0.00	0.00	0.00	0.00	0.00
	150mph	0.00	0.00	0.00	0.00	0.00	0.00
200ft	110mph	0.00	0.00	0.00	0.00	0.00	0.00
	130mph	0.00	0.00	0.00	0.00	0.00	0.00
	150mph	0.00	0.00	0.00	0.00	0.00	0.00
220ft	110mph	0.00	0.00	0.00	0.00	0.00	
	130mph	0.00	0.00	0.00	0.00	0.00	
	150mph	0.00	0.00	0.00	0.00	0.00	
240ft	110mph	0.00	0.00	0.00	0.00	0.00	
	130mph	0.00	0.00	0.00	0.00	0.00	
	150mph	0.00	0.00	0.00	0.00	0.00	

Table 13 – GTS: Maximum Cable Tension Box Span – Maximum Cable Tension Single Span with 3 Headed, Aluminum Traffic Signals with Backplates

3 Headed Aluminum Without Backplate							
Span	Wind Speed	5 Signals	7 Signals	9 Signals	11 Signals	13 Signals	15 Signals
100ft	110mph	0.00	0.00	0.00			
	130mph	0.00	0.00	0.00			
	150mph	0.00	0.00	0.00			
120ft	110mph	0.00	0.00	0.00	0.00		
	130mph	0.00	0.00	0.00	0.00		
	150mph	0.00	0.00	0.00	0.00		
140ft	110mph	0.00	0.00	0.00	0.00	0.00	
	130mph	0.00	0.00	0.00	0.00	0.00	
	150mph	0.00	0.00	0.00	0.00	0.00	
160ft	110mph	0.00	0.00	0.00	0.00	0.00	0.00
	130mph	0.00	0.00	0.00	0.00	0.00	0.00
	150mph	0.00	0.00	0.00	0.00	0.00	0.00
180ft	110mph	0.00	0.00	0.00	0.00	0.00	0.00
	130mph	0.00	0.00	0.00	0.00	0.00	0.00
	150mph	0.00	0.00	0.00	0.00	0.00	0.00
200ft	110mph	0.00	0.00	0.00	0.00	0.00	0.00
	130mph	0.00	0.00	0.00	0.00	0.00	0.00
	150mph	0.00	0.00	0.00	0.00	0.00	0.00
220ft	110mph	0.00	0.00	0.00	0.00	0.00	
	130mph	0.00	0.00	0.00	0.00	0.00	
	150mph	0.00	0.00	0.00	0.00	0.00	
240ft	110mph	0.00	0.00	0.00	0.00	0.00	
	130mph	0.00	0.00	0.00	0.00	0.00	
	150mph	0.00	0.00	0.00	0.00	0.00	

Table 14 – GTS: Maximum Cable Tension Box Span – Maximum Cable Tension Single Span with 3 Headed, Aluminum Traffic Signals without Backplates











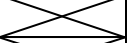
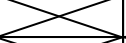
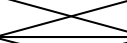
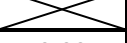
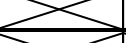
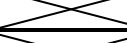

5 Headed Aluminum With Backplate							
Span	Wind Speed	5 Signals	7 Signals	9 Signals	11 Signals	13 Signals	15 Signals
100ft	110mph	0.00	0.00	0.00			
	130mph	0.00	0.00	0.00			
	150mph	0.00	0.00	0.00			
120ft	110mph	0.00	0.00	0.00	0.00		
	130mph	0.00	0.00	0.00	0.00		
	150mph	0.00	0.00	0.00	0.00		
140ft	110mph	0.00	0.00	0.00	0.00	0.00	
	130mph	0.00	0.00	0.00	0.00	0.00	
	150mph	0.00	0.00	0.00	0.00	0.00	
160ft	110mph	0.00	0.00	0.00	0.00	0.00	0.00
	130mph	0.00	0.00	0.00	0.00	0.00	0.00
	150mph	0.00	0.00	0.00	0.00	0.00	0.00
180ft	110mph	0.00	0.00	0.00	0.00	0.00	0.00
	130mph	0.00	0.00	0.00	0.00	0.00	0.00
	150mph	0.00	0.00	0.00	0.00	0.00	0.00
200ft	110mph	0.00	0.00	0.00	0.00	0.00	0.00
	130mph	0.00	0.00	0.00	0.00	0.00	0.00
	150mph	0.00	0.00	0.00	0.00	0.00	0.00
220ft	110mph	0.00	0.00	0.00	0.00	0.00	
	130mph	0.00	0.00	0.00	0.00	0.00	
	150mph	0.00	0.00	0.00	0.00	0.00	
240ft	110mph	0.00	0.00	0.00	0.00	0.00	
	130mph	0.00	0.00	0.00	0.00	0.00	
	150mph	0.00	0.00	0.00	0.00	0.00	

Table 15 – GTS: Maximum Cable Tension Box Span – Maximum Cable Tension Single Span with 5 Headed, Aluminum Traffic Signals with Backplates

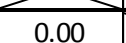
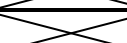
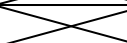
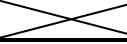
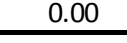
Span	Wind Speed	5 Signals			7 Signals			9 Signals		
		90 deg	15 deg	30 deg	90 deg	15 deg	30 deg	90 deg	15 deg	30 deg
100ft	110mph	0.55	0.63	0.70	0.62	0.71	0.80	0.67	0.76	0.85
	130mph	0.59	0.66	0.75	0.67	0.75	0.85	0.71	0.80	0.91
	150mph	0.65	0.74	0.85	0.73	0.84	0.97	0.78	0.90	1.03
120ft	110mph	0.60	0.68	0.76	0.68	0.78	0.87	0.74	0.84	0.95
	130mph	0.64	0.72	0.81	0.73	0.81	0.92	0.79	0.89	1.00
	150mph	0.71	0.79	0.92	0.79	0.91	1.04	0.86	0.99	1.14
140ft	110mph	0.65	0.73	0.81	0.74	0.83	0.93	0.81	0.91	1.02
	130mph	0.69	0.77	0.86	0.78	0.87	0.99	0.85	0.95	1.08
	150mph	0.75	0.84	0.97	0.85	0.96	1.11	0.92	1.05	1.21
160ft	110mph	0.69	0.77	0.86	0.78	0.88	0.99	0.86	0.97	1.09
	130mph	0.73	0.81	0.91	0.83	0.92	1.04	0.90	1.01	1.14
	150mph	0.80	0.89	1.02	0.90	1.01	1.16	0.98	1.11	1.28
180ft	110mph	0.73	0.81	0.90	0.83	0.93	1.04	0.91	1.03	1.15
	130mph	0.77	0.86	0.96	0.87	0.97	1.09	0.95	1.07	1.20
	150mph	0.84	0.93	1.07	0.94	1.05	1.21	1.02	1.15	1.33
200ft	110mph	0.77	0.85	0.95	0.87	0.98	1.08	0.96	1.08	1.20
	130mph	0.81	0.90	1.00	0.91	1.02	1.14	1.00	1.11	1.25
	150mph	0.88	0.97	1.11	0.98	1.09	1.26	1.07	1.20	1.38
220ft	110mph	0.81	0.89	0.99	0.91	1.02	1.13	1.00	1.13	1.25
	130mph	0.85	0.94	1.05	0.95	1.06	1.18	1.04	1.16	1.30
	150mph	0.92	1.02	1.16	1.02	1.14	1.31	1.11	1.24	1.43
240ft	110mph	0.84	0.93	1.03	0.95	1.06	1.17	1.04	1.17	1.30
	130mph	0.89	0.98	1.09	0.99	1.10	1.23	1.08	1.21	1.35
	150mph	0.96	1.06	1.20	1.06	1.18	1.35	1.15	1.28	1.48

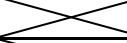
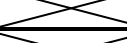
Table 16 – GTS: Excerpt of Concrete Pole Moment Ratio for Skewed and Non-Skewed Box Span Configurations, with Backplates

Concrete Pole CSR Ratio (30 degree Wind Angle / 30 degree Box Skew)
vs. Span Length
[110 mph]

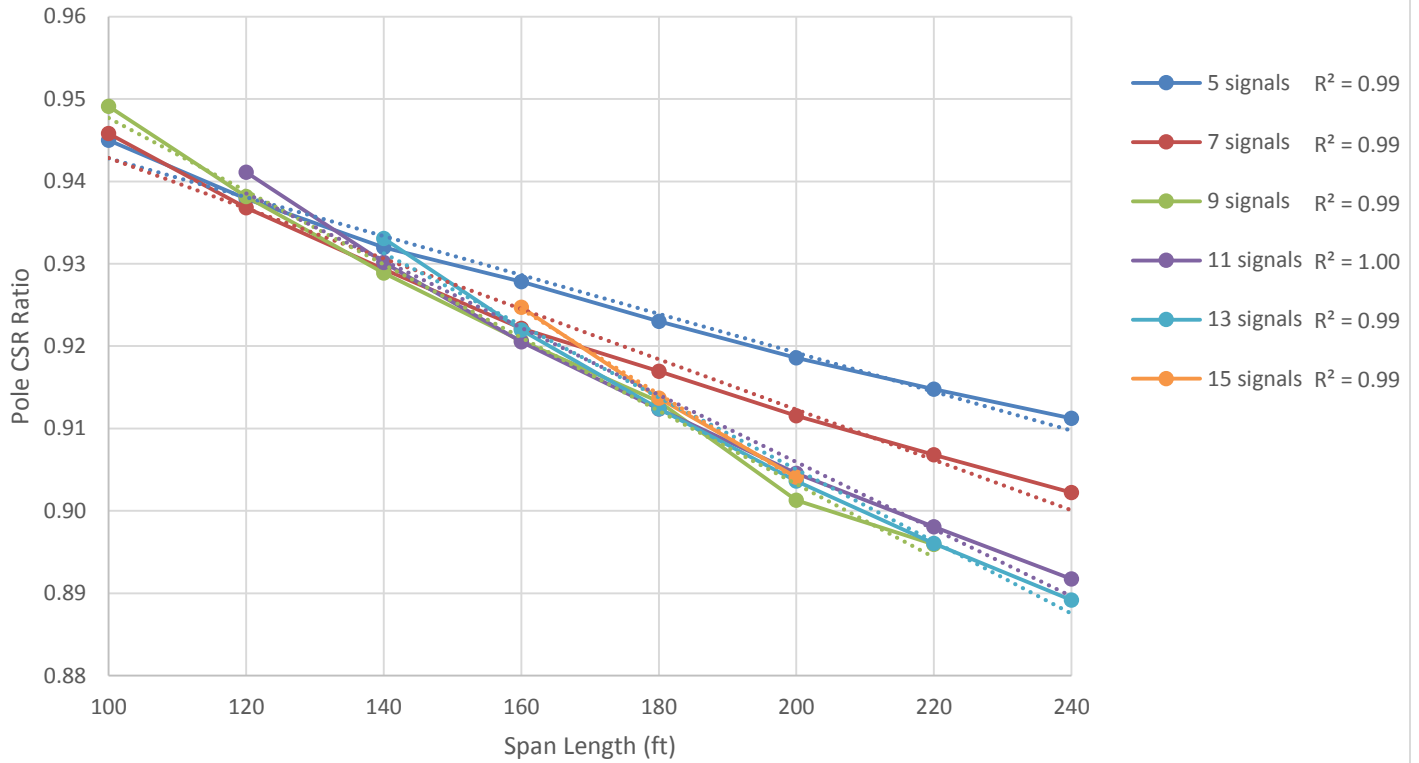

Figure 71 – GTS: Concrete Pole CSR Ratio (30 degree Wind Angle / 30 degree Box Skew) vs. Span Length, 110 mph Wind Speed , with Backplates

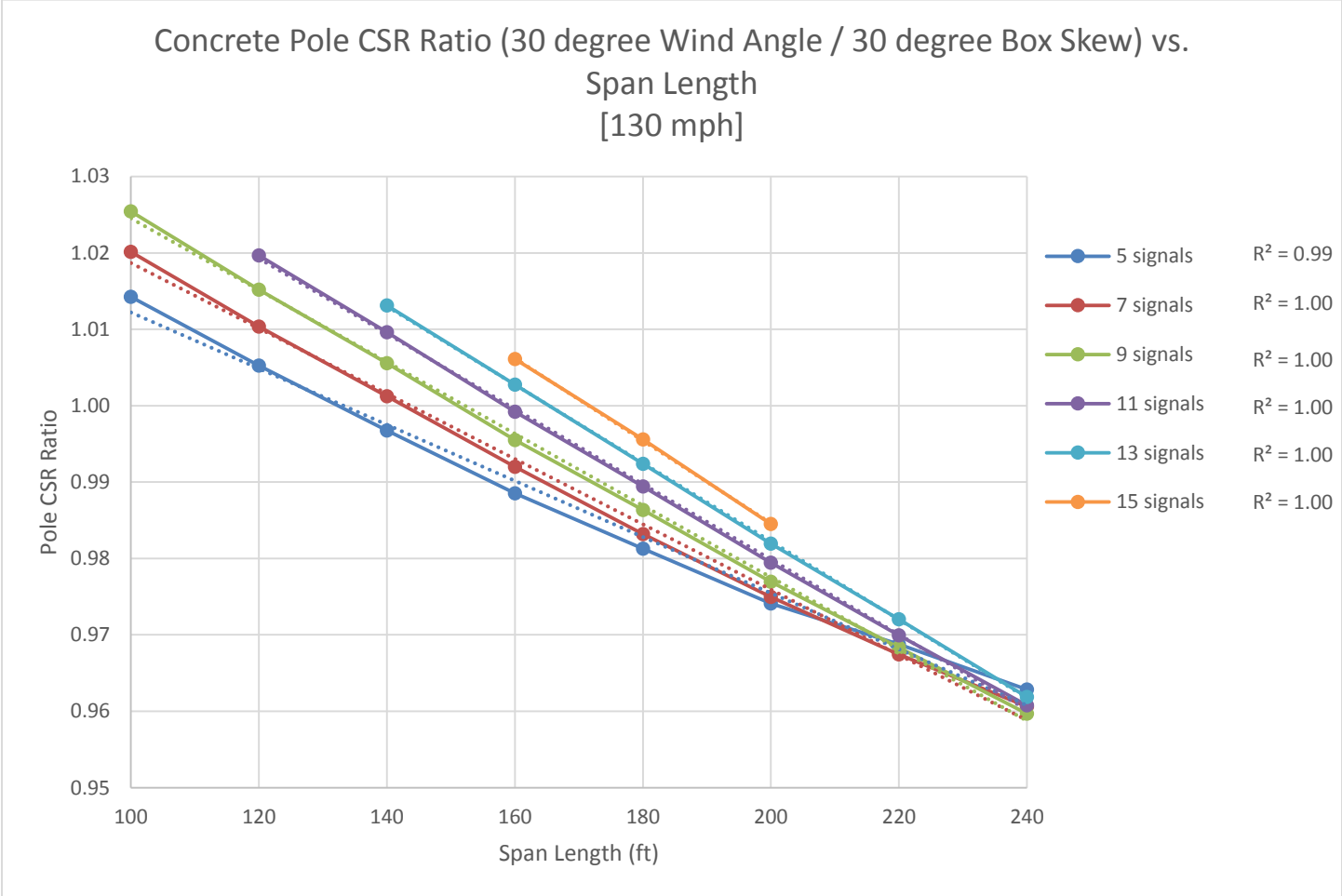

Figure 72 – GTS: Concrete Pole CSR Ratio (30 degree Wind Angle / 30 degree Box Skew) vs. Span Length, 130 mph Wind Speed, with Backplates

Concrete Pole CSR Ratio (30 degree Wind Angle / 30 degree Box Skew)
vs. Span Length
[150 mph]

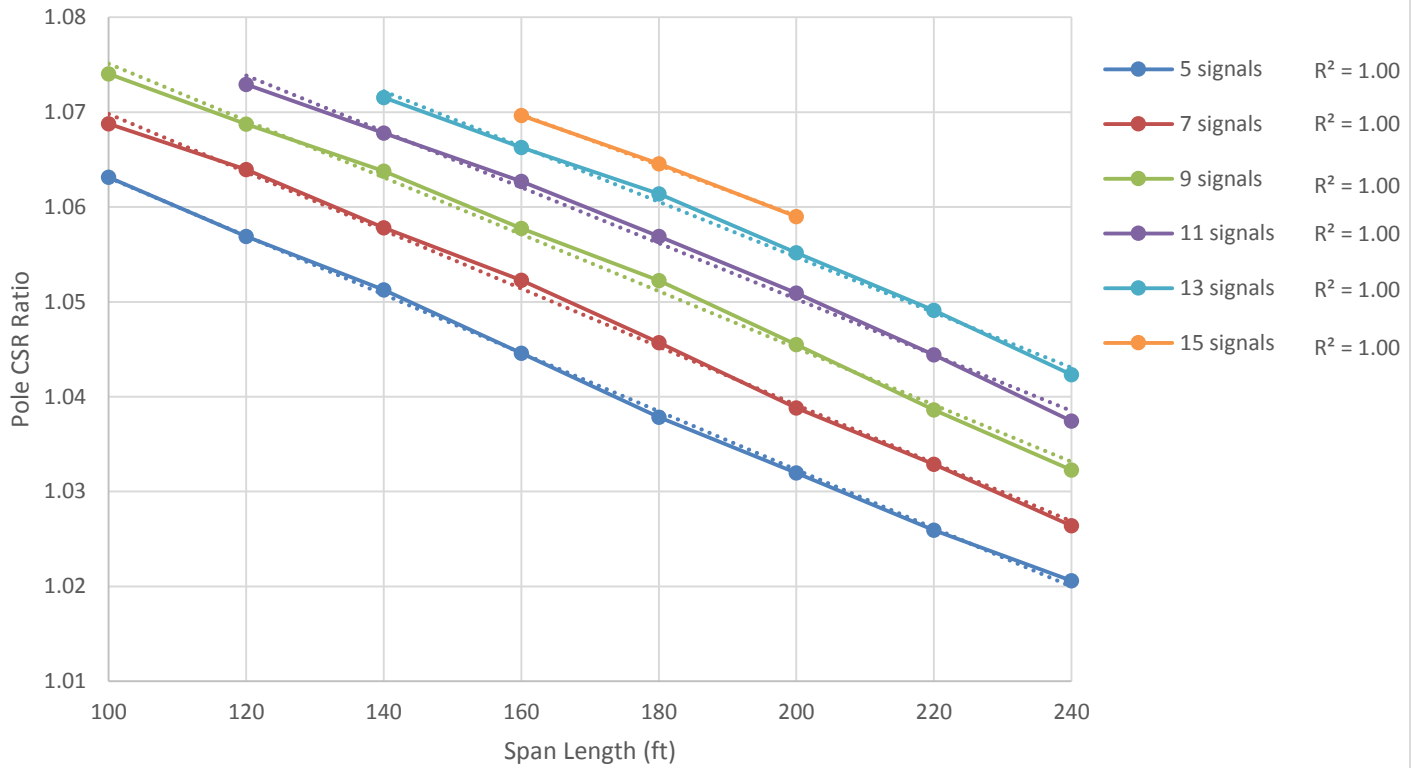

Figure 73 – GTS: Concrete Pole CSR Ratio (30 degree Wind Angle / 30 degree Box Skew) vs. Span Length, 150 mph Wind Speed, with Backplates

Span	Wind Speed	3 Signals			5 Signals			7 Signals			9 Signals		
		Default	0.7	0.7 / 0.4	Default	0.7	0.7 / 0.4	Default	0.7	0.7 / 0.4	Default	0.7	0.7 / 0.4
80ft	110mph	X	X	X	X	X	X	X	X	9.9	X	X	X
	130mph	X	X	X	X	9.7	X	X	10.8	X	X	X	X
	150mph	X	9.4	X	10.8	X	13.3	X	X	X	X	X	X
100ft	110mph	5.5	5.1	X	7.1	6.4	X	X	X	X	X	X	X
	130mph	6.7	7.9	X	8.8	X	X	X	X	X	X	X	X
	150mph	7.9	X	X	X	X	X	X	X	X	X	X	X
120ft	110mph	X	X	X	7.1	X	8.9	X	X	X	X	X	X
	130mph	6.8	X	X	8.7	X	X	X	X	X	X	X	X
	150mph	X	9.5	X	X	X	X	X	X	X	X	X	X
140ft	110mph	X	X	X	X	7.0	X	8.4	8.1	X	X	X	X
	130mph	X	8.0	X	8.8	X	X	X	11.6	13.3	X	X	X
	150mph	X	X	X	10.4	X	X	X	X	16.1	X	X	X

Note – All runs marked with an “X” indicated the program crashing with no results produced.

Table 17 – ATLAS Cable Tension Results for 0 Degree Wind Angle Box Span Configurations

Span	Wind Speed	3 Signals			5 Signals			7 Signals			9 Signals		
		Default	0.7	0.7 / 0.4	Default	0.7	0.7 / 0.4	Default	0.7	0.7 / 0.4	Default	0.7	0.7 / 0.4
80ft	110mph	X	X	X	X	4.9	6.1	8.2	X	X	X	X	X
	130mph	X	4.8	X	5.8	6.0	X	7.5	X	X	X	X	X
	150mph	X	X	8.6	X	7.0	X	X	X	X	X	X	X
100ft	110mph	4.4	4.0	4.9	6.1	5.1	6.4	X	X	8.9	X	X	X
	130mph	5.3	5.0	X	7.5	6.4	9.8	X	X	X	X	X	X
	150mph	6.1	5.8	X	8.5	7.4	11.4	11.2	8.6	X	X	X	X
120ft	110mph	X	4.1	5.7	X	X	X	X	X	X	X	X	X
	130mph	X	X	X	X	X	X	X	X	X	X	X	X
	150mph	X	6.0	X	8.2	X	X	X	X	X	X	X	X
140ft	110mph	X	X	X	X	X	X	X	6.2	X	X	X	X
	130mph	X	X	X	7.0	X	X	X	X	X	X	X	X
	150mph	X	X	X	X	X	X	X	X	X	X	X	X

Note – All runs marked with an “X” indicated the program crashing with no results produced.

Table 18 – ATLAS Cable Tension Results for 45 Degree Wind Angle Box Span Configurations, with Backplates

Span	Wind Speed	3 Signals			5 Signals			7 Signals			9 Signals		
		Default	0.7	0.7 / 0.4	Default	0.7	0.7 / 0.4	Default	0.7	0.7 / 0.4	Default	0.7	0.7 / 0.4
80ft	110mph	5.6	4.8	7.0	X	X	X	X	X	X	X	X	X
	130mph	X	X	X	X	X	X	X	X	X	X	X	X
	150mph	X	X	X	X	X	X	X	X	X	X	X	X
100ft	110mph	5.5	5.1	X	7.1	6.4	8.9	8.9	7.3	10.2	X	X	X
	130mph	6.7	X	X	8.3	8.0	11.1	10.8	9.2	12.7	X	X	X
	150mph	7.6	X	X	10.4	9.6	13.3	12.7	13.5	15.5	X	X	X
120ft	110mph	5.5	5.4	X	X	X	X	X	X	X	X	X	X
	130mph	6.8	X	X	X	X	X	X	X	X	X	X	X
	150mph	8.1	X	X	X	X	X	X	X	X	X	X	X
140ft	110mph	5.6	X	X	X	X	X	8.4	X	X	X	X	X
	130mph	X	X	X	X	X	X	9.6	10.1	X	X	X	X
	150mph	8.0	X	X	X	X	X	10.5	13.9	X	X	X	X

Note – All runs marked with an “X” indicated the program crashing with no results produced.

Table 19 – ATLAS Cable Tension Results for 90 Degree Wind Angle Box Span Configurations, with Backplates

Appendix E – Hanging Box Span Wire Study

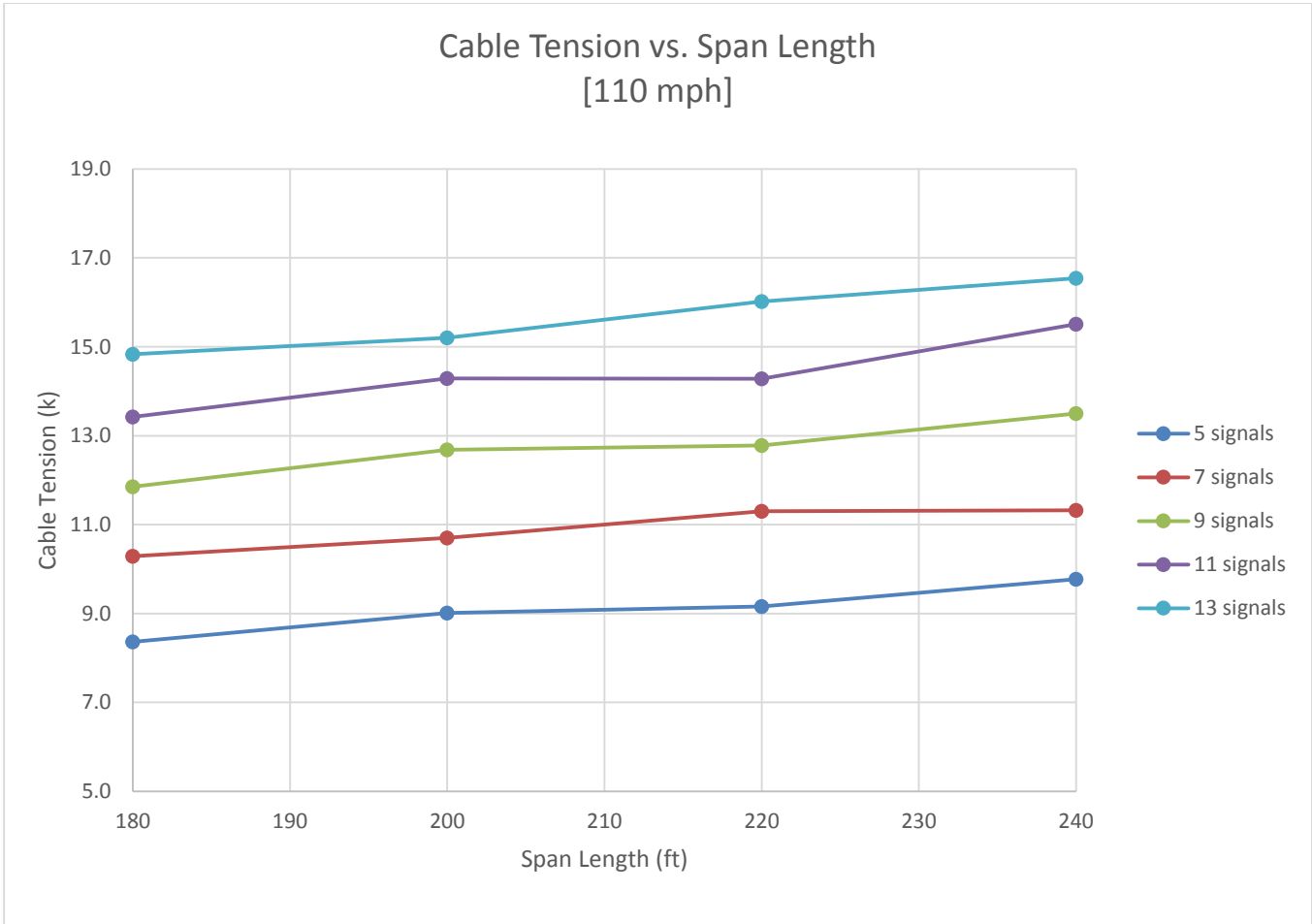

Figure 74 – GTS: Cable Tension Results versus Span Length for Models with Concrete Poles, 110 mph Wind Speed, with Backplates

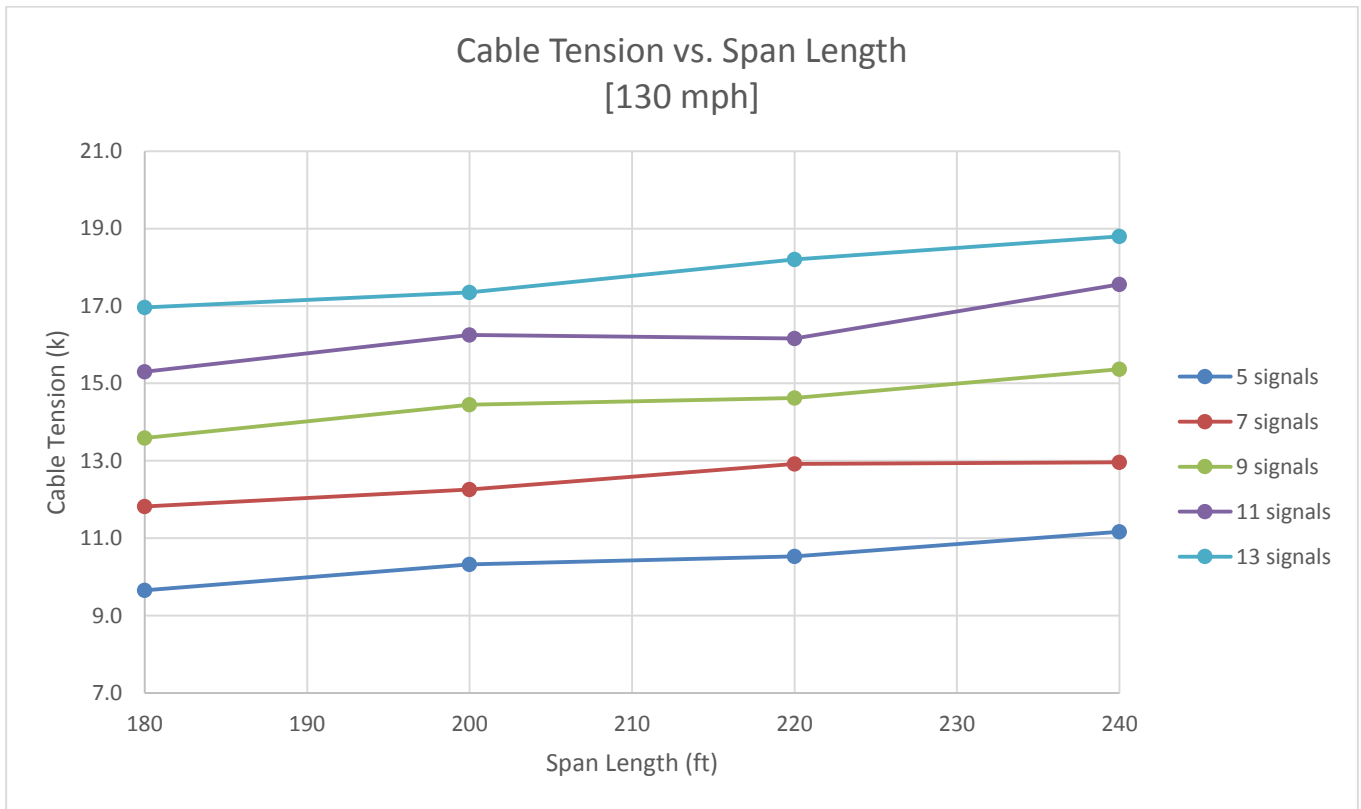

Figure 75 – GTS: Cable Tension Results versus Span Length for Models with Concrete Poles, 130 mph Wind Speed, with Backplates

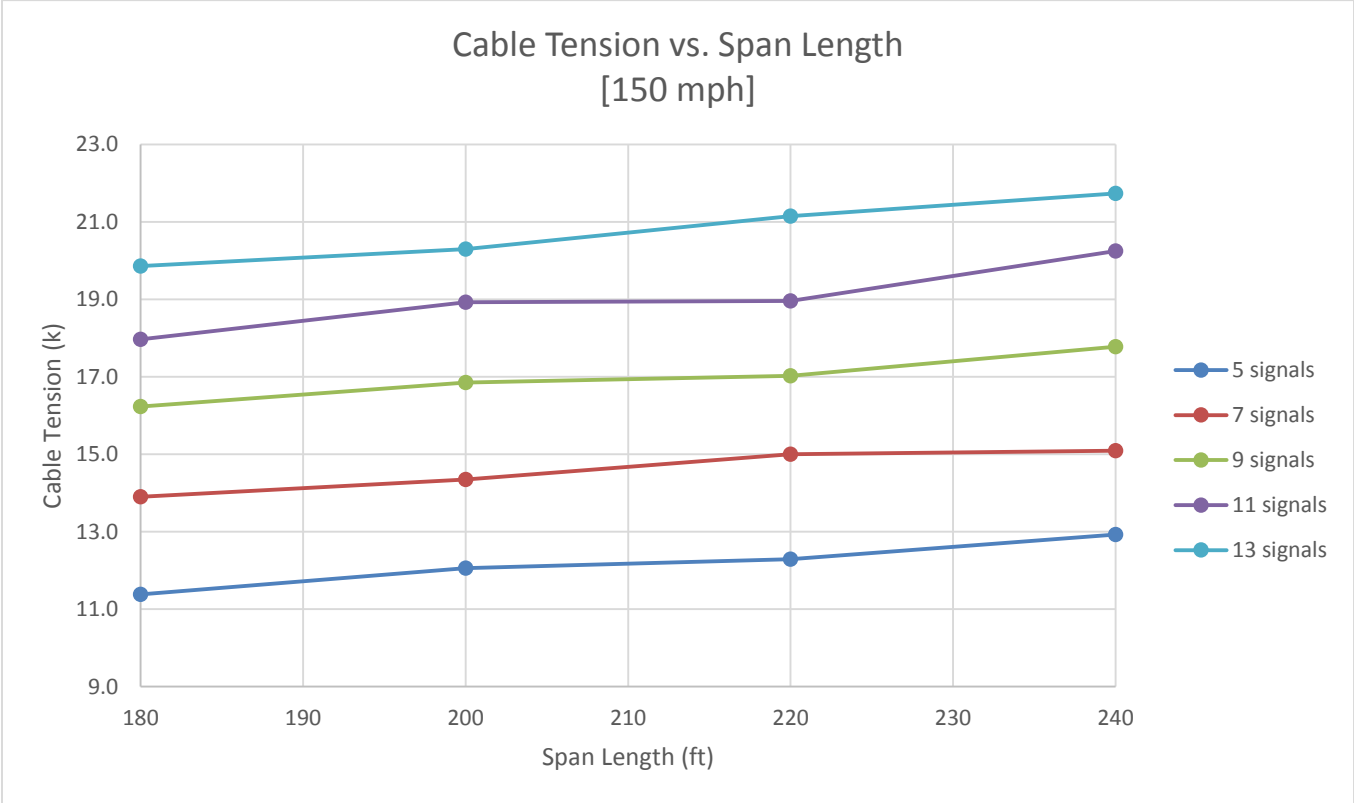

Figure 76 – GTS: Cable Tension Results versus Span Length for Models with Concrete Poles, 150 mph Wind Speed, with Backplates

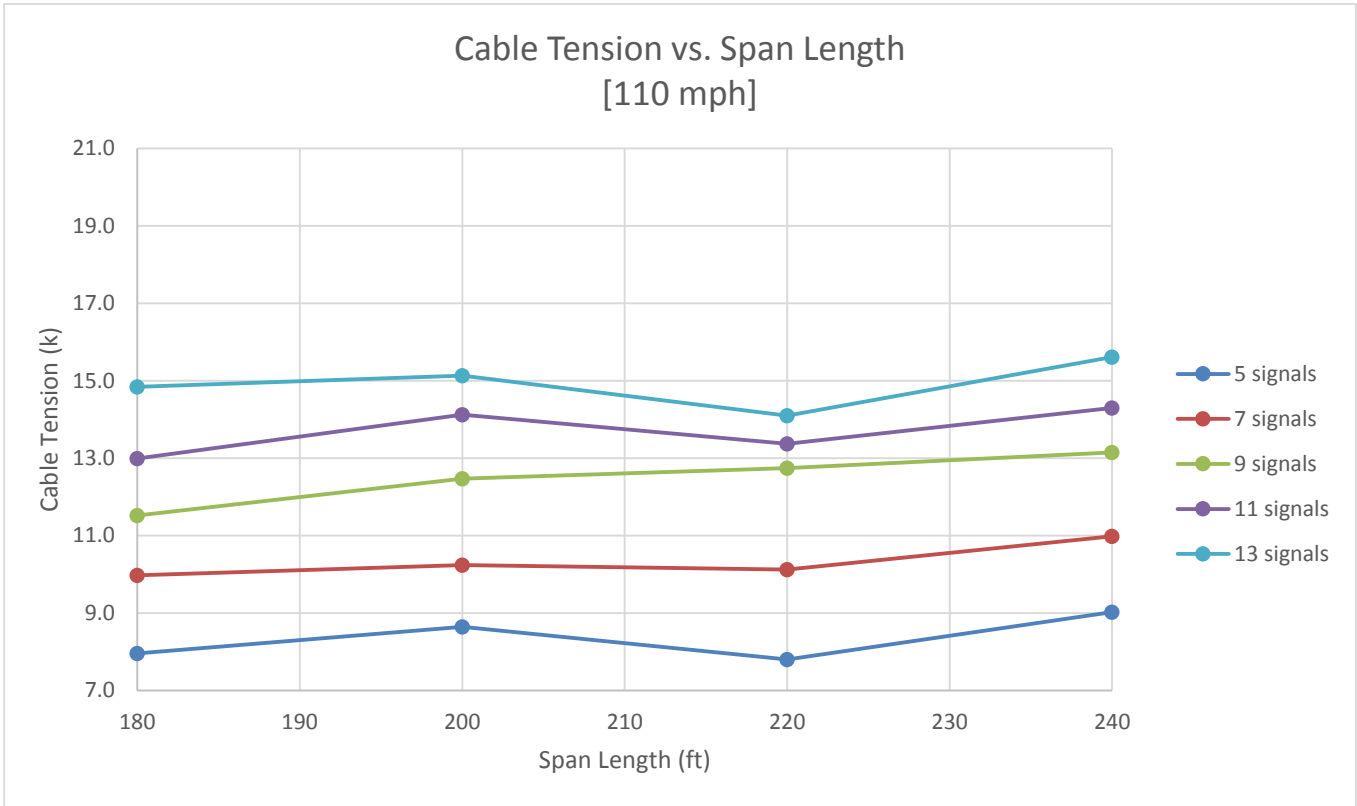

Figure 77 – GTS: Cable Tension Results versus Span Length for Models with Steel Poles, 110 mph Wind Speed, with Backplates

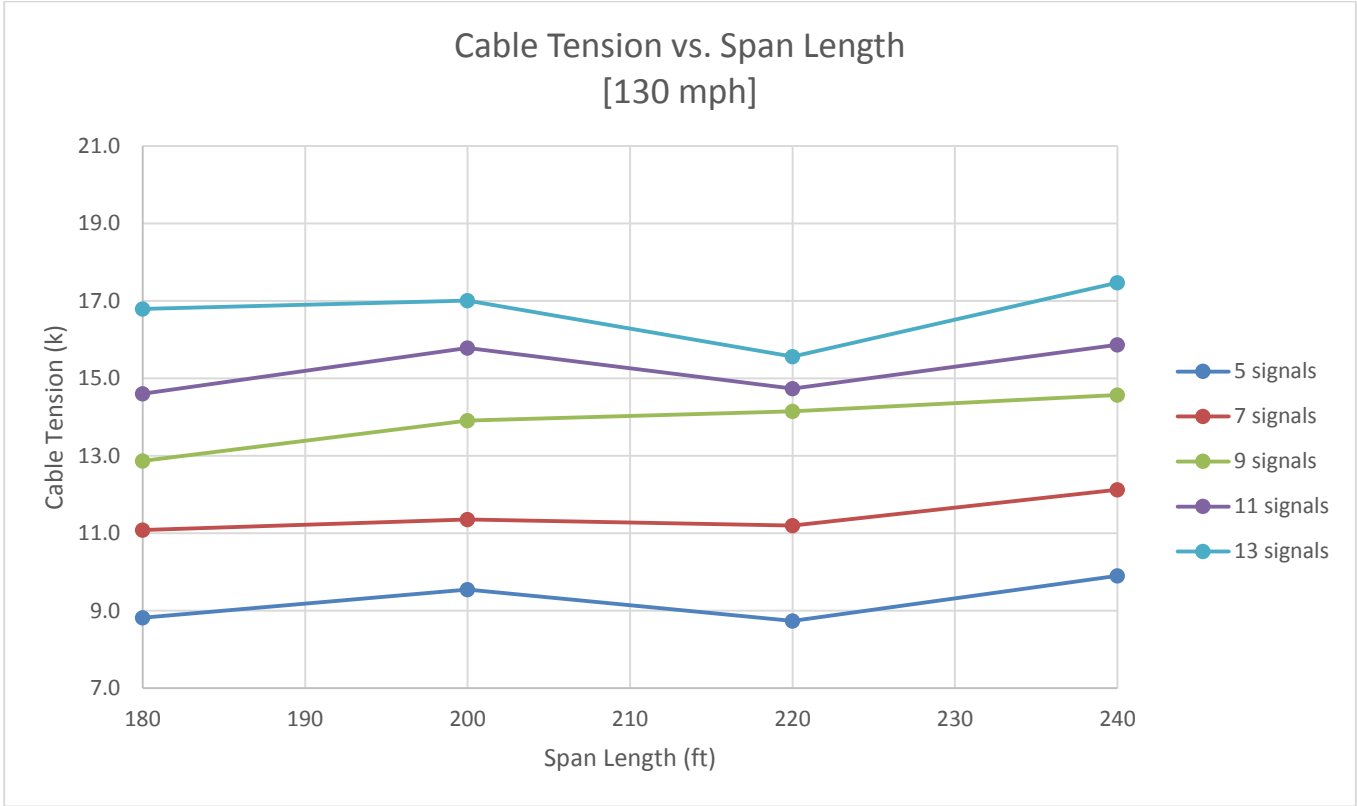

Figure 78 – GTS: Cable Tension Results versus Span Length for Models with Steel Poles, 130 mph Wind Speed, with Backplates

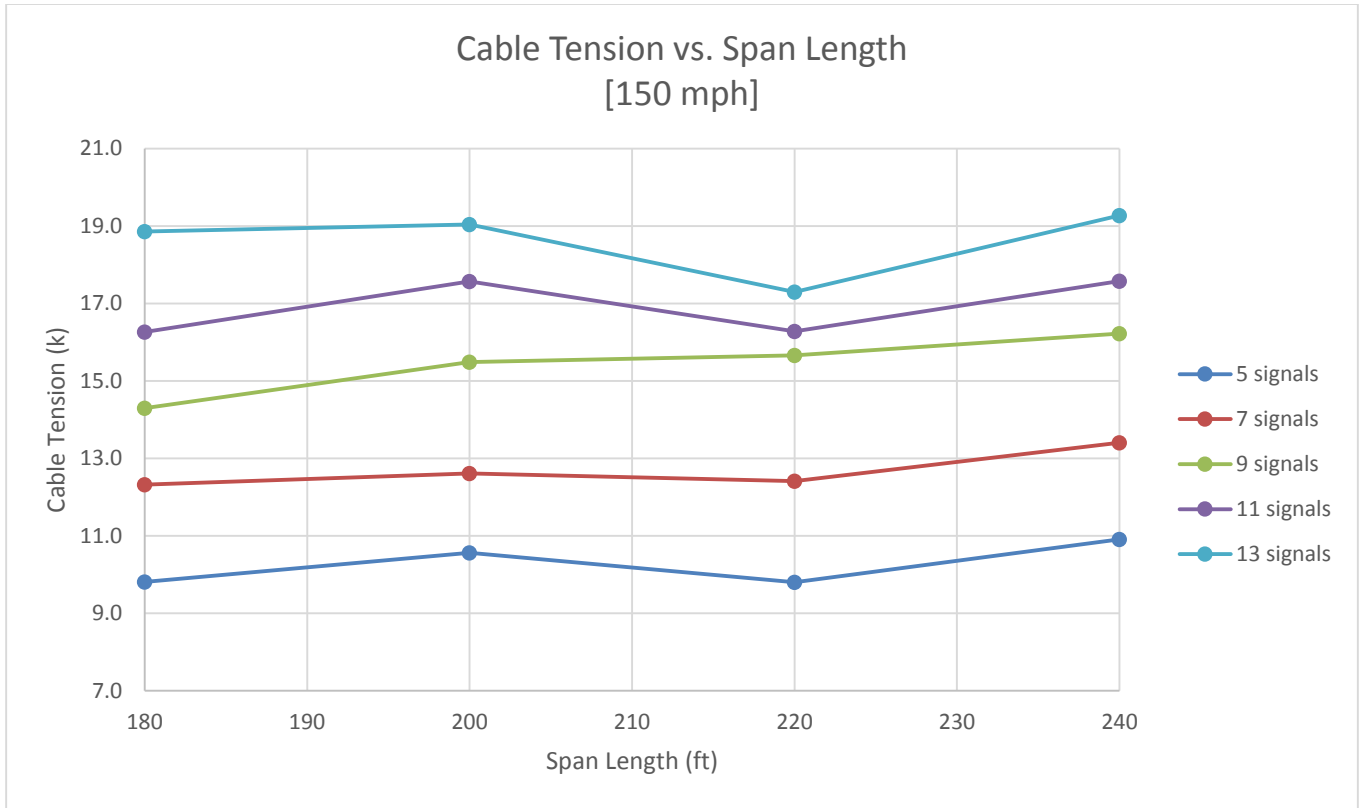

Figure 79 – GTS: Cable Tension Results versus Span Length for Models with Steel Poles, 150 mph Wind Speed, with Backplates

Concrete / Steel						
Span	Wind Speed	5 Signals	7 Signals	9 Signals	11 Signals	13 Signals
180ft	110mph	1.05	1.03	1.03	1.03	1.00
	130mph	1.10	1.07	1.06	1.05	1.01
	150mph	1.16	1.13	1.13	1.11	1.05
200ft	110mph	1.04	1.04	1.02	1.01	1.00
	130mph	1.08	1.08	1.04	1.03	1.02
	150mph	1.14	1.14	1.09	1.08	1.07
220ft	110mph	1.17	1.12	1.00	1.07	1.14
	130mph	1.21	1.15	1.03	1.10	1.17
	150mph	1.25	1.21	1.09	1.16	1.22
240ft	110mph	1.08	1.03	1.03	1.08	1.06
	130mph	1.13	1.07	1.05	1.11	1.08
	150mph	1.19	1.13	1.10	1.15	1.13

Note – The 10 largest ratios are highlighted in red. The lowest 10 ratios are highlighted in green.

Table 20 – GTS: Cable Tension Results; Concrete Pole / Steel Pole, with Backplates

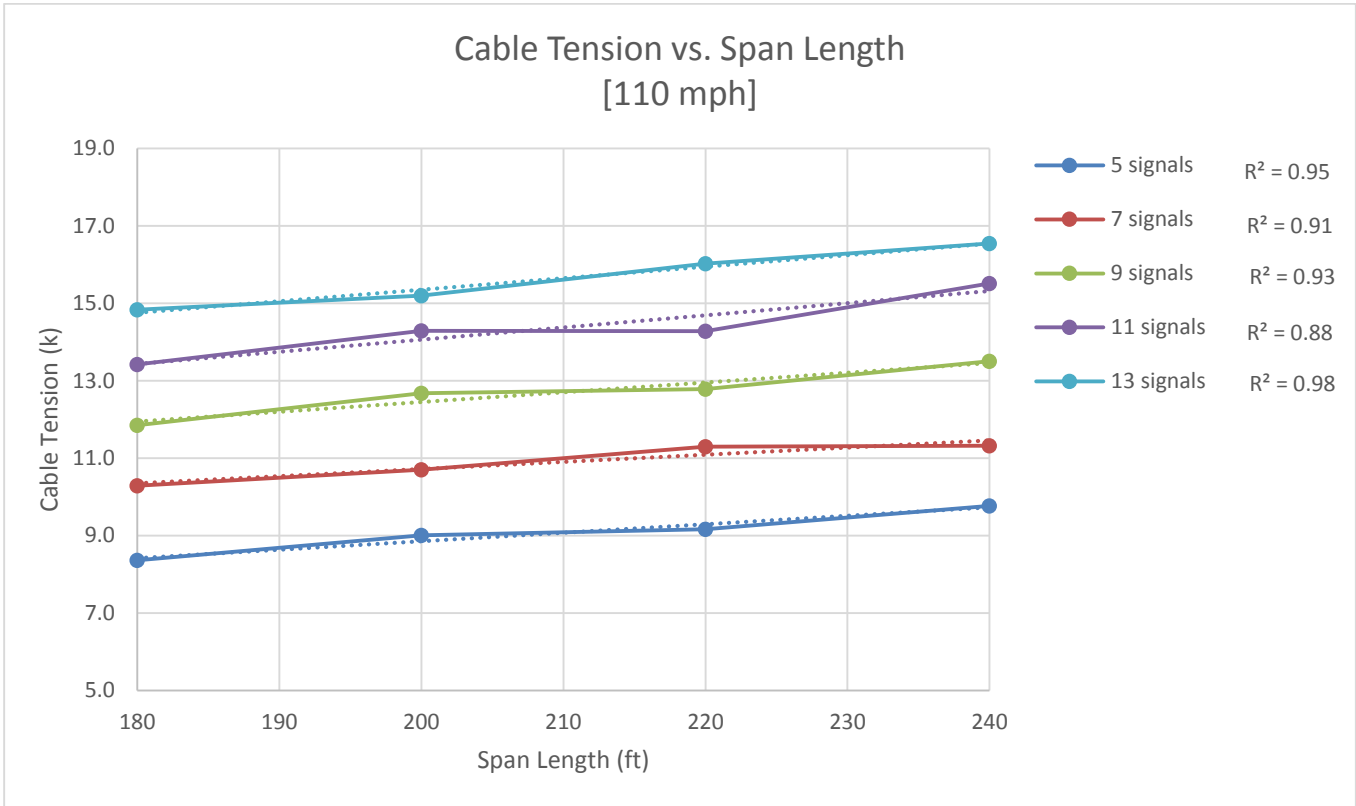

Figure 80 – GTS: Cable Tension Versus Span Length and Trend lines with Concrete Poles, 110 mph Wind Speed, with Backplates

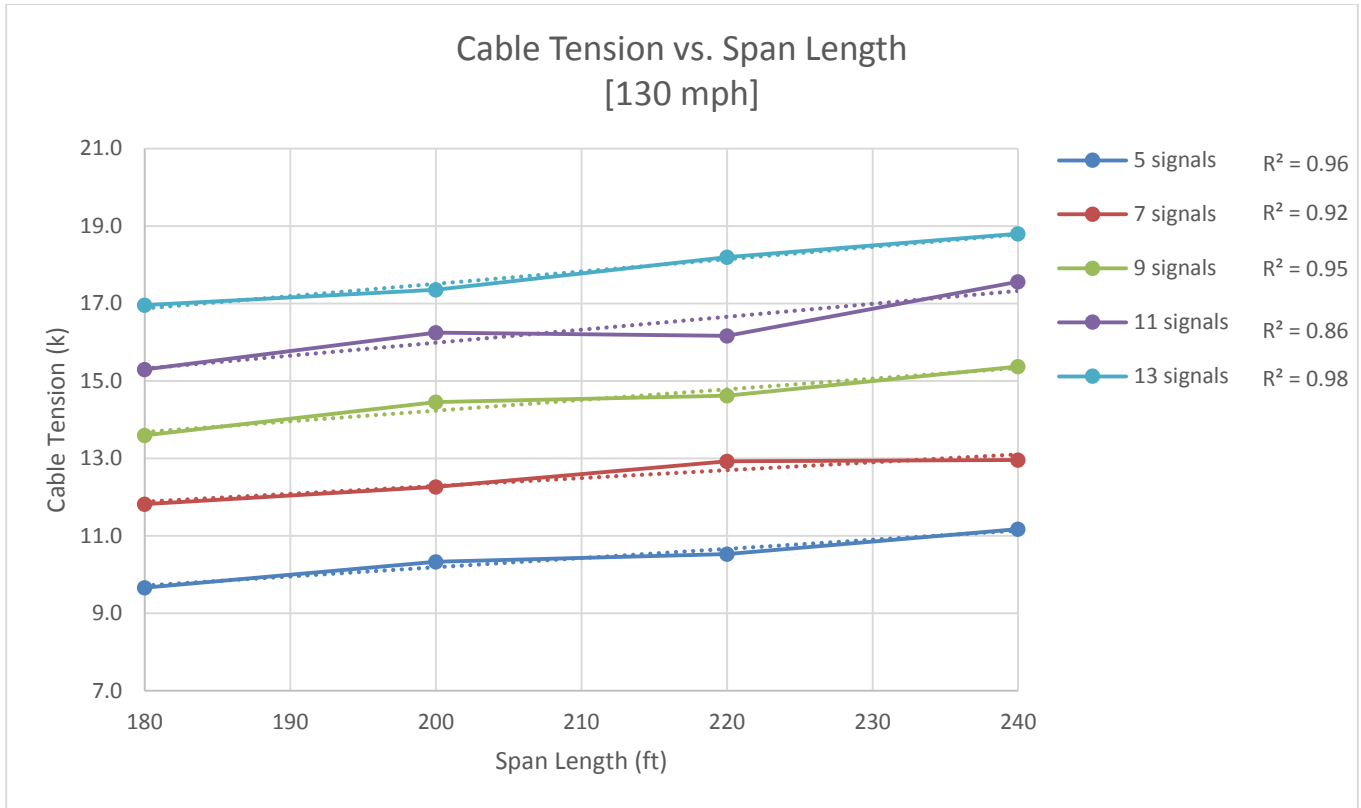

Figure 81 – GTS: Cable Tension Versus Span Length and Trend lines with Concrete Poles, 130 mph Wind Speed, with Backplates

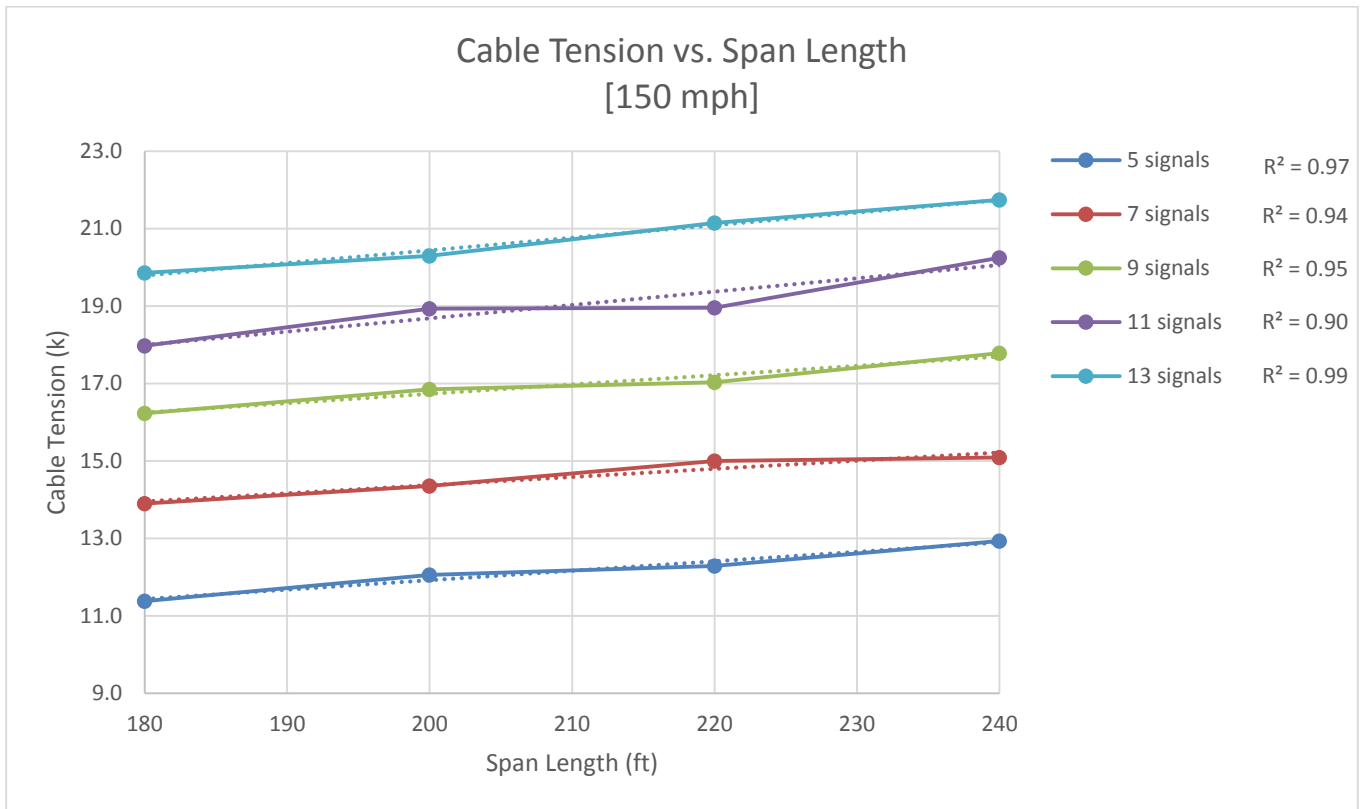

Figure 82 – GTS: Cable Tension Versus Span Length and Trend lines with Concrete Poles, 150 mph Wind Speed, with Backplates

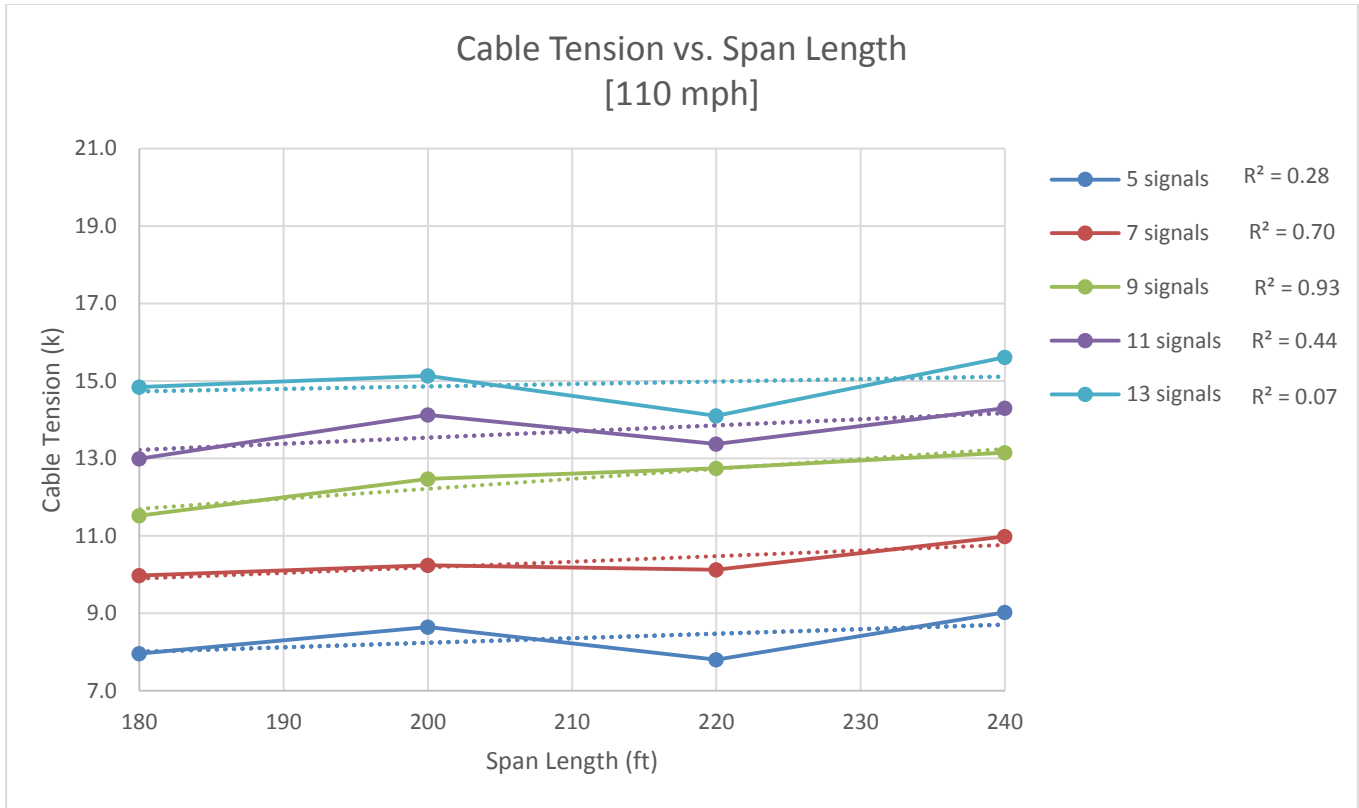

Figure 83 – GTS: Cable Tension Versus Span Length and Trend lines with Steel Poles, 110 mph Wind Speed, with Backplates

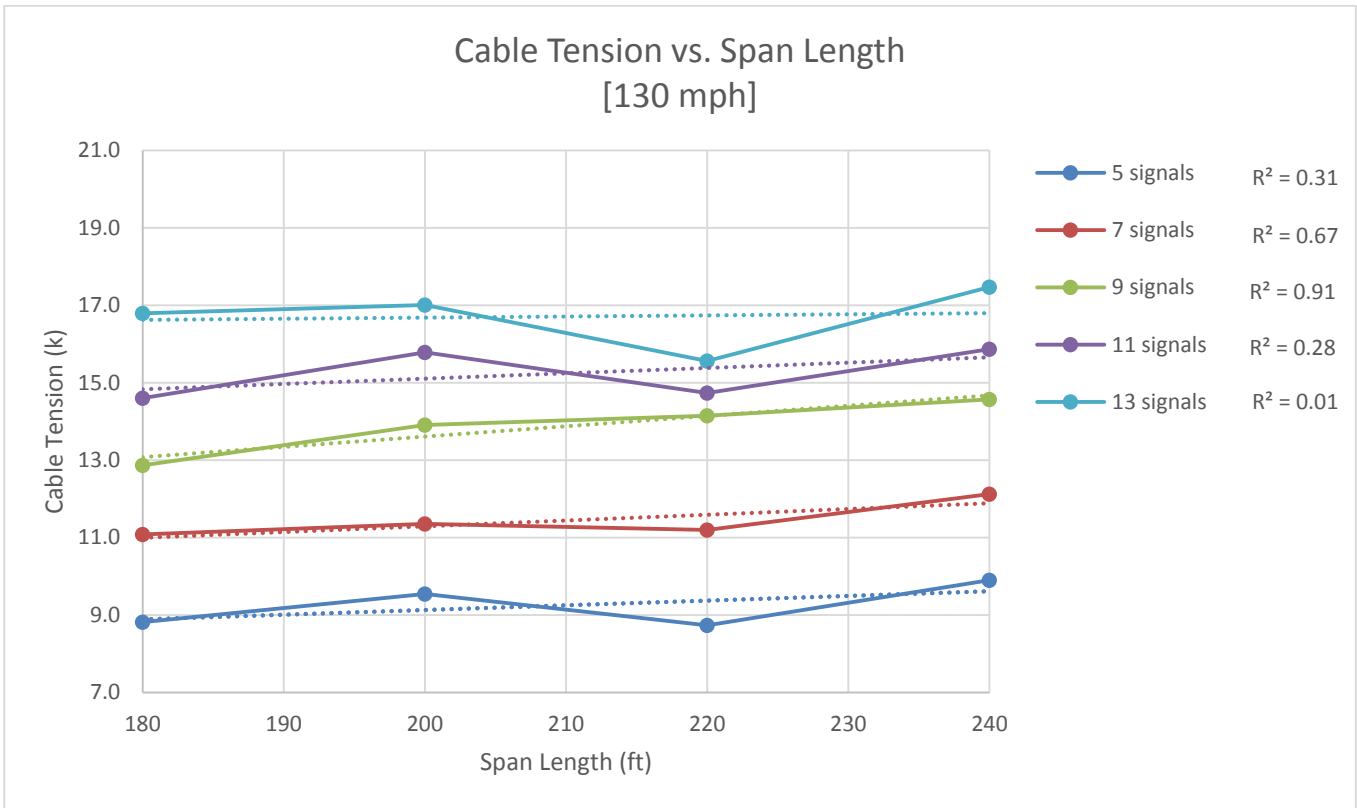

Figure 84 – GTS: Cable Tension Versus Span Length and Trend lines with Steel Poles, 130 mph Wind Speed, with Backplates

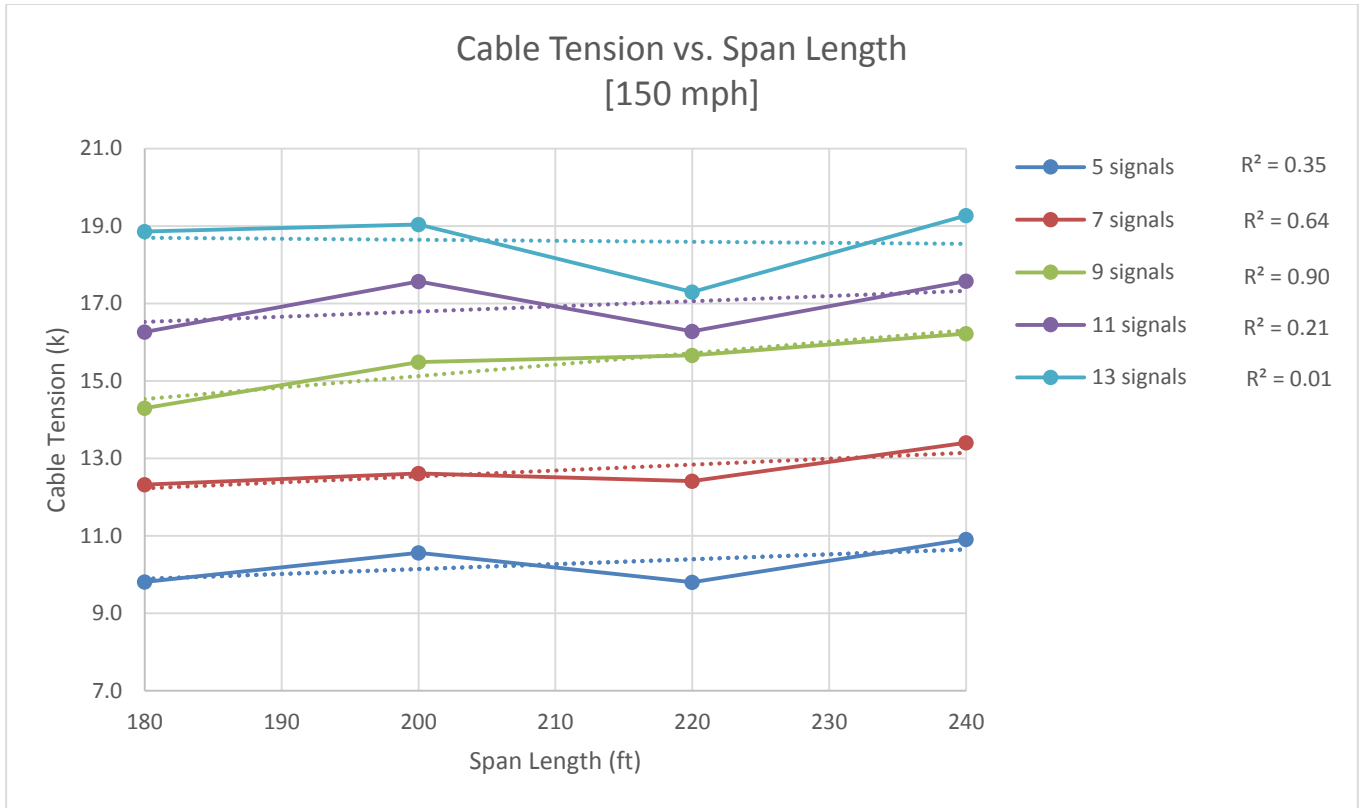

Figure 85 – GTS: Cable Tension Versus Span Length and Trend lines with Steel Poles, 150 mph Wind Speed, with Backplates

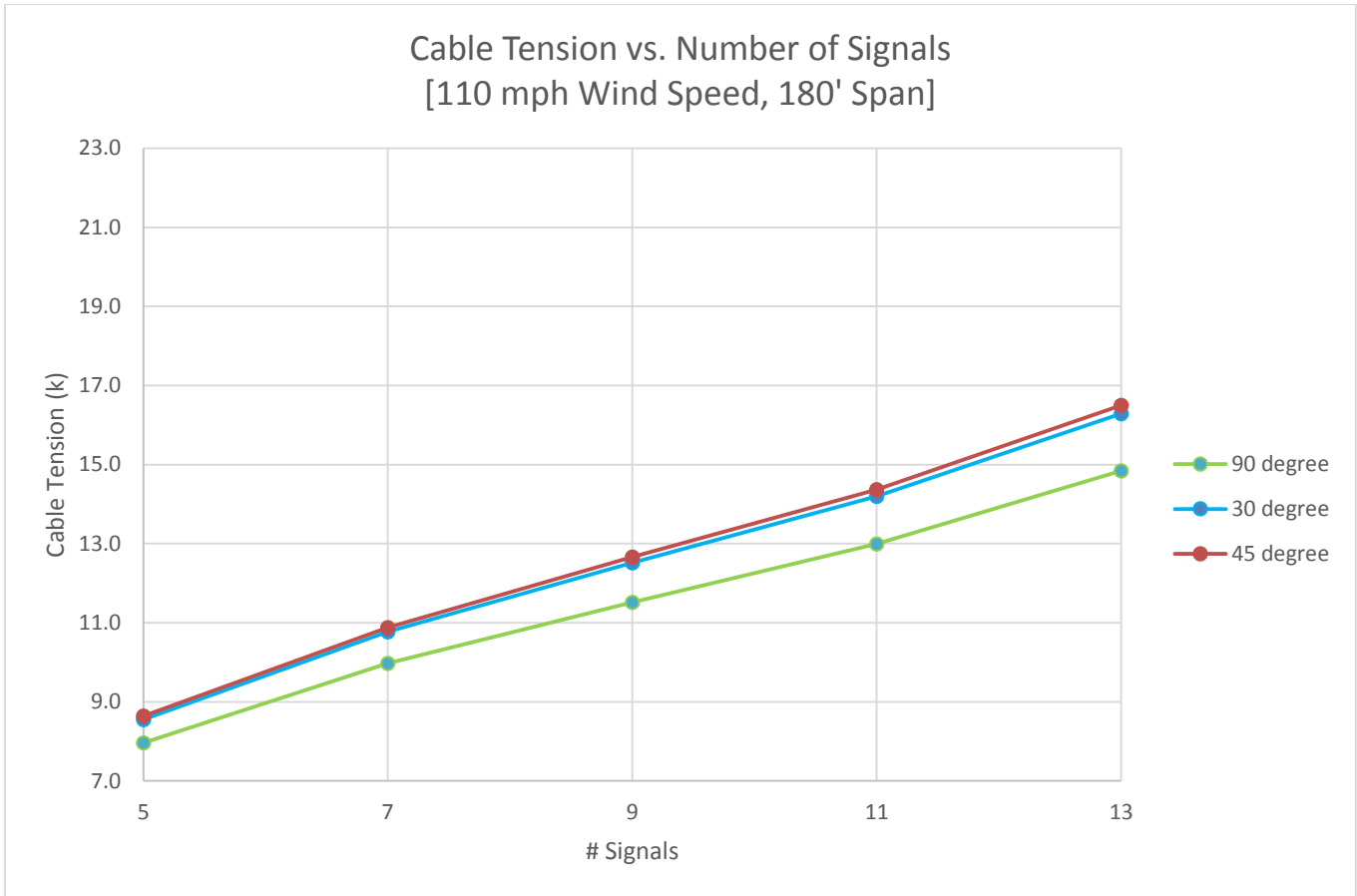

Figure 86 – GTS: Cable Tension versus Number of Signals, 110 mph Wind Speed, 180 Ft. Span, with Backplates

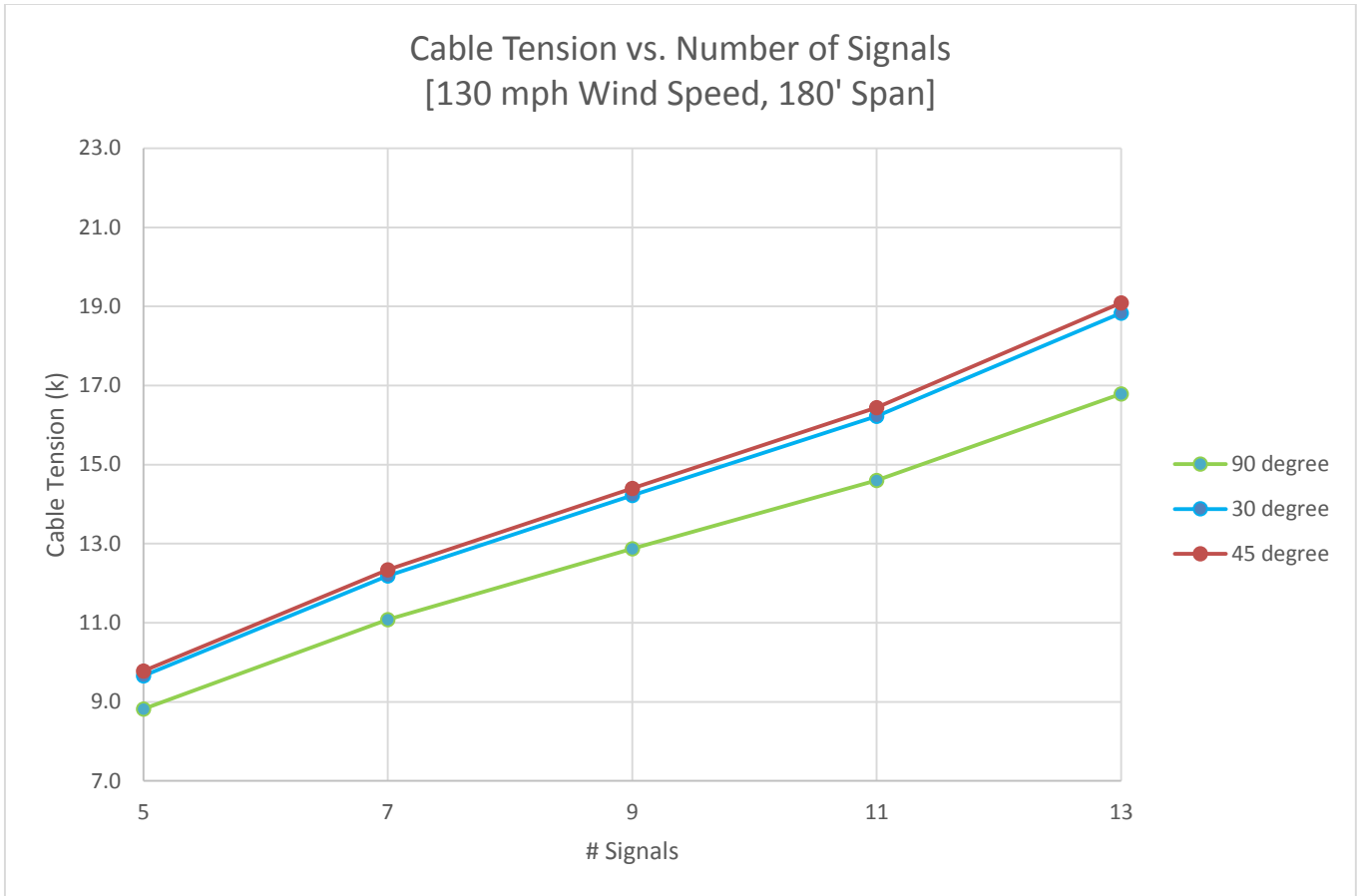

Figure 87 – GTS: Cable Tension versus Number of Signals, 130 mph Wind Speed, 180 Ft. Span, with Backplates

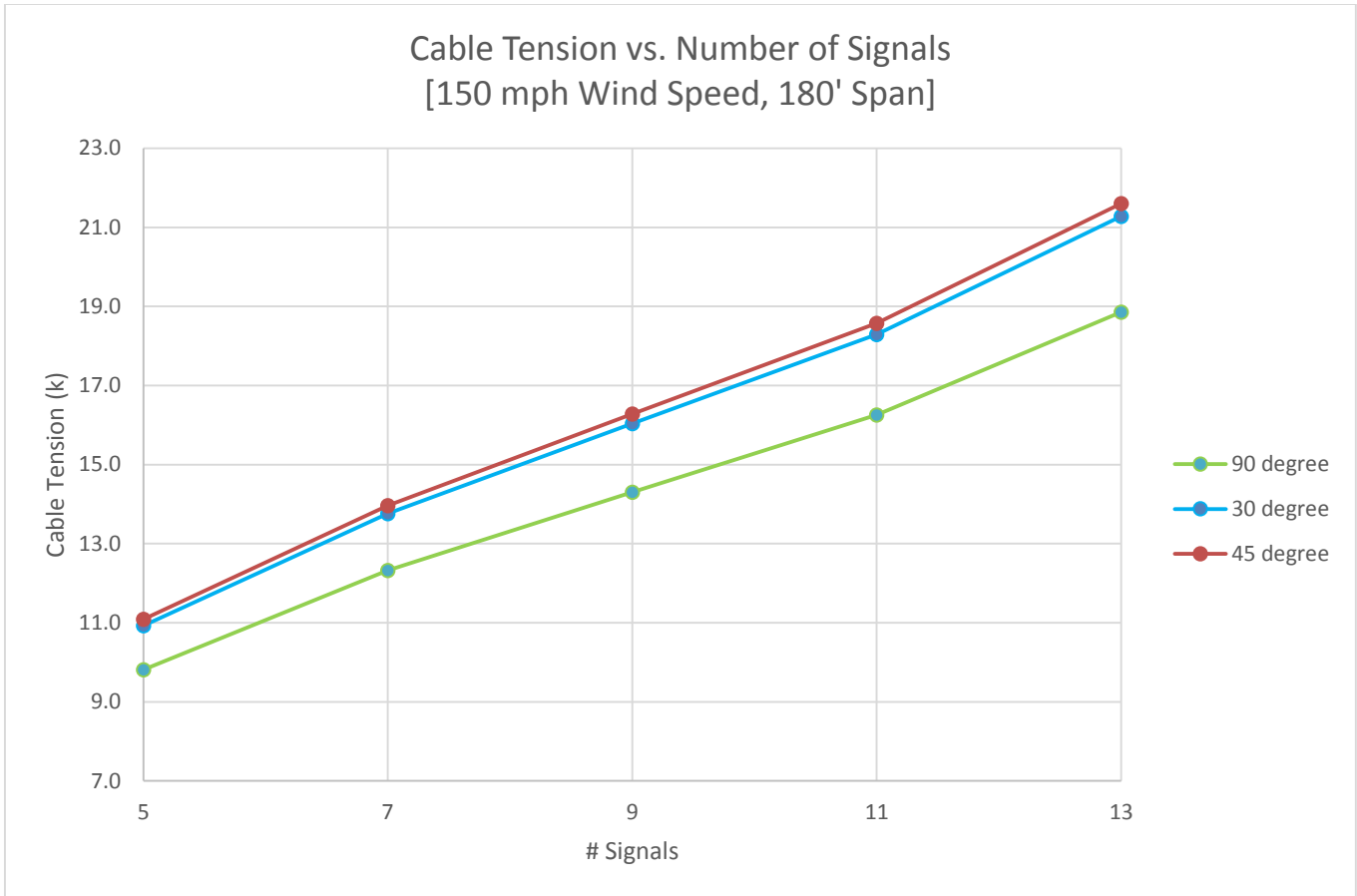

Figure 88 – GTS: Cable Tension versus Number of Signals, 150 mph Wind Speed, 180 Ft. Span, with Backplates

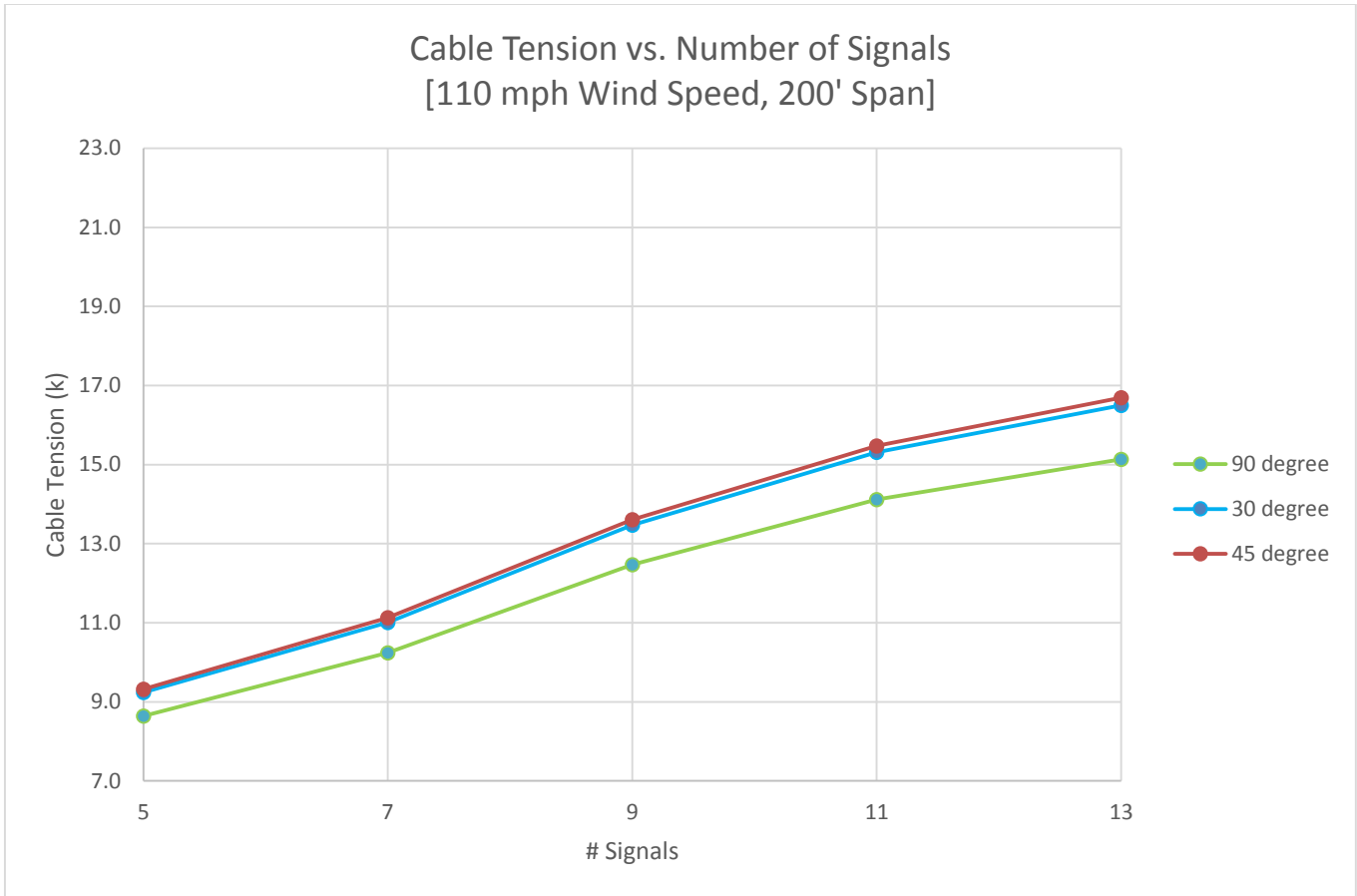

Figure 89 – GTS: Cable Tension versus Number of Signals, 110 mph Wind Speed, 200 Ft. Span, with Backplates

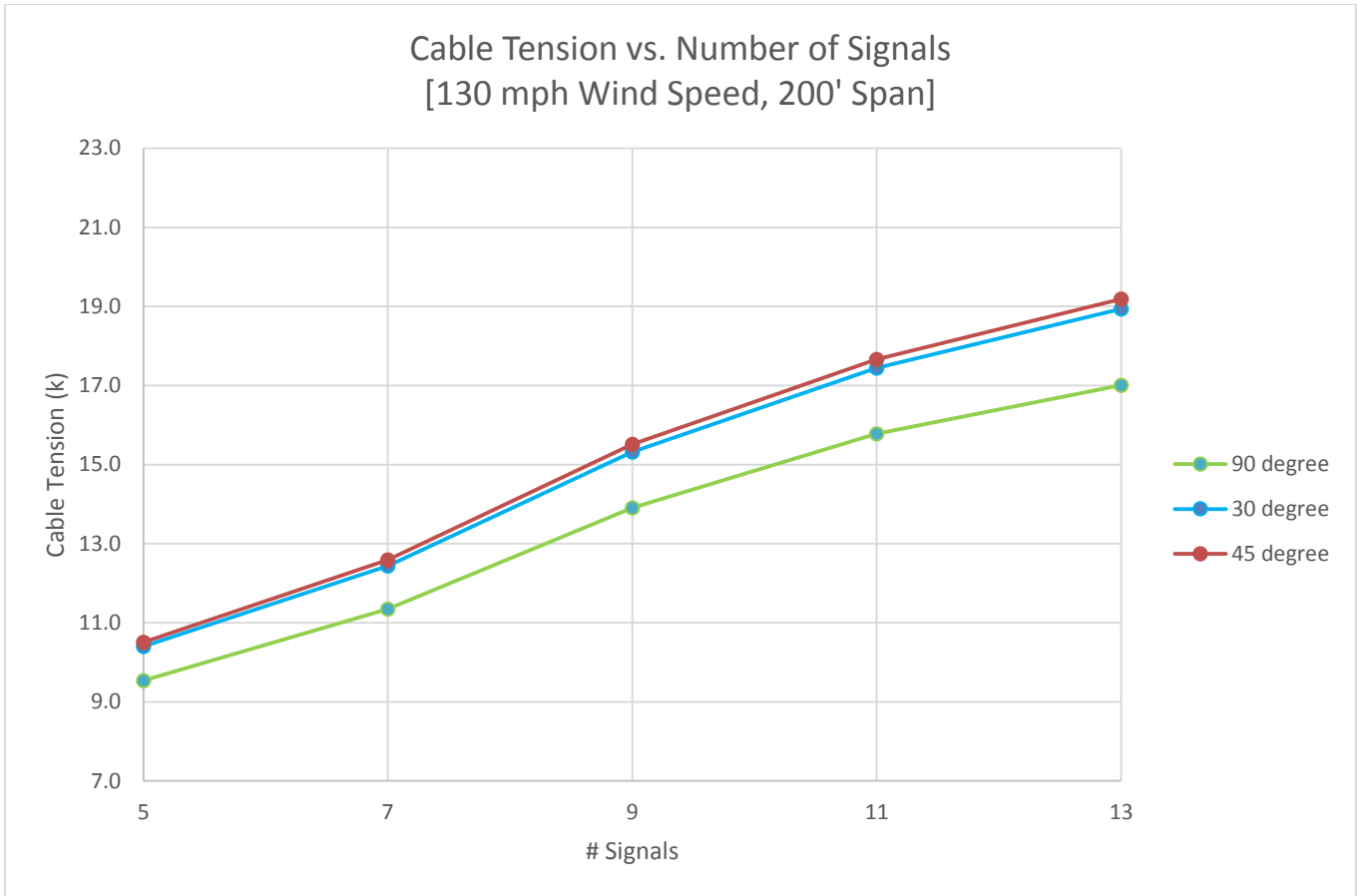

Figure 90 – GTS: Cable Tension versus Number of Signals, 130 mph Wind Speed, 200 Ft. Span, with Backplates

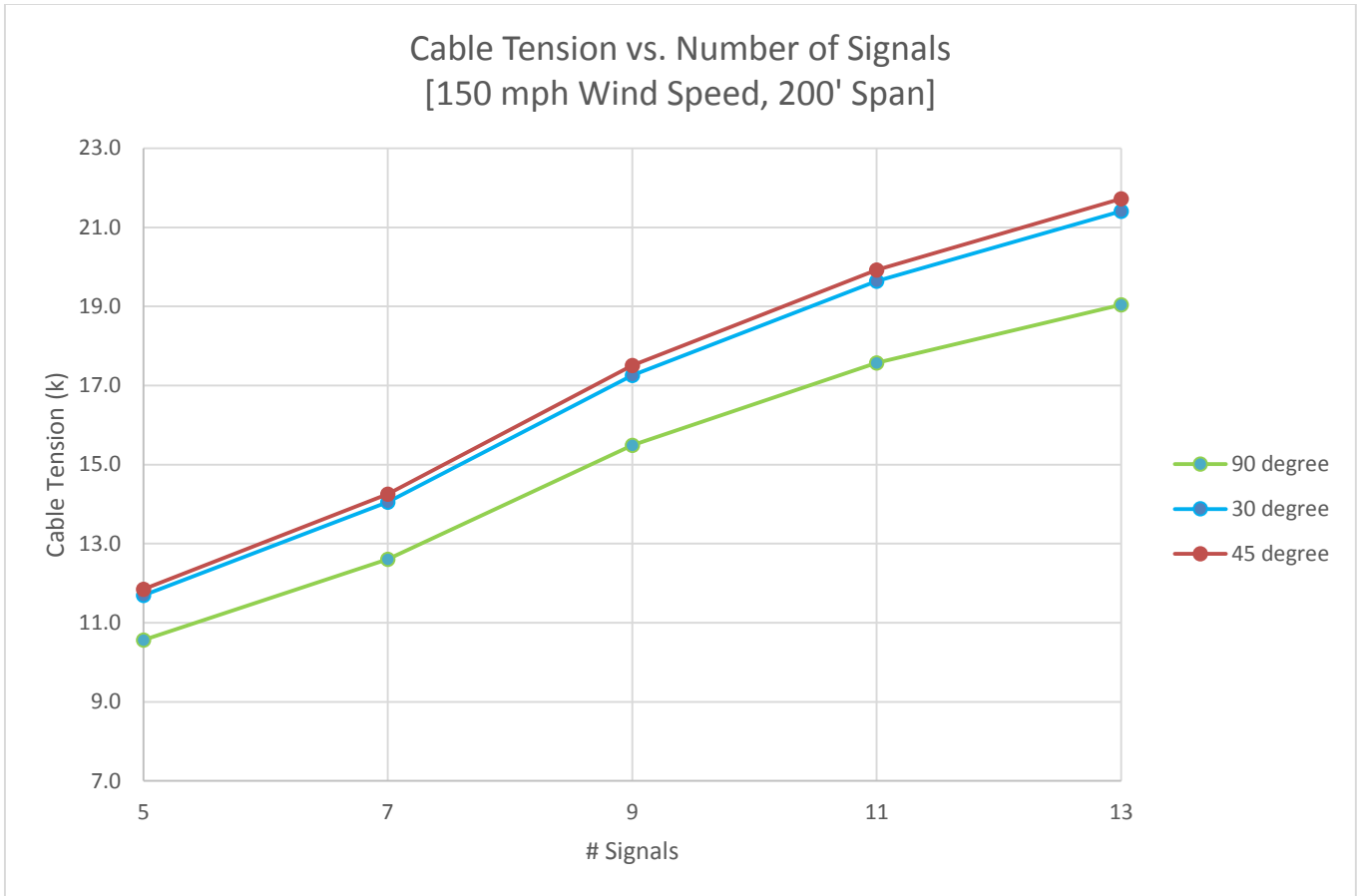

Figure 91 – GTS: Cable Tension versus Number of Signals, 150 mph Wind Speed, 200 Ft. Span, with Backplates

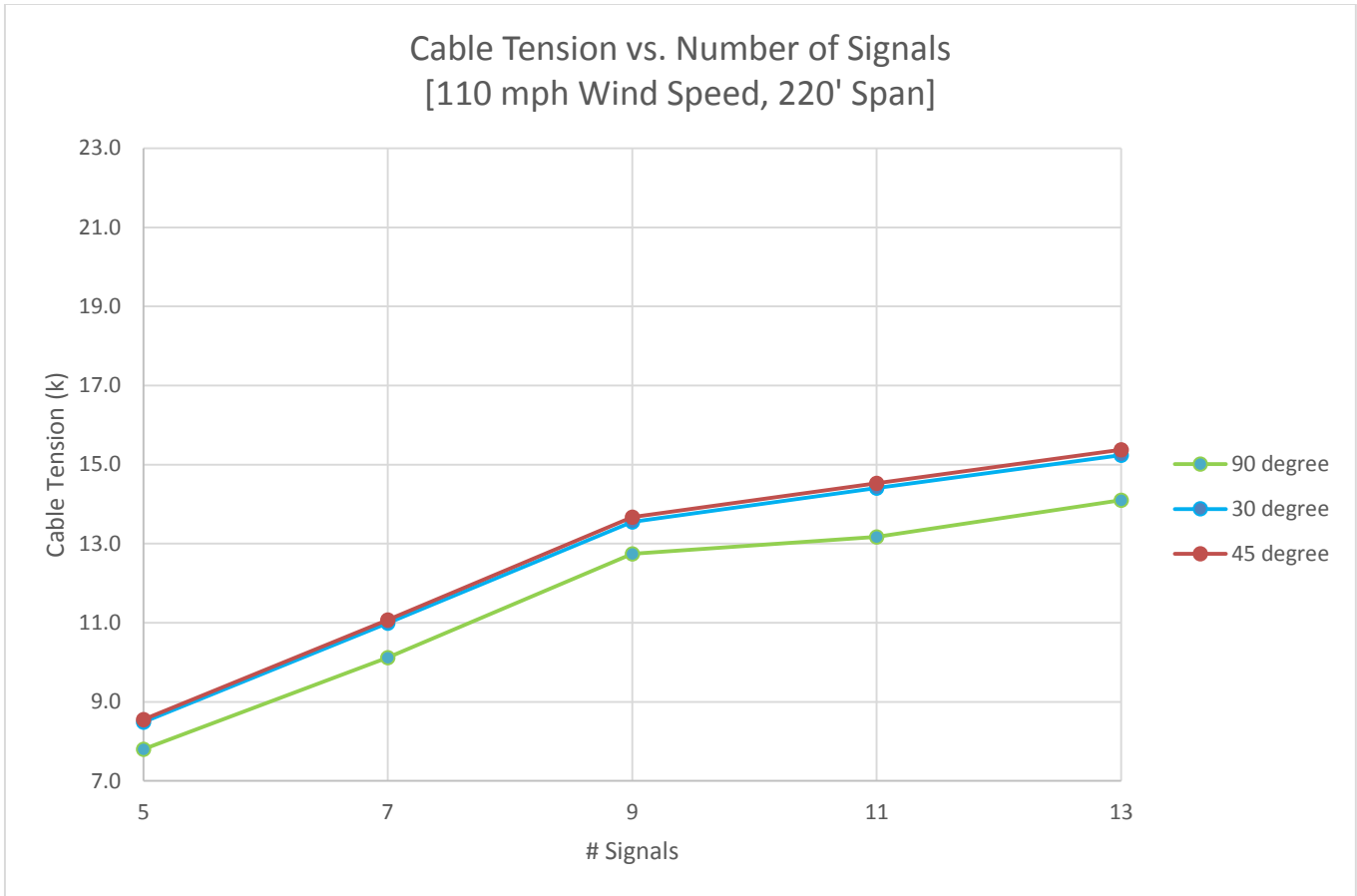

Figure 92 – GTS: Cable Tension versus Number of Signals, 110 mph Wind Speed, 220 Ft. Span, with Backplates

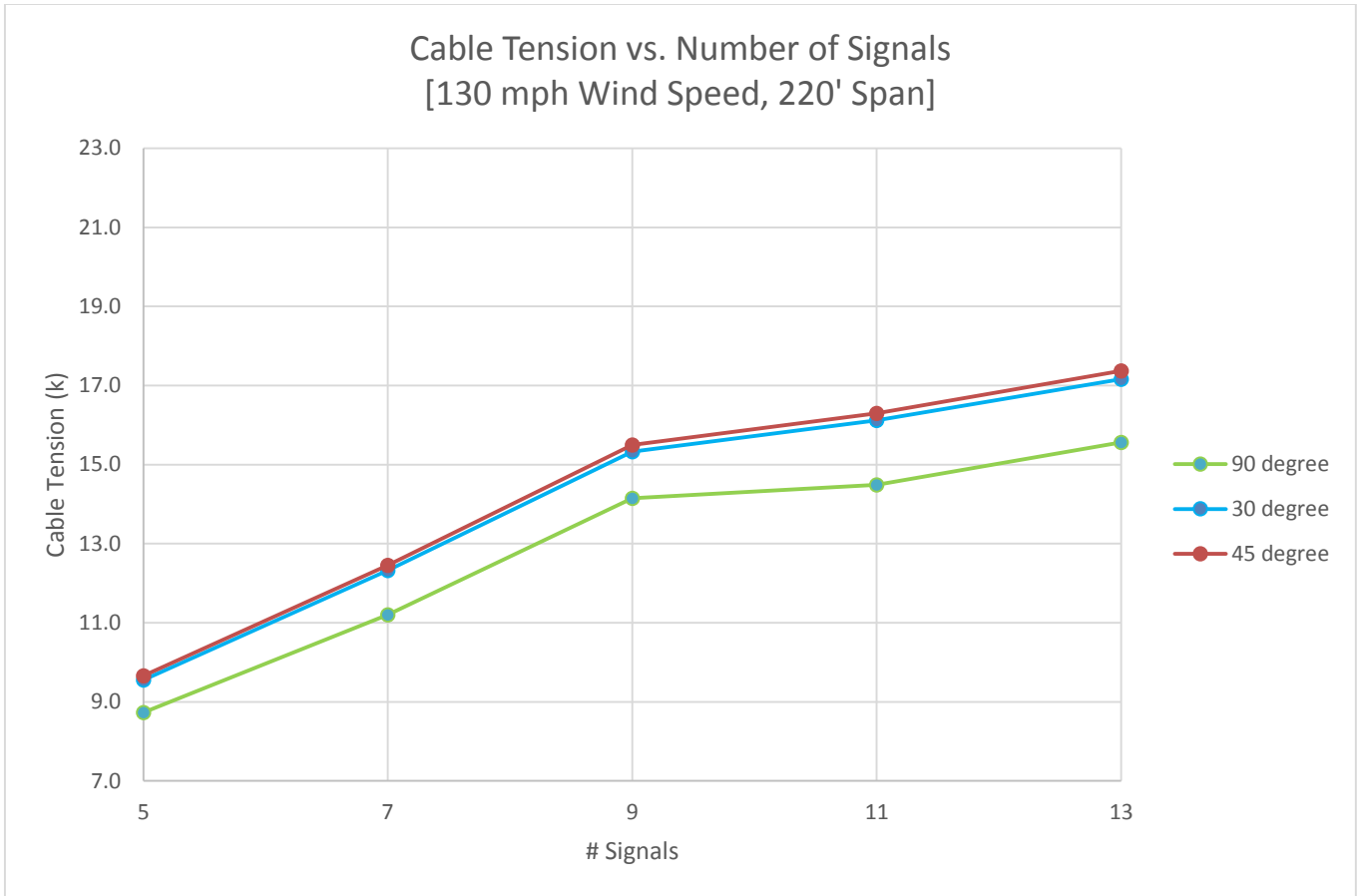

Figure 93 – GTS: Cable Tension versus Number of Signals, 130 mph Wind Speed, 220 Ft. Span, with Backplates

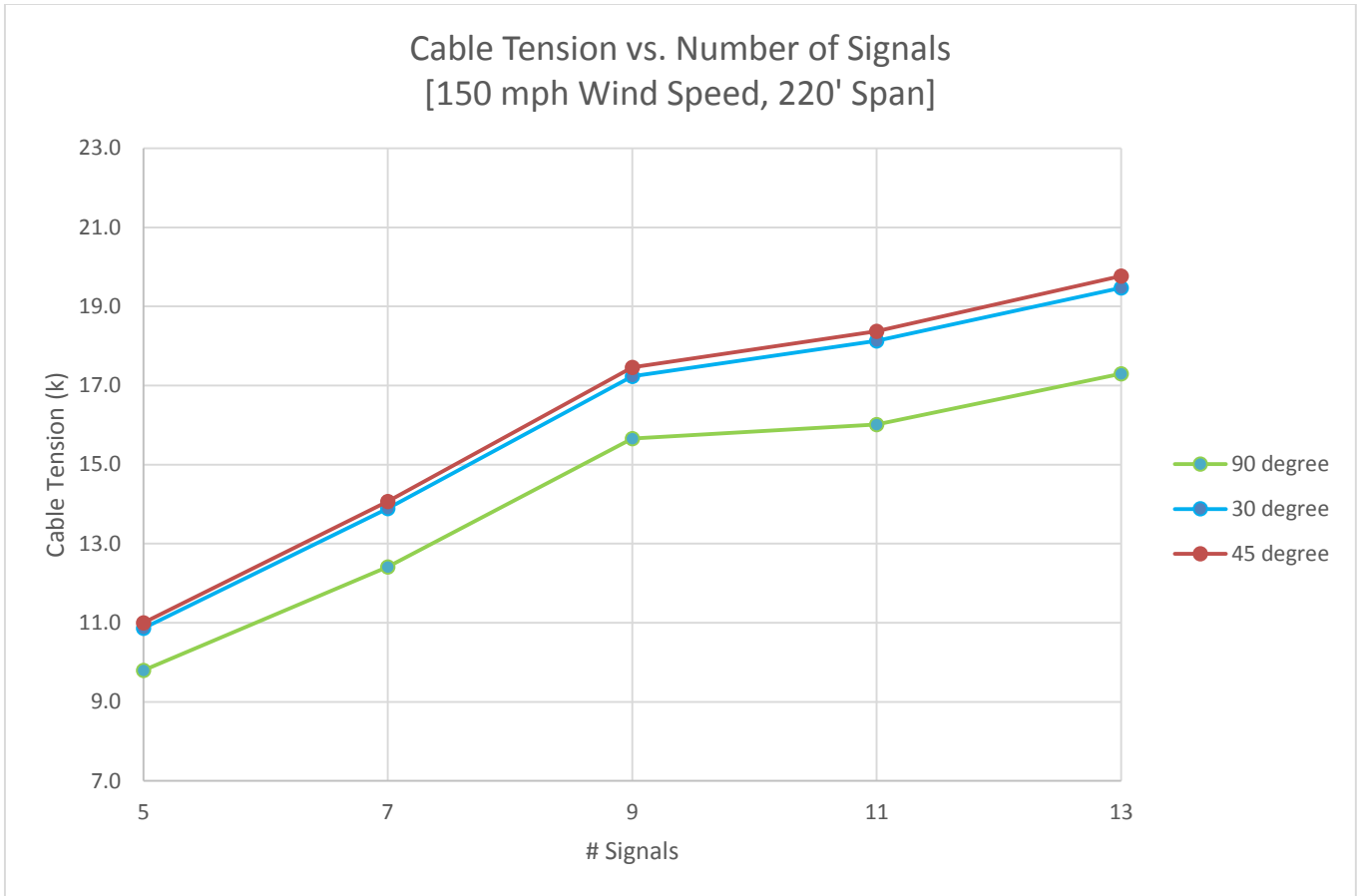

Figure 94 – GTS: Cable Tension versus Number of Signals, 150 mph Wind Speed, 220 Ft. Span, with Backplates

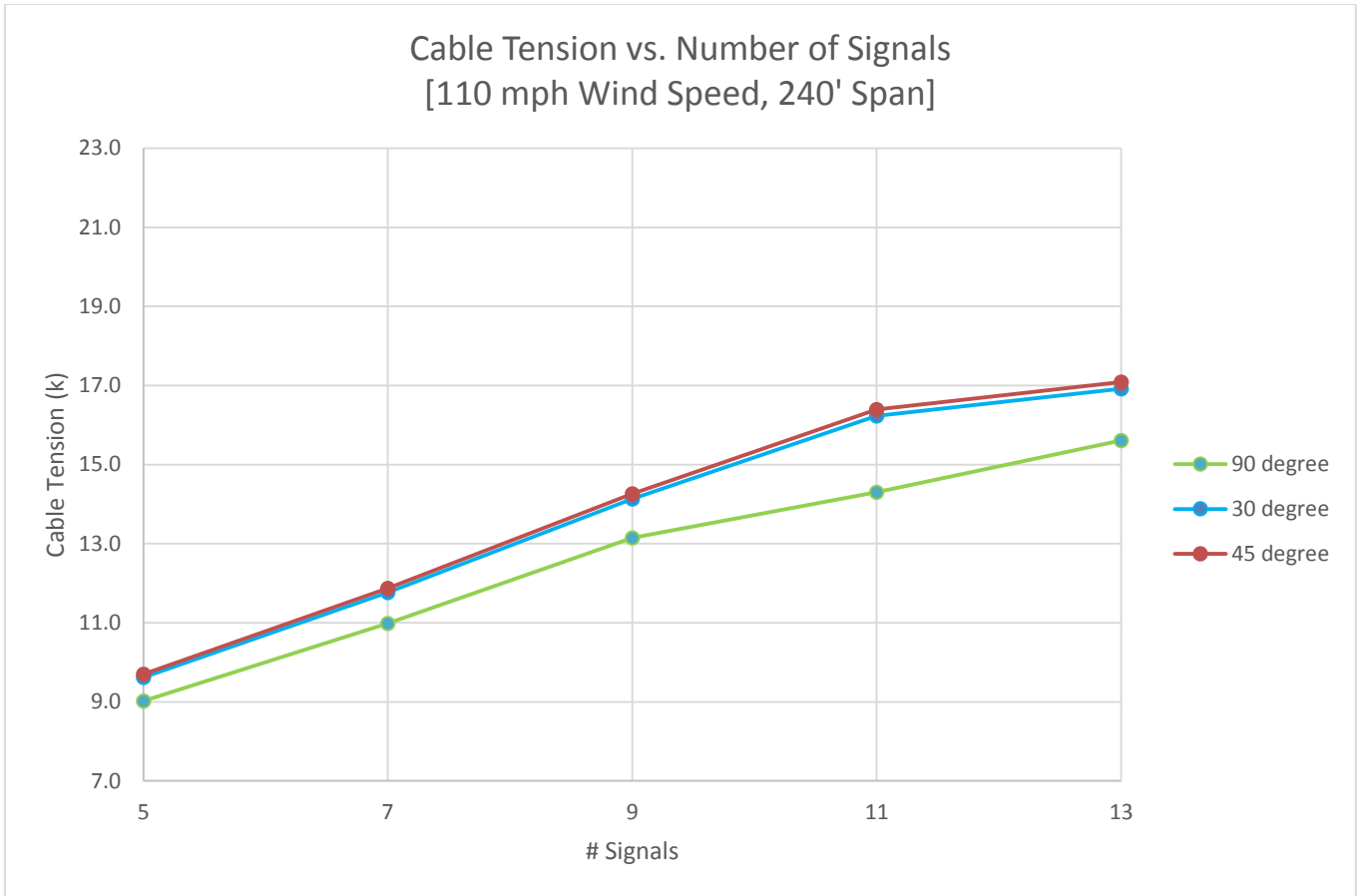

Figure 95 – GTS: Cable Tension versus Number of Signals, 110 mph Wind Speed, 240 Ft. Span, with Backplates

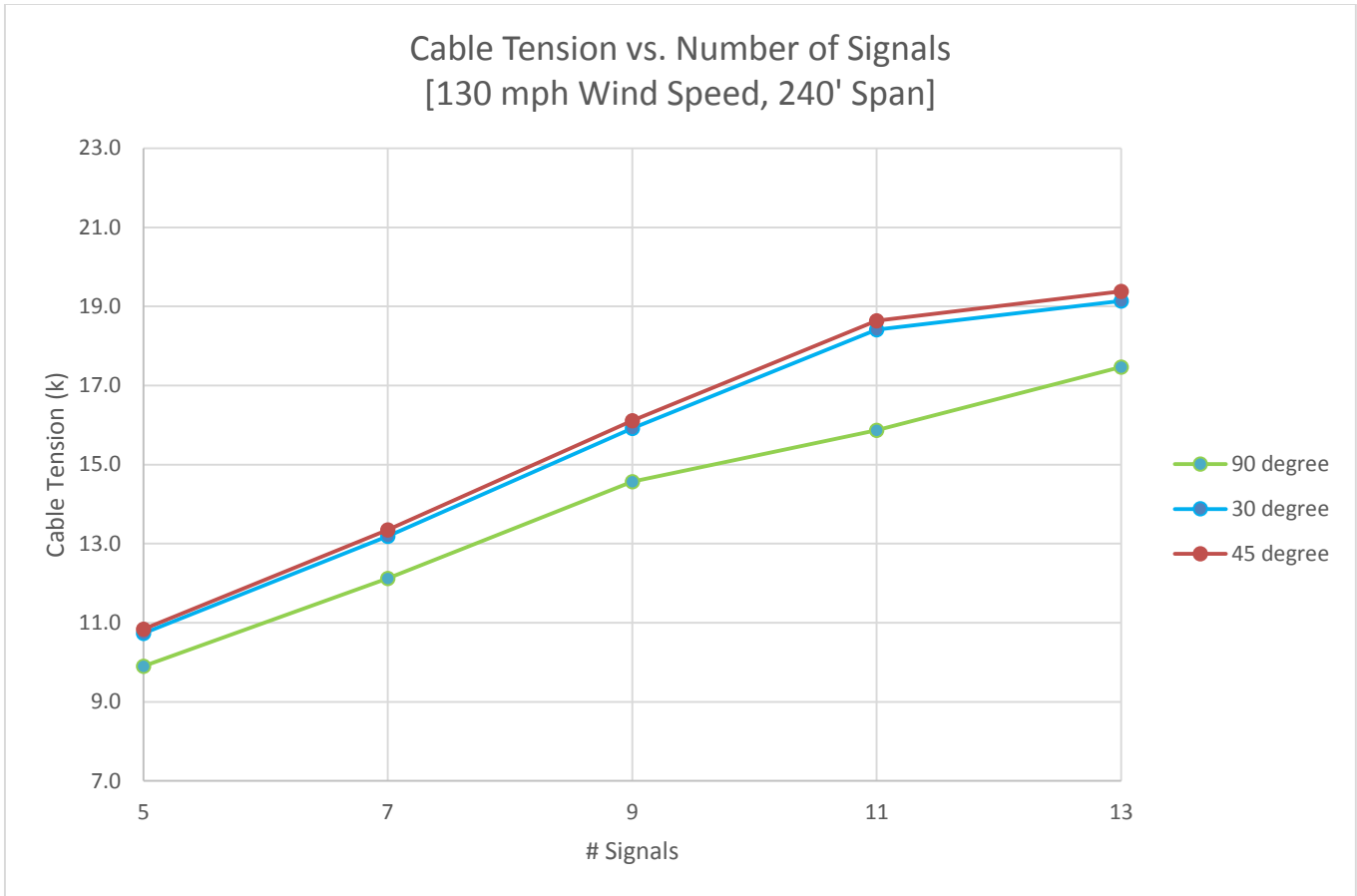

Figure 96 – GTS: Cable Tension versus Number of Signals, 130 mph Wind Speed, 240 Ft. Span, with Backplates

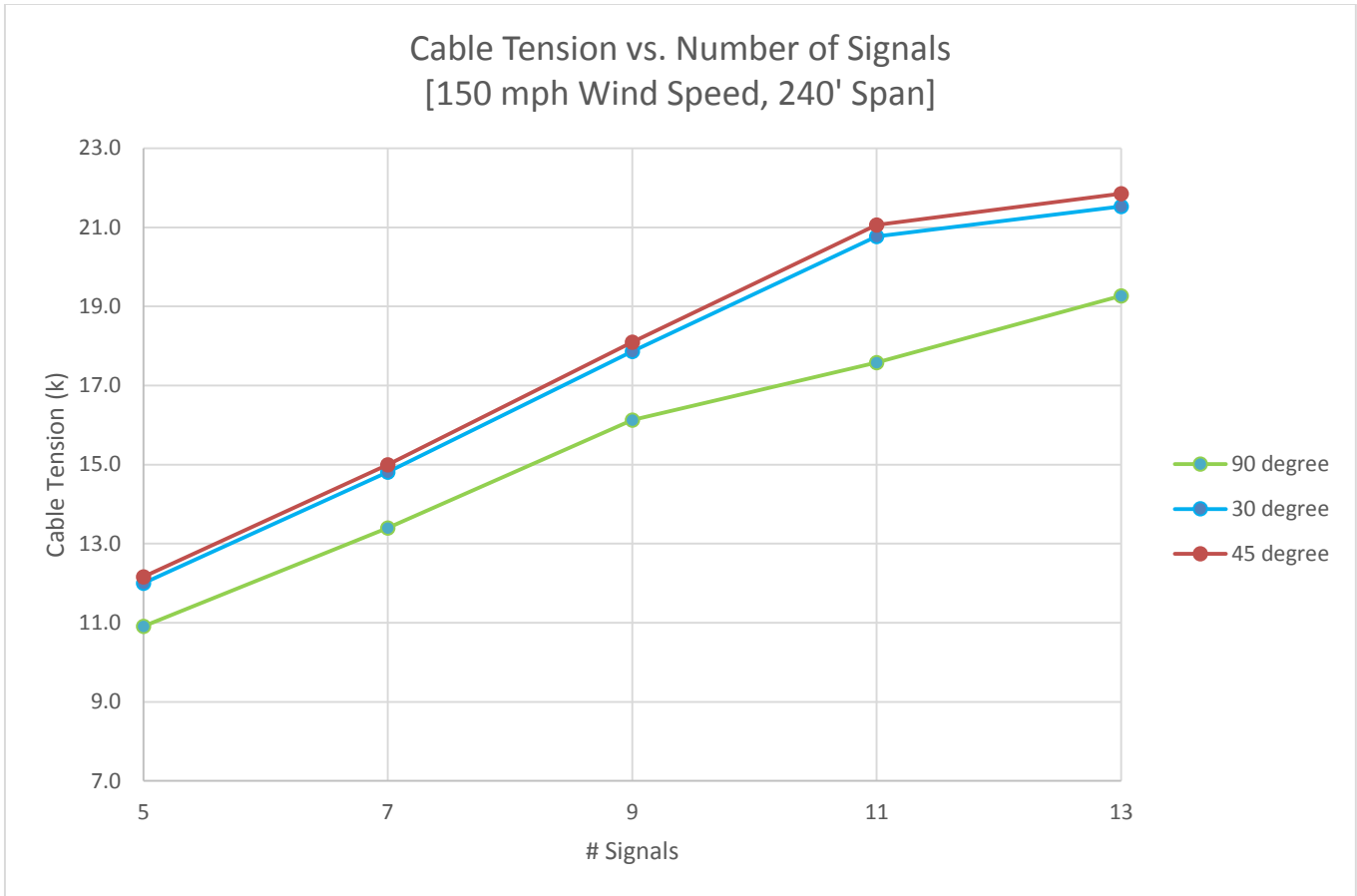

Figure 97 – GTS: Cable Tension versus Number of Signals, 150 mph Wind Speed, 240 Ft. Span, with Backplates

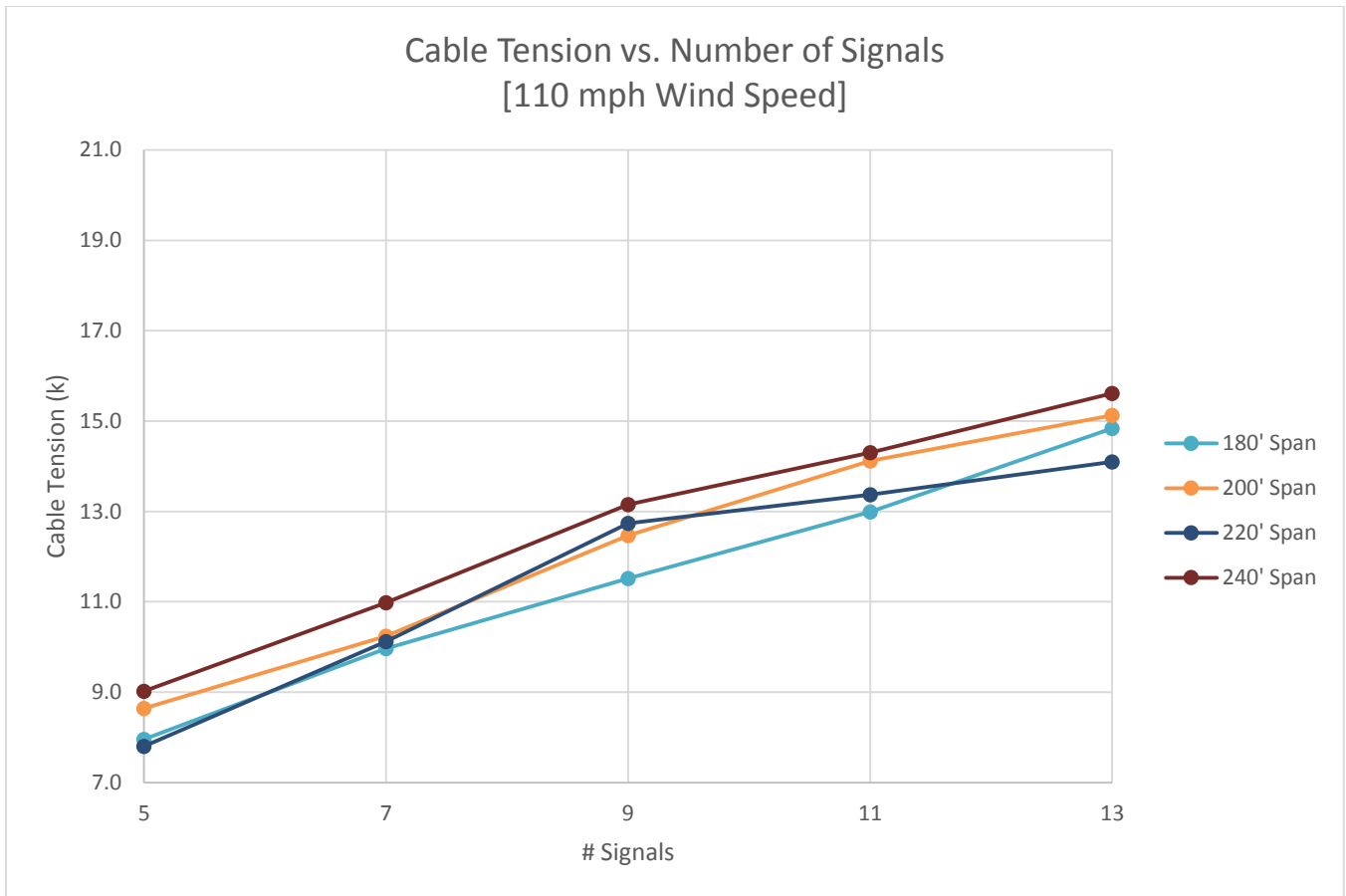

Figure 98 – GTS: Cable Tension versus Number of Signals, 110 mph Wind Speed, No Skew, with Backplates

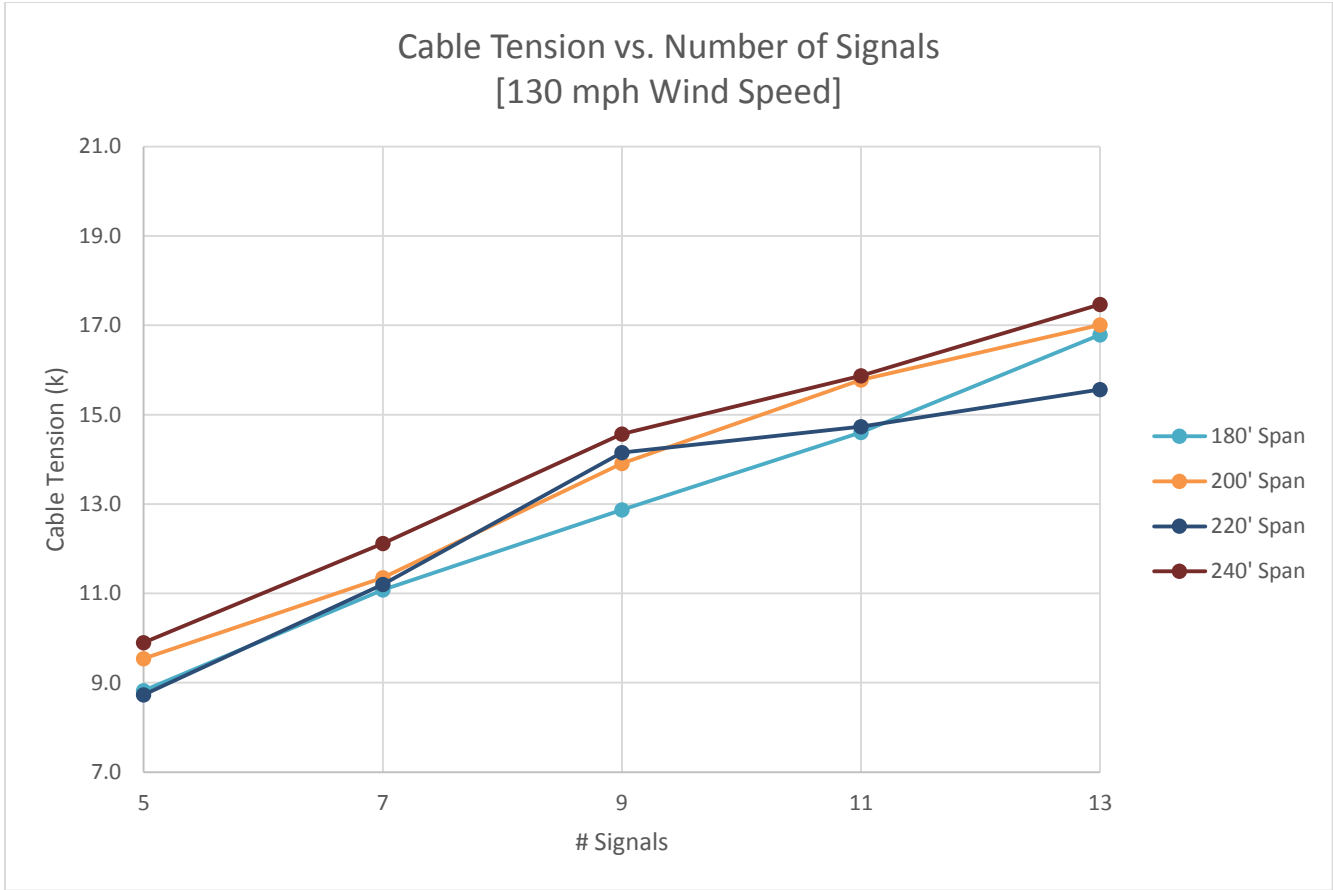

Figure 99 – GTS: Cable Tension versus Number of Signals, 130 mph Wind Speed, No Skew, with Backplates

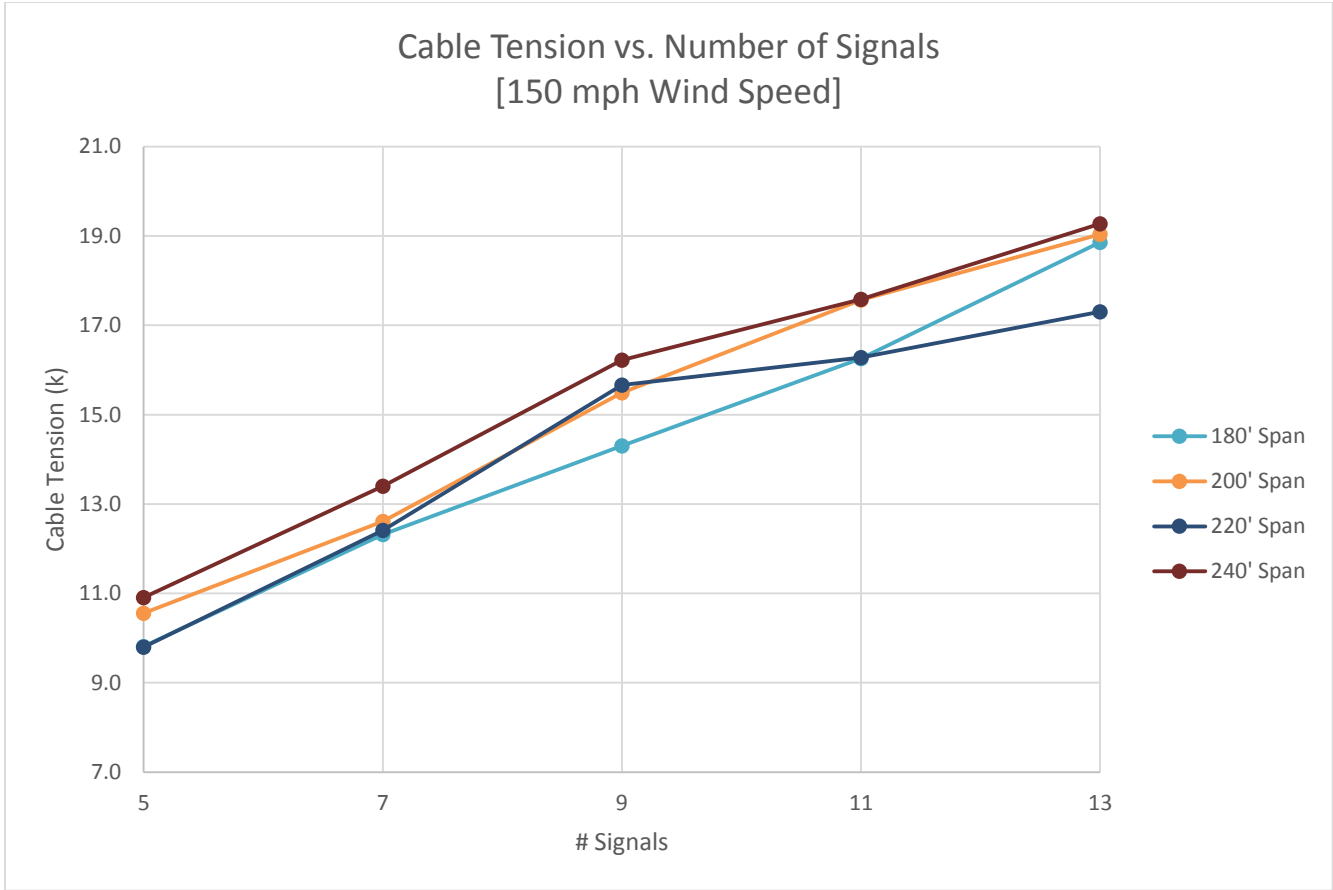

Figure 100 – GTS: Cable Tension versus Number of Signals, 150 mph Wind Speed, No Skew, with Backplates

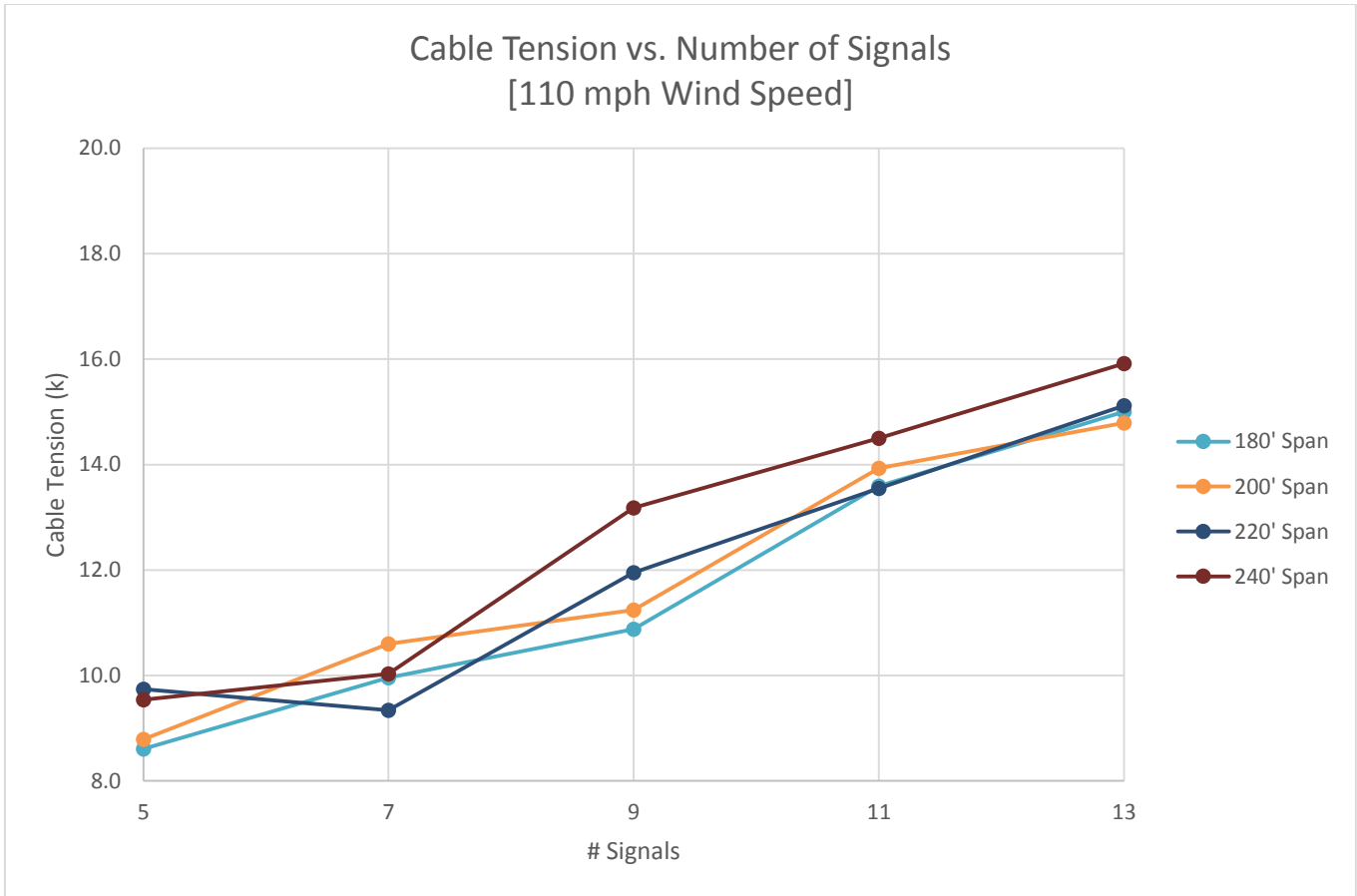

Figure 101 – GTS: Cable Tension versus Number of Signals, 110 mph Wind Speed, 15 Degree Skew, with Backplates

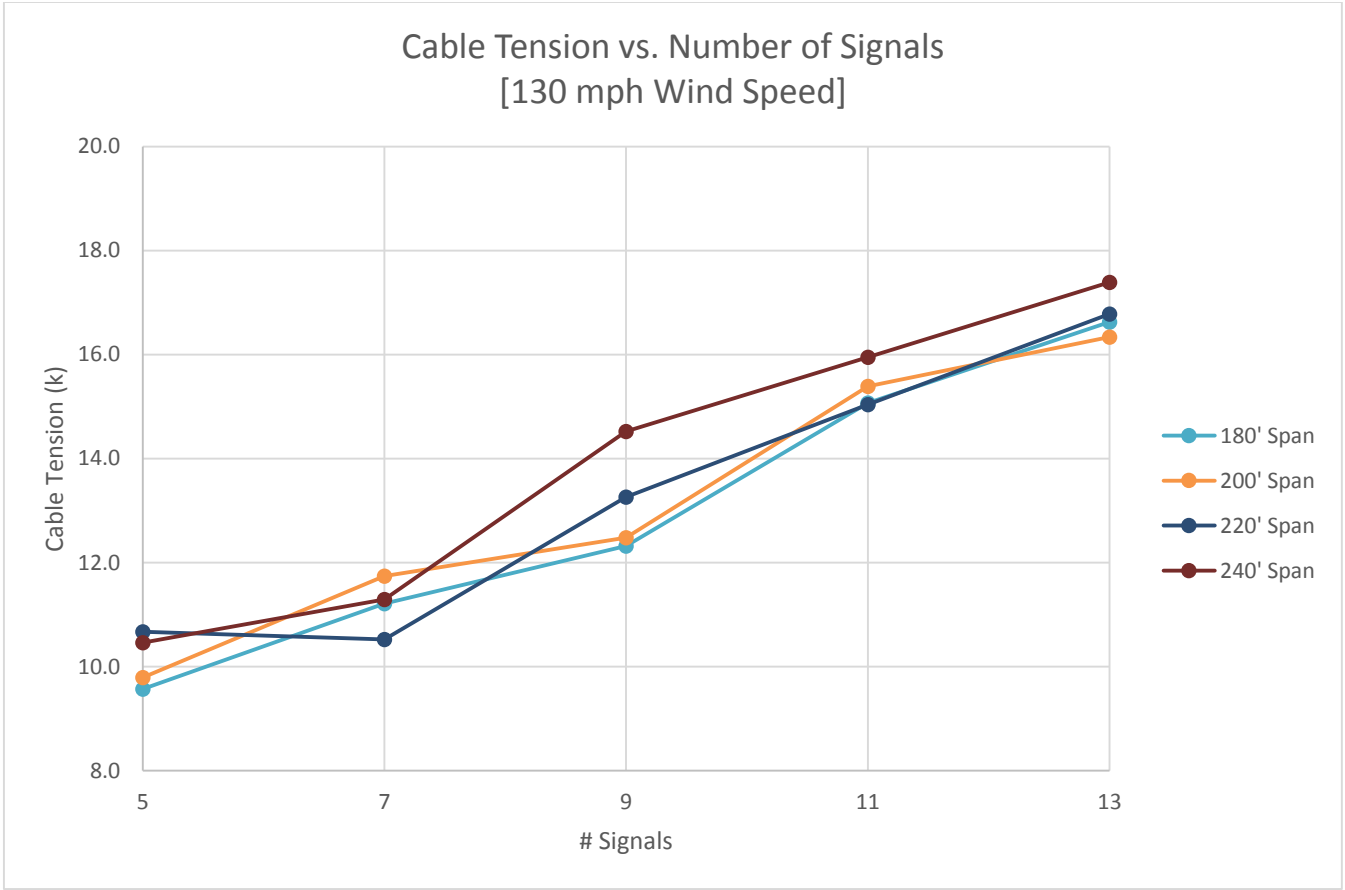

Figure 102 – GTS: Cable Tension versus Number of Signals, 130 mph Wind Speed, 15 Degree Skew, with Backplates

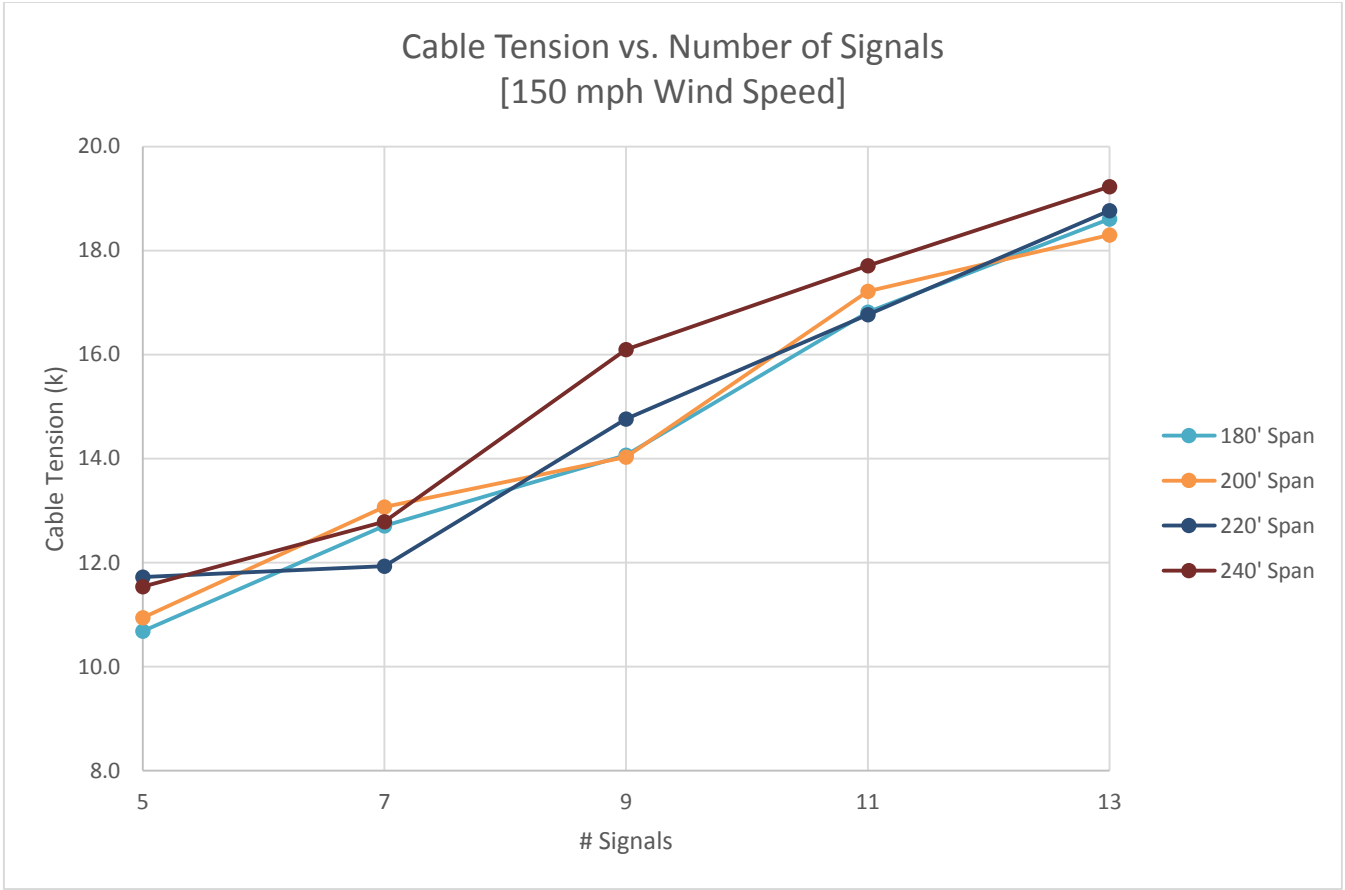

Figure 103 – GTS: Cable Tension versus Number of Signals, 150 mph Wind Speed, 15 Degree Skew, with Backplates

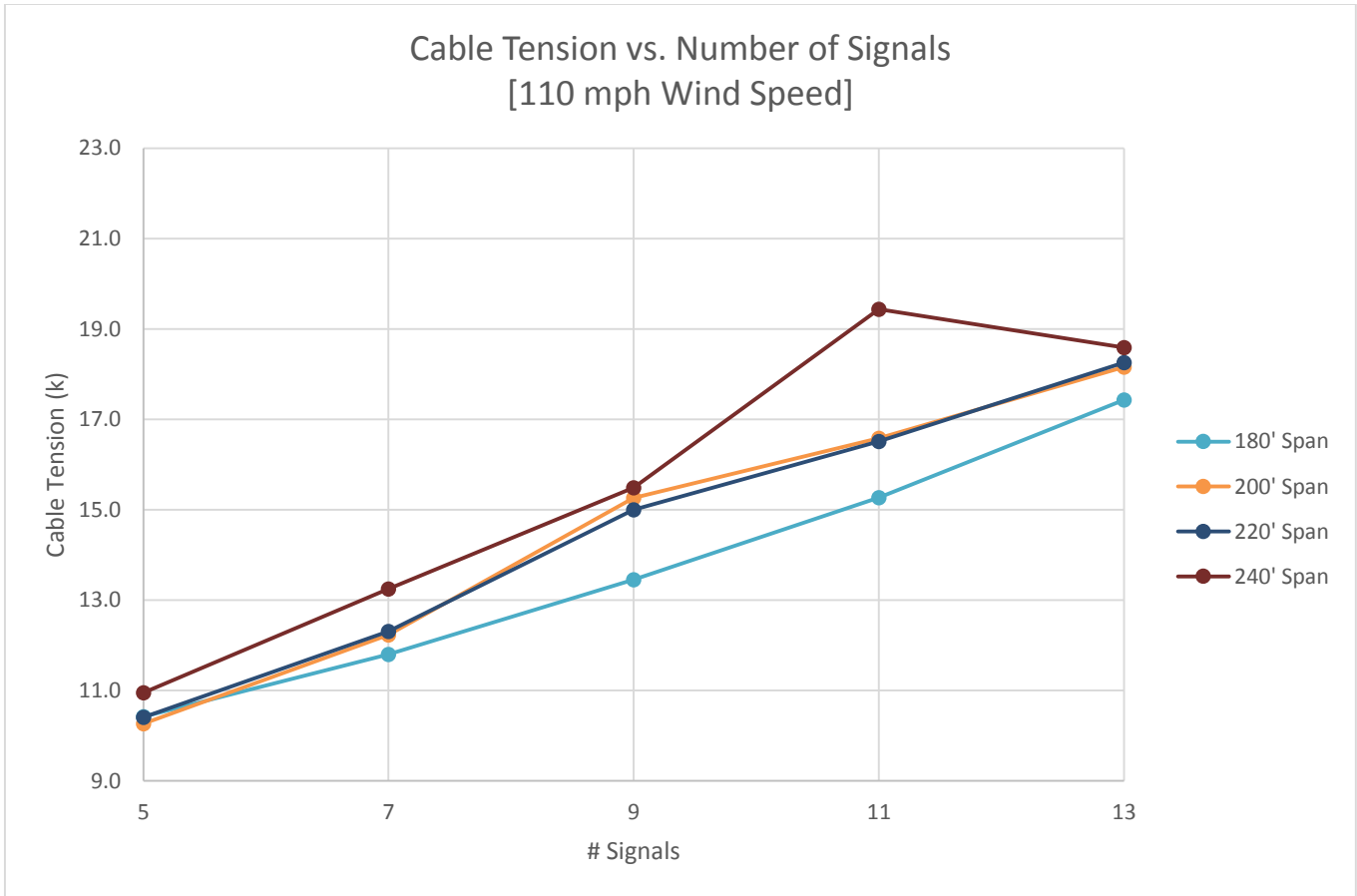

Figure 104 – GTS: Cable Tension versus Number of Signals, 110 mph Wind Speed, 30 Degree Skew, with Backplates

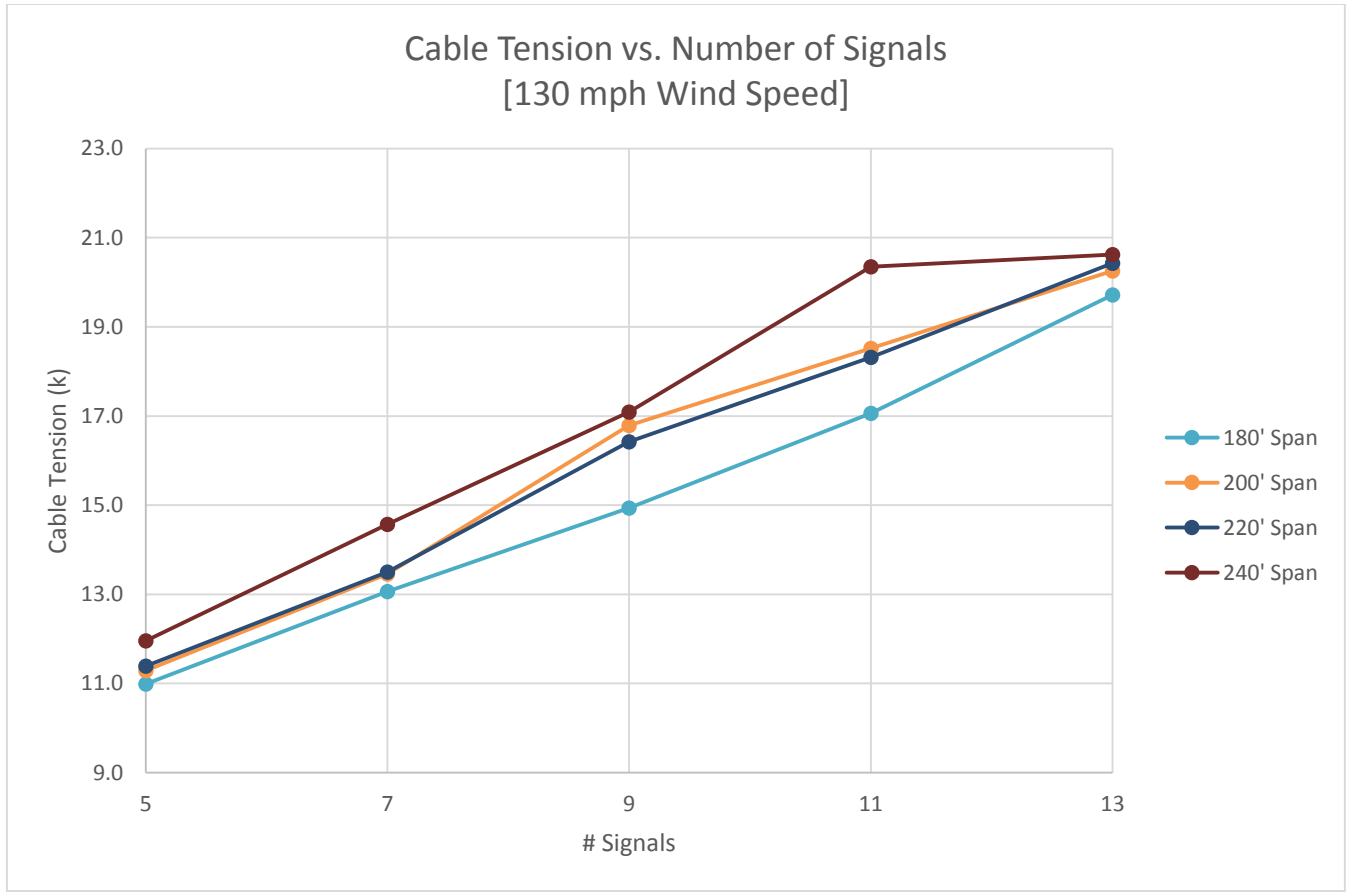

Figure 105 – GTS: Cable Tension versus Number of Signals, 130 mph Wind Speed, 30 Degree Skew, with Backplates

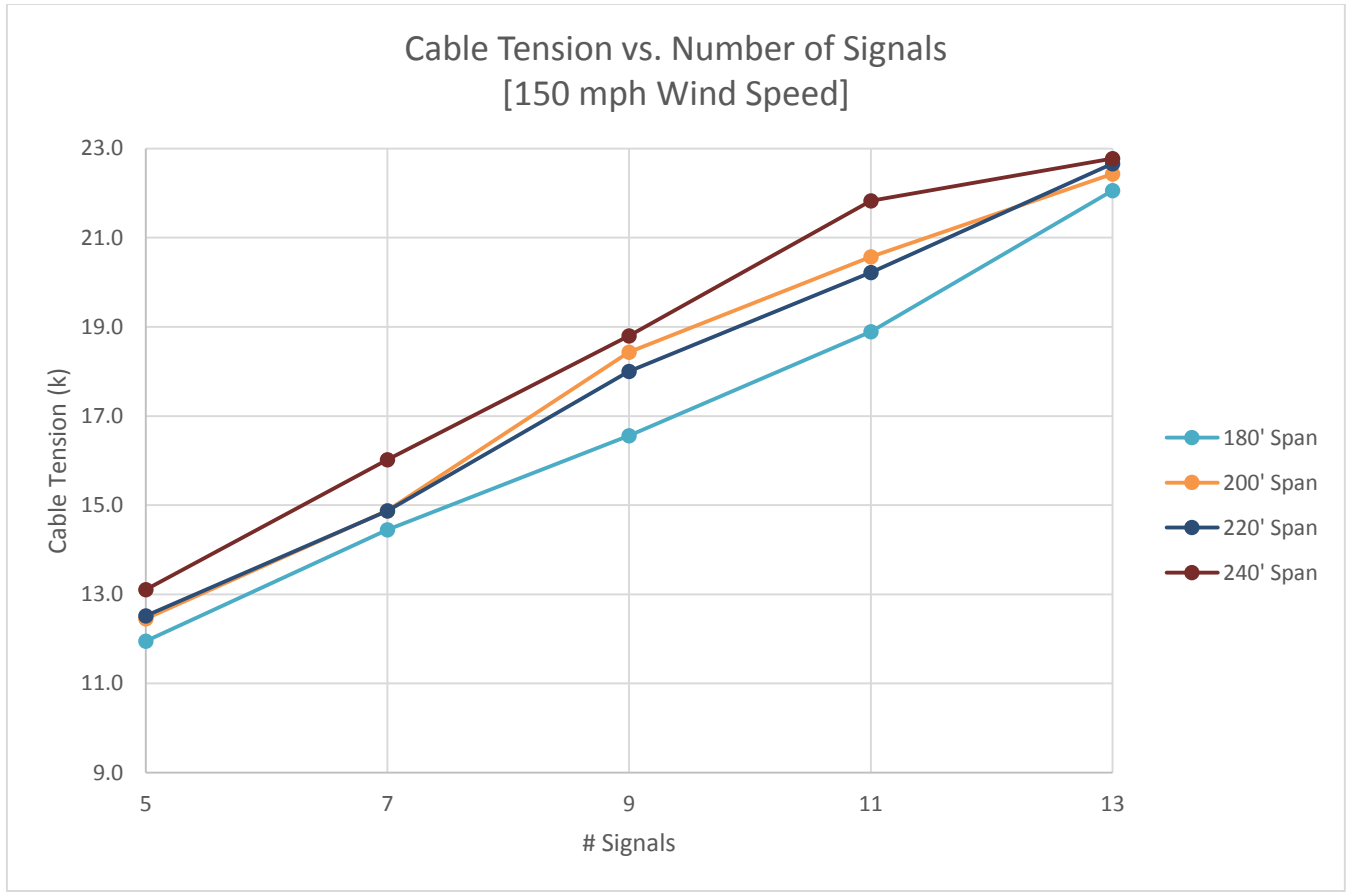

Figure 106 – GTS: Cable Tension versus Number of Signals, 150 mph Wind Speed, 30 Degree Skew, with Backplates

Span	Wind Speed	5 Signals	7 Signals	9 Signals	11 Signals	13 Signals
180ft	110mph	1.08	1.00	0.94	1.05	1.01
	130mph	1.09	1.01	0.96	1.03	0.99
	150mph	1.09	1.03	0.98	1.03	0.99
200ft	110mph	1.02	1.04	0.90	0.99	0.98
	130mph	1.03	1.03	0.90	0.98	0.96
	150mph	1.04	1.04	0.91	0.98	0.96
220ft	110mph	1.25	0.92	0.94	1.01	1.07
	130mph	1.22	0.94	0.94	1.02	1.08
	150mph	1.20	0.96	0.94	1.03	1.08
240ft	110mph	1.06	0.91	1.00	1.01	1.02
	130mph	1.06	0.93	1.00	1.01	1.00
	150mph	1.06	0.95	0.99	1.01	1.00

Note – The 10 largest values are highlighted in red. The 10 smallest values are highlighted in green.

Table 21 – GTS: Cable Tension 15 Degree Skew / Cable Tension 0 Degree Skew, with Backplates

Span	Wind Speed	5 Signals	7 Signals	9 Signals	11 Signals	13 Signals
180ft	110mph	1.31	1.18	1.17	1.18	1.17
	130mph	1.25	1.18	1.16	1.17	1.17
	150mph	1.22	1.17	1.16	1.16	1.17
200ft	110mph	1.19	1.19	1.22	1.17	1.20
	130mph	1.18	1.19	1.21	1.17	1.19
	150mph	1.18	1.18	1.19	1.17	1.18
220ft	110mph	1.33	1.22	1.18	1.23	1.30
	130mph	1.30	1.21	1.16	1.24	1.31
	150mph	1.28	1.20	1.15	1.24	1.31
240ft	110mph	1.21	1.21	1.18	1.36	1.19
	130mph	1.21	1.20	1.17	1.28	1.18
	150mph	1.20	1.20	1.16	1.24	1.18

Note – The 10 largest values are highlighted in red. The 10 smallest values are highlighted in green.

Table 22 – GTS: Cable Tension 30 Degree Skew / Cable Tension 0 Degree Skew, with Backplates

Span	Wind Speed	5 Signals	7 Signals	9 Signals	11 Signals	13 Signals
180ft	110mph	1.07	1.08	1.09	1.09	1.10
	130mph	1.10	1.10	1.10	1.11	1.12
	150mph	1.11	1.12	1.12	1.12	1.13
200ft	110mph	1.07	1.08	1.08	1.08	1.09
	130mph	1.09	1.10	1.10	1.11	1.11
	150mph	1.11	1.11	1.11	1.12	1.12
220ft	110mph	1.09	1.09	1.06	1.09	1.08
	130mph	1.09	1.10	1.08	1.11	1.10
	150mph	1.11	1.12	1.10	1.13	1.13
240ft	110mph	1.07	1.07	1.07	1.13	1.08
	130mph	1.08	1.09	1.09	1.16	1.10
	150mph	1.10	1.11	1.11	1.18	1.12

Note – The 10 largest values are highlighted in red. The 10 smallest values are highlighted in green.

Table 23 – GTS: Cable Tension 30 Degree Wind Angle / Cable Tension 0 Degree Wind Angle, with Backplates

Span	Wind Speed	5 Signals	7 Signals	9 Signals	11 Signals	13 Signals
180ft	110mph	1.09	1.09	1.10	1.11	1.11
	130mph	1.11	1.11	1.12	1.13	1.14
	150mph	1.13	1.13	1.14	1.14	1.15
200ft	110mph	1.08	1.09	1.09	1.10	1.10
	130mph	1.10	1.11	1.12	1.12	1.13
	150mph	1.12	1.13	1.13	1.13	1.14
220ft	110mph	1.10	1.09	1.07	1.10	1.09
	130mph	1.11	1.11	1.10	1.12	1.12
	150mph	1.12	1.13	1.11	1.15	1.14
240ft	110mph	1.08	1.08	1.08	1.15	1.09
	130mph	1.09	1.10	1.11	1.17	1.11
	150mph	1.11	1.12	1.12	1.20	1.13

Note – The 10 largest values are highlighted in red. The 10 smallest values are highlighted in green.

Table 24 – GTS: Cable Tension 45 Degree Wind Angle / Cable Tension 0 Degree Wind Angle, with Backplates

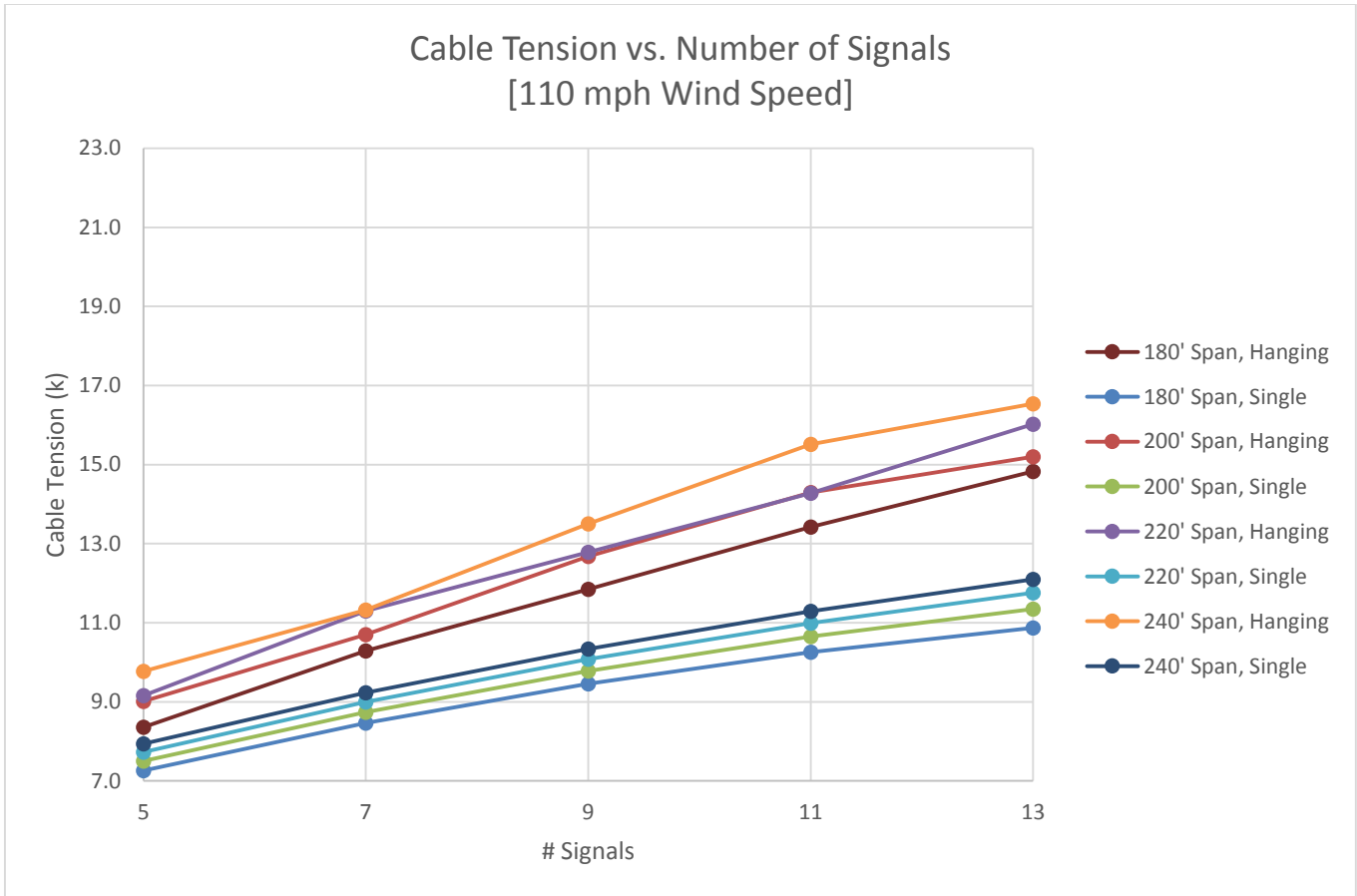

Figure 107 – GTS: Cable Tension versus Number of Signals, Hanging Box and Single Span, 110 mph Wind Speed, with Backplates

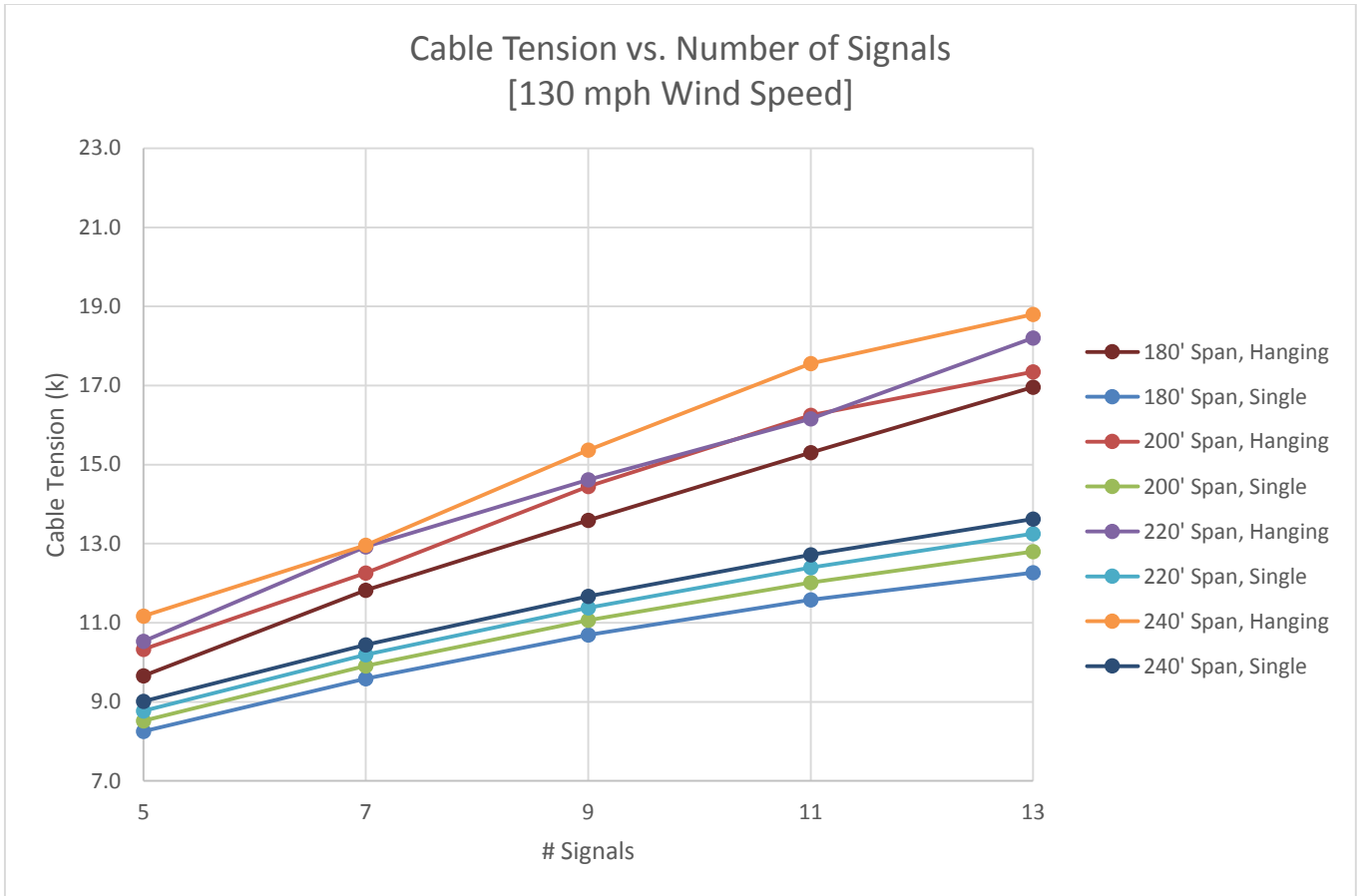

Figure 108 – GTS: Cable Tension versus Number of Signals, Hanging Box and Single Span, 130 mph Wind Speed, with Backplates

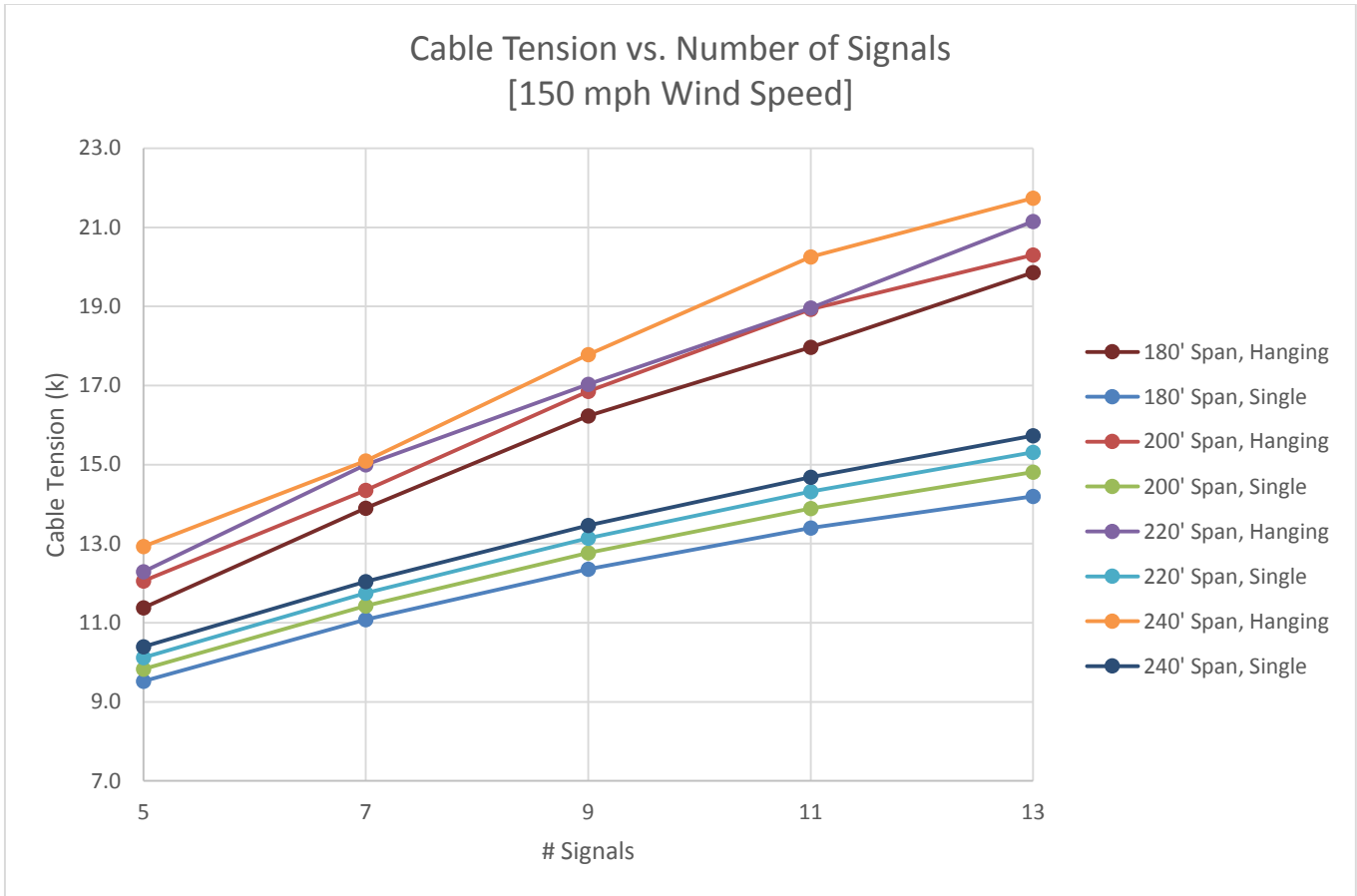

Figure 109 – GTS: Cable Tension versus Number of Signals, Hanging Box and Single Span, 150 mph Wind Speed, with Backplates

Hanging / Single						
Span	Wind Speed	5 Signals	7 Signals	9 Signals	11 Signals	13 Signals
180ft	110mph	1.15	1.22	1.25	1.31	1.36
	130mph	1.17	1.23	1.27	1.32	1.38
	150mph	1.20	1.25	1.31	1.34	1.40
200ft	110mph	1.20	1.22	1.30	1.34	1.34
	130mph	1.21	1.24	1.31	1.35	1.36
	150mph	1.23	1.26	1.32	1.36	1.37
220ft	110mph	1.18	1.26	1.27	1.30	1.36
	130mph	1.20	1.27	1.28	1.30	1.37
	150mph	1.21	1.28	1.30	1.32	1.38
240ft	110mph	1.23	1.23	1.31	1.37	1.37
	130mph	1.24	1.24	1.32	1.38	1.38
	150mph	1.24	1.25	1.32	1.38	1.38

Note – The 10 largest values are highlighted in red. The 10 smallest values are highlighted in green.

Table 25 – GTS: Cable Tension Ratio, Hanging Box to Single Span, with Backplates

Appendix F – GTStrudl Screenshots

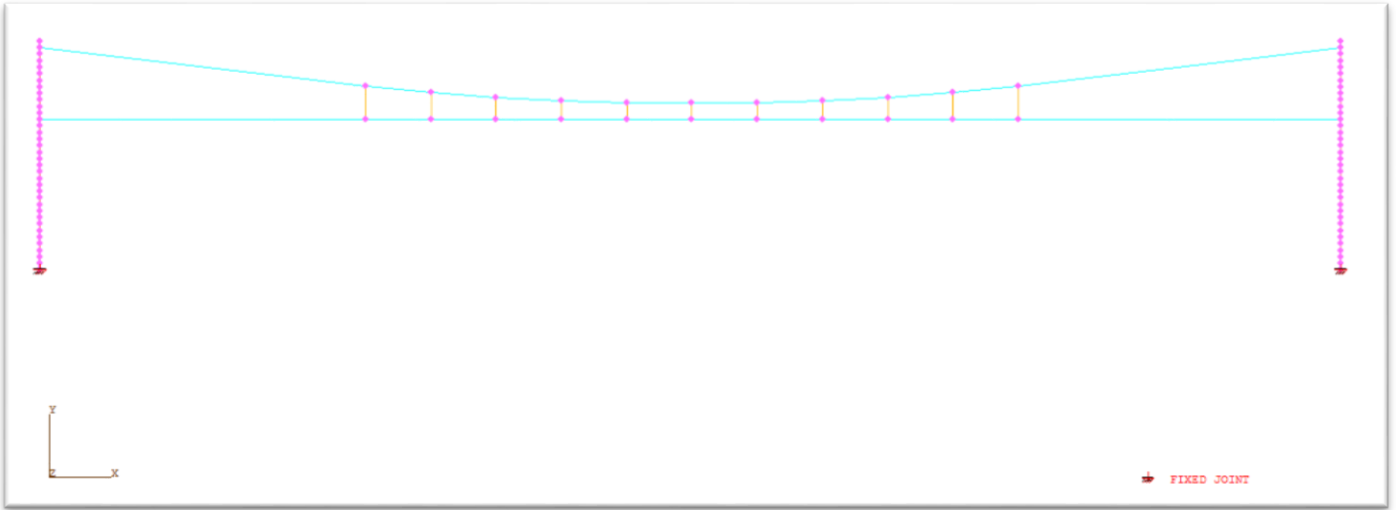

Figure 110 – Typical Single Span Model

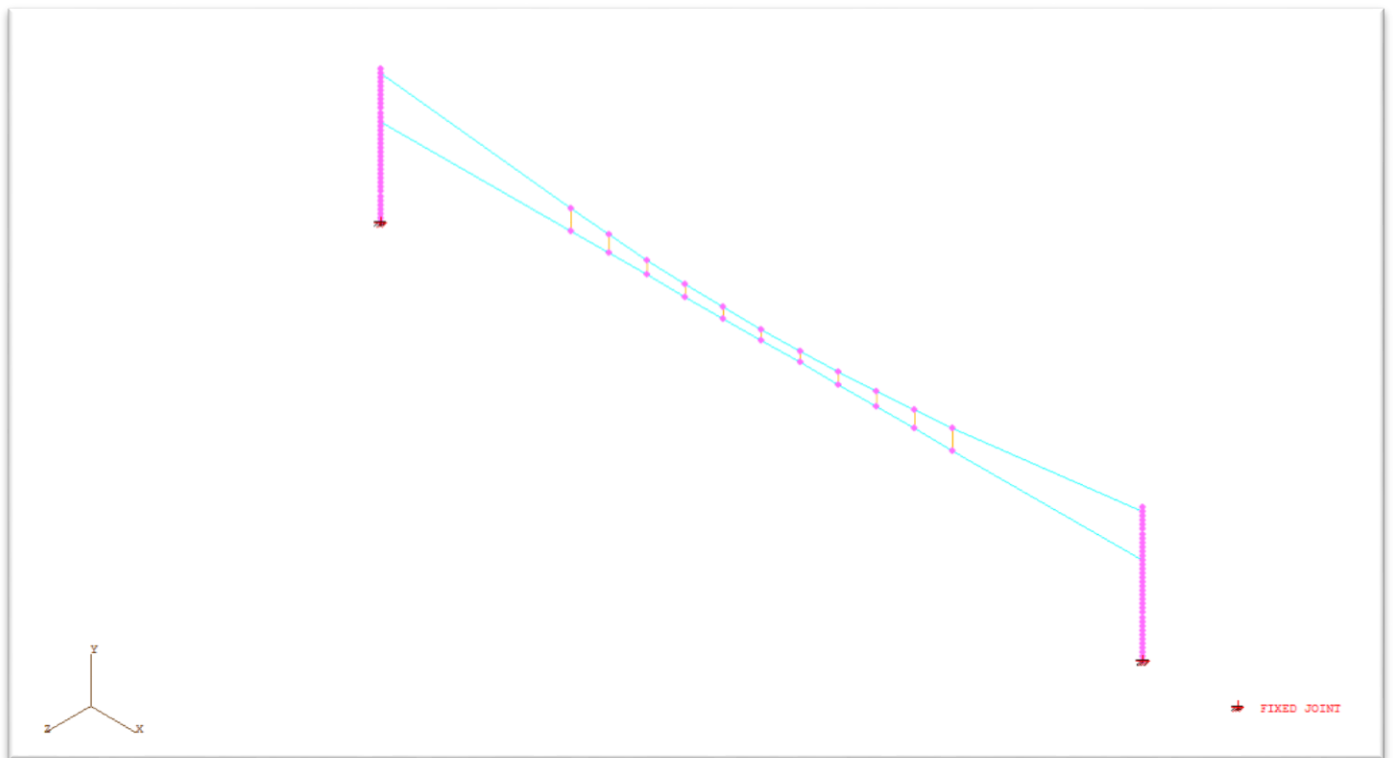

Figure 111 – Isometric View of Typical Single Span Model

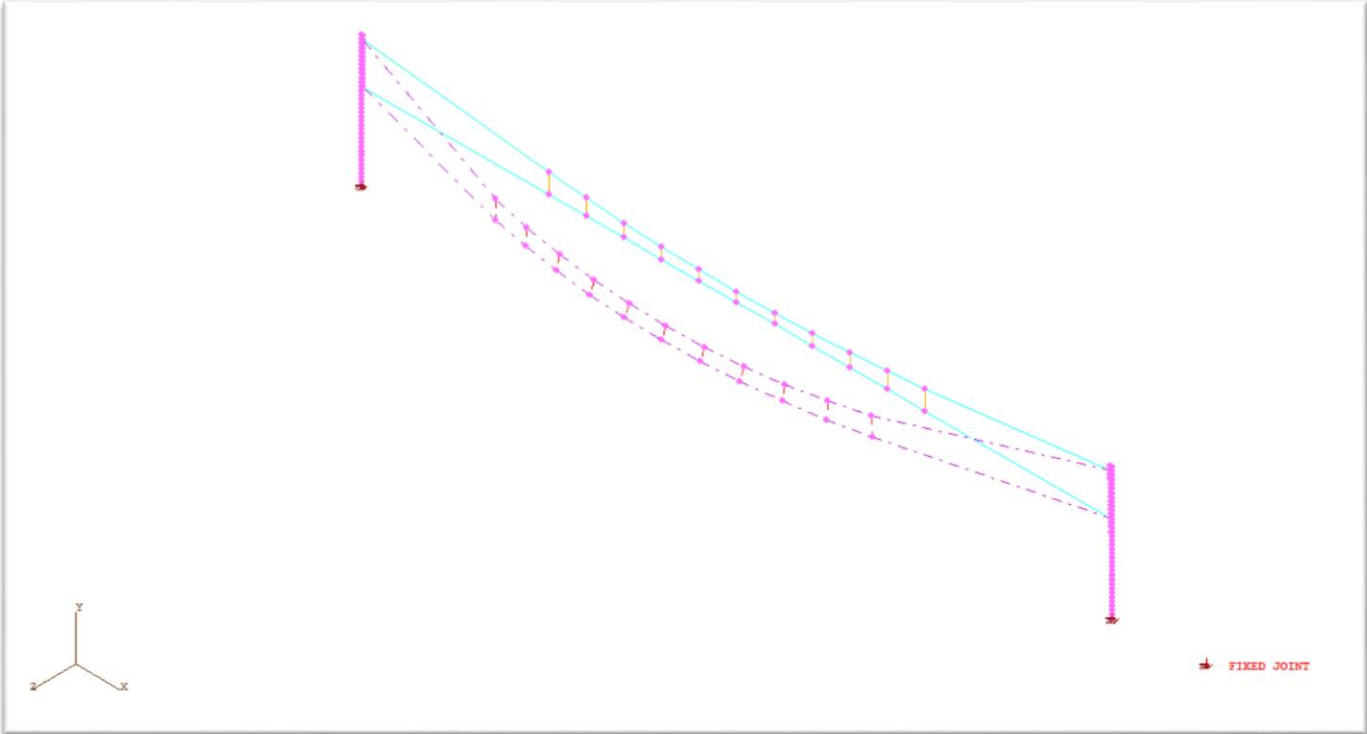

Figure 112 – Isometric View of Deflected Shape for Single Span Model

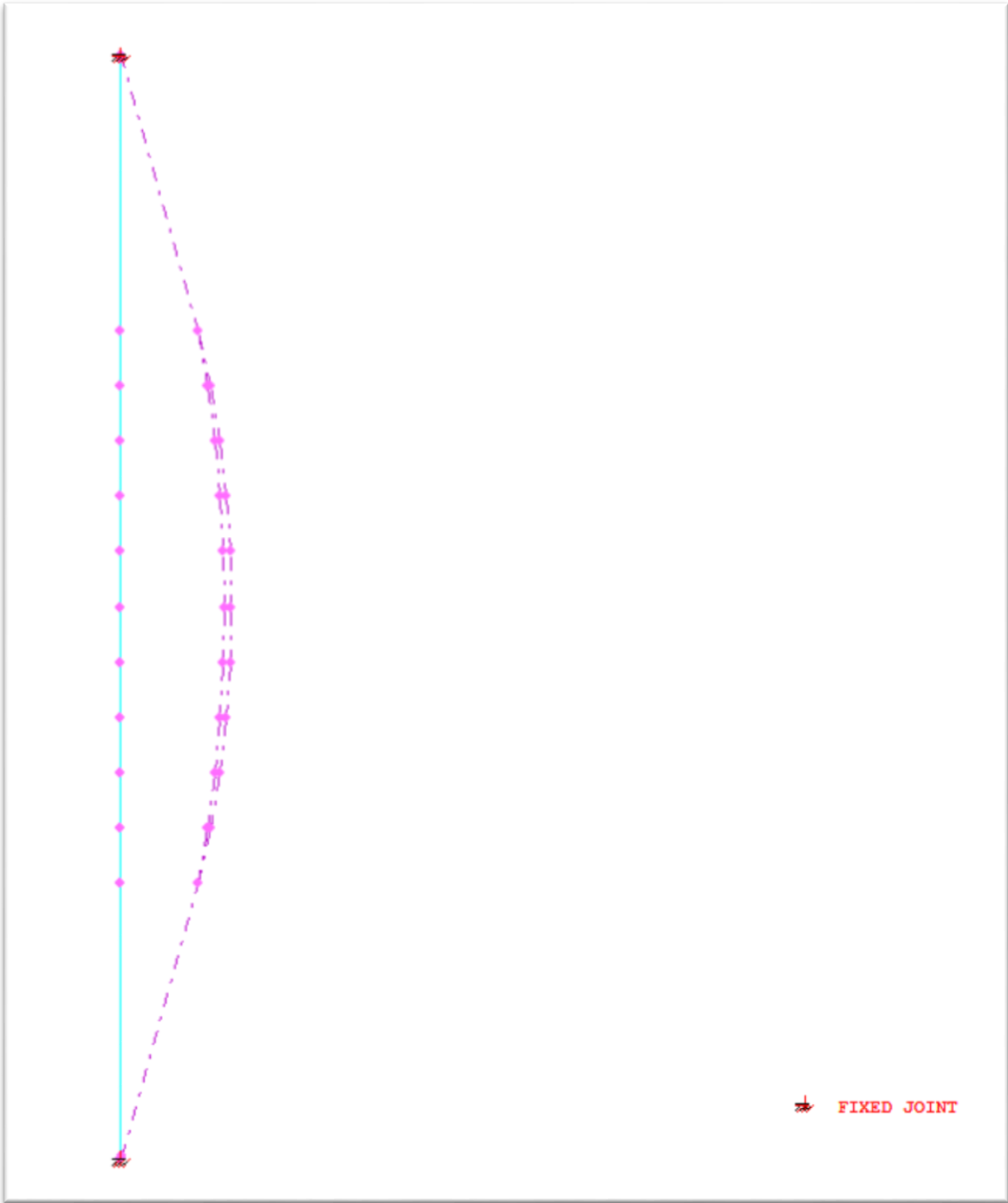

Figure 113 – Plan View of Deflected Shape for Single Span Model

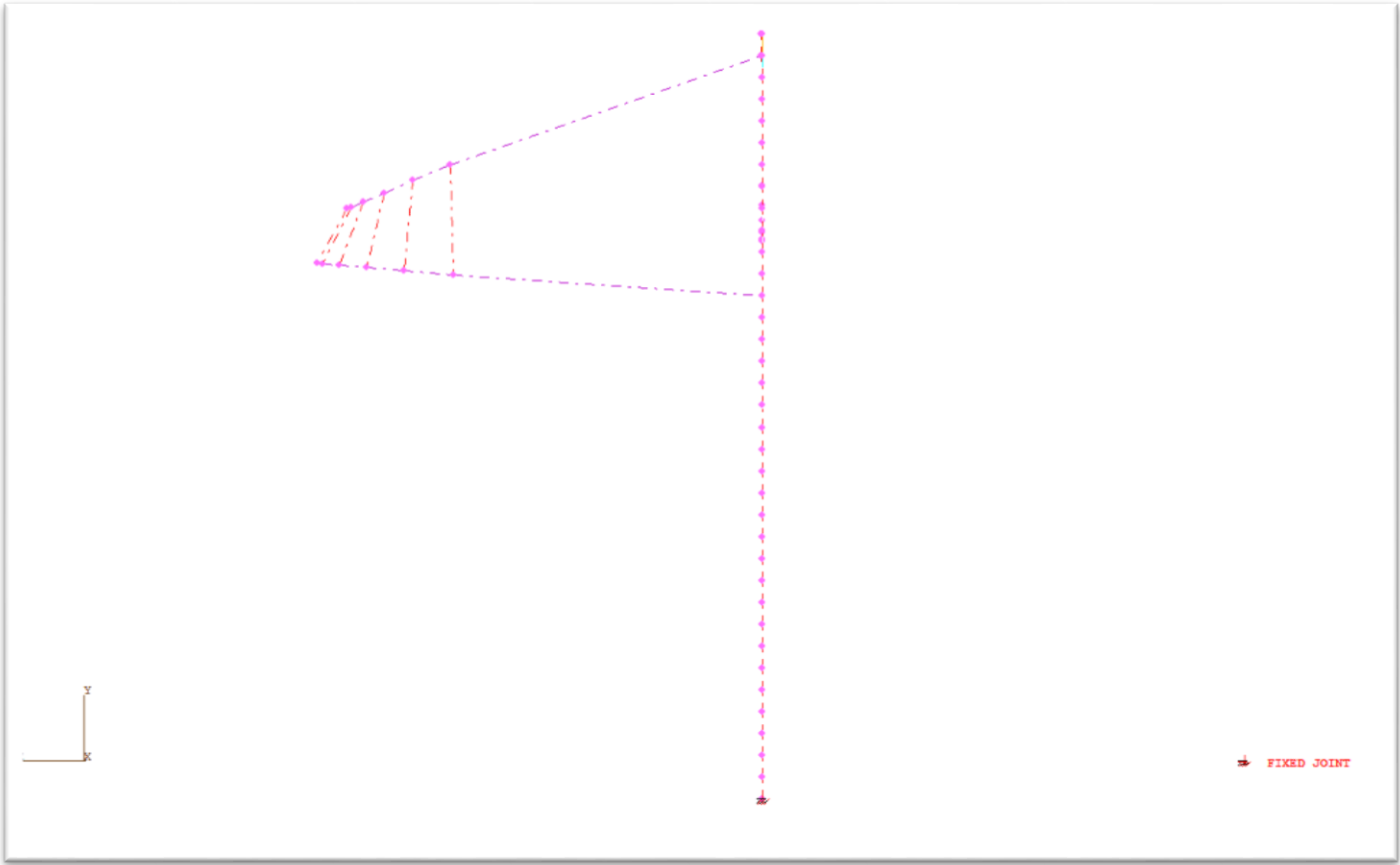

Figure 114 – Elevation View of Deflected Shape for Single Span Model

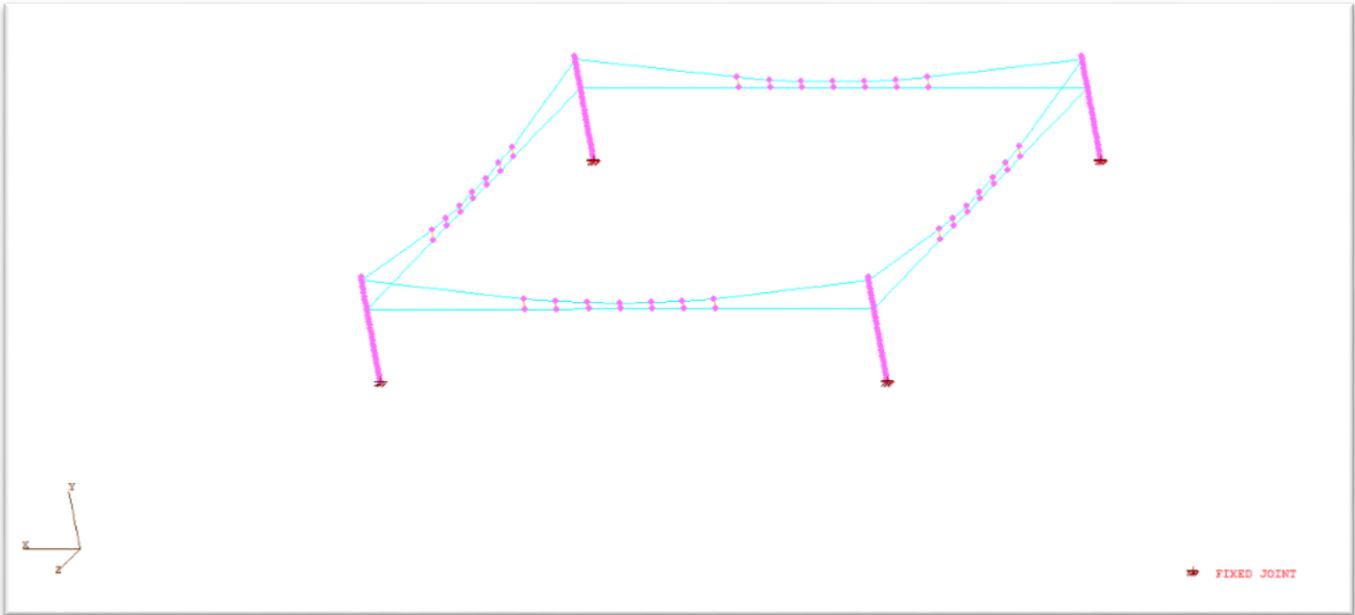

Figure 115 – Isometric View of Typical Box Configuration Model

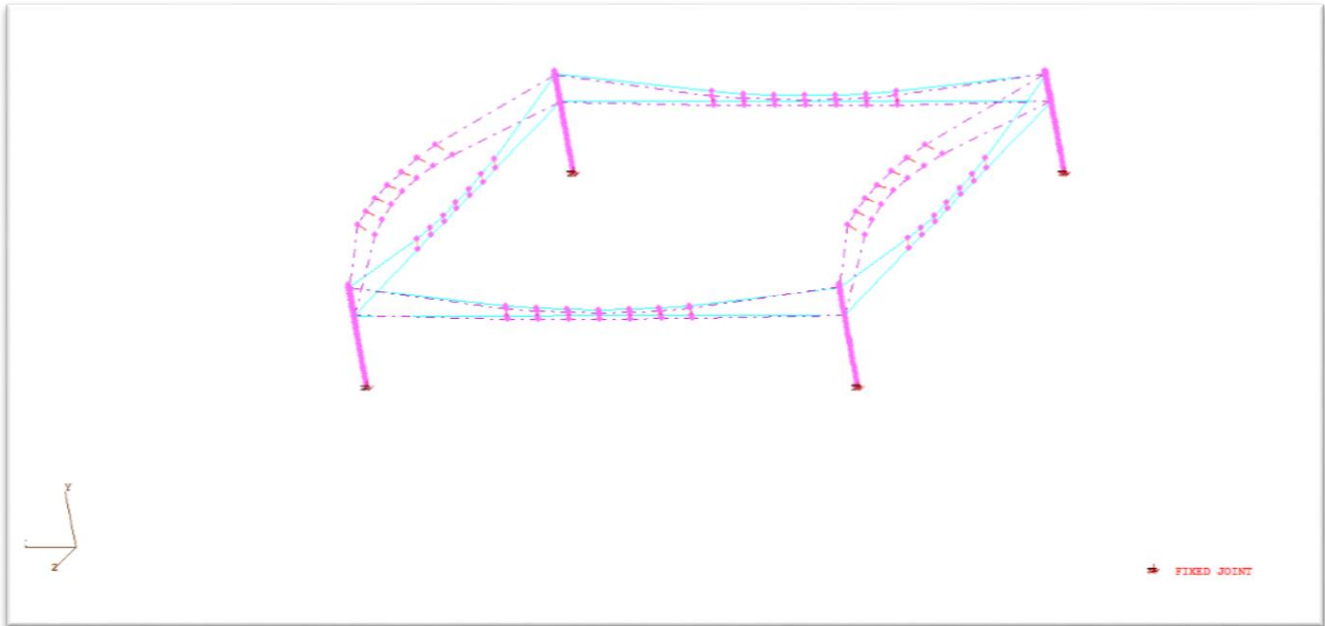

Figure 116 – Isometric View of Deflected Shape for Box Configuration Model, 90 Degree Wind Angle

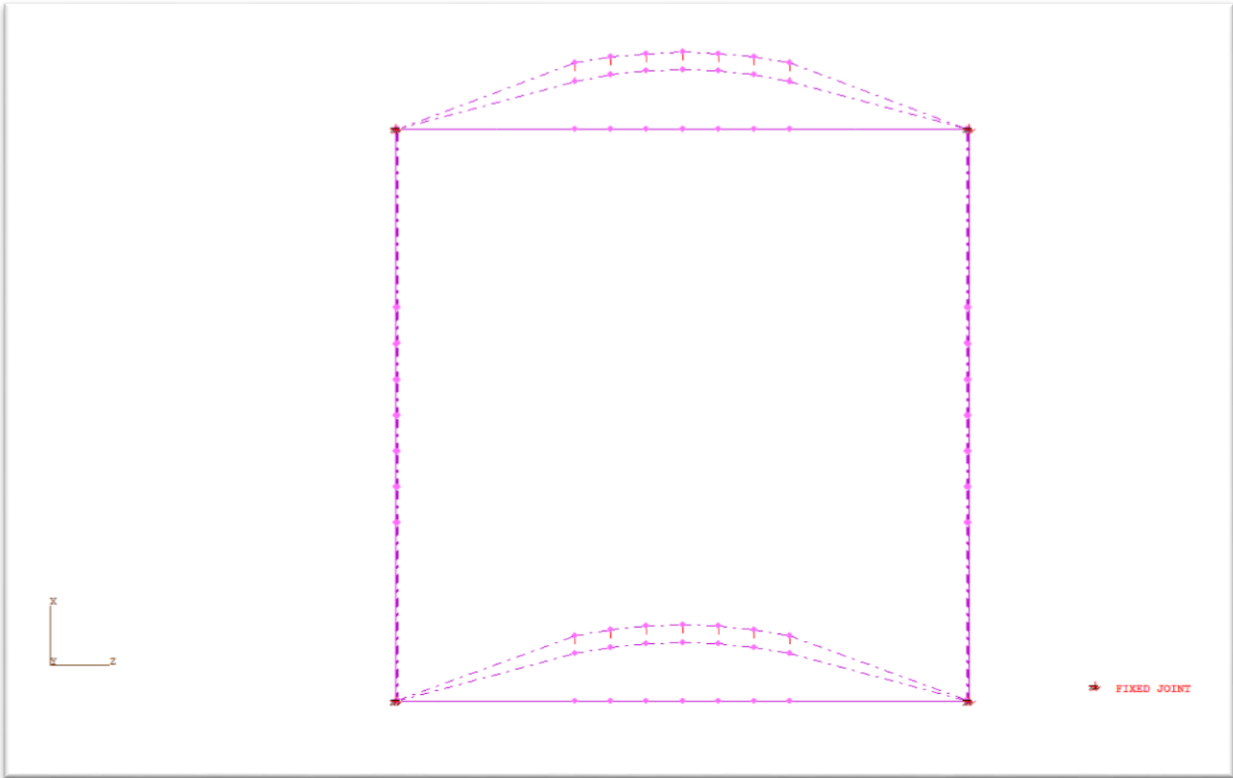

Figure 117 – Plan View of Deflected Shape for Box Configuration Model, 90 Degree Wind Angle

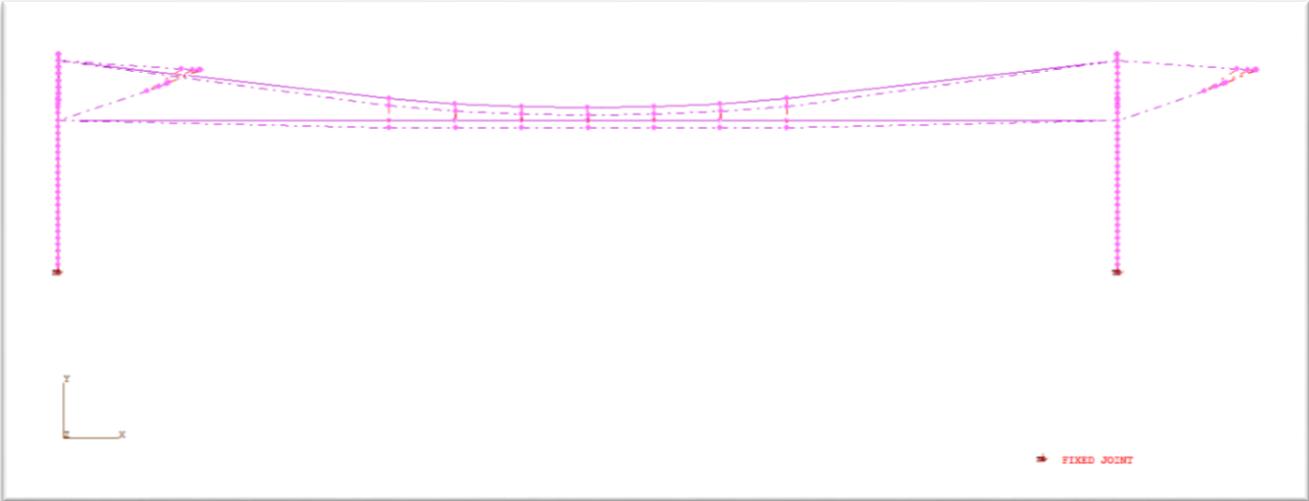

Figure 118 – Elevation View of Deflected Shape for Box Configuration Model, 90 Degree Wind Angle

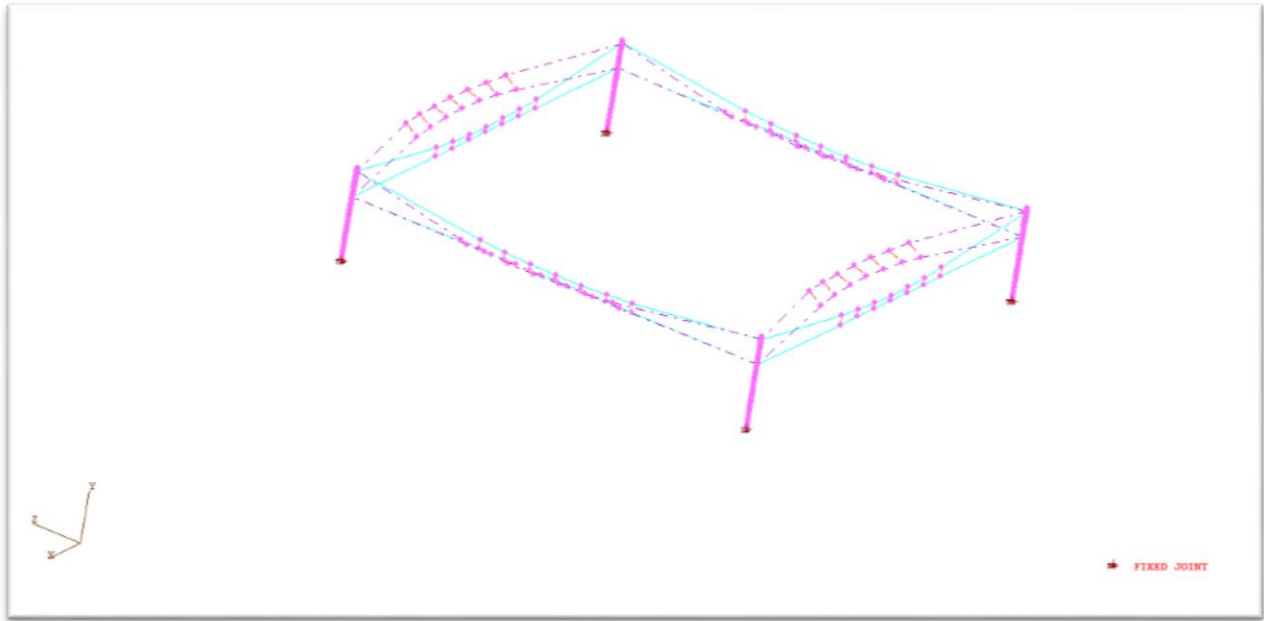

Figure 119 – Isometric View of Deflected Shape for Box Configuration Model, 45 Degree Wind Angle

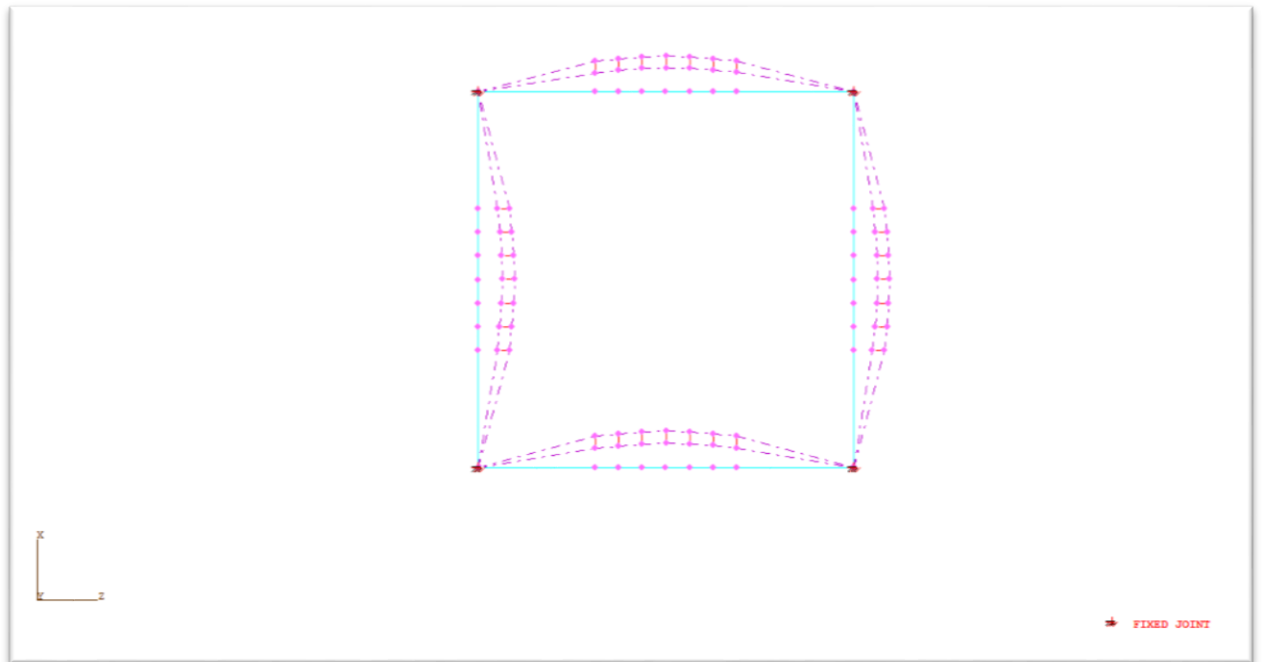

Figure 120 – Plan View of Deflected Shape for Box Configuration Model, 45 Degree Wind Angle

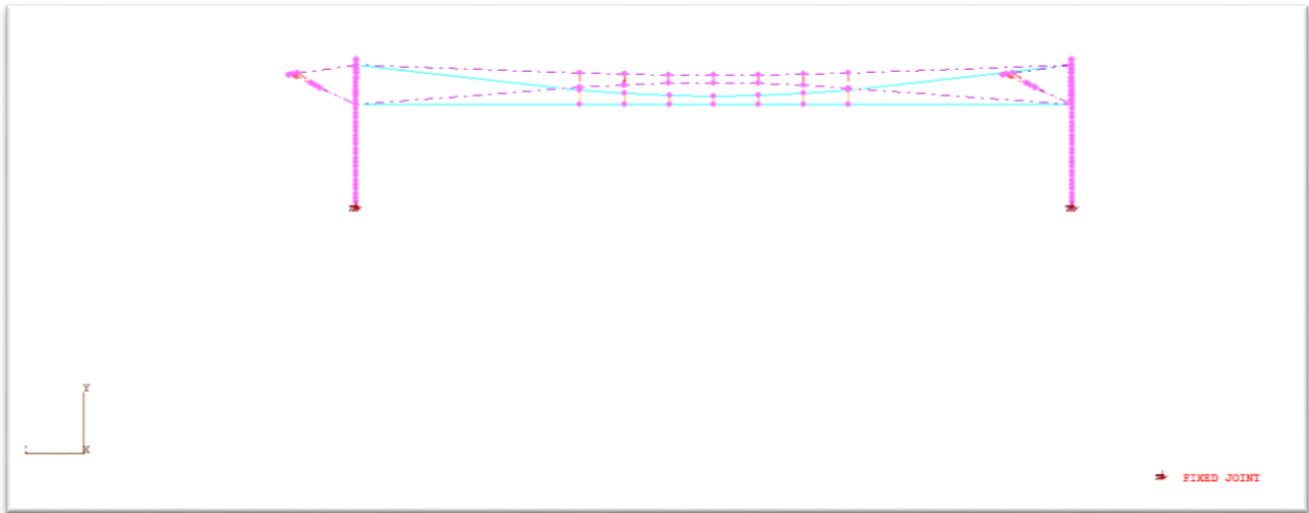

Figure 121 – Elevation View of Deflected Shape for Box Configuration Model, 45 Degree Wind Angle

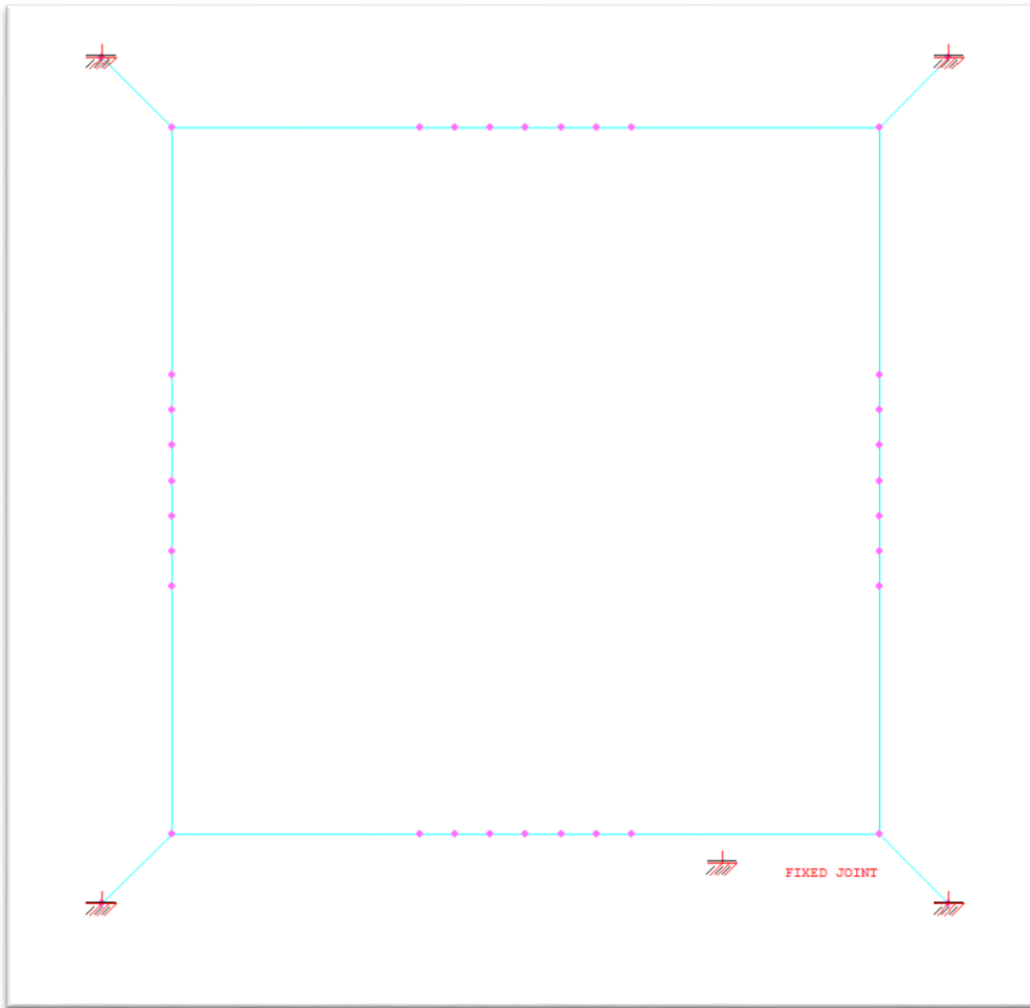

Figure 122 – Plan View of Typical Hanging Box Configuration Model

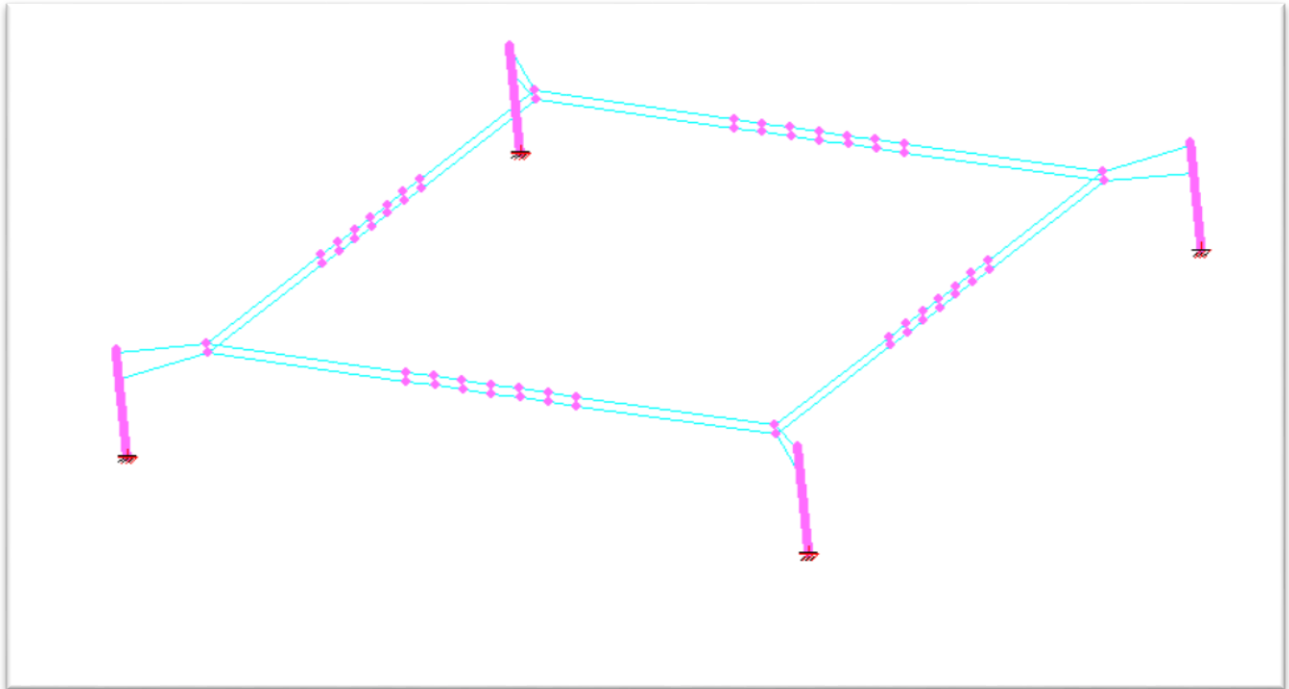

Figure 123 – Isometric View of Typical Hanging Box Configuration Model

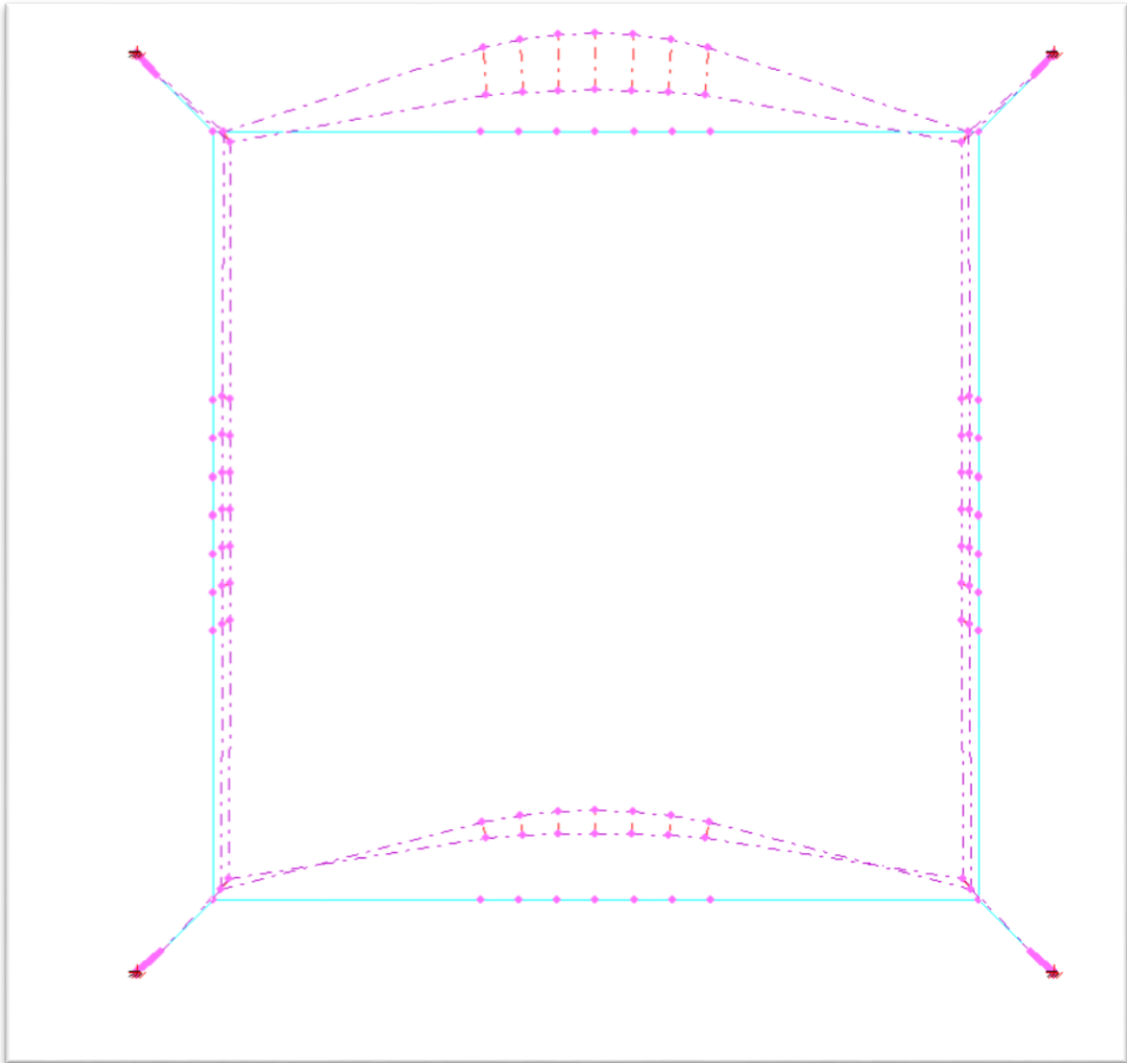

Figure 124 – Plan View of Deflected Shape for Hanging Box Configuration Model, 90 Degree Wind Angle

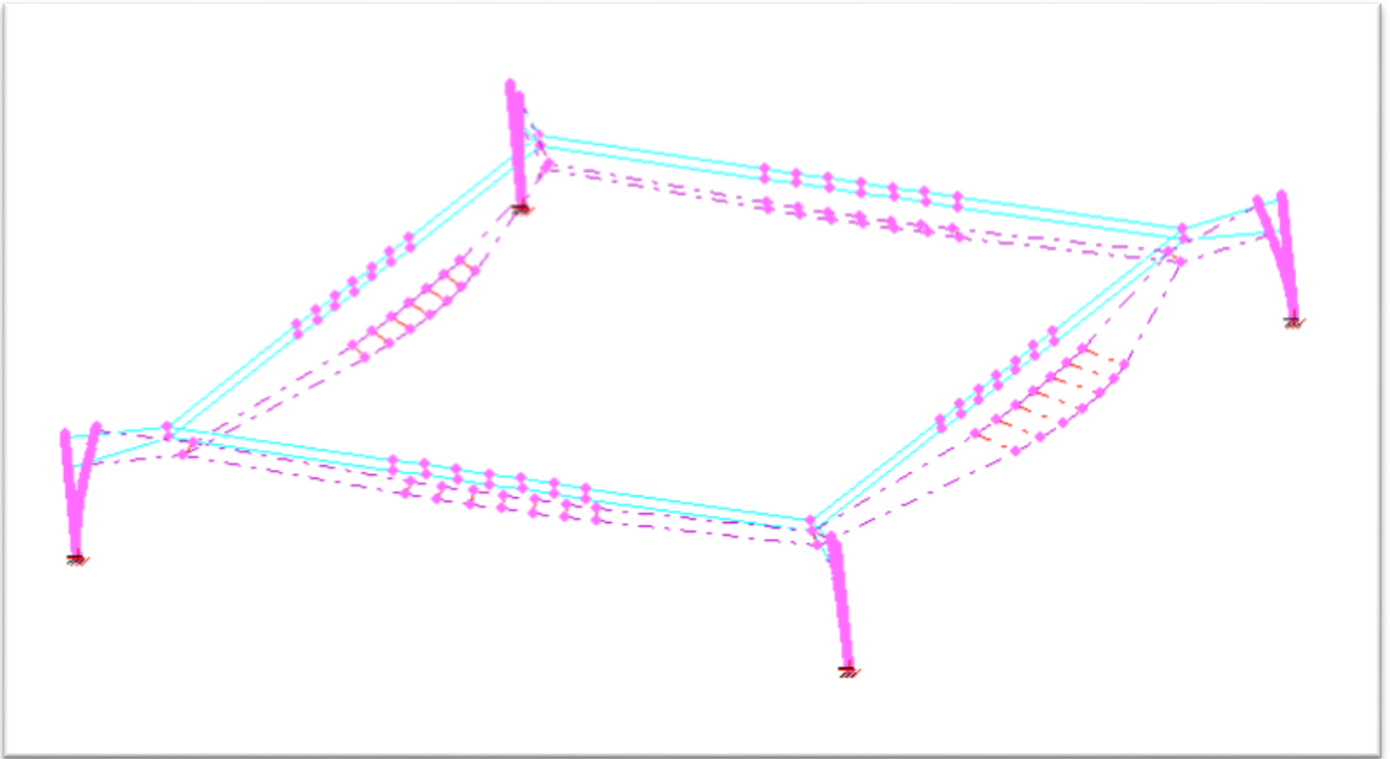

Figure 125 – Isometric View of Deflected Shape for Hanging Box Configuration Model, 90 Degree Wind Angle

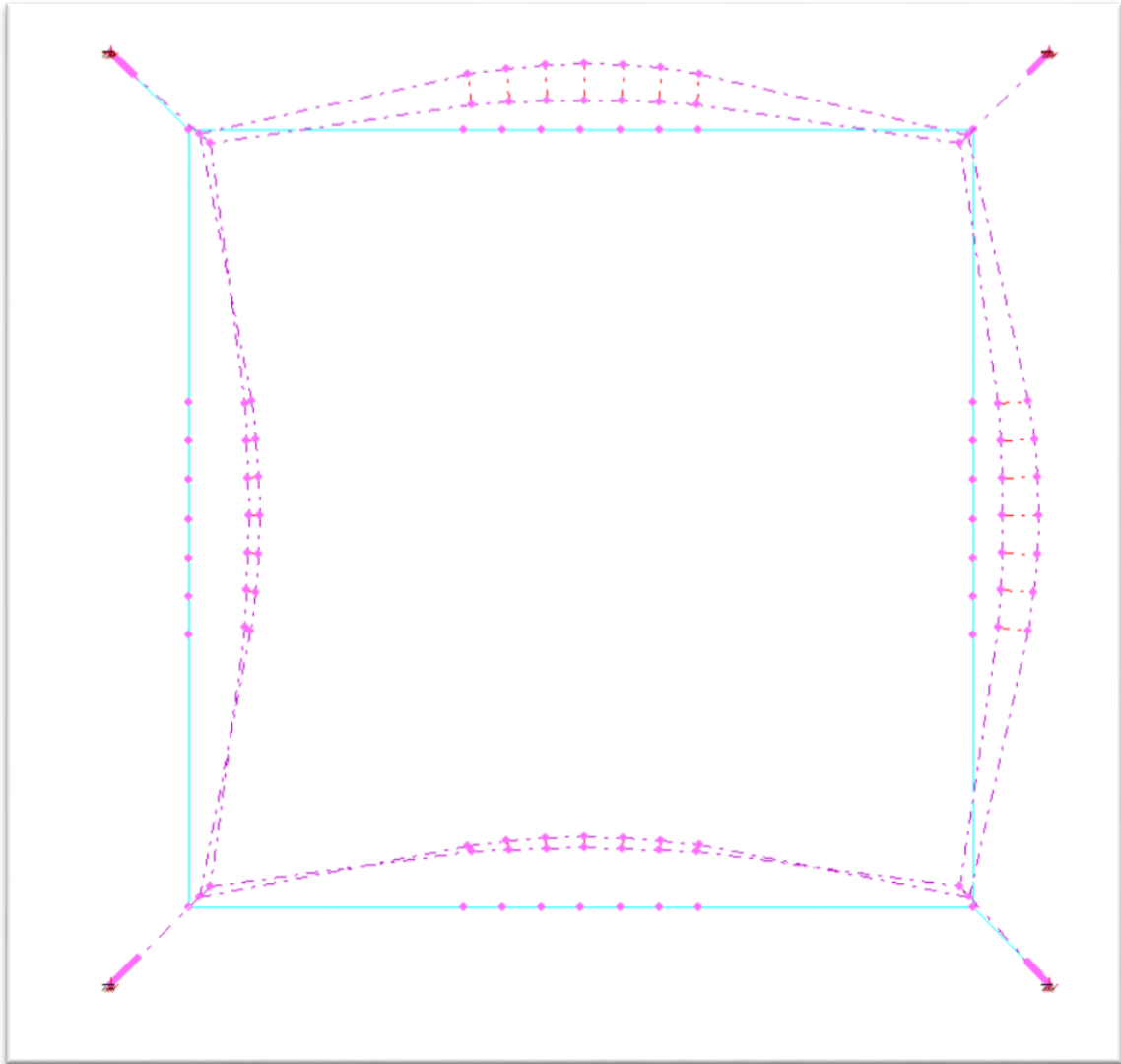

Figure 126 – Plan View of Deflected Shape for Hanging Box Configuration Model, 45 Degree Wind Angle

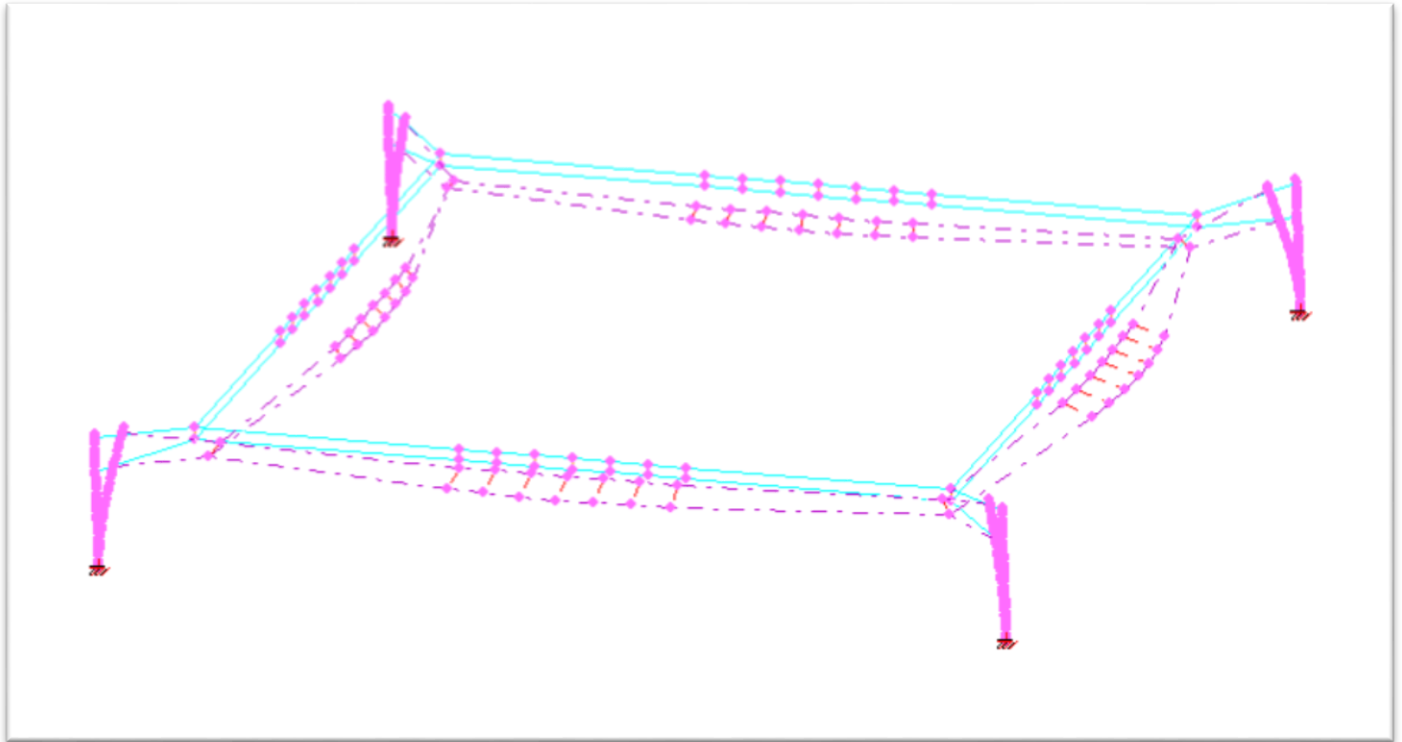

Figure 127 – Isometric View of Deflected Shape for Hanging Box Configuration Model, 45 Degree Wind Angle

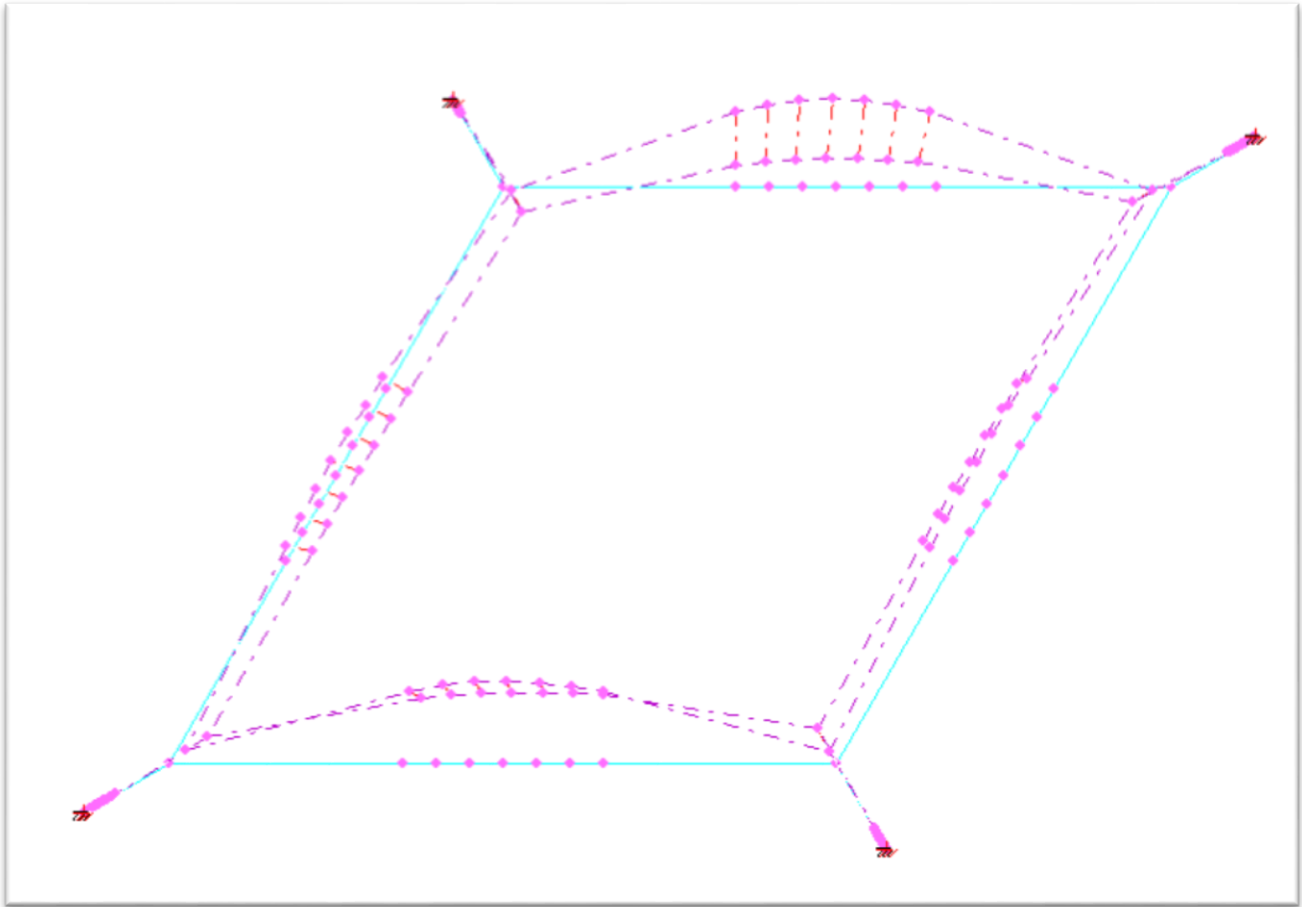

Figure 128 – Plan View of Deflected Shape for Hanging Box Configuration Model, 30 Degree Skew, 90 Degree Wind Angle

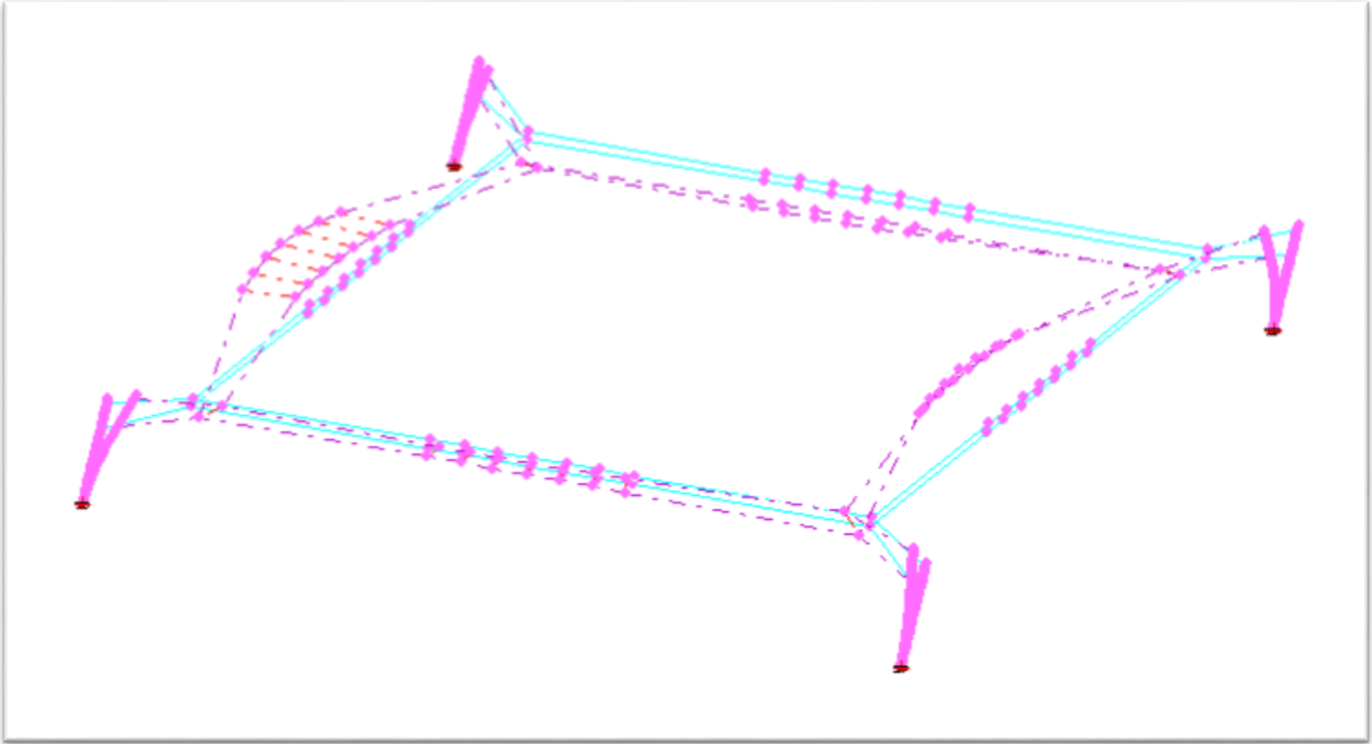

Figure 129 – Isometric View of Deflected Shape for Hanging Box Configuration Model, 30 Degree Skew, 90 Degree Wind Angle

Appendix G – Simplified Analysis Procedure

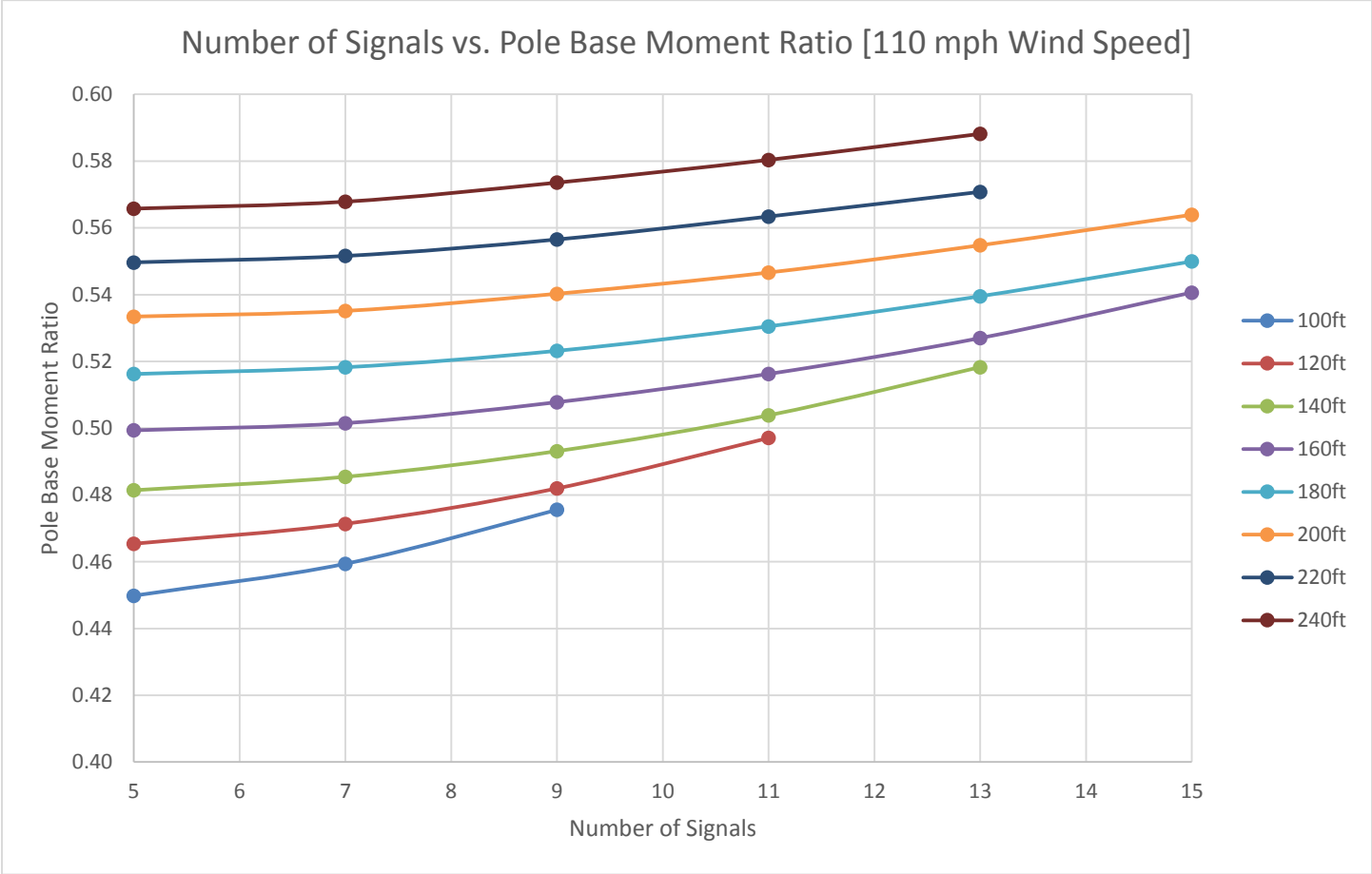

Figure 130 – GTS: Pole Base Moment Ratio (Minor Axis / Major Axis) Versus Number of Signals, Box Span, 3 Headed Aluminum Signals with Backplates, 110 mph Wind Speed

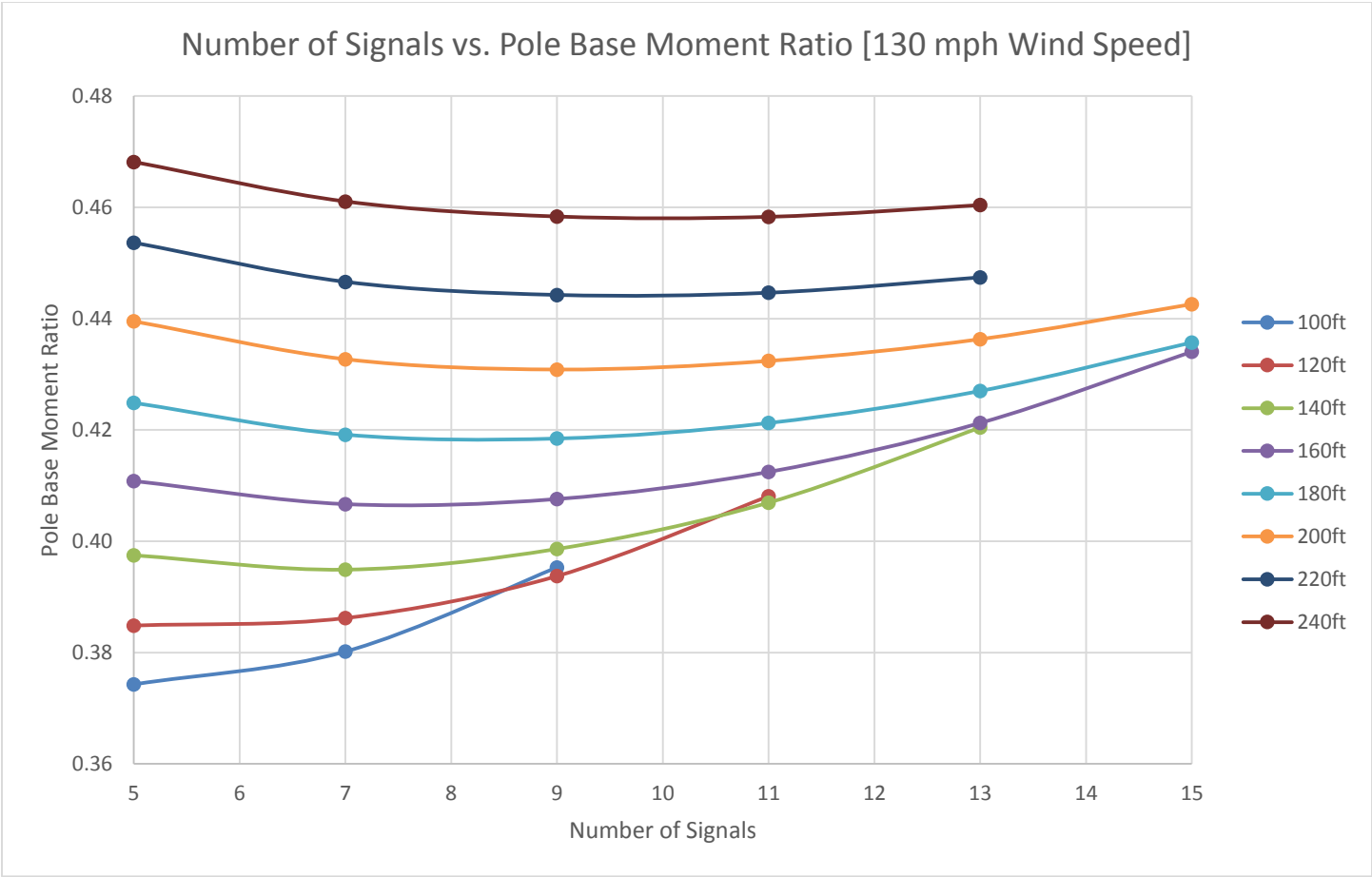

Figure 131 – GTS: Pole Base Moment Ratio (Minor Axis / Major Axis) Versus Number of Signals, Box Span, 3 Headed Aluminum Signals with Backplates, 130 mph Wind Speed

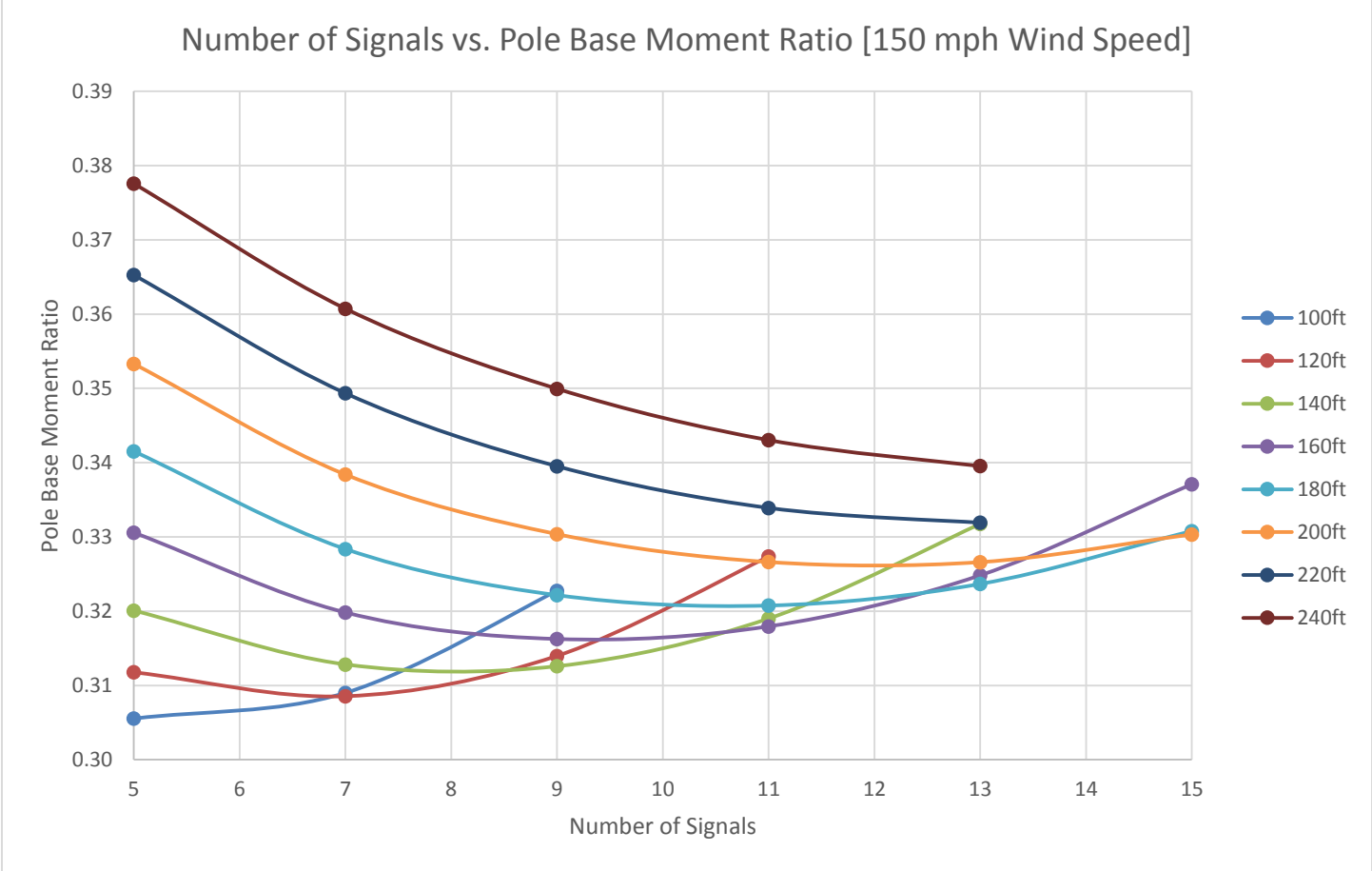

Figure 132 – GTS: Pole Base Moment Ratio (Minor Axis / Major Axis) Versus Number of Signals, Box Span, 3 Headed Aluminum Signals with Backplates, 150 mph Wind Speed

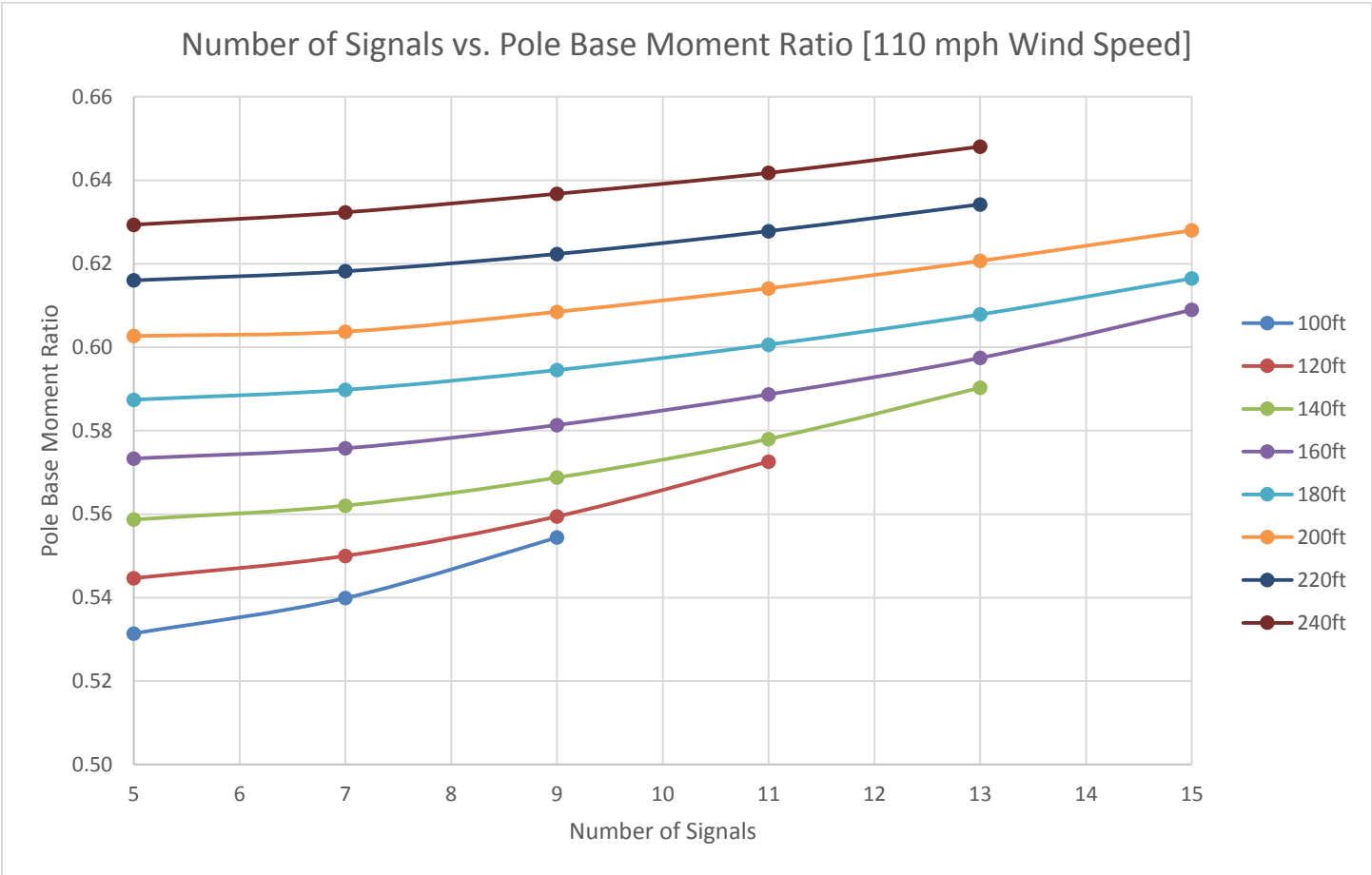

Figure 133 – GTS: Pole Base Moment Ratio (Minor Axis / Major Axis) Versus Number of Signals, Box Span, 3 Headed Aluminum Signals without Backplates, 110 mph Wind Speed

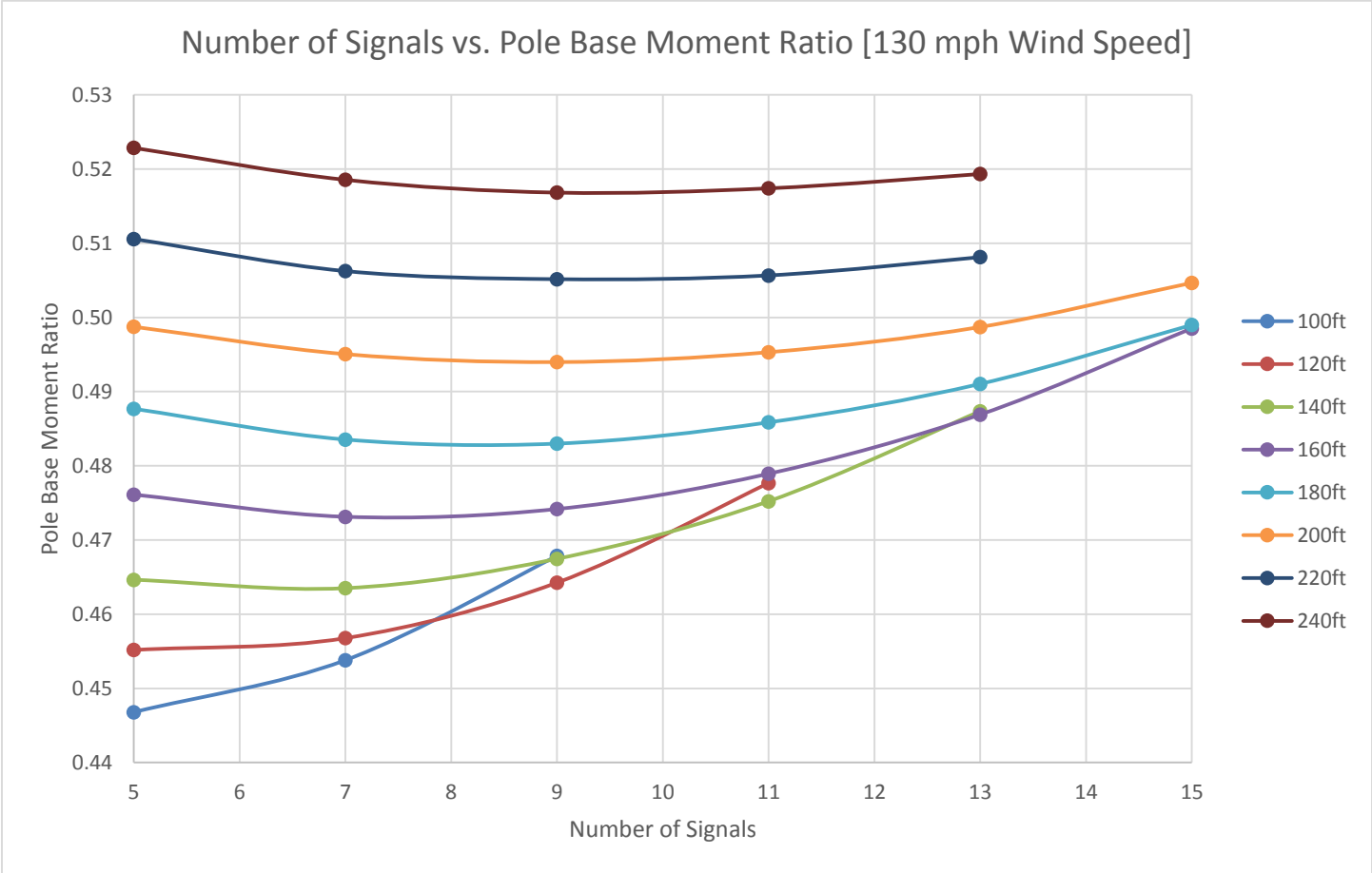

Figure 134 – GTS: Pole Base Moment Ratio (Minor Axis / Major Axis) Versus Number of Signals, Box Span, 3 Headed Aluminum Signals without Backplates, 130 mph Wind Speed

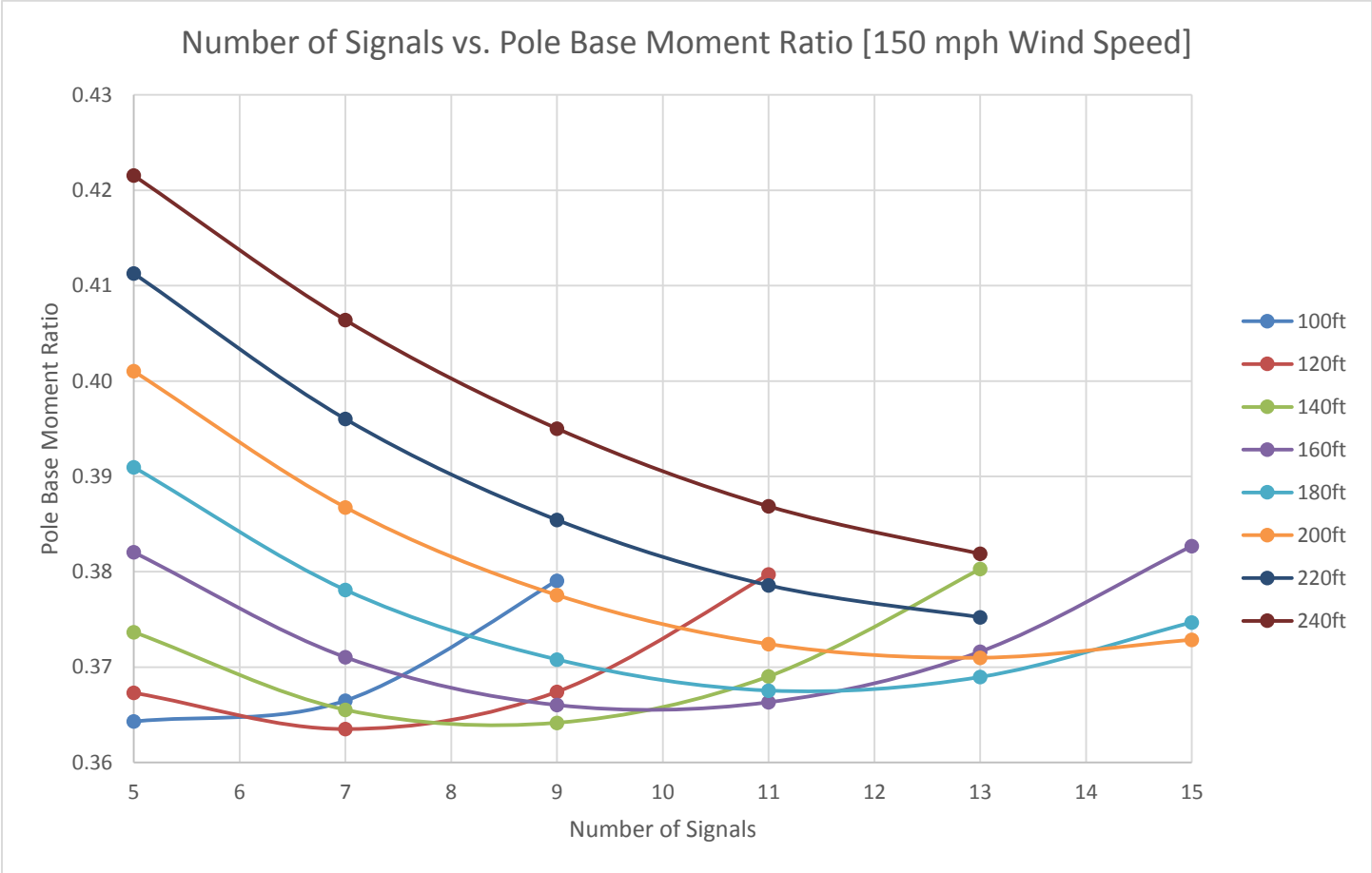

Figure 135 – GTS: Pole Base Moment Ratio (Minor Axis / Major Axis) Versus Number of Signals, Box Span, 3 Headed Aluminum Signals without Backplates, 150 mph Wind Speed

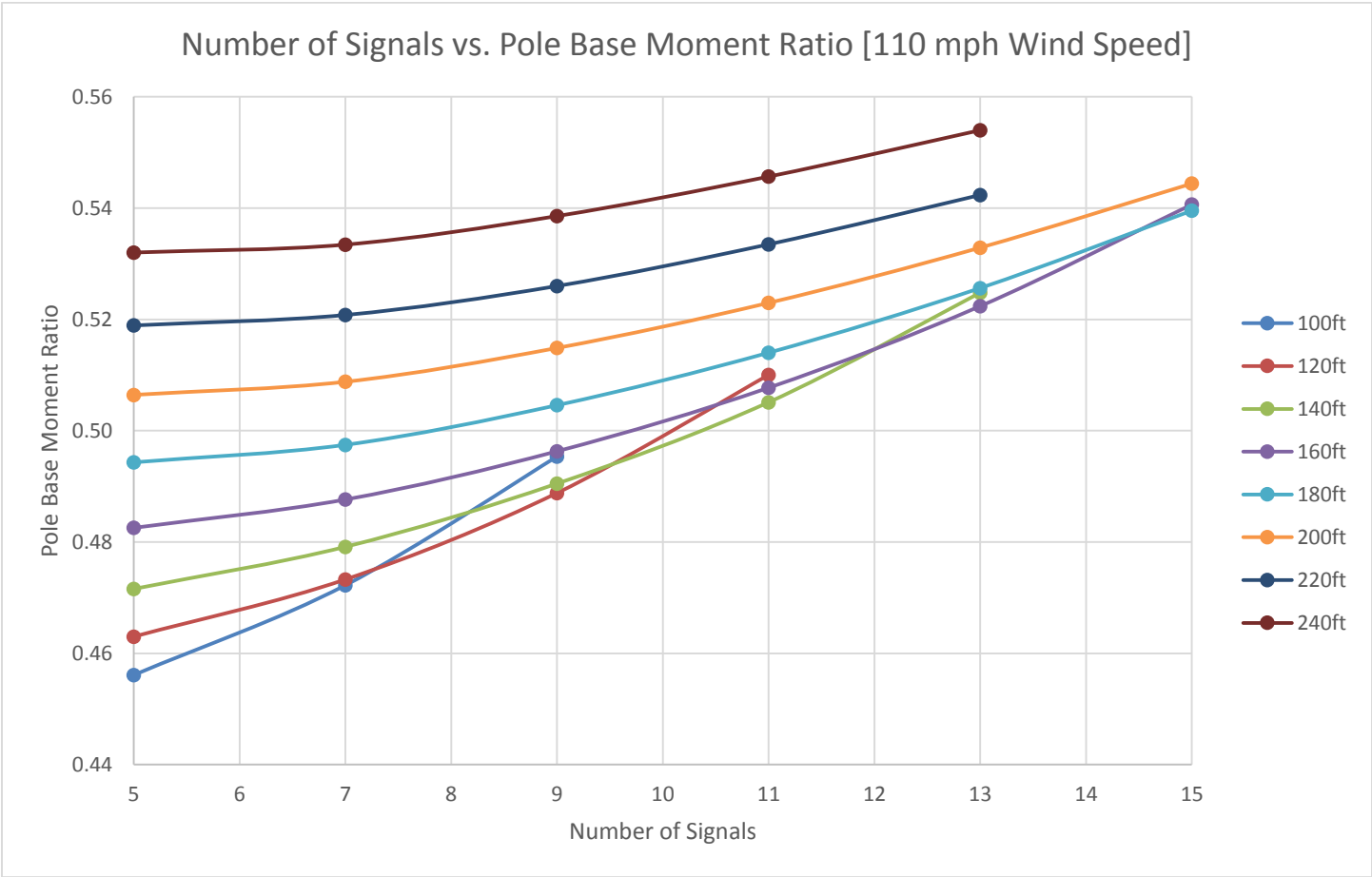

Figure 136 – GTS: Pole Base Moment Ratio (Minor Axis / Major Axis) Versus Number of Signals, Box Span, 5 Headed Aluminum Signals with Backplates, 110 mph Wind Speed

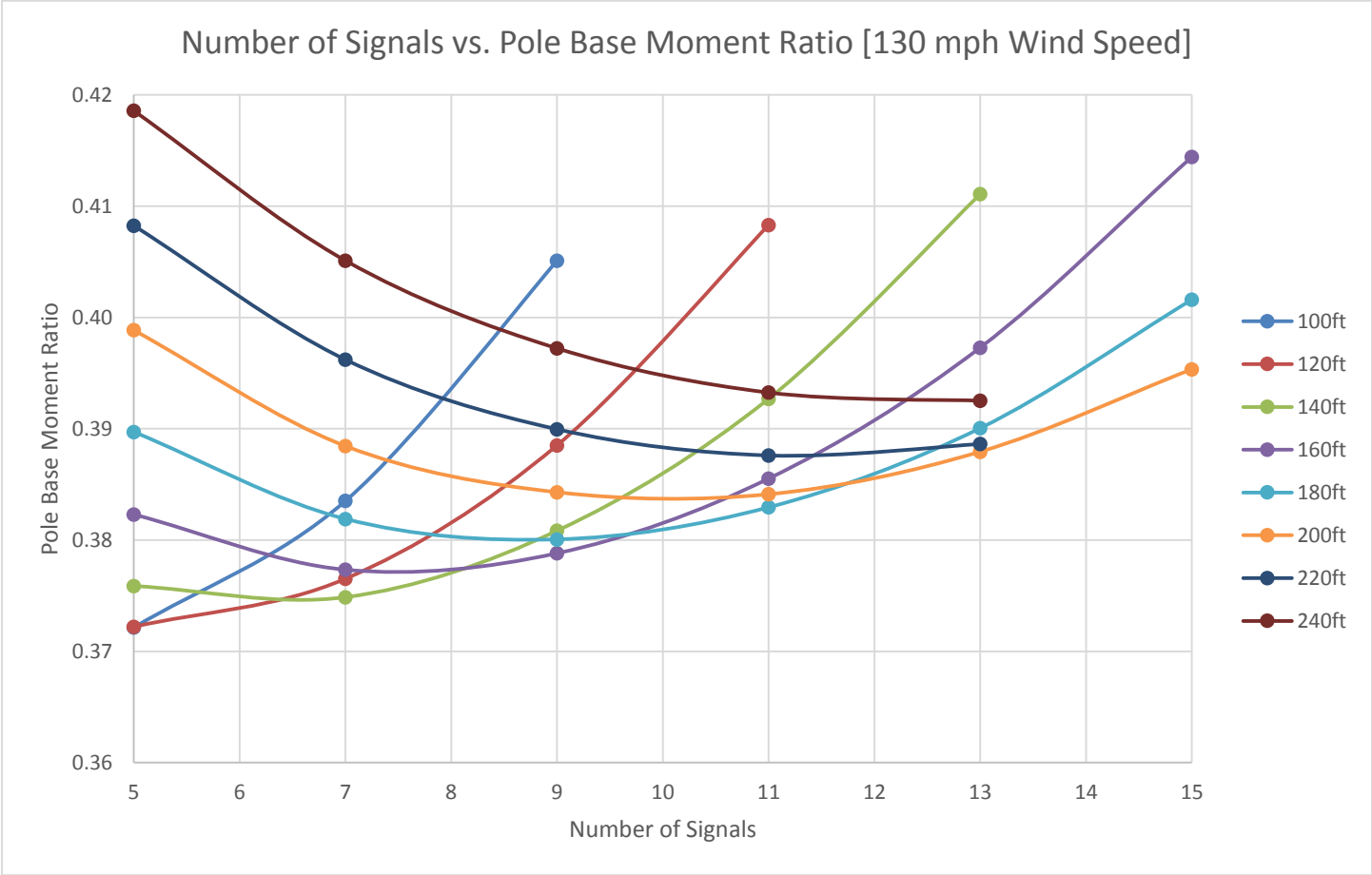

Figure 137 – GTS: Pole Base Moment Ratio (Minor Axis / Major Axis) Versus Number of Signals, Box Span, 5 Headed Aluminum Signals with Backplates, 130 mph Wind Speed

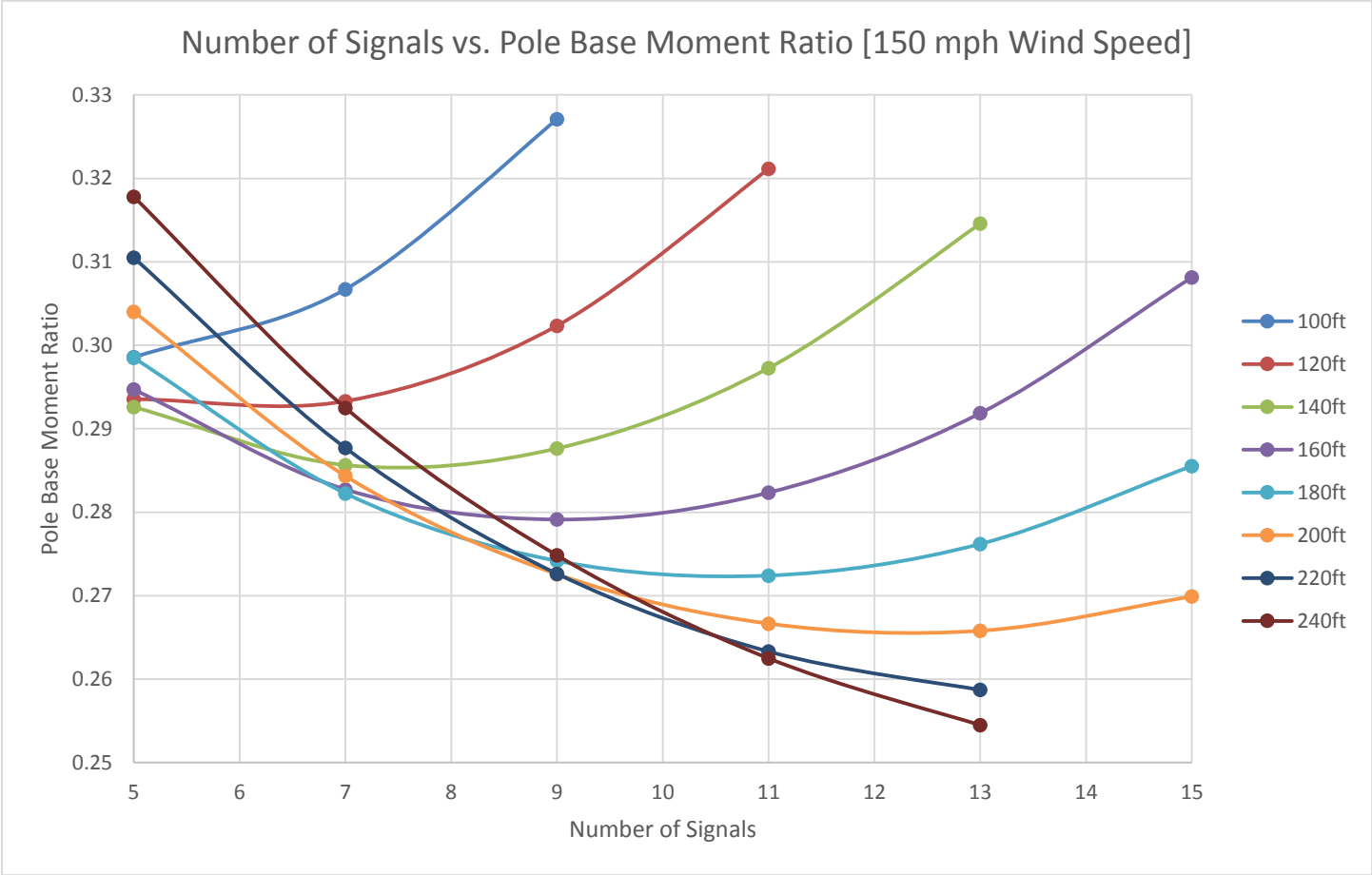

Figure 138 – GTS: Pole Base Moment Ratio (Minor Axis / Major Axis) Versus Number of Signals, Box Span, 5 Headed Aluminum Signals with Backplates, 150 mph Wind Speed

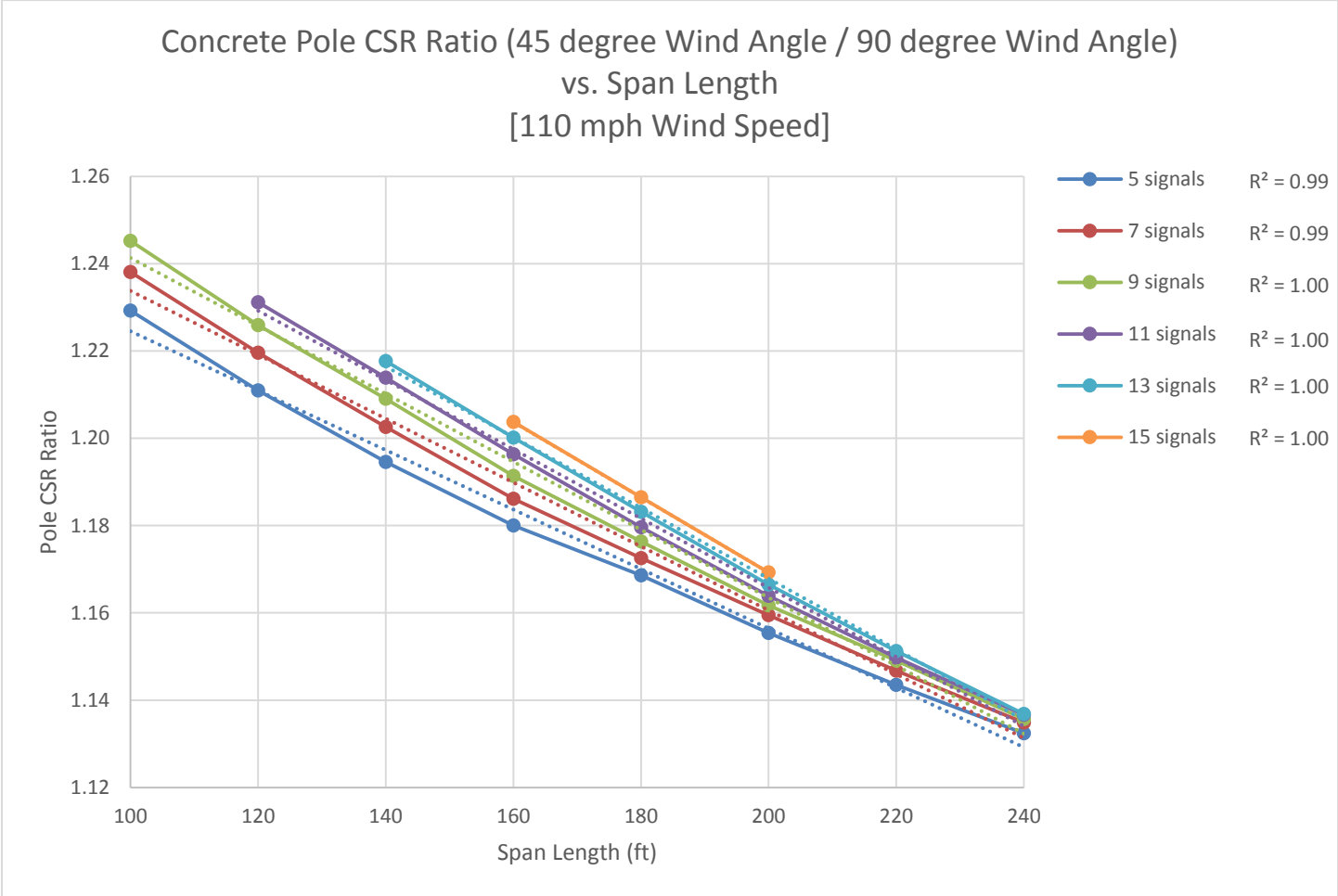

Figure 139 – GTStrudl Pole Base Moment CSR Ratio with 3 Headed, Aluminum Traffic Signals with Backplates, 110 mph Wind Speed, Box Span

Concrete Pole CSR Ratio (45 degree Wind Angle / 90 degree Wind Angle)
 vs. Span Length
 [130 mph Wind Speed]

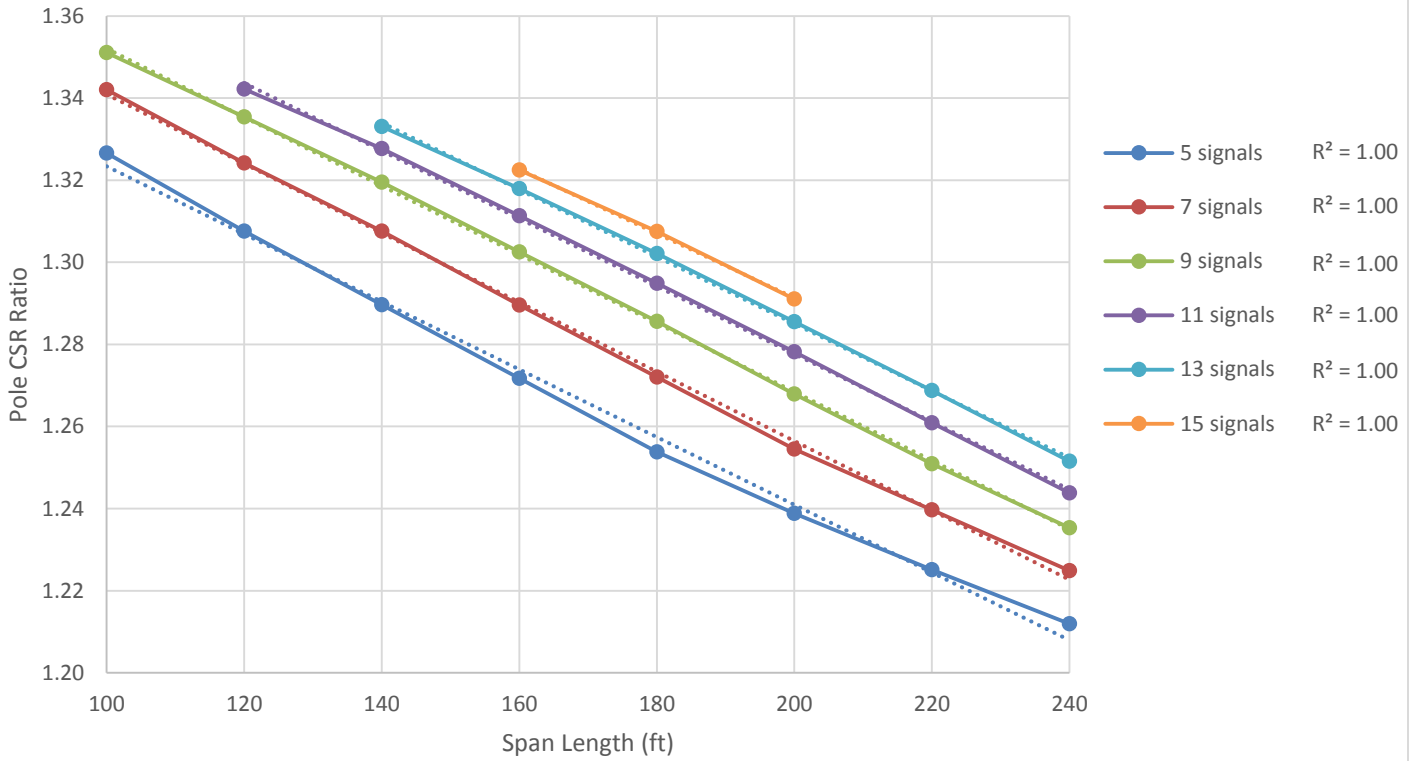

Figure 140 – GTStrudl Pole Base Moment CSR Ratio with 3 Headed, Aluminum Traffic Signals with Backplates, 130 mph Wind Speed, Box Span

Concrete Pole CSR Ratio (45 degree Wind Angle / 90 degree Wind Angle)
vs. Span Length
[150 mph Wind Speed]

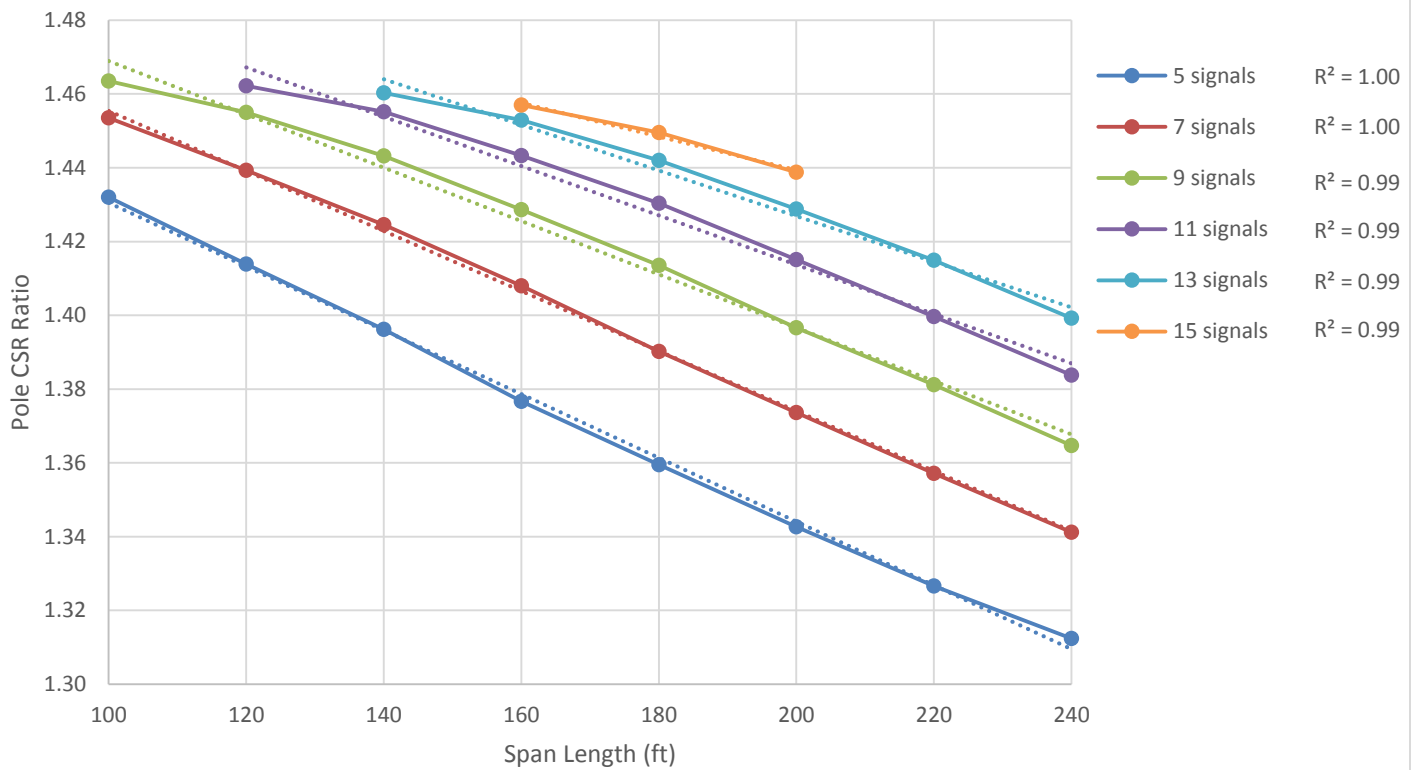

Figure 141 – GTStrudl Pole Base Moment CSR Ratio with 3 Headed, Aluminum Traffic Signals with Backplates, 150 mph Wind Speed, Box Span

Concrete Pole CSR Ratio (45 degree Wind Angle / 90 degree Wind Angle)
vs. Span Length
[110 mph Wind Speed]

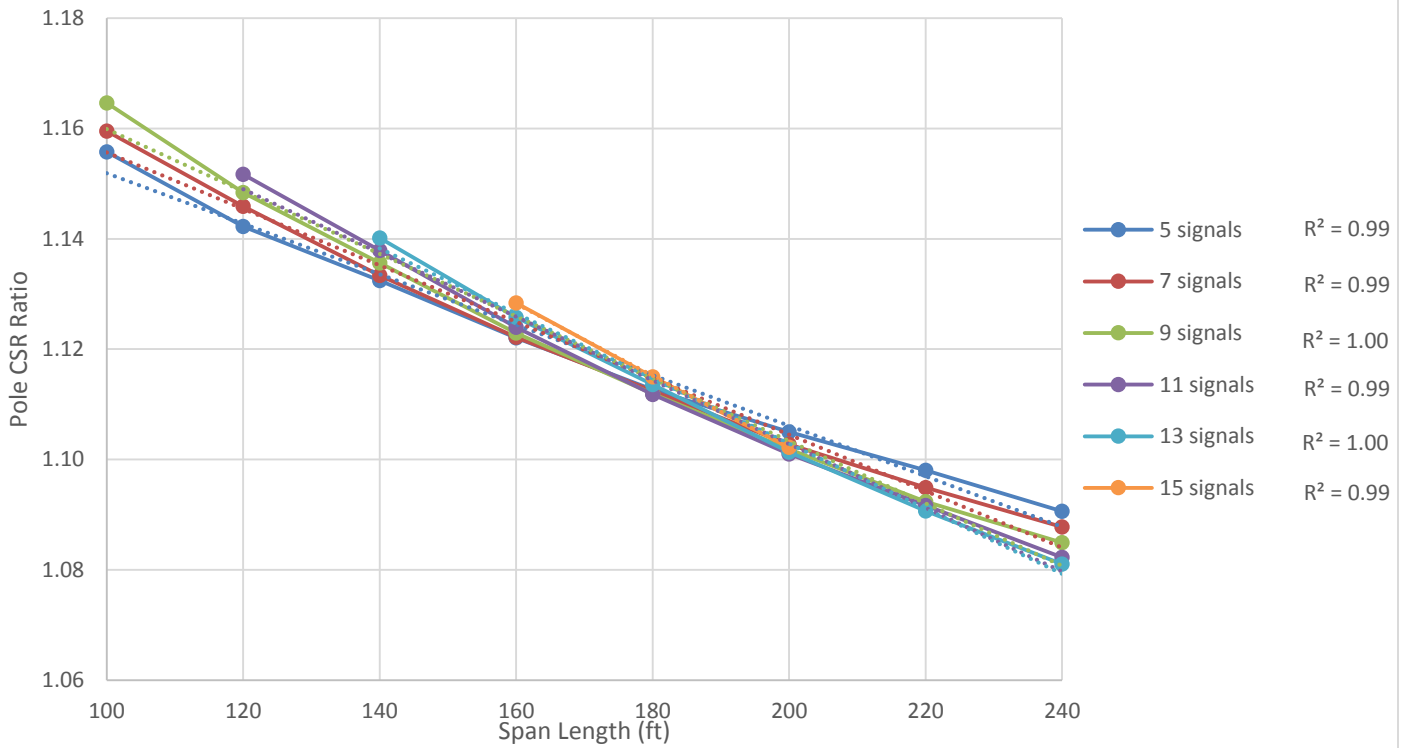

Figure 142 – GTStrudl Pole Base Moment CSR Ratio with 3 Headed, Aluminum Traffic Signals without Backplates, 110 mph Wind Speed, Box Span

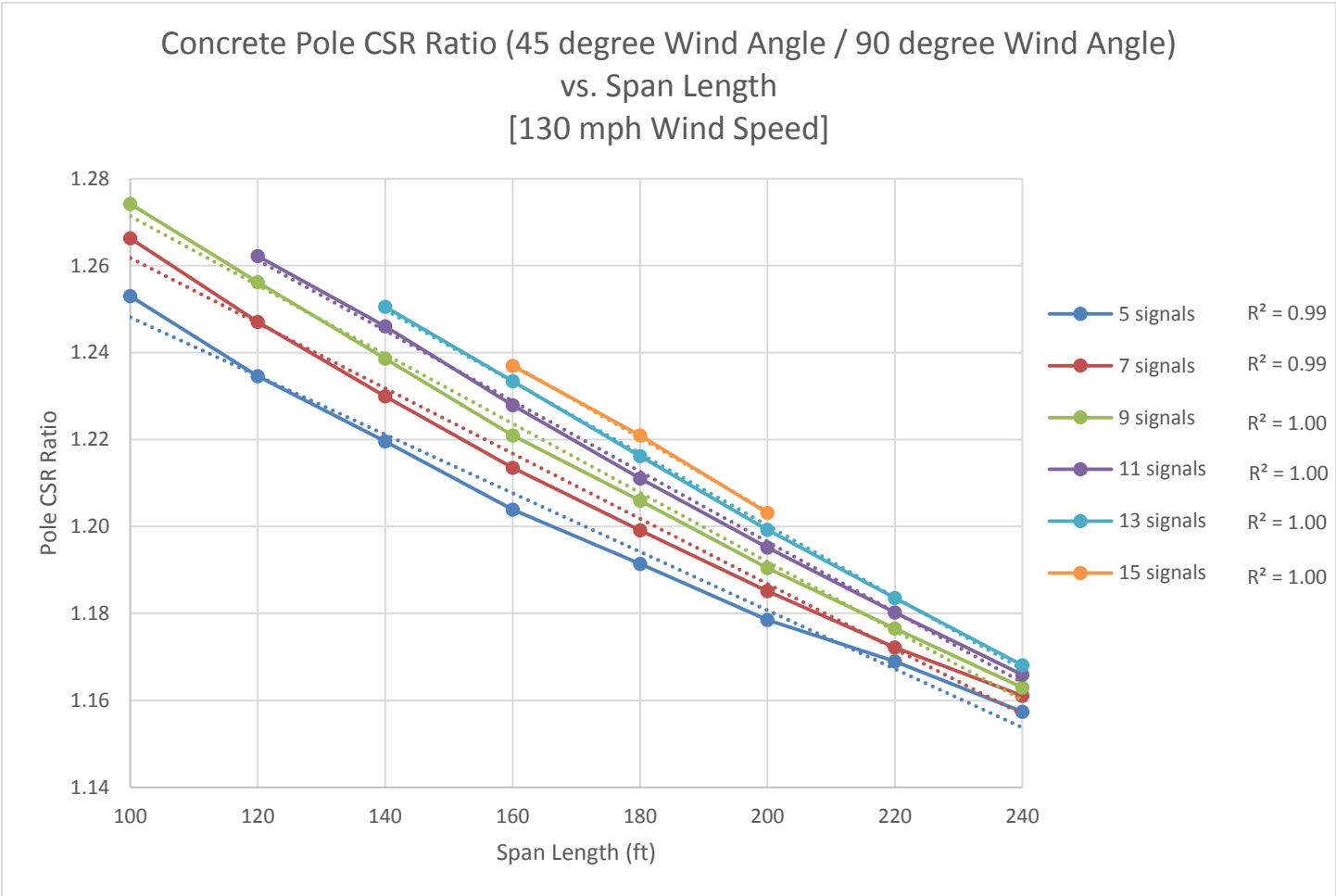

Figure 143 – GTStrudl Pole Base Moment CSR Ratio with 3 Headed, Aluminum Traffic Signals without Backplates, 130 mph Wind Speed, Box Span

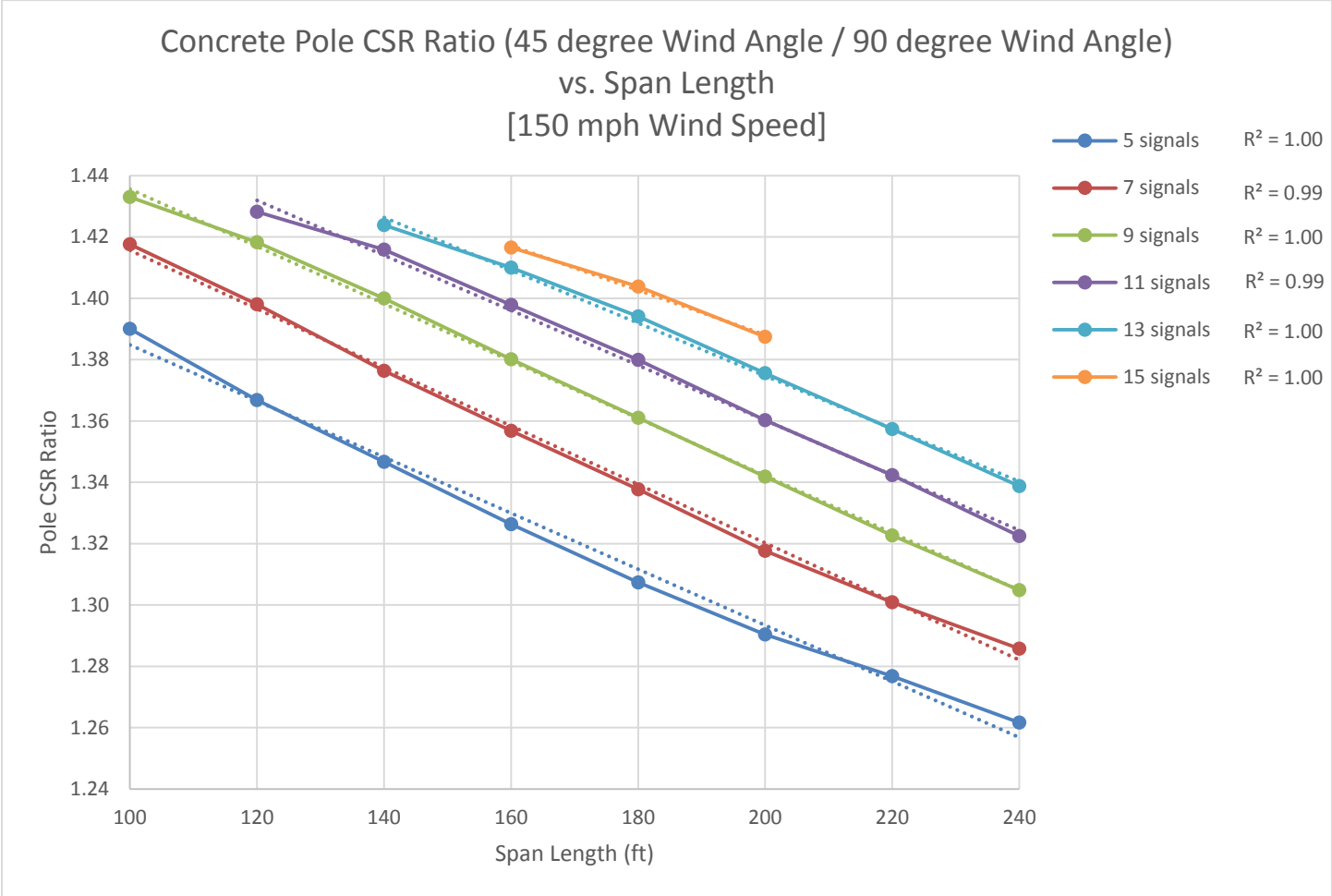

Figure 144 – GTStrudl Pole Base Moment CSR Ratio with 3 Headed, Aluminum Traffic Signals without Backplates, 150 mph Wind Speed, Box Span

Concrete Pole CSR Ratio (45 degree Wind Angle / 90 degree Wind Angle)
vs. Span Length
[110 mph Wind Speed]

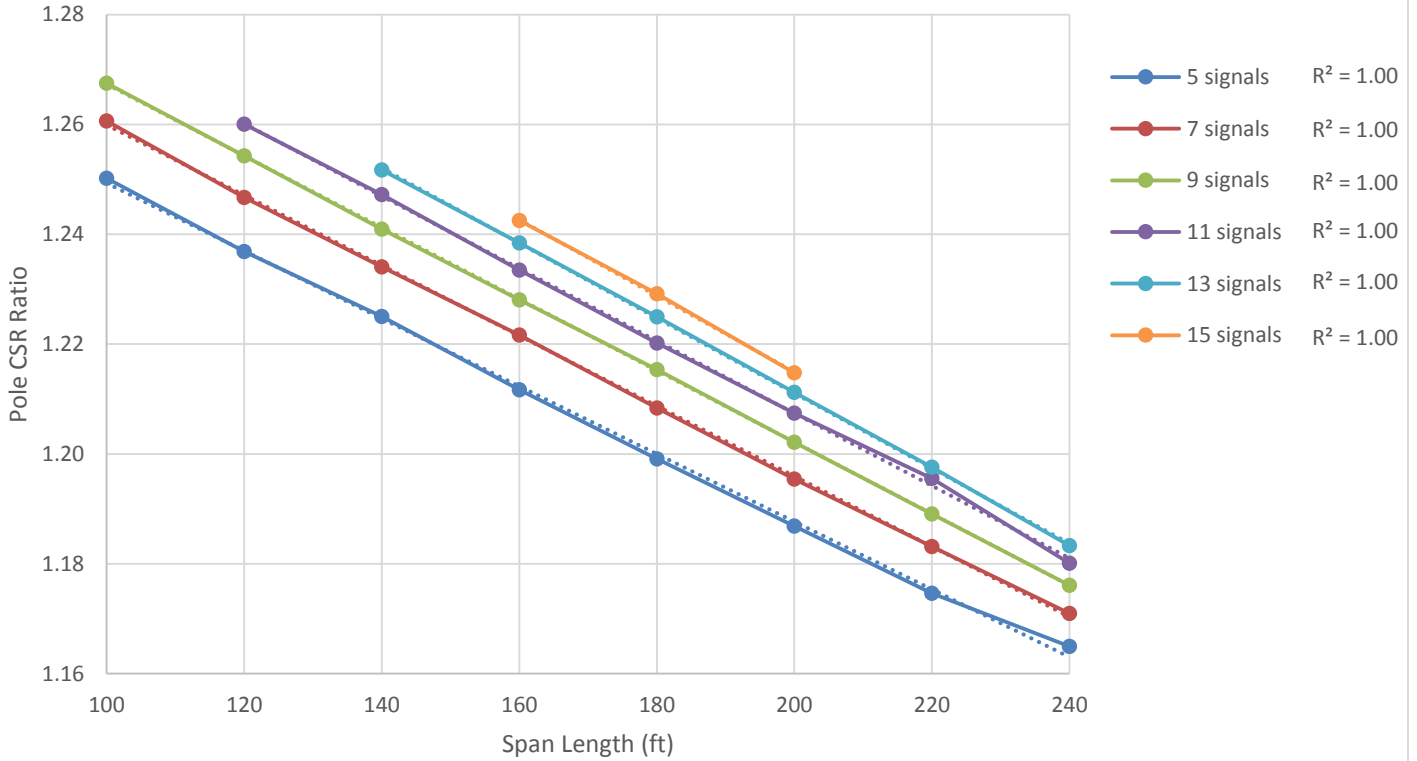

Figure 145 – GTStrudl Pole Base Moment CSR Ratio with 5 Headed, Aluminum Traffic Signals with Backplates, 110 mph Wind Speed, Box Span

Concrete Pole CSR Ratio (45 degree Wind Angle / 90 degree Wind Angle)
vs. Span Length
[130 mph Wind Speed]

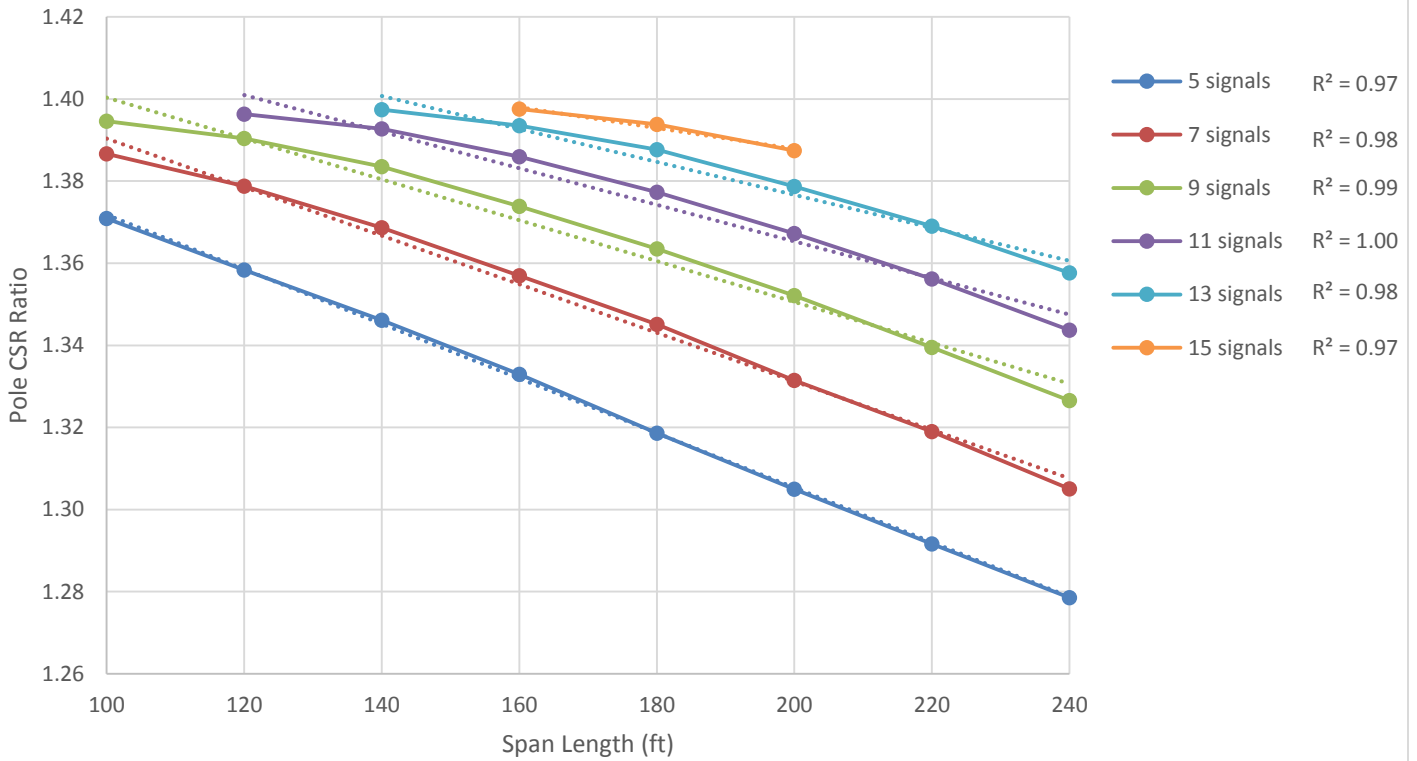

Figure 146 – GTStrudl Pole Base Moment CSR Ratio with 5 Headed, Aluminum Traffic Signals with Backplates, 130 mph Wind Speed, Box Span

Concrete Pole CSR Ratio (45 degree Wind Angle / 90 degree Wind Angle)
vs. Span Length
[150 mph Wind Speed]

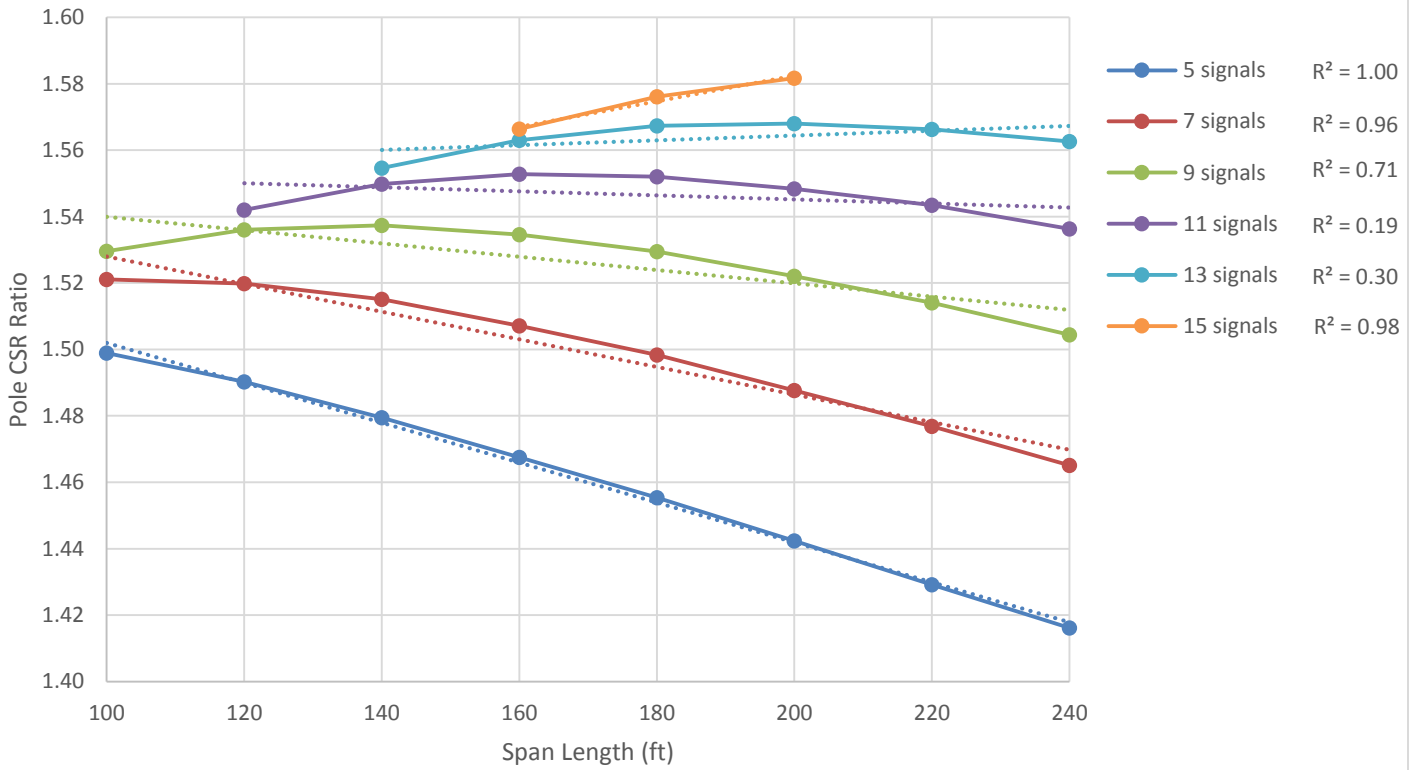

Figure 147 – GTStrudl Pole Base Moment CSR Ratio with 5 Headed, Aluminum Traffic Signals with Backplates, 150 mph Wind Speed, Box Span

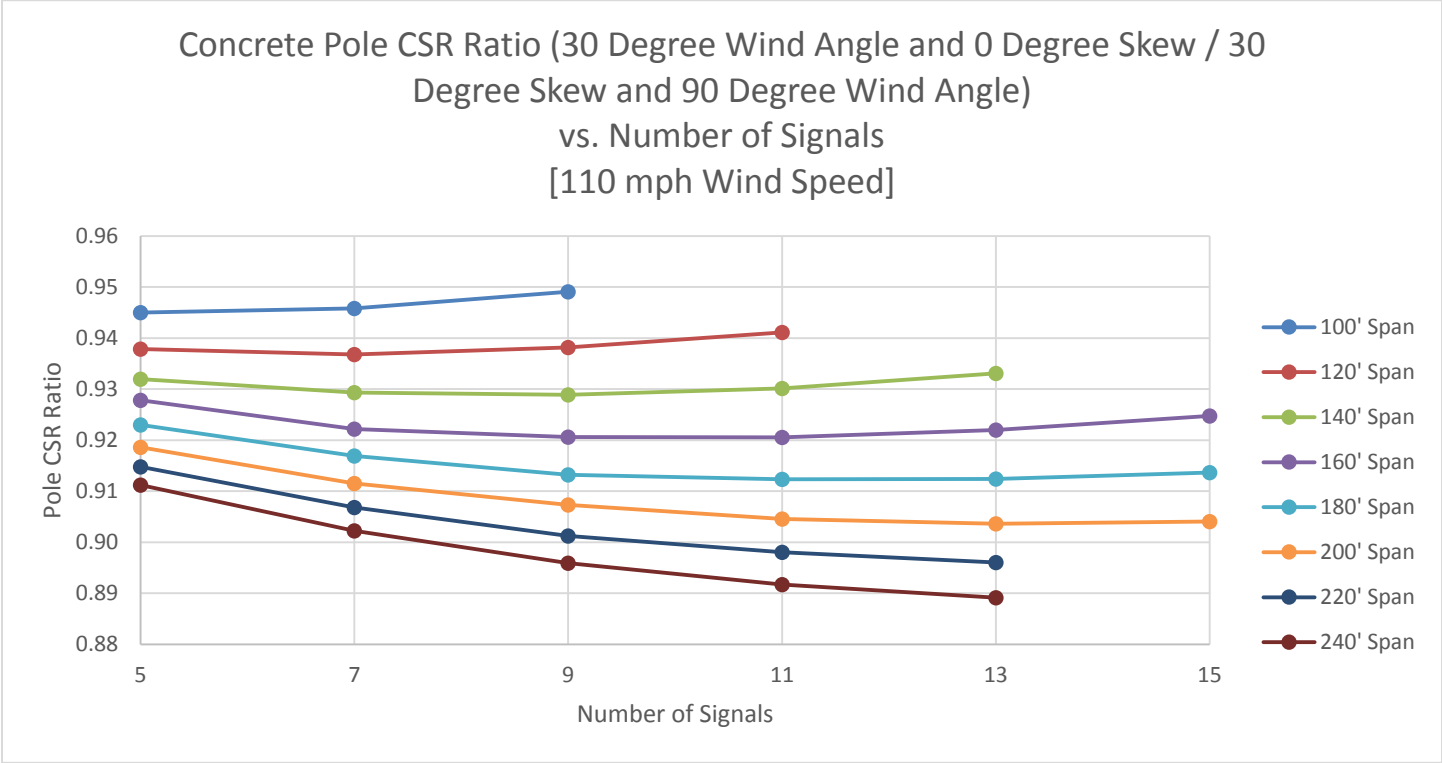

Figure 148 – GTStrudl Concrete Pole Base Moment CSR Ratio (30 Degree Wind Angle And 0 Degree Box Skew Relative to 30 Degree Box Skew and 90 Degree Wind Angle) with 3 Headed, Aluminum Traffic Signals With Backplates, 110 mph Wind Speed, Box Span

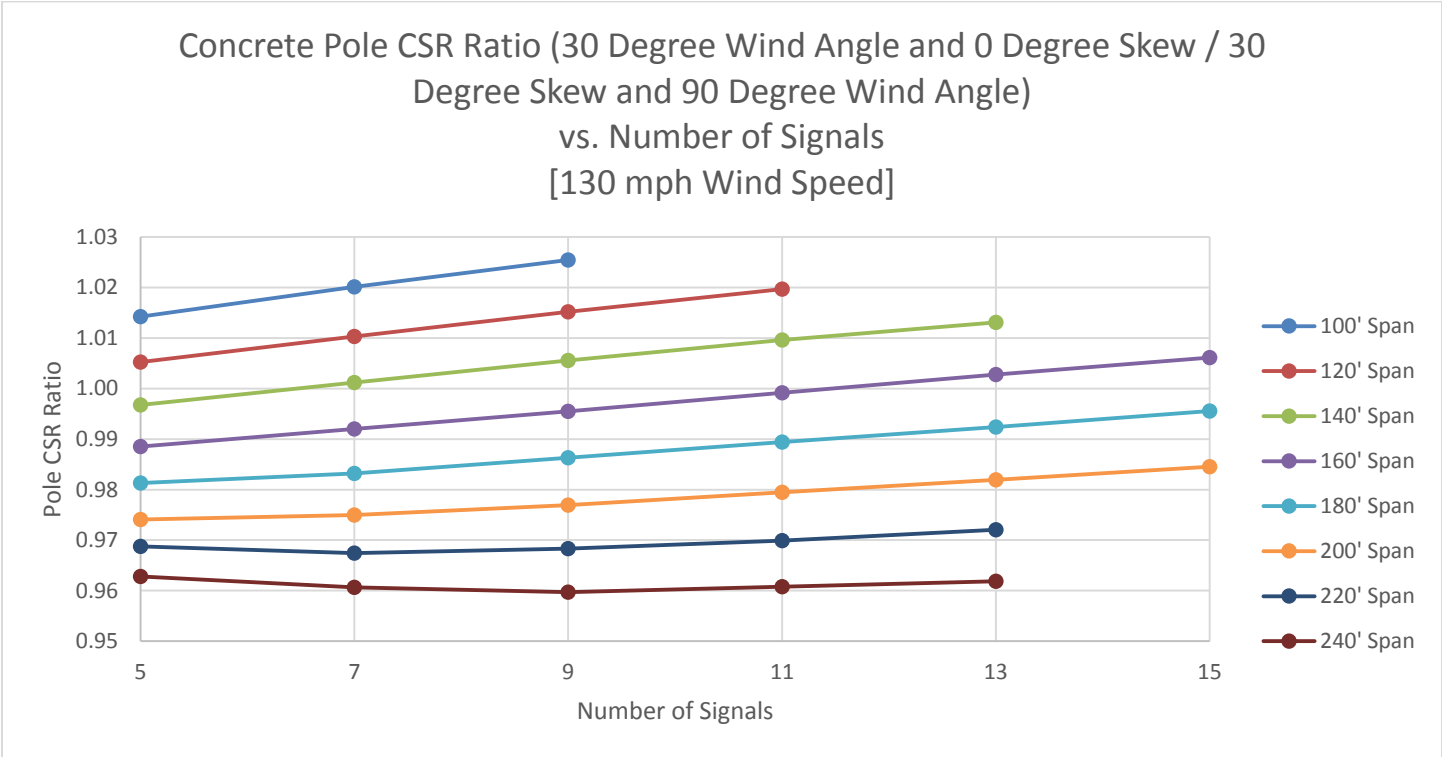

Figure 149 – GTStrudl Concrete Pole Base Moment CSR Ratio (30 Degree Wind Angle And 0 Degree Box Skew Relative to 30 Degree Box Skew and 90 Degree Wind Angle) with 3 Headed, Aluminum Traffic Signals With Backplates, 130 mph Wind Speed, Box Span

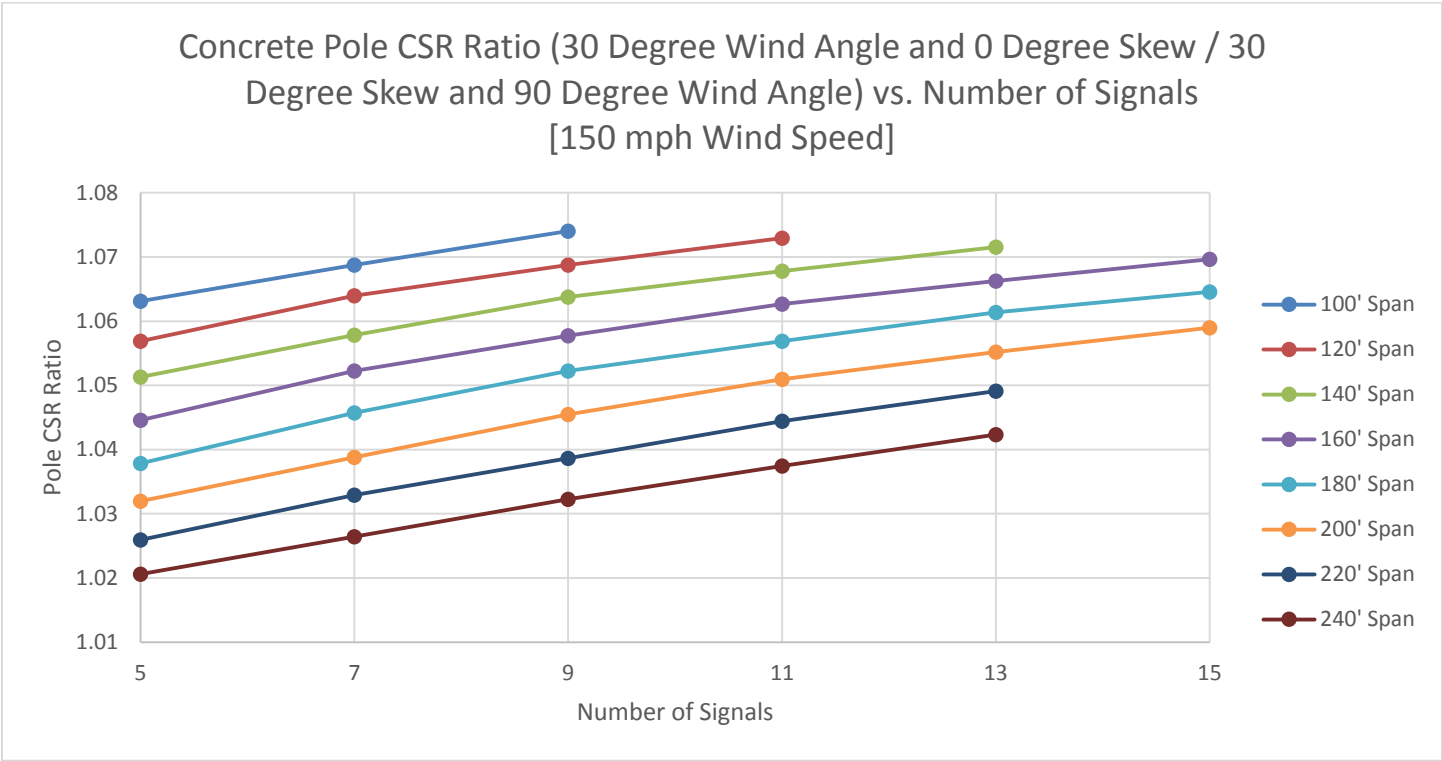

Figure 150 – GTStrudl Concrete Pole Base Moment CSR Ratio (30 Degree Wind Angle And 0 Degree Skew Relative to 30 Degree Box Skew and 90 Degree Wind Angle) with 3 Headed, Aluminum Traffic Signals With Backplates, 150 mph Wind Speed, Box Span

$$MF = 1.14 + 0.02 * N$$

where N = Number of Signals

Equation 1 – Magnification Factor for Number of Signals, Hanging Box

$$SF = 0.0003 * D^2 + 0.0017 * D + 1$$

Where D = Skew Angle in Degrees

Equation 2 – Skew Factor, Hanging Box

Appendix H – References

1. "Analysis of Light Poles And Signals ATLAS V6 User's Manual, " Bridge Software Institute, Gainesville, Florida 2014.
2. Cook, R.A., and Johnson, E. "Development of Hurricane Resistant Cables Supported Traffic Signals" University of Florida, Report No. BD545RPWO #57, July 2007.
3. AASHTO 2015 Interim Revisions to Standard Specifications for Structural Supports for Highway Signs, Luminaires, and Traffic Signals (LTS-6), Sixth Edition.
4. Structures Design Guidelines, 2015 FDOT Structures Manual, Volume 1.
5. Modifications to LTS-6, 2015 FDOT Structures Manual, Volume 3.