

Soils and Foundations Handbook 2022



State Materials Office
Gainesville, Florida

This page is intentionally blank.

Table of Contents

Table of Contents	ii
List of Tables.....	xii
Chapter 1	1
1 Introduction	1
1.1 Geotechnical Tasks in Typical Highway Projects.....	2
1.1.1 Planning, Development, and Engineering Phase	2
1.1.2 Project Design Phase.....	2
1.1.3 Construction Phase.....	2
1.1.4 Post-Construction Phase.....	3
Chapter 2	4
2 Subsurface Investigation Procedures	4
2.1 Review of Project Requirements	4
2.2 Review of Available Data.....	4
2.2.1 Topographic Maps.....	4
2.2.2 Aerial Photographs	5
2.2.3 Geological Maps and Reports	5
2.2.4 Natural Resources Conservation Service Surveys	5
2.2.5 Potentiometric Surface Map.....	5
2.2.6 Adjacent Projects.....	5
2.3 Field Reconnaissance	5
2.4 Field Exploration Methods	6
2.4.1 Test Pits and Trenches.....	6
2.4.2 Boreholes.....	6
2.4.2.1 Auger Borings.....	7
2.4.2.2 Hollow-Stem Auger Borings	7
2.4.2.3 Wash Borings.....	7
2.4.2.4 Coring	7
2.4.3 Soundings.....	7
2.4.4 Geophysical Methods.....	7
2.4.4.1 Seismic Refraction and Reflection.....	8
2.4.4.2 Resistivity	8
2.4.4.3 Ground Penetrating Radar (GPR)	8
2.4.5 Soil Sampling	8
2.4.5.1 Bag Bulk Samples.....	9
2.4.5.2 Split-Barrel.....	9
2.4.5.3 Shelby Tube	9
2.4.5.4 Piston Samplers.....	9
2.4.5.4.1 Stationary.....	9
2.4.5.4.2 Floating.....	10
2.4.5.4.3 Retractable	10
2.4.5.5 Rock Core Sampling.....	10
2.4.5.5.1 Double Tube Core Barrel	10

2.4.5.5.2 Triple Tube Core Barrel	11
2.5 References	14
2.6 Specifications and Standards	14
Chapter 3	16
3 Subsurface Investigation Guidelines for Highways and Related Structures.....	16
3.1 General Requirements	16
3.2 Guidelines for Minimum Explorations.....	17
3.2.1 Roadway Soil Surveys and Rails to Trails/Multi-use Trail Projects.....	18
3.2.2 Structures.....	20
3.2.2.1 Bridges	20
3.2.2.2 Approach Embankments	24
3.2.2.3 Retaining Walls.....	25
3.2.2.4 Noise Walls	25
3.2.2.5 Buildings.....	25
3.2.2.6 Drainage Structures.....	25
3.2.2.7 High Mast Lighting, and Overhead Sign Structures	26
3.2.2.8 Mast Arms Assemblies, Microwave Vehicle Detection Systems (MVDS) Poles and Strain Poles.....	26
3.2.2.9 CCTV Poles	27
3.2.2.10 Cable Barriers	27
3.2.2.11 Tunnels.....	28
3.2.2.12 Other Structures	28
3.2.3 Borrow Areas	28
3.2.4 Open Retention Ponds.....	28
3.2.5 Closed Retention Ponds	29
3.2.6 Exfiltration Trenches/French Drains	29
3.3 References	32
3.4 Specifications and Standards	32
Chapter 4	33
4 In-situ Testing	33
4.1 Standard Penetration Test (SPT)	33
4.2 Cone Penetrometer Test (CPT).....	34
4.3 Dynamic Cone Penetrometer Test.....	35
4.4 Dilatometer Test (DMT).....	36
4.5 Pressuremeter Test (PMT).....	36
4.6 Field Vane Test.....	37
4.7 Percolation Test	37
4.8 Infiltration Test	37
4.9 Permeability Test.....	38
4.9.1 Constant Head Test	39
4.9.2 Rising Head Test	39
4.9.3 Falling Head Test	39
4.9.4 Pumping Test.....	39
4.9.5 Vertical Insitu Permeameter (VIP) Test.....	39

4.10 Environmental Corrosion Tests	39
4.10.1 pH of Soils.....	40
4.10.2 pH of Water.....	40
4.10.3 Chloride Ion in Water.....	40
4.10.4 Chloride Ion in Soil.....	40
4.10.5 Sulfate Ion in Brackish Water	40
4.10.6 Sulfates in Soil	40
4.10.7 Electrical Resistance of Water	40
4.10.8 Electrical Resistance of Soil.....	40
4.11 Grout Plug Pull-out Test.....	40
4.12 References	51
Chapter 5	54
5 Laboratory Tests.....	54
5.1 Soils	54
5.1.1 Grain-Size Analysis.....	54
5.1.1.1 Sieve Analysis.....	54
5.1.1.2 Hydrometer	54
5.1.2 Moisture Content.....	55
5.1.3 Atterberg Limits	55
5.1.3.1 Liquid Limit.....	55
5.1.3.2 Plastic Limit.....	55
5.1.4 Specific Gravity of Soils	55
5.1.5 Strength Tests.....	56
5.1.5.1 Unconfined Compression Tests	56
5.1.5.2 Triaxial Compression Tests	56
5.1.5.2.1 Unconsolidated-Undrained (UU), or Q Test	56
5.1.5.2.2 Consolidated-Undrained (CU), or R Test.....	57
5.1.5.2.3 Consolidated-Drained (CD), or S Test	57
5.1.5.3 Direct Shear	57
5.1.5.4 Miniature Vane Shear (Torvane) and Pocket Penetrometer	57
5.1.6 Consolidation Test.....	57
5.1.6.1 One-Dimensional Test	58
5.1.6.2 Constant Rate of Strain Test	58
5.1.7 Organic Content	59
5.1.8 Shrinkage and Swell.....	59
5.1.8.1 Shrinkage	59
5.1.8.2 Swell	59
5.1.9 Permeability	59
5.1.9.1 Constant-Head Test.....	59
5.1.9.2 Falling-Head Test.....	60
5.1.9.3 Flexible Wall Permeability	60
5.1.10 Environmental Corrosion Tests.....	60
5.1.11 Compaction Tests.....	60
5.1.11.1 Standard Proctor.....	60
5.1.11.2 Modified Proctor.....	61

5.1.12 Relative Density Tests.....	61
5.1.12.1 Maximum Index Density	61
5.1.12.2 Minimum Index Density	61
5.1.13 Limerock Bearing Ratio (LBR).....	61
5.1.14 Resilient Modulus Test (Dynamic)	62
5.2 Rock Cores	62
5.2.1 Unconfined Compression Test.....	62
5.2.2 Absorption and Bulk Specific Gravity	62
5.2.3 Splitting Tensile Strength.....	62
5.2.4 Triaxial Compression Strength.....	62
5.2.5 Unit Weight of Sample.....	63
5.2.6 Rock Scour Rate Determination.....	63
5.3 References	63
5.4 Specifications and Standards	64
Chapter 6	66
6 Materials Description, Classification, and Logging.....	66
6.1 Materials Description and Classification.....	66
6.1.1 Soils.....	66
6.1.1.1 Color	67
6.1.1.2 Constituents.....	67
6.1.1.3 Grading	67
6.1.1.3.1 Coarse-Grained Soils	67
6.1.1.3.1.1 Well-Graded	67
6.1.1.3.1.2 Poorly-Graded	67
6.1.1.3.1.3 Gap-Graded	67
6.1.1.3.2 Fine-Grained Soil	67
6.1.1.4 Relative Density and Consistency	67
6.1.1.5 Friction Angle vs. SPT-N	68
6.1.1.6 Moisture Content	69
6.1.1.7 Particle Angularity and Shape	69
6.1.1.8 Organic Content	69
6.1.1.9 Additional Descriptive Terms.....	69
6.1.1.10 Classification.....	69
6.1.1.10.1 Unified Soil Classification System (USCS)	69
6.1.1.10.2 AASHTO Classification System	70
6.1.2 Rocks.....	70
6.1.2.1 Color	70
6.1.2.2 Constituents.....	70
6.1.2.3 Weathering.....	70
6.1.2.4 Hardness.....	70
6.1.2.5 Formation.....	71
6.1.2.6 Additional Description Terms.....	71
6.2 Logging.....	71
6.2.1 Comments on Drilling Procedures and/or Problems.....	71
6.2.2 Test Results	71

6.2.3 Rock Quality Designation (RQD)	71
6.3 References	80
6.4 Specifications and Standards	80
Chapter 7	81
7 Field Instrumentation	81
7.1 Instrumentation	81
7.1.1 Inclinometers (Slope Indicators)	81
7.1.2 Settlement Indicators	82
7.1.3 Piezometers	83
7.1.4 Tiltmeters	84
7.1.5 Monitoring Wells	84
7.1.6 Vibration Monitoring	84
7.1.7 Special Instrumentation	84
7.2 References	88
7.3 Specifications and Standards	88
Chapter 8	89
8 Analysis and Design	89
8.1 Roadway Embankment Materials	89
8.1.1 Limits of Unsuitable Materials	89
8.1.2 Limerock Bearing Ratio (LBR) (When Allowed)	89
8.1.3 Resilient Modulus (M_R)	90
8.1.4 Corrosivity	90
8.1.5 Drainage	90
8.1.6 Earthwork Factors	91
8.1.7 Other Considerations	91
8.2 Foundation Types	91
8.2.1 Spread Footings	91
8.2.1.1 Design Procedure	91
8.2.1.2 Considerations	92
8.2.2 Driven Piles	92
8.2.2.1 Design Procedure	92
8.2.2.2 Considerations	92
8.2.3 Drilled Shafts	93
8.2.3.1 Design Procedure for Major Structures	93
8.2.3.2 Considerations	94
8.2.3.3 Design Procedure for Miscellaneous Structures	95
8.2.4 Auger-Cast Piles	96
8.2.4.1 Design Procedure	96
8.2.4.2 Considerations	96
8.2.5 Micro Piles	96
8.2.5.1 Design Procedure	96
8.2.6 GRS Abutments	97
8.3 Foundation Analysis	97
8.3.1 Rock Fracture	97

8.3.2 Lateral Loads.....	98
8.3.3 Scour.....	98
8.3.4 Downdrag.....	98
8.3.5 Construction Requirements.....	99
8.3.6 Cofferdams & Sheet Piles.....	99
8.4 Embankment Settlement/Stability.....	100
8.4.1 Settlement.....	100
8.4.1.1 Design Procedure.....	100
8.4.1.2 Considerations.....	100
8.4.1.3 Possible Solutions.....	101
8.4.2 Stability.....	101
8.4.2.1 Design Procedure.....	101
8.4.2.2 Considerations.....	101
8.4.2.3 Possible Solutions.....	102
8.5 Retaining Wall Design.....	102
8.5.1 Gravity Walls.....	102
8.5.2 Counterfort Walls.....	103
8.5.3 MSE Walls.....	103
8.5.4 Sheet Pile Walls.....	103
8.5.5 Soil Nail Walls.....	104
8.5.6 Soldier Pile/Panel Walls.....	104
8.5.7 GRS Walls.....	105
8.5.7.1 Design Procedure.....	105
8.5.7.2 Considerations.....	105
8.6 Steepened Slopes.....	105
8.6.1 Design Procedure.....	105
8.6.2 Considerations.....	105
8.7 Computer Programs used in FDOT.....	108
8.8 References.....	112
Chapter 9.....	115
9 Presentation of Geotechnical Information.....	115
9.1 Roadway Soil Survey.....	115
9.1.1 General Information.....	115
9.1.2 Conclusion and Recommendations.....	115
9.1.3 Roadway Soils Survey (Report of Tests) Sheet.....	116
9.1.4 Roadway (and Pond, etc.) Cross Sections.....	116
9.1.5 Appendix.....	117
9.2 Structures Investigation.....	117
9.2.1 Introduction.....	117
9.2.2 Scope of Investigation.....	118
9.2.3 Interpretation of Subsurface Conditions.....	118
9.2.4 Existing Structures Survey and Evaluation.....	119
9.2.5 Structure Foundation Analysis and Recommendations.....	119
9.2.5.1 GRS Abutments.....	120
9.2.5.2 Spread Footings.....	120

9.2.5.3 Driven Piles.....	120
9.2.5.4 Drilled Shafts	122
9.2.5.5 Auger Cast Piles.....	123
9.2.6 Roadway and Approach Embankment Considerations.....	123
9.2.6.1 Settlement	123
9.2.6.2 Stability	124
9.2.6.3 Construction Considerations.....	124
9.2.7 Retaining Walls and Seawalls	124
9.2.8 Steepened Slopes.....	124
9.2.9 Technical Special Provisions	125
9.2.10 Appendix	125
9.3 Final or Supplementary Report.....	126
9.4 Signing and Sealing	126
9.5 Distribution.....	127
9.6 Plan and Specification Review	127
9.7 Electronic Files	127
9.8 Unwanted.....	128
Chapter 10	136
10 Construction and Post-Construction.....	136
10.1 Dynamic Pile Driving Analysis.....	136
10.2 Dynamic Monitoring of Pile Driving	137
10.3 Load Tests.....	137
10.3.1 Static Load Tests	138
10.3.2 Statnamic Load Tests	138
10.3.3 Other Rapid Load Tests.....	138
10.3.4 Osterberg Load Tests	138
10.4 Pile/Drilled Shaft Damage Assessment.....	138
10.4.1 Pile Integrity Testing.....	138
10.4.2 Crosshole Sonic Logging	139
10.4.3 Gamma-Gamma Density Logging	139
10.4.4 Thermal Integrity Testing of Drilled Shafts (TITDS).....	139
10.5 Drilled Shaft Construction.....	139
10.6 Shaft Inspection Device (SID).....	140
10.7 Field Instrumentation Monitoring	140
10.8 Troubleshooting.....	141
10.9 Records	141
10.10 References	145
10.11 Specifications and Standards.....	145
Chapter 11	147
11 Design-Build Projects	147
11.1 Planning and Development Phase:	147
11.1.1 Department’s Geotechnical Engineer Responsibilities.....	147
11.1.2 Design-build Team Responsibilities	147
11.2 Technical Proposals & Bidding Phase.....	147

11.2.1 Department’s Geotechnical Engineer Responsibilities	147
11.2.2 Design-Build Team Responsibilities.....	148
11.3 Design/Construction Phase.....	148
11.3.1 Department’s Geotechnical Engineer.....	148
11.3.2 Design-Build Team	148
Appendix A	149
Determination of Design Side Resistance for Drilled Shafts & Auger Cast Piles Socketed in the Florida Limestone Based on Rock Core Testing.....	149
Appendix B.....	160
Design Guidelines for Auger Cast Piles for Miscellaneous Structures Based on SPT or CPT Values Without Rock Core Tests	160
Appendix C.....	166
Step by Step Design Procedure for the Analysis of Downdrag	166
Appendix D	171
Design Method for Drilled Shaft with Pressure Grouted Tip	172
Appendix E.....	174
Reinforced Embankment Design Method.....	175
Appendix F	177
Determination Of Acceptance Criteria For Driven Piles	178
Determining the Capacity of a Pile from an Instrumented Set-Check.....	183
Appendix G	184
Cable Barrier Foundation Analysis using Broms’ Method.....	184
Appendix H	189
Specifications and Standards.....	189
ASTM.....	190
AASHTO	194
Florida Test Methods.....	195
Appendix I.....	197
Reference List	197
AASHTO.....	198
NCHRP	198
TRB	198
FDOT.....	198
FHWA	198
Military	200
Other Federal	200
Misc.	201

List of Figures

Figure 1, Excerpt from the Potentiometric Surface of the St. Johns River Water Management District and Vicinity, Florida, September 1993 map	12
Figure 2, Field Reconnaissance Report	13
Figure 3, Stress Distribution Below Equivalent Footing For Pile Group (AASHTO 2020).....	30
Figure 4, Chart for Determining the Maximum Depth of Significant Increase in Vertical Stress in the Foundation Soils Resulting from an Infinitely Long Trapezoidal Fill (both fill and foundation assumed homogeneous, isotropic and elastic). (After Schmertmann, 1967)	31
Figure 5, Example SPT-N Adjustments Due to Plugged Sampler	41
Figure 6, Typical Log from Mechanical Friction-Cone.....	42
Figure 7, Typical Log from Electric Piezocone.....	43
Figure 8, Typical Interpreted Output from Electric Cone Penetrometer	44
Figure 9, Schematic of the Marchetti Flat Dilatometer (After Baldi, et al., 1986).....	45
Figure 10, Dilatometer (After Marchetti 1980)	45
Figure 11, Dilatometer (Continued).....	46
Figure 12, Menard Pressuremeter Equipment (After NAVFAC, 1986).....	47
Figure 13, Vane Shear Test Equipment (After NAVFAC, 1986).....	48
Figure 14, Permeability Test Methods (from Bowles, 1984)	49
Figure 15, Formulas for Determination of Permeability (Hvorslev, 1951)	50
Figure 16, Angle of Internal Friction vs. SPT-N (After Peck, 1974)	72
Figure 17, C_N vs. Effective Overburden Pressure (After Peck, 1974).....	73
Figure 18, Unified Soil Classification System (After ASTM, 1993)	74
Figure 19, Unified Soil Classification System (After ASTM, 1993)(Cont.)	75
Figure 20, AASHTO Soil Classification System (After ASTM, 1993)	76
Figure 21, AASHTO Soil Classification System (After ASTM, 1993) (Cont.)	77
Figure 22, Field Boring Log Form.....	78
Figure 23, Typical Boring Log	79
Figure 24, Principle of Inclinator Operation (After Dunncliff, 1988)	85
Figure 25, Typical Settlement Platform Design (Standard Plans, Index 141-T01)	86
Figure 26, Example Pneumatic Pore Pressure Transducer	87
Figure 27, Design Example 1 (LBR Design Methods) 90% Method	110
Figure 28, Example of Rock Lens Punching Condition	111
Figure 29, Typical Report of Tests Sheet	129
Figure 30, Typical Roadway Cross-Section Sheet (Required border may differ).....	130
Figure 31, Generalized Soil Profile Example	131
Figure 32, Typical Report of Core Borings Sheet	132
Figure 33, Typical Report of Cone Soundings Sheet (Required border may differ).....	133
Figure 34, Standard Soil Type Symbols	135
Figure 35, Static Load Test.....	141
Figure 36, Axial Statnamic Load Test	142
Figure 37, Lateral Statnamic Load Test.....	142
Figure 38, Osterberg Load Cells.....	143

Figure 39, Pile Integrity Tester (After PDI, 1993).....	143
Figure 40, Shaft Inspection Device.....	144
Figure B 1	165
Figure G1, Broms' Deflection Factor vs. Length Factor (after FHWA-NHI-05-042)....	186

List of Tables

Table 1, Relative Density or Consistency	68
Table 2, Geotechnical Engineering Analysis Required in Reference 1 for Embankments, Cut Slopes, Structure Foundations and Retaining Walls	106
Table 3, Geotechnical Engineering Analysis Required in Reference 1(Continued)	107
Table 4, Example + 2% of Optimum Method Calculation	109
Table 5, Signing and Sealing Placement.....	126
Table 6, Applicability of Standard Soil Type Symbols	135

This page is intentionally blank.

Chapter 1

1 Introduction

The purpose of this handbook is to provide Geotechnical Engineers with a guide to the proper procedures in the performance of geotechnical activities for the Florida Department of Transportation. Specifically, this handbook is intended to define the tasks involved in performing a subsurface investigation and the geotechnical aspects of the design and construction of roadways and roadway structures. General guidelines are presented covering the geotechnical phases of a typical project.

As each project presents unique considerations and requires engineering judgment based on a thorough knowledge of the individual situation, the scope of services in the contract for each project supersedes the minimum scope of work outlined in this handbook. The scope of services dictates the specific practices, which are to be used on a particular project. Additionally, the scope defines the required interaction between the Department's Geotechnical Engineer and those performing the geotechnical work.

The design and construction of a roadway and related structures is a complex operation involving the participation of many department units and outside agencies. The key to the successful completion of the project is communication. It is essential that good communication, coordination and interaction exist between the Geotechnical Engineer and these other units and agencies. This interaction should continue throughout all project phases to ensure a reliable and cost-effective design and minimize construction problems.

This handbook is designed to present information in the same sequence, as it would occur during project development for a design-bid-construct project. A general outline of the tasks, which should be performed by a Geotechnical Engineer during a project, is shown in Sections **1.1.1** through **1.1.4**. The details of these tasks are discussed and amplified in subsequent chapters. Chapter 11 discusses the process for a design build project. A general outline of the tasks, which should be performed by a Geotechnical Engineer for a design build project, is shown in Sections [11.1](#) through [11.3](#).

Finally, it should be noted that this is not intended as an all-encompassing or comprehensive procedural handbook. Methods of subsurface investigation and of analyzing data and solving problems are not discussed in detail. The lists of references at the end of each chapter are but a few of the many sources of information that will provide the engineer with greater insight into investigation procedures and analysis and problem solving techniques. Clarification regarding the content of this Handbook is available from the District Geotechnical Engineer, the State Geotechnical Materials Engineer in Gainesville, and the State Geotechnical Engineer and State Construction Geotechnical Engineer in Tallahassee.

1.1 Geotechnical Tasks in Typical Highway Projects

1.1.1 Planning, Development, and Engineering Phase

- Prepare geotechnical scope of services for consultant projects.
- Assist in corridor and route selection.
- Review existing information.
- Perform field reconnaissance of site and existing structures.
- Plan and supervise field investigation program, field and laboratory testing.
- Analyze all data available.
- Prepare preliminary geotechnical report summarizing available data and providing recommendations
- Identify potential needs for the design investigation to address construction requirements and anticipate problems (performing requirements, vibration and noise impacts).

1.1.2 Project Design Phase

- Perform additional field investigations and provide additional or revised recommendations if called for in geotechnical report or if project has substantially changed since earlier investigations.
- Assist structural engineer in interpreting and applying geotechnical recommendations to design and special provisions and/or supplemental specifications.
- Design and if applicable perform load test programs or special instrumentation monitoring as deemed necessary.
- Review plans, special provisions and/or supplemental specifications.
- Identify construction activities and techniques to minimize potential construction requirements and problems (performing requirements, vibration and noise impacts).

1.1.3 Construction Phase

- Establish construction criteria for geotechnical portions of project.
- Inspect construction procedures to assure compliance with design and specifications.
- Design, install, perform, monitor, and evaluate load test programs and/or instrumentation systems.
- Solve unforeseen foundation and/or roadway soils problems.

1.1.4 Post-Construction Phase

- Assess and provide solutions to roadway and structure maintenance problems, which are related to the geotechnical characteristics of the site.
- Summarize construction procedures and/or problems and any changes in design made during construction.
- Provide information to State Geotechnical files for reference during the design of future projects.

Chapter 2

2 Subsurface Investigation Procedures

Because of the varying complexity of projects and soil conditions, it is very difficult to establish a rigid format to be followed in conducting each and every subsurface investigation; however, there are basic steps that should be considered for any project. By outlining and describing these steps, it will be possible to standardize procedures and considerably reduce time and expense often required to go back and obtain information not supplied by the initial investigation.

The basic steps are summarized in this and subsequent chapters. In this chapter, review of existing data is discussed, as well as commonly used methods for performing field explorations. Guidelines for minimum investigations for various types of projects are presented in [Chapter 3](#); field and laboratory test methods are discussed in [Chapters 4 & 5](#), respectively. Refer also to ASTM D 5434.

2.1 Review of Project Requirements

The first step in performing a subsurface investigation is a thorough review of the project requirements. It is necessary that the information available to the Geotechnical Engineer include the project location, alignment, structure locations, structure loads, approximate bridge span lengths and pier locations, and cut and fill area locations. The Geotechnical Engineer should have access to typical section, plan and profile sheets, and cross sections with a template for the proposed roadway showing cuts and fills. This information aids the Geotechnical Engineer in planning the investigation and minimizes expensive and time-consuming backtracking.

2.2 Review of Available Data

After gaining a thorough understanding of the project requirements, the Geotechnical Engineer should collect all relevant available information on the project site. Review of this information can aid the engineer in understanding the geology, geography and topography of the area and assist him in laying out the field explorations and locating potential problems. Contact the District Geotechnical Engineer for assistance in obtaining sources of this available data. Existing data may be available from the following sources:

2.2.1 Topographic Maps

These maps are prepared by the U.S. Geological Survey (USGS) and the U.S. Coast and Geodetic Survey (USCGS) and are readily available. They are sometimes also prepared on a larger scale by the Department during early planning phases of a project. These maps portray physical features, configuration and elevation of the ground surface, and surface water features. This data is valuable in determining accessibility for field equipment and possible problem areas.

2.2.2 Aerial Photographs

These photographs are available from the Department and other sources. They are valuable in that they can provide the basis for reconnaissance and, depending on the age of the photographs, show manmade structures, excavations, or fills that affect accessibility and the planned depth of exploration. Historical photographs can also help determine the reasons and/or potential of general scour and sinkhole activity.

2.2.3 Geological Maps and Reports

Considerable information on the geological conditions of an area can often be obtained from geological maps and reports. These reports and maps often show the location and relative position of the different geological strata and present information on the characteristics of the different strata. This data can be used directly to evaluate the rock conditions to be expected and indirectly to estimate possible soil conditions since the parent material is one of the factors controlling soil types. Geological maps and reports can be obtained from the USGS, Florida Geological Survey, university libraries, and other sources.

2.2.4 Natural Resources Conservation Service Surveys

These surveys are compiled by the U.S. Department of Agriculture usually in the form of county soils maps. These surveys can provide valuable data on shallow surface soils including mineralogical composition, grain size distribution, depth to rock, water table information, drainage characteristics, geologic origin, and the presence of organic deposits.

2.2.5 Potentiometric Surface Map

The potentiometric surface elevation shown on the map (see [Figure 1](#)) can supplement and be correlated with what was found in the field by the drillers. The Potentiometric Surface map can be obtained from the local Water Management District office.

2.2.6 Adjacent Projects

Data may be available on nearby projects from the Department, or county or city governments. The Department may have soils data on file from state projects and as-built drawings and pile driving records for the final structure. This data is extremely useful in setting preliminary boring locations and depths and in predicting problem areas. Maintenance records for existing nearby roadways and structures may provide additional insight into the subsurface conditions. For example, indications of differential settlement or slope stability problems may provide the engineer with valuable information on the long-term characteristics of the site.

2.3 Field Reconnaissance

Following review of the existing data, the Geotechnical Engineer should visit the project site. This will enable the engineer to gain first-hand knowledge of field

conditions and correlate this information with previous data. The form included as [Figure 2](#) indicates the type of information the engineer should look for. In particular, the following should be noted during the field reconnaissance:

1. Nearby structures should be inspected to ascertain their foundation performance and potential to damage from vibration or settlement from foundation installation. Also, the structure's usages must be looked at to check the impact the foundation installation may have (i.e. a surgical unit, printing company, etc.).
2. On water crossings, banks should be inspected for scour and the streambed inspected for evidence of soil deposits not previously indicated.
3. Note any feature that may affect the boring program, such as accessibility, structures, overhead utilities, signs of buried utilities, or property restrictions.
4. Note any feature that may assist in the engineering analysis, such as the angle of any existing slopes and the stability of any open excavations or trenches.
5. Any drainage features, including signs of seasonal water tables.
6. Any features that may need additional borings or probing such as muck pockets.

2.4 Field Exploration Methods

Assuming access and utility clearances have been obtained and a survey base line has been established in the field, field explorations are begun based on the information gained during the previous steps. Many methods of field exploration exist; some of the more common are described below. These methods are often augmented by in-situ testing (see [Chapter 4](#)).

2.4.1 Test Pits and Trenches

These are the simplest methods of inspecting subsurface soils. They consist of excavations performed by hand, backhoe, or dozer. Hand excavations are often performed with posthole diggers or hand augers. They offer the advantages of speed and ready access for sampling. They are severely hampered by limitations of depth and by the fact they cannot be used in soft or loose soils or below the water table. In Florida their use is generally limited to borrow pits.

2.4.2 Boreholes

Borings are probably the most common method of exploration. They can be advanced using a number of methods, as described below. Upon completion, all borings should be backfilled in accordance with applicable Department of Environmental Protection and Water Management District regulations. In many cases this will require full depth grouting.

2.4.2.1 Auger Borings

Rotating an auger while simultaneously advancing it into the ground; the auger is advanced to the desired depth and then withdrawn. Samples of cuttings can be removed from the auger; however, the depth of the sample can only be approximated. These samples are disturbed and should be used only for material identification. This method is used to establish soil strata and water table elevations, or to advance to the desired stratum before Standard Penetration Testing (SPT) or undisturbed sampling is performed. However, it may not be effective in very soft or loose soils below the water table without casing or drilling mud to hold the hole open. See ASTM D 1452.

2.4.2.2 Hollow-Stem Auger Borings

A hollow-stem auger consists of a continuous flight auger surrounding a hollow drill stem. The hollow-stem auger is advanced similar to other augers; however, removal of the hollow stem auger is not necessary for sampling. SPT and undisturbed samples are obtained through the hollow drill stem, which acts like a casing to hold the hole open. This increases usage of hollow-stem augers in soft and loose soils. See ASTM D 6151.

2.4.2.3 Wash Borings

In this method, the boring is advanced by a combination of the chopping action of a light bit and the jetting action of water flowing through the bit. This method of advancing the borehole is used only when precise soil information is not required between sample intervals.

2.4.2.4 Coring

A core barrel is advanced through rock by the application of downward pressure during rotation. Circulating water removes ground-up material from the hole while also cooling the bit. The rate of advance is controlled so as to obtain the maximum possible core recovery. Refer to [2.4.5.5 Rock Core Sampling](#) for details.

2.4.3 Soundings

A sounding is a method of exploration in which either static or dynamic force is used to cause a rod tipped with a testing device to penetrate soils. Samples are not usually obtained. The depth to rock can easily be deduced from the resistance to penetration. The resistance to penetration can be measured and correlated to various soil properties. See [Chapter 4](#) for details of the cone penetrometer.

2.4.4 Geophysical Methods

These are nondestructive exploratory methods in which no samples can be taken. Geophysical methods can provide information on the general subsurface profile, the depth to bedrock, depth to groundwater, and the location of granular borrow areas, peat deposits, or subsurface anomalies. Results can be significantly affected by many factors however, including the presence of groundwater, non-

homogeneity of soil stratum thickness, and the range of wave velocities within a particular stratum. In addition, all surface geophysical methods are inherently limited by decreasing resolution with depth. For this reason, geophysical explorations should always be accompanied by conventional borings and an experienced professional must interpret results. (See ASTM D 6429 and US Army Corps of Engineers Engineering Manual EM-1110-1-1802) Geophysical methods commonly used for engineering purposes include:

2.4.4.1 Seismic Refraction and Reflection

These methods rely on the fact that shock waves travel through different materials at different velocities. The times required for an induced shock wave to travel to set detectors after being refracted or reflected by the various subsurface materials are measured. This data is then used to interpret material types and thickness. Seismic refraction is limited to material stratifications in which velocities increase with depth. For the seismic refraction method, refer to ASTM D 5777. Seismic investigations can be performed from the surface or from various depths within borings. For cross-hole seismic techniques, see ASTM D 4428.

2.4.4.2 Resistivity

This method is based on the differences in electrical conductivity between subsurface strata. An electric current is passed through the ground between electrodes and the resistivity of the subsurface materials is measured and correlated to material types. Several electrode arrangements have been developed, with the Wenner (4 equally spaced electrodes) being the most commonly used in the United States. Refer to ASTM G 57 and D 6431.

2.4.4.3 Ground Penetrating Radar (GPR)

The velocity of electromagnetic radiation is dependent upon the material through which it is traveling. GPR uses this principle to analyze the reflections of radar signals transmitted into the ground by a low frequency antenna. Signals are continuously transmitted and received as the antenna is towed across the area of interest, thus providing a profile of the subsurface material interfaces.

Penetration is commonly on the order of 3 to 30 ft. GPR is limited by the contrast in the properties of adjacent material. In addition to having sufficient velocity contrast, the boundary between the two materials needs to be sharp. For instance, it is more difficult to see a water table in fine-grained materials than in coarse-grained materials because of the different relative thicknesses of the capillary fringe for the same contrast. See ASTM D 6432.

2.4.5 Soil Sampling

Common methods of sampling during field explorations include those listed below. All samples should be properly preserved and carefully transported to the laboratory such that sample properties and integrity are maintained. See ASTM D 4220.

2.4.5.1 Bag Bulk Samples

These are disturbed samples obtained from auger cuttings or test pits. The quantity of the sample depends on the type of testing to be performed, but can range up to 50 lb. or more. Testing performed on these samples includes classification, moisture-density, Limerock Bearing Ratio (LBR), and corrosivity tests. A portion of each sample should be placed in a sealed container for moisture content determination.

2.4.5.2 Split-Barrel

Also known as a split-spoon sample, this method is used in conjunction with the Standard Penetration Test (see [Chapter 4](#)). The sampler is a 2-inch (O.D.) split barrel which is driven into the soil with a 140-pound hammer dropped 30 inches. After it has been driven 18 inches, it is withdrawn and the sample removed. The sample should be immediately examined, logged and placed in sample jar for storage. These are disturbed samples and are not suitable for strength or consolidation testing. They are adequate for moisture content, gradation, and Atterberg Limits tests, and valuable for visual identification. See ASTM D 1586.

2.4.5.3 Shelby Tube

This is thin-walled steel tube, usually 3 inches (O.D.) by 30 inches in length. It is pushed into the soil with a relatively rapid, smooth stroke and then retracted. This produces a relatively undisturbed sample provided the Shelby tube ends are sealed immediately upon withdrawal. Refer to ASTM D 1587 (AASHTO T 207).

This sample is suitable for strength and consolidation tests. This sampling method is unsuitable for hard materials. Good samples must have sufficient cohesion to remain in the tube during withdrawal. Refer to ASTM D 1587 (AASHTO T 207).

When materials are too weak to be retained by a Shelby tube, a piston type of sampler should be used.

2.4.5.4 Piston Samplers

2.4.5.4.1 Stationary

This sampler has the same standard dimensions as the Shelby Tube, above. A piston is positioned at the bottom of the thin-wall tube while the sampler is lowered to the bottom of the hole, thus preventing disturbed materials from entering the tube. The piston is locked in place on top of the soil to be sampled. A sample is obtained by pressing the tube into the soil with a continuous, steady thrust. The stationary piston is held fixed on top of the soil while the sampling tube is advanced. This creates suction while the sampling tube is retrieved thus aiding in retention of the sample. This sampler is suitable for soft to firm clays, silts and

organics. Samples are generally less disturbed and have a better recovery ratio than those from the Shelby Tube method.

2.4.5.4.2 Floating

This sampler is similar to the stationary method above, except that the piston is not fixed in position but is free to ride on the top of the sample. The soils being sampled must have adequate strength to cause the piston to remain at a fixed depth as the sampling tube is pushed downward. If the soil is too weak, the piston will tend to move downward with the tube and a sample will not be obtained. This method should therefore be limited to stiff or hard cohesive materials.

2.4.5.4.3 Retractable

This sampler is similar to the stationary sampler, however, after lowering the sampler into position the piston is retracted and locked in place at the top of the sampling tube. A sample is then obtained by pushing the entire assembly downward. This sampler is used for loose or soft soils.

2.4.5.4.4 Hydraulic (Osterberg)

In this sampler, a movable piston is attached to the top of a thin-wall tube. Sampling is accomplished as hydraulic pressure pushes the movable piston downward until it contacts a stationary piston positioned at the top of the soil sample. The distance over which the sampler is pushed is fixed; it cannot be over-pushed. This sampler is used for very soft to firm cohesive and organic soils.

2.4.5.5 Rock Core Sampling

Rock cores shall be obtained in accordance with ASTM D 2113 Standard Practice for Diamond Core Drilling for Site Excavation using a double or triple wall core barrel equipped with diamond or tungsten-carbide tipped bits. There are three basic types of core barrels: Single tube, double tube, and triple tube. Single tube core barrels generally provide poor recovery rates in Florida limestone and their use is not allowed. Double tube core barrels for 2.4 inch cores generally provide lesser quality samples than triple tube barrels, and shall only be used for core samples larger than 3.5 inches. Triple tube core barrels are required for core samples smaller than 3.5 inches and are described below. (Note: face discharge bits generally provide better return in Florida limestone). Refer to ASTM D 5079 for practices of preserving and transporting rock core samples.

2.4.5.5.1 Double Tube Core Barrel

This core barrel consists of inner and outer tubes equipped with a diamond or tungsten-carbide drill bit. As coring progresses, fluid is introduced downward between the inner and outer tubes to cool the bit and to wash ground-up material to the surface. The inner tube protects the

core from the highly erosive action of the drilling fluid. In a rigid type core barrel, both the inner and outer tubes rotate. In a swivel type, the inner tube remains stationary while the outer tube rotates. Several series of swivel type core barrels are available. Barrel sizes vary from EWG or EWM (0.845 inch to 6 inch I.D.). The larger diameter barrels are used in highly erodible materials, such as Florida limestone, to generally obtain better core recovery. The minimum core barrel to be used shall be HW (2.4 inch I.D.), and it is recommended using 4 inch I.D. core barrels to better evaluate the Florida limestone properties.

2.4.5.5.2 Triple Tube Core Barrel

Similar to the double tube, above, but has an additional inner liner, consisting of either a clear plastic solid tube or a thin metal split tube, in which the core is retained. This barrel best preserves fractured and poor quality rock cores.

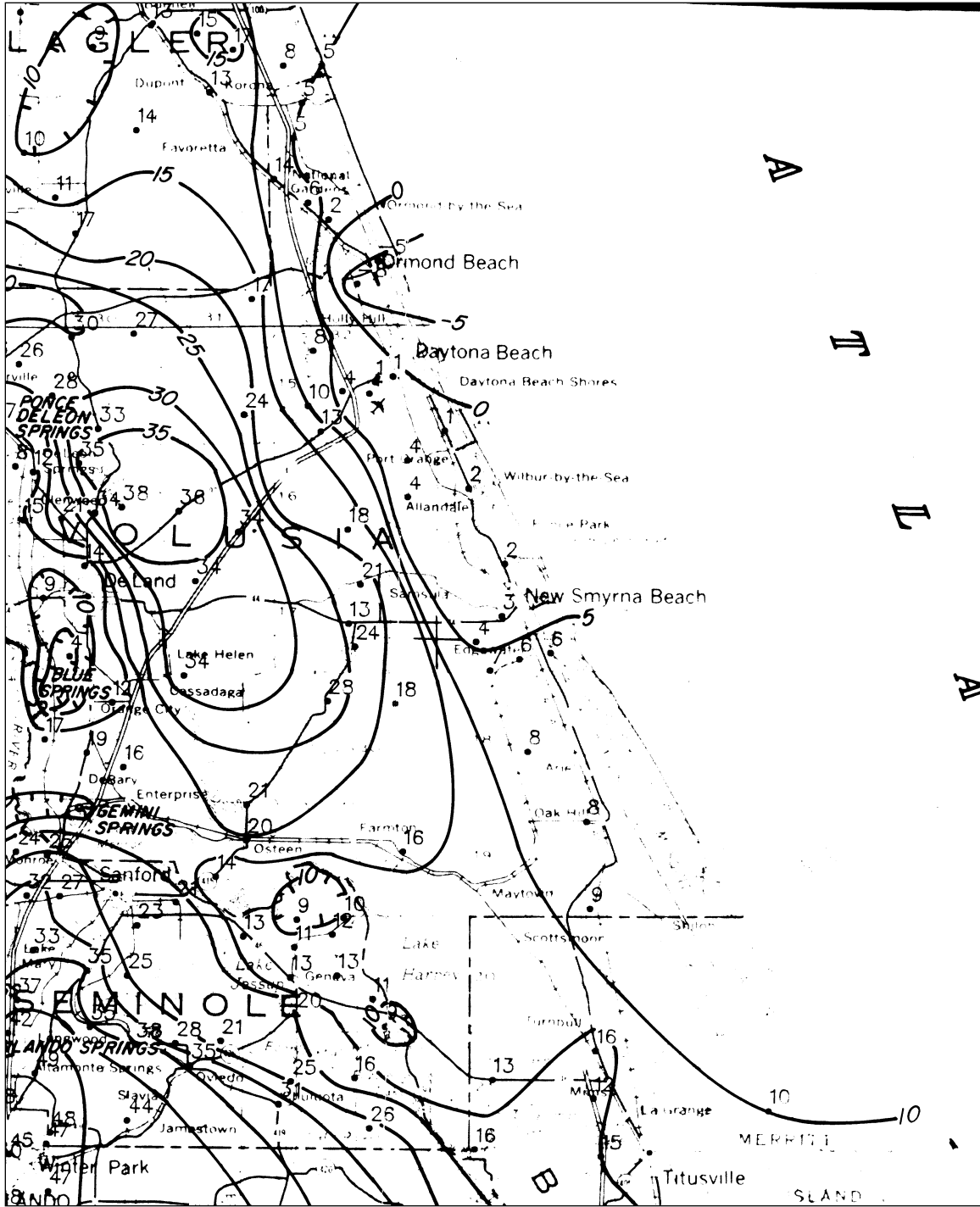

Figure 1, Excerpt from the Potentiometric Surface of the St. Johns River Water Management District and Vicinity, Florida, September 1993 map

STATE OF FLORIDA DEPARTMENT OF TRANSPORTATION
FIELD RECONNAISSANCE REPORT

FORM 675-020-14
 MATERIALS
 05/99

FIN PROJ= _____ OLD STATE PROJECT NUMBER: _____ COUNTY: _____

REPORTED BY: _____ DATE _____

<p>1. STATIONING</p> <p><input type="radio"/> WELL MARKED</p> <p><input type="radio"/> POORLY MARKED (WE CAN WORK)</p> <p><input type="radio"/> POORLY MARKED (WE MUST REMARK)</p> <p><input type="radio"/> REQUEST TO REMARK</p>	<p>8. FOUNDATIONS (CONTINUED)</p> <p>IF WATER CROSSING: WILL BARGE BE NECESSARY: _____ EASILY PLACED IN WATER: _____ CURRENT <input type="radio"/> SWIFT <input type="radio"/> MODERATE <input type="radio"/> SLOW :</p> <p>IF PRESENT BRIDGE NEARBY, WHAT TYPE OF FOUNDATION: _____ ANY PROBLEMS EVIDENT IN OLD BRIDGE (DESCRIBE ON BACK) IS WATER SUPPLY NEARBY: _____</p>
<p>2. BENCH MARKS</p> <p>IN PLACE: <input type="radio"/> YES <input type="radio"/> NO</p> <p>DISTANCE FROM WORKSITE : _____</p>	<p>9. GROUND WATER TABLE DEPTH: _____ _____ _____</p> <p>PRESENT WATER LOCATION: _____ _____ _____</p>
<p>3. PROPERTY OWNERS</p> <p>GRANTED PERMISSION: <input type="radio"/> YES <input type="radio"/> NO</p> <p>REMARKS ON BACK</p>	<p>10. CAPROCK</p> <p>BOULDERS OVER AREA? <input type="radio"/> YES <input type="radio"/> NO</p> <p>DEFINITE OUTCROP? <input type="radio"/> YES <input type="radio"/> NO</p> <p>(SHOW SKETCH ON BACK) WHAT KIND? _____ _____</p>
<p>4. UTILITIES</p> <p>WILL DRILLERS ENCOUNTER UNDERGROUND UTILITIES? <input type="radio"/> YES <input type="radio"/> NO</p> <p>AT WHICH AREA? _____ WHAT TYPE? _____ _____ _____</p>	<p>11. SPECIAL EQUIPMENT NECESSARY</p> <p>_____</p> <p>_____</p> <p>_____</p>
<p>5. SURFACE SOILS</p> <p><input type="radio"/> SAND <input type="radio"/> CLAY <input type="radio"/> SANDY CLAY</p> <p><input type="radio"/> SILT <input type="radio"/> MUCK <input type="radio"/> OTHER</p>	<p>12. REMARKS ON ACCESS</p> <p>DESCRIBE ANY PROBLEMS ON ACCESS</p> <p>_____</p> <p>_____</p>
<p>6. GENERAL SITE DESCRIPTION</p> <p><input type="radio"/> LEVEL <input type="radio"/> ROLLING <input type="radio"/> HILLSIDE</p> <p><input type="radio"/> VALLEY <input type="radio"/> SWAMP <input type="radio"/> GULLIED</p> <p>GROUND COVER</p> <p><input type="radio"/> CLEARER <input type="radio"/> FARMED <input type="radio"/> BUILDINGS</p> <p><input type="radio"/> HEAVY WOODS <input type="radio"/> LIGHT WOODS <input type="radio"/> OTHER</p> <p>REMARKS ON BACK</p>	<p>13. DEBRIS AND SANITARY DUMPS</p> <p>LOCATION: _____</p> <p>REMARKS: _____ _____ _____</p>
<p>7. SOIL SURVEY</p> <p>LENGTH _____</p> <p><input type="radio"/> DRILL RIG (WHEELED)</p> <p><input type="radio"/> DRILL RIG (WHEELED ATV)</p> <p><input type="radio"/> DRILL RIG (TRACK)</p>	
<p>8. FOUNDATIONS</p> <p>REPLACING: _____</p> <p>WIDENING: _____</p> <p>RELOCATION: _____</p> <p><input type="radio"/> DRILL RIG (TRUCK MOUNTED)</p> <p><input type="radio"/> DRILL RIG (WHEELED ATV)</p> <p><input type="radio"/> DRILL RIG (TRACK)</p> <p><input type="radio"/> SKID RIG</p> <p><input type="radio"/> WATER TRUCK</p> <p><input type="radio"/> SAND PUMP</p>	

RECYCLED PAPER 

Figure 2, Field Reconnaissance Report

2.5 References

1. Cheney, Richard S. & Chassie, Ronald G., Soils and Foundations Workshop Manual – Second Edition, FHWA HI-88-009, 1993.
2. NAVFAC DM-7.1 - Soil Mechanics, Department of the Navy, Naval Facilities Engineering Command, 1986.
3. Hannigan, P.J., Goble, G.G., Thendean, G., Likins, G.E., and Rausche, F., Manual on Design and Construction of Driven Pile Foundations, FHWA-HI-97-013 and 014, 1996.
4. Fang, Hsai-Yang, Foundation Engineering Handbook Second Edition, Van Nostrand Reinhold Company, New York, 1990.
5. AASHTO, Manual on Subsurface Investigations, Washington DC, 1988.
6. Munfakh, George, Arman, Ara, Samtani, Naresh, and Castelli, Raymond, Subsurface Investigations, FHWA-HI-97-021, 1997.
7. Recommended Guidelines for Sealing Geotechnical Exploratory Holes, National Cooperative Highway Research Program, NCHRP Report 378
8. Engineering Manual 1110-1-1802, Geophysical Exploration for Engineering and Environmental Investigations, Department of Army, U.S. Army Corps of Engineers, 1995

2.6 Specifications and Standards

<u>Subject</u>	<u>ASTM</u>	<u>AASHTO</u>
Standard Practice for Soil Investigation and Sampling by Auger Borings	D 1452	-
Standard Test Method for Penetration Test and Split-Barrel Sampling of Soils	D 1586	T 206
Standard Practice for Thin-Walled Tube Sampling of Soils for Geotechnical Purposes	D 1587	T 207
Standard Practice for Diamond Core Drilling for Site Investigation	D 2113	T 225
Standard Practices for Preserving and Transporting Soil Samples	D 4220	-
Standard Test Methods for Crosshole Seismic Testing	D 4428	-
Standard Practices for Preserving and Transporting Rock Core Samples	D 5079	-
Standard Guide for Field Logging of Subsurface Explorations of Soil and Rock	D 5434	-
Standard Guide for Using the Seismic Refraction Method for Subsurface Investigation	D 5777	-

<u>Subject</u>	<u>ASTM</u>	<u>AASHTO</u>
Standard Practice for Using Hollow-Stem Augers for Geotechnical Exploration and Soil Sampling	D 6151	-
Standard Test Method for Field Measurement of Soil Resistivity Using the Wenner Four-Electrode Method	G 57	-
Standard Guide for Selecting Surface Geophysical Methods	D 6429	-
Standard Guide for Using the Direct Current Resistivity Method for Subsurface Investigation	D 6431	

Chapter 3

3 Subsurface Investigation Guidelines for Highways and Related Structures

A subsurface investigation should be performed at the site of all new structure, roadway construction, widenings, extensions, trails and rehabilitation locations as directed by the District Geotechnical Engineer or project scope.

This chapter presents guidelines to plan a subsurface investigation program. As the requirements will vary with the project conditions, engineering judgment is essential in tailoring the investigation to the specific project.

The amounts and types of data obtained during a subsurface investigation are often constrained by limitations of time, manpower, equipment, access, or funds. However, as a minimum, the investigation should provide sufficient data for the Geotechnical Engineer to recommend the most efficient design. Without sufficient data, the engineer must rely on conservative designs, which may cost considerably more than an extended exploration program.

A comprehensive subsurface investigation program might include both conventional borings and other specialized field investigatory or testing methods. While existing data can provide some preliminary indication of the necessary extent of exploration, more often it will be impossible to finalize the investigation plan until some field data is available. Therefore, close communication between the engineer and driller is essential. The results of preliminary borings should be reviewed as soon as possible so that additional borings and in-situ testing, if necessary, can be performed without remobilization and with a minimum loss of time.

Modification for Non-Conventional Projects:
Delete the first paragraph and insert the following: A subsurface investigation should be performed at the site of all new structure, roadway construction, widenings, extensions, trails and rehabilitation locations as outlined herein, except as otherwise described in the RFP.

3.1 General Requirements

The extent of the exploration will vary considerably with the nature of the project. However, the following general standards apply to all investigation programs or as appropriate for the specific project and agreed upon by the District Geotechnical Engineer:

Modification for Non-Conventional Projects:

Delete the previous paragraph and insert the following:

The following general standards apply as outlined herein to all investigation programs, except as otherwise described in the RFP:

1. Preliminary exploration depths should be estimated from data obtained during field reconnaissance, existing data, local geology and local experience. The borings should penetrate unsuitable founding materials (organic soils, soft clays, loose sands, etc.) and terminate in competent material. Competent materials are those suitable for support of the foundations being considered.
2. All borings shall be extended below the estimated scour depths.
3. Each boring, sounding, and test pit should be given a unique identification number for easy reference.
4. The horizontal and vertical location shall be determined for each boring, sounding, and test pit as follows:

Offshore borings should be referenced to mean sea level with the aid of a tide gauge. (Note: There are two vertical datums. They are the 1929 datum and the 1988 datum; ensure that the proper one is being referenced.)
5. Locate bridge borings by survey; use survey methods or a field Global Positioning System (GPS) unit with a manufacturer's rated accuracy of ± 10 feet to locate the Longitude and Latitude coordinates of roadway, pond and miscellaneous structure borings, and the boundaries of muck probe areas.
6. A sufficient number of samples, suitable for the types of testing intended, should be obtained within each layer of material.
7. Water table observation within each boring or test pit should be recorded after sufficient time (typically 24 hours) has elapsed for the water table to stabilize. Other groundwater observations (artesian pressure, etc.) should also be recorded.
8. Unless serving as an observation well, each borehole, sounding, and test pit should be backfilled or grouted according to applicable environmental guidelines. Refer to Reference 6.

3.2 Guidelines for Minimum Explorations

Following is a description of the recommended minimum explorations for various types of projects. It is stressed that these guidelines represent the minimum extent of exploration and testing anticipated for most projects and must be adapted to the specific requirements of each individual project. The District Geotechnical Engineer should be consulted for assistance in determining the requirements of a

specific project. Coordinate the assessment of soil variability and the need for increased boring frequency with the District Geotechnical Engineer. Additionally, the Engineer should verify that the Federal Highway Administration (FHWA) minimum criteria are met. Refer to Reference 3.

It is noted that the guidelines below consider the use of conventional borings only. While this is the most common type of exploration, the Engineer may deem it appropriate on individual projects to include soundings, test pits, geophysical methods, or in-situ testing as supplementary explorations or as substitutes for some, but not all, of the conventional borings noted in the following sections.

Modification for Non-Conventional Projects:

Delete the first sentence and insert the following:

The following are the minimum explorations for various types of projects, except as otherwise described in the RFP:

3.2.1 Roadway Soil Surveys and Rails to Trails/Multi-use Trail Projects

Soil survey explorations are made along the proposed roadway alignment for the purpose of defining subsurface materials. This information is used in the design of the pavement section, as well as in defining the limits of unsuitable materials and any remedial measures to be taken. Soil survey information is also used in predicting the probable stability of cut or fill slopes.

Minimum criteria for soil surveys vary substantially, depending on the location of the proposed roadway, the anticipated subsurface materials, and the type of roadway. The following are basic guidelines covering general conditions. It is important that the engineer visit the site to ensure all features are covered. In general, if a structure boring is located in close proximity to a planned soil survey boring, the soil survey boring may be omitted.

- a. At least one boring shall be placed at each 100-foot interval. Generally, borings are to be staggered left and right of the centerline to cover the entire roadway corridor. Borings may be spaced further apart if pre-existing information indicates the presence of uniform subsurface conditions. Additional borings shall be located as necessary to define the limits of any undesirable materials or to better define soil stratification.
- b. In areas of variable soil conditions, additional borings shall be located at each interval considering the following criteria.
 - 1) For interstate highways, three borings are to be placed at each interval, one within the median and one within each roadway.
 - 2) For four lane roadways, two borings are to be placed at each interval, one within each roadway.

- c. For roadway widenings that provide an additional lane, one boring shall be placed within the additional lane at each interval.
- d. In areas of cut or fill, where stability analysis is anticipated, a minimum of two additional borings shall be placed at each interval near the outer reaches of the sloped areas.
- e. In all cases, at least three samples per mile or 3 per project whichever is greater shall be obtained for each stratum encountered. Each of the samples representing a particular stratum shall be obtained from a different location, with sampling locations spread out over each mile. Samples should be of adequate size to permit classification and moisture content testing.
- f. For new construction, three 100 lb. samples per mile per stratum or 5 per project whichever is greater, of all materials within 4 feet below the proposed base elevation and considered 'Select' in accordance with Standard Plans, Index 120-001 shall be obtained and delivered to the State Materials Office in Gainesville for Resilient Modulus (M_R) testing. Samples of all strata located in excavation areas (i.e., water retention areas, ditches, cuts, etc.), which can be used in accordance with Standard Plans, Index 120-001 shall also be obtained for M_R testing when fill below paved areas will be required.
- g. Corrosion series samples shall be obtained (unless no structures are to be installed) on a frequency of at least one sample per stratum per 1,500 feet of alignment.
- h. When a rigid pavement is being considered for design, obtain sufficient samples to perform laboratory permeability tests based upon the requirements given in the Rigid Pavement Design Manual.
- i. Borings in areas of little or no grade change shall extend a minimum of 5 feet below grade, drainage pipe or culvert invert level whichever is deeper. For projects with proposed buried storm sewer systems, one boring shall be extended to a nominal depth of 20 feet below grade every 500 feet along the alignment of the storm sewer system; project specifics may dictate adjustments. For projects with proposed regular light poles, one boring shall be extended to a nominal depth of 10 feet below grade every 500 feet along the alignment if borings for buried storm sewer systems are not performed; project specifics may dictate adjustments. Borings may or may not include Standard Penetration Tests (SPT), depending on the specific project requirements and its location.
- j. In areas of cut, borings shall extend a minimum of 5 feet below the proposed grade, drainage pipe or culvert invert level whichever is deeper. If poor soil conditions are encountered at this depth, borings shall be extended to suitable materials or to a depth below grade equal to the depth of cut, whichever occurs first. Bag, SPT, undisturbed and core samples shall be obtained as appropriate for analyses.

- k. In areas of fill, borings shall extend to firm material or to a depth of twice the embankment height, whichever occurs first. Bag, SPT, and undisturbed samples shall be obtained as appropriate.
- l. Delineate areas of deleterious materials (muck, plastic soils, trash fill, buried slabs or pavements, etc.) to both the vertical and the horizontal extents.

3.2.2 Structures

The purpose of structure borings is to provide sufficient information about the subsurface materials to permit design of the structure foundations and related geotechnical construction. The following general criteria should satisfy this purpose on most projects; however, it is the engineer's responsibility to assure that appropriate explorations are carried out for each specific project.

All structure borings shall include Standard Penetration Testing (SPT) at regular intervals unless other sampling methods and/or in-situ testing (as defined in **Chapter 4**) are being performed. Extend borings sufficiently below the shallow foundation, or deep foundation tip elevations in accordance with the FHWA minimum criteria to determine the adequacy of the bearing soils and the long term settlement behavior of the foundation. Refer to Reference 3.

The actual elevation and location of each boring and sounding including the Station, Offset, Latitude and Longitude shall be determined by the project surveyor either before or after the boring or sounding is performed. Corrosion testing must be performed for each site unless the structure is designed for the most aggressive conditions.

3.2.2.1 Bridges

- 1) Minimum frequency of Bridge Foundation Borings (increase boring frequency for highly variable sites). For straddle piers, consider each column as a separate pier:
 - a. Spread Footings –
 - i. Footings < 70 feet wide - at least one boring per footing
 - ii. Footings \geq 70 feet wide - at least two borings per footing
 - b. Driven Piles –
 - i. for all bridges without test piles ensure at least one boring is within 50 feet of every pile;
 - ii. for bridges with test piles & spans \geq 60'
 - Bents/pier foundations < 70 feet wide - at least one boring per bent/pier foundation per structure;
 - Bents/pier foundations \geq 70 feet wide - at least two evenly spaced borings within each bent/pier foundation per structure;
 - iii. for bridges with test piles & spans < 60'
 - Bents/pier foundations < 70 feet wide - at least one boring at every other bent/pier foundation per structure

- Bents/pier foundations ≥ 70 feet wide - at least two evenly spaced borings within every other bent/pier foundation (or one boring at alternating ends of every bent/pier foundation) per structure
- c. Redundant Drilled Shafts - at least one per bent/pier foundation in consistent soil conditions; in variable soil conditions, ensure at least one boring is within 20 feet of each shaft.
- d. Nonredundant Drilled Shafts – at least one per shaft (See 12)
- e. Auger Cast Piles (ACP) –
 - Bents/pier foundations < 70 feet wide - at least one boring per bent/pier per structure within 25 feet of each bent/pier footing;
 - Bents/pier foundations ≥ 70 feet wide - at least two evenly spaced borings per bent/pier foundation per structure, with at least one boring within 25 feet of each end of each bent/pier footing;
 - All bridges with ACP foundations require static load tests. Perform at least one boring within 5 feet of the location of the static load test pile.

For structure widenings, the total number of borings may be reduced depending on the information available for the existing structure.

When practical, perform each 2.5-inch minimum diameter SPT boring at each pier or abutment location during the design phase. The hole pattern should be staggered so that borings occur at the opposite ends of adjacent piers.

- 2) If pier locations are unknown, a Phase I Investigation including borings spaced approximately every 500 feet, or as directed by the District Geotechnical Engineer, may be performed to provide sufficient information for the structural engineer to complete the Bridge Development Report process and determine the locations of the bridge piers. Perform the pier specific borings during a Phase II Investigation after the bridge pier locations are determined.

Modification for Non-Conventional Projects:
Delete Item 2) and replace with “2) If pier locations are unknown, perform a Phase I Investigation including borings spaced to provide sufficient information for the structural engineer to complete the Bridge Development Report process and determine the locations of the bridge piers. Perform the pier foundation specific borings during the design phase after the bridge pier locations are determined.”

- 3) Boring depths must consider the most likely foundation type for the bridge.
 - a. Borings for shallow foundations shall be continued to a depth below the foundation of :
 - i. $2B$ where $L < 2B$,
 - ii. $5B$ where $L > 5B$
 - iii. Interpolate depth for L between $2B$ and $5B$

where B is the diameter of a circular foundation or the smaller dimension of a rectangular foundation, and L is the larger dimension of a rectangular foundation.
 - b. Borings for driven pile foundations tipped in soil shall be continued until all unsuitable foundation materials have been penetrated and the predicted stress from the equivalent footing loading is less than 10% of the original overburden pressure (see [Figure 3](#)). For pile foundations tipped in rock (with core $q_u \geq 550$ psi or $N=100$), continue borings to at least 10 feet below the foundation tip elevations. For piles tipped in weaker materials, continue borings to at least 20 feet below the foundation tip elevations.

Commentary: For typical pile resistances, borings to at least 25 feet of competent bearing material (generally N -values of 50 or greater) will usually satisfy the above.
 - c. Borings for rock socketed drilled shafts shall continue through competent materials for at least two shaft diameters below the expected shaft tip elevation (See 6). Borings for non-rock socketed drilled shafts shall continue through competent materials for at least two times the width of the shaft group below the expected shaft tip elevation. (Scour and lateral requirements must be satisfied.) For nonredundant drilled shafts see additional requirements below.
 - d. Borings for rock socketed ACP shall continue through competent materials for at least 10 feet below the expected pile tip elevation (See 6). Borings for non-rock ACP shall continue through competent materials for at least two times the width of the pile group below the expected pile tip elevation. (Scour and lateral stability requirements must be satisfied.)
- 4) When using the Standard Penetration Test, split-spoon samples shall be obtained at a maximum interval of 2.5 to 3.0 feet and at the top of each stratum. Continuous SPT sampling in accordance with ASTM D 1586 is required in the top 15 feet unless the material is obviously unacceptable for shallow foundations.
- 5) When cohesive soils are encountered, undisturbed samples shall be obtained at 5-foot intervals in at least one boring. Undisturbed samples shall be obtained from more than one boring where possible.
- 6) When rock is encountered, successive core runs shall be made with the

objective of obtaining the best possible core recovery. **SPT's shall be performed between core runs, typically at 5-foot intervals.**

- 7) For bridges (including pedestrian bridges) to be supported by nonredundant drilled shaft foundations (See Section 8.2.3 Drilled Shafts.), perform at least one SPT boring at each drilled shaft location during the design phase.
- 8) In-situ vane, pressuremeter, or dilatometer tests (See [Chapter 4](#)) are recommended where soft clays are encountered.
- 9) Corrosion series tests (see [Chapter 4](#)) are required on all new bridge projects designed for less than the most aggressive conditions. The soil and the water shall be tested. If inland locations are identified to have extremely aggressive environments which do not seem to represent the field conditions, the engineer should obtain three additional samples per project to confirm an extremely aggressive test result and contact the Corrosion Section of the State Materials Office (SM-corrosionsection@dot.state.fl.us).
- 10) In the case of a water crossing, samples of streambed materials and each underlying stratum shall be obtained for determination of the median particle diameter, D₅₀, needed for scour analysis. Sample and test materials above the maximum probable depth of scour. Consult the Drainage Engineer as necessary when determining this depth.
- 11) For piers designed for large ship impact loads, pressuremeter tests are recommended to profile the material from the scour elevation to seven (7) foundation element diameters below the deepest scour elevation at the pier location.
- 12) For nonredundant drilled shafts:

The minimum number of borings required to be evenly spaced at each nonredundant drilled shaft location will be dependent on the shaft size as follows:

Maximum Shaft Diameter, feet	Minimum Borings/Shaft	Minimum Borings/Pier
For fairly uniform sites:		
<=8	1	1
9 to 10	1	2
For variable sites or karstic areas:		
<=7	1	1
8 to 10	2	2

Variable sites include those in known variable geologic areas and those determined to be variable (difficult to predict based on other borings) during the subsoil exploration program.

Contact the State Geotechnical Engineer for exploration requirements for drilled shaft diameters larger than 10 feet (if allowed).

Core the limestone load bearing strata and test core samples. Borings shall extend to not less than three shaft diameters below the proposed/final shaft tip elevation or to the depth required above in Item 3), whichever is deeper. Pilot holes shall be required as necessary during construction in cases where the original boring depth is insufficient, where shafts are lengthened or shaft locations are modified. Borings shall be located by survey and performed within one (1) foot of the shaft location. If access during the design phase limits the ability to accomplish these borings this close to the drilled shaft locations, perform a preliminary boring no farther than 60 feet from the shaft and include plan notes to require the pilot holes to be taken during construction, unless otherwise authorized by the District Geotechnical Engineer. **However, every effort shall be made to perform these borings and test the cores during the design phase in lieu of the need for pilot holes and rock core testing during construction.**

Note the size of rock core sampled in the boring log. The minimum acceptable rock core diameter is 2.4 inches for general design borings (although 4 inch diameter rock cores are preferable). Rock core samples for drilled shaft specific pilot holes should be 4 inches in diameter or larger in order to increase core recovery, RQD and increase the likelihood of obtaining a better quality core.

3.2.2.2 Approach Embankments

- 1) At least one boring shall be taken at the point of highest fill; the borings taken for the bridge abutment will usually satisfy this purpose.

If settlement or stability problems are anticipated, due to the height of the proposed embankment and/or the presence of poor foundation soils, additional borings shall be taken along the alignment. If a boring was not performed at the bridge abutment, the first of these borings shall be no more than 15 feet from the abutment. The remaining borings shall be placed at 100-foot intervals until the height of the fill is less than 5 feet. Borings shall be taken at the toe of the proposed embankment slopes as well as the embankment centerline.

- 2) Borings shall extend to a depth of twice the proposed embankment height and unsuitable founding materials have been penetrated. In the event suitable founding materials are not encountered, borings shall be continued until the superimposed stress is less than 10% of the original overburden pressure (see [Figure 4](#)).
- 3) Sampling and in-situ testing criteria are in accordance with ASTM D-1586.

3.2.2.3 Retaining Walls

- 1) At all permanent and critical temporary retaining wall locations borings shall be taken at a maximum interval of one per 150 feet of the wall, as close to the wall alignment as possible. Borings shall be extended below the bottom of the wall a minimum of twice the wall height or at least 10 feet into competent material. This applies to all earth retaining structures, proprietary systems as well as precast and cast-in-place. For sheet pile walls, borings shall be extended below the lower adjacent ground surface to a minimum of twice the wall height or at least 10 feet into competent rock.
- 2) Sampling and in-situ testing criteria are in accordance with ASTM D-1586.

3.2.2.4 Noise Walls

- 1) Noise Wall Borings shall be taken at a maximum interval of one per 500 feet of the wall, as close to the wall alignment as possible. Extend borings below the bottom of the wall to a depth of twice the wall height or 30 feet whichever is less. Increase the boring frequency in variable locations and areas of suspected weak soils such as wetlands, filled wetlands, etc.
- 2) Sampling and in-situ testing criteria are in accordance with ASTM D-1586.

3.2.2.5 Buildings

In general, perform one boring at each corner and one in the center. This may be reduced for small buildings. For extremely large buildings or variable site conditions, one boring should be taken at each support location. Other criteria are the same as for bridges.

3.2.2.6 Drainage Structures

- 1) Borings shall be taken at proposed locations of box culverts. Trenches or hand auger borings may suffice for smaller structures.
- 2) For box culverts, borings shall extend a minimum of 15 feet below the bottom of the culvert or until firm material is encountered, whichever is deeper.
- 3) For smaller structures, borings or trenches shall extend at least 5 feet below the bottom of the structure or until firm material is encountered, whichever is deeper.
- 4) Corrosion testing must be performed for each site unless the structure is designed for the most aggressive conditions. When testing is performed, material from each stratum above the invert elevation and any standing water shall be tested. For drainage systems parallel to roadway alignments, tests shall be performed at 1,500-foot (or smaller) intervals along the alignment.

3.2.2.7 High Mast Lighting, and Overhead Sign Structures

- 1) One boring shall be taken at each designated location; ensure each shaft is within 20 feet of a boring.
- 2) Borings shall be 40 feet into suitable soil or 10 feet into competent rock with 15 feet minimum total depth. Deeper borings may be required for cases with higher than normal torsional loads.
- 3) Sampling and in-situ testing criteria are in accordance with ASTM D-1586.
- 4) Corrosion testing may be omitted and the structure designed for the most aggressive conditions unless otherwise required by the District Geotechnical Engineer.

Modification for Non-Conventional Projects:

Delete 4) and insert the following:

Corrosion testing must be performed for each foundation unless the structure is designed for the most aggressive conditions.

3.2.2.8 Mast Arms Assemblies, Microwave Vehicle Detection Systems (MVDS) Poles and Strain Poles

- 1) One boring to 25 feet into suitable soil or 10 feet into competent rock with 15 feet minimum total depth (Auger, SPT or CPT) shall be taken in the area of each designated location (for uniform sites one boring can cover more than one foundation location).
- 2) For Standard Mast Arm Assemblies, verify that the soil strength properties at the foundation locations meet or exceed the soil strength properties assumed for the Standard Mast Arm Assemblies in the Standard Indices. A site-specific design must be performed for those sites having weaker strength properties.
- 3) For mast arm assemblies not covered in the standards an analysis and design must be performed.
- 4) Corrosion testing may be omitted and the structure designed for the most aggressive conditions unless otherwise required by the District Geotechnical Engineer.

Modification for Non-Conventional Projects:

Delete 4) and insert the following:

Corrosion testing must be performed for each foundation unless the structure is designed for the most aggressive conditions.

3.2.2.9 CCTV Poles

- 1) One boring shall be taken at each designated location; ensure each shaft is within 20 feet of a boring.
- 2) Borings shall be 20 feet into suitable soil or 10 feet into competent rock with 15 feet minimum total depth. Deeper borings may be required for cases with higher than normal loads.
- 3) Sampling and in-situ testing criteria are in accordance with ASTM D-1586.
- 4) Corrosion testing may be omitted and the structure designed for the most aggressive conditions unless otherwise required by the District Geotechnical Engineer.

Modification for Non-Conventional Projects:
Delete 4) and insert the following: Corrosion testing must be performed for each foundation unless the structure is designed for the most aggressive conditions.

3.2.2.10 Cable Barriers

- 1) One boring to 35 feet into suitable soil or 15 feet into competent rock (Auger, SPT or CPT) shall be taken in the area of each designated location for cable barrier end anchorages.
- 2) For Standard Cable Barrier End Anchorages, verify that the soil strength properties at the foundation locations meet or exceed the soil strength properties assumed in Developmental Specification 540. A site-specific design must be performed for those sites having weaker strength properties.
- 3) In addition to the soil borings at the end anchorages, a geotechnical assessment of the soils along the cable barrier alignment between the anchor locations shall occur. This may be done using any of the normal preliminary investigation methods (topographic maps, aerial photos, geological maps and reports, etc.) as well as original roadway plans. As a minimum, a visual assessment in the field is required. Investigate areas that appear to be wetlands, have high organic content or that are saturated for extended periods by taking site specific borings.
- 4) Corrosion testing may be omitted and the structure designed for the most aggressive conditions unless otherwise required by the District Geotechnical Engineer.

Modification for Non-Conventional Projects:

Delete 4) and insert the following:

Corrosion testing must be performed for each foundation unless the structure is designed for the most aggressive conditions.

3.2.2.11 Tunnels

Due to the greatly varying conditions under which tunnels are constructed, investigation criteria for tunnels shall be established by the District Geotechnical Engineer for each project on an individual basis.

Modification for Non-Conventional Projects:

Delete this paragraph and see the RFP for requirements.

3.2.2.12 Other Structures

Contact the District Geotechnical Engineer for instructions concerning other structures not covered in this section.

Modification for Non-Conventional Projects:

Delete this paragraph and see the RFP for requirements.

3.2.3 Borrow Areas

Test pits, trenches, and various types of borings can be used for exploration of potential borrow areas. Samples should be obtained to permit classification, moisture, compaction, permeability test, LBR, M_R and/or corrosion testing of each material type, as applicable. The extent of the exploration will depend on the size of the borrow area and the amount and type of borrow needed.

3.2.4 Open Retention Ponds

Two auger borings (SPT borings with continuous sampling may be substituted) shall be taken per 40,000 feet² of pond, with a minimum depth of 5 feet below the deepest elevation of the pond, or until a confining layer is encountered or local Water Management District criteria are satisfied. A minimum of two field permeability tests per pond shall be performed, with this number increasing for larger ponds.

Sufficient testing must be accomplished to verify whether the excavated material can be used for embankment fill. If rock is to be excavated from the pond, sufficient SPT borings must be accomplished to estimate the volume and hardness of the rock to be removed.

3.2.5 Closed Retention Ponds

One auger boring (SPT borings with continuous sampling may be substituted) shall be taken per 40,000 feet² of pond, with a minimum depth of five feet below the deepest elevation of the pond, and one SPT boring per 40,000 feet² of pond, with a minimum depth of two times the proposed water height or until local Water Management District criteria are satisfied. A minimum of two field permeability tests per pond shall be performed, with this number increasing for larger ponds.

Sufficient testing must be accomplished to verify whether the excavated material can be used for embankment fill. If rock is to be excavated from the pond, sufficient SPT borings must be accomplished to estimate the volume and hardness of the rock to be removed.

3.2.6 Exfiltration Trenches/French Drains

One auger boring (SPT borings with continuous sampling may be substituted) shall be taken per 1,000 feet of continuous exfiltration trench, with a minimum depth of 20 feet. A minimum of one open hole percolation test per 1,000 feet of continuous exfiltration trench shall be performed.

If rock is to be excavated or expected to be encountered, sufficient SPT borings must be accomplished to estimate the depth, volume and hardness of the rock to be encountered.

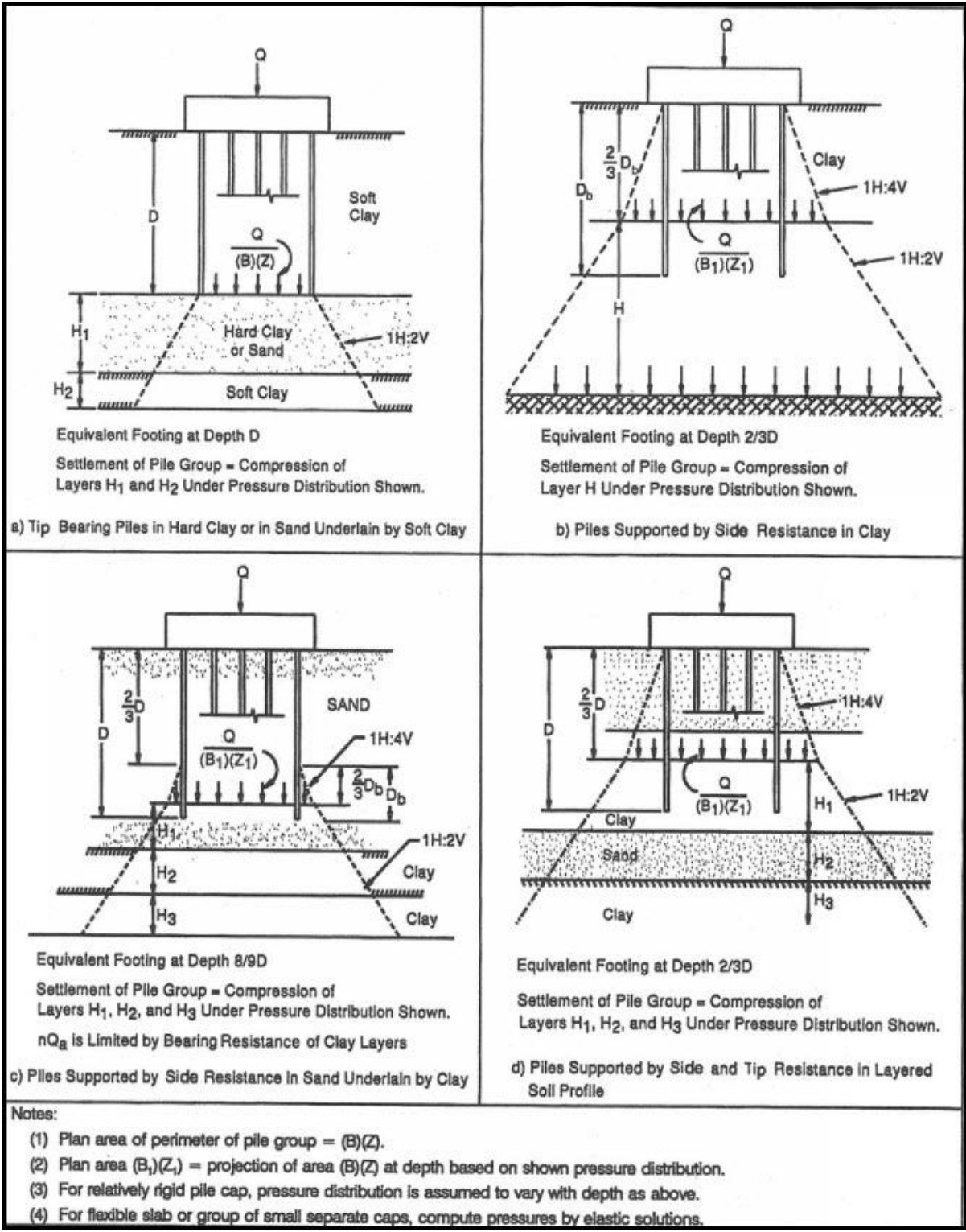

Figure 3, Stress Distribution Below Equivalent Footing For Pile Group (AASHTO 2020)

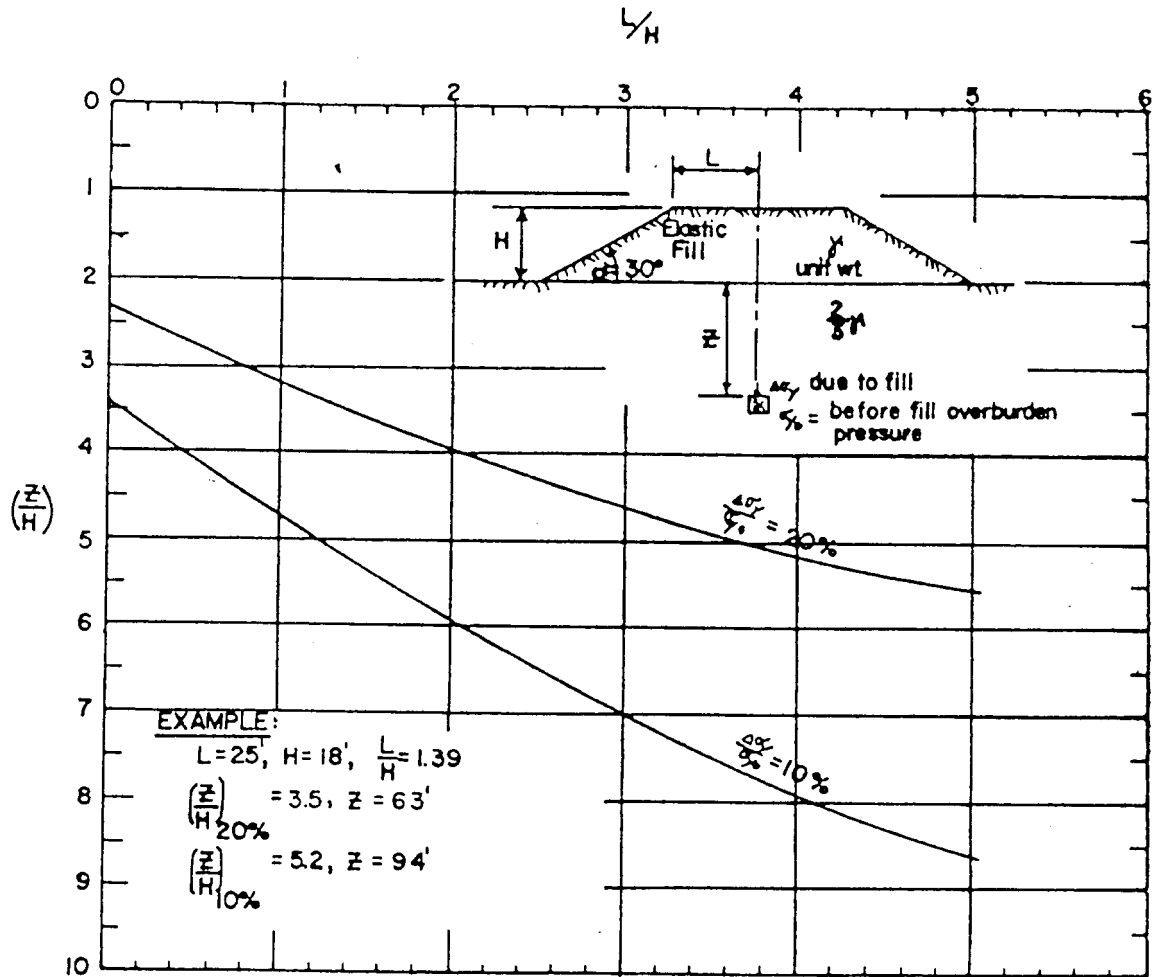

Figure 4, Chart for Determining the Maximum Depth of Significant Increase in Vertical Stress in the Foundation Soils Resulting from an Infinitely Long Trapezoidal Fill (both fill and foundation assumed homogeneous, isotropic and elastic). (After Schmertmann, 1967)

3.3 References

1. Cheney, Richard S. & Chassie, Ronald G., Soils and Foundations Workshop Manual – Second Edition, FHWA HI-88-009, 1993.
2. NAVFAC DM-7.1 Soils Mechanics, Department of the Navy, Naval Facilities Engineering Command, 1986.
3. “Checklist and Guidelines for Review of Geotechnical Reports and Preliminary Plans and Specifications,” Federal Highway Administration, 1985. Revised 2003.
4. Schmertmann, J.H., Guidelines For Use In The Soils Investigation and Design of Foundations For Bridge Structures In The State Of Florida, Research Report 121-A, Florida Department of Transportation, 1967.
5. Munfakh, George, Arman, Ara, Samtani, Naresh, and Castelli, Raymond, Subsurface Investigations, FHWA-HI-97-021, 1997.
6. Recommended Guidelines for Sealing Geotechnical Exploratory Holes, National Cooperative Highway Research Program, NCHRP Report 378.
7. Rigid Pavement Design Manual, FDOT, (Current version).
8. [General Tolling Requirements \(GTR\) Volume 1, FDOT, \(Current Version\)](#)

3.4 Specifications and Standards

<u>Subject</u>	<u>ASTM</u>	<u>AASHTO</u>	<u>FM</u>
Standard Test Method for Penetration Test and Split-Barrel Sampling of Soils	D 1586	T 206	-

Chapter 4

4 In-situ Testing

The testing described in this chapter provides the Geotechnical Engineer with soil and rock parameters determined in-situ. This is important on all projects, especially those involving soft clays, loose sands and/or sands below the water table, due to the difficulty of obtaining representative samples suitable for laboratory testing. For each test included, a brief description of the equipment, the test method, and the use of the data is presented.

4.1 Standard Penetration Test (SPT)

This test is probably the most widely used field test in the United States. It has the advantages of simplicity, the availability of a wide variety of correlations for its data, and the fact that a sample is obtainable with each test. A standard split barrel sampler is advanced into the soil by dropping a 140-pound safety or automatic hammer on the drill rod from a height of 30 inches. (Note: Use of a donut hammer is not permitted). The sampler is advanced a total of 18 inches. The number of blows required to advance the sampler for each of three 6-inch increments is recorded. The sum of the number of blows for the second and third increments is called the Standard Penetration Value, or more commonly, N-value (blows per foot). Perform all Standard Penetration Tests in accordance with ASTM D 1586 (AASHTO T 206).

Note the type of hammer (safety or automatic) on the boring logs, since this will affect the actual input driving energy. Only one type of hammer may be used in each SPT boring. **Because of the substantial increase in consistency, automatic SPT hammers are required for all SPT borings performed using truck and all-terrain vehicle mounted drilling equipment;** safety hammers will be permitted only for borings requiring specialty and/or unique drilling equipment that cannot support an automatic hammer (i.e., small amphibious rigs, tripod, small barge, etc.) Use of safety hammers requires the approval of the District Geotechnical Engineer.

When Standard Penetration Tests (SPT) are performed in soil layers containing shell or similar materials, the sampler may become plugged. A plugged sampler will cause the SPT N-value to be much larger than for an unplugged sampler and, therefore, not a representative index of the soil layer properties. In this circumstance, a realistic design requires reducing the N-value used for design to the trend of the N-values which do not appear distorted. (See [Figure 5](#) and [Reference 3](#)) However, the actual N-values should be presented on the Report of Core Borings Sheet.

During design, the N-values may need to be corrected for overburden pressure. A great many correlations exist relating the corrected N-values to relative density, angle of internal friction, shear strength, and other parameters. Design methods are available for using N-values in the design of driven piles, embankments, spread footings and drilled shafts. However, when using FB-Deep or GeoStat, the N-values should not be corrected since the design methodology is based on uncorrected N-values.

The SPT values should not be used indiscriminately. They are sensitive to the fluctuations in individual drilling practices and equipment. Studies have also indicated that the results are more reliable in sands than clays. Although extensive use of this test in subsurface exploration is recommended, it should always be augmented by other field and laboratory tests, particularly when dealing with clays.

A method to measure the energy during the SPT has been developed (ASTM D 4633). Since there is a wide variability of performance in SPT hammers, this method is useful to evaluate an individual hammer's performance. The SPT installation procedure is similar to pile driving because it is governed by stress wave propagation. As a result, if force and velocity measurements are obtained during a test, the energy transmitted can be determined.

The FDOT sponsored a study in which 224 energy measurements were taken during SPT tests using safety hammers and compared to 113 energy measurements taken during SPT tests using automatic hammers. Each drill rig was evaluated using multiple drill crews, multiple sampling depths and multiple types of drill rods. The study concluded that the efficiency for automatic SPT hammers on average was 79.8%; whereas, most safety hammers averaged 64.5%. Because most design correlations and FDOT design programs are based on safety hammer N-values, N-values obtained during SPT tests performed using an automatic hammer shall be converted for design to an equivalent safety hammer N-value efficiency by the following relationship:

$$N_{ES} = \xi * N_{AUTO}$$

where:

N_{AUTO} = The Automatic Hammer N-value

ξ = The Equivalent Safety Hammer Conversion Factor, and

N_{ES} = The Equivalent Safety Hammer N-value

Based on the results of the Department's study a value of 1.24 shall be used for ξ in the above relationship. No other multiplier shall be used to convert automatic hammer N-values to equivalent safety hammer N-values without written concurrence from the State Geotechnical Engineer. Consultants desiring to use their own rig specific conversion factor must perform annual calibrations in accordance with ASTM D 4633.

Design calculations using SPT-N value correlations should be performed using N_{ES} , however, only the actual field SPT-N values should be plotted on the soil profiles depicting the results of SPT borings.

4.2 Cone Penetrometer Test (CPT)

The Cone Penetrometer Test is a quasi-static penetration test in which a cylindrical rod with a conical point is advanced through the soil at a constant rate and the resistance to penetration is measured. A series of tests performed at varying depths at one location is commonly called a sounding.

Several types of penetrometer are in use, including electric cone, electric friction-cone, piezocone, and hand cone penetrometers. Cone penetrometers measure the resistance to penetration at the tip of the penetrometer, or the end-bearing

component of resistance. Friction-cone penetrometers are equipped with a friction sleeve, which provides the added capability of measuring the side friction component of resistance. Mechanical penetrometers have telescoping tips allowing measurements to be taken incrementally, generally at intervals of 8 inches or less. Electronic penetrometers use electronic force transducers to obtain continuous measurements with depth. Piezocone penetrometers are electronic penetrometers, which are also capable of measuring pore water pressures during penetration. Hand cone penetrometers are similar to mechanical cone penetrometers, except they are usually limited to determining cone tip resistance. Hand cone penetrometers are normally used to determine the strength of soils at shallow depth, and they are very useful for evaluating the strength of soils explored by hand auger methods.

For all types of penetrometers, cone dimensions of a 60-degree tip angle and a 10 cm^2 (1.55 in^2) projected end area are standard. Friction sleeve outside diameter is the same as the base of the cone. Penetration rates should be between 0.4 and 0.8 in/sec. Tests shall be performed in accordance with ASTM D 5778 (electronic friction cones and piezocones).

The penetrometer data is plotted showing the end-bearing resistance, the friction resistance and the friction ratio (friction resistance divided by end bearing resistance) vs. depth. Pore pressures, if measured, can also be plotted with depth. The results should also be presented in tabular form indicating the interpreted results of the raw data. See [Figure 6](#), [Figure 7](#), and [Figure 8](#) (Note: the log for a standard cone penetration test would only include the first three plots: tip resistance, local friction, and friction ratio; shown in [Figure 33](#)).

The friction ratio plot can be analyzed to determine soil type. Many correlations of the cone test results to other soil parameters have been made, and design methods are available for spread footings and piles. The penetrometer can be used in sands or clays, but not in rock or other extremely strong soils. Generally, soil samples are not obtained with soundings, so penetrometer exploration should always be augmented by SPT borings or other borings with soil samples taken.

The piezocone penetrometer can also be used to measure the dissipation rate of the excessive pore water pressure. This type of test is useful for subsoils, such as fibrous peat or muck that are very sensitive to sampling techniques. The cone should be equipped with a pressure transducer that is capable of measuring the induced water pressure. To perform this test, the cone will be advanced into the subsoil at a standard rate of 0.8 inch/sec. Pore water pressures will be measured immediately and at several time intervals thereafter. Use the recorded data to plot a pore pressure versus log-time graph. Using this graph one can directly calculate the pore water pressure dissipation rate or rate of settlement of the soil.

4.3 Dynamic Cone Penetrometer Test

This test is similar to the cone penetrometer test except, instead of being pushed at a constant rate, the cone is driven into the soil. The number of blows required to advance the cone in 6-inch increments is recorded. A single test generally consists of two increments. Tests can be performed continuously to the depth desired with an expendable cone, which is left in the ground upon drill rod withdrawal, or

they can be performed at specified intervals by using a retractable cone and advancing the hole by auger or other means between tests. Samples are not obtained.

Blow counts can generally be used to identify material type and relative density. In granular soils, blow counts from the second 6-inch increment tend to be larger than for the first increment. In cohesive soils, the blow counts from the two increments tend to be about the same. While correlations between blow counts and engineering properties of the soil exist, they are not as widely accepted as those for the SPT. Shallow tests should be performed in accordance with ASTM D 6951. For deeper tests, the equipment, testing procedure and interpretation of the results should be based upon the manufacturer's recommendations.

4.4 Dilatometer Test (DMT)

The dilatometer is a 3.75-inch wide and 0.55-inch thick stainless steel blade with a thin 2.4-inch diameter expandable metal membrane on one side. While the membrane is flush with the blade surface, the blade is either pushed or driven into the soil using a penetrometer or drilling rig. Rods carry pneumatic and electrical lines from the membrane to the surface. At depth intervals of 8 inch, the pressurized gas expands the membrane and both the pressure required to begin membrane movement and that required to expand the membrane into the soil 0.04 inches are measured. Additionally, upon venting the pressure corresponding to the return of the membrane to its original position may be recorded (see [Figure 9](#), [Figure 10](#), and [Figure 11](#)). Refer to References 5, 6, and 7.

Through developed correlations, information can be deduced concerning material type, pore water pressure, in-situ horizontal and vertical stresses, void ratio or relative density, modulus, shear strength parameters, and consolidation parameters. Compared to the pressuremeter, the flat dilatometer has the advantage of reduced soil disturbance during penetration. Tests shall be performed in accordance with ASTM D 6635.

4.5 Pressuremeter Test (PMT)

This test is performed with a cylindrical probe placed at the desired depth in a borehole. The Menard type pressuremeter requires pre-drilling of the borehole; the self-boring type pressuremeter advances the hole itself, thus reducing soil disturbance. The PENCEL pressuremeter can be set in place by pressing it to the test depth or by direct driving from ground surface or from within a predrilled borehole. The hollow center PENCEL probe can be used in series with the static cone penetrometer. The Menard probe contains three flexible rubber membranes (see [Figure 12](#)). The middle membrane provides measurements, while the outer two are "guard cells" to reduce the influence of end effects on the measurements. When in place, the guard cell membranes are inflated by pressurized gas while the middle membrane is inflated with water by means of pressurized gas. The pressure in all the cells is incremented and decremented by the same amount. The measured volume change of the middle membrane is plotted against applied pressure. Tests shall be performed in accordance with ASTM D 4719.

Studies have shown that the "guard cells" can be eliminated without sacrificing the accuracy of the test data provided the probe is sufficiently long.

Furthermore, pumped air can be substituted for the pressurized gas used to inflate the membrane with water. The TEXAM[®] pressuremeter is an example of this type.

Results are interpreted based on semi-empirical correlations from past tests and observation. In-situ horizontal stresses, shear strength, bearing capacities, and settlement can be estimated using these correlations. The pressuremeter test results can be used to obtain load transfer curves (p-y curves) for lateral load analyses. The pressuremeter test is very sensitive to borehole disturbance and the data may be difficult to interpret for some soils.

4.6 Field Vane Test

This test consists of advancing a four-bladed vane into cohesive soil to the desired depth and applying a measured torque at a constant rate until the soil fails in shear along a cylindrical surface. (See [Figure 13](#)) The torque measured at failure provides the undrained shear strength of the soil. A second test run immediately after remolding at the same depth provides the remolded strength of the soil and thus information on soil sensitivity. Tests shall be performed in accordance with ASTM D-2573 (AASHTO T 223).

This method is commonly used for measuring shear strength in soft clays and organic deposits. It should not be used in stiff and hard clays. Results can be affected by the presence of gravel, shells, roots, or sand layers. Shear strength may be overestimated in highly plastic clays and a correction factor should be applied.

4.7 Percolation Test

The percolation test is used to ascertain the vertical percolation rate of unsaturated soil, i.e., the rate at which the water moves through near surface soils. The most common tests consist of digging a 4 to 12 inch diameter hole to the stratum for which information is required, cleaning and backfilling the bottom with coarse sand or gravel, filling the hole with water and providing a soaking period of sufficient length to achieve saturation. During the soaking period, water is added as necessary to prevent loss of all water. The percolation rate is then obtained by filling the hole to a prescribed water level and measuring the drop in water level over a set time. The times required for soaking and for measuring the percolation rate vary with the soil type; local practice should be consulted for specific requirements. See also References 8 and 9.

Results of this test are generally used in evaluating site suitability for septic system drainage fields.

4.8 Infiltration Test

The infiltration rate of a soil is the maximum rate at which water can enter the soil from the surface under specified conditions. The most common test in Florida uses a double-ring infiltrometer. Two open cylinders, approximately 20 inch high and 12 to 24 inch in diameter, are driven concentrically into the ground. The outer ring is driven to a depth of about 6 inch, the inner ring to a depth of 2 to 4 inch. Both are partially filled with water. As the water infiltrates into the soil, measured volumes are added to keep the water levels constant. The volumes of water added to the inner ring and to the annular space during a specific time interval, equivalent to the

amounts, which have infiltrated the soil. These are converted into infiltration rates, expressed in units of length per unit time, usually inches per hour. The infiltration rate is taken as the maximum steady state infiltration velocity occurring over a period of several hours. In the case of differing velocities for the inner ring and the annular space, the maximum velocity from the inner ring should be used. The time required to run the test is dependent upon soil type. Tests shall be performed in accordance with ASTM D 3385.

Drainage engineers in evaluating runoff, ditch or swale infiltration use information from this test.

4.9 Permeability Test

Field permeability tests measure the coefficient of permeability (hydraulic conductivity) of in-place materials. The coefficient of permeability is the factor of proportionality relating the rate of fluid discharge per unit of cross-sectional area to the hydraulic gradient (the pressure or “head” inducing flow, divided by the length of the flow path). This relation is usually expressed as:

$$Q/A = \frac{HK}{L}$$

Where Q is discharge rate (volume/time); A is cross-sectional area, H/L is the hydraulic gradient (dimensionless); and K is the coefficient of permeability, expressed in length per unit time (cm/sec, ft/day, etc.). The area and length factors are often combined in a “shape factor” or “conductivity coefficient” (See Reference 2). Permeability is the most variable of all the materials properties commonly used in geotechnical analysis. A permeability spread of ten or more orders of magnitude has been reported for a number of different types of tests and materials. Measurement of permeability is highly sensitive to both natural and test conditions. The difficulties inherent in field permeability testing require that great care be taken to minimize sources of error and to correctly interpret, and compensate for, deviations from ideal test conditions.

Factors Affecting Tests: The following five physical characteristics influence the performance and applicability of permeability tests:

- (1) position of the water level,
- (2) type of material – rock or soil,
- (3) depth of the test zone,
- (4) permeability of the test zone, and
- (5) heterogeneity and anisotropy of the test zone.

To account for these factors, it is necessary to isolate the test zone. Methods for doing so are shown in References 2 & 17.

Many types of field permeability tests can be performed. In geotechnical exploration, equilibrium tests are the most common. These include constant and variable head gravity tests and pressure (Packer) tests conducted in single borings. In a few geotechnical investigations, and commonly in water resource or environmental studies, non-equilibrium “aquifer” or “pump” tests are conducted (a well is pumped at a constant rate for an extended period of time). Typical ranges of permeability

coefficients and suggested test methods from Reference 18 are presented in [Figure 14](#). Formulas for computing permeability coefficients from constant and variable head tests are included in [Figure 15](#). For in-situ variable head tests, see References 17 and 2. Perform laboratory tests according to ASTM D 5856. Perform constant head and falling head borehole permeability tests in accordance with ASTM D 6391.

4.9.1 Constant Head Test

The most commonly used permeability test is the constant head test. However, it may be difficult to perform in materials of either very high or very low permeability since the flow of water may be difficult to maintain or to measure.

4.9.2 Rising Head Test

In a saturated zone with sufficiently permeable materials the rising head test is more accurate than a constant or a falling head test. Plugging of the pores by fines or by air bubbles is less apt to occur in a rising head test. In an unsaturated zone, the rising head test is inapplicable.

4.9.3 Falling Head Test

In zones where the flow rates are very high or very low, the falling head test may be easier to perform than a constant head test. In an area of unknown permeability the constant head and rising head tests should be attempted before a falling head test.

4.9.4 Pumping Test

In large scale seepage investigations or groundwater resource studies, the expense of aquifer or pumping tests may be justified as they provide more accurate and useful data than any other type of test. Pump tests require a test well, pumping equipment, and lengthy test times. Observation wells are necessary. A vast number of interpretive techniques have been published for special conditions.

Permeability calculations are made based on the rate of pumping, the measured draw down, and the configuration of the test hole and observation wells. Refer to ASTM D 4050 and Reference 17.

4.9.5 Vertical Insitu Permeameter (VIP) Test

The FDOT sponsored a study to develop a field permeability test method using a probe as an alternative to conventional borehole testing methods. The conical probe that was developed can be pushed into the soil using a standard drill rig. It has a vertical injection port to control the outflow of water into the surrounding soil. The result is a mean coefficient of permeability at the depth to which the probe was advanced, and multiple depths can be tested from a single sounding. Tests shall be performed in accordance with FM 5-614.

4.10 Environmental Corrosion Tests

These tests are carried out on soil and water at structure locations, on structural backfill materials and on subsurface materials along drainage alignments to determine the corrosion classification to be considered during design. For structures, materials are classified as slightly, moderately, or extremely aggressive, depending on their pH,

resistivity, chloride content, and sulfate content. (Refer to the latest Structures Design Guidelines, for the criteria, which defines each class). For roadway drainage systems, test results for each stratum are presented for use in determining alternate culvert materials. Testing shall be performed in the field and/or the laboratory according to the standard procedures listed below. Once the project's corrosion test results have been reviewed by the District Geotechnical Office, compile the sample data and results into the "Corrosion Series Test Results_SMO.xlsx" Excel form on the [Geotechnical Engineering webpage](#), and email the completed form to SM-corrosionsection@dot.state.fl.us.

4.10.1 pH of Soils

- a) FM 5-550

4.10.2 pH of Water

- a) FM 5-550

4.10.3 Chloride Ion in Water

- a) FM 5-552

4.10.4 Chloride Ion in Soil

- a) FM 5-552

4.10.5 Sulfate Ion in Brackish Water

- a) FM 5-553

4.10.6 Sulfates in Soil

- a) FM 5-553

4.10.7 Electrical Resistance of Water

- a) FM 5-551

4.10.8 Electrical Resistance of Soil

- a) FM 5-551

4.11 Grout Plug Pull-out Test

This test is performed when the design of drilled shafts in rock is anticipated. However, the values obtained from this test should be used carefully.

A 4-inch diameter (minimum) by 30-inch long core hole is made to the desired depth in rock. A high strength steel bar with a bottom plate and a reinforcing cage over the length to be grouted is lowered to the bottom of the hole. Sufficient grout is poured into the hole to form a grout plug approximately 2 feet long. After curing, a center hole jack is used to incrementally apply a tension load to the plug with the intent of inducing a shear failure at the grout - limestone interface. The plug is extracted, the failure surface examined, and the actual plug dimensions measured.

The ultimate shear strength of the grout-limestone interface is determined by dividing the failure load by the plug perimeter area. This value can be used to estimate the skin friction of the rock-socketed portion of the drilled shaft.

Example SPT-N Adjustments Due to Plugged Sampler

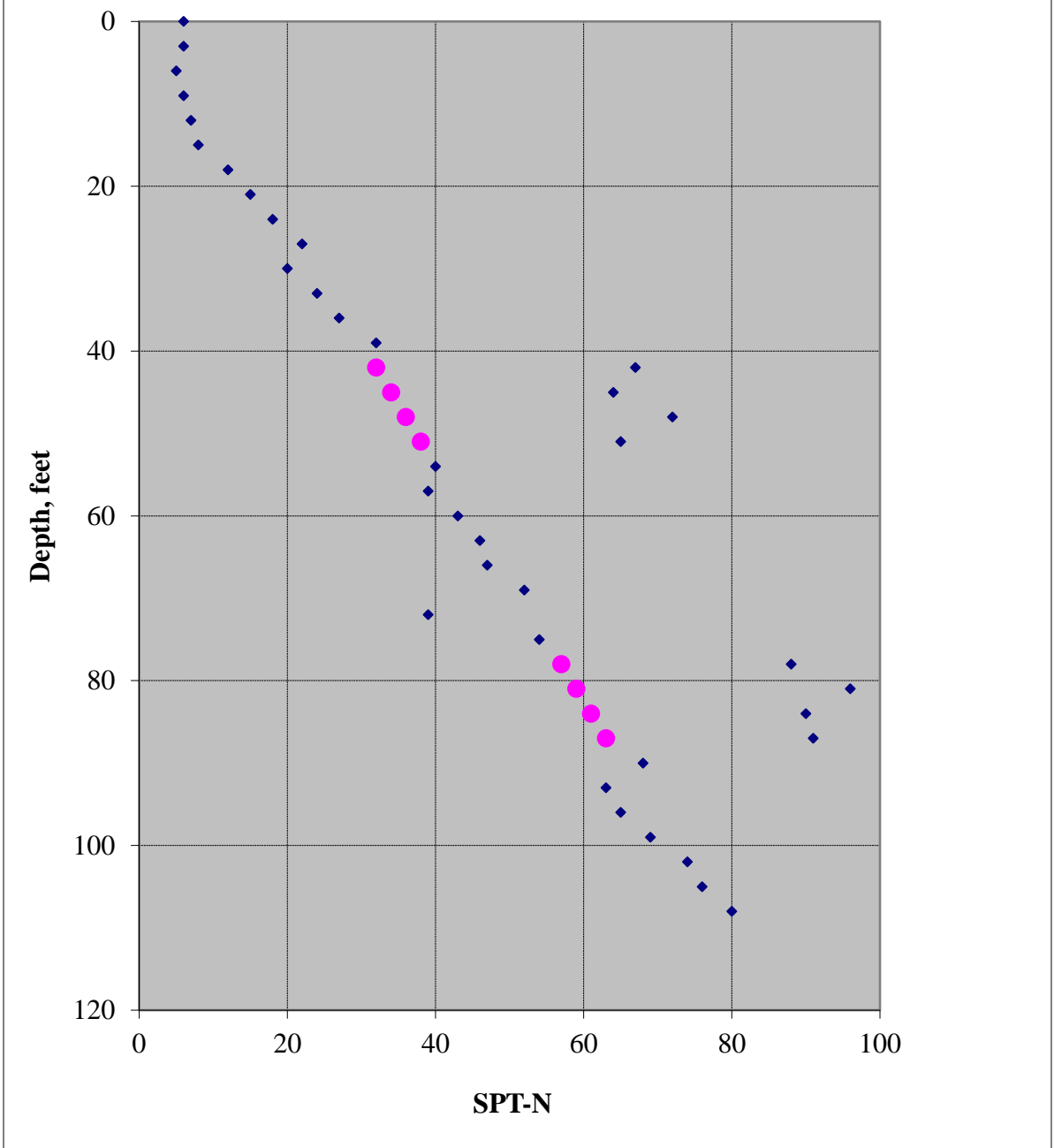

Figure 5, Example SPT-N Adjustments Due to Plugged Sampler

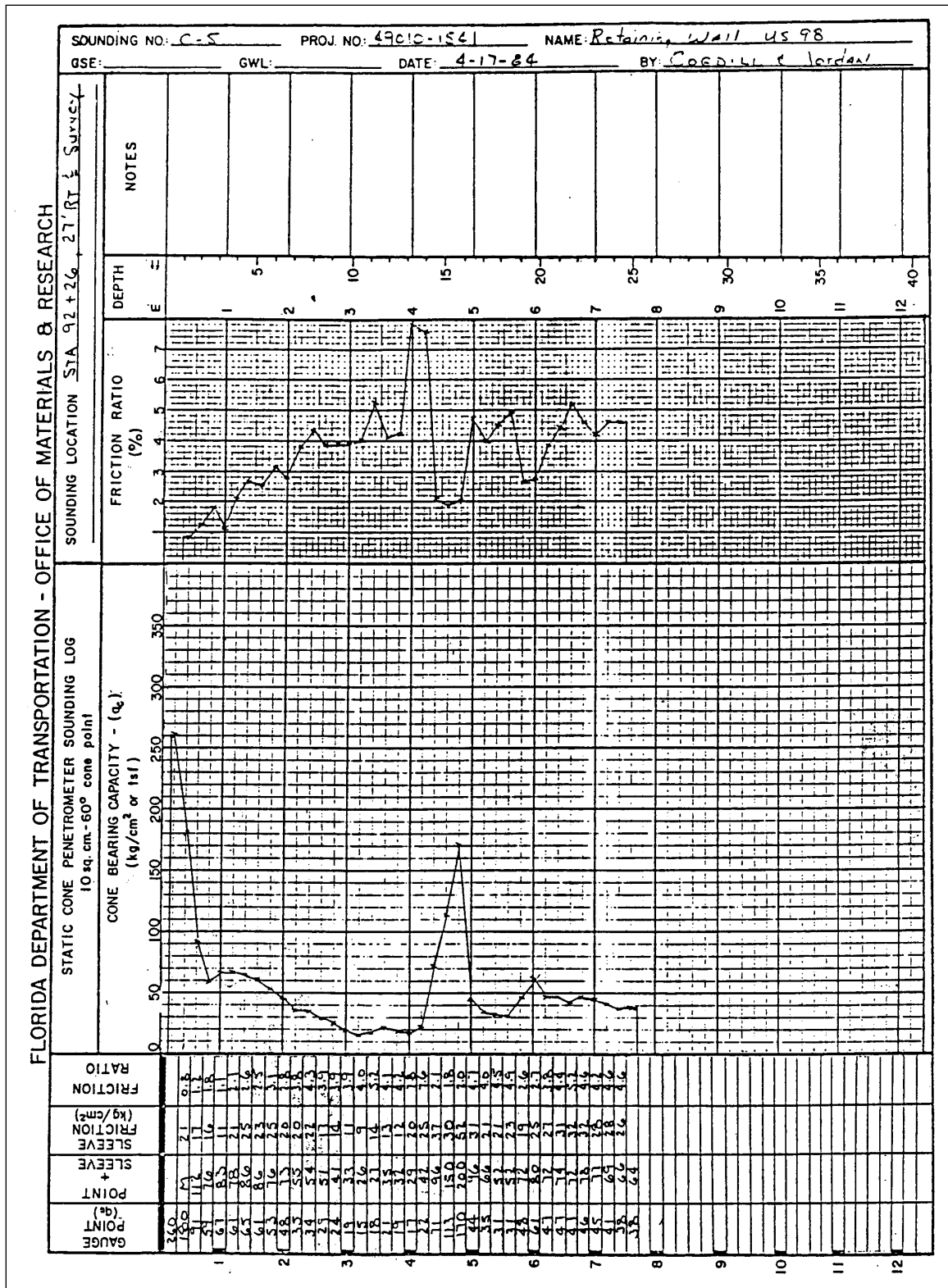

Figure 6, Typical Log from Mechanical Friction-Cone

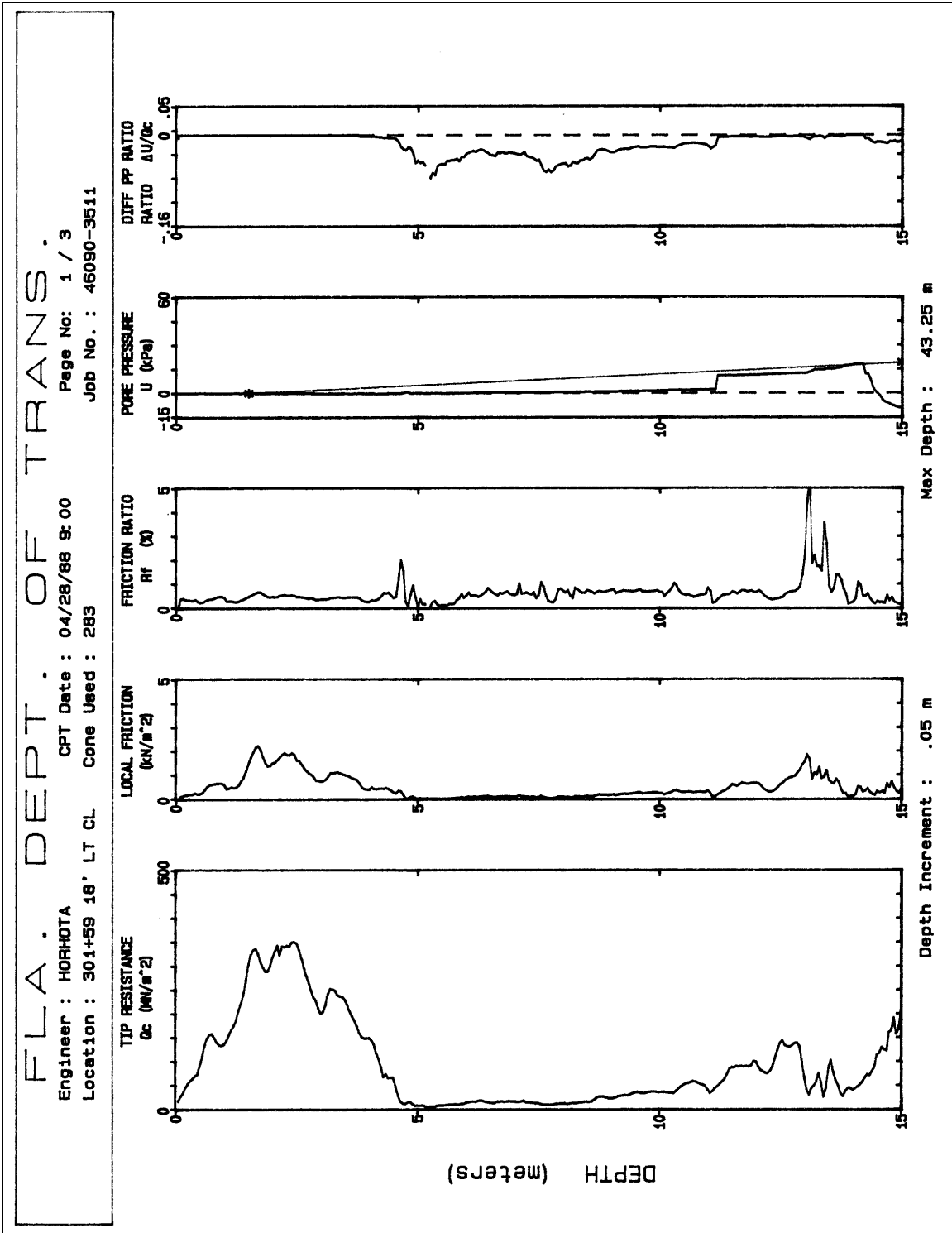

Figure 7, Typical Log from Electric Piezocone

FLORIDA D.O.T MATERIALS OFFICE

CPT DATE :04/28/88 9:00
 LOCATION :301+59 6 m LT CL
 Job No. :46090-3511
 Tot. Unit Wt. (avg) : 510 N/m³

ENGINEER :BLANTON
 Cone Used :283
 Water table (meters) : 1.5

DEPTH (meters)	Qc (avg) (MN/m ²)	Fs (avg) (kN/m ²)	Rf (avg) (%)	SIGV' (MPa)	SOIL BEHAVIOUR TYPE	Eq - Dr (%)	PHI deg.	SPT N	Su (MPa)
0.50	53.24	0.16	0.31	0.04	sand to silty sand	>90	>48	13	UNDEFINED
1.00	139.74	0.56	0.40	0.13	sand	>90	>48	27	UNDEFINED
1.50	205.64	0.71	0.35	0.22	sand	>90	>48	39	UNDEFINED
2.00	312.59	1.77	0.57	0.28	gravelly sand to sand	>90	>48	50	UNDEFINED
2.50	341.26	1.77	0.52	0.31	gravelly sand to sand	>90	>48	>50	UNDEFINED
3.00	262.08	1.08	0.41	0.35	gravelly sand to sand	>90	>48	42	UNDEFINED
3.50	236.04	1.00	0.42	0.38	sand	>90	>48	45	UNDEFINED
4.00	173.89	0.67	0.39	0.42	sand	>90	46-48	33	UNDEFINED
4.50	92.91	0.41	0.44	0.45	sand to silty sand	70-80	44-46	22	UNDEFINED
5.00	17.01	0.13	0.79	0.49	sandy silt to clayey silt	UNDFND	UNDFD	7	1.07
5.50	6.64	0.01	0.21	0.52	sensitive fine grained	UNDFND	UNDFD	3	.38
6.00	10.38	0.03	0.32	0.55	sandy silt to clayey silt	UNDFND	UNDFD	4	.62
6.50	16.33	0.10	0.60	0.59	sandy silt to clayey silt	UNDFND	UNDFD	6	1.01
7.00	15.86	0.10	0.61	0.62	sandy silt to clayey silt	UNDFND	UNDFD	6	.97
7.50	14.86	0.09	0.63	0.66	sandy silt to clayey silt	UNDFND	UNDFD	6	.90
8.00	10.37	0.06	0.61	0.69	sandy silt to clayey silt	UNDFND	UNDFD	4	.60
8.50	13.54	0.09	0.67	0.73	sandy silt to clayey silt	UNDFND	UNDFD	5	.80
9.00	22.86	0.16	0.70	0.76	silty sand to sandy silt	<40	34-36	7	UNDEFINED
9.50	29.15	0.21	0.71	0.80	silty sand to sandy silt	<40	36-38	9	UNDEFINED
10.00	35.88	0.26	0.72	0.83	silty sand to sandy silt	<40	36-38	11	UNDEFINED
10.50	39.31	0.28	0.71	0.87	silty sand to sandy silt	40-50	36-38	13	UNDEFINED
11.00	53.59	0.30	0.56	0.90	sand to silty sand	50-60	38-40	13	UNDEFINED
11.50	58.47	0.30	0.52	0.94	sand to silty sand	50-60	38-40	14	UNDEFINED
12.00	92.18	0.64	0.69	0.97	sand to silty sand	60-70	40-42	22	UNDEFINED
12.50	94.25	0.44	0.47	1.01	sand to silty sand	60-70	40-42	23	UNDEFINED
13.00	125.46	1.04	0.83	1.04	sand to silty sand	70-80	40-42	30	UNDEFINED
13.50	50.89	1.15	2.26	1.08	sandy silt to clayey silt	UNDFND	UNDFD	19	3.24
14.00	51.81	0.39	0.76	1.11	silty sand to sandy silt	40-50	36-38	17	UNDEFINED
14.50	68.95	0.32	0.46	1.15	sand to silty sand	50-60	38-40	17	UNDEFINED
15.00	154.16	0.41	0.27	1.18	sand	70-80	42-44	30	UNDEFINED
15.50	214.47	0.46	0.22	1.22	gravelly sand to sand	80-90	42-44	34	UNDEFINED
16.00	239.03	0.43	0.18	1.25	gravelly sand to sand	80-90	42-44	38	UNDEFINED
16.50	168.43	0.21	0.13	1.29	sand	70-80	42-44	32	UNDEFINED
17.00	102.13	0.13	0.13	1.32	sand	60-70	38-40	20	UNDEFINED
17.50	101.49	0.22	0.22	1.36	sand	60-70	38-40	19	UNDEFINED
18.00	171.24	0.28	0.16	1.39	sand	70-80	40-42	33	UNDEFINED
18.50	174.32	0.23	0.13	1.43	sand	70-80	40-42	33	UNDEFINED
19.00	191.14	0.25	0.13	1.46	sand	70-80	42-44	37	UNDEFINED

Dr - All sands (Jamiolkowski et al. 1985) PHI - Robertson and Campanella 1983 Su: Nk= 15

**** Note: For interpretation purposes the PLOTTED CPT PROFILE should be used with the TABULATED OUTPUT from CPTINTR1 (v 3.04) ****

Figure 8, Typical Interpreted Output from Electric Cone Penetrometer

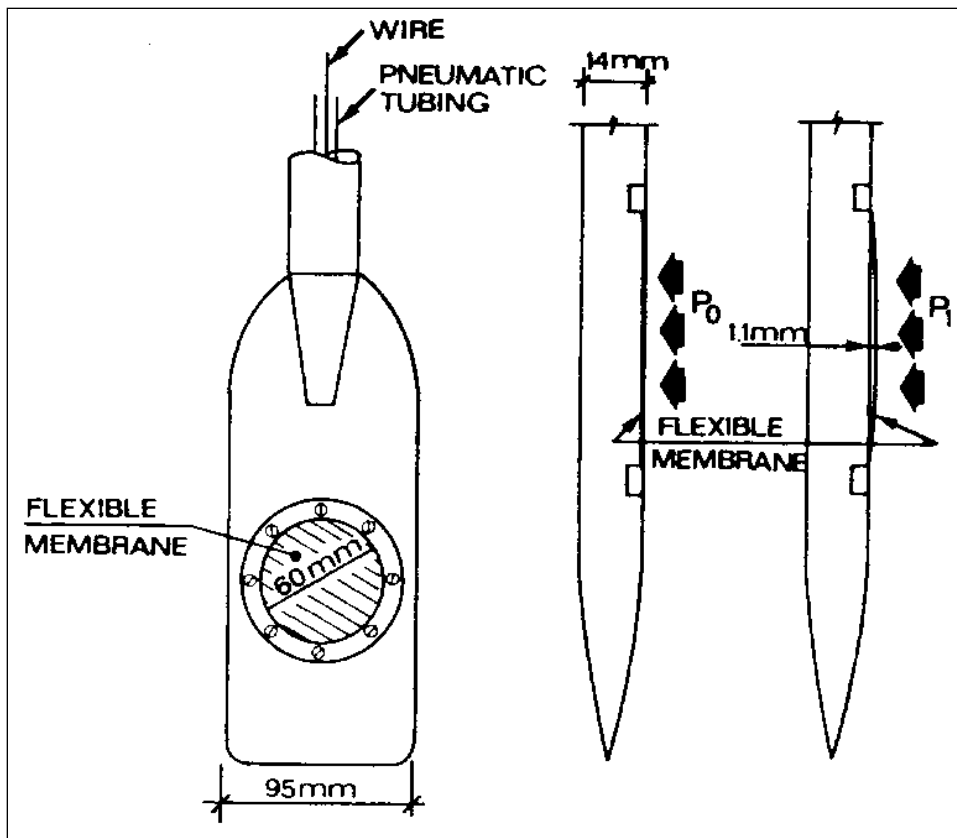

Figure 9, Schematic of the Marchetti Flat Dilatometer (After Baldi, et al., 1986)

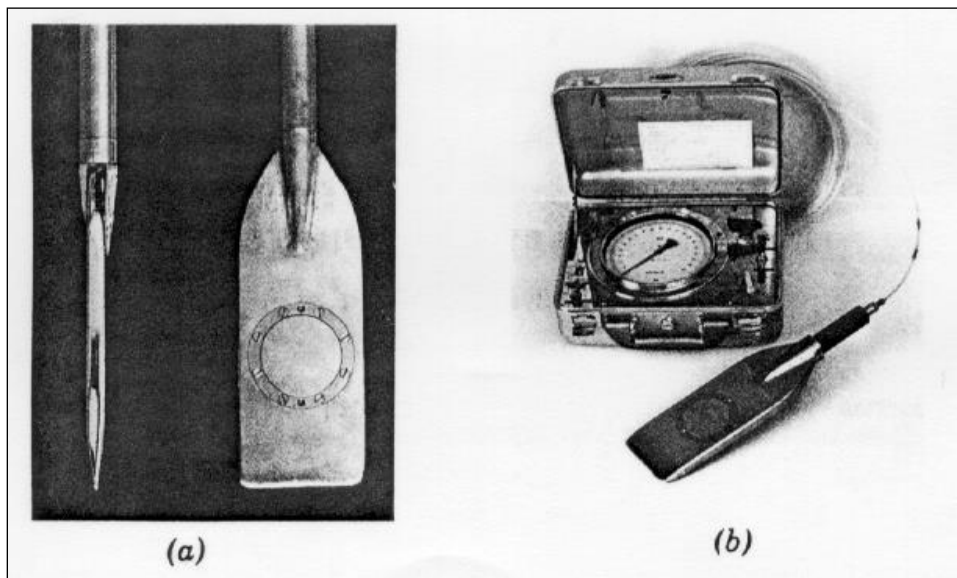

Figure 10, Dilatometer (After Marchetti 1980)

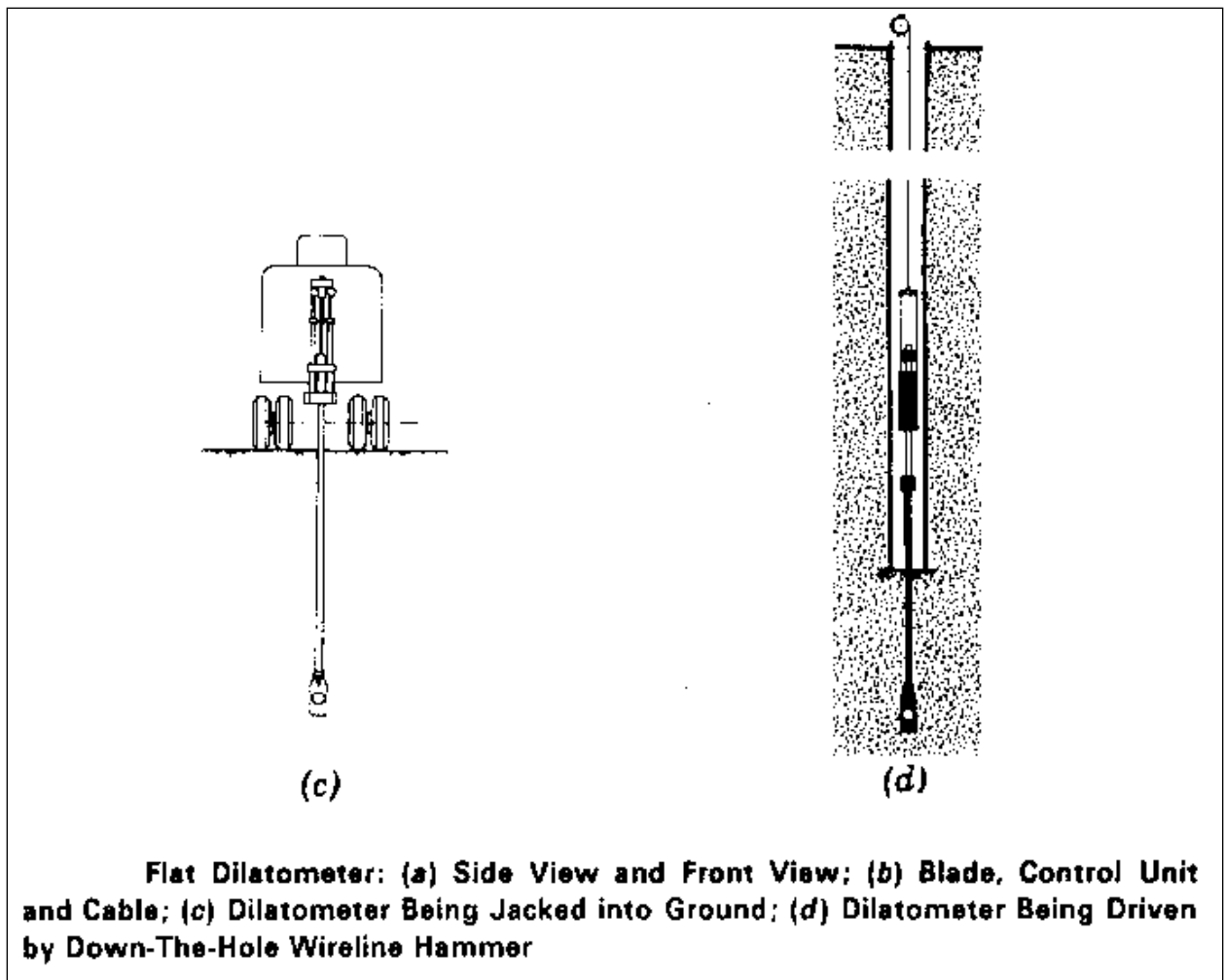

Figure 11, Dilatometer (Continued)

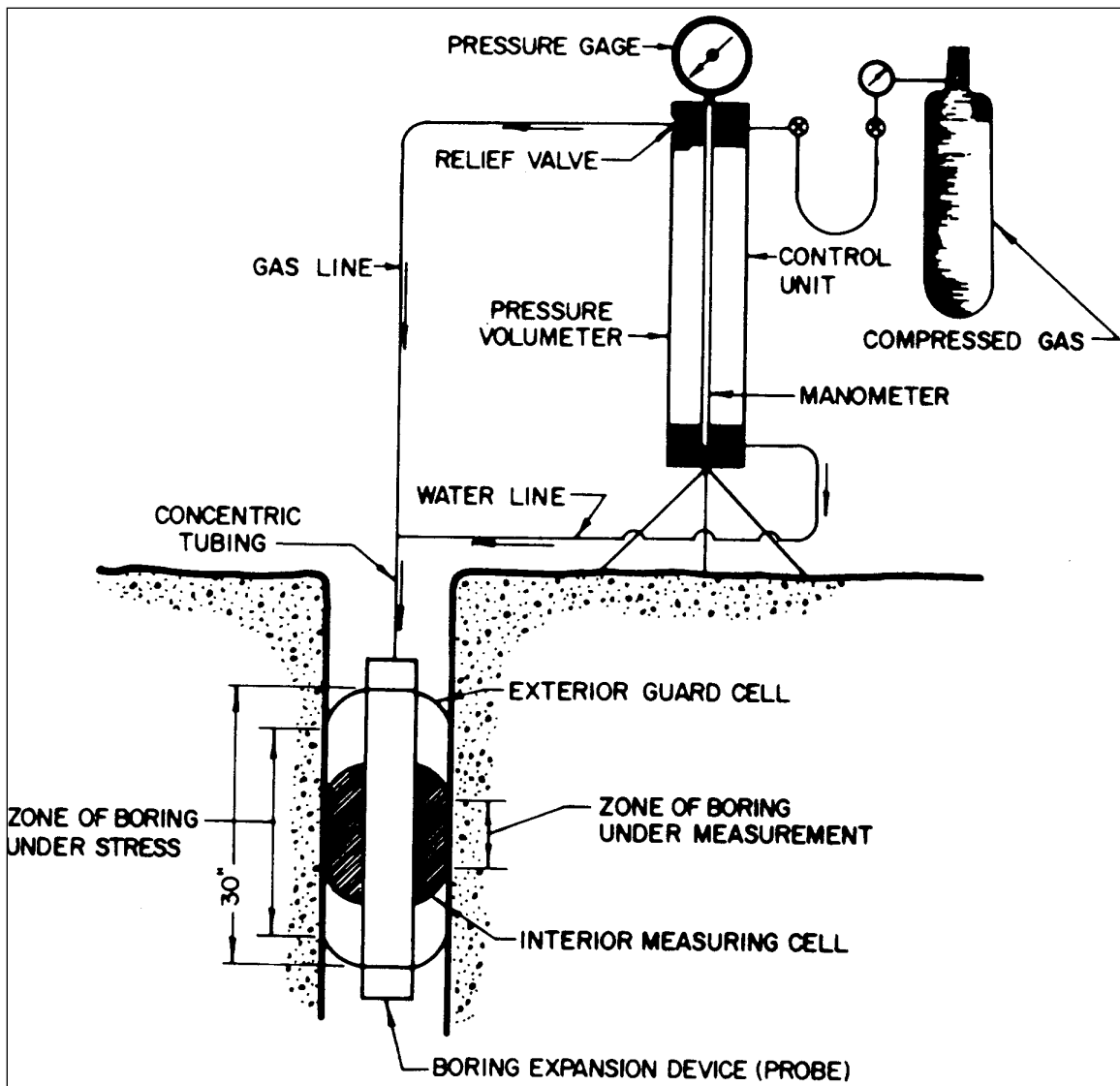

Figure 12, Menard Pressuremeter Equipment (After NAVFAC, 1986)

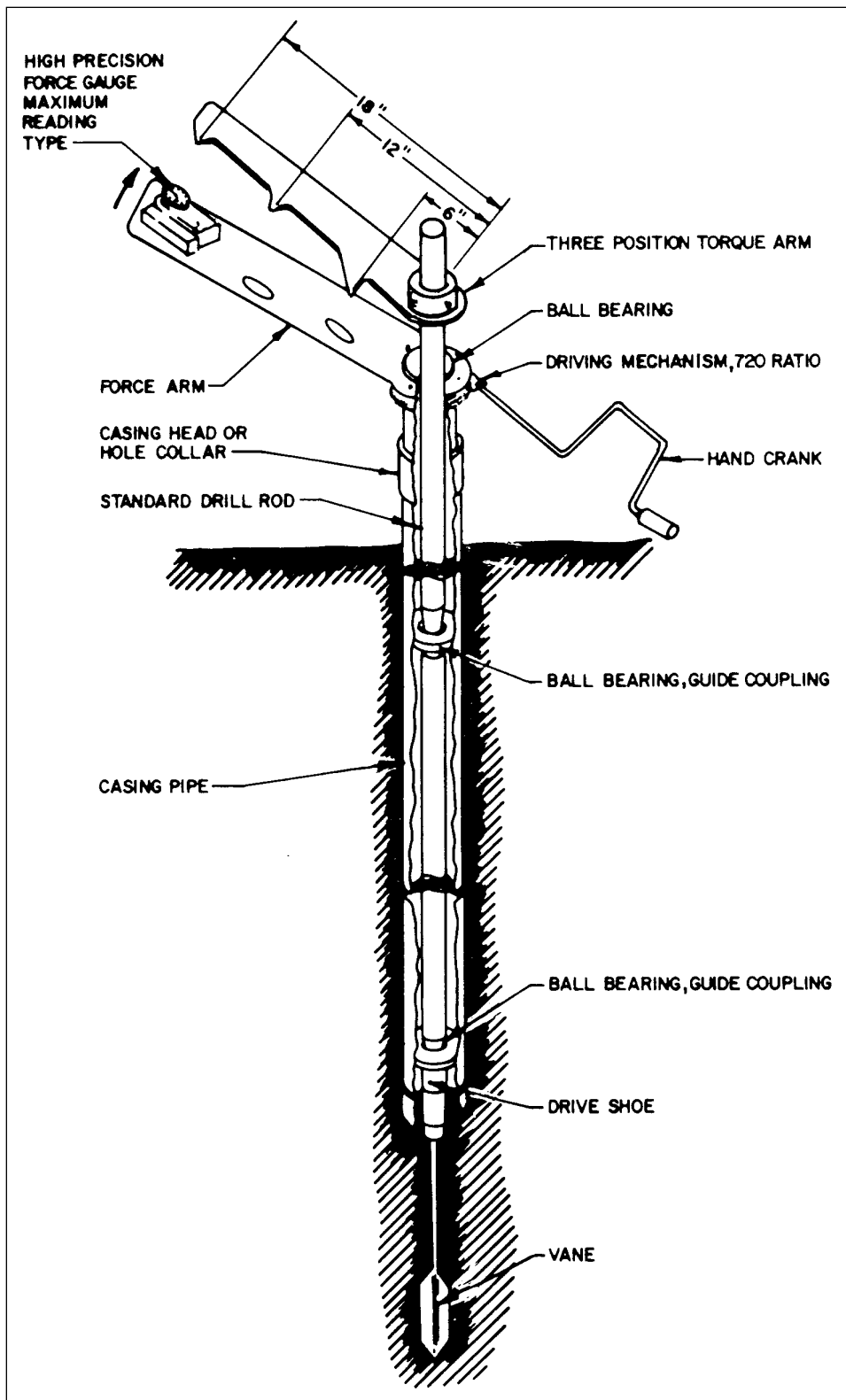

Figure 13, Vane Shear Test Equipment (After NAVFAC, 1986)

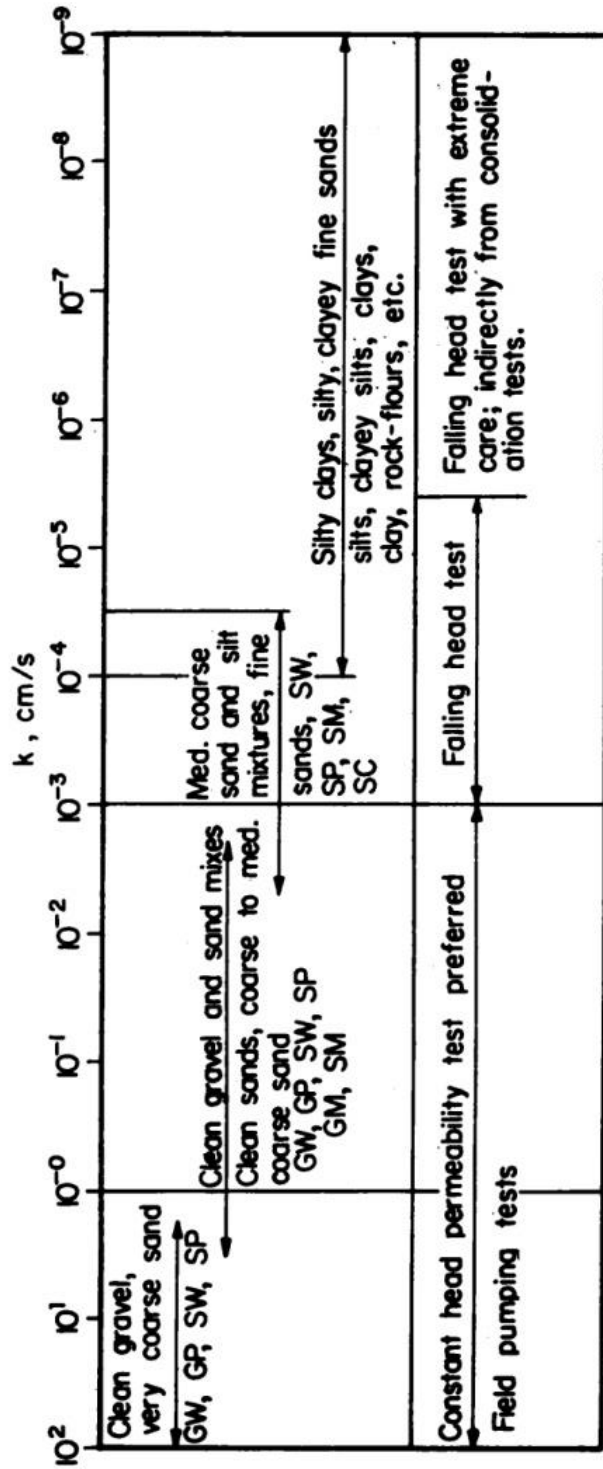

Figure 8-6 Typical ranges of permeability coefficients and suggested test methods.

Figure 14, Permeability Test Methods (from Bowles, 1984)

CASE		CONSTANT HEAD	VARIABLE HEAD	BASIC TIME LAG	NOTATION
A		$k_v = \frac{4 \cdot q \cdot L}{\pi \cdot D^2 \cdot H_c}$	$k_v = \frac{d^2 \cdot L}{D^2 \cdot (t_2 - t_1)} \ln \frac{H_1}{H_2}$ $k_v = \frac{L}{t_2 - t_1} \ln \frac{H_1}{H_2}$ FOR $d = D$	$k_v = \frac{d^2 \cdot L}{D^2 \cdot T}$ $k_v = \frac{L}{T}$ FOR $d = D$	<p>D = DIAM. INTAKE, SAMPLE, CM d = DIAMETER, STANDPIPE, CM L = LENGTH, INTAKE, SAMPLE, CM H_c = CONSTANT PIEZ. HEAD, CM H₁ = PIEZ. HEAD FOR t = t₁, CM H₂ = PIEZ. HEAD FOR t = t₂, CM q = FLOW OF WATER, CM³/SEC. t = TIME, SEC. T = BASIC TIME LAG, SEC. k'_v = VERT. PERM. CASING, CM/SEC. k_v = VERT. PERM. GROUND, CM/SEC. k_h = HORIZ. PERM. GROUND, CM/SEC. k_m = MEAN COEFF. PERM., CM/SEC. m = TRANSFORMATION RATIO k_m = √k_h · k_v m = √k_h / k_v ln = log_e = 2.3 log₁₀</p> <p>DETERMINATION BASIC TIME LAG T</p>
B		$k_m = \frac{q}{2 \cdot D \cdot H_c}$	$k_m = \frac{\pi \cdot d^2}{8 \cdot D \cdot (t_2 - t_1)} \ln \frac{H_1}{H_2}$ $k_m = \frac{\pi \cdot D}{8 \cdot (t_2 - t_1)} \ln \frac{H_1}{H_2}$ FOR $d = D$	$k_m = \frac{\pi \cdot d^2}{8 \cdot D \cdot T}$ $k_m = \frac{\pi \cdot D}{8 \cdot T}$ FOR $d = D$	
C		$k_m = \frac{q}{2.75 \cdot D \cdot H_c}$	$k_m = \frac{\pi \cdot d^2}{11 \cdot D \cdot (t_2 - t_1)} \ln \frac{H_1}{H_2}$ $k_m = \frac{\pi \cdot D}{11 \cdot (t_2 - t_1)} \ln \frac{H_1}{H_2}$ FOR $d = D$	$k_m = \frac{\pi \cdot d^2}{11 \cdot D \cdot T}$ $k_m = \frac{\pi \cdot D}{11 \cdot T}$ FOR $d = D$	
D		$k'_v = \frac{4 \cdot q \cdot \left[\frac{\pi \cdot k'_v \cdot D}{8 \cdot k_v \cdot m} + L \right]}{\pi \cdot D^2 \cdot H_c}$	$k'_v = \frac{d^2 \cdot \left[\frac{\pi \cdot k'_v \cdot D}{8 \cdot k_v \cdot m} + L \right]}{D^2 \cdot (t_2 - t_1)} \ln \frac{H_1}{H_2}$ $k_v = \frac{\pi \cdot D}{8 \cdot (t_2 - t_1)} + L \ln \frac{H_1}{H_2}$ FOR $k'_v = k_v$ $d = D$	$k'_v = \frac{d^2 \cdot \left[\frac{\pi \cdot k'_v \cdot D}{8 \cdot k_v \cdot m} + L \right]}{D^2 \cdot T}$ $k_v = \frac{\pi \cdot D}{8 \cdot T} + L$ FOR $k'_v = k_v$ $d = D$	
E		$k'_v = \frac{4 \cdot q \cdot \left[\frac{\pi \cdot k'_v \cdot D}{11 \cdot k_v \cdot m} + L \right]}{\pi \cdot D^2 \cdot H_c}$	$k'_v = \frac{d^2 \cdot \left[\frac{\pi \cdot k'_v \cdot D}{11 \cdot k_v \cdot m} + L \right]}{D^2 \cdot (t_2 - t_1)} \ln \frac{H_1}{H_2}$ $k_v = \frac{\pi \cdot D}{11 \cdot (t_2 - t_1)} + L \ln \frac{H_1}{H_2}$ FOR $k'_v = k_v$ $d = D$	$k'_v = \frac{d^2 \cdot \left[\frac{\pi \cdot k'_v \cdot D}{11 \cdot k_v \cdot m} + L \right]}{D^2 \cdot T}$ $k_v = \frac{\pi \cdot D}{11 \cdot T} + L$ FOR $k'_v = k_v$ $d = D$	
F		$k_h = \frac{q \cdot \ln \left[\frac{2mL}{D} + \sqrt{1 + \left(\frac{2mL}{D} \right)^2} \right]}{2 \cdot \pi \cdot L \cdot H_c}$	$k_h = \frac{d^2 \cdot \ln \left[\frac{2mL}{D} + \sqrt{1 + \left(\frac{2mL}{D} \right)^2} \right]}{8 \cdot L \cdot (t_2 - t_1)} \ln \frac{H_1}{H_2}$ $k_h = \frac{d^2 \cdot \ln \left(\frac{4mL}{D} \right)}{8 \cdot L \cdot (t_2 - t_1)} \ln \frac{H_1}{H_2}$ FOR $\frac{2mL}{D} > 4$	$k_h = \frac{d^2 \cdot \ln \left[\frac{2mL}{D} + \sqrt{1 + \left(\frac{2mL}{D} \right)^2} \right]}{8 \cdot L \cdot T}$ $k_h = \frac{d^2 \cdot \ln \left(\frac{4mL}{D} \right)}{8 \cdot L \cdot T}$ FOR $\frac{2mL}{D} > 4$	
G		$k_h = \frac{q \cdot \ln \left[\frac{mL}{D} + \sqrt{1 + \left(\frac{mL}{D} \right)^2} \right]}{2 \cdot \pi \cdot L \cdot H_c}$	$k_h = \frac{d^2 \cdot \ln \left[\frac{mL}{D} + \sqrt{1 + \left(\frac{mL}{D} \right)^2} \right]}{8 \cdot L \cdot (t_2 - t_1)} \ln \frac{H_1}{H_2}$ $k_h = \frac{d^2 \cdot \ln \left(\frac{2mL}{D} \right)}{8 \cdot L \cdot (t_2 - t_1)} \ln \frac{H_1}{H_2}$ FOR $\frac{mL}{D} > 4$	$k_h = \frac{d^2 \cdot \ln \left[\frac{mL}{D} + \sqrt{1 + \left(\frac{mL}{D} \right)^2} \right]}{8 \cdot L \cdot T}$ $k_h = \frac{d^2 \cdot \ln \left(\frac{2mL}{D} \right)}{8 \cdot L \cdot T}$ FOR $\frac{mL}{D} > 4$	

ASSUMPTIONS

SOIL AT INTAKE, INFINITE DEPTH AND DIRECTIONAL ISOTROPY (k_v AND k_h CONSTANT) - NO DISTURBANCE, SEGREGATION, SWELLING OR CONSOLIDATION OF SOIL - NO SEDIMENTATION OR LEAKAGE - NO AIR OR GAS IN SOIL, WELL POINT, OR PIPE - HYDRAULIC LOSSES IN PIPES, WELL POINT OR FILTER NEGLIGIBLE

Figure 15, Formulas for Determination of Permeability (Hvorslev, 1951)

4.12 References

1. Cheney, Richard S. & Chassie, Ronald G. Soils and Foundations Workshop Manual – Second Edition, FHWA HI-88-009, 1993.
2. NAVFAC DM-7.1 - Soils Mechanics, Department of the Navy, Naval Facilities Engineering Command, 1986.
3. Schmertmann, John, Guidelines for use in the Soils Investigation and Design of Foundations for Bridge Structures in the State of Florida, Florida Department of Transportation, Research Report 121-A, 1967.
4. Schmertmann, John H., Guidelines for Cone Penetration Test - Performance and Design, FHWA-TS-78-209, 1978.
5. Marchetti, Silvano, In-Situ Tests by Flat Dilatometer, Journal of the Geotechnical Engineering Division, ASCE, Vol. 106, No. GT3, March 1980.
6. Baldi, G., Bellotti R., Ghionna, V., Jamiolkowski, M., Marchetti, S. and Pasqualini, E. Flat Dilatometer Tests in Calibration Chambers, Use of Insitu Tests in Geotechnical Engineering, ASCE Specialty Conference, Geotechnical Special Publication No. 6, 1986.
7. Schmertmann, John, Suggested Method for Performing the Flat Dilatometer Test, Geotechnical Testing Journal, ASTM, Vol. 9, No. 2, June 1986.
8. U.S. Environmental Protection Agency, Land Treatment of Municipal Wastewater - Process Design Manual, 1981.
9. Standards For Onsite Sewage Disposal Systems, Rules of the Department of Health and Rehabilitative Services, Chapter 10 D-6, Florida Administrative Code.
10. US Department of Interior, Bureau of Reclamation, Earth Manual, US Government Printing Office, Washington, D.C., 1994.
11. Drainage Manual, Florida Department of Transportation, (Current version).
12. Munfakh, George, Arman, Ara, Samtani, Naresh, and Castelli, Raymond, Subsurface Investigations, FHWA-HI-97-021, 1997.
13. Briaud, Jean-Louis, The Pressuremeter Test for Highway Applications, FHWA-IP-89-008, 1989.
14. Briaud, Jean-Louis and Miran, Jerome; Manual on the Cone Penetrometer Test, FHWA-SA-91-043, 1992.
15. Briaud, Jean-Louis and Miran, Jerome; Manual on the Dilatometer Test, FHWA-SA-91-044, 1992.
16. Structures Design Guidelines, Florida Department of Transportation, (Current version).
17. Hvorslev, Juul M., Time Lag and Soil Permeability in Ground-Water Observations, Bulletin No. 36, United States Army Corps of Engineers Waterways Experiment Station, Vicksburg, 1951.
18. Bowles, Joseph E., Physical and Geotechnical Properties of Soils, Second Edition, New York: McGraw-Hill Book Company, 1984.

4.13 Specifications and Standards

<u>Subject</u>	<u>ASTM</u>	<u>AASHTO</u>	<u>FM</u>
Standard Test Method for Penetration Test and Split-Barrel Sampling of Soils	D 1586	T 206	-
Standard Test Method for Field Vane Shear Test in Cohesive Soil	D 2573	T 223	-
Standard Test Method for Infiltration Rate of Soils in Field Using Double-Ring Infiltrometer	D 3385	-	-
Standard Test Method (Field Procedure) for Withdrawal and Injection Well Tests for Determining Hydraulic Properties of Aquifer Systems	D 4050	-	-
Standard Test Method for Energy Measurement for Dynamic Penetrometers	D 4633	-	-
Standard Test Methods for Prebored Pressuremeter Testing in Soils	D 4719	-	-
Standard Practices for Preserving and Transporting Rock Core Samples	D 5079	-	-
Standard Test Method for Performing Electronic Friction Cone and Piezocone Penetration Testing of Soils	D 5778	-	-
Standard Practice for Using the Electronic Piezocone Penetrometer Tests for Environmental Site Characterization and Estimation of Hydraulic Conductivity	D 6067		
Standard Test Method for Field Measurement of Hydraulic Conductivity Using Borehole Infiltration	D 6391		
Standard Test Method for Performing the Flat Plate Dilatometer Test	D 6635	-	-
Standard Test Method for Use of the Dynamic Cone Penetrometer in Shallow Pavement Applications	D 6951	-	-
Standard Test Method for Field Measurement of Soil Resistivity Using the Wenner Four-Electrode Method	G 57	-	-
Standard Test Method for pH of pH of Soil and Water	-	-	5-550
Standard Test Method for Resistivity of Soil and Water	-	-	5-551
Standard Test Method for Sulfate in Soil and Water	-	-	5-553
Standard Test Methods for Chloride in Soil and Water	-	-	5-552

Subject

Standard Test Method for Determination of Mean Permeability in the Field Using the Vertical Insitu Permeameter (VIP)

ASTM

AASHTO

FM

5-614

Chapter 5

5 Laboratory Tests

As with other phases of a subsurface investigation program, the laboratory testing must be intelligently planned in advance but flexible enough to be modified based on test results. The ideal laboratory program will provide the engineer with sufficient data to complete an economical design, yet not tie up laboratory personnel and equipment with superfluous testing. The cost for laboratory testing is insignificant compared to the cost of an over-conservative design.

This chapter is limited to a brief description of the tests, their purpose and the uses of the resulting data. Detailed instructions on test procedures will be found in the References and Specifications and Standards listed at the end of the chapter. Tests shall be performed and results presented as described in the listed References and Specifications and Standards except as stated herein. Not every test outlined below is applicable to every project. Engineering judgment must be exercised in setting up a testing program that will produce the information required on each specific project.

5.1 Soils

5.1.1 Grain-Size Analysis

This test is performed in two stages: sieve analysis for coarse-grained soils (sands, gravels) and hydrometer analysis for fine-grained soils (clays, silts). Soils containing both types are tested in sequence, with the material passing the No. 200 sieve (0.075 mm or smaller) analyzed by hydrometer.

5.1.1.1 Sieve Analysis

This test provides a direct measurement of the particle size distribution of a soil by causing the sample to pass through a series of wire screens with progressively smaller openings of known size. The amount of material retained on each sieve is weighed. See AASHTO T 27 or AASHTO T 311 (ASTM C 136).

5.1.1.2 Hydrometer

This test is based on Stokes Law. The diameter of a soil particle is defined as the diameter of a sphere which has the same unit mass and which falls at the same velocity as the particle. Thus, a particle size distribution is obtained by using a hydrometer to measure the change in specific gravity of a soil-water suspension as soil particles settle out over time.

Results are reported on a combined grain size distribution plot as the percentage of sample smaller than, by weight, versus the log of the particle diameter. These data are necessary for a complete classification of the soil. The curve also provides other parameters, such as effective diameter (D_{10}) and coefficient of uniformity (C_u). Tests shall be performed in accordance with AASHTO T 88.

5.1.2 Moisture Content

The moisture content, w , is defined as the ratio of the weight of water in a sample to the weight of solids. The wet sample is weighed, and then oven-dried to a constant weight at a temperature of about 230° F (110° C). The weight after drying is the weight of solids. The change in weight, which has occurred during drying, is equivalent to the weight of water. For organic soils, a reduced drying temperature of approximately 140° F (60° C) is sometimes recommended. Tests shall be performed in accordance with AASHTO T 265 (ASTM D 2216).

The moisture content is valuable in determining the properties of soils and can be correlated with other parameters. A good technique is to plot the moisture content from SPT samples as a function of depth.

5.1.3 Atterberg Limits

The liquid limit, plastic limit and shrinkage limit are all Atterberg Limits. However, for classification purposes, the term Atterberg Limits generally refers to the liquid and plastic limits only. The tests for these two are described here; the shrinkage limit test is described in Section 5.1.8 of this chapter.

The liquid limit (LL) is the moisture content of a soil at the boundary between the liquid and plastic states. The plastic limit (PL) is the moisture content at the boundary between the plastic and semi-solid states. The plasticity index (PI) is the difference between the LL and PL. The results are generally reported as LL/PI values and can be plotted on the same graph as the moisture content above. These values are useful in soil classification and have been correlated with other parameters.

5.1.3.1 Liquid Limit

The liquid limit is determined by ascertaining the moisture content at which two halves of a soil cake will flow together for a distance of 0.5 inch along the bottom of the groove separating the halves, when the bowl they are in is dropped 25 times for a distance of 0.4 inches at the rate of 2 drops/second. Tests shall be performed in accordance with AASHTO T 89 (ASTM D 4318).

5.1.3.2 Plastic Limit

The plastic limit is determined by ascertaining the lowest moisture content at which the material can be rolled into threads 0.125 inches in diameter without crumbling. Tests shall be performed in accordance with AASHTO T 90 (ASTM D 4318).

5.1.4 Specific Gravity of Soils

The specific gravity of soil, G_s , is defined as the ratio of the mass in air of a given volume of soil particles to the mass in air of an equal volume of gas free distilled water at a stated temperature (typically 68° F). The specific gravity is determined by means of a calibrated pycnometer, by which the mass and temperature of a deaired soil/distilled water sample is measured. Tests shall be

performed in accordance with AASHTO T 100 (ASTM D 854). This method is used for soil samples composed of particles less than the No. 4 U.S. standard sieve (0.187 inch). For particles larger than this sieve, use the procedures for Specific Gravity and Absorption of Coarse Aggregate (AASHTO T 85 (ASTM C 127)).

The specific gravity of soils is needed to relate a weight of soil to its volume, and it is used in the computations of other laboratory tests.

5.1.5 Strength Tests

The shear strength of a soil is the maximum shearing stress the soil structure can resist before failure. Soils generally derive their strength from friction between particles (expressed as the angle of internal friction, ϕ), or cohesion between particles (expressed as the cohesion, c in units of force/unit area), or both. These parameters are expressed in the form of total stress (c , ϕ) or effective stress (c , ϕ). The total stress on any subsurface element is produced by the overburden pressure plus any applied loads. The effective stress equals the total stress minus the pore water pressure.

The common methods of ascertaining these parameters in the laboratory are discussed below. All of these tests should be performed only on undisturbed samples.

5.1.5.1 Unconfined Compression Tests

While under no confining pressure, a cylindrical sample is subjected to an axial load until failure. This test is only performed on cohesive soils. Total stress parameters are obtained. The cohesion is taken as one-half the unconfined compressive strength, q_u . This test is a fast and economical means of approximating the shear strength at shallow depths, but the reliability is poor with increasing depth. Tests shall be performed in accordance with AASHTO T 208 (ASTM D 2166).

5.1.5.2 Triaxial Compression Tests

In this test a cylindrical sample is subjected to an axial load until failure while also being subjected to confining pressure approximating the in-situ stress conditions. Various types of tests are possible with the triaxial apparatus as summarized below.

5.1.5.2.1 Unconsolidated-Undrained (UU), or Q Test

In this test the specimen is not permitted to change its initial water content before or during shear. The results are total stress parameters. This test is used primarily in the calculation of immediate embankment stability during quick-loading conditions. Refer to AASHTO T 296 (ASTM D 2850).

5.1.5.2.2 Consolidated-Undrained (CU), or R Test

In this test the specimen is allowed to consolidate under the confining pressure prior to shear, but no drainage is permitted during shear. A minimum of three tests at different confining pressures is required to derive the total stress parameters. If pore pressure measurements are taken during testing, the effective stress parameters can also be derived. Refer to ASTM D 4767.

5.1.5.2.3 Consolidated-Drained (CD), or S Test

This test is similar to the CU test (above) except that drainage is permitted during shear and the rate of shear is very slow. Thus, the buildup of excess pore pressure is prevented. As with the CU test, a minimum of three tests is required. Effective stress parameters are obtained. This test is used to determine parameters for calculating long-term stability of embankments. Refer to ASTM D 7181

5.1.5.3 Direct Shear

In this test a thin soil sample is placed in a shear box consisting of two parallel blocks and a normal force is applied. One block remains fixed while the other block is moved parallel to it in a horizontal direction. The soil fails by shearing along a plane that is forced to be horizontal. A series of at least three tests with varying normal forces is required to define the shear strength parameters for a particular soil. This test is typically run as a consolidated-drained test on cohesionless materials. Tests shall be performed in accordance with FM 3-D3080.

5.1.5.4 Miniature Vane Shear (Torvane) and Pocket Penetrometer

These tests are used only as an index of the undrained shear strength (S_u) of clay samples and should not be used in place of a laboratory test program. Both tests consist of hand-held devices that are pushed into the sample and either a torque resistance (torvane) or a tip resistance (pocket penetrometer) is measured. They can be performed in the lab or in the field, typically on the ends of undisturbed thin-walled tube samples, as well as along the sides of test pits. Miniature vane shear tests shall be performed in accordance with ASTM D 4648.

5.1.6 Consolidation Test

When large loads such as embankments are applied to the surface, cohesive subsoils will consolidate, i.e., settle over time, through a combination of the rearrangement of the individual particles and the squeezing out of water. The amount and rate of settlement is of great importance in construction. For example, an embankment may settle until a gap exists between an approach and a bridge abutment. The calculation of settlement involves many factors, including the magnitude of the load, the effect of the load at the depth at which compressible soils exist, the water table, and characteristics of the soil itself. Consolidation testing is performed to ascertain the nature of these characteristics.

5.1.6.1 One-Dimensional Test

The most often used method of consolidation testing is the one-dimensional test. In this test, a specimen is placed in a consolidometer (oedometer) between two porous stones, which permit drainage. Specimen size can vary depending on the equipment used. Various loading procedures can be used during a one-dimensional test with incremental loading being the most common. With this procedure the specimen is subjected to increasing loads, usually beginning at approximately 1/16 tsf and doubling each increment up to 16 tsf. After each load application the change in sample height is monitored incrementally for, generally, 24 hours or more to clearly identify t_{100} and creep consolidation characteristics. To evaluate the recompression parameters of the sample, an unload/reload cycle can be performed during the loading schedule. To better evaluate the recompression parameters for over consolidated clays, the unload/reload cycle may be performed after the preconsolidation pressure has been defined. After the maximum loading has been reached, the loading is removed in decrements. Tests shall be performed in accordance with AASHTO T 216 (ASTM D 2435).

The data from a consolidation test is usually presented on an e -log p curve, which plots void ratio (e) as a function of the log of pressure (p), or an ε -log p curve where ε equals % strain. The parameters necessary for settlement calculation can be derived from these curves: compression index (C_c), recompression index (C_r), preconsolidation pressure (p_o or P_c) and initial void ratio (e_o). A separate plot is prepared of change in sample height versus log time for each load increment; from this, the coefficient of consolidation (c_v) and coefficient of secondary compression (C_α) can be derived. These parameters are used to predict the rate of primary settlement and amount of secondary compression.

For high organic materials (organic content greater than 50%), FDOT-sponsored studies have shown that end of primary consolidation occurs quickly in the laboratory and field, and that a major portion of the total settlement is due to secondary and tertiary compression (creep). As a result, differentiating between primary consolidation and creep settlement on the individual loading's settlement versus time plots can be very difficult and generate misleading results. To analyze results from one-dimensional consolidation tests for these types of materials, use the Square Root (Taylor) Method to identify the end of primary consolidation for each load sequence. Each load sequence must be maintained for 24 hours or more to identify the slopes of the secondary and tertiary compression portions of the settlement versus time plot.

5.1.6.2 Constant Rate of Strain Test

Other loading methods include the Constant Rate of Strain Test (ASTM D 4186) in which the sample is subjected to a constantly changing load while maintaining a constant rate of strain; and the single-increment test,

sometimes used for organic soils, in which the sample is subjected only to the load expected in the field. A direct analogy is drawn between laboratory consolidation and field settlement amounts and rates.

5.1.7 Organic Content

Organic soils demonstrate very poor engineering characteristics, most notably low strength and high compressibility. In the field these soils can usually be identified by their dark color, musty odor and low unit weight. The most used laboratory test for design purposes is the Ignition Loss test, which measures how much of a sample's mass burns off when placed in a muffle furnace. The results are presented as a percentage of the total sample mass. Tests shall be performed in accordance with AASHTO T 267 (ASTM D 2974).

5.1.8 Shrinkage and Swell

5.1.8.1 Shrinkage

These tests are performed to determine the limits of a soil's tendency to lose volume during decreases in moisture content. The shrinkage limit (SL) is defined as the maximum water content at which a reduction in water content will not cause a decrease in volume of the soil mass. Tests shall be performed in accordance with ASTM D 4943.

5.1.8.2 Swell

Some soils, particularly those containing montmorillonite clay, tend to increase their volume when their moisture content increases. These soils are unsuitable for roadway construction. The swell potential can be estimated from the test methods shown in AASHTO T 258 (ASTM D 4546).

5.1.9 Permeability

The laboratory determination of soil permeability can be performed by one of the following test methods. Permeability can also be determined either directly or indirectly from a consolidation test.

5.1.9.1 Constant-Head Test

This test uses a permeameter into which the sample is placed and compacted to the desired relative density. Water (preferably de-aired) is introduced via an inlet valve until the sample is saturated. Water is then allowed to flow through the sample while a constant head is maintained. The permeability is measured by the quantity of flow of discharge over a specified time. This method is generally preferred for use with coarse-grained soils with $k > 10^{-3}$ cm/sec (Bowles 1984). Tests shall be performed in accordance with AASHTO T 215 (ASTM D 5856 or ASTM D 2434).

5.1.9.2 Falling-Head Test

This test uses an apparatus and procedure similar to the constant-head test (above), but the head is not kept constant. The permeability is measured by the decrease in head over a specified time. This method is often considered more economical for tests of long duration, such as tests on fine-grained soils with k between 5×10^{-5} and 10^{-3} cm/sec (Bowles 1984). Tests shall be performed in accordance with FM 5-513.

5.1.9.3 Flexible Wall Permeability

For fine-grained soils, tests performed using a triaxial cell are generally preferred. In-situ conditions can be modeled by application of an appropriate confining pressure. The sample can be saturated using back pressuring techniques. Water is then allowed to flow through the sample and measurements are taken until steady-state conditions occur. Tests shall be performed in accordance with ASTM D 5084.

5.1.10 Environmental Corrosion Tests

These tests are performed to determine the corrosion classification of soil and water. A series of tests includes pH, resistivity, chloride content, and sulfate content testing. The testing can be done either in the laboratory or in the field. See the **Environmental Corrosion Tests** section in [Chapter 4](#) for a list of test procedures. Corrosion testing must be performed for each site unless the most aggressive conditions are assumed.

5.1.11 Compaction Tests

These tests are used to determine the optimum water content and maximum dry density, which can be achieved for a particular soil using a designated compactive effort. Results are used to determine appropriate methods of field compaction and to provide a standard by which to judge the acceptability of field compaction.

Compacting a sample in a test mold of known volume using a specified compactive effort performs the test. The water content and the weight of the sample required to fill the mold are determined. Results are plotted as density versus water content. By varying the water content of the sample, several points on the moisture-density curve shall be obtained in accordance with the standard procedures specified.

The compactive effort used is dependent upon the proposed purpose of the site and the loading to which it will be subjected. The most commonly used laboratory test compactive efforts are described below.

5.1.11.1 Standard Proctor

This test method uses a 5.5-pound rammer dropped from a height of 12 inches. The sample is compacted in three layers. Tests shall be performed in accordance with FM 1-T 099.

5.1.11.2 Modified Proctor

This test method uses a 10-pound rammer dropped from a height of 18 inches. The sample is compacted in five layers. Tests shall be performed in accordance with FM 1-T 180.

5.1.12 Relative Density Tests

Proctor tests often do not produce a well-defined moisture-density curve for cohesionless, free-draining soils. Additionally, maximum densities from Proctor tests may be less than those obtained in the field or by vibratory methods. For these soils, it may be preferable to perform tests, which determine standard maximum and minimum densities of the soil. The density of the in-situ soil can then be compared with these maximum and minimum densities and its relative density and/or percent compaction can be calculated.

5.1.12.1 Maximum Index Density

This test requires that either oven-dried or wet soil be placed in a mold of known volume, and that a 2-psi surcharge load is applied. The mold is then vertically vibrated at a specified frequency for a specified time. The weight and volume of the sample after vibrating are used to calculate the maximum index density. Tests shall be performed in accordance with ASTM D 4253.

5.1.12.2 Minimum Index Density

This test is performed to establish the loosest condition, which can be attained by standard laboratory procedures. Several methods can be used, but the preferred method is to carefully pour a steady stream of oven-dried soil into a mold of known volume through a funnel. Funnel height should be adjusted continuously to maintain a free fall of the soil of approximately 0.5 inches. Tests shall be performed in accordance with ASTM D 4254.

5.1.13 Limerock Bearing Ratio (LBR)

This test is used to determine the bearing value of limerock and other soils, which are used as base, stabilized subgrade in Florida.

A minimum of four, and preferably five, samples is compacted at varying moisture contents to establish a moisture-density curve for the material. Compaction procedures are similar to those of the modified Proctor test. There are two options, the soaked and the unsoaked methods. For the soaked method, the samples are soaked for a period of 48 hours under a surcharge mass of at least 2.5 lb. For the unsoaked method, the samples are tested without any soak period. For both methods a penetration test is then performed on each sample by causing a 1.95-inch diameter piston to penetrate the soil at a constant rate and to a depth of 0.5 inches. A load-penetration curve is plotted for each sample and the LBR corresponding to 0.1-inch penetration is calculated. The maximum LBR for a material is determined from a plot of LBR versus moisture content. Tests shall be performed in accordance with FM 5-515.

5.1.14 Resilient Modulus Test (Dynamic)

This test is used to determine the dynamic elastic modulus of a base or subgrade soil under conditions that represent a reasonable simulation of the physical conditions and stress states of such materials under flexible pavements subjected to wheel loads. A prepared cylindrical sample is placed in a triaxial chamber and conditioned under static or dynamic stresses. A repeated axial stress is then applied at a fixed magnitude, duration, and frequency. The resilient modulus, M_r , is calculated by dividing the deviator stress by the resilient axial strain. This value is used in the design and evaluation of pavement systems. Tests shall be performed in accordance with AASHTO T 307.

5.2 Rock Cores

Laboratory tests on rock are performed on small samples of intact cores. However, the properties of in-situ rock are often determined by the presence of joints, bedding planes, etc. It is also important that the rock cores come from the zone that the foundations are founded in. Laboratory test results must therefore be considered in conjunction with knowledge of the in-situ characteristics of the rock mass. Some of the more common laboratory tests are:

5.2.1 Unconfined Compression Test

This test is performed on intact rock core specimens, which preferably have a length of at least two times the diameter. The specimen is placed in the testing machine and loaded axially at an approximately constant rate such that failure occurs within 2 to 15 minutes. **Note: the testing machine must be of the proper size for the samples being tested.** Tests shall be performed in accordance with ASTM D 7012.

5.2.2 Absorption and Bulk Specific Gravity

Absorption is a measure of the amount of water, which an initially dry specimen can absorb during a 48-hour soaking period. It is indicative of the porosity of the sample. Bulk specific gravity is used to calculate the unit weight of the material. Tests shall be performed in accordance with ASTM C 97.

5.2.3 Splitting Tensile Strength Test

This test is an indirect tensile strength test similar to the point load test; however, the compressive loads are line loads applied parallel to the core's axis by steel bearing plates between which the specimen is placed horizontally. Loading is applied continuously such that failure occurs within one to ten minutes. The splitting tensile strength of the specimen is calculated from the results. Tests shall be performed in accordance with ASTM D 3967 **except that the minimum t/D (length-to-diameter) ratio shall be 1.0 when testing.**

5.2.4 Triaxial Compression Strength

This test is performed to provide shearing strengths and elastic properties of rock under a confining pressure. It is commonly used to simulate the stress

conditions under which the rock exists in the field. Tests shall be performed in accordance with ASTM D 7012.

5.2.5 Unit Weight of Sample

This is a direct determination of either the moist or total weight of the rock core sample divided by the total cylindrical volume of the intact sample (for the total/moist unit weight), or the oven-dried weight divided by the total volume (for the dry unit weight). This measurement includes any voids or pore spaces in the sample, and therefore can be a relative indicator of the strength of the core sample. Samples should be tested at the moisture content representative of field conditions, and samples should be preserved until time of testing. Moisture contents shall be performed in accordance with ASTM D 2216.

5.2.6 Rock Scour Rate Determination

A rotating erosion test apparatus (RETA) was developed during research sponsored by the Department to measure the erosion of intact 4 inch long by 2.4 inch or 4 inch diameter rock core samples. Results from these tests can be used to model the erodibility of cohesive soils and soft rock and estimate scour depths. When reduced scour susceptibility is suspected, contact the District Geotechnical Engineer to determine the availability of scour testing for site-specific applications.

5.3 References

1. Lambe, T. William, Soil Testing for Engineers, John Wiley & Sons, Inc. New York, NY, 1951.
2. NAVFAC DM-7.1 - Soil Mechanics, Department of the Navy, Naval Facilities Engineering Command, 1986.
3. Munfakh, George, Arman, Ara, Samtani, Naresh, and Castelli, Raymond, Subsurface Investigations, FHWA-HI-97-021, 1997.
4. Bowles, J. E., "Engineering Properties of Soils and Their Measurement", 3rd ed., McGraw Hill Book Company, New York, 1986

5.4 Specifications and Standards

<u>Subject</u>	<u>ASTM</u>	<u>AASHTO</u>	<u>FM</u>
Standard Test Method for Coefficient of Permeability - Falling Head	-	-	5-513
Standard Test Method for Limerock Bearing Ratio (LBR)	-	-	5-515
Standard Test Method for Determining the Resilient Modulus of Soils and Aggregate Materials	-	T 307	-
Standard Test Methods for Absorption and Bulk Specific Gravity of Dimension Stone	C 97	-	-
Standard Test Method for Specific Gravity and Absorption of Coarse Aggregate	C 127	T 85	1-T 85
Standard Test Method for Sieve Analysis of Fine and Coarse Aggregate	C 136	T 27	
Standard Test Method for Grain-Size Analysis of Granular Soil Materials		T 311	
Standard Test Method for Particle-Size Analysis of Soils	-	T 88	-
Standard Test Method for Shrinkage Factors of Soils by the Wax Method	D 4943	-	-
Standard Test Method for Laboratory Compaction Characteristics of Soil Using Standard Effort (12,400 ft-lbf/ft ³ (600 kN-m/m ³))			1-T 099
Standard Test Method for Specific Gravity of Soils	D 854	T 100	-
Standard Test Method for Laboratory Compaction Characteristics of Soil Using Modified Effort (56,000 ft-lbf/ft ³ (2,700 kN-m/m ³))			1-T 180
Standard Test Method for Unconfined Compressive Strength of Cohesive Soil	D 2166	T 208	-
Standard Test Method for Laboratory Determination of Water (Moisture) Content of Soil and Rock	D 2216	T 265	-
Standard Test Method for Permeability of Granular Soils (Constant Head)	D 2434	T 215	-
Standard Test Method for One-Dimensional Consolidation Properties of Soils	D 2435	T 216	-
Standard Test Method for Unconsolidated, Undrained Compressive Strength of Cohesive Soils in Triaxial Compression	D 2850	T 296	-
Standard Test Methods for Moisture, Ash, and Organic Matter of Peat and Other Organic Soils	D 2974	T 267	1-T 267

<u>Subject</u>	<u>ASTM</u>	<u>AASHTO</u>	<u>FM</u>
Standard Test Method for Direct Shear Test of Soils Under Consolidated Drained Conditions	-	-	3-D3080
Standard Test Method for Splitting Tensile Strength of Intact Rock Core Specimens	D 3967	-	-
Standard Test Method for One-Dimensional Consolidation Properties of Soils Using Controlled-Strain Loading	D 4186	-	-
Standard Test Methods for Maximum Index Density and Unit Weight of Soils Using a Vibratory Table	D 4253	-	-
Standard Test Method for Minimum Index Density and Unit Weight of Soils and Calculation of Relative Density	D 4254	-	-
Standard Test Method for Liquid Limit, Plastic Limit, and Plasticity Index of Soils	D 4318	T 89 & T 90	-
Standard Test Methods for One-Dimensional Swell or Settlement Potential of Cohesive Soils	D 4546	T 258	-
Standard Test Method for Laboratory Miniature Vane Shear Test for Saturated Fine-Grained Clayey Soil	D 4648	-	-
Standard Test Method for Consolidated Undrained Triaxial Compression Test for Cohesive Soils	D 4767	-	-
Standard Practices for Preserving and Transporting Rock Core Samples	D 5079	-	-
Standard Test Method for Measurement of Hydraulic Conductivity of Saturated Porous Materials Using a Flexible Wall Permeameter	D 5084	-	-
Standard Test Method for Measurement of Hydraulic Conductivity of Porous Material Using a Rigid-Wall, Compaction-Mold Permeameter	D 5856	-	-
Standard Test Method for Compressive Strength and Elastic Moduli of Intact Rock Core Specimens under Varying States of Stress and Temperatures	D 7012	-	-
Standard Test Method for Consolidated, Drained Triaxial Compression Test for Soils	D 7181	-	-

Chapter 6

6 Materials Description, Classification, and Logging

During field exploration a log must be kept of the materials encountered. A field engineer, a geologist, or the driller usually keeps the field log. Details of the subsurface conditions encountered, including basic material descriptions, and details of the drilling and sampling methods should be recorded. Upon delivery of the samples to the laboratory, an experienced technician will generally verify or modify material descriptions and classifications based on the results of laboratory testing and/or detailed visual-manual inspection of samples. See ASTM D 5434.

Material descriptions, classifications, and other information obtained during the subsurface explorations are heavily relied upon throughout the remainder of the investigation program and during the design and construction phases of a project. It is therefore necessary that the method of reporting this data is standardized. Records of subsurface explorations should follow as closely as possible the standardized format presented in this chapter.

6.1 Materials Description and Classification

A detailed description for each material stratum encountered should be included on the log. The extent of detail will be somewhat dependent upon the material itself and on the purpose of the project. However, the descriptions should be sufficiently detailed to provide the engineer with an understanding of the material present at the site. Since it is rarely possible to test all of the samples obtained during an exploration program, the descriptions should be sufficiently detailed to permit grouping of similar materials and choice of representative samples for testing.

6.1.1 Soils

Soils should be described in general accordance with the Description and Identification of Soils (Visual - Manual Procedure) of ASTM D 2488. This procedure employs visual examination and simple manual tests to identify soil characteristics, which are then included in the material description. For example, estimates of grain-size distribution by visual examination indicate whether the soil is fine-grained or coarse-grained. Manual tests for dry strength, dilatancy, toughness, and plasticity indicate the type of fine-grained soil. Organics are identified by color and odor. A detailed soil description should comply with the following format:

- Color
- Constituents
- Grading
- Relative Density or Consistency
- Moisture Content
- Particle Angularity and Shape
- Additional Descriptive Terms
- Classification

6.1.1.1 Color

The color description is restricted to two colors. If more than two colors exist, the soil should be described as multi-colored or mottled and the two predominant colors given.

6.1.1.2 Constituents

Constituents are identified considering grain size distribution and the results of the manual tests. In addition to the principal constituent, other constituents which may affect the engineering properties of the soil should be identified. Secondary constituents are generally indicated as modifiers to the principal constituent (i.e., sandy clay or silty gravel). Other constituents can be included in the description using the terminology of ASTM D 2488 through the use of terms such as trace (<5%), few (5-10%), little (15-25%), some (30-45%) and mostly (50-100%).

6.1.1.3 Grading

6.1.1.3.1 Coarse-Grained Soils

Coarse-grained soils are defined as either:

6.1.1.3.1.1 Well-Graded

Soil contains a good representation of all particle sizes from largest to smallest.

6.1.1.3.1.2 Poorly-Graded

Soil contains particles about the same size. A soil of this type is sometimes described as being uniform.

6.1.1.3.1.3 Gap-Graded

Soil does not contain one or more intermediate particles sizes. A soil consisting of gravel and fine sand would be gap graded because of the absence of medium and coarse sand sizes.

6.1.1.3.2 Fine-Grained Soil

Descriptions of fine-grained soils should not include a grading.

6.1.1.4 Relative Density and Consistency

Relative density refers to the degree of compactness of a coarse-grained soil. Consistency refers to the stiffness of a fine-grained soil. When evaluating subsoil conditions using correlations based on safety hammer SPT tests, SPT-N values obtained using an automatic hammer should be increased by a factor of 1.24 to produce the equivalent safety hammer SPT-N value. However, only actual field recorded (uncorrected) SPT-N values shall be included on the [Report of Core Borings Sheet](#).

Standard Penetration Test N-values (blows per foot) are usually used to define the relative density and consistency as follows:

Table 1, Relative Density or Consistency

<i>Granular Materials</i>		
Relative Density	Safety Hammer SPT N-Value (Blow/Foot)	Automatic Hammer SPT N-Value (Blow/Foot)
Very Loose	Less than 4	Less than 3
Loose	4 – 10	3 – 8
Medium Dense	10 – 30	8 – 24
Dense	30 – 50	24 – 40
Very Dense	Greater than 50	Greater than 40
<i>Silts and Clays</i>		
Consistency	Safety Hammer SPT N-Value (Blow/Foot)	Automatic Hammer SPT N-Value (Blow/Foot)
Very Soft	Less than 2	Less than 1
Soft	2 – 4	1 – 3
Firm	4 – 8	3 – 6
Stiff	8 – 15	6 – 12
Very Stiff	15 – 30	12 – 24
Hard	Greater than 30	Greater than 24

If SPT data is not available, consistency can be estimated in the field based on visual-manual examination of the material. Refer to ASTM D 2488 for consistency criteria.

The pocket penetrometer and torvane devices may be used in the field as an index of the remolded undrained shear strength of clay samples. See Section 5.15.4.

6.1.1.5 Friction Angle vs. SPT-N

Various published correlations estimate the angle of internal friction, ϕ , of cohesionless soils based on SPT-N values and effective overburden pressure. Some of these correlations are widely accepted whereas, others are more likely to overestimate triaxial test data. In the absence of laboratory shear strength testing, ϕ estimates for cohesionless soils, based on SPT-N, shall not exceed the values proposed by Peck, 1974 (see [Figure 16](#)). These values are based on SPT-N values obtained at an effective overburden pressure of one ton per square foot. The correction factor, C_N , proposed by Peck, 1974 (see [Figure 17](#)) may be used to “correct” N values obtained at overburden pressures other than 1 tsf.

6.1.1.6 Moisture Content

The in-situ moisture content of a soil should be described as dry, moist, or wet.

6.1.1.7 Particle Angularity and Shape

Coarse-grained soils are described as angular, sub-angular, sub-rounded, or rounded. Gravel, cobbles, and boulders can be described as flat, elongated, or flat and elongated. Descriptions of fine-grained soils will not include a particle angularity or shape.

6.1.1.8 Organic Content

The organic content of materials can greatly alter its engineering properties. In general, materials with an organic content greater than 5% are considered unsuitable for use in roadway embankments. In some instances materials with lesser organic contents are desired. Classify organic soils as follows:

- Organic Material = O.C. > 5% but < 20%
- Highly Organic Material = O.C. > 20 but < 75%; highly organic materials are often referred to as “muck” in other FDOT documents.
- Peat = O.C. > 75% (which is defined in ASTM D 4427)

6.1.1.9 Additional Descriptive Terms

Any additional descriptive terms considered to be helpful in identifying the soil should be included. Examples of such terms include calcareous, cemented, micaceous and gritty. Material origins or local names should be included in parentheses (i.e., fill, ironrock).

The term “clean sand” is commonly used to describe A-3 sand which is free of organics, debris, clay lumps, etc.

6.1.1.10 Classification

A soil classification should permit the engineer to easily relate the soil description to its behavior characteristics. All soils should be classified according to one of the following two systems.

6.1.1.10.1 Unified Soil Classification System (USCS)

This system is used primarily for engineering purposes and is particularly useful to the Geotechnical Engineer. Therefore, they should be used for all structural-related projects; such as bridges, retaining walls, buildings, etc. Precise classification requires that a grain size analysis and Atterberg Limits tests be performed on the sample. The method is discussed in detail in ASTM D 2487 and a summary is reprinted in [Figure 18](#) and [Figure 19](#) for convenience.

6.1.1.10.2 AASHTO Classification System

This system is used generally to classify soils for highway construction purposes and therefore will most often be used in conjunction with roadway soil surveys. Like the Unified System, this system requires grain size analysis and Atterberg Limit tests for precise classification. The system is discussed in detail in AASHTO M 145 (ASTM D 3282), and a summary is reprinted in [Figure 20](#) and [Figure 21](#) for convenience.

6.1.2 Rocks

In Florida, only sedimentary rocks are encountered within the practical depths for structure foundations. Descriptions of sedimentary rocks are based on visual observations and simple tests. Descriptions should comply with the following format:

- Color
- Constituents
- Weathering
- Grain Size
- Cementation
- Additional Descriptive Terms

6.1.2.1 Color

As with soils, the description should be limited to two predominant colors.

6.1.2.2 Constituents

The principal constituent is the rock type constituting the major portion of the stratum being investigated. Since the formations encountered in Florida normally consist of only one rock type, the use of modifying constituents will generally not be applicable; however, when more than one rock type is present in any given formation, both should be included in the description.

6.1.2.3 Weathering

The degree of weathering should be described. Classical classification systems do not apply to Florida rock.

6.1.2.4 Hardness

Classical classification systems do not apply to Florida rock. Do not include subjective descriptions of rock hardness. Include only the objective indicators of the rock hardness (SPT-N values, excessive drilling time and down pressure, results of core testing, etc.) that would lead others to your subjective conclusions.

In historic documents “soft limerock” sometimes referred to materials containing limestone or limerock fragments with SPT-N less than or equal to 50 blows per foot.

6.1.2.5 Formation

Include the name of the geologic formation in parentheses after the description of the sample.

6.1.2.6 Additional Description Terms

Use any additional terms that will aid in describing the type and condition of the rock being described. Terms such as fossiliferous, friable, indurated, and micaceous are to be used where applicable.

6.2 Logging

The standard boring log included as [Figure 22](#), or its equivalent as approved by the District Geotechnical Engineer, shall be used for all borings and test pits. A sample completed log is included as [Figure 23](#). The majority of information to be included on this form is self-explanatory. Information that should be presented in the remarks column includes:

6.2.1 Comments on Drilling Procedures and/or Problems

Any occurrences, which may indicate characteristics of the in-situ material, should be reported. Such occurrences include obstructions; difficulties in drilling such as caving, flowing sands, caverns, loss of drilling fluid, falling drill rods, change in drilling method and termination of boring above planned depth.

6.2.2 Test Results

Results of tests performed on samples in the field, such as pocket penetrometer or torvane tests should be noted. Results of tests on in-situ materials, such as field vane tests, should also be recorded.

6.2.3 Rock Quality Designation (RQD)

In addition to the percent recovery, the RQD should be recorded for each core run. RQD is a modified core recovery, which is best used on NX size core or larger (HW is FDOT minimum size allowed). It describes the quality of rock based on the degree and amount of natural fracturing. Determined the RQD by summing the lengths of all core pieces equal to or longer than 4 inches (ignoring fresh irregular breaks caused by drilling) and dividing that sum by the total length of the core run.

Expressing the RQD as a percentage, the rock quality is described as follows:

<u>RQD (%)</u>	<u>Description of Rock Quality</u>
0 - 25	Very poor
25 - 50	Poor
50 - 75	Fair
75 - 90	Good
90 - 100	Excellent

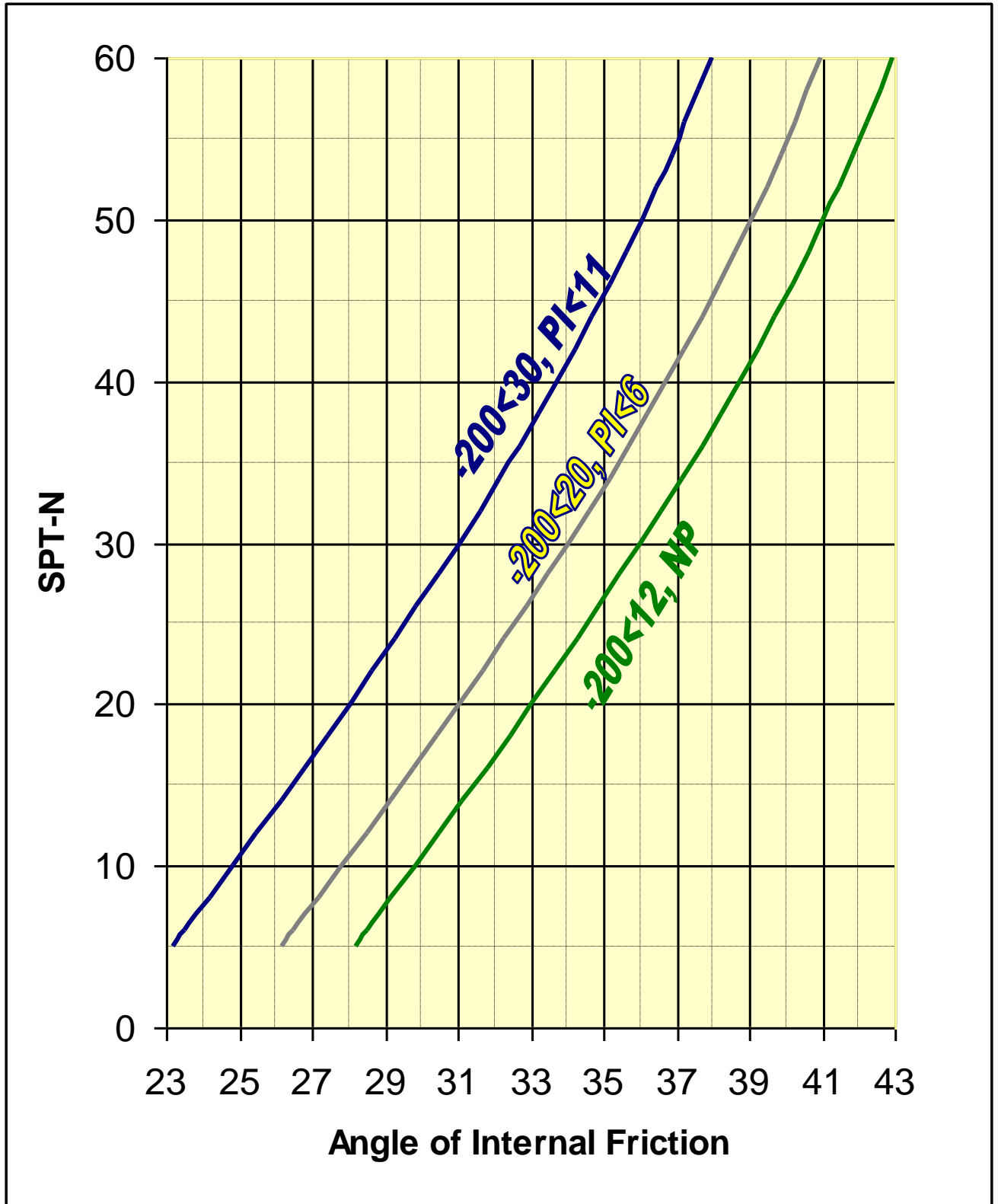

Figure 16, Angle of Internal Friction vs. SPT-N (After Peck, 1974)

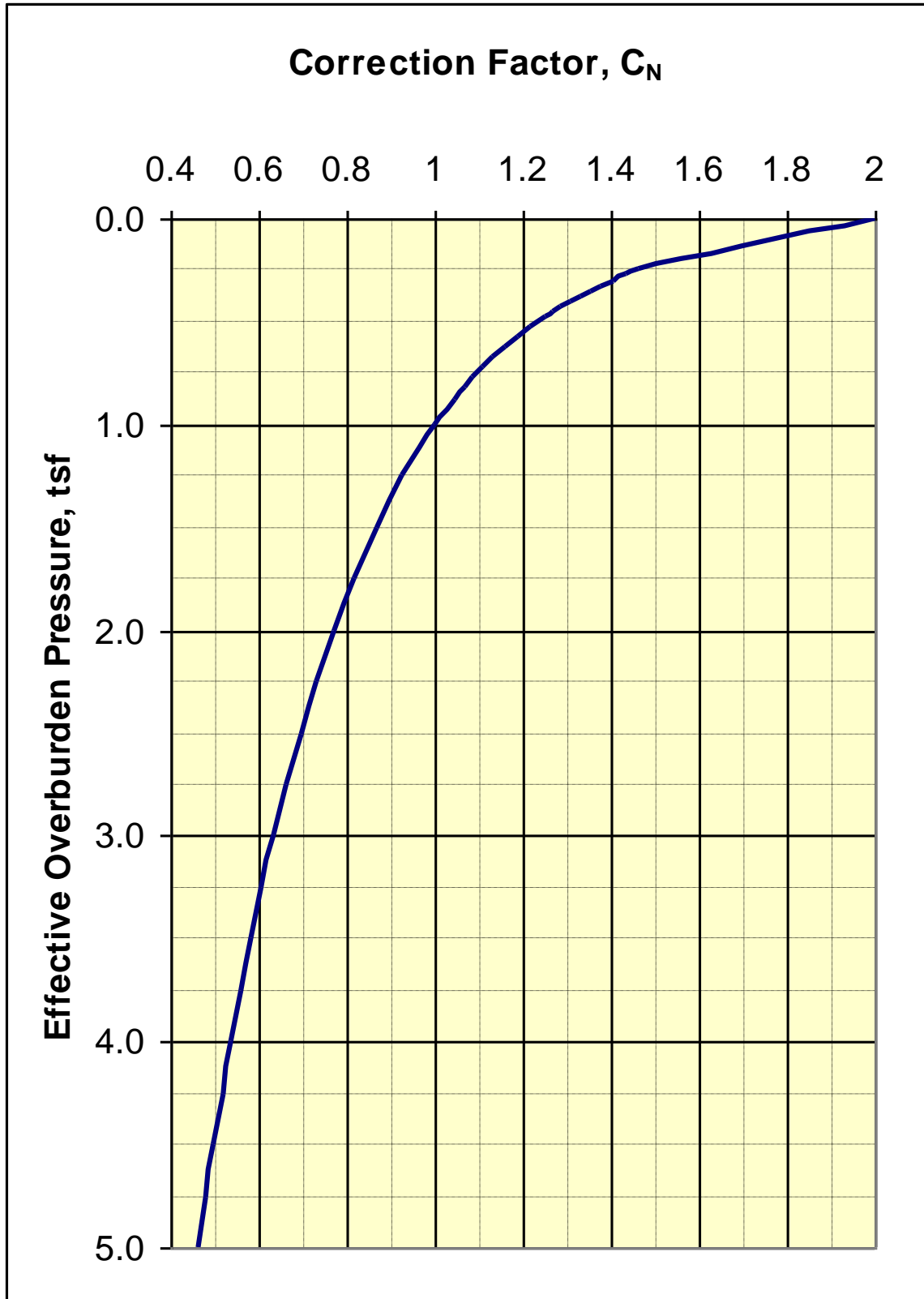

Figure 17, C_N vs. Effective Overburden Pressure (After Peck, 1974)

Criteria for Assigning Group Symbols and Group Names Using Laboratory Tests ^A			Soil Classification		
	Group Symbol	Group Name ^B			
COARSE-GRAINED SOILS More than 50 % retained on No. 200 sieve	Gravels More than 50 % of coarse fraction retained on No. 4 sieve	Clean Gravels Less than 5 % fines ^C	$Cu \geq 4$ and $1 \leq Cc \leq 3^E$	GW	Well-graded gravel ^F
		Gravels with Fines More than 12 % fines ^C	Fines classify as ML or MH	GP	Poorly graded gravel ^F
			Fines classify as CL or CH	GM	Silty gravel ^{F,G,H}
		Clean Sands Less than 5 % fines ^D	$Cu \geq 6$ and $1 \leq Cc \leq 3^E$	GC	Clayey gravel ^{F,G,H}
		Sands with Fines More than 12 % fines ^D	$Cu < 6$ and/or $1 > Cc > 3^E$	SW	Well-graded sand ^I
			Fines classify as ML or MH	SP	Poorly graded sand ^I
			Fines classify as CL or CH	SM	Silty sand ^{G,H,I}
				SC	Clayey sand ^{G,H,I}
		Silts and Clays Liquid limit less than 50	inorganic	CL	Lean clay ^{K,L,M}
			organic	ML	Silt ^{K,L,M}
FINE-GRAINED SOILS 50 % or more passes the No. 200 sieve			Liquid limit – oven dried < 0.75	OL	Organic clay ^{K,L,M,N}
			Liquid limit – not dried		Organic silt ^{K,L,M,O}
		Silts and Clays Liquid limit 50 or more	inorganic	CH	Fat clay ^{K,L,M}
			PI plots on or above "A" line	MH	Elastic silt ^{K,L,M}
HIGHLY ORGANIC SOILS		Primarily organic matter, dark in color, and organic odor	Liquid limit – oven dried < 0.75	OH	Organic clay ^{K,L,M,P}
			Liquid limit – not dried		Organic silt ^{K,L,M,Q}
^A Based on the material passing the 3-in. (75-mm) sieve. ^B If field sample contained cobbles or boulders, or both, add "with cobbles or boulders, or both" to group name. ^C Gravels with 5 to 12 % fines require dual symbols: GW-GM well-graded gravel with silt GW-GC well-graded gravel with clay GP-GM poorly graded gravel with silt GP-GC poorly graded gravel with clay ^D Sands with 5 to 12 % fines require dual symbols: SW-SM well-graded sand with silt SW-SC well-graded sand with clay SP-SM poorly graded sand with silt SP-SC poorly graded sand with clay ^E $Cu = D_{60}/D_{10}$ $Cc = \frac{(D_{30})^2}{D_{10} \times D_{60}}$ ^F If soil contains ≥ 15 % sand, add "with sand" to group name. ^G If fines classify as CL-ML, use dual symbol GC-GM, or SC-SM. ^H If fines are organic, add "with organic fines" to group name. ^I If soil contains ≥ 15 % gravel, add "with gravel" to group name. ^J If Atterberg limits plot in hatched area, soil is a CL-ML, silty clay. ^K If soil contains 15 to 29 % plus No. 200, add "with sand" or "with gravel," whichever is pre-dominant. ^L If soil contains ≥ 30 % plus No. 200, pre-dominantly sand, add "sandy" to group name. ^M If soil contains ≥ 30 % plus No. 200, pre-dominantly gravel, add "gravelly" to group name. ^N $PI \geq 4$ and plots on or above "A" line. ^O $PI < 4$ or plots below "A" line. ^P PI plots on or above "A" line. ^Q PI plots below "A" line.					

Figure 18, Unified Soil Classification System (After ASTM, 1993)

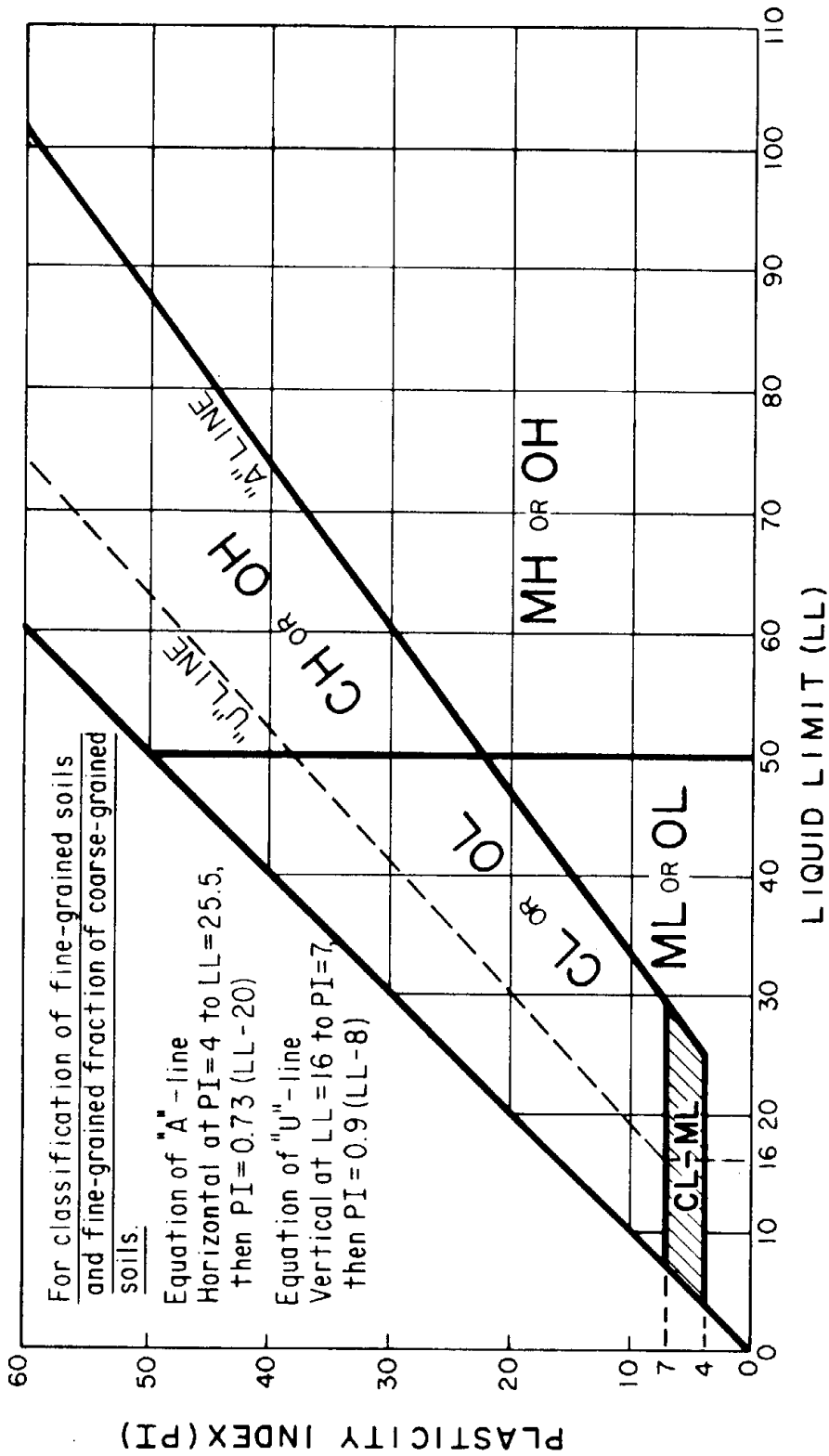
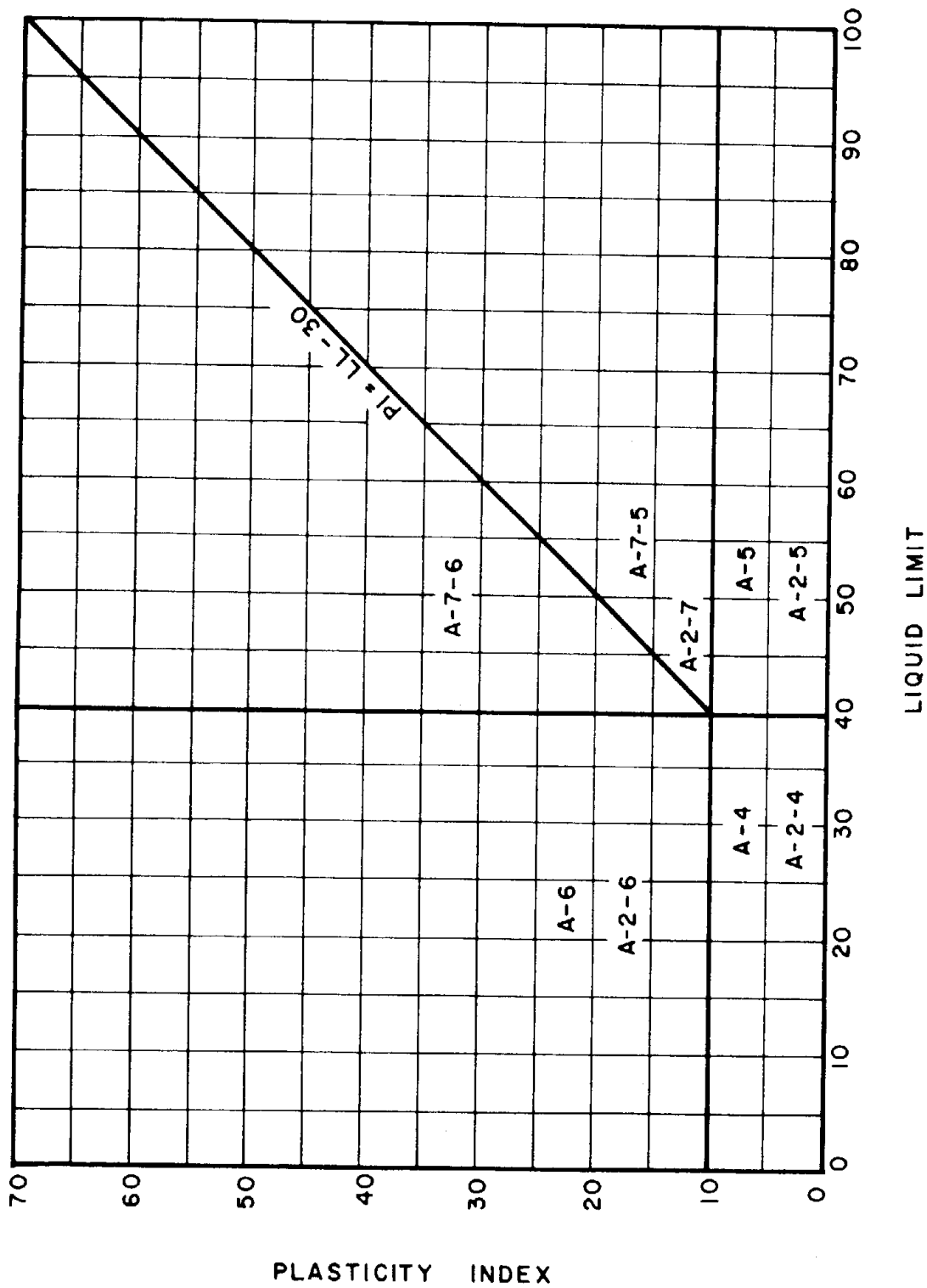

Figure 19, Unified Soil Classification System (After ASTM, 1993)(Cont.)

Classification of Soils and Soil-Aggregate Mixtures							
General Classification	Granular Materials (35 % or less passing No. 200)		Silt-Clay Materials (More than 35 % passing No. 200)				
Group Classification	A-1	A-3 ^A	A-2	A-4	A-5	A-6	A-7
Sieve analysis, % passing:							
No. 10 (2.00 mm)
No. 40 (425 μm)	50 max	51 min
No. 200 (75 μm)	25 max	10 max	35 max	36 min	36 min	36 min	36 min
Characteristics of fraction passing No. 40 (425 μm):							
Liquid limit	^B	40 max	41 min	40 max	41 min
Plasticity index	6 max	N.P.	^B	10 max	10 max	11 min	11 min
General rating as subgrade	Excellent to Good			Fair to Poor			
^A The placing of A-3 before A-2 is necessary in the "left to right elimination process" and does not indicate superiority of A-3 over A-2. ^B See Table 2 for values. Reprinted with permission of American Association of State Highway and Transportation Officials							

Classification of Soils and Soil-Aggregate Mixtures										
General Classification	Granular Materials (35 % or less passing No. 200)					Silt-Clay Materials (More than 35 % passing No. 200)				
Group classification	A-1		A-2		A-3		A-4		A-5	
	A-1-a	A-1-b	A-2-4	A-2-5	A-2-6	A-2-7	A-4	A-5	A-6	A-7
Sieve analysis, % passing:										
No. 10 (2.00 mm)	50 max
No. 40 (425 μm)	30 max	50 max
No. 200 (75 μm)	15 max	25 max	35 max	35 max	35 max	35 max	36 min	36 min	36 min	36 min
Characteristics of fraction passing No. 40 (425 μm):										
Liquid limit	40 max	41 min	40 max	41 min	40 max	41 min	40 max	41 min
Plasticity index	...	6 max	10 max	10 max	11 min	11 min	10 max	10 max	11 min	11 min ^A
Usual types of significant constituent materials	Stone Fragments, Gravel and Sand		Silty or Clayey Gravel and Sand		Silty Soils		Silty Soils		Clayey Soils	
General rating as subgrade	Excellent to Good					Fair to Poor				
^A Plasticity index of A-7-5 subgroup is equal to or less than LL minus 30. Plasticity index of A-7-6 subgroup is greater than LL minus 30 (see Fig. 1). Reprinted with permission of American Association of State Highway and Transportation Officials.										

Figure 20, AASHTO Soil Classification System (After ASTM, 1993)



NOTE—A-2 soils contain less than 35 % finer than 200 sieve.

Figure 21, AASHTO Soil Classification System (After ASTM, 1993) (Cont.)

STATE OF FLORIDA DEPARTMENT OF TRANSPORTATION
FIELD BORING LOG

FORM 675-020-12
MATERIALS - 05/94

SHEET _____ OF _____

PROJECT NO. _____ NAME _____ COUNTY _____ DISTRICT _____
LOCATION _____ TOWNSHIP _____ RANGE _____ SECTION _____
ROAD NUMBER _____ SURFACE ELEVATION _____
EQUIPMENT TYPE _____ RIG NO. _____ BORING NO. _____
DATE STARTED _____ COMPLETED _____ DRILLED BY _____
LOGGED BY _____ BORING TYPE: AUGER, WASHED, PERCUSSION, ROTARY, _____
WATER TABLE: 0 HR. _____ 24 HRS. _____ HRS. _____ CASED, UNCASD, DRILLING MUD, _____

SAMPLE CONDITIONS: DISTURBED GOOD LOST CORE SAMPLE
SAMPLE TYPES: A: AUGER SB: SPLIT BARREL S: SHELBY TUBE RC: ROCK CORE _____ SIZE
TESTS: W.C.: WATER CONTENT (%) T: TORVANE (TSF) V: IN-SITU VANE TEST (TSF)

ELEV. (FT.)	DEPTH (FT.)	S.P.T. BLOWS	MATERIAL DESCRIPTION	SAMPLES			TESTS	REMARKS
				CON.	NO. TYPE	REC. (%)		

RECYCLED PAPER

Figure 22, Field Boring Log Form

STATE OF FLORIDA DEPARTMENT OF TRANSPORTATION
FIELD BORING LOG

FORM 675-020-12
 MATERIALS - 05/94

SHEET 1 OF 1

PROJECT NO. 79100-1523 NAME SR-40 over Tomoka River COUNTY Volusia DISTRICT 5
 LOCATION STA 14+80, 25 ft RT CL Survey TOWNSHIP 14S RANGE 31E SECTION 25
 ROAD NUMBER SR-40 SURFACE ELEVATION +22.6 ft, NGVD
 EQUIPMENT TYPE CME-45, Automatic Hammer RIG NO. 7476 BORING NO. 4
 DATE STARTED 8/27/90 COMPLETED 8/28/90 DRILLED BY Jenkins
 LOGGED BY Dawson BORING TYPE: (AUGER) WASHED, PERCUSSION, ROTARY, _____
 WATER TABLE: 0 HR. 4.2 ft 24 HRS. 4.2 ft HRS. _____ (CASED) UNCASED, DRILLING MUD, To 14.5 ft

SAMPLE CONDITIONS:  DISTURBED GOOD LOST CORE SAMPLE SAMPLE TYPES: A: AUGER SB: SPLIT BARREL S: SHELBY TUBE RC: ROCK CORE NX SIZE TESTS: W.C.: WATER CONTENT (%) T: TORVANE (TSF) V: IN-SITU VANE TEST (TSF)

ELEV. (FT.)	DEPTH (FT.)	S.P.T. BLOWS	MATERIAL DESCRIPTION	SAMPLES			TESTS	REMARKS
				CON.	NO. TYPE	REC. (%)		
22.6								
		2	Light Brown Fine SAND, Poorly Graded, Loose to Compact, Moist to Wet, Sub-Angular (SP)		SB-1	50		
		3						
		5						
		7						
		8		SB-2	60			
17.6	5	0	Dark Brown Sandy SILT, some Wood, Very Loose, Wet, Fibrous (Muck) (ML)		SB-3	20		Advanced 12" Under Weight of Hammer
		1						
		1	Reddish-Brown Silty CLAY, Trace Sand and Shell, Soft to Firm, Wet (CL)		SB-4	80		
		2						
12.6	10				S-1	100	T = 0.4	
		3			SB-5	100		
		4						
		12	Tan LIMESTONE, Highly to Moderately Weathered, Soft		SB-6	40		
7.6	15	16						
		25			RC-1	75		RQD = 38%
								Loss of Water at 17.8 ft
2.6	20	46		SB-7	30			Boring Terminated at 20.5 ft
		50/3"						Backfilled 8/28/90

Figure 23, Typical Boring Log

6.3 References

1. Cheney, Richard S. & Chassie, Ronald G., Soils and Foundations Workshop Manual – Second Edition, FHWA HI-88-009, 1993.
2. NAVFAC DM-7.1-Soil Mechanics, Department of the Navy, Naval Facilities Engineering Command, 1986.
3. Munfakh, George, Arman, Ara, Samtani, Naresh, and Castelli, Raymond, Subsurface Investigations, FHWA-HI-97-021, 1997.

6.4 Specifications and Standards

<u>Subject</u>	<u>ASTM</u>	<u>AASHTO</u>	<u>FM</u>
Standard Classification of Soils for Engineering Purposes (Unified Soil Classification System)	D 2487	-	-
Standard Practice for Description and Identification of Soils (Visual-Manual Procedure)	D 2488	-	-
Standard Classification of Soils and Soil-Aggregate Mixtures for Highway Construction Purposes	D 3282	M 145	-
Standard Guide for Field Logging of Subsurface Explorations of Soil and Rock	D 5434	-	-

Chapter 7

7 Field Instrumentation

7.1 Instrumentation

Field instrumentation can be used on major projects during the analysis and design phase to assist the engineer in refinement of the design. An instrumented test embankment constructed during the preliminary stages of a project to assist in settlement prediction is an example.

On projects where analysis has indicated potential problems with embankment or structure settlement or stability, construction must be monitored through the use of field instrumentation. The location of such instrumentation should be included in the foundation design. This instrumentation allows the engineer to assess the settlement rate and evaluate stability as construction proceeds. The installation of this instrumentation and the interpretation of the ensuing data should be made by the Geotechnical Engineer in consultation with the construction engineer. Also included in the design package should be special provisions and the hold points, time or limitations of construction (for example, fill shall halt until settlement is less than 1 inch per 24 hours, etc.) needs to be indicated for the contractor. Many of the special provisions are available from the District or State Geotechnical Engineers.

Additionally, field instrumentation can be installed to provide data on existing structures or embankments. For example, slope indicators placed within an unstable area of an existing slope can provide the engineer with information, which is valuable in assessing the cause of the problem and in designing the necessary remedial measures.

Many of the instruments described in this chapter involve equipment such as inclinometer casing, settlement platform risers, or junction boxes, which protrude above ground in the construction area. These protuberances are particularly susceptible to damage from construction equipment. The Geotechnical Engineer must work with the construction engineer to ensure that the contractor understands the importance of these instruments and the need to protect them. The special provisions should carry penalties attached to them for the negligent damage to these instruments occurring during construction.

The most commonly used types of instrumentation are discussed below (Reference 2 and 4 is recommended for more detail):

7.1.1 Inclinometers (Slope Indicators)

These instruments are used to monitor embankment or cut slope stability. An inclinometer casing consists of a grooved metal or plastic tube that is installed in a borehole. The bottom of the tube must be in rock or dense material, which will not experience any movement, thereby achieving a stable point of fixity. A sensing probe is lowered down the tube and deflection of the tube is measured. Successive readings can be plotted to provide the engineer with information about the rate of subsurface movement with depth (see [Figure 24](#)). Refer to ASTM D 6230.

Care must be taken when installing the casing so that spiraling of the casing does not occur because of poor installation techniques. This will result in the orientation of the grooves at depth being different than at the surface. This can be checked with a spiral-checking sensor, and the data adjusted with most new computerized data reduction routines. Also, the space between the borehole wall and the casing should be backfilled with a firm grout, sand, or gravel. For installation in highly compressible soils, use of telescoping couplings should be used to prevent damage of the casing.

To monitor embankment construction, inclinometers should be placed at or near the toes of slopes of high-fill embankments where slope stability or lateral squeeze is considered a potential problem. The casing should penetrate the strata in which problems are anticipated. Readings should be taken often during embankment construction. Fill operations should be halted if any sudden increase in movement rate is detected. The applicable portions of the technical special provision [T120, T141, T144, T442: Instrumented Surcharge Embankment with Wick Drains](#) should be modified for site conditions, other usable pore-pressure transducer types and instruments, and included in the contract package.

7.1.2 Settlement Indicators

Settlement instruments simply record the amount and rate of the settlement under a load; they are most commonly used on projects with high fill embankments where significant settlement is predicted. The simplest form is the settlement platform or plate, which consists of a square wooden platform or steel plate placed on the existing ground surface prior to embankment construction. A reference rod and protecting pipe are attached to the platform. As fill operations progress, additional rods and pipes are added. (See [Figure 25](#) or [Standard Plans, Index 141-T01](#)). Settlement is evaluated by periodically measuring the elevation of the top of the reference rod. Benchmarks used for reference datum shall be known to be stable and remote from all possible vertical movement. It is recommended to use multiple benchmarks and to survey between them at regular intervals.

Settlement platforms should be placed at those points under the embankment where maximum settlement is predicted. On large jobs two or more per embankment are common. The platform elevation must be recorded before embankment construction begins. This is imperative, as all future readings will be compared with the initial reading. Readings thereafter should be taken periodically until the embankment and surcharge (if any) are completed, then at a reduced frequency. The settlement data should be plotted as a function of time. The Geotechnical Engineer should analyze this data to determine when the rate of settlement has slowed sufficiently for construction to continue. The technical special provision [141 Settlement Plates](#) should be modified for site conditions and included in the contract package.

A disadvantage to the use of settlement platforms is the potential for damage to the marker pipe by construction equipment. Also, care must be taken in choosing a stable survey reference which will not be subject to settlement. If

the reference is underlain by muck, other soft soils or, is too close to construction activities, it may also settle with time.

Alternatives to settlement plates include borehole installed probe extensometers and spider magnets in which a probe lowered down a compressible pipe can identify points along the pipe either mechanically or electrically, and thereby, the distance between these points can be determined. Surveying at the top of the pipe needs to be performed to get absolute elevations if the pipe is not seated into an incompressible soil layer. This method allows a settlement profile within the compressible soil layer to be obtained. Care must be taken during installation and grouting the pipe in the borehole so that it is allowed to settle in the same fashion as the surrounding soil.

7.1.3 Piezometers

Piezometers are used to measure the amount of water pressure within the saturated pores of a specific zone of soil. The critical levels to which the excess pore pressure will increase prior to failure can be estimated during design. During construction, the piezometers are used to monitor the pore water pressure buildup. After construction, the dissipation of the excess pore water pressure over time is used as a guide to consolidation rate. Thus, piezometers can be used to control the rate of fill placement during embankment construction over soft soils.

The simplest type of piezometer is an open standpipe extending through the fill, but its use may be limited by the response time lag inherent in all open standpipe piezometers. More useful and common in Florida are the vibrating wire and the pneumatic piezometers. Pneumatic piezometers consist of a sensor body with a flexible diaphragm attached. This sensor is installed in the ground and attached to a junction box with twin tubes. The junction box outlet can be connected to a readout unit. Pressurized gas is applied to the inlet tube. As the applied gas pressure equals and then exceeds the pore water pressure, the diaphragm deflects allowing gas to vent through the outlet tube. The gas supply is then turned off and the diaphragm returns to its original position when the pressure in the inlet tube equals the pore water pressure. This pressure is recorded (see [Figure 26](#)). Refer to AASHTO T 252. Vibrating wire piezometers are read directly by the readout unit. Electrical resistance piezometers are also available; however, the use of electrical resistance piezometers is generally limited to applications where dynamic responses are to be measured.

Piezometers should be placed prior to construction in the strata in which problems are most likely to develop. If the problem stratum is more than 10 feet (3 m) thick, more than one piezometer should be placed, at varying depths. The junction box should be located at a convenient location but outside the construction area if possible, however, the wire leads or pneumatic tubing need to be protected from excessive strain due to settlements.

The pore water pressure should be checked often during embankment construction. After the fill is in place, it can be monitored at a decreasing frequency. The data should be plotted (as pressure or feet (meters) of head) as a function of time. A good practice is to plot pore water pressure, settlement, and

embankment elevation on the same time-scale plot for comparison. The technical special provision [T144: Pore-Pressure Transducers \(Piezometers\)](#) should be modified for site conditions and included in the contract package.

7.1.4 Tiltmeters

Tiltmeters measure the inclination of discrete parts of structures from the norm. They are most commonly used to monitor tilting of bridge abutments and decks or retaining walls, and can also be used to monitor rotational failure surfaces in landslides. Types range from a simple plumb line to more sophisticated equipment.

7.1.5 Monitoring Wells

A monitoring or observation well is used to monitor groundwater levels or to provide ready access for sampling to detect groundwater contamination. It consists of a perforated section of pipe or well point attached to a riser pipe, installed in a sand-filled borehole.

Monitoring wells should also be installed in conjunction with piezometers to provide a base reference necessary for calculating changes in pore pressure. The monitoring well should be placed in an unimpacted area of construction to reflect the true static water table elevation. Installation and decommissioning of monitoring wells shall be in accordance with local DEP and Water Management District rules and regulations.

7.1.6 Vibration Monitoring

It is sometimes desirable to monitor the ground vibrations induced by blasting, pile driving, construction equipment, or traffic. This is especially critical when construction is in close proximity to sensitive structures or equipment, which may become damaged if subjected to excessive vibration.

A vibration-monitoring unit typically consists of a recording control unit, one or more geophones, and connecting cables. Sensors to detect noise levels are also available. Geophones and/or noise sensors are placed at locations where data on vibration levels is desired. Peak particle velocities, principle frequencies, peak noise pressure levels, and actual waveforms can be recorded. Results are compared with pre-established vibration-limiting criteria, which are based on structure conditions, equipment sensitivity, or human tolerance.

7.1.7 Special Instrumentation

Earth pressure cells and strain gauges fall into this category of special instruments. They are not normally used in monitoring construction projects but only in research and special projects. These instruments require experienced personnel to install and interpret the data. Consult the State Materials Office for assistance.

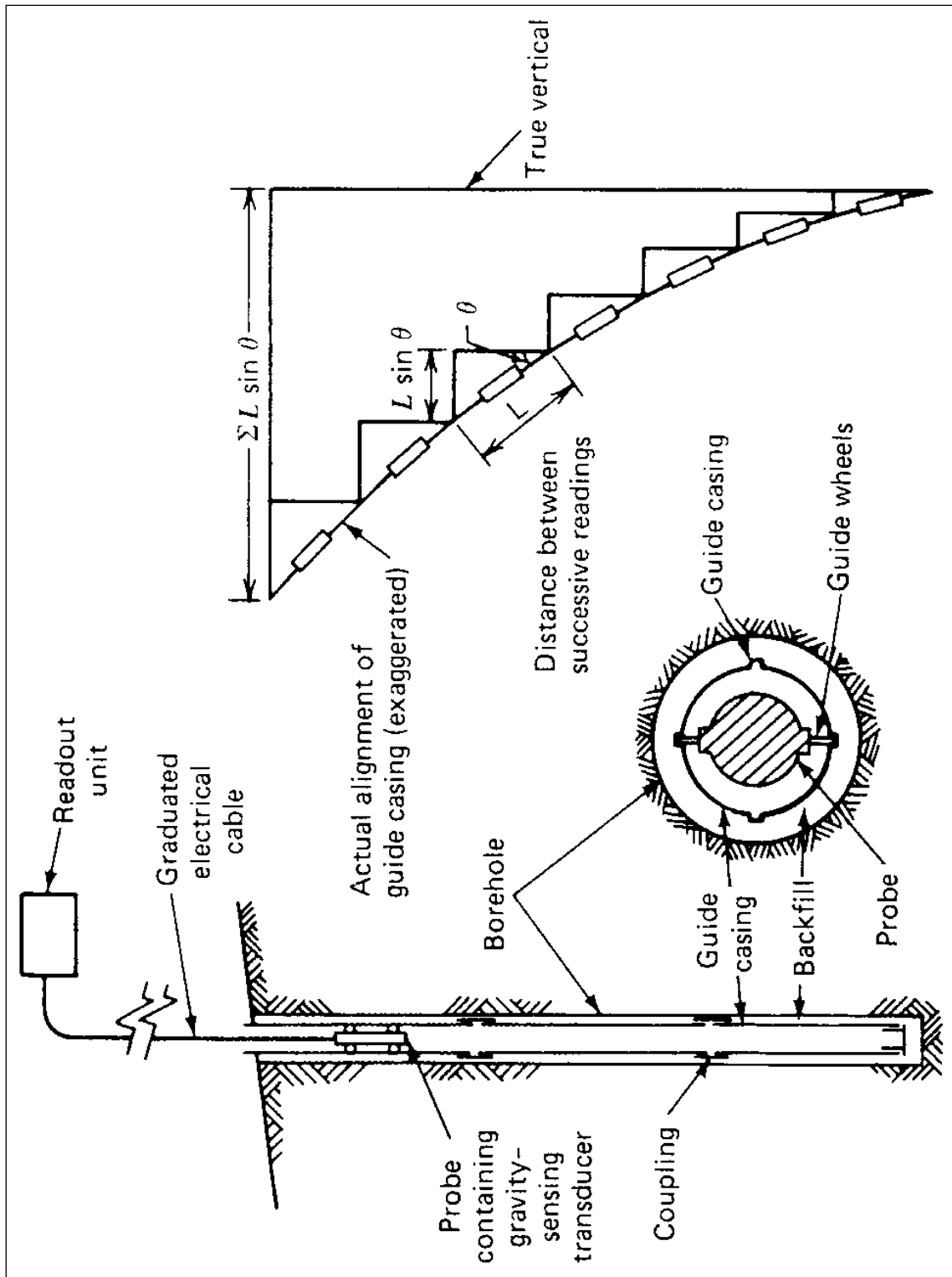

Figure 24, Principle of Inclinometer Operation (After Dunncliff, 1988)

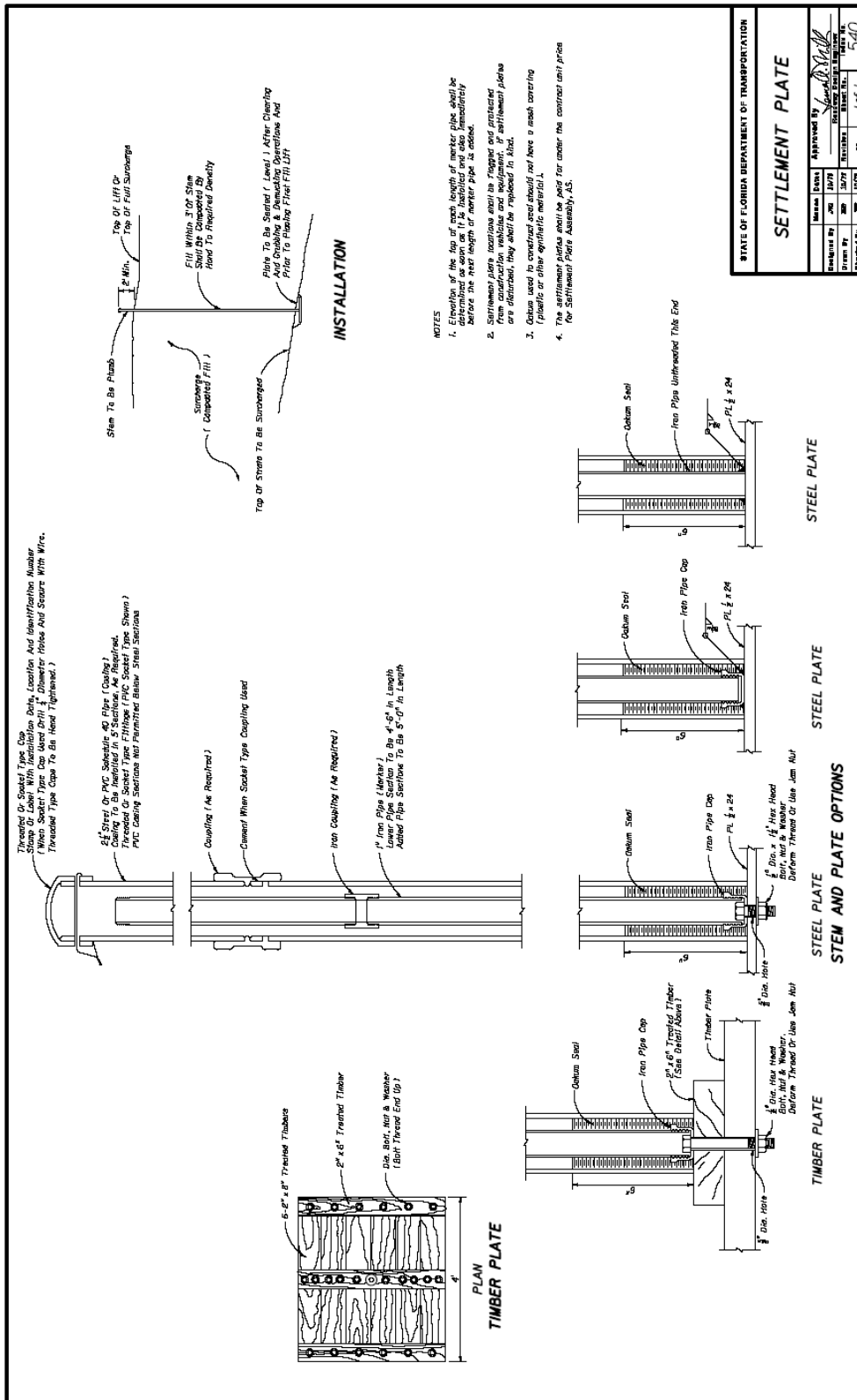

Figure 25, Typical Settlement Platform Design (Standard Plans, Index 141-T01)

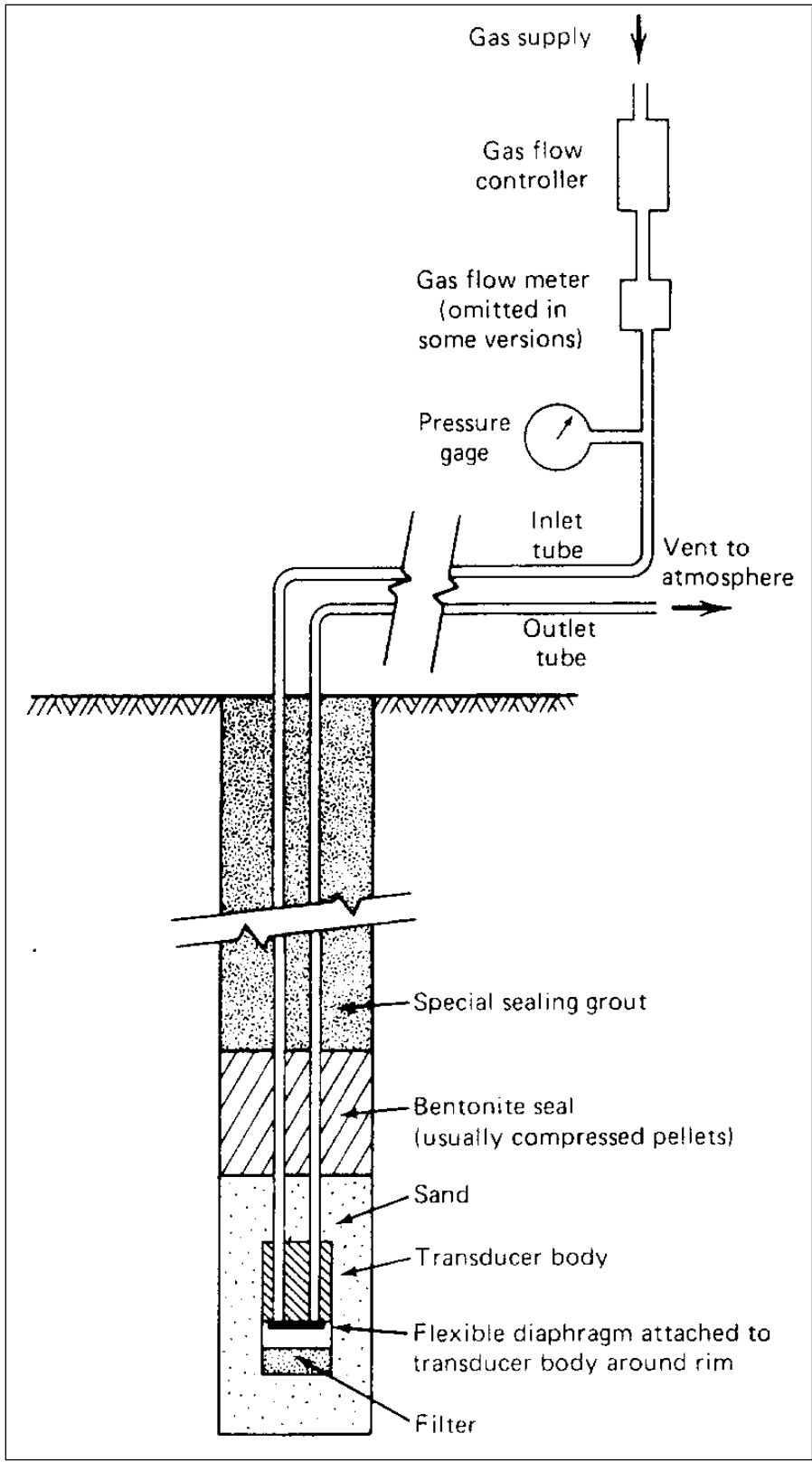

Figure 26, Example Pneumatic Pore Pressure Transducer

7.2 References

1. Cheney, Richard S. & Chassie, Ronald G., Soils and Foundations Workshop Manual – Second Edition, FHWA HI-88-009, 1993.
2. Dunicliff, John, Geotechnical Instrumentation for Monitoring Field Performance, Wiley-Interscience, New York, 1993.
3. Standard Plans for Road and Bridge Construction, Florida Department of Transportation, (Current version).
4. Dunicliff, John, Geotechnical Instrumentation, FHWA-HI-98-034, 1998.

7.3 Specifications and Standards

<u>Subject</u>	<u>ASTM</u>	<u>AASHTO</u>	<u>FM</u>	<u>STD. INDEX</u>
Settlement Platform	-	-	-	540/141-T01
Standard Test Method for Measurements of Pore Pressures in Soils	-	T 252	-	-
Standard Test Method for Monitoring Ground Movement Using Probe-Type Inclinedometers	D 6230	-	-	-

Chapter 8

8 Analysis and Design

Once all exploration and testing have been completed, the Geotechnical Engineer must organize and analyze all existing data and provide design recommendations. The scope of the analysis will of course depend upon the scope of the project and the soils involved.

This chapter will discuss the major factors, which must be considered during the analysis and design phase and possible methods of solving potential problems. [Table 2](#) and [Table 3](#) present FHWA guidelines regarding analyses which should be performed. The references cited in the text provide suggested methods of analysis and design. A list of computer programs, which are approved for use by the Department to aid analysis, is available on the [Geotechnical Engineering webpage](#).

8.1 Roadway Embankment Materials

The suitability of in-situ materials for use as roadway embankment is determined by analysis of the results of soil survey explorations. Embankment materials must comply with Standard Plans, Index 120-001.

The subsurface materials identified during soil survey explorations should be classified, usually according to the AASHTO classification system, and stratified. Soils must be stratified such that similar soils are contained within the same stratum. Stratifications shall be based upon the material removal and utilization requirements of Standard Plans, Indexes 120-002 & 120-001. If testing identifies dissimilar types within the same stratum, additional sampling and testing may be required to better define or re-stratify the in-situ materials.

Once stratified, each stratum must be analyzed to define characteristics that may affect the design. Such characteristics include:

8.1.1 Limits of Unsuitable Materials

The limits of all in-situ materials considered unsuitable for pavement embankments should be defined and the effect of each material on roadway performance should be assessed. Refer to Standard Plans, Index 120-002 for requirements on excavation and replacement of these materials. In areas where complete excavation is not feasible but the potential for problems exists, possible solutions to be considered include stabilization with lime, cement, or flyash, placement of geotextile, surcharging, and combinations of these and other methods.

8.1.2 Limerock Bearing Ratio (LBR) (When Allowed)

When LBR testing is permitted by the State Materials Office for design purposes, the LBR value should be determined based on test results and the stratification of subsurface materials. The design value should be representative of actual field conditions. Two methods are applied to the LBR test data to account for variability in materials, moisture contents and field versus laboratory

conditions. The design LBR is the lower of the values determined by each of the following two methods:

8.1.2.1 $\pm 2\%$ of Optimum Method

The LBR values corresponding to moisture contents 2% above and 2% below the moisture content of the maximum LBR value (Refer to [Table 4](#)). The average of these values is the design LBR value from this method. It may be substantially lower than the average of the maximum LBRs.

8.1.2.2 90% Method

Maximum LBR values are sorted into ascending or descending order. For each value, the percentage of values, which are equal to or greater than that value, is calculated. These percentages are plotted versus the maximum LBR values. The LBR value corresponding to 90% is used as the design value from this method (Refer to. Thus, 90% of the individual tests results are equal to or greater than the design value derived from this method.

8.1.3 Resilient Modulus (M_R)

Determine the resilient modulus directly from laboratory testing (AASHTO T 307). For roadway embankment materials, a design resilient modulus shall be chosen based on test results at 11 psi bulk stress and the stratification of subsurface materials. The design value should be representative of actual field conditions.

The following method is applied to the M_R test data to account for variability in materials and to provide for an optimum pavement design (Reference 28):

90% M_R Method

Resilient modulus values using AASHTO T 307 at 11 psi bulk stress are sorted into descending order. For each value, the percentage of values, which are equal to or greater than that value, is calculated. These percentages are plotted versus the M_R values. The M_R value corresponding to 90% is used as the design value. Thus, 90% of the individual tests result are equal to or greater than the design value.

8.1.4 Corrosivity

Results of field and/or laboratory tests should be reviewed and the potential for corrosion of the various structure foundation and drainage system components should be assessed.

8.1.5 Drainage

The permeability and infiltration rate of the embankment materials should be estimated based on test results or knowledge of the material characteristics. This data, along with data on the depth to groundwater, can then be used in assessing the need for and in designing drainage systems, including pavement underdrains and retention, detention, and infiltration ponds.

8.1.6 Earthwork Factors

Truck and fill adjustment factors used in estimating earthwork quantities should be estimated based on local experience. See **Borrow Excavation (Truck Measure)** in the **FDOT Design Manual (FDM)** for example calculations using these factors

8.1.7 Other Considerations

Other characteristics which can be detected from soil survey explorations and which can affect the roadway design include expansive soils, springs, sinkholes (References 36 & 40 provide helpful insights into Florida sinkhole issues), potential grading problems due to the presence of rock, etc. The effect of these characteristics on roadway performance should be assessed.

8.2 Foundation Types

As an absolute minimum for Design-Bid-Build projects, GRS abutments, spread footings, driven piles and drilled shafts should be considered as potential foundation types for each bridge structure. For noise barrier walls, auger-cast piles may be the preferred foundation. On some projects, one or more of these alternatives will be obviously not feasible for the subsurface conditions present. Analysis of design capacity should be based on SPT and/or cone penetrometer results, laboratory and/or in-situ strength tests, consolidation tests, and the results of instrumentation programs, if available. Consider the need for additional field tests based on the variability of the conditions observed.

Analyze all foundations in accordance with the latest requirements of the *AASHTO LRFD Bridge Design Specifications* except where specific requirements have been superseded by the Structures Design Guidelines or those contained herein. Particular attention shall be paid to deflections in the service limit state, especially for drilled shafts where large deflections may be required to satisfy the strength limit state.

8.2.1 Spread Footings

The use of spread footings is generally controlled by the depth to material of adequate bearing capacity and the potential for settlement of footings placed at this depth.

8.2.1.1 Design Procedure

References 3, 5, and 22 offer good methods. Provide the minimum foundation elevation and the anticipated bearing material. Estimate settlements, including the amount of total settlement, rate of settlement, and the potential for differential settlement.

For spread footings on rock or IGM, ensure against punching failure into the weaker stratum below the bearing stratum (See 8.3.1 Rock Fracture). Evaluate the effect of excavation aids such as continuous sheet pile which could compromise the continuity of the bearing layer (See 8.3.6).

8.2.1.2 Considerations

Varying depths of footings should be considered to achieve maximum economy of design. For water crossings, depth of scour will be a controlling factor, which may preclude consideration of spread footings. Difficult conditions for dewatering and preparation of foundation soils shall be addressed when applicable. Ground improvement methods which permit the use of spread footings in otherwise marginal cases (grouting, vibratory compaction, etc.) may be considered where their use might be more economical than deep foundations.

8.2.2 Driven Piles

Driven piles must be designed for axial and lateral loading conditions as applicable. The following types of driven piles are considered acceptable for supporting structural loads on permanent FDOT structures (depending on environmental restrictions): Steel H-piles, Steel Pipe Piles, Prestressed Concrete Piles 18" square and larger, and Concrete Cylinder Piles of 54" or 60" diameter. 14" square Prestressed Concrete Piles may be used for pedestrian bridges if there are no environmental restrictions. Timber piles may be used for temporary bridges, however, steel piles are chosen more often by contractors. Other pile types and sizes may be considered for design-build projects and contractor's Cost Savings Initiative (CSI) submittals.

8.2.2.1 Design Procedure

The following computer programs are available the [Bridge Software Institute](#) (BSI):

- FB-Deep is available for assessment of axial design capacity
- FB-Pier is available for assessment of lateral design capacity and pile group settlement
- GeoStat is available for the evaluation of site variability

The Help Files for the FB-Deep, FB-Pier and GeoStat programs are recommended references. Include all materials within 3B of the individual pile tip or 2 times the minimum group dimension below the tip of the piles, whichever is deeper.

For foundations tipped on rock or IGM, ensure the bearing layer thickness below the tip elevation is sufficient to prevent punching failure into the weaker stratum below the bearing stratum for the end bearing resistance included in the design ([See 8.3.1 Rock Fracture](#)). Address pile group effects, settlement and downdrag as applicable. References 5, 6, 7 & 30 are recommended for analyzing group effects and settlement potential. See Appendix C for a step by step design procedure for the analysis of downdrag.

8.2.2.2 Considerations

Various pile types and sizes should be analyzed to achieve an optimum design. For water crossings, depth of scour must be considered for both axial

and lateral load analyses. Test pile locations should be recommended and the need for static and/or dynamic testing addressed. Consider the drivability of the piles. See the Structures Design Guidelines for load limits for driving of different pile sizes. In FB-Deep and GeoStat analyses, code sand layers containing 30% (“Some” by ASTM D-2488) or greater quantities of shell as soil type 4.

On FDOT projects, steel pipe piles are normally driven closed end. In extremely aggressive conditions they may be used only if filled with a cast-in-place concrete core in accordance with SDG 3.1.F.2 (See SDG 3.1.F & SDG Table 3.1-1 for additional information).

8.2.3 Drilled Shafts

Drilled shafts derive their resistance from direct contact between the surrounding soil and the drilled shaft concrete. As with driven piles, drilled shafts must be designed considering both axial and lateral loads.

8.2.3.1 Design Procedure for Major Structures

Resistance factors and associated design methods for geotechnical resistance of drilled shafts are in SDG Table 3.6.3-1. It is implicitly shown in the table that the resistance factors for drilled shafts tipped in sand or clay are based on side shear design methods only (i.e. FHWA alpha method in clay and FHWA beta method in sand). Note also that the beta method for side shear resistance in sand refers to the method developed by O’Neil & Reese (Ref 9), not the beta method described in FHWA’s GEC 10.

Because tip movements on the order of several inches are generally required to mobilize tip resistance in sand or clay, methods to pre-mobilize tip resistance must be incorporated to include tip resistance in these materials. Methods to pre-mobilize tip resistance include: pressure grouted tips, rim cell devices and bi-directional load test jacks.

Reference 9 is generally applicable to all conditions except for drilled shafts socketed in Florida limestone. Refer to Appendix A for an approved method of determining the side resistance for drilled shafts socketed in Florida limestone. The normal spacing for drilled shafts is 3D. For rock socketed drilled shaft groups with spacing of 2.5D or greater, a group efficiency factor of 1 may be used for axial loads; for shafts tipped in other materials refer to the current AASHTO LRFD Bridge Design Specification. P-y multipliers for lateral loads are in the Structures Design Guidelines. General foundation analysis considerations are further described below.

The following computer programs are available the [Bridge Software Institute](#) (BSI):

- FB-Deep is available for assessment of axial design capacity
- FB-Pier is available for assessment of lateral design capacity and shaft group settlement
- GeoStat is available for the evaluation of site variability and minimum number of laboratory tests required to develop side shear design correlations

The Help Files for the FB-Deep, FB-Pier and GeoStat programs are recommended references.

Nonredundant drilled shaft bridge foundations have special design requirements as follows:

1. All shafts in nonredundant bridge foundations shall be a minimum of four feet in diameter.
2. Consider the effects of combined axial loads and moment to properly evaluate the geotechnical bearing resistance of the shaft and the effect on the distribution of the stresses across the shaft bottom. There is often sufficient horizontal reaction to resist moments in shafts embedded at least seven shaft diameters below the design ground surface.

Various drilled shaft sizes should be analyzed to achieve an optimum design. For water crossings, depth of scour must be considered. Any anticipated construction problems should be considered. The method of construction (dry, slurry, or casing) should be addressed, as this will affect the side friction and end bearing values assumed during design. Both the unit side friction and mobilized end bearing values should be analyzed and presented. References 6, 7 & 30 are recommended for analyzing group effects. See Appendix C for a step by step design procedure for the analysis of downdrag. For foundations tipped on rock or IGM, ensure the bearing layer thickness below the tip elevation is sufficient to prevent punching failure into the weaker stratum below the bearing stratum for the end bearing resistance included in the design ([See 8.3.1 Rock Fracture](#)).

Prudent design considers that estimated side shear resistance requires sufficient surface area of the shaft to interact with the socket. Design values are based on statistical techniques; some portions of the rock are likely weaker than others due to normal geologic variability. Furthermore, undetected construction flaws could reduce load transfer. Therefore, the minimum rock socket length shall be 8 feet or 1.5 times the shaft diameter, whichever is longer. When the total socket length must be broken into layers, each layer should be at least one shaft diameter.

8.2.3.2 Considerations

When estimating drilled shaft resistance from side shear and end bearing (for shafts tipped in rock or IGM), ensure the resistance limits the end bearing to 1/3 of the ultimate value.

In sand, drilled shafts with pressure grouted tips should be considered. Pressure grouted tips are most effective in loose to medium dense sands. Guidance for the design of drilled shafts with pressure grouted tips may be found in Appendix D and in Reference 9.

Load tests on test shafts should be specified when necessary to verify capacity and/or constructability. Reinforced method shafts (test holes) are always required for bridges, and their locations shall be specified in the plans. Load tests should not be performed on method shafts. Method shafts should be the depth of the deepest shafts on the project, whereas the load test shafts should verify the resistance of the most economical bearing zone. Refer to the Structures Design Guidelines for additional considerations.

Drilled shafts may be constructed using temporary or permanent casing, however, the drilled shaft design methods are applicable only for computing the resistance of the uncased portions of the shaft. Portions of the shaft constructed with temporary casing will most commonly have reduced side shear resistance versus constructing the same portion of the shaft using slurry.

All resistance must be strain compatible. Peak side shear in rock will normally occur well before peak side shear in soil. The difference in the deformation required to mobilize skin friction in soil and rock versus what is required to mobilize end bearing shall be considered when estimating axial compressive resistance of shafts embedded in rock. (See References 9 and 30)

Verify the bearing strata will support the drilled shaft(s) without the risk of punching shear failure.

8.2.3.3 Design Procedure for Miscellaneous Structures

Drilled shafts for miscellaneous structures must be designed considering both axial and lateral loads, however the design for lateral loads will normally govern. The controlling loading condition for miscellaneous structures is normally due to wind loading during the design storm event after several days of continuous rain would have occurred. Therefore, the design groundwater level is normally at the ground surface. When drilled shafts for miscellaneous structures will be founded in limestone, the guidelines in Appendix B for rock may be used. An example lateral load analysis using Broms' Method for a cable barrier end terminal is presented in Appendix G.

When laterally loaded drilled shafts for miscellaneous structures are founded through compacted select fill berm or slope, include the portion of the pile with less than 2.5D horizontal soil cover (face-of-pile to face-of-slope) in the unsupported length, and design the portion of the pile with more than 2.5D soil cover as though founded in level ground.

When borings indicate water levels will not be encountered during drilled shaft construction, add the following note to the Plans:

- The Dry Method of drilled shaft construction may be appropriate for this foundation.

8.2.4 Auger-Cast Piles

As with driven piles and drilled shafts, auger-cast piles must be designed considering both axial and lateral loads. However, lateral loads typically govern when auger-cast-piles are used for noise wall foundations. See the SDG for restrictions on the use of Auger Cast Piles for bridges and other structures.

8.2.4.1 Design Procedure

Design Auger Cast Piles for Bridges (when allowed) using the same design procedures as for side shear resistance of drilled shafts. For side shear resistance of rock or cohesive IGM materials, use the design procedures outlined in Appendix A. Unit side shear values for all foundations must be strain compatible; this is particularly important for auger cast pile bridge foundations. Therefore, for design of rock or IGM socketed auger cast piles supporting bridges, the side shear resistance from the overburden soil is neglected unless strain compatible values are determined by site specific load tests.

Generic designs for noise barrier wall foundations on level ground are presented in the [Standard Plans for Road and Bridge Construction](#). When walls are founded through compacted select fill berm, include the portion of the pile with less than 2.5D horizontal soil cover (face-of-pile to face-of-slope) in the unsupported length, and design the portion of the pile with more than 2.5D soil cover as though founded in level ground.

If the site specific soil conditions are weaker than the values presented in the Standard Plans Instructions (SPI) or if a site specific design is desired, auger-cast piles shall be designed in accordance with the procedure outlined in Appendix B. Consult with the District Geotechnical Engineer for local guidelines regarding auger-cast piles.

8.2.4.2 Considerations

Considerations for auger-cast piles supporting precast noise walls are presented in the Standard Plans Instructions, Index [534-200](#).

8.2.5 Micro Piles

In special cases micro piles may be the preferred foundation system. This would typically be in cases of limited access, close proximity to settlement sensitive structures and foundations to be strengthened. See the SDG for restrictions on the use of micropiles for bridges and other structures.

8.2.5.1 Design Procedure

Designs must comply with Section 10.9 of Reference 30, however, all side shear resistance in the casing plunge length shall be disregarded. References 26

and 30 are recommended for background information. Static Load Tests are required to verify the design.

8.2.6 GRS Abutments

GRS abutments are part of FHWA's Every Day Counts (EDC) initiative to reduce bridge construction time and cost. Bridge projects constructed using this technology were considered cost effective, are performing well, and the lessons learned during those projects led to the GRS Guide (Reference 34). GRS abutments are permitted for simply supported spans as described in the Structures Manual; for additional background, see References 34 and 35.

8.2.6.1 Design Procedure

Designs must comply with Appendix C of Reference 34, except as otherwise indicated in Sections 3.12.12 and 3.13.4 of the Structures Design Guidelines.

Present GRS abutments in the Plans. The Plans may or may not utilize [Developmental Standard Plans, Index D6025](#), however, the same information needs to be presented. GRS abutments shall be constructed using [Developmental Specification 549](#). The District Specifications Office needs to file the request for Developmental Specification 549 to be incorporated into the specifications package.

8.2.6.2 Considerations

Limitations and considerations are presented in Sections 3.12.12 and 3.13.4 of the Structures Design Guidelines, and in the Instructions for [Developmental Standard Plans, Index D6025](#).

8.3 Foundation Analysis

Along with an axial analysis (as outlined in the previous section) for deep foundations, the following factors must also be addressed in the geotechnical report

8.3.1 Rock Fracture

For shallow foundations and the end bearing component of deep foundations supported on layered profiles where limestone or IGM bearing materials are underlain by weaker materials such as those depicted in [Figure 28](#), ensure the bearing layer thickness below the bearing elevation is sufficient to prevent punching failure into a weaker stratum below the bearing stratum. Perform this check as part of the bearing analysis for the strength limit state. For spread footings use a trapezoidal pressure distribution.

Because the RMR (Rock Mass Rating) & GSI (Geological Strength Index) methods in AASHTO are unreliable for nearly all Florida limestone and IGM materials, estimate the shear resistance within the limestone and IGM lenses using the method outlined in Appendix A for determining "f_s." The sample set may be limited to the borings closest to each foundation in order to best estimate the bearing conditions.

Commentary: The McVay method applied in Appendix A is based on the shaft socket interface being sufficiently rough that the failure surface is entirely within the rock or IGM in which the shaft is socketed. Therefore f_s is the rock shear strength. For details see Reference 37. See Reference 41 for a discussion of the applicability of RMR & GSI to Florida limestone.

When the limestone/IGM material has not been cored and tested, the shear resistance of the material below the tip elevation may be estimated using Standard Penetration Test (SPT) blow count using the following equation:

$$q_{frac} = 0.1 \text{ tsf} * N_{60} \leq 5 \text{ tsf}$$

where N_{60} is the corrected (for energy) SPT blow count.

The resistance factor, ϕ , for this check is taken from the Table 3.6.3-1 of the Structures Design Guidelines (SDG) as appropriate for redundant or nonredundant drilled shafts. For piles, use the resistance factor for redundant shafts including end bearing from Table 3.6.3-1 of the SDG. For spread footings, use the resistance factors in AASHTO Table 10.5.5.2.2-1

8.3.2 Lateral Loads

Lateral load analyses for deep foundations shall be performed on all retaining structures and almost all bridges permitting navigation. The Structural Engineer using soil parameters provided by the Geotechnical Engineer shall perform the analyses for bridges. The Geotechnical Engineer shall check the final lateral load analysis for correct soil property application. The associated minimum tip elevations requirement (elevation where structure stability is achieved plus 5 feet) must be reviewed. Designs may need to be changed if lateral deflection is excessive. Reference 10 is recommended.

8.3.3 Scour

For structures over water, scour susceptibility may control the design. Design for scour requires coordination of efforts between the Hydraulics Engineer, Geotechnical Engineer, and the Structures Engineer. This multi-discipline effort, which is needed for the proper iterative procedure used for scour design, is described in the FDOT Structures Design Guidelines.

8.3.4 Downdrag

For piles driven through a soil layer(s) subject to consolidation, a load transfer (negative skin friction) occurs due to the consolidating soil settling around the pile. The downward forces created by this process are known as downdrag. The results of downdrag can be either excessive settlements or overstressing the pile if it is an end bearing pile.

To minimize the downdrag forces: (a) place the embankment fill and allow the compressible soil(s) to consolidate prior to driving, or (b) use a polyethylene wrap around the pile within the embankment fill placed after driving, or (c) bitumen coatings may be used to reduce the load transferred by the adjacent soil(s), but a means for protecting this coating during driving must be used. The Geotechnical Engineer shall provide the downdrag values along with

recommended methods to reduce the effect of downdrag. See [Appendix C](#) or Reference 32 for a step by step design procedure for the analysis of downdrag.

8.3.5 Construction Requirements

This would identify any project specific requirements that may be required for constructability. This would include items like preforming, jetting, vibration monitoring artesian water, etc. It would also identify any nearby structures and occupants usages that would be impacted from the installation of the foundations and special techniques required to minimize these impacts.

8.3.6 Cofferdams & Sheet Piles

Consider the effect of cofferdams penetrating rock layers that may terminate above the tip of the cofferdam or sheet pile. Consider whether continuous sheet piles should be replaced with soldier pile type cofferdams or walls.

Consider the effects on foundations constructed in sandy soils due to temporary cofferdams or sheet piles in close proximity. The installation of displacement pile groups within a temporary cofferdam becomes difficult as the degree of soil confinement increases with each pile installed. This confinement generally increases the driving resistance only while the cofferdam or sheet pile remains in place; extraction of the cofferdam or sheet pile (particularly vibratory extraction) may dramatically reduce the final pile resistance from the tip elevation of the cofferdam or sheet pile up to the ground surface, even with non-displacement piles. In addition to ensuring the minimum tip elevation of the foundation is well below the cofferdam or sheet pile, consider the following:

1. Set check perimeter piles after extraction of the cofferdam or sheet pile. If any pile set checked does not meet the required resistance, set check all piles in the group.
2. If seepage is not an issue, use braced sheets with short penetrations.
3. Use preformed pile holes to reduce resistance above the tip elevation of the cofferdam or sheet pile, and ensure NBR is achieved from only the soil and/or rock below the tip elevation of the cofferdam or sheet pile.
4. Instrument all piles to ensure the NBR is achieved after excluding all the temporary resistance from materials above the tip of cofferdam and sheet pile.
5. Ensure the top of rock socket for the drilled shaft is deeper than the tip elevation of the cofferdam or sheet pile.
6. Evaluate the effect of vibrations during extraction on spread footing bearing materials. Ensure the cofferdam or sheet pile tip is above a 1:2 control line (1V:2H) extended from the bottom edge of the spread footing or other shallow foundation.

Cofferdam design, should consider seepage flow and seepage pressure to determine sheet pile penetration depth.

8.4 Embankment Settlement/Stability

The completed embankment must provide sufficient support for value added pavement. (See Specification Sections 338 & 355) Embankment settlement and global stability should be addressed concurrently, as various options to solve settlement problems will also impact or be impacted by stability.

8.4.1 Settlement

Settlement calculations should be based on the results of consolidation tests performed on high-quality samples.

8.4.1.1 Design Procedure

References 3 and 11 are recommended.

8.4.1.2 Considerations

The results of consolidation calculations should be plotted on a time-settlement curve and included in the report. For compressible clay and organic materials, base total settlement estimates on primary consolidation, and secondary compression (creep) settlements over the design life of the roadway. In these cases, creep estimates must be based on coefficients of secondary compression values obtained from laboratory consolidation test results. Include time rate of settlement estimates; basing these estimates on laboratory or field tests is recommended.

For high organic content materials (organic content greater than 50%), base total settlement estimates on primary consolidation, secondary and tertiary compression (creep) settlements over the design life of the roadway. In these cases, creep estimates must be based on coefficients of secondary and tertiary compression values obtained from laboratory consolidation test results.

If excessive settlement due to compressible clays or organic materials is predicted over too lengthy a time period, (the criteria can vary) the engineer must propose a method of dealing with the problem. Not every possible solution is applicable to every project because of constraints of construction time, stability, etc. The Geotechnical Engineer may also need to design and monitor a field instrumentation program.

If surcharge is required, maintain surcharge load until at least 90% of the total expected settlement due to the fill with surcharge has occurred. Design the surcharge loading such that 100% of primary consolidation plus at least half of the creep consolidation for non-surcharged embankment has completed before the surcharge is removed.

Design lightweight fill embankments to provide a factor of safety \geq 1.20 against buoyancy, and lateral movement due to the 500 year storm. Provide details for a PVC or HDPE liner to protect lightweight fills such as EPS geofom which may be damaged by accidental exposure to chemical or petroleum spills.

8.4.1.3 Possible Solutions

1. Reduce fill height. This is seldom practical except in planning phase.
2. Provide waiting period to allow for the majority of consolidation to occur.
3. Increase surcharge height.
4. Use a lightweight fill.
5. Install wick drains within the compressible material to be surcharged.
6. Excavate soft compressible material and backfill with granular soil.
7. Ground modification such as stone columns, dynamic compaction, deep soil mixing, etc. (See References 38, 39 and [GeoTechTools](#))
8. Combinations of some of the above.

8.4.2 Stability

Stability analyses are performed based on the results of in-situ strength tests and/or laboratory strength tests on high quality samples. A range of possible material strengths is often considered, thus providing the engineer with a range of soil resistance from which to judge the stability of the slope. Any construction or utility placement that will require trenching or excavation will need a stability analysis.

In the Strength Limit State, LRFD slope stability analyses shall be based on a resistance factor of 0.75 when the geotechnical parameters are well defined and reasonably consistent, or based on worst case conditions. When the geotechnical parameters are highly variable, a resistance factor of 0.65 shall be used. Analyses for slopes supporting structures shall include all factored bearing loads from the supported structure in accordance with the current AASHTO LRFD Bridge Design Specifications. Analyses are required for all slopes steeper than 2H to 1V. Analyses may be needed for flatter slopes depending on soil and site conditions.

8.4.2.1 Design Procedure

References 3, 13, 18 and 30 are recommended. References 3, 13 and 18 are based on Factor of Safety or Service Limit State analyses which may be helpful, but will need to be modified. Various computer programs are available to assist in the analysis. Identify required reinforcement materials as R-2 or R-3 Geosynthetics when required for Embankments Over Soft Soils or Reinforced Slope applications, respectively.

8.4.2.2 Considerations

Soil resistance should be calculated for all possible slope conditions (i.e., surcharge loading, varying fill heights and/or slopes, varying water tables, etc.) for the service limit state. The engineer must design a method of dealing with potential stability problems and may need to design and monitor a field instrumentation program.

8.4.2.3 Possible Solutions

1. Realign highway.
2. Reduce fill height.

Note: These first two solutions are seldom practical unless the problem is identified early in the planning phase.

3. Flatten slope (Right of way requirements?).
4. Staged construction, to allow soft soil to gain strength through consolidation.
5. Excavate and replace soft soils.
6. Include geotextile or geogrid within the embankment.
7. Place berm at toe.
8. Use lightweight fills.
9. Ground modification such as stone columns, dynamic compaction, deep soil mixing, etc. (See References 38, 39 and [GeoTechTools](#))
10. Using obstructions to keep vehicles from parking on or approaching the crest of the slope.
11. Installing an underdrain system to depress the phreatic surface in the slope.
12. Constructing a trench at the top of the slope to divert surface water from the slope face.
13. Combinations of the above.

8.5 Retaining Wall Design

All retaining walls; including gravity walls, cantilever walls, crib walls, and mechanically stabilized earth (MSE) walls and soil nail walls; must be designed in accordance with the current AASHTO LRFD Bridge Design Specifications (except as noted in the FDOT Structures Design Guidelines (SDG) and the FDOT Design Manual ([FDM](#))) with adequate soil resistance against bearing, sliding, overturning, and overall stability. A design analysis is still required when standard index walls are used on a project.

8.5.1 Gravity Walls

8.5.1.1 Design Procedure

Reference 17 is recommended.

8.5.1.2 Considerations

All gravity walls including those taken from the [Standard Plans for Road and Bridge Construction](#) should be checked for stability. These walls are sensitive to differential settlements so they must be carefully checked. Refer

to the FDOT Structures Design Guidelines and the [FDM](#) for procedures on design of walls.

8.5.2 Counterfort Walls

8.5.2.1 Design Procedure

References 30 and 17 are recommended for Counterfort walls.

8.5.2.2 Considerations

This type of wall is typically not as economical as an MSE wall but it is competitive with other walls. It can be used in extremely aggressive environments. Speed of construction is another advantage in congested areas. Refer to the FDOT Structures Design Guidelines and the [FDM](#) for procedures on design of walls.

8.5.3 MSE Walls

8.5.3.1 Design Procedure

Reference 30 and 13 are recommended for MSE walls.

8.5.3.2 Considerations

The use of proprietary MSE wall systems is growing more common as rights-of-way become limited and congestion grows. FDOT maintains standard indices of wall systems pre-approved for use as permanent and critical temporary walls.

For all proprietary systems, the Geotechnical Engineer is responsible for external stability and assuring that the design is compatible with the actual subsurface conditions. The system proprietor is responsible for internal stability. Control drawings will be provided to the proprietary wall companies, which indicate the minimum lengths of reinforcement required for external stability. Drawings produced by the proprietor will show the actual reinforcement lengths required. These lengths will be the longer of those required for external stability, as given by the Geotechnical Engineer, and those required for internal stability, as calculated by the proprietor. Refer to the FDOT Structures Manual and the [FDM](#) for additional requirements.

8.5.4 Sheet Pile Walls

8.5.4.1 Design Procedure

Reference 17 is recommended for sheet pile walls.

8.5.4.2 Considerations

The engineer is responsible for all permanent sheet pile walls and all temporary sheet pile walls considered critical. When coatings will be used on wall panels, ensure the friction between the coated wall panel and the soil is properly considered; assume zero friction when a bitumen coating is used.

Steel sheet piles are normally installed using a vibratory hammer; concrete

sheet piles are installed by jetting. It is important to alert the contractor to soil or rock layers that will make sheet pile installation difficult by providing appropriate information in the plans. Consider preforming and other installation effects on the resulting friction between the wall panel and the soil or rock.

Consider the effects of cofferdams or sheet piles constructed near (within 5D of) foundations, particularly when the foundations are supported fully or partially on sandy soils. Reference 42 is recommended for evaluating the effects of sheet pile proximity on driven foundation piles. (See also [Section 8.3.6](#))

8.5.5 Soil Nail Walls

8.5.5.1 Design Procedure

References 17 and 23 are recommended for soil nail walls.

8.5.5.2 Considerations

Soil nail walls in sand may require large movements to mobilize soil resistance, and vertical excavations may not be achievable.

8.5.6 Soldier Pile/Panel Walls

8.5.6.1 Design Procedure

The analysis and design of soldier piles is different from sheet pile walls because the failure of individual pile elements is different from continuous walls. The failure mechanism of the individual pile is analogous to a bearing failure in front of the pile; the total resistance force assumes the pile has an effective width of 3B (or three times the width of the pile) for all types of soil. The bearing resistance pressures for cohesive soils are considered to be uniform with a magnitude of 2c (two times the cohesion) neglecting the soil resistance of 1.5 times the pile width (B) from the bottom of excavation. For granular soils, determine K_p with or without wall friction and neglect the soil resistance to a depth equal to one B below the bottom of excavation. When wall friction is considered, the interface angle δ must not exceed the value given in Table 1 of Reference 5 for the applicable soil and soldier pile materials. References 17 and 30 are recommended for Soldier Pile/Panel walls.

8.5.6.2 Considerations

Soldier pile and lagging walls usually consist of steel H-piles and horizontal lagging and are primarily used for top-down construction. Soldier pile walls can be cantilevered or anchored, temporary or permanent. For permanent applications in Florida, concrete pile and panel lagging is usually preferred. Soldier Pile/Panel walls should be considered in locations where sheet pile walls are needed, however, sheet pile installation difficulties are expected. Refer to the FDOT Structures Design Guidelines and the [FDM](#) for additional requirements.

8.5.7 GRS Walls

GRS walls are similar to GRS abutments.

8.5.7.1 Design Procedure

Designs must comply with Appendix C of Reference 34, except as otherwise indicated in Sections 3.12.12 and 3.13.4 of the Structures Design Guidelines.

Present GRS walls in the Plans using [Developmental Standard Plans, Index D6025](#). Incorporate [Developmental Specification 549](#) into the specifications package.

8.5.7.2 Considerations

Limitations and considerations are presented in Sections 3.12.12 and 3.13.4 of the Structures Design Guidelines and in the [Developmental Standard Plans Instructions, Index D6025](#).

8.6 Steepened Slopes

All steepened slopes must be designed for external stability including all failure possibilities such as sliding, deep-seated overall instability, local bearing capacity failure at the toe (lateral squeeze), and excessive settlement from both short- and long-term conditions. Reinforcement requirements must be designed to adequately account for the internal stability of the slope.

8.6.1 Design Procedure

Reference 13 is recommended. Identify Reinforced Slope reinforcement materials in the Plans or TSPs as R-3 Geosynthetics.

8.6.2 Considerations

Coordinate the use of steepened slopes with the District Maintenance Office. As with all slopes steeper than 1V:3H, steepened slopes require maintenance berms for mowing equipment – See the [FDM](#).

Table 2, Geotechnical Engineering Analysis Required in Reference 1 for Embankments, Cut Slopes, Structure Foundations and Retaining Walls

TABLE 3
REQUIRED GEOTECHNICAL ENGINEERING ANALYSIS

Soil Classification		Embankment and Cut Slopes		Structure Foundations (Bridges and Retaining Structures)		Retaining Structures (Conventional, Crib and MSE)	
Unified	AASHTO ¹	Slope Stability ² Analysis	Settlement Analysis	Bearing Capacity Analysis	Settlement Analysis	Lateral Earth Pressure	Stability Analysis
GW	A-1-a	Generally not required if cut or fill slope is 1.5H to 1V or flatter.	Generally not required except possibly for SC soils.	Required for spread footings, pile or drilled shaft foundations.	Generally not needed except for SC soils or for large, heavy structures.	GW, SP, SW & SP soils generally suitable for backfill behind or in retaining or reinforced soil walls.	All walls should be designed to provide minimum F.S. = 2 against overturning & F.S. = 1.5 against sliding along base.
GP	A-1-a	For FDOT Projects, analysis is required for all slopes steeper than 2H to 1V. (See 8.4.2)		Spread footings generally adequate except possibly for SC soils	Empirical correlations with SPT values usually used to estimate settlement	GM, GC, SM & SC soils generally suitable if have less than 15% fines. Lateral earth pressure analysis required using soil angle of internal friction.	External slope stability considerations same as previously given for cut slopes & embankments.
GM	A-1-b						
GC	A-2-6	Erosion of slopes may be a problem for SW or SM soils.					
SW	A-2-7						
SP	A-3	Required unless non-plastic. Erosion of slopes may be a problem.	Required	Required. Spread footing generally adequate.	Required. Can use SPT values if non-plastic.	These soils are not recommended for use directly behind or in retaining or reinforced soil walls.	
SM	A-2-4						
SC	A-2-5	Required	Required				
ML	A-4						
CL	A-6	Required	Required				
OL	A-4						

¹ This is an approximate correlation to Unified (Unified Soil Classification system is preferred for geotechnical engineering usage, AASHTO system was developed for rating pavement subgrades).

² These are general guidelines, detailed slope stability analysis may not be required where past experience in area is similar or rock gives required slope angles.

Table 3, Geotechnical Engineering Analysis Required in Reference 1(Continued)

TABLE 3 (Continued)

Soil Classification		Embankment and Cut Slopes		Structure Foundations (Bridges and Retaining Structures)		Retaining Structures (Conventional, Crib and MSE)	
Unified	AASHTO ¹	Slope Stability ² Analysis	Settlement Analysis	Bearing Capacity Analysis	Settlement Analysis	Lateral Earth Pressure	Stability Analysis
MH	A-5	Required. Erosion of slopes may be a problem.	Required.	Required.	Required.	These soils are not recommended for use directly behind or in retaining walls.	All walls should be designed to provide minimum F.S. = 2 against overturning & F.S. = 1.5 against sliding along base.
CH	A-7	Required.	Required.	Deep foundation generally required unless soil has been preloaded.	Consolidation test data needed to estimate settlement amount and time.		
OH	A-7	Required.	Required.				External slope stability considerations same as previously given for cut slopes & embankments
PT	----	Required.	Required. Long term settlement can be significant	Deep foundation required unless peat excavated and replaced.	Highly compressible and not suitable for foundation support		
Rock		Fills – not required for slopes 1.5H to 1V or flatter. Cuts – required but depends on spacing, orientation and strength of discontinuities and durability of rock		Required for spread footings or drilled shafts. Empirically related to RQD ³	Required where rock is badly weathered or closely fractured (low RQD). May require in situ test such as pressuremeter.	Required. Use rock backfill angle of internal friction.	

REMARKS:
 Soils – temporary ground water control may be needed for foundation excavations in GW through SM soils.
 Backfill specifications for reinforced soil walls using metal reinforcements should meet the following requirements in insure use of non-corrosive backfill:
 pH range = 5 to 10; Resistivity > 3000 ohm-cm; Chlorides < 100 ppm; Sulfates < 200 ppm; Organic content 1% maximum

Rock – Durability of shales (siltstone, claystone, mudstone, etc.) to be used in fills should be checked. Non-durable shales should be embanked as soils, i.e., placed in maximum 0.3 m (1 ft) loose lifts and compacted with heavy sheepsfoot or grid rollers.

¹ This is an approximate correlation to Unified (Unified Soil Classification system is preferred for geotechnical engineering usage, AASHTO system was developed for rating pavement subgrades).

² These are general guidelines, detailed slope stability analysis may not be required where past experience in area is similar or rock gives required slope angles.

³ RQD (Rock Quality Designation) = sum of pieces of rock core 4” or greater in length divided by the total length of core run.

8.7 Computer Programs used in FDOT

See the listing of [Geotechnical Computer Programs](#) used in FDOT on the [Geotechnical Engineering webpage](#).

Table 4, Example + 2% of Optimum Method Calculation

TEST NO.	MAXIMUM LBR	LBR AT MOISTURE CONTENTS: (OF OPTIMUM LBR)	
		- 2%	+ 2%
1	165	30	18
2	35	25	25
3	64	60	45
4	35	12	8
5	85	20	45
6	55	45	20
7	33	7	10
MEAN LBR VALUE:	67.42	28.42	24.43
AVERAGE = 26.42 (26) => DESIGN LBR = 26			

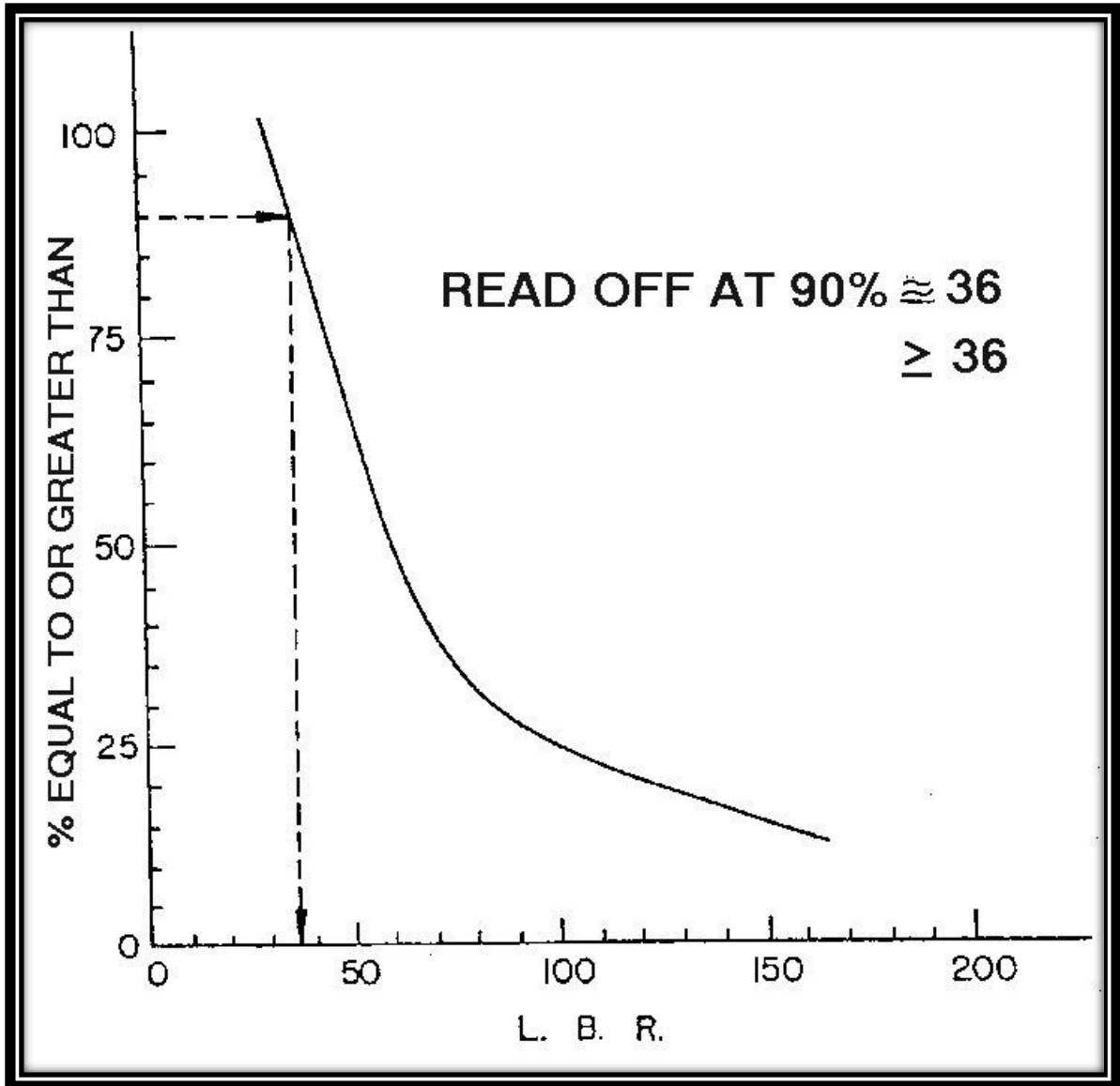

Figure 27, Design Example 1 (LBR Design Methods) 90% Method

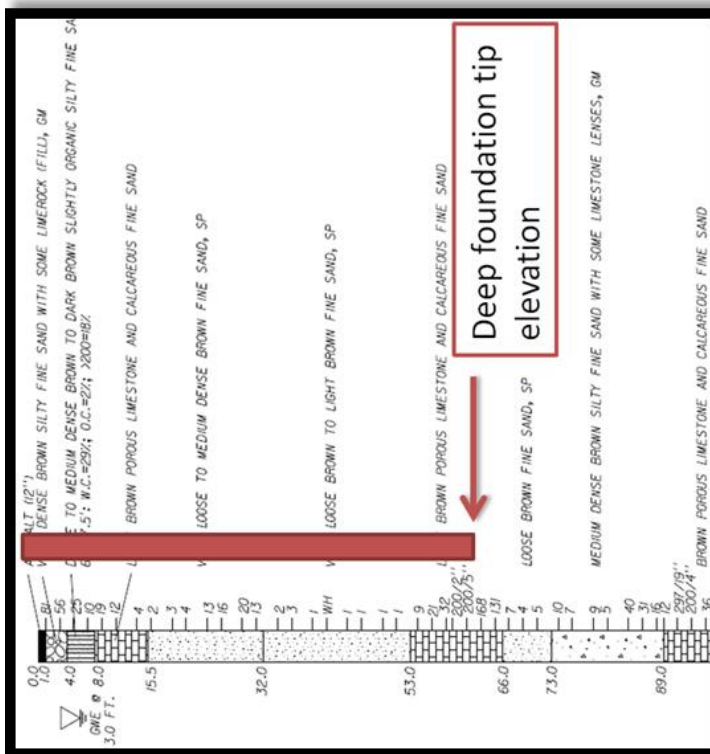
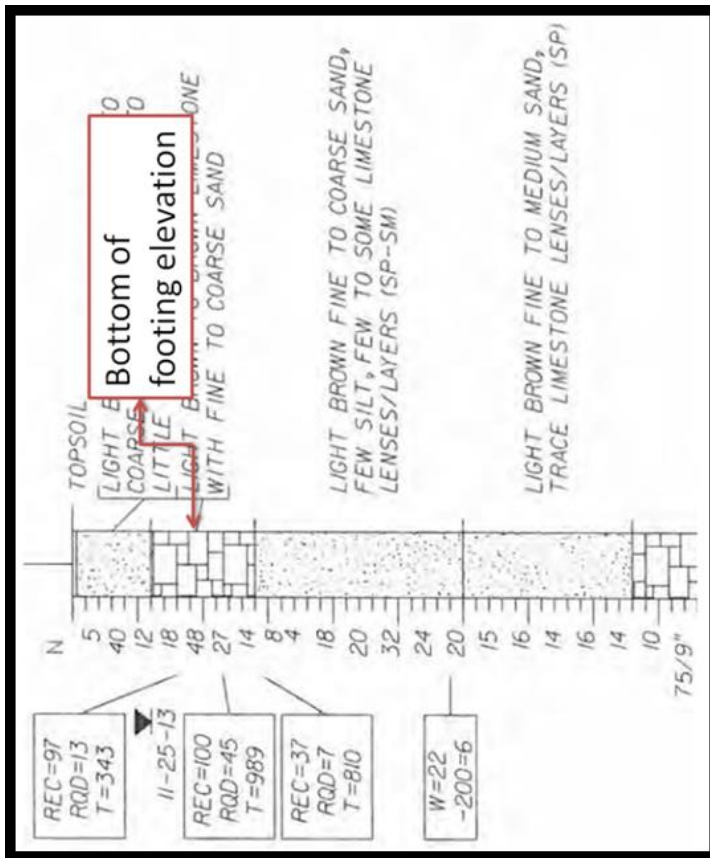

Figure 28, Example of Rock Lens Punching Condition

8.8 References

1. “Checklist and Guidelines for Review of Geotechnical Reports and Preliminary Plans and Specifications”, Federal Highway Administration, 1988, Revised 2003.
2. Standard Plans for Road and Bridge Construction, Florida Department of Transportation, (Current version).
3. Cheney, Richard S. & Chassie, Ronald G., Soils and Foundations Workshop Manual – Second Edition, FHWA HI-88-009, 1993.
4. NAVFAC DM-7.1 - Soil Mechanics, Department of the Navy, Naval Facilities Engineering Command, 1986.
5. NAVFAC DM-7.2 - Foundations and Earth Structures, Department of the Navy, Naval Facilities Engineering Command, 1986.
6. Bloomquist, David, Centrifugal Model Investigation of Pile Group Efficiencies, Research report C-3981, 1991.
7. Hannigan, P.J., Goble, G.G., Likins, G.E., and Rausche, F., Design and Construction of Driven Pile Foundations Volumes I & II, FHWA-NHI-05-042 and 043, 2006.
8. Schmertmann, John H., Guidelines for Cone Penetration Test Performance and Design, FHWA-TS-78-209, 1978.
9. O’Neill, Michael W. and Reese, Lymon C., Drilled Shafts: Construction Procedures and Design Methods, FHWA-IF-99-025, 1999
10. Reese, Lymon C., Handbook on Design of Piles and Drilled Shafts Under Lateral Load, FHWA-IP-84-11, 1984.
11. Duncan, J.M. & Buchignani, A.L., An Engineering Manual for Settlement Studies, Department of Civil Engineering, University of California, Berkeley, 1976.
12. Holtz, Robert D., Christopher, Barry R., and Berg, Ryan R., Geosynthetic Design and Construction Guidelines, FHWA HI-95-038, 1995.
13. Berg, Ryan R., Christopher, Barry R., and Samatani, Naresh C., Design and Construction of Mechanically Stabilized Earth Walls and Reinforced Soil Slopes – Volumes I & II, FHWA-NHI-10-024 & 025, FHWA GEC 11, 2009.
14. Sabatini, P.J., Elias, V., Schmertmann, G.R., and Bonaparte, R., Earth Retaining Systems, FHWA Geotechnical Engineering Circular No. 2. 1997.
15. Structures Design Guidelines, Florida Department of Transportation, (Current version).
16. [FDOT Design Manual](#), Florida Department of Transportation, (Current version).
17. Tanyu, Burak F., Sabatini, Paul J. and Berg, Ryan R., Earth Retaining Structures, FHWA-NHI-07-071, 2008.

18. Abramson, Lee, Boyce, Glenn, Lee, Thomas, Sharma, Sunil, Advance Course on Soil Slope Stability: Volume I, Slope Stability Manual, FHWA-SA-94-005, 1994.
19. O'Neill, M.W., Townsend, F.C., Hassan, K.M., Buller, A. Chan, P.S.; Load Transfer for Drilled Shafts in Intermediate Geomaterials, FHWA-RD-95-172, 1996.
20. Lukas, Robert G.; Dynamic Compaction, FHWA Geotechnical Engineering Circular No. 1, 1995.
21. Raushe, F., Thendean, G., Abou-matar, H., Likins, G.E., Goble, G.G.; Determination of Pile Driveability and Capacity from Penetration Tests Vol I - Vol III; FHWA-RD-96-179 thru 181, 1997.
22. Haley & Aldrich, Inc.; Spread Footings for Highway Bridges, FHWA-RD-86-185, 1987.
23. Lazarte, C., Robinson, H., Gómez, J., Baxter, A., Cadden, A., Soil Nail Walls – Reference Manual; FHWA GEC7, FHWA-NHI-14-007, 2015
24. Rixner, J.J., Kraemer, S.R., and Smith, A.D.; Prefabricated Vertical Drains Vol. I, Engineering Guidelines, FHWA-RD-86-186, 1986.
25. McVay, M., Armaghani, B., and Casper, R.; “Design and Construction of Auger-Cast Piles in Florida” in Design and Construction of Auger Cast Piles, and Other Foundation Issues, Transportation Research Record No. 1447, 1994.
26. Armour, T., Groneck, P., Keeley, J. and Sharma, S.: Micropile Design and Construction Guidelines; FHWA-SA-97-070, 2000.
27. Urzua, Alfredo; EMBank- A Microcomputer Program to Determine One-Dimensional Compression Due to Embankment Loads, FHWA-SA-92-045, 1993.
28. Yoder, E. J. and Witczak, M. W.; Principles of Pavement Design, John Wiley and Sons, 2nd Ed., 1975.
29. Bowles, Joseph E., Foundation Analysis and Design, Fourth Edition, New York: McGraw-Hill Book Company, 1988.
30. AASHTO LRFD Bridge Design Specifications, American Association of State Highway and Transportation Officials, (Current Edition).
31. Winterkorn, Hans F., and Fang, Hsai-Yang, Foundation Engineering Handbook, Van Nostrand Reinhold Company Inc., 1975
32. Briaud, J. L. and Tucker, L., Design and Construction Guidelines for Downdrag on Uncoated and Bitumen Coated Piles, NCHRP Report 393, 1997.
33. Sabatini, P., Tanyu, B., Armour, T., Groneck, P. and Keeley, J., Micropile Design and Construction (Reference Manual for NHI Course 132078), FHWA-NHI-05-039, 2005

34. Adams, M., Nicks, J., Stabile, T., Wu, J., Schlatter, W. and Hartmann, J., Geosynthetic Reinforced Soil Integrated Bridge System, Interim Implementation Guide, FHWA-HRT-11-026, 2011
35. Adams, M., Nicks, J., Stabile, T., Wu, J., Schlatter, W. and Hartmann, J., Geosynthetic Reinforced Soil Integrated Bridge System, Synthesis Report, FHWA-HRT-11-027, 2011
36. Gray, Kathy M., *Central Florida Sinkhole Evaluation*, <http://www.dot.state.fl.us/geotechnical/publications.shtm>
37. McVay, M.C., Townsend, F.C., and Williams, R.C., 1992, "Design of Socketed Drilled Shafts in Limestone" ASCE Journal of Geotechnical Engineering, Vol. 118, No. 10, October, 1992.
38. Elias, V., Welsh, J., Warren, J., Lukas, R., Collin, J., and Berg, R., Ground Improvement Methods - Vols 1 & 2, FHWA NHI-06-019 & 020, 2006
39. Bruce, M.E., Berg, R., Collin, J., Filz, G., Terashi, M., and Yang, D., Deep Mixing for Embankment and Foundation Support, FHWA-HRT-13-046, 2013
40. Nam, B.H., Shamet, R., Soliman, M., Wang, D., Yun, H.B., Development Of A Sinkhole Risk Evaluation Program, FDOT Research Report BDV24-977-17, 2018
41. McVay, M.C., Song, X., Wasman, S., Nguyen, T., and Wang, K., Strength Envelopes for Florida Rock and Intermediate Geomaterials, [FDOT Research Report BDV31-977-51](#), 2019
42. Chung, J.H., McVay, M.C., Davidson, M.T., Effect of proximity of Sheetpile Walls on the Apparent Capacity of Driven Displacement Piles, [FDOT Research Report BDV31-977-26](#), August 2018.

Chapter 9

9 Presentation of Geotechnical Information

Upon completion of the subsurface investigation and analysis, the information obtained must be compiled in a report format that is clear and easy to follow. This report will serve as the permanent record of all geotechnical data known during design of the project, and it will be referenced throughout the design, construction and service life of the project. It is perhaps the most critical function of the geotechnical process.

The geotechnical report shall present the data collected in a clear manner, draw conclusions from the data and make recommendations for the geotechnical related portions of the project. Most projects will generally require either a roadway soil survey or a structure related foundation investigation, or both. For reports prepared by consultants, the basis for the consultants' recommendations shall be documented in the report and retained.

This chapter describes the format for presentation of geotechnical data for each type of project. General outlines of the topics to be discussed in the geotechnical report are presented. For any given project, certain items may need to be added. Also included in this chapter are discussions on the finalization and distribution of the geotechnical report and on the incorporation of its recommendations into the design.

9.1 Roadway Soil Survey

The geotechnical report for a roadway soil survey presents conclusions and recommendations concerning the suitability of in-situ materials for use as embankment materials. Special problems affecting roadway design, such as slope stability or excessive settlement may also be discussed if applicable. The following is a general outline of the topics to be included.

9.1.1 General Information

- a. List of information provided to the geotechnical consultant (alignment, foundation layout, 30% plans, scour estimate, etc.).
- b. Description of the project, including location, type, and any design assumptions.
- c. Description of significant geologic and topographic features of the site.
- d. Description of width, composition, and condition of existing roadway.
- e. Description of all methods used during subsurface exploration, in-situ testing, and laboratory testing; along with the raw data from these tests.
- f. Provide the make and model of the GPS unit used to determine the Latitude and Longitude coordinates of borings, bulk samples, muck probe areas, etc.

9.1.2 Conclusion and Recommendations

- a. Provide an explanation of stratification of in-situ materials including observed groundwater level and estimated seasonal high/low groundwater levels.

- b. Evaluate the strength and extent of unsuitable soils within the proposed alignment including their probable effect on roadway performance. Indicate the anticipated horizontal and vertical extent of removal of unsuitable materials. Provide recommendations for special construction considerations, to minimize anticipated problems.
- c. Provide estimated soil drainage characteristics and permeability or infiltration rates. In the case of rigid pavement design, include average laboratory permeability values for each stratum based on the requirements given in the Rigid Pavement Design Manual.
- d. Provide recommendations for cut or fill sections when seepage, stability or settlements are significant.
- e. Provide recommendations and considerations for any proposed walls.
- f. Provide recommendations and considerations for any proposed storm water retention ponds.
- g. Provide recommendations to minimize the effects of roadway construction (vibratory rollers, utility excavations, sheet pile installation, etc.) on surrounding structures and on the usage of those structures.

9.1.3 Roadway Soils Survey (Report of Tests) Sheet

This sheet presents a material description and results of classification and corrosivity tests for each stratum. Recommendations for material utilization are provided in accordance with Standard Plans, Indexes 120-001 and 120-002. Visual classification of muck is not sufficient; present organic and moisture content test results. The number of lab tests performed for each stratum shall be included for corrosion tests results as well as classification tests. Include the range of result values of all tests performed for each stratum. Round all test values except organic content values less than 10 and pH to the most appropriate whole number; round pH test results and organic content values less than 10 to one decimal place. Include all tests performed, including M_R tests performed by the State Materials Office. The Report of Tests Sheet is included in the report and the construction plans. [Figure 29](#) is an example of a typical test results sheet.

9.1.4 Roadway (and Pond, etc.) Cross Sections

Stratified boring logs are plotted on the cross section sheets included in the construction plans. Each material stratum is numbered corresponding to the strata on the test results sheet. [Figure 30](#) is an example of a typical cross sections sheet, and [Figure 31](#) is a typical example of a generalized soil profile. If cross sections sheets are to be prepared by others, the appropriate subsurface information should be provided. The Geotechnical Engineer shall verify that the data has been correctly incorporated.

The anticipated horizontal and vertical limits for removal of unsuitable materials shall be indicated on the cross sections.

9.1.5 Appendix

All roadway soil survey reports shall include an appendix, containing the following information:

- a. Soil conservation (NRCS/USDA) and USGS maps, depicting the project location.
- b. Boring location plan, plots of boring logs and/or cone soundings
- c. Results of roadway soil survey borings performed. For all SPT borings, include the information required in 9.2.3.
- d. Any other pertinent information.
- e. Analysis of the geotechnical information.

9.1.6 Geotechnical Data for NexGen Plans

The Final Geotechnical Data deliverable for a project is a xml file generated from the FDOT Geotechnical Data Manager (GDM) application. This application is delivered with the FDOT Connect software and is located in the C:\FDOTConnect\Organization-Civil\FDOT\Apps\GeotechDataManager folder.

The Geotechnical Data file should be named XXXXXXXXXXXX-modifier.xml where XXXXXXXXXXXX is the project number, the modifier is optional but can be used to differentiate data files if more than one is delivered with the project. The xml file should be stored in the project's Geotechnical discipline folder.

The GDM application provides the ability to manually create a deliverable xml file from scratch.

If a database system is used for storing Geotechnical data, the data can be exported out in Excel format that the GDM software can convert to the required xml format. Excel formatted templates are provided to show how the exported data shall be formatted for conversion by GDM. These spreadsheets are provided in the project's Geotechnical folder. The existing spreadsheet format should not be modified in any way. Once the database data is exported, it should then be imported into GDM then exported out to the final deliverable xml data file.

Training for this process can be found at the following YouTube location:
<https://www.youtube.com/watch?v=L944Hj2eJ98>

9.2 Structures Investigation

9.2.1 Introduction

The geotechnical report for a structure presents the conclusions and recommendations for the most suitable foundation types and information required for incorporating such foundations into the design of the structure. Recommendations for related work, such as approach embankments and retaining walls, are also included. Special construction considerations are noted. Items stated in the FDOT Specification 455 shall not be repeated and copied into the report. Only the site-specific items should be recommended for technical special provisions. The following is a general guide to the contents of a typical structure foundation report.

9.2.2 Scope of Investigation

- a. Description of type of project, location of project, local geology and any assumptions related to the project.
- b. Vicinity map, including potentiometric map, USGS and soil survey maps (NRCS/USDA), depicting project location.
- c. Summary of general content of report.

9.2.3 Interpretation of Subsurface Conditions

- a. Description of the methods used in the field investigation, including the types and frequencies of all in-situ tests.
- b. Description of the laboratory-testing phase, including any special test methods employed.
- c. Boring location plan and plots of boring logs and cone soundings. See [Figure 32](#) and [Figure 33](#) for examples of Report of Core Borings and Report of Cone Soundings sheets. Provide the longitude and latitude of each boring or sounding below the station, offset and elevation, and the depth of temporary casing used to perform the boring on the Report of Core Borings and Report of Cone Soundings sheets. Use the standard soil type symbols shown in [Figure 34](#) as described in [Table 6](#) when plotting boring logs. Note the size of rock core sampled. Provide the make and model of the GPS unit used to determine the Latitude and Longitude coordinates of borings, bulk samples, muck probe areas, etc.

These sheets are included in the final plans; see the **Core Borings** section of the *FDOT Structures Detailing Manual* for additional requirements for these sheets.
- d. Estimated depths of scour (usually determined by the Hydraulics Engineer), if applicable.
- e. Environmental class for both substructure and superstructure, based on results of corrosivity tests. This information is also reported on the Report of Core Borings sheet. For extremely aggressive classification note what parameter placed it in that category.
- f. Summary table of soil parameters determined from field and laboratory testing.
- g. Table of soil parameters to use with computer modeling (such as the FB-Pier or FB-MultiPier program). These parameters can be broken up into zones across the bridge length.
- h. Recommendations and considerations for any proposed walls. MSE or cast-in-place wall recommendations.
- i. Discussion of undesirable conditions observed in the borings and undesirable conditions present in the geologic formation(s) encountered at the site, together with any impact on proposed construction.

Modification for Non-Conventional Projects:

- Add: j. Discussion of anticipated procedures for mitigating undesirable conditions observed in the borings or expected due to the geologic formation(s) encountered at the site.

9.2.4 Existing Structures Survey and Evaluation

Existing structures to be protected may include sensitive sites, such as those listed in FDM Chapter 307. The Roadway Design Office has determined the Roadway Engineer will generally determine whether there are sensitive sites, such as those listed in 34.1 in proximity to the project. The Department will make a final determination whether revised thresholds of settlement and vibration are warranted.

When requested by the EOR:

- 1) The geotechnical design effort should evaluate these structures and confirm monitoring during construction is warranted based on the anticipated soil type, building characteristics (type, use, condition, etc.), proximity and the proposed construction operations.
- 2) Assist the EOR in developing mitigation strategies and evaluating whether limits on vibration limits and settlements more stringent than those specified in section 108 should be required for these structures.
- 3) Recommend and discuss with the Department the potential need of specifying different movement thresholds.
- 4) Prepare a Modified Special Provision to specify the revised thresholds of vibration and settlement identifying the sensitive sites where these thresholds shall apply.

Where there is a potential impact on existing structures in the surrounding area, the geotechnical report should include the structure's address, type of construction, the estimated vibration level that may cause damage, the usage (storage building, hospital, etc.), what the potential problem may be and what actions should be taken to minimize the impact. Ensure that settlement and vibration monitoring are specified in the plans for the sites requiring these revised thresholds

Where construction dewatering may create a potential impact on existing structures in the surrounding area, the report should include the structure's address, type of construction, the degree of dewatering that may cause damage, the usage, what the potential problem may be and what actions are recommended to minimize the impact.

9.2.5 Structure Foundation Analysis and Recommendations

Alternate foundation recommendations should be provided for all structures including recommendations for GRS abutments, spread footings, driven piles, and drilled shafts. An explanation should be included for any of these alternates judged not to be feasible. The types of analyses performed should be summarized.

Modification for Non-Conventional Projects:

Delete the previous paragraph and replace with “Provide a summary of the analysis and recommendations for the preferred foundation.”

9.2.5.1 GRS Abutments

1. Summarize evaluation including reason(s) for selection and/or exclusion.
2. Design soil pressure based on settlement and bearing capacity.
3. Estimated short and long term settlements assuming GRS abutments are constructed in accordance with Specification 549.
4. Soil improvement method(s).
5. Estimate the reduction in settlement anticipated resulting from these improvement methods.
6. Sinkhole potential.
7. Provide the information required in the [Developmental Standard Plans Instructions, Index D6025](#).

9.2.5.2 Spread Footings

1. Summarize evaluation including reason(s) for selection and/or exclusion.
2. Elevation of bottom of footing or depth to competent bearing material.
3. Design soil pressure based on settlement and bearing capacity.
4. Estimated short and long term settlements assuming spread footings are constructed in accordance with Specification 455.
5. Soil improvement method(s).
6. If soil material needs to be over excavated and replaced, recommend plan notes specifying the depth of excavation. Provide recommendations for technical special provisions for footing construction, including compaction requirements and the need for particular construction methods such as dewatering or proof rolling in addition to the requirements in Specifications 125 and 455. Estimate the reduction in settlements anticipated resulting from these special requirements.
7. Sinkhole potential.

9.2.5.3 Driven Piles

1. Suitable pile types and reasons for design selections and exclusions.
2. Plotted design curves of soil resistance for selected pile size alternates. Plotted curves should present the Davisson capacity, ultimate skin friction and mobilized end bearing versus pile tip elevation for the existing soil profile. The Davisson capacity is equivalent to the LRFD nominal resistance (R_n).

Provide separate pile analyses for each recommended pile size, for each SPT boring and/or CPT sounding. Provide a corresponding pile capacity curve for each analysis. When more than one boring is taken at a pile group or when it is appropriate to otherwise generalize the soil strata, show the corresponding pile capacity curves together on the same plot and establish the lower bound for that pile group.

3. Estimated elevation of consistent bearing layer suitable for providing the required nominal resistance without the risk of punching shear failure.
4. Recommendations for pile length or bearing elevation to minimize post-construction settlements in soil layers or punching shear failure of rock or hard layers.
5. Recommendations for pile length or bearing elevation to provide the nominal uplift resistance. (The resistance factor for uplift is determined by the Construction QC method used to verify uplift resistance, see Structures Design Guidelines Table 3.5.6-1).
6. Estimated pile settlement and pile group settlement for the minimum tip elevation.
7. Effects of scour, downdrag and lateral squeeze, if applicable.
8. Estimated maximum pile driving resistance to be encountered in reaching the minimum tip elevation. If the FB-Deep Davisson bearing capacity computed at or above the minimum tip elevation exceeds the Maximum Pile Driving Resistance defined in Table 3.2 of the Structures Design Guidelines, determine the preforming or jetting elevations required to reduce the driving resistance to an acceptable magnitude. Provide additional capacity curves required by the FDOT Structures Design Guidelines on separate pages.
9. Recommended limitations on predrilling/preforming operations to prevent impacts from observed or expected artesian conditions.
10. Recommended locations of test piles.
11. Selection of load test types, locations and depths where applicable. For static, Statnamic or Osterberg load testing, the ultimate load must be shown in the plans: the greater of 2 times the factored design load or the design nominal resistance)
12. Recommendations for special provisions for pile installation (special needs or restrictions). Special construction techniques may be needed to minimize the effects of foundation installation discussed in **Section 9.2.4**.
13. Recommendations and special techniques to address the effects of temporary cofferdams or sheet piles on the pile capacity; see Section 8.3.6.
14. Present recommendations for information to be placed in the Pile Data Table shown in the [SPI for FDOT Standard Plans Index 455-001](#).

15. Present soil parameters to be used for lateral analysis accounting for installation techniques and scour. The Geotechnical Engineer shall check the final lateral load analyses for correct soil property application.
16. On small projects with reasonably predictable bearing layers, provide the production pile lengths in the Pile Data Table for each bent rather than test pile lengths.
17. Sinkhole potential and its implications for pile installation and performance.

9.2.5.4 Drilled Shafts

1. Include plots of resistance versus tip elevation for selected alternate shaft sizes. Plots should be developed for both factored (Q_r) and nominal (Q_n) resistance and should show end bearing, skin friction and total resistance (end bearing shall not be discounted). Depths of scour analyzed should be included.
2. Unless otherwise specified, separate shaft analyses for the recommended shaft sizes are to be performed for each SPT boring and/or CPT sounding. Provide resistance versus tip elevation curves for each analysis. When more than one boring is taken at a shaft group or when it is appropriate to otherwise generalize the soil strata, the corresponding resistance versus tip elevation curves are to be shown on the same plot and a recommended relationship established for that particular structure(s). Indicate the unit skin friction and end bearing values used for the analyses. Ensure socket lengths are sufficient to prevent punching shear failure in cases where the foundation is anticipated to tip in a strong layer underlain by weaker layer.
3. Provide recommendations for minimum shaft length or bearing elevation, for shaft diameter, and design soil resistance. The minimum socket length should be indicated, if applicable (non-lateral).
4. Minimum shaft spacing or influence of group effects on capacity.
5. Effects of scour, downdrag and lateral squeeze, if any.
6. Estimate drilled shaft settlement and shaft group settlement.
7. Recommend test types, locations and depths. For static, Statnamic or Osterberg load testing, the ultimate load the test should be taken to must be shown in the plans (for LRFD designs, the greater of 2 times the factored design load or the nominal resistance).
8. Evaluate the need for technical special provisions for shaft installation (special needs or restrictions). Special construction techniques may be needed to minimize the effects of foundation installation discussed in **Section 9.2.4**.
9. Present recommendations for information to be placed in the Drilled Shaft Data Table shown in the FDOT Structures Design Guidelines.
10. Include the potentiometric Surface Map information.

11. Present soil/rock parameters to be used for lateral analysis accounting for installation techniques and scour. The Geotechnical Engineer shall check the final lateral load analysis for correct soil/rock property application.
12. Sinkhole potential and its implications for drilled shaft construction and performance.

9.2.5.5 Auger Cast Piles

1. Suitable pile sizes.
2. Plotted design curves of soil resistance for selected pile size alternates. The ultimate skin friction capacity is equivalent to the LRFD nominal resistance (R_n).

Provide separate pile analyses for each recommended pile size, for each SPT boring and/or CPT sounding. Provide a corresponding pile capacity curve for each analysis. When more than one boring is taken at a pile group or when it is appropriate to otherwise generalize the soil strata, show the corresponding pile capacity curves together on the same plot and establish the lower bound for that pile group.

3. Estimated elevation of consistent bearing layer suitable for providing the required nominal resistance.
4. Recommendations for providing the nominal uplift resistance (see Structures Design Guidelines Table 3.5.20-2).
5. Estimated pile settlement and pile group settlement for the recommended tip elevation.
6. Effects of scour, downdrag and lateral squeeze, if applicable.
7. Recommended locations of demonstration piles and load test piles.
8. The ultimate load for the load test must be shown in the plans (the greater of 2 times the factored design load or the design nominal resistance).
9. Recommendations and special techniques to address the effects of temporary cofferdams or sheet piles on the pile capacity; see Section 8.3.6.
10. Present recommendations for information to be placed in the Drilled Shaft Data Table shown in the FDOT Structures Detailing Manual (Change the title of the table to “Auger Cast Pile Data Table”).
11. Present soil parameters to be used for lateral analysis accounting for installation techniques and scour. The Geotechnical Engineer shall check the final lateral load analyses for correct soil property application.
12. Sinkhole potential and its implications for pile installation and performance.

9.2.6 Roadway and Approach Embankment Considerations

9.2.6.1 Settlement

1. Estimated magnitude and rate of settlement.

2. Evaluation of possible alternatives if magnitude or time required for settlement is excessive and recommended treatment based on economic analysis, time and environmental constraints.

9.2.6.2 Stability

1. Estimated overall stability using the latest AASHTO LRFD resistance factors.
2. Evaluation of possible treatment alternatives if required resistance is not provided. Recommended treatment based on economic analysis, time and environmental constraints.
3. Verify stability for fully saturated conditions.

9.2.6.3 Construction Considerations

1. Special fill requirements and drainage at abutment walls.
2. Construction monitoring program.
3. Recommendations for technical special provisions regarding embankment construction.

9.2.7 Retaining Walls and Seawalls

- a. Settlement potential
- b. Recommended lateral earth pressure parameters.
- c. Recommended wall type according to the [FDOT Design Manual \(FDM\)](#).
- d. Factored soil resistance or alternate foundation recommendations.
- e. Factored soil resistance and loads with respect to sliding and overturning (including standard index wall designs).
- f. Overall stability of walls.
- g. Recommendations for technical special provisions for fill material (except MSE walls) and drainage.
- h. Special considerations for tiebacks, geotextiles, reinforcing materials, etc., if applicable.
- i. MSE reinforcement lengths required for external stability, if applicable. See the FDOT Structures Design Guidelines and the FDM for details.

9.2.8 Steepened Slopes

- a. Estimated resistance factor against internal and external stability failure based on LRFD.
- b. Spacing and lengths of reinforcement to provide a stable slope.
- c. Design parameters for reinforcement (design strength, durability criteria, and soil-reinforcement interaction).
- d. Fill material properties.

- e. Special drainage considerations (subsurface and surface water runoff control).
- f. Verify stability for fully saturated conditions.

9.2.9 Technical Special Provisions

Technical Special Provisions (TSP's) shall be used to change the Standard Specifications for a project only when extraordinary, project specific conditions exist.

The Department has available a small number of Technical Special Provisions for various items of work tailored to previous projects. These Technical Special Provisions can be obtained from the District Geotechnical Engineer or <http://www.fdot.gov/geotechnical/publications.shtm>.

TSP's obtained from the Department were tailored to reflect the specific needs of a previous project, and they will need to be updated and revised to reflect the needs of your specific project.

9.2.10 Appendix

All structure investigation reports shall include an appendix, containing the following information:

- a. Report of Core Borings (or Report of SPT Borings) Sheet. (See [Figure 32](#)) (Note the FDOT Geotechnical CADD Standard menu is available.)
- b. Color photographs of rock cores indicating boring and core elevation.
- c. Report of Cone Sounding Sheet. (See [Figure 33](#))
- d. Data logs or reports from specialized field tests.
- e. Laboratory test data sheets. The following are examples of what should be provided.
 1. Rock Cores: Location, elevation, Maximum Load, Core Length, Core Diameter, Moist Density, Dry Density, Splitting Tensile Strength, Unconfined Compressive Strength, Strain at 50% of Unconfined Compressive Strength, Strain at Failure and Corrected Tangent Modulus (adjust the origin to eliminate seating stresses; use the adjusted origin and the slope of the linear portion of the Stress vs. Strain curve).
 2. Rock core data reduction and statistical analyses obtaining design side resistance for drilled shaft socket in rock, if applicable, according to Appendix A of this Handbook.
 3. Gradations: Location, elevation, test results.
 4. Corrosion Tests: Location, elevation, test results.
 5. Consolidation Tests: plots of e vs. $\log p'$ and displacement vs. time (both \sqrt{t} time and $\log t$ time), and index properties of tested materials.
- f. Engineering analyses (bearing resistance, lateral stability, group effects, settlement, global stability, punching shear, downdrag, scour, and other applicable analyses).
- g. Recommended plan notes.

- h. FHWA checklist.
- i. Copies of actual field boring logs with all drillers' notes and hand written refinements, if any (not typed logs).
- j. Any other pertinent information.

9.3 Final or Supplementary Report

To obtain the optimum benefit from the geotechnical investigation, it is imperative that the Geotechnical Engineer and the project design and construction engineers interact throughout the duration of the project. The input from the Geotechnical Engineer should be incorporated into the project as it develops. Often, the geotechnical report, which is initially prepared, is considered preliminary. As the design of the project progresses, the geotechnical recommendations may have to be modified. When the project approaches the final design stage, the Geotechnical Engineer should prepare a final or supplementary report to revise his assumptions and recommendations if necessary in accordance with the final design plans. The following topics should be included in this report:

1. Final recommended foundation type and alternates.
2. Size and bearing elevation of footing or size, length, and number of piles or drilled shafts at each structural foundation unit.
3. Final factored design loads.
4. Requirements for construction control for foundation installation.
5. Possible construction problems, such as adjacent structures, and recommended solutions.
6. Comments issued on the preliminary Report by the District Geotechnical Office and the State Geotechnical Office (if applicable) and the corresponding responses.

9.4 Signing and Sealing

Submittals are required to be electronically signed and sealed; geotechnical documents shall be signed and sealed by the Professional Engineer in responsible charge in accordance with Florida Statutes and the Rules of the State Board of Professional Engineers. The following documents are included:

Table 5, Signing and Sealing Placement

Geotechnical Report	First page of official copy
Technical Special Provisions	First page of official copy
Roadway Soils Survey Sheet	Signature Sheet of the Plans
Report of Core Borings Sheet	Signature Sheet of the Plans
Report of Cone Soundings Sheet	Signature Sheet of the Plans
Other Geotechnical Sheets	Signature Sheet of the Plans

For supplemental specifications and special provisions, which cover other topics in addition to Geotechnical Engineering, the engineer in responsible charge of the geotechnical portions should indicate the applicable pages. See Section 130 of the FDOT Design Manual.

9.5 Distribution

The following offices should be provided copies of geotechnical reports, as applicable:

1. Project Manager.
2. District Geotechnical Engineer.
3. District Drainage Engineer.
4. District Structural Design Section.
5. Roadway Design Section.
6. State Geotechnical Engineer (for Category II structures).

Modification for Non-Conventional Projects:

Delete the above distribution list and see the RFP for requirements.

9.6 Plan and Specification Review

In addition to writing the report, the Geotechnical Engineer shall review all phases of the plans and specifications to ensure that the geotechnical recommendations have been correctly incorporated.

A marked up set of prints from the Quality Control Review, signed by the geotechnical reviewer, shall be submitted with each phase submittal. The responsible Professional Engineer performing the Quality Control review shall provide a signed statement certifying the review was conducted.

FDOT Standard and Supplemental Specifications shall not be changed except in rare cases, then only with the approval of the District Geotechnical Engineer. The Specifications Office requires a Modified Special Provision for all project specific changes to the FDOT Standard and Supplemental Specifications.

Modification for Non-Conventional Projects:

Delete the last Paragraph and insert the following:

FDOT Standard. Supplemental and Developmental Specifications shall not be changed except in rare cases; then only with the approval of the Engineer.

9.7 Electronic Files

The consultant shall submit an electronic copy of:

1. The final approved geotechnical report in MS Word format. Include the boring log sheets in DGN format, and include the input files used in the analysis programs (FB-Deep, FB-Pier, etc.).

2. The completed Excel spreadsheet with soil boring information for the FDOT GIS Soil Boring Database together with the boring profiles in PDF format.

If the consultant uses a computer program in the design process that is not listed for use in this handbook, the following additional items shall be included in the report submittal:

1. Example hand calculations verifying the results of the consultant's computer programs shall be included in the calculations package.
2. An electronic copy of the geotechnical Consultant's program and the computer input data files.

9.8 Unwanted

Some of the things we do not wish to see in the report are:

1. Do not summarize or retype standard test methods or FDOT specifications into the report. Specifications and test methods should be referenced by number, and the reader can look them up if needed.
2. Do not change the Standard Specifications without valid justification. (For example, do not change the MSE wall backfill gradation; base your design on the backfill material required in the Standard Specifications.)
3. Do not include long verbal descriptions when a simple table will be more clear.
4. Do not bury the capacity curves in printed computer output files.

**STATE OF FLORIDA
DEPARTMENT OF TRANSPORTATION
MATERIALS AND RESEARCH**

DISTRICT : 3
ROAD NO : SR 22
COUNTY : BAY

PROJECT NAME : _____
FINANCIAL PROJECT ID : _____

DATE OF SURVEY : 2/15/2018-5/1/2018
SURVEY MADE BY : SOIL SURVEY, INC.
SUBMITTED BY : LEIA T. CROSSWELL, P.E.

CROSS SECTION SOIL SURVEY FOR THE DESIGN OF ROADS
SURVEY BEGINS STA. : 125+87 SURVEY ENDS STA. : 442+67
REFERENCE: BASELINE SURVEY

STRATUM NO.	NO. OF TESTS	ORGANIC CONTENT		MOISTURE CONTENT		SIEVE ANALYSIS RESULTS					ATTENBERG LIMITS (%)		DESCRIPTION	CORROSION TEST RESULTS			PH			
		%	NO. OF TESTS	%	NO. OF TESTS	20	40	60	100	200	LIQUID	PLASTIC		RESISTIVITY	CHLORIDE	SULFATES				
						NO. OF TESTS	NO. OF TESTS	NO. OF TESTS	NO. OF TESTS	NO. OF TESTS	NO. OF TESTS	NO. OF TESTS	NO. OF TESTS	NO. OF TESTS	NO. OF TESTS	NO. OF TESTS	NO. OF TESTS	NO. OF TESTS		
1	0	0	0	0	0	0	0	0	0	0	0	0	0	0	0	0	0	0	0	
2	0	0	0	0	0	0	0	0	0	0	0	0	0	0	0	0	0	0	0	
3	7	3.2-4.4	7	8-20	7	94-100	86-94	65-71	34-45	15-21	0	0	0	0	0	0	0	0	0	6.4-8.3
4	3	1.2-2.2	4	15-25	4	84-100	71-93	60-80	53-82	37-45	4	25-38	5-9	A-4	0	0	0	0	0	8.4-8.9
5	0	0	0	0	0	0	0	0	0	0	0	0	0	0	0	0	0	0	0	7.5-8.2
6	3	22-40	3	47-150	3	100	88-92	73-79	60-68	51-55	3	25-33	10-15	A-8	0	0	0	0	0	0
7	0	0	0	0	0	0	0	0	0	0	0	0	0	0	0	0	0	0	0	0
8	3	16-20	3	20-58	3	99-100	97-99	88-97	77-80	10-15	0	0	0	A-2.4	0	0	0	0	0	4.6-5.2
9	0	0	0	0	0	0	0	0	0	0	0	0	0	0	0	0	0	0	0	0

EMPAVEMENT AND SUBGRADE MATERIAL

STRATA BOUNDARIES ARE APPROXIMATE MAKE FINAL CHECK AFTER GRADING

▲ - WATER TABLE ENCOUNTERED
 ▼ - ESTIMATED SEASONAL HIGH GROUNDWATER LEVEL
 GNE - GROUND WATER NOT ENCOUNTERED

The material from Stratum Number 1 is Rock Base under Asphaltic Concrete.

The material from Stratum Number 2 appears satisfactory for use in the embankment when utilized in accordance with Standard Plans, Index 120-001.

The material from Stratum Number 3 appears satisfactory for use in the embankment when utilized in accordance with Standard Plans, Index 120-001. However, this material is likely to retain excess moisture and may be difficult to dry and compact. It should be used in the embankment above the water level existing at the time of construction.

This material may not be used in the subgrade portion of the roadbed due to its organic content.

The materials from Stratum Numbers 4 and 5 are plastic materials and shall be removed in accordance with Standard Plans, Index 120-002. They may be placed above the project rather than full depths for short distances.

The material from Stratum Numbers 6 and 8 is ORGANIC/A-8 material and shall be removed in accordance with Standard Plans, Index 120-002, except where noted in the cross sections.

The material from Stratum Number 7 is highly plastic material and shall be removed in accordance with Standard Plans, Index 120-002. It may be used within the project limits as indicated in Standard Plans, Index 120-001 only when encountered within the project limits and is not to be used when obtained from outside the project limits.

The material from Stratum Number 9 is the Natural Limestone Formation. Special tools and equipment may be required to excavate and/or de-water this material.

The * ... * indicates an unmeasured parameter.

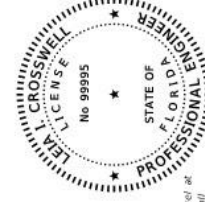

THIS ITEM HAS BEEN DIGITALLY SIGNED AND SEALED BY
Leia T. Crosswell
 2018.10.11 8:31:01 -400

ON THE DATE ADJACENT TO THE SEAL PRINTED COPIES OF THIS DOCUMENT ARE NOT CONSIDERED SIGNED AND SEALED AND THE SIGNATURE MUST BE VERIFIED ON ANY ELECTRONIC COPIES.

SOIL SURVEY, INC.
 321 EAST 2ND STREET
 TALLAHASSEE, FL 32301
 CERTIFICATE OF AUTHORIZATION: 12235
 LEIA T. CROSSWELL, P.E. NO. 99995

DATE	DESCRIPTION	REVISIONS	LEIA T. CROSSWELL, P.E. P.E. NO. 99995	STATE OF FLORIDA DEPARTMENT OF TRANSPORTATION	SHEET NO.
			SOIL SURVEY, INC. 321 EAST 2ND STREET TALLAHASSEE, FL 32301 CERTIFICATE OF AUTHORIZATION: 12235	ROAD NO. SR 22 COUNTY BAY FINANCIAL PROJECT ID 123456-1-2-01	GR-1

Figure 29, Typical Report of Tests Sheet

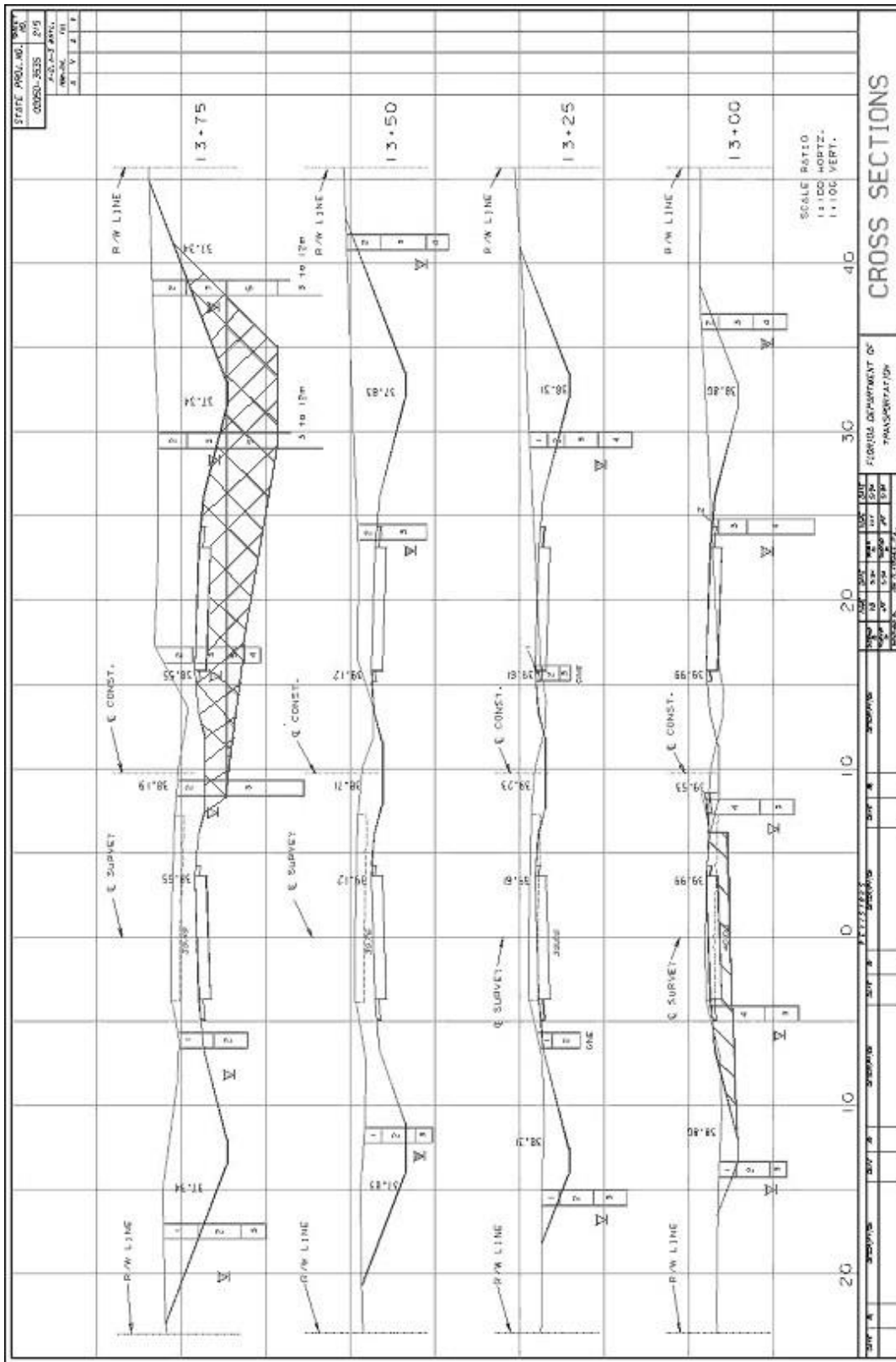

Figure 30, Typical Roadway Cross-Section Sheet (Required border may differ)

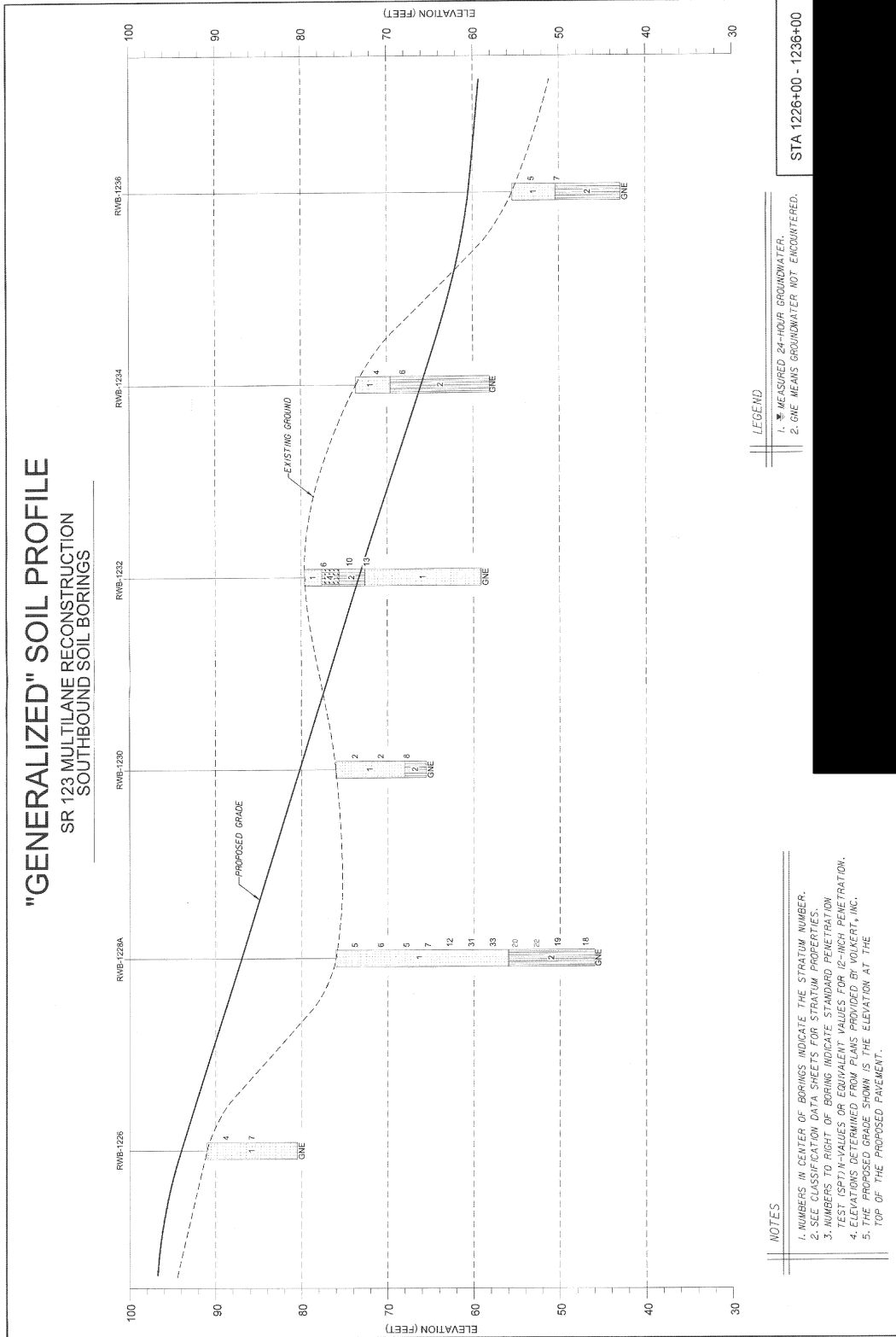

Figure 31, Generalized Soil Profile Example

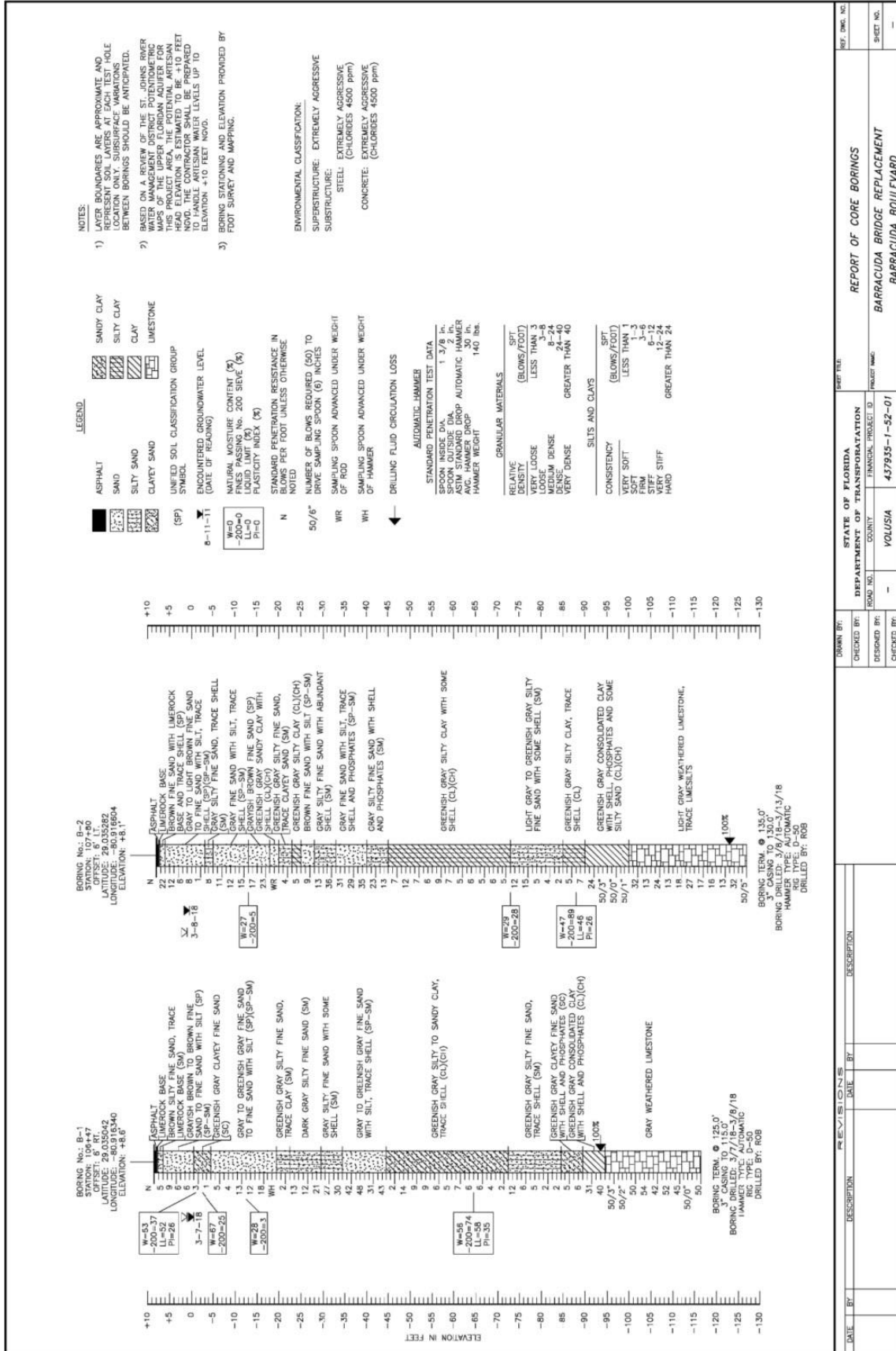

Figure 32, Typical Report of Core Borings (or Report of SPT Borings) Sheet

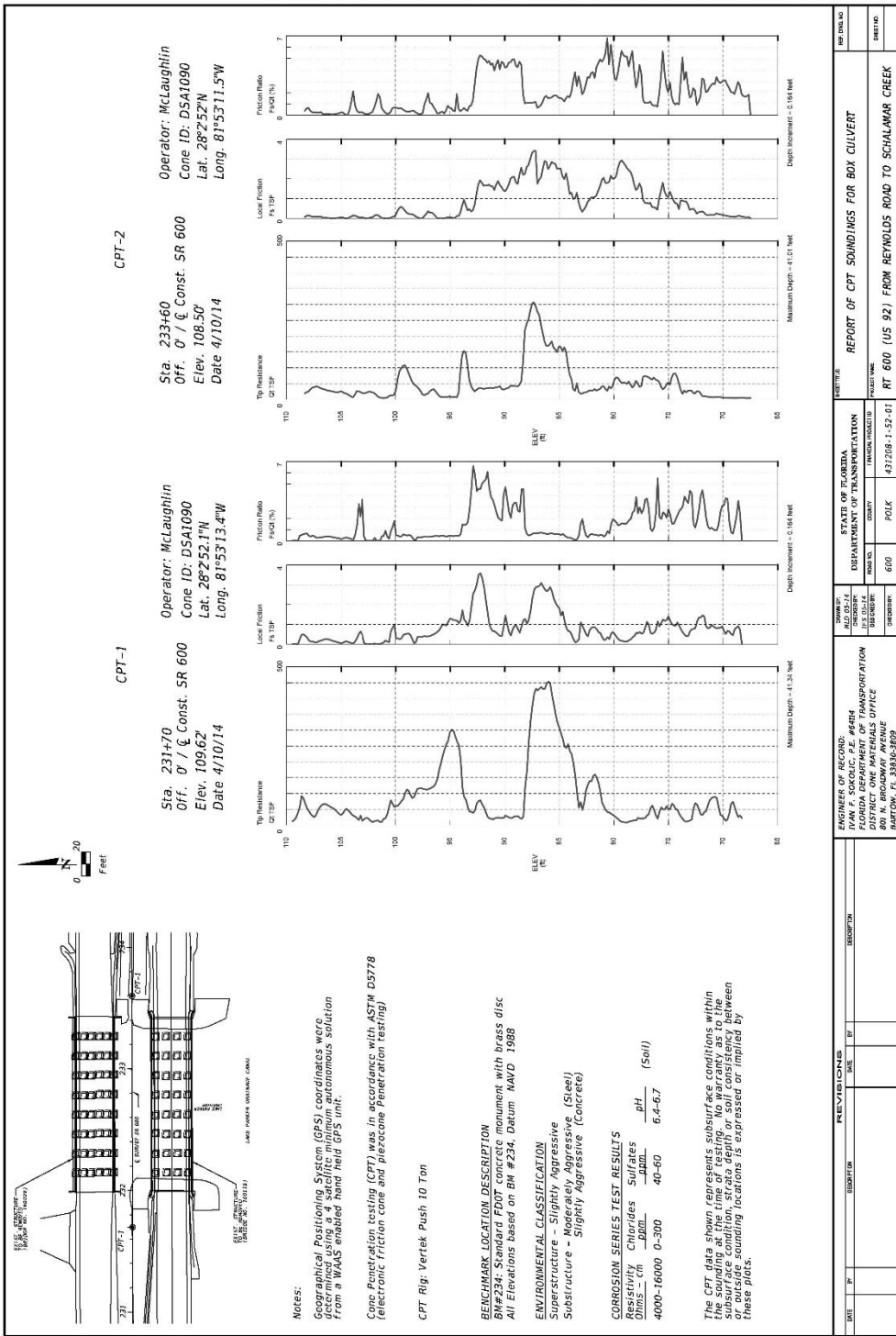

Figure 33, Typical Report of Cone Soundings Sheet (Required border may differ)











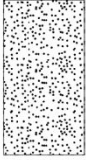
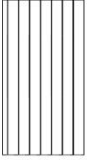



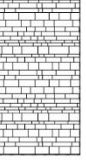
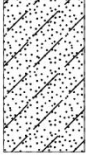
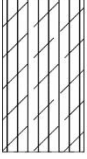
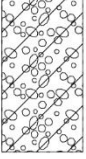

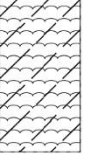
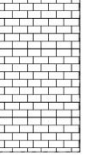
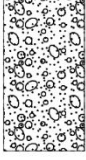
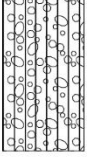
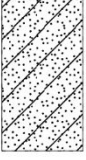

<i>SAND</i> 	<i>SILT</i> 	<i>CLAY</i> 	<i>GRAVEL</i> 	<i>SHELL</i> 	<i>SOFT LIMESTONE</i> 
<i>Clayey SAND</i> 	<i>Clayey SILT</i> 	<i>Gravelly CLAY</i> 	<i>Clayey GRAVEL</i> 	<i>Clayey SHELL</i> 	<i>HARD LIMESTONE</i> 
<i>Gravelly SAND</i> 	<i>Gravelly SILT</i> 	<i>Sandy CLAY</i> 	<i>Sandy GRAVEL</i> 	<i>Sandy SHELL</i> 	<i>SandStone</i> 
<i>Shelly SAND</i> 	<i>Shelly SILT</i> 	<i>Shelly CLAY</i> 	<i>Shelly GRAVEL</i> 	<i>Gravelly SHELL</i> 	<i>COQUINA</i> 
<i>Silty SAND</i> 	<i>Sandy SILT</i> 	<i>Silty CLAY</i> 	<i>Silty GRAVEL</i> 	<i>Silty SHELL</i> 	<i>MUCK/ PEAT</i> 
<i>ORGANIC SAND</i> 	<i>Cemented SAND</i> 	<i>DEBRIS/ TRASH</i> 	<i>VOID</i> 		

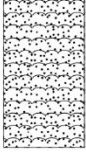
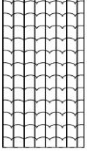
Figure 34, Standard Soil Type Symbols

Table 6, Applicability of Standard Soil Type Symbols

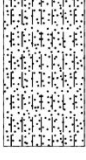
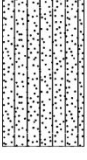
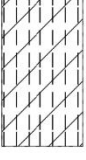
Symbol	Soil Type
SAND	Sand with $\leq 12\%$ fines
Clayey SAND	Sand with 12% to 50% Clay
Gravelly SAND	Sand with $> 30\%$ Gravel
Shelly SAND	Sand with $>30\%$ Shell
Silty SAND	Sand with 12% to 50% Silt
SILT	Silt with $LL < 50$
Clayey SILT	Elastic Silt
Gravelly SILT	Silt with $> 30\%$ Gravel
Sandy SILT	Sand/Silt mixture with $>50\%$ Silt
Shelly SILT	Silt with $>30\%$ Shell
CLAY	Fat Clay
Gravelly CLAY	Clay with $> 30\%$ Gravel
Sandy CLAY	Clay with $> 30\%$ Sand
Shelly CLAY	Clay with $>30\%$ Shell
Silty CLAY	Clay with $> 30\%$ Silt
GRAVEL	Gravel with $\leq 12\%$ fines
Clayey GRAVEL	Gravel with 12% to 50% Clay
Sandy GRAVEL	Gravel with $> 30\%$ Sand
Shelly GRAVEL	Gravel with $>30\%$ Shell
Silty GRAVEL	Gravel with 12% to 50% Silt
SHELL	Shell with $\leq 12\%$ fines
Silty SHELL	Shell with 12% to 50% Silt
COQUINA	Cemented Coquina
SANDSTONE	Sandstone
MUCK/PEAT	Highly Organic Soils with Organic Content $> 20\%$
Organic SAND	Sand with Organic Content = 5% to 20%
Soft LIMESTONE	Limestone with $N \leq 50$
Hard LIMESTONE	Limestone with $N > 50$
VOID	Apparent Cavity or Void

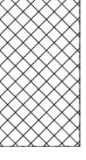
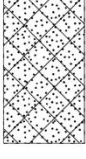
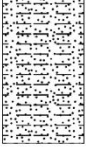
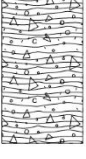
Chapter 10

10 Construction and Post-Construction

The Geotechnical Engineers' involvement does not end with the completion of the final report; they may also be involved in the preconstruction, construction and maintenance phases of a project.

During construction, in-situ materials and construction methods for geotechnical elements must be inspected to assure compliance with the design assumptions and the project specifications. Such inspection tasks include subgrade and/or embankment compaction control, assurance of proper backfilling techniques around structural elements, and routine footing, drilled shaft, and piling installation inspection. While the Geotechnical Engineers may not regularly be involved in these inspections, they must assure that sufficient geotechnical information is provided to a qualified inspector. They must also be prepared to review the procedures and the inspection records if needed.

Modification for Non-Conventional Projects:

Delete the first and second paragraphs, and insert the following:

During construction, in-situ materials and construction methods for geotechnical elements must be inspected to assure compliance with the design assumptions and the project specifications. Such inspection tasks include subgrade and/or embankment compaction control, assurance of proper backfilling techniques around structural elements, and routine footing, drilled shaft, and piling installation inspection.

Where existing structures may be sensitive to vibrations or movement, pre-construction and post-construction surveys of the structures will be needed. Mitigating action shall be taken to reduce the impact. It may also be required to monitor construction-induced vibrations, groundwater level changes, and/or settlement or heave of the structures. A qualified Geotechnical Engineer should be involved in the placement of these monitoring devices as well as the interpretation of the resulting data.

On major projects especially, several other aspects of the construction phase may require significant input from the Geotechnical Engineer. Involvement of the Geotechnical Engineer is often required post-construction as well. Tasks, which in all cases require the direct involvement of a Geotechnical Engineer, include those discussed below.

10.1 Dynamic Pile Driving Analysis

The wave equation uses a mass-spring-dashpot system to dynamically model the behavior of a pile subjected to impact driving. The latest version of the WEAP computer program is recommended. Based on pile driving equipment data supplied by the contractor, the Geotechnical Engineer can use the wave equation program to determine the relationship between ultimate pile capacity and the penetration resistance (the number of blows per foot). The program also determines the relationship between stresses induced in the pile during driving and the penetration resistance. These relationships are then used to determine the suitability of the proposed driving system and to determine in the field if adequate pile capacity can be obtained.

10.2 Dynamic Monitoring of Pile Driving

Measurements of the dynamic pile response can be obtained during driving by using Embedded Data Collectors (EDCs) or the Pile Driving Analyzer (PDA). Refer to ASTM D 4945 (AASHTO T 298). These measurements are used to determine:

1. Pile capacity
2. Driving stresses and probable damage to the pile
3. Energy transfer to the pile and therefore the efficiency and suitability of the pile driving system.
4. The soil parameters used in wave equation analysis for determining the installation criteria for subsequent piles when applicable.
5. Possible reasons for pile installation problems.

On major projects, dynamic monitoring of pile driving can be used together with static load tests to confirm design-bearing capacities. Quite often, the use of dynamic measurements decreases the number of static load tests required. This will result in time, as well as, cost savings to a load test program. On smaller projects, dynamic measurements alone may serve as the load testing method. The advancement in the design of the PDA system in recent years has made this equipment a reliable tool for the field-testing and inspection of driven piles when combined with signal matching analysis.

The Embedded Data Collector (EDC) system developed under FDOT sponsored research utilizes internal strain and acceleration measurements at both the top and bottom of the pile. The currently required method of analysis published by Tran et. al. utilizes the data from the top and bottom internal gages to determine the pile capacity and is considered equivalent to signal matching analysis. (Smart Structures, Inc. refers to this method as the FDOT Method because the patent rights are assigned to FDOT) Refer to [Standard Plans, Index 455-003](#).

10.3 Load Tests

Many major projects involving driven piles or drilled shafts incorporate load tests to reduce uncertainty and/or increase resistance factors. These tests are conducted to verify that actual pile or shaft response to loading is as assumed by the designer, and to ensure that the measured resistance is not less than the nominal resistance computed during design. The use of resistance factors associated with load testing requires verifying and mobilizing the design side shear and end bearing values during the load test. The project Geotechnical Engineers should be involved in the load testing itself, and the interpretation of the resultant data. They should also be prepared to modify designs if the load tests fail to verify and fully mobilize the design values.

Extrapolating the trend of an under loaded load test does change the measured resistance, and therefore, design values based on such extrapolated trends must not be used with a load testing resistance factor.

10.3.1 Static Load Tests

Three types are commonly used based on type of loading: axial compression (refer to ASTM D 1143) (See [Figure 35](#)), axial tension (refer to ASTM D 3689), or lateral load (refer to ASTM D 3966). In each case, the test typically consists of a jack/load cell system to apply a loading based on the desired application against a reaction system and measuring the resulting displacement.

10.3.2 Statnamic Load Tests

Statnamic applies axial or lateral loads of 30 to over 5,000 tons (0.3 to >44 MN) (See [Figure 36](#) and [Figure 37](#) and). The load application is between a static load and a dynamic load. The associated dynamic and rate of loading effects differ by soil type and are subtracted, resulting in the equivalent static load curve. No reaction piles are required. The duration of loading is on the order of 0.1 seconds. The load cell and LVDTs provide direct measurements of load-displacement behavior. Drilled shafts tested by the Statnamic method should be instrumented with electronic resistance strain gauges at various elevations to measure load transfer characteristics. Statnamic produces load versus displacement results immediately on site. ASTM Standard D 7383, Procedure A describes this type of testing.

10.3.3 Other Rapid Load Tests

Alternative Axial Compressive Force Pulse (Rapid) Load Tests are described in ASTM Standard D 7383, Procedure B; however, these alternative test methods have not been adequately calibrated to static load test results to determine an appropriate resistance factor for FDOT projects.

10.3.4 Osterberg Load Tests

The Osterberg Load Cell is cast into the bottom of a pile or anywhere in a drilled shaft (See [Figure 38](#)). The cell expands to jack against the foundation's end bearing capacity so no reaction system is required. The cell can be placed above the bottom of a drilled shaft to equal out the loading. Or multiple cells can be used to isolate various zones. Currently there is no ASTM standard on this type of testing.

10.4 Pile/Drilled Shaft Damage Assessment

Various test methods are available to assess the quality of the in-place deep foundation unit. These quality assurance tests need to be performed by qualified personnel and the results need to be analyzed and interpreted by experienced engineers in order to provide meaningful results.

10.4.1 Pile Integrity Testing

The use of low strain impact non-destructive testing (pulse-echo, etc.) has become common to determine cracks or breaks in driven piles caused by high stresses, severe necking or large voids which might have occurred during the construction of drilled shafts, or the actual length of piles for existing structures (one such product, the P.I.T. from Pile Dynamics, Inc., is shown in [Figure 39](#)). The

Geotechnical Engineer should evaluate results of these tests. Refer to ASTM D 5882.

10.4.2 Crosshole Sonic Logging

Crosshole Sonic Logging has been used to determine the integrity of drilled shafts and slurry walls. The test involves lowering probes to the bottom of water-filled access tubes, and recording the compression waves emitted from a source probe in one tube by a receiver in another tube at the same or different (offset) elevations. The probes are pulled back to the surface at the same rate, and this procedure is repeated at various test configurations in order to obtain a profile of the entire depth of the shaft. Potential defects are indicated by delays in the signal arrival time and lower energies at a given test depth. This test method is limited to detecting defects between the access tubes used during each test. Since access tubes are needed for this test, the design of the reinforcement cage must take the total number and location of these tubes into account. Concrete mixtures producing large amounts of bleed-water have caused CSL tests to indicate zones with apparently poor quality concrete. Refer to ASTM D 6760.

10.4.3 Gamma-Gamma Density Logging

Gamma-gamma density logging is performed using a radioactive source and receiver within the same access tube. It is used to measure changes in uniformity of the cylindrical zone surrounding the outside of the access tube. The radius of the tested zone is dependent on the equipment used. This test method can be used to detect anomalies outside the cage of reinforcing steel.

10.4.4 Thermal Integrity Testing of Drilled Shafts (TITDS)

Thermal integrity testing uses the heat of the hydrating concrete to differentiate concrete from soil. It can scan the shaft concrete both inside and outside the reinforcing cage within 1 to 2 days after the shaft is poured. As the temperature profiles obtained from logging tubes are matched to 3-D thermal modeling information, the configuration of the completed shaft is determined. Refer to ASTM D 7949.

10.5 Drilled Shaft Construction

Using the wet method during construction of a drilled shaft, slurry is used to maintain a positive head inside the open shaft in order to keep the hole open prior to placement of concrete. In order to ensure the slurry shall meet the requirements to perform properly, the following control tests shall be performed: density, viscosity, sand content, and pH of the slurry. Refer to FM 8-R13B-1, 8-R13B-2, 8-R13B-3, and 8-R13B-4, respectively.

In order to evaluate the quality of the rock directly below the shaft excavation, rock cores shall be taken to a minimum depth of 5 feet and up to 20 feet below the bottom of the drilled shaft excavation of redundant drilled shafts or three shaft diameters below the bottom of the drilled shaft excavation for nonredundant shafts. Coring shall be performed in accordance with ASTM D 2113 using a double wall or

triple wall core barrel. The core barrel shall be designed to provide core samples 4 inches in diameter or larger, and allow the cored material to be removed in an undisturbed state. Refer to ASTM D 2113 and ASTM D 5079.

Guidance for the interpretation of drilled shaft tip grouting results can be found in the research publication “Load and Resistance Factors Design (LRFD) Resistance Factors for Tip Grouted Drilled Shafts, BDV25-977-37”, Final Report, 2019

10.6 Shaft Inspection Device (SID)

A piece of equipment that is used to inspect the bottom cleanliness of drilled shafts prior to placement of concrete through the use of an inspection bell which houses a high resolution video camera (See [Figure 40](#)) The inspection bell is lowered from a service platform to the bottom of the shaft, and the operator can view the condition of the bottom via the camera. The bell is fitted with a depth gage to indicate the thickness of debris on the shaft bottom. Sufficient views of the shaft bottom are used to inspect a statistically significant portion of the shaft bottom. The Shaft Inspection Device uses pressurized nitrogen to overcome the static head of the drilling fluids, purge the fluids from the camera bell, and provide an unobstructed view of the shaft. A small reduction in air pressure would allow drilling fluid to slowly enter the bell.

When the shaft bottom is flat (as required in Specifications) and the bell is plumb, a layer of water or drilling fluid in the bell can be used measure the thickness of sediments mounds "away" from the sediment depth gauge. When the fluid rises to the 1/2" pin on the gauge, the percentage of the view covered with sediment deposits thicker than 1/2" may be estimated; these sediments are above the fluid level. When the 1/2" depth pin is missing the first mark (1.0 cm) depth must be used. The same procedure may also be used to determine whether any portion of the view contains sediments in excess of 1-1/2" [4.0 cm] thick. Special care must be used to ensure the fluid does not erode the sediment as it enters the bell, especially if the operator attempts to fill the bell with water using the water jets intended for flushing these sediments, instead of filling the bell with drilling fluid as described above.

10.7 Field Instrumentation Monitoring

Field instrumentation is often used during construction and afterward to assure that actual field conditions are in agreement with the assumptions made during design or to monitor changes in conditions, which may occur during construction. Refer to **Chapter 7** for descriptions of some of the more common types of field instrumentation.

All field instrumentation should be installed, and have readings taken, by qualified personnel under the supervision of a Geotechnical Engineer. A Geotechnical Engineer should interpret all data and recommend any necessary action. For example, in projects where surcharging or precompression is required to improve the foundation soils, waiting periods are required. It is essential that the Geotechnical Engineer communicate with the construction engineer when required waiting periods determined from actual measurements differ from predicted periods so that the project schedule can be properly adapted.

10.8 Troubleshooting

No matter how carefully a project was investigated and designed, the possibility exists that unforeseen problems will arise during construction or afterward. The Geotechnical Engineer should be prepared to investigate when such problems occur. He should then recommend changes in design or construction method if necessary to minimize construction down time. If it is determined that maintenance problems have a geotechnical basis, he should recommend remedial actions that will eliminate, or at least reduce, the problems.

10.9 Records

Complete records of the geotechnical aspects of the construction and maintenance phases of a project should be kept. Any specialized construction procedures or design changes should be noted. Construction and maintenance problems and their solutions should be described in detail. This information should then be provided to the District Geotechnical Engineer and the State Geotechnical Engineer in Tallahassee.



Figure 35, Static Load Test



Figure 36, Axial Statnamic Load Test



Figure 37, Lateral Statnamic Load Test

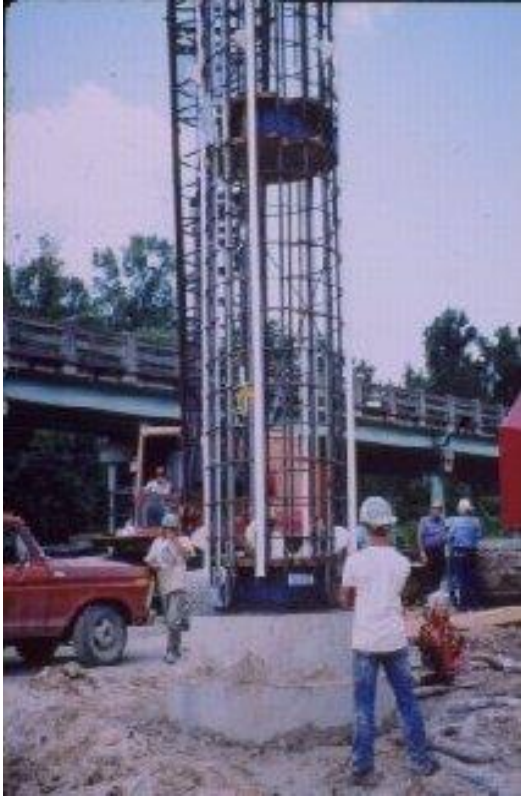

Figure 38, Osterberg Load Cells



Figure 39, Pile Integrity Tester (After PDI, 1993)



Figure 40, Shaft Inspection Device

10.10 References

1. Butler, H.D. and Hoy, Horace E.; The Texas Quick-Load Method for Foundation Load Testing - User's Manual, FHWA-IP-77-8, 1976.
2. Goble, G.G. & Rausche, Frank, GRLWEAP, Wave Equation Analysis of Pile Foundations, GRL & Associates, Inc., 1991.
3. Shih-Tower and Reese, Lymon C.; Com624P – Laterally Loaded Pile Analysis Program for the Microcomputer Version 2.0, FHWA-SA-91-048.
4. Kyfor, Zenon G., Schmore, Austars R., Carlo, Thomas A., and Baily, Paul F.; Static Testing of Deep Foundations, FHWA-SA-91-042, 1992.
5. Dunicliff, John, Geotechnical Instrumentation for Monitoring Field Performance, NCHRP Synthesis 89, Transportation Research Board, 1993.
6. Osterberg, J.O.; The Osterberg CELL for Load Testing Drilled Shafts and Driven Piles, FHWA-SA-94-035, 1995.
7. Hannigan, P.J., Goble, G.G., Thendean, G., Likins, G.E., and Rausche, F., Manual on Design and Construction of Driven Pile Foundations, FHWA-HI-97-013 and 14, 1996.
8. Pile Driving Analyzer Manual, PAK, Pile Dynamics, Inc., Cleveland, Ohio, 1997.
9. Paikowsky, Samuel G. and Tolosko, Terry A.; Extrapolation of Pile Capacity From Non-Failed Load Tests, FHWA-RD-99-170, 1999.
10. Dunicliff, John, Geotechnical Instrumentation, FHWA-HI-98-034, 1998.

10.11 Specifications and Standards

<u>Subject</u>	<u>ASTM</u>	<u>AASHTO</u>	<u>FM</u>
Viscosity of Slurry	-	-	8-RP13B-2
PH of Slurry	-	-	8-RP13B-4
Standard Test Method for Piles Under Static Axial Compressive Load	D 1143	-	-
Standard Test Method for Individual Piles Under Static Axial Tensile Load	D 3689	-	-
Standard Test Method for Piles Under Lateral Loads	D 3966	-	-
Standard Test Method for Density of Bentonitic Slurries	D 4380	-	8-RP13B-1
Standard Test Method for Sand Content by Volume of Bentonitic Slurries	D 4381	-	8-RP13B-3
Standard Test Method for High-Strain Dynamic Testing of Piles	D 4945	T 298	-
Standard Practices for Preserving and Transporting Rock Core Samples	D 5079	-	-

<u>Subject</u>	<u>ASTM</u>	<u>AASHTO</u>	<u>FM</u>
Standard Test Method for Low Strain Integrity Testing of Piles	D 5882	-	-
Standard Test Method for Integrity Testing of Concrete Deep Foundations by Ultrasonic Crosshole Testing	D 6760	-	-
Standard Test Methods for Axial Compressive Force Pulse (Rapid) Testing of Deep Foundation	D 7383	-	-
Standard Test Methods for Thermal Integrity Profiling of Concrete Deep Foundations	D 7949	-	-

Chapter 11

11 Design-Build Projects

Typically, the compressed procurement schedule for Design-build limits the available time for a full geotechnical investigation to be performed prior to issuing the RFP for a Design-build project. A sufficient number of geotechnical borings needs to be attached to the RFP to give DB Teams an understanding of the geotechnical conditions for the project. When possible, a more extensive geotechnical investigation should be performed for Design-build projects than for normal design-bid-construct projects. The total effort may exceed 120% of a normal investigation in order to assist the Teams in offering their most cost effective solution for the project. During the design and construction phase, the Design-build team performs the design specific investigation. The Design-build team shall be responsible for its own analysis of any and all data used by the team.

11.1 Planning and Development Phase:

11.1.1 Department's Geotechnical Engineer Responsibilities

The Department's geotechnical engineer gathers data on the conditions at the site sufficient for the design-build team to make a realistic proposal. It is preferred to perform as complete a geotechnical field and laboratory investigation as time permits, and provide the data to the Design-build teams for their use in preparing preliminary designs and technical proposals. Upon completion of the preliminary subsurface investigation, the information obtained must be compiled in a format, which will present the data collected to the various design-build teams. The evaluation of the subsurface data should establish the limits of areas of relative uniformity for load testing. The limited geotechnical data collected prior to bidding is provided to prospective teams for information only. Preliminary geotechnical reports prepared by the Department for use by Design-Build Teams should not include analysis of the geotechnical information or any suggestions for handling any potential problems.

11.1.2 Design-build Team Responsibilities

Design-Build Teams are not yet selected at this time. Potential teams submit letters of interests from which a short list is determined.

11.2 Technical Proposals & Bidding Phase

11.2.1 Department's Geotechnical Engineer Responsibilities

The Department's geotechnical engineer answers questions from the design-build team through the project manager, reviews technical proposals and provides recommendations to other technical reviewers regarding the completeness and appropriateness of proposed supplemental field testing, ground modification and load testing programs, etc.

11.2.2 Design-Build Team Responsibilities

Short listed Design-Build Teams perform analyses of the preliminary geotechnical data and any additional data they gather independently. The teams determine the appropriate design and construction methods based on their approach/equipment, the requirements provided in this document and the Request For Proposals for the project; submit technical proposals and bids.

11.3 Design/Construction Phase

11.3.1 Department's Geotechnical Engineer

The Department's geotechnical engineer reviews design and construction methods for compliance with the contract documents and performs verification testing as required.

11.3.2 Design-Build Team

The design-build team meets the requirements set forth in the contract documents.

Appendix A

Determination of Design Side Resistance for Drilled Shafts & Auger Cast Piles Socketed in the Florida Limestone Based on Rock Core Testing

DETERMINATION OF DESIGN SIDE SHEAR RESISTANCE FROM TEST DATA TO DESIGN PARAMETERS FOR DRILLED SHAFTS & AUGER CAST PILES SOCKETED IN FLORIDA LIMESTONE

Remark: This article is an updated version of the papers Peter Lai presented in the 1996 & 1998 Design Conferences, as well as the inclusion in the Appendix of the FDOT's Soils and Foundation Handbook, 2002. This update is to clarify the contents that are most often misinterpreted by engineers and present an example.

Introduction

The variable strength properties of the Florida limestone formation always prompted the question of what design side shear resistance should be used for a drilled shaft socketed in it. Some engineers even decide that doing any tests on rock cores obtained from the project site is senseless because of the uncertainties associated with a spatial variability of the limestone. This presentation provides a method for determining a reasonable design side shear resistance value from a statistically significant number of ASTM D 7012 (Method D) unconfined compression and ASTM D 3967 (with $t/D \geq 1.0$) splitting tensile tests.

Design Method

On the basis of the study done by the University of Florida, the following method proposed by Prof. McVay seems to be the most appropriate for the Florida limestones. The ultimate side shear resistance for the portion socketed in the rock is expressed as

$$f_{su} = \frac{1}{2} * \sqrt{q_u} * \sqrt{q_t} \quad (1)$$

where f_{su} is the ultimate side shear resistance,
 q_u is the unconfined compression strength of rock core, and
 q_t is the splitting tensile strength (McVay, 1992).

$$(f_{su})_{DESIGN} = REC * f_{su} \quad (2)$$

To consider the spatial variations of the rock qualities, the average **REC** (% recovery in decimal) is applied to the ultimate unit side shear resistance, f_{su} , and the product is used as the design ultimate side shear resistance.

This method has been used by the Department engineers for several years now and it has provided reasonable estimates of design side shear resistance as compared with load test data. However, there are some uncertainties of how to obtain the q_u , q_t and **REC** values.

Rock Sampling and Laboratory Testing

A critical component of this design method work is the quality of the rock cores. The rock core sample quality is dependent upon the sampling techniques as well as the size and type of the core barrel used. Due to the porous nature of the Florida limestone, the larger diameter samplers are more favorable than the smaller diameter samplers since they will provide more representative specimens. Therefore, in the FDOT's 'Soils and Foundation Manual', a minimum core barrel size of 61 mm (2.4") I.D. is required and a 101.6 mm (4") I.D. core barrel is recommended for better evaluation of the Florida limestone properties. Furthermore, the manual also requires a triple or double barrel as a minimum to have better percentage recovery as well as RQD depending on the core size. After obtaining the better quality core samples, the engineer can select more representative specimens for laboratory unconfined compression and splitting tensile tests. Thus better shear strength test data can be obtained for more accurate design side shear resistance.

Variability

The variability of the Florida limestone formations is very large. To obtain representative design values for drilled shafts, one has to obtain a lot of rock core samples. The number of specimens needed for the design depends on the desired level of confidence. The following relationship identifies the amount of standard error (E) in terms of the number of laboratory specimen tested (n), the confidence level (t), and the standard deviation of strength test (σ) can be expressed as (Smith, 1986),

$$E = \frac{t\sigma}{\sqrt{n}} \quad (3)$$

This equation is useful to gauge the number of core specimens needed for the design confidence level, however, since the variability of the rock strengths is so big that the mean value of the samples cannot be used for design most of the time. As an aid, plotting a frequency distribution (histogram) of the rock core test results (both the q_u and q_t results individually) can assist the designer in determining a sufficient number of tests in order to identify a clear distribution (i.e. normal, log-normal, etc.)

Check the Big Picture

First the borings and core recoveries and test results for a project need to be reviewed for uniformity. Determine whether the test results are reasonably consistent across the project, whether there are different approximate areas or sites (Paikowsky, 2004) within the project, whether there are two or more reasonably different strata, or whether the project is so variable that each boring appears to be from a different site. A histogram of the rock core test results can identify secondary peaks in the data which may indicate a secondary distribution exists within the project site. This would indicate that there are significant site variabilities which warrant separating the data into multiple sets to represent different areas or strata within the project.

When borings show extreme variability, the engineer needs to prudently reconsider whether the drilled shaft design is likely to be appropriate for each and every pier on the

project. When the project location subsoils are so variable trends cannot be reasonably discerned, more data, or a different foundation type, is needed.

Data Reduction Method

The data reduction method presented here is intended to provide a means to obtain a more reliable q_u , q_t and REC values that can provide realistic design side shear resistance for the rock formations. This method involves the following steps of analyses for each area or site within the project limits.

1. Find the mean and standard deviations of both the q_u and q_t strength test data sets.
2. Establish the upper and lower limits of each type of strength test data set by using the mean values, +/- one standard deviation.
3. Discount all the data in the data sets that are larger or smaller than the established upper and lower limits, respectively.
4. Recalculate the mean and standard deviation of the data within the boundaries of each modified strength test data set computed above.
5. Establish the upper and lower bounds of q_u and q_t by setting the calculated mean value as the design upper bound value and the mean minus one standard deviation as the design lower bound value.
6. Use the q_u and q_t obtained from steps 4 and 5 to calculate the respective upper and lower bounds of the ultimate side shear resistance, f_{su} .
7. Multiply the ultimate side shear resistance f_{su} by the mean REC (in decimal) to account for the spatial variability.
8. Consider these two design boundaries the global side shear resistance values for the area or site within the project.
9. A resistance factor should be applied to these side shear resistance values depending on the construction method used. The following table may be used as a guide to obtain an appropriate a resistance factor for the Load and Resistance Factor Design (LRFD) method.

Drilled Shaft Design Basis	Resistance Factor, ϕ	
	Redundant	Nonredundant
Neglecting end bearing	0.60	0.50
Including 1/3 end bearing	0.55	0.45
Static Load Testing*	0.75	0.65

*Number of load tests required depends on the uniformity of the project.

The engineer should then decide which value is appropriate for the design. For a project with uniform subsurface, a few load tests may qualify the use of the resistance factors listed above. However, if the subsurface at the project is erratic, it requires more tests to qualify for the use of these factors because each area or site within the project limits requires separate load tests. If a representative soil profile cannot be obtained, the number of load tests may be as many as the number of various soil profiles that are existing at the project.

10. Generate a chart to index the global side shear resistance boundary values determined in Step 8 with the boundary SPT N-values performed between core runs. The boundary SPT N-values vary from various geological formations. In general, the lower bound N-value range from 20 to 30 blows per foot and the upper bound ranges from 50 to 100 blows per foot. N-values falling within these boundaries can be used to obtain the design side shear resistance values from the chart. Note that the correlations are for specific site use only since the SPT N-values are being used as indices. See Section 3.2 for SPT and rock core requirements during structure borings.
11. Design the shaft based on local boring logs. When N values are absent, use the design lower bound rock strength to design the drilled shaft socket.

The following example is meant to illustrate the analyses outline above. The data, especially the side shear resistance vs. SPT-N-value chart, are not meant for any real design purposes.

Example: Design a shaft with 48" diameter and in a group of four shafts. Each shaft will support a factored design load of 2,500 kips. Assuming there will not be any load test for the project. Thus, a resistance factor of 0.55 will be used for the design.

Steps 1 to 5 Rock test data reduction

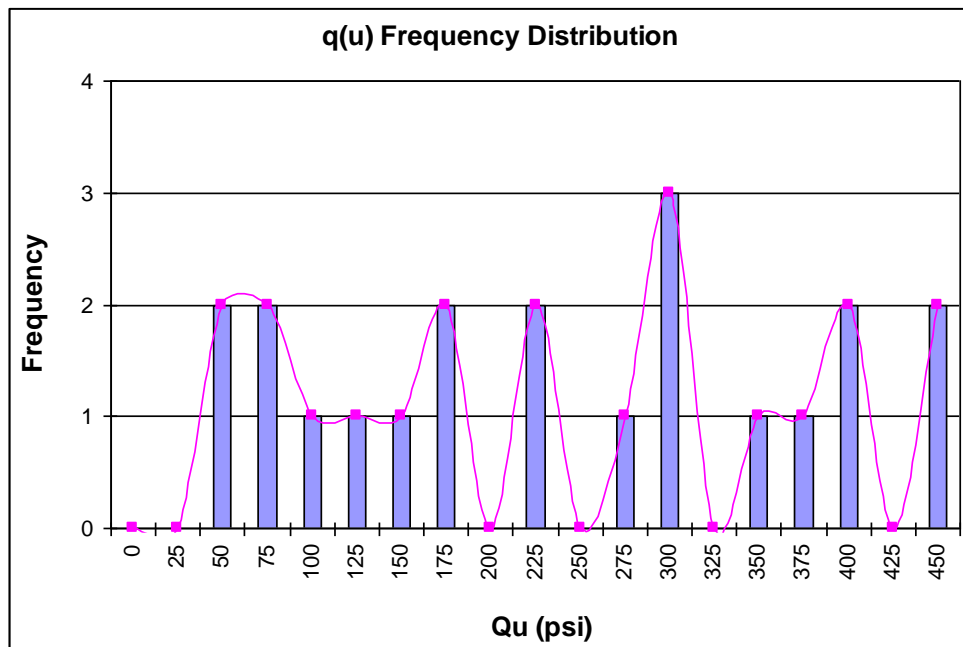

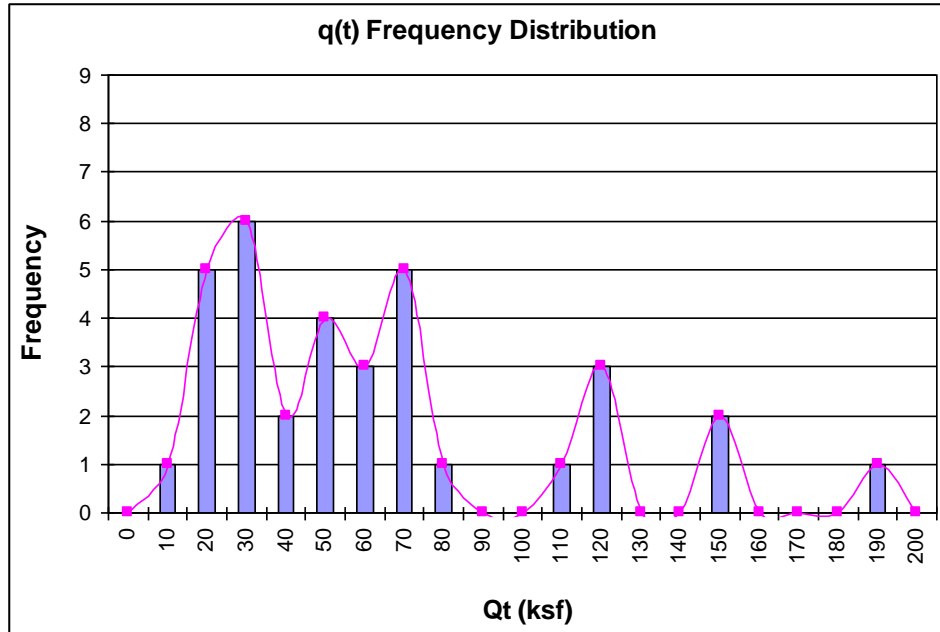

Table 1, EXAMPLE DATA SET

Boring No.	Core Sample Elevations		% REC	q_u , ksf	q_t , ksf
	Top	Bottom			
B-1	-62.24	-65.42	30		32.2
B-1	-72.42	-75.42	67	97.2	27.4
B-1	-82.42	-87.42	13		114.2
B-2	-36.58	-41.58	18	169.1	
B-9	-74.42	-82.42	5		26.5
B-9	-89.42	-94.4	43		24.7
B-9	-89.4	-94.4	43		32.9
S-12	-30	-35	60	211.2	68.4
S-12	-35	-40	48	117.0	19.4
S-12	-50	-55	48		19.6
B-7	-44.4	-52.4	18		43.5
B-7	-92.9	-97.4	98		26.3
B-7	-97.4	-102.4	66		117.5
B-7	-134.4	-142.4	35	140.6	64.7
B-11	-34.2	-39.2	38		144.0
B-11	-34.2	-39.2	38	379.5	189.1
B-11	-34.2	-39.2	38		112.6
B-11	-76.4	-81.4	33		26.3
B-11	-90.4	-95.4	60		68.7
N-14	-40	-43	63	389.4	
B-10	-33.4	-41.4	46	283.5	148.8
B-10	-33.4	-41.4	46		52.7
B-10	-46.4	-51.4	69	444.4	49.9
B-10	-46.4	-54.4	69	212.9	60.5

B-10	-46.4	-51.4	69		65.8
B-8	-48.9	-57.9	48	158.7	55.5
B-8	-48.9	-57.9	48	272.8	54.0
B-8	-48.9	-57.9	48		76.8
B-8	-59.9	-67.9	50	285.1	40.4
B-8	-99.9	-107.9	17		14.1
N-17	-58.1	-63	33	432.0	45.3
S-15	-48.5	-53.5	55	51.4	
S-15	-48.5	-53.5	55		17.5
S-15	-65	-70	61	38.4	7.7
B-6	-64.1	-72.1	51	58.2	12.4
B-6	-74	-82	57	365.4	101.4
B-6	-114	-122	45		21.0
N-25	-58.8	-63.3	85	26.6	
N-25	-68.8	-73.3	80	281.3	
N-25	-73.3	-78.3	47	331.5	
SUM			1941	4745.7	1981.1
MEAN (\bar{x})			48.5	226.0	58.3
STANDARD DEVIATION (σ)				134.3	44.3
UPPER BOUND ($\bar{x} + \sigma$)				360.2	102.6
LOWER BOUND ($\bar{x} - \sigma$)				91.7	14.0

Use the upper and lower bounds of q_u and q_t as guides to limit the data set so that no data are higher than the upper bound value and no data are lower than the lower bound value. The modified data set is presented in the following table

Table 2, **MODIFIED EXAMPLE DATA SET**

Boring No.	Core Sample Elevations		% REC	q_u , ksf	q_t , ksf
	Top	Bottom			
B-1	-62.24	-65.42	30		32.2
B-1	-72.42	-75.42	67	97.2	27.4
B-1	-82.42	-87.42	13		114.2
B-2	-36.58	-41.58	18	169.1	
B-9	-74.42	-82.42	5		26.5
B-9	-89.42	-94.4	43		24.7
B-9	-89.4	-94.4	43		32.9
S-12	-30	-35	60	211.2	68.4
S-12	-35	-40	48	117.0	19.4
S-12	-50	-55	48		19.6
B-7	-44.4	-52.4	18		43.5
B-7	-92.9	-97.4	98		26.3
B-7	-97.4	-102.4	66		117.5
B-7	-134.4	-142.4	35	140.6	64.7
B-11	-34.2	-39.2	38		144.0

B-11	-34.2	-39.2	38	379.5	189.1
B-11	-34.2	-39.2	38		112.6
B-11	-76.4	-81.4	33		26.3
B-11	-90.4	-95.4	60		68.7
N-14	-40	-43	63	389.4	
B-10	-33.4	-41.4	46	283.5	148.8
B-10	-33.4	-41.4	46		52.7
B-10	-46.4	-51.4	69	444.4	49.9
B-10	-46.4	-54.4	69	212.9	60.5
B-10	-46.4	-51.4	69		65.8
B-8	-48.9	-57.9	48	158.7	55.5
B-8	-48.9	-57.9	48	272.8	54.0
B-8	-48.9	-57.9	48		76.8
B-8	-59.9	-67.9	50	285.1	40.4
B-8	-99.9	-107.9	17		14.1
N-17	-58.1	-63	33	432.0	45.3
S-15	-48.5	-53.5	55	51.4	
S-15	-48.5	-53.5	55		17.5
S-15	-65	-70	61	38.4	7.7
B-6	-64.1	-72.1	51	58.2	12.4
B-6	-74	-82	57	365.4	101.4
B-6	-114	-122	45		21.0
N-25	-58.8	-63.3	85	26.6	
N-25	-68.8	-73.3	80	281.3	
N-25	-73.3	-78.3	47	331.5	
SUM			1941	2560.7	1134.9
MEAN			48.5	213.4	43.6
STANDARD DEVIATION				77.0	22.2
LOWER BOUND				136.4	21.5

Step 6 Calculate the ultimate side shear resistance, f_{su}

By using the above q_u and q_t values the following f_{su} values can be calculated;

$$\text{Ult. Mean Value(Upper Boundary)} \quad f_{su} = \frac{1}{2} * \sqrt{213.4} * \sqrt{43.6} = 48.3 \text{ ksf}$$

$$\text{Ult. Lower Value (Lower Boundary)} \quad f_{su} = \frac{1}{2} * \sqrt{136.4} * \sqrt{21.5} = 27.1 \text{ ksf}$$

Steps 7 & 8 Spatial variability consideration and establish the design ultimate side shear boundaries

The design ultimate side shear resistance should also account for the spatial variability of the site by multiplying the mean %REC value (in decimal) to the above mean, which based on FDOT experience is more representative as the high end value, and low values respectively and obtain;

Design Upper Boundary $(f_{su})_{DESIGN} = .485 * 48.3 = 23.4 \text{ ksf}$

Design Lower Boundary $(f_{su})_{DESIGN} = .485 * 27.1 = 13.1 \text{ ksf}$

Step 9 Select the appropriate design resistance factor based on design conditions and whether the design parameters for this site will be verified by a load test.

Step 10 Generate a design side shear resistance chart

Using the above calculated global ultimate design shear resistance together with the lower and upper bound SPT N-values of 25 and 50 (the minimum and maximum SPT values in the rock core data set being evaluated), respectively; the following design chart is generated.

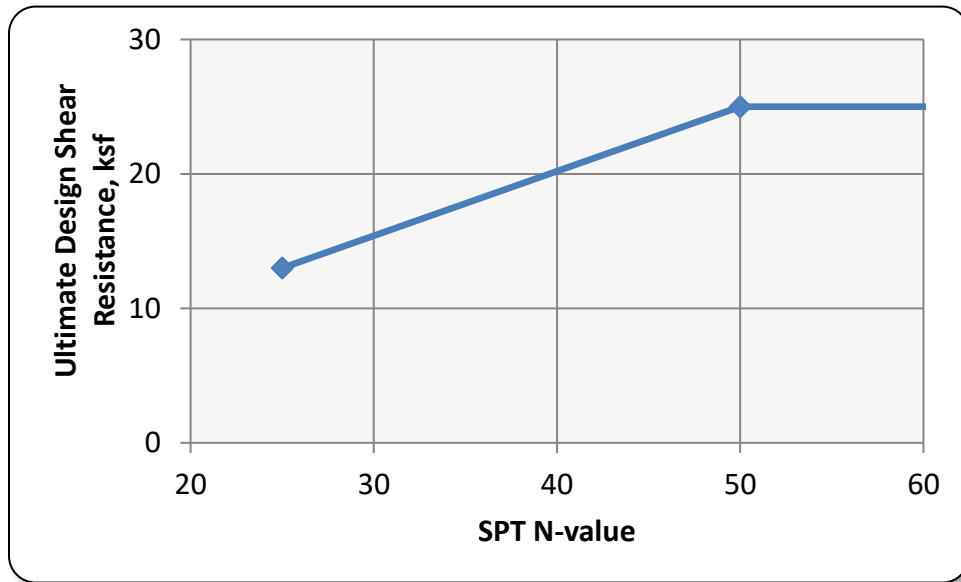

Step 11 Design shaft using local subsurface information – boring log at pier location

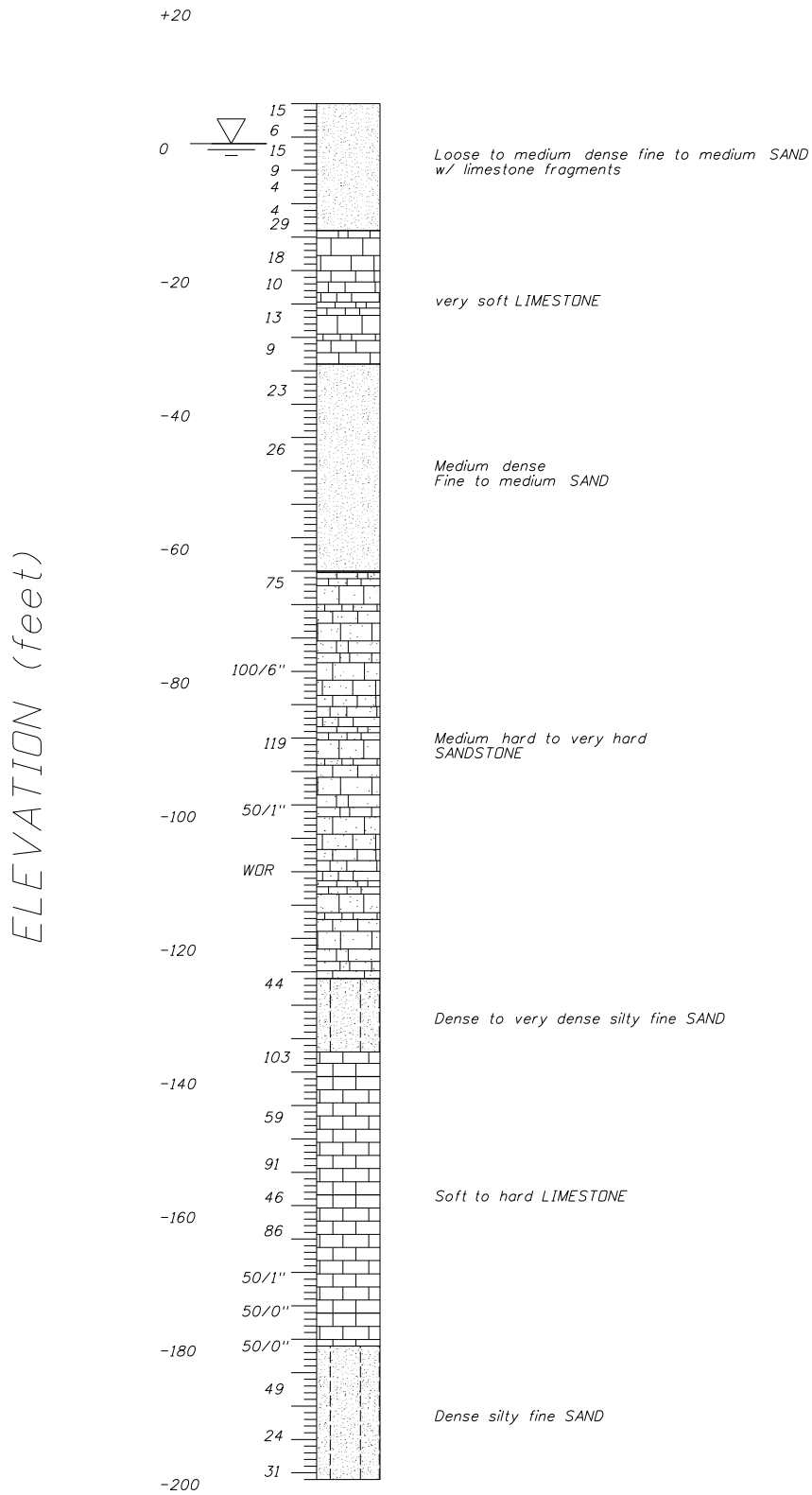

The following table is a summary of the boring log and how it will be used the shaft design.

Layer	Soil Description	Elev., ft	Thickness, ft	Ave N- value	Unit Side shear, ksf	Side Resistance, Kips/ft
1	sand	5.7 to -13	18.7	9	-*	-
2	Soft limestone	-13 to -23	10	16	-**	-
3	sand	-23 to -64	41	25	-*	-
4	limestone	-64 to -109	45	>50	23.4	294.4

Notes: *Neglected because of high ground water table and casing may be used.

**The soft limestone layer is very close to the top of the shaft. If casing is used, the rock-casing interface will shatter during the installation. In the second case, if casing is not used, the rock-shaft interface will slip and the deformation will pass the peak strength strain into the residual strength range due to high stress concentration at the top part of the shaft. Thus, in both cases, the upper limestone stratum will behave like granular material and should be designed as such.

Diameter of shaft-----D=48" or 4'

Perimeter area per foot of shaft----- $A = \pi * D = 12.57 \text{ ft}^2$

Side resistance per foot of rock socket, kips/ft---- $R_s = A * \text{unit side shear} = 294.4$

Factored design load, kips ----- $Q = 2,500 / 0.55 = 4545.5$

Total required socket length, ft----- $L = 4545.5 / 294.4 = 15.4$

Thus the design shaft should socket 15.5 feet into the limestone or tipped at elevation -79.5' if only side resistance is used. Shaft base resistance can also be utilized for design, however, a strain compatible design, such as O'Neal's Design Method for IGM must be used.

References:

McVay, M. C., Townsend, F.C., and Williams, R.C. (1992), "Design of Socketed Drilled Shafts in Limestone" ASCE Journal of Geotechnical Engineering, Vol. 118, No. 10, October, 1992.

O'Neill, M., "Drilled Shafts: Construction Procedures and Design Methods" Publication No. FHWA-IF-99-025, August 1999.

Paikowsky, S. G., "Load and Resistance Factor Design (LRFD) for Deep Foundations" NCHRP Report 507, 2004

Appendix B

Design Guidelines for Auger Cast Piles for Miscellaneous Structures Based on SPT or CPT Values Without Rock Core Tests

GENERAL

In order to accommodate the post supports of noise walls and reinforcement with the required cover, the normal foundation diameter is approximately 30 inches. It is generally desirable and efficient to limit foundation depths to 25 or 30 feet. If the design indicates a 30 inch diameter foundation will need to be longer than 30 feet, a larger diameter foundation should be considered. Refer also to 8.2.4.1.

NOISE BARRIER FOUNDATIONS

See Section 8.2.4.1

LATERAL LOAD RESISTANCE

Use a Load Factor in accordance with the latest AASHTO LRFD Bridge Design Specifications.

When required, computer programs such as FBPIer, LPILE, or COM624 may be used to determine the deflections and rotations.

k values in Sands.

For structures subject to lateral loads due to a storm event, k values input into FBPIer, LPILE, or COM624 shall not exceed the following values in pounds per cubic inch, without lateral load tests:

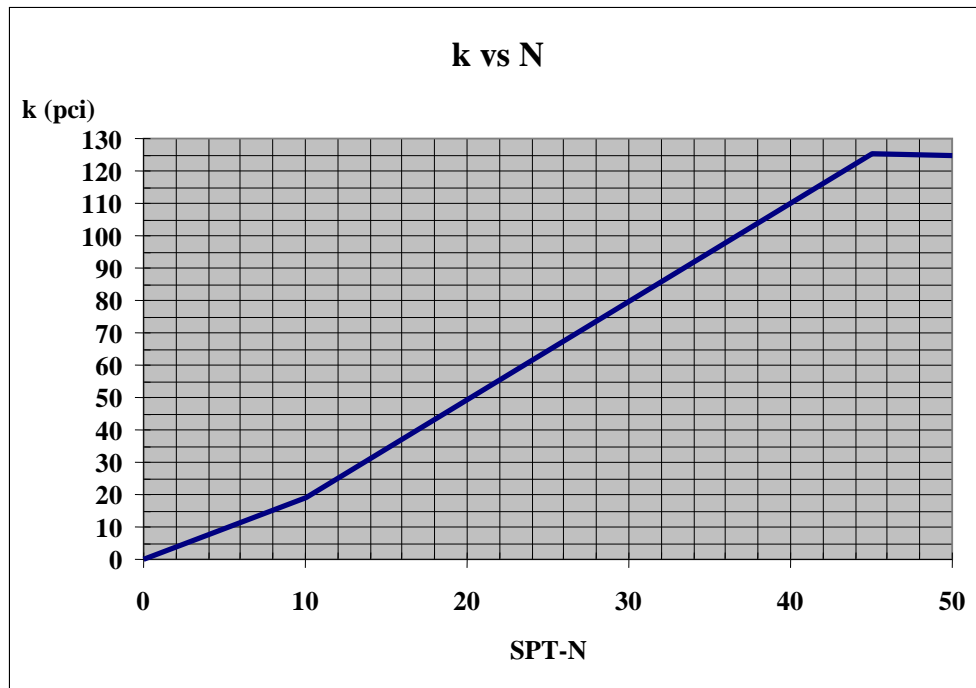

Note: Since submerged conditions are likely to exist when the design load condition occurs, make no distinction between dry and submerged conditions.

Friction Angles in Sand

The following typical correlation may be used to estimate the soil friction angle, ϕ :

$$\phi = N/4 + 28$$

As an alternative, the procedure described in [6.1.1.5 Friction Angle vs. SPT-N](#) shall be used. The maximum Φ value shall be limited to 35 degrees for silty sand (A-2-4) and 38 degrees for clean sand (A-3), unless higher friction angles are statistically supported by laboratory shear strength test results.

Clay

Use the LPILE or COM624 program guideline to determine k and ϵ_{50} values. However, limit the properties of clay to stiff clay or weaker (design values for undrained shear strength shall not exceed 2000 psf and the ϵ_{50} shall not be less than 0.007), unless laboratory stress-strain measurements indicate otherwise.

Rock

The results of SPT borings are most often used for designing noise wall foundations in shallow limestone strata. Less conservative designs require more vigorous sampling and testing to demonstrate that less conservative design values are appropriate in all locations. In the absence of a comprehensive, vigorous sampling and testing program, the design based on SPT borings shall be as follows:

Rock material with N-values less than 10 blows/foot shall be modeled as sand. Rock material with N-values between 10 and 20 blows/foot shall be modeled as sandy gravel:

$$\text{Friction Angle, } \phi = N/4 + 33$$

The maximum friction angle value shall be limited to 40 degrees, unless higher friction angles are statistically supported by laboratory shear strength test results.

Rock material with N-values of 20 blows/foot or more:

- Use the LPILE or COM624 program guideline to model p-y curves of weak rock.

Modeling rock as stiff clay will be acceptable, provided N-values are 10 blows/foot or more and reasonable conservatism in the selection of k and undrained shear strength are adopted.

AXIAL LOAD RESISTANCE (doesn't normally control the design of noise barrier foundations)

Side Resistance in Sands

Side resistance in cohesionless soils shall be computed by the FHWA Method (Beta Method) specified in the Publication FHWA-IF-99-025 (August, 1999) for drilled shafts as follows:

$$f_s = P'_v \beta_c$$

$$\beta_c = \beta * N/15 \text{ where } \beta_c \leq \beta$$

$$\beta = 1.5 - 0.135 (z)^{0.5} \text{ (z, depth in ft), where } 1.2 \geq \beta \geq 0.25$$

where f_s = Ultimate unit side resistance
 The maximum value of f_s shall be limited to 2.1 tsf, unless load test results indicate otherwise.
 P'_v = Effective vertical stress

Side Resistance in Rock:

When limestone and calcareous rock cores are obtained for laboratory testing, the ultimate unit side resistance shall be estimated as discussed in Appendix A.

When rock cores and laboratory testing are not available, use the following approach:

- If SPT N-value in rock is less than 25 blows / foot, assume sand behavior.
- If SPT N-value in rock is greater than or equal to 25 blows / foot, use the following:
 $f_s = 0.1 N$ (tsf) where $f_s \leq 5.0$ tsf

Side Resistance in Clay

Model inorganic clays and silts in accordance with FHWA methods. Shear strength values should be estimated from UU tests, unconfined tests, vane tests, etc. If only SPT tests are available, Consultants are expected to use reasonable judgment in the selection of undrained shear strength from correlations available in the literature.

The shear strength of clay estimated from SPT-N values or CPT results shall not exceed 2000 psf, unless laboratory stress-strain measurements indicate otherwise.

Side resistance shall be computed by the FHWA Method (Alpha Method) specified in the Publication FHWA-IF-99-025 (August, 1999) for drilled shafts as follows:

$$f_s = \alpha S_u$$

where S_u = Design undrained shear strength of clay (psf)
 α = A dimensionless correlation coefficient as defined below:
 $\alpha = 0$ between 0 to 5 feet depth
 $\alpha = 0$ for a distance of B (the pile diameter) above the base
 $\alpha = 0.55$ for $1.5 \geq S_u/P_a$
 $\alpha = 0.55 - 0.1 (S_u/P_a - 1.5)$ for $2.5 \geq S_u/P_a \geq 1.5$
 for $S_u/P_a > 2.5$, follow FHWA-IF-99-025 Figure B.10
 P_a = Atmospheric pressure (2116 psf at 0 ft Mean Sea Level)

Organic Soils

Neglect any side resistance in soils with an organic content greater than 5.0% by ASTM D 2974.

End Bearing Resistance

Neglect any end bearing resistance.

Factors of Safety & Resistance Factors

To compute an allowable axial load, a minimum factor of safety of 2.0 shall be used. The service axial load shall not exceed this allowable load.

For LRFD design, use a Load Factor in accordance with the latest AASHTO LRFD Bridge Design Specifications and a Resistance Factor of 0.6.

DESIGN WATER TABLE

For structures where the design is controlled by storm related wind loads, the design water table is at the ground surface.

For load conditions not associated with storm related wind loads, the seasonal high water table estimated for the location may be used for computation of axial capacity and lateral load analysis. If no information is available to determine the seasonal high water table, the designer will assume the water table at the ground surface. Include a justification for the selected design water level in the foundation analysis.

SPT ENERGY CORRECTIONS

SPT N values from automatic hammers may be corrected to account for higher energy as compared with safety hammer. The energy correction factor shall not exceed 1.24.

USE OF STATIC CONE PENETROMETER TESTS

If static cone penetrometer test (CPT) is used in the geotechnical investigation, the cone resistance data shall be converted to SPT N-values. The converted SPT N-values shall in turn be used in the foundation design according to the methods indicated in the previous sections of these design guidelines.

The correlation presented in **FIGURE B1** shall be used in the conversion of the CPT cone tip resistance, Q_c (tsf) to SPT N-values, based on mean particle size, D_{50} (mm) of the material. The use of design parameters that are less conservative than the values obtained from cone tip resistance to N-value correlations, and other sections of this document, shall be statistically supported by the results of high-quality laboratory tests and/or in-situ tests for the specific soil/rock deposits.

Correlation of (Q_c / N) Versus D_{50}

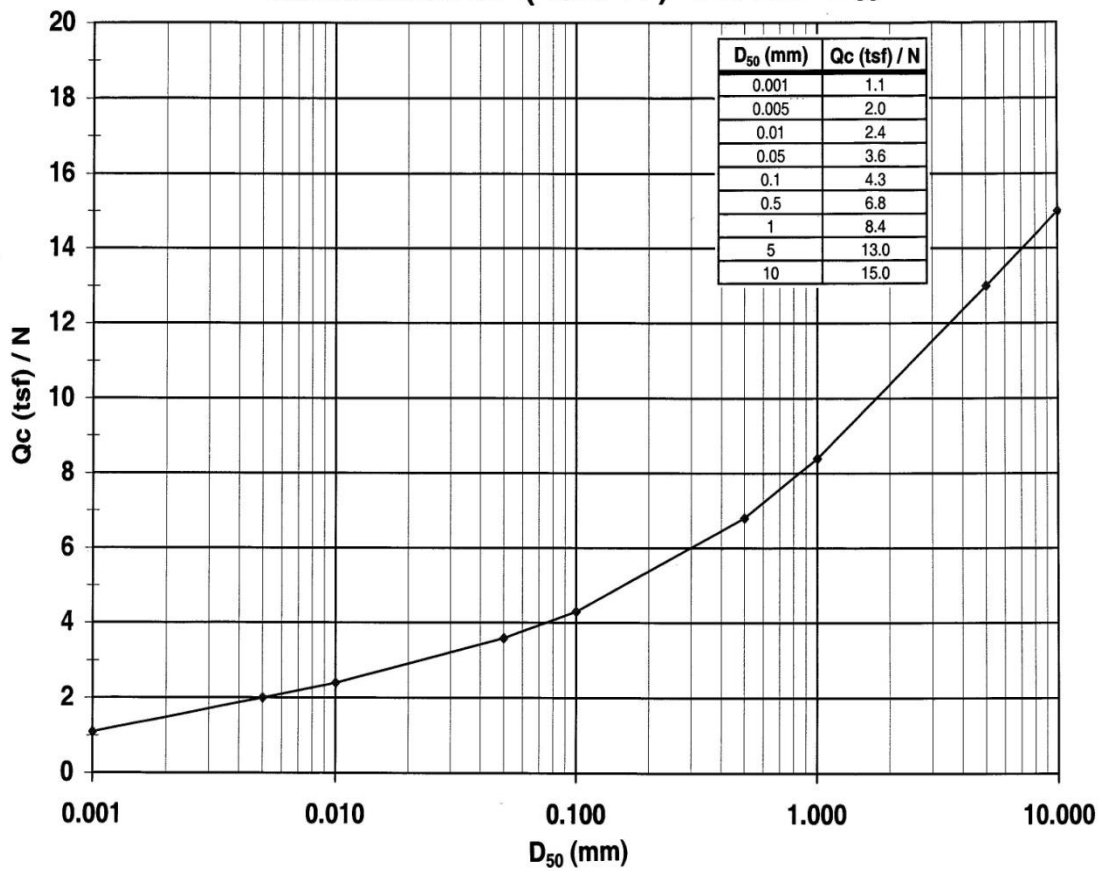

Figure B 1

REQUIRED COMPUTATIONS FOR GEOTECHNICAL REVIEW

Reports, Shop Drawings, CSI submittals, and Design-Build submittals, shall include calculations and numerical program outputs of all the cases and loadings considered in the design. Copies of structural calculations indicating wind loads computations and structural deflections at the top of the wall (due to pole and panel bending) shall also be included in the geotechnical package of computations.

Appendix C

Step by Step Design Procedure for the Analysis of Downdrag

Negative Shaft Resistance or Downdrag

*The following is adapted from FHWA HI 97-013
Design and Construction of Driven Pile Foundations (1998)*

When piles are installed through a soil deposit which will later settle, the resulting relative downward movement of the soil around piles induces "downdrag" forces on the piles. These "downdrag" forces are also called negative shaft resistance. Negative shaft resistance is the reverse of the usual positive shaft resistance developed along the pile surface. The downdrag force increases the axial load on the pile and can be especially significant on long piles driven through compressible soils. Therefore, the potential for negative shaft resistance must be considered in pile design. Batter piles should be avoided in soil conditions where large soil settlements are expected because of the additional bending forces imposed on the piles, which can result in pile deformation and damage. Settlement computations should be performed to determine the amount of settlement the soil surrounding the piles is expected to undergo after the piles are installed. The amount of relative settlement between soil and pile that is necessary to mobilize negative shaft resistance is about 10 to 12 mm (½ inch). At that movement, the maximum value of negative shaft resistance is equal to the soil-pile adhesion. The negative shaft resistance cannot exceed this value because slip of the soil along the pile shaft occurs at this value. It is particularly important in the design of friction piles to determine the depth at which the pile will be unaffected by negative shaft resistance. Only below that depth can positive shaft resistance forces provide support to resist vertical loads.

The most common situation where large negative shaft resistance develops occurs when fill is placed over a compressible layer immediately prior to, or after piles are driven. Negative shaft resistance can also develop whenever the effective overburden pressure is increased on a compressible layer through which a pile is driven; due to lowering of the ground water table, for example.

STEP BY STEP DESIGN PROCEDURE FOR ANALYSIS OF DOWNDRAG LOADING

STEP 1

Establish the simplified soil profile and soil properties for computing settlement.

STEP 2

Determine the overburden pressure increase, Δp , versus depth due to the approach embankment fill. There are many methods and computer programs available for this purpose. An acceptable hand method is included at the end of this appendix.

STEP 3

Perform settlement computations for the soil layers along the embedded pile length.

- a. Determine the consolidation parameters for each soil layer, preferably from laboratory consolidation test results.
- b. Compute the settlement of each soil layer.

- c. Compute the total settlement over the embedded pile length, i.e. the sum of the settlements from each soil layer and partial soil layers. Do not include soil settlements below the pile toe.

STEP 4

Determine the pile length that will experience negative shaft resistance. Negative shaft resistance occurs due to the settlement between soil and pile. The amount of settlement between soil and pile necessary to mobilize the negative shaft resistance is about ½ inch. Therefore, negative shaft resistance will occur on the pile shaft in each soil layer or portion of a soil layer with ½ inch more settlement than the settlement of the pile.

STEP 5

Determine magnitude of negative shaft resistance, R_{dd} . The method used to calculate the ultimate negative shaft resistance over the pile length determined in Step 4 is the same method used to calculate the ultimate positive shaft resistance, except that it will act in the opposite direction.

STEP 6

Calculate the nominal pile resistance provided by the positive shaft resistance and the toe resistance, R_n . Positive shaft and toe resistances will develop below the depth where the relative pile-soil movements are less than ½ inch. The positive soil resistances can be calculated on the pile length remaining below the negative shaft resistance depth from Step 4 using an appropriate static analysis method for the soil type as described in this chapter.

STEP 7

Calculate the net ultimate pile capacity, R_{net} available to resist imposed loads.

$$R_{net} = R_{ult} - R_{dd}$$

STEP 8

Calculate the DOWNDRAG value for the Pile Data Table of the plans as

$$\text{DOWNDRAG} = R_{dd} + (\text{Driving Resistance of soil contributing to } R_{dd})$$

$$R_n = (\text{Factored Design Load} + \text{Net Scour} + \text{Downdrag}) / \phi$$

Where: ϕ is the resistance factor taken from Table 3.1 of the Structures Design Guidelines. During initial drive, the driving resistance of the soil contributing to R_{dd} equals about 0.75 times the ultimate skin friction for most sand and silty sand strata; it may be as low as 0.50 times the ultimate skin friction for plastic clayey soils that build-up excess pore water pressures during driving and later exhibit significant soil set-up. The driving resistance will be as high as 1.0 times the ultimate skin friction for clean sands that do not exhibit set-up.

During restrike, the driving resistance of the soil contributing to R_{dd} typically equals 1.0 times the ultimate skin friction because the excess pore pressures that built-up during initial drive will have dissipated.

STEP 9

Consider alternatives to obtain higher net ultimate pile capacity such as preloading or surcharging to reduce settlements prior to pile installation, use of lightweight fills to reduce settlements that cause downdrag loads, isolation of pile from consolidating soil, etc.

Method to determine the overburden pressure increase, Δp , versus depth due to the approach embankment fill.

The overburden pressure increase, Δp , is equal to the pressure coefficient, K_f , determined from the pressure distribution chart presented in Figure 9.53, multiplied by the height of fill, h , and the unit weight of fill, γ . The pressure distribution chart provides the pressure coefficient, K_f , at various depths below the bottom of the fill (x_{bf}), and also at various distances from the centerline of the fill. The depth below the bottom of the fill is given as a multiple of "b," where b, is the distance from the centerline of the fill to the midpoint of the fill side slope, as shown in the Figure below.

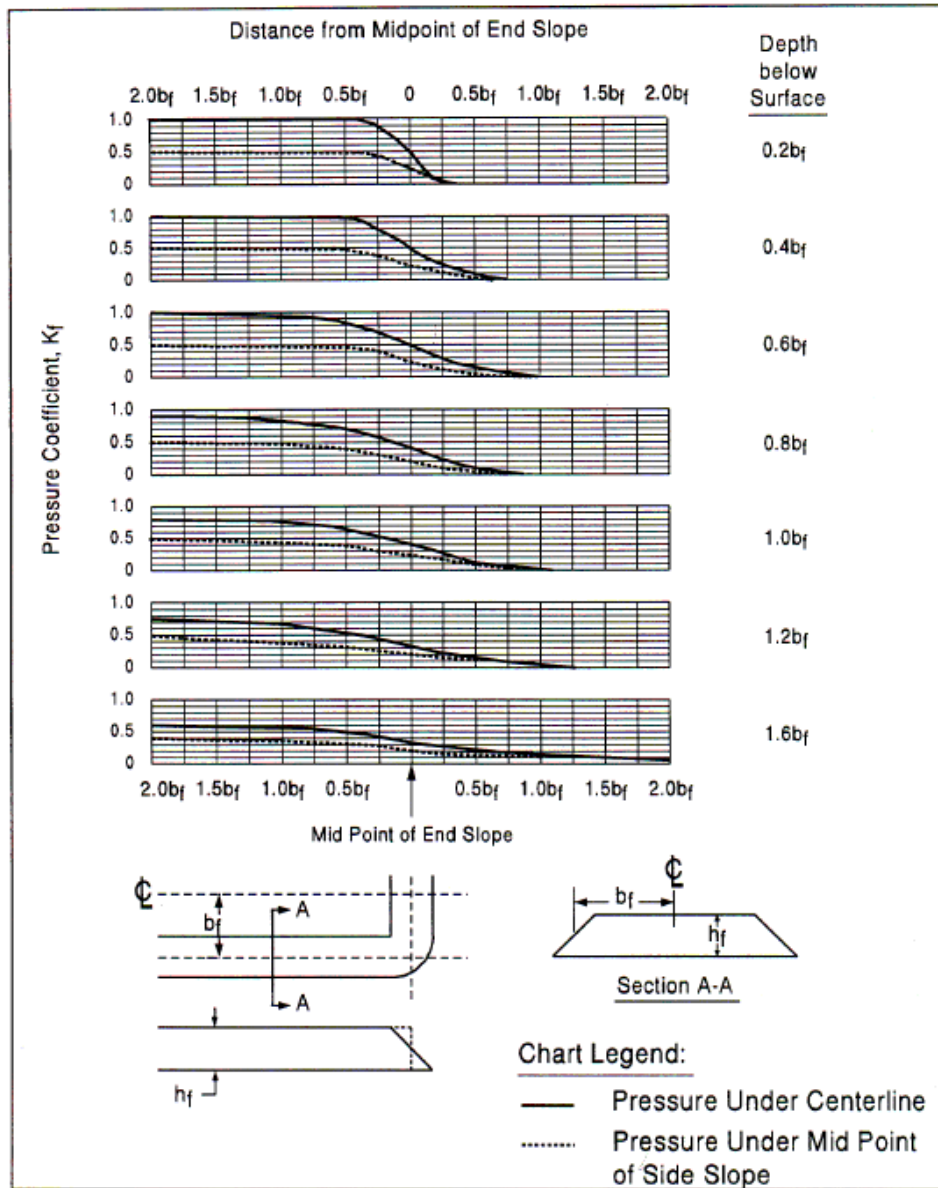

Figure 9.53 Pressure Distribution Chart Beneath the End of a Fill (After Cheney and Chassie, 1993)

Appendix D

Design Method for Drilled Shaft with Pressure Grouted Tip

Design Method for Drilled Shaft with Pressure Grouted Tip

For a given shaft diameter and anticipated embedment length, the method for estimating the unit tip resistance of grouted shafts in cohesionless soils involves the following steps:

1. Calculate the nominal side shear resistance (F_s) for the given shaft diameter (D) and total embedded shaft length. Using GeoStat software, ensure that a sufficiently large number of laboratory tests are performed to develop side shear design values for rock strata.

2. Calculate the nominal uplift side shear resistance ($F_{s \text{ uplift}}$);

$$F_{s \text{ uplift}} = (F_s)(\text{Uplift Reduction Multiplier}^*)$$

*O'Neill cited uplift resistance of shafts to be 0.75 that of compression/downward loading. O'Neill, M. W. (2001). "Side Resistance in Piles and Drilled Shafts," *The Thirty-Fourth Karl Terzaghi Lecture, ASCE J. Geotech. Geoenviron. Eng.* 127:3-6.

3. Calculate the ungrouted nominal unit tip resistance of the shaft (q_{tip}^{**}) for 5 % Diam. tip settlement as per AASHTO 10.8.2.2.2.

**The 5% settlement is also the default value used in FB-Deep for drilled shafts founded in cohesionless soils, thus, one can use the FB-Deep formula ($q_{tip} = 0.6 \times \text{SPT } N_{60}$, tsf) where SPT N_{60} is weighted average at shaft tip (Reese & O'Neill, 1988).

4. Determine the maximum anticipated grout pressure (GP_{max}) by dividing the nominal uplift side shear resistance ($F_{s \text{ uplift}}$) by the cross-sectional area of the shaft (A);

$$GP_{max} = F_{s \text{ uplift}}/A$$

5. Calculate the Grout Pressure Index, GPI , as the ratio of the maximum anticipated grout pressure (Step 4) to the ungrouted unit tip resistance (q_{tip}), (Step 3);

$$GPI = GP_{max}/q_{tip}$$

6. Determine the Tip Capacity Multiplier (TCM) using the following equation

$$TCM = 0.713(GPI) + 0.3$$

7. Estimate the grouted unit tip resistance as the product of the Tip Capacity Multiplier (Step 6) and the ungrouted unit tip resistance (q_{tip}), (Step 1).

$$q_{grouted} = (TCM)(q_{tip})$$

8. Compute the nominal tip resistance $R_{n \text{ tip}} = (q_{grouted})(A_{tip}^{***})$

***The tip area of a grouted shaft has been shown to be larger than the shaft diameter due to cavity expansion of the soils beneath the tip. While values less than the constructed shaft diameter have been suggested to account for variability, the constructed diameter of the shaft was used to develop this design method and therefore statistically incorporates variations both larger and smaller than the nominal shaft diameter.

9. Compute the nominal resistance $R_n = R_{n \text{ side shear}} + R_{n \text{ tip}}$

10. Compute the factored resistance $R_R = \phi(R_{n \text{ side shear}} + R_{n \text{ tip}})$

Note that the side shear is assumed to develop with very little displacement, thus allowing for the use of this ultimate value. Care should be taken when specifying maximum allowable shaft uplift during grouting such that the side shear resistance (contributing to the total resistance) is not displaced beyond possible peak strength and into a lower residual value. The Step 6 TCM value coincides with the maximum side shear at no more than 1%D tip settlement.

Design Example

Given: A 3 ft diameter drilled shaft tipped in sand (SPT $N_{60 \text{ tip}} = 30$ and $F_s = 300$ tons).

- Calculate the nominal uplift side shear resistance:

$$F_{s \text{ uplift}} = (0.75)(300 \text{ tons})$$

$$F_{s \text{ uplift}} = 225 \text{ tons}$$

- Calculate the nominal end bearing @ 5%D settlement:

$$q_{\text{tip}} = (0.6)(30)$$

$$q_{\text{tip}} = 18 \text{ tsf}$$

- Calculate the maximum anticipated grout pressure:

Maximum Grout Pressure = $F_{s \text{ uplift}} / \text{Tip Area}$

$$GP_{\text{max}} = (225 \text{ tons}) / [(3 \text{ ft})^2 \pi / 4]$$

$$GP_{\text{max}} = 31.8 \text{ tsf}$$

- Calculate the grout pressure index (GPI):

Grout Pressure Index = $GP_{\text{max}} / \text{Ultimate End Bearing}$

$$GPI = 31.8 \text{ tsf} / 18 \text{ tsf}$$

$$GPI = 1.77$$

- Calculate the Tip Capacity Multiplier (TCM):

$$TCM = (0.713)(1.77) + 0.3$$

$$TCM = 1.56$$

- Calculate grouted unit end bearing capacity

$$q_{\text{grouted}} = (TCM)(q_{\text{tip}}) = (1.56)(18) = 28.1 \text{ tsf}$$

Nominal Side and Tip Resistances after grouting:

$$R_{n \text{ side shear}} = 300 \text{ tons}$$

$$R_{n \text{ tip}} = (q_{\text{grouted}})(A_{\text{tip}})$$

$$R_{n \text{ tip}} = (28.1 \text{ tsf})(3 \text{ ft})^2(3.1416/4)$$

$$R_{n \text{ tip}} = 199 \text{ tons}$$

$$R_n = 499 \text{ tons}$$

Factored Bearing Resistance after grouting:

$$R_R = \phi(R_{n \text{ side shear}} + R_{n \text{ tip}})$$

$$R_R = 0.6(300 \text{ tons} + 199 \text{ tons})$$

$$R_R = 299 \text{ tons}$$

Appendix E

Reinforced Embankment Design Method

Reinforced Embankment Design Method

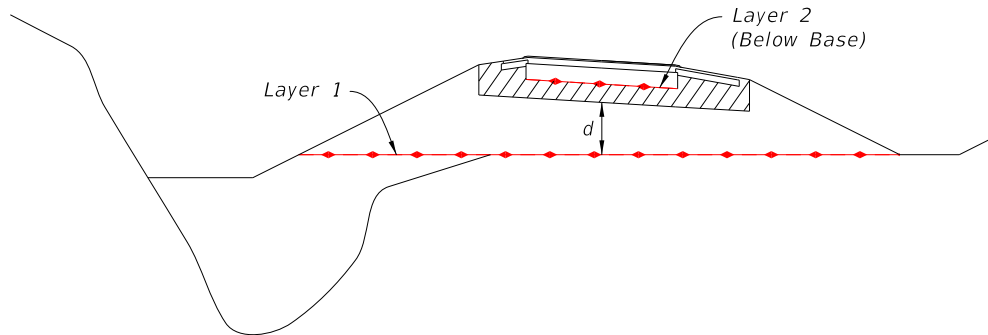

Reinforced embankments utilize geosynthetic reinforcement to provide structural support of traffic loads over the life of the pavement. This reinforcement application involves a relatively shallow flexible pavement substructure (embankment/subgrade/base profile) that is constructed over unsuitable soils that are at or near the ground surface. Therefore, the flexible pavement is directly affected by these underlying soft soils. The following design requirements are to be used for the selection of the geosynthetics used in the reinforcement of the roadway embankment system, including both the embankment soils and the aggregate base. Roadway reinforced embankments should be utilized when complete excavation and replacement of unsuitable soils below the proposed pavement system is not economical or desirable.

STEP 1

- a. Determine construction loads.
- b. Normal highway wheel loads are assumed for this design method.
- c. If wheel loads will exceed legal highway wheel loads, contact a proprietary designer.

STEP 2

- a. Measure strength of insitu soils using Vane Shear, CPT, DMT, PMT, etc.
- b. If S_U design < 250 psf, STOP and use Reinforced Foundation over Soft Soils in FDM Chapter 263

STEP 3

Determine **minimum** depth below stabilized subgrade to Layer 1 from Table 1.

STEP 4

Determine the required geosynthetic allowable tensile strength (T_R) from Table

1.

STEP 5

- a. Determine surcharge requirements.
- b. Use 5 ft minimum surcharge height.
- c. (reinforced embankment test sections were surcharged for 6 months)

STEP 6

- a. Verify global stability.
- b. Increase T_R and/or surcharge requirements as required.

STEP 7

- a. Design the flexible pavement.

- b. Contact the District Materials Office for guidance in selecting the design M_R value for the reinforced structural fill layer.

STEP 8

Detail the plans with the required location and T_R of the R-4 geogrid or geotextile. The Contractor will choose an R-4 material from the APL.

Where:

$$\frac{T_{ult}}{RF_{ID}RF_D} \geq T_R$$

Table 1

S_U , psf	d, inches	T_R , lb/ft
750 to 1,500	18	250
500 to 750	18	340
375 to 500	20	340
250 to 375	24	340

Appendix F

Determination Of Acceptance Criteria For Driven Piles & Determining the Capacity of a Pile from an Instrumented Set-Check

Determination Of Acceptance Criteria For Driven Piles

Piles must be installed to not less than the Nominal Bearing Resistance (NBR) in the Plans. For details on the computation of NBR refer to the SDG, chapter 3.

The potential effect of nearby construction activities on pile capacity shall be evaluated using acceptable theoretical methods and engineering judgment. For example, the influence of jetting concrete sheet pile or vibratory installation/removal of steel sheet pile in the vicinity of foundation piles shall be considered, when evaluating foundation performance. Confirmation of pile resistance through set-checks after completion of nearby construction is the preferred alternative. When set-checks are not feasible, potential reductions in pile resistance due to nearby construction can be addressed by implementing revisions (increases) to the NBR, minimum tip elevation, or applicable Plan notes.

The following construction quality control methods may be used to determine pile resistance in the field (see SDG Chapter 3 Table 3.5.6-1 for an exhaustive list):

1. Standard pile driving criteria with dynamic monitoring equipment such as the Pile Driving Analyzer (PDA) monitored test pile(s) or monitored production pile(s) in projects without test piles connected to external instruments, signal matching software such as CAPWAP, and Wave Equation Analysis. The dynamic monitoring equipment will normally utilize a program, such as the PDA's PDIPlot program described in this appendix, for viewing the results. (The discussions on this method below use the terms 'PDA', 'CAPWAP' and 'PDIPlot' for simplicity.)
2. Embedded Data Collector (EDC) monitoring of all Test Piles and all Production Piles (100%), using tip and top gauges, or a combination of piles with top and tip gauges and piles with only top gauges. A percentage of the piles in each bent/pier must be analyzed with the FDOT Method post-processing software.
3. PDA monitoring of all Test Piles and all Production Piles (100%), with CAPWAP analyses of the percentage of the piles in each bent/pier required in the Specification.

1. Standard Driving Criteria with PDA Test Piles or monitored indicator production pile(s) in projects without test piles, **CAPWAP and Wave Equation Analysis**

In this method dynamic load tests are initially performed on test piles or indicator production piles and a resistance factor (ϕ) of 0.65 may be used in the computation of the required NBR. Dynamic Load tests are performed in accordance with Specification 455. Dynamic data are collected on PDA sensors connected at the top of the pile throughout the entire drive for every impact blow. The purpose of this method is to establish a "calibrated" model that predicts the number of blows per foot and stroke combination to achieve a desired resistance. The Driving Criteria based on PDA testing involves the following steps:

- a. Estimation of production pile tip elevation based on PDA results, and preparation of selected blow for CAPWAP analysis
- b. CAPWAP analysis to confirm PDA results
- c. Wave Equation calibration and final wave equation analysis
- d. Driving Criteria Letter

a. Estimation of production pile tip elevation based on PDA results, and selection of dynamic data for CAPWAP analysis

Based on the field collected dynamic data estimate the tip elevation where NBR is achieved. Following the recommendations in CAPWAP's manual select a representative blow of good data quality for signal match analysis. Adjust the blow as required and ensure the wave speed is properly determined, the F (force trace from strain gauges) and V (velocity times impedance trace from accelerometers) forces are proportional and the final displacement converges to the measured set.

b. CAPWAP Analysis

- Check that the static resistance distribution makes sense, compare with boring logs and pile driving records to ensure reasonable assumptions are being implemented. Do not expect the automatic search feature to provide an accurate resistance distribution.
- Match Quality number (MQN): Make every reasonable attempt to obtain a MQN less than three. Make sure good matching is obtained for both wave and force matching analysis.
- Ensure resistance is not overestimated throughout the entire first $4L/c$ portion of the record.
- Match in blow count. Make every reasonable attempt to match the observed number of blows per foot for the selected interval.

Once the CAPWAP analysis is performed, determine the equivalent J_c (Case damping) value and compare the CAPWAP capacity with the corresponding PDA capacity. The equivalent J_c is the value that produces the same PDA capacity as the one determined by CAPWAP analysis.

Reprocess the PDA and PDILOT based on CAPWAP analysis results (using the J_c value from the previous step and the RMX capacity or proper capacity approach), to tabulate the capacity throughout the drive.

c. Wave Equation Calibration

Using the CAPWAP estimated quake, damping and static resistance distribution, establish a WEAP model based on the test pile or indicator production pile length and properties. Perform WEAP analyses to match the following parameters from CAPWAP and PDA: Energy Transferred EMX (within 10%), Compression Stress CSX (within 10%), blow count (within 10% but never below the blows/ft measured in the field) for the capacity and stroke evaluated. Some adjustments may be required to the static resistance distribution, hammer efficiency, cushion, thickness, stiffness, etc. to get an acceptable model.

Verify the model: Refer to the corrected PDIPlot, and compare at several depths (near the estimated bearing depth) to check how the model predicts blow count at other capacities/strokes measurements (use PDIPlot average output per foot or per increment). Refine the model if necessary.

Blow count criteria: On the refined wave equation model, apply production pile lengths and NBR loading conditions to develop a driving criteria. Reduce efficiency for battered piles as required. If the Contractor provides longer piles than the authorized lengths, perform the analysis again to confirm the criteria still applies.

d. Driving Criteria Letter

The driving criteria letter provides the inspector with directions on when to accept piles. The letter should include the pile acceptance criteria based on blow count vs. stroke height results obtained from WEAP analysis, pile cushion details and recommendations regarding the operation of the hammer to avoid damaging the pile while driving. In addition, if the minimum tip elevation is not shown on the Plans, provide a criterion for “firm bearing material” to determine when the minimum pile penetration per 455-5.8 has been achieved. Provide the maximum number of hammer blows that may be applied to pile cushions before they must be replaced and the minimum number of blows a new cushion must be impacted before applying the blow count and refusal criteria. Indicate the minimum stroke or stroke range under which this number of blows must be applied. For more information regarding the driving criteria letter, refer to the Construction Procedures Administration Manual (CPAM, chapter 10.1, sample letters 3 and 4).

e. Additional Considerations

It is important to note that the driving criteria applies to the soil/rock material encountered at the elevation at which CAPWAP analysis was performed. Piles that satisfy the driving criteria within different soil/rock strata need to be evaluated to confirm resistance has been attained. In addition, driving criteria based on initial drive may not be used for re-strike conditions. To develop a valid set-check criteria, dynamic load test data must be available for the same driving conditions and time after initial drive was performed, and the same steps indicated here should be followed.

In some special conditions, the pile driving log (and PDIPlot) may indicate an unusually high blow count in upper layers, even though capacity was not obtained. This may occur because soil properties change with depth. For example, a pile driven through soil with large damping properties will require a larger blow count than low damping soils, for the same capacity. This may also occur when the pile cushion has not been fully compressed. In most cases, a specified elevation above which the criteria does not apply will resolve this issue. However, in some cases it may be necessary to revise the model to ensure piles will not attain a false bearing (meet the

blow count requirement without actually achieving the static resistance). There are three choices:

1. Implement a minimum elevation above which the criteria is not to be applied.
2. Be conservative. Ensure the blow count requirement is high enough to avoid stopping in the higher damping soil without bearing. This may be feasible when the test pile shows an increase in capacity with depth and a conservative criteria does not result in unreasonably long production pile lengths.
3. Establish a different criteria for the upper layers to account for the increased damping value of those soils. One criteria will be applicable above a predetermined elevation, and the other will be applicable below that elevation.

2. Embedded Data Collector (EDC) monitoring of Test Piles and Production Piles (100%)

EDC is an approved method for using embedded sensors to monitor pile driving. In this method, dynamic load tests are performed on test piles and all production piles with the EDC system. Sensors are embedded in the pile in accordance with Standard Plans Index 455-003. Test piles may be driven to determine production pile lengths. A resistance factor (ϕ) of 0.75 may be used with this method. No driving criteria are required because achieving the NBR, without exceeding the allowable stress limits, will be determined in the field by EDC monitoring in accordance with either **a.** or **b.** below.

a. EDC monitoring of all Test Piles and all Production Piles, using 100% top and tip gauges.

All EDC piles are monitored in the field using Smart Structures' UF Method. Smart Structures' FDOT Method post-processing software will be used to verify the UF Method results of at least 10% of all piles in each bent and pile footing (minimum one per bent/group) including all test piles. In unique soil conditions such as extreme scour, large uplift loads or high variability soils a higher percentage FDOT Method analyses is required.

b. EDC monitoring of all Test Piles and all Production Piles, using a combination of top & tip gauges and top only gauges.

1. Use top and tip gauges in at least 10% of the piles (minimum one per bent/group) and top only gauges in the remaining piles. All test piles shall contain top and tip gauges. Test piles are included in the 10% minimum. In unique soil conditions such as extreme scour, large uplift loads or high variability soils a higher percentage FDOT Method analyses is required, therefore, a higher percentage of piles with top and tip gauges is also required.

2. In the field, use the UF Method during driving and confirm pile resistance with the FDOT Method after driving is complete for the piles instrumented with top and tip gauges. Use the Fixed Jc/Case Method with back computed/selected Jc value (as described in the below points) for piles instrumented with top only gauges.
3. For the piles instrumented with top and tip gauges, review the FDOT Method results for at least the first 10 blows in the six inches of the drive qualifying the pile for acceptance and use the Fixed Jc/Max Case Method equation to back compute the damping (Jc) value from the FDOT Method capacity for the representative blow.
4. In the event the back computed Jc value using FDOT method appears to be out of an acceptable range (<0.1 or greater than 1.0), use the UF method capacity and good engineering judgment to determine Jc.
5. When more than one pile in a bent/group must be analyzed, select the highest Jc value of the analyzed piles for the bent/group and/or good engineering judgement to determine which production piles will be based on which Jc value.
6. When the need for set checks is anticipated, the Jc value for set check conditions will be higher than for initial driving. Therefore, the above procedure must be repeated on a set checked pile at the required set-up periods with top & tip gauges to determine the Jc value for set checking a top sensor only pile. When this is not possible use prudent engineering judgement in consultation with and approval by the District Geotechnical Engineer.

3. PDA monitoring of all Test Piles and all Production Piles (100%), with CAPWAP analysis of the percentage of the piles in each bent/pier required in the Specification.

In this method dynamic load tests are performed on test piles and all production piles. Test piles (when required) are driven first to determine production pile lengths, or in cases when the Contractor has chosen to order production piles in advance, to verify that the ordered length is adequate. With this method, a resistance factor (ϕ) of 0.75 may be used in the computation of the required NBR. No driving criteria are required as achieving the NBR, without exceeding the allowable stress limits, will be determined in the field by PDA and CAPWAP. CAPWAP analyses are required on at least 10% of the piles in each bent or pile footing to confirm that the proper damping value, Jc, is used to estimate static resistance of the remaining piles. In unique soil conditions such as extreme scour, large uplift loads or high variability soils a higher percentage of CAPWAP analyses is required. In addition, piles that meet the criteria at significantly different elevations from where CAPWAP was performed, or tip on a different material type, will require separate CAPWAP analysis. Finally, at least one additional CAPWAP analysis is required for an instrumented re-drive, if this has a different set-up time than other piles evaluated in the pier.

Determining the Capacity of a Pile from an Instrumented Set-Check

In accordance with section 455-5.10.4, the pile capacity to be reported from an instrumented set-check will be the lowest of:

- The highest capacity recorded in the set-check
- The average capacity of the five consecutive blows following the highest capacity blow divided by 0.95
- The lowest capacity of the remainder of the blows (if any, after the blows in b above) in the set-check divided by 0.90

Note, disregard the last blow, which is typically a low energy blow after hammer was shut down.

Example 1, instrumented set-check w/ minimum blows:		Example 2, instrumented set-check and advance pile:	
Blow #	Capacity, kips	Blow #	Capacity, kips
1.	450	1.	450
2.	600	2.	600
3.	590	3.	590
4.	585	4.	585
5.	580	5.	580
6.	575	6.	575
7.	570	7.	570
8.	277	8.	400
		9.	550
		10.	530
		11.	528
		12.	520
		13.	513
		14.	509
		15.	501
		16.	494
		17.	478
		18.	461
		19.	216
Answer: a. Highest capacity recorded= 600 kips		Answer: a. Highest capacity recorded= 600 kips	
b. Average of next 5 blows/0.95 = [(590+585+580+575+570)/5]/0.95= 580 kips/ 0.95= 610 kips		b. Average of next 5 blows/0.95 = [(590+585+580+575+570)/5]/0.95= 580 kips/ 0.95= 610 kips	
Answer=600 kips		c. Lowest capacity of the following blows (excluding the last one)= 461/.90= 512 kips	
		Answer=512 kips	

Appendix G

Cable Barrier Foundation Analysis using Broms' Method

Cable Barrier Foundation Analysis using Broms' Method

Horizontal Service Load on Foundation, $Q_a = 40$ kips

Effective Unit Weight of Soil, $\gamma = 50$ pcf

Friction angle, $\phi = 30$ degrees

Cohesion, $C = 0$

Factor of Safety = 2 (Overturning)

$k_h = 7$ pci

Service Load Deflection = 1 inch

Broms' method is useful for estimating the ultimate lateral capacity of single piles in uniform soils. The method was originally proposed for "short" piles and "long" piles, with and without a rigid pile cap to prevent rotation. Short piles are considered stiff with respect to the surrounding soil and behave like a "fence post" and pivot in response to lateral loading. Long piles remain fixed at depth and the upper portion of the pile bends in response to loading. Generally, finite difference computer programs utilizing p-y methods, such as COM624 or FB-Pier are more accurate for long piles, but sometimes do not converge when analyzing short piles.

Broms' method for free-head short piles assumes the pile pivots about the tip, and the resistance is due to the passive earth pressure of 3 times the width of the pile. The method assumes the earth pressure in the direction of the loading does not activate.

$$\Sigma M_{tip} = 0$$

$$\frac{1}{2} \gamma D^2 (K_p) \frac{1}{3} D 3b - PD = 0; \quad \text{where:}$$

$D = \text{Depth of pile}$

$K_p = \text{Coefficient of passive earth pressure (3.0 for } \phi = 30)$

$b = \text{Width of pile}$

$P = \text{Ultimate lateral load (Service Load * Factor of Safety)}$

Solving for D:

$$D = \sqrt{\frac{2P}{\gamma K_p b}}$$

For the standard soil and default loading:

$$D = \sqrt{\frac{2 \cdot 80,000 \text{ lb}}{50 \text{ pcf} \cdot 3 \cdot b}}$$

For 48 inch diameter drilled shaft:

$$D = \sqrt{\frac{2 \cdot 80,000 \text{ lb}}{50 \text{ pcf} \cdot 3 \cdot 4 \text{ ft}}} = 16.3 \text{ ft}$$

Check service load deflection.

Computing deflection using Broms' method is less straightforward. Terms need to be carefully taken from the applicable e_c/D curve from the following graph (for cohesionless soils). In this example, the Free Head with $e_c/D = 0.0$ curve is used.

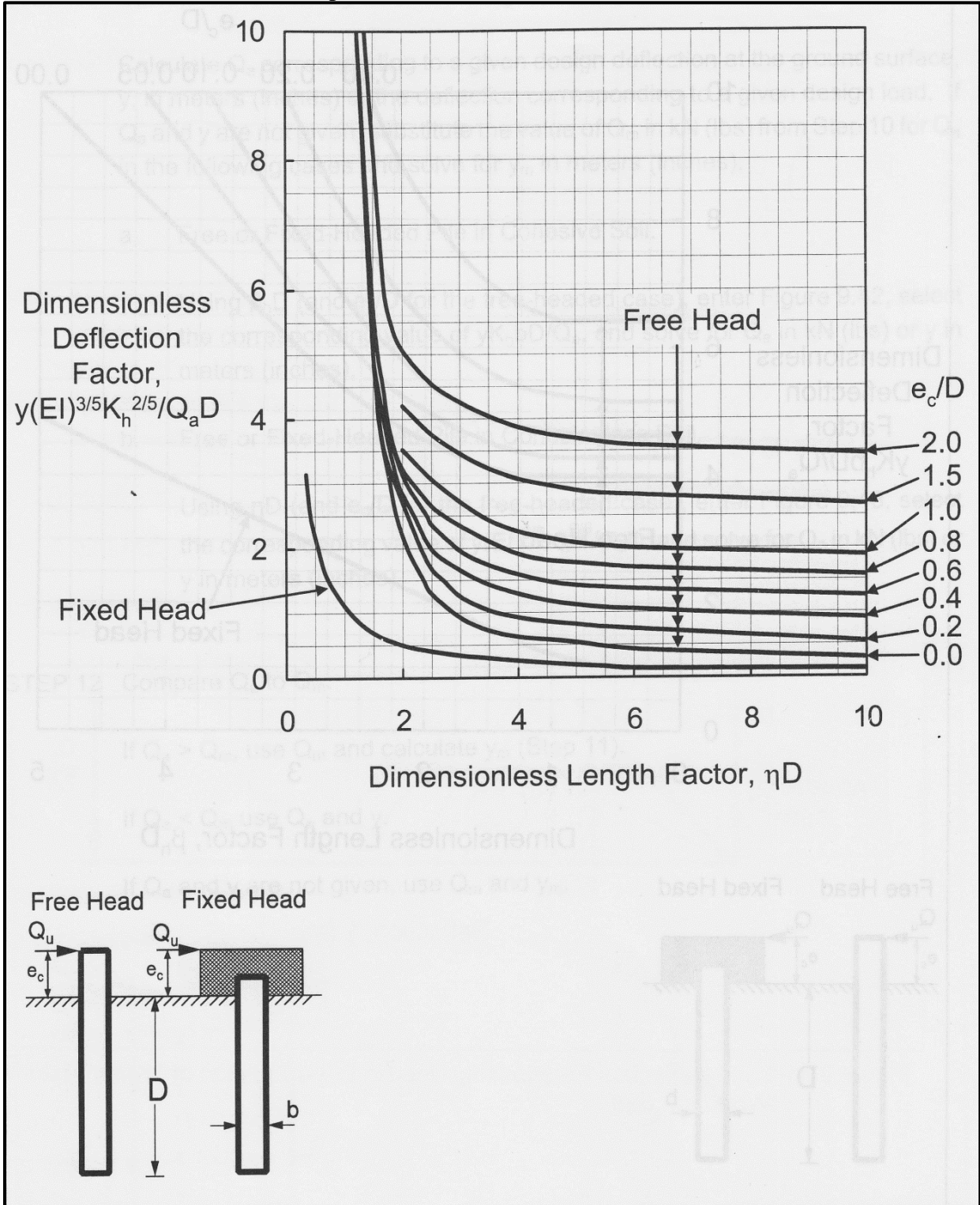

Figure G1, Broms' Deflection Factor vs. Length Factor (after FHWA-NHI-05-042)
 $(K_h = k_h)$

The graph is a comparison of 2 dimensionless terms:

$$\frac{y(EI)^{\frac{3}{5}}k_h^{\frac{2}{5}}}{Q_a D} \text{ vs. } \eta D$$

Where $\eta = \sqrt[5]{\frac{k_h}{EI}}$

For 48 inch drilled shaft with concrete $f_c' = 4000$ psi

$$\eta = \sqrt[5]{\frac{7pci}{3605000psi \cdot 260576in^4}} = 0.00595 \text{ inch}^{-1}$$

$$\eta D = 0.00595 \cdot 16.3ft \cdot \frac{12in}{ft} = 1.16$$

No good; $\eta D = 1.16$ is not on graph.

Try D where $\eta D = 1.5$

$$D = \frac{1.5}{0.00595 \cdot 12} = 21.0 \text{ ft}$$

From graph (Free Head with $e_c/D = 0.0$),

$$\frac{y(EI)^{\frac{3}{5}}k_h^{\frac{2}{5}}}{Q_a D} = 4.75$$

Solving for y:

$$y = \frac{4.75 \cdot Q_a D}{(EI)^{\frac{3}{5}}k_h^{\frac{2}{5}}} = \frac{4.75 \cdot 40000 \cdot 21 \cdot 12}{(3605000 \cdot 260576)^{\frac{3}{5}}(7)^{\frac{2}{5}}} = 1.44 > 1 \text{ inch}$$

No Good.

Try D=23 ft

$$\eta D = 0.00595 \cdot 23ft \cdot \frac{12in}{ft} = 1.64$$

From graph,

$$\frac{y(EI)^{\frac{3}{5}}k_h^{\frac{2}{5}}}{Q_a D} = 3.5$$

Solving for y:

$$y = \frac{3.5 \cdot Q_a D}{(EI)^{\frac{3}{5}}k_h^{\frac{2}{5}}} = \frac{3.5 \cdot 40000 \cdot 23 \cdot 12}{(3605000 \cdot 260576)^{\frac{3}{5}}(7)^{\frac{2}{5}}} = 1.16 \text{ inch}$$

Try D=25 ft

$$\eta D = 0.00595 \cdot 25 \text{ ft} \cdot \frac{12 \text{ in}}{\text{ft}} = 1.79$$

From graph,

$$\frac{y(EI)^{\frac{3}{5}} k h^{\frac{2}{5}}}{Q_a D} = 2.5$$

Solving for y:

$$y = \frac{2.5 \cdot Q_a D}{(EI)^{\frac{3}{5}} k h^{\frac{2}{5}}} = \frac{2.5 \cdot 40000 \cdot 25 \cdot 12}{(3605000 \cdot 260576)^{\frac{3}{5}} (7)^{\frac{2}{5}}} = 0.90 \text{ inch}$$

Okay, $y < 1$ inch

Use 4' diameter drilled shaft, 25 ft deep

Appendix H

Specifications and Standards

ASTM

<u>Subject</u>	<u>ASTM</u>
Standard Test Methods for Absorption and Bulk Specific Gravity of Dimension Stone	C 97
Standard Test Method for Density, Relative Density (Specific Gravity), and Absorption of Coarse Aggregate	C 127
Standard Test Method for Sieve Analysis of Fine and Coarse Aggregate	C 136
Standard Test Methods for Chloride Ion In Water	D 512
Standard Test Method for Laboratory Compaction Characteristics of Soil Using Standard Effort (12,400 ft-lbf/ft ³ (600 kN-m/m ³))	D 698
Standard Test Method for Specific Gravity of Soil Solids by Water Pycnometer	D 854
Standard Test Methods for Electrical Conductivity and Resistivity of Water	D 1125
Standard Test Method for Deep Foundations Under Static Axial Compressive Load	D 1143
Standard Test Methods for pH of Water	D 1293
Standard Practice for Soil Exploration and Sampling by Auger Borings	D 1452
Standard Test Method for Laboratory Compaction Characteristics of Soil Using Modified Effort (56,000 ft-lbf/ft ³ (2,700 kN-m/m ³))	D 1557
Standard Test Method for Penetration Test (SPT) and Split-Barrel Sampling of Soils	D 1586
Standard Practice for Thin-Walled Tube Sampling of Soils for Geotechnical Purposes	D 1587
Standard Practice for Rock Core Drilling and Sampling of Rock for Site Exploration	D 2113
Standard Test Method for Unconfined Compressive Strength of Cohesive Soil	D 2166
Standard Test Methods for Laboratory Determination of Water (Moisture) Content of Soil and Rock by Mass	D 2216
Standard Test Method for Permeability of Granular Soils (Constant Head)	D 2434
Standard Test Methods for One-Dimensional Consolidation Properties of Soils Using Incremental Loading	D 2435
Standard Classification of Soils for Engineering Purposes (Unified Soil Classification System)	D 2487
Standard Practice for Description and Identification of Soils (Visual-Manual Procedure)	D 2488
Standard Test Method for Field Vane Shear Test in Cohesive Soil	D 2573
Standard Test Method for Unconsolidated-Undrained Triaxial Compression Test on Cohesive Soils	D 2850

<u>Subject</u>	<u>ASTM</u>
Standard Test Methods for Moisture, Ash, and Organic Matter of Peat and Other Organic Soils	D 2974
Standard Practice for Classification of Soils and Soil-Aggregate Mixtures for Highway Construction Purposes	D 3282
Standard Test Method for Infiltration Rate of Soils in Field Using Double-Ring Infiltrometer	D 3385
Standard Test Method for Deep Foundations Under Static Axial Tensile Load	D 3689
Standard Test Method for Piles Under Lateral Loads	D 3966
Standard Test Method for Splitting Tensile Strength of Intact Rock Core Specimens	D 3967
Standard Test Method (Field Procedure) for Withdrawal and Injection Well Tests for Determining Hydraulic Properties of Aquifer Systems	D 4050
Standard Test Method for Sulfate Ion in Brackish Water, Seawater, and Brines	D 4130
Standard Test Method for One-Dimensional Consolidation Properties of Saturated Cohesive Soils Using Controlled-Strain Loading	D 4186
Standard Practices for Preserving and Transporting Soil Samples	D 4220
Standard Test Methods for Maximum Index Density and Unit Weight of Soils Using a Vibratory Table	D 4253
Standard Test Method for Minimum Index Density and Unit Weight of Soils and Calculation of Relative Density	D 4254
Standard Test Method for Liquid Limit, Plastic Limit, and Plasticity Index of Soils	D 4318
Standard Test Method for Density of Bentonitic Slurries	D 4380
Standard Test Method for Sand Content by Volume of Bentonitic Slurries	D 4381
Standard Classification of Peat Samples by Laboratory Testing	D 4427
Standard Test Methods for Crosshole Seismic Testing	D 4428
Standard Practice for Estimating Peat Deposit Thickness	D 4544
Standard Test Methods for One-Dimensional Swell or Collapse of Cohesive Soils	D 4546
Standard Test Method for Energy Measurement for Dynamic Penetrometers	D 4633
Standard Test Method for Determination of Water (Moisture) Content of Soil by Microwave Oven Heating	D 4643
Standard Test Method for Laboratory Miniature Vane Shear Test for Saturated Fine-Grained Clayey Soil	D 4648
Standard Test Method for Prebored Pressuremeter Testing in Soils	D 4719

<u>Subject</u>	<u>ASTM</u>
Standard Test Method for Consolidated Undrained Triaxial Compression Test for Cohesive Soils	D 4767
Standard Test Method for Shrinkage Factors of Soils by the Wax Method	D 4943
Standard Test Method for High-Strain Dynamic Testing of Deep Foundations	D 4945
Standard Practices for Preserving and Transporting Rock Core Samples	D 5079
Standard Test Method for Measurement of Hydraulic Conductivity of Saturated Porous Materials Using a Flexible Wall Permeameter	D 5084
Standard Guide for Field Logging of Subsurface Explorations of Soil and Rock	D 5434
Standard Guide for Planning and Conducting Borehole Geophysical Logging	D 5753
Standard Guide for Using the Seismic Refraction Method for Subsurface Investigation	D 5777
Standard Test Method for Performing Electronic Friction Cone and Piezocone Penetration Testing of Soils	D 5778
Standard Test Method for Low Strain Integrity Testing of Deep Foundations	D 5882
Standard Test Method for Measurement of Hydraulic Conductivity of Porous Material Using a Rigid-Wall, Compaction-Mold Permeameter	D 5856
Standard Practice for Using Significant Digits in Geotechnical Data	D 6026
Standard Practice for Using the Electronic Piezocone Penetrometer Tests for Environmental Site Characterization and Estimation of Hydraulic Conductivity	D 6067
Standard Practice for Using Hollow-Stem Augers for Geotechnical Exploration and Soil Sampling	D 6151
Standard Test Method for Field Measurement of Hydraulic Conductivity Using Borehole Infiltration	D 6391
Standard Guide for Selecting Surface Geophysical Methods	D 6429
Standard Test Method for Performing the Flat Plate Dilatometer Test	D 6635
Standard Test Method for Integrity Testing of Concrete Deep Foundations by Ultrasonic Crosshole Testing	D 6760
Standard Test Methods for Particle-Size Distribution (Gradation) of Soils Using Sieve Analysis	D 6913
Standard Test Method for Use of the Dynamic Cone Penetrometer in Shallow Pavement Applications	D 6951
Standard Test Method for Compressive Strength and Elastic Moduli of Intact Rock Core Specimens under Varying States of Stress and Temperatures	D 7012
Standard Test Method for Consolidated Drained Triaxial Compression Test for Soils	D 7181

<u>Subject</u>	<u>ASTM</u>
Standard Test Methods for Laboratory Determination of Density (Unit Weight) of Soil Specimens	D 7263
Standard Test Methods for Axial Compressive Force Pulse (Rapid) Testing of Deep Foundations	D 7383
Standard Test Method for Measuring pH of Soil for Use in Corrosion Testing	G 51
Standard Test Method for Field Measurement of Soil Resistivity Using the Wenner Four-Electrode Method	G 57
American National Standard for Use of the International System of Units (SI): The Modern Metric System	SI-10

AASHTO

<u>Subject</u>	<u>AASHTO</u>
Standard Classification of Soils and Soil-Aggregate Mixtures for Highway Construction Purposes	M 145
Standard Test Method for Sieve Analysis of Fine and Coarse Aggregate	T 27
Standard Test Method for Specific Gravity and Absorption of Coarse Aggregate	T 85
Standard Test Method for Particle-Size Analysis of Soils	T 88
Standard Method of Test for Determining the Liquid Limit of Soils	T 89
Standard Method of Test for Determining the Plastic Limit and Plasticity Index of Soils	T 90
Standard Method of Test for Moisture-Density Relations of Soils Using a 2.5-kg (5.5-lb) Rammer and a 305-mm (12-in.) Drop	T 99
Standard Test Method for Specific Gravity of Soils	T 100
Standard Method of Test for Moisture-Density Relations of Soils Using a 4.54-kg (10-lb) Rammer and a 457-mm (18-in.) Drop	T 180
Standard Test Method for Penetration Test and Split-Barrel Sampling of Soils	T 206
Standard Method of Test for Thin-Walled Tube Sampling of Soils	T 207
Standard Test Method for Unconfined Compressive Strength of Cohesive Soil	T 208
Standard Test Method for Permeability of Granular Soils (Constant Head)	T 215
Standard Test Method for One-Dimensional Consolidation Properties of Soils	T 216
Standard Test Method for Field Vane Shear Test in Cohesive Soil	T 223
Standard Practice for Diamond Core Drilling for Site Investigation	T 225
Standard Method of Test for Measurements of Pore Pressures in Soils	T 252
Standard Method of Test for Determining Expansive Soils	T 258
Standard Method of Test for Laboratory Determination of Moisture Content of Soils	T 265
Standard Method of Test for Determination of Organic Content in Soils by Loss on Ignition	T 267
Standard Test Method for Unconsolidated, Undrained Compressive Strength of Cohesive Soils in Triaxial Compression	T 296
Standard Test Method for High-Strain Dynamic Testing of Piles	T 298
Standard Test Method for Grain-Size Analysis of Granular Soil Materials	T 311

Florida Test Methods

<u>Subject</u>	<u>FM</u>
Standard Test Method for Coefficient of Permeability - Falling Head	5-513
Standard Test Method for Limerock Bearing Ratio (LBR)	5-515
Standard Test Method for pH of Soil and Water	5-550
Standard Test Methods for Resistivity of Soil and Water	5-551
Standard Test Methods for Chloride in Soil and Water	5-552
Standard Test Method for Sulfate in Soil and Water	5-553
Standard Test Method for Determination Of Mean Permeability In The Field Using The Vertical Insitu Permeameter (VIP)	5-614
Standard Test Method for Specific Gravity and Absorption of Coarse Aggregate	1-T 085
Standard Test Method for Particle-Size Analysis of Soils	1-T 088
Standard Test Method for Determining the Liquid Limit of Soils	1-T-089
Standard Test Method for Determining the Plastic Limit and Plasticity Index of Soils	1-T-090
Standard Test Method for Specific Gravity of Soils	1-T 100
Standard Test Method for Moisture Density Relations of Soils Using a 10-lb. (4.54kg) Rammer and an 18-in. (457mm) Drop	1-T 180
Standard Practice for Thin-Walled Tube Geotechnical Sampling of Soils	1-T 207
Standard Test Method for Permeability of Granular Soils (Constant Head)	1-T 215
Standard Test Method for One-Dimensional Consolidation Properties of Soils	1-T 216
Standard Test Method for Direct Shear Test of Soils Under Consolidated Drained Conditions	1-T 236
Standard Test Method for Laboratory Determination of Moisture Content of Soils	1-T 265
Standard Test Methods for Determination of Organic Content in Soils by Loss on Ignition	1-T 267
Standard Test Method for Unconsolidated, Undrained Compressive Strength of Cohesive Soils in Triaxial Compression	1-T 296
Standard Test Method for Consolidated Undrained Triaxial Compression Test for Cohesive Soils	1-T 297
Standard Test Method for Direct Shear Test of Soils Under Consolidated Drained Conditions	3-D3080
Standard Test Method for Density of Bentonitic Slurries	8-RP13B-1
Viscosity of Slurry	8-RP13B-2
Standard Test Method for Sand Content by Volume of Bentonitic Slurries	8-RP13B-3

Subject
pH of Slurry

FM
8-RP13B-4

Appendix I

Reference List

AASHTO

AASHTO LRFD Bridge Design Specifications, AASHTO, Washington DC, (Current version).

Manual on Subsurface Investigations, AASHTO, Washington DC, 1988.

Technical Manual for Design and Construction of Road Tunnels – Civil Elements, AASHTO, Washington DC, 2010.

NCHRP

Recommended Guidelines for Sealing Geotechnical Exploratory Holes, National Cooperative Highway Research Program, NCHRP Report 378

Dunnicliff, John, Geotechnical Instrumentation for Monitoring Field Performance, NCHRP Synthesis 89, Transportation Research Board, 1993.

TRB

M. McVay, B. Armaghani, and R. Casper; “Design and Construction of Auger-Cast Piles in Florida” in Design and Construction of Auger Cast Piles, and Other Foundation Issues, Transportation Research Record No. 1447, 1994

FDOT

Guidelines For Use In The Soils Investigation and Design of Foundations For Bridge Structures In The State Of Florida, Research Report 121-A, Florida Department of Transportation, 1967.

Rigid Pavement Design Manual, FDOT, (Current version)

Drainage Manual, Florida Department of Transportation, (Current version)

Standard Plans for Road and Bridge Construction, Florida Department of Transportation, (Current version).

Structures Design Guidelines, Florida Department of Transportation, (Current version).

FDOT Design Manual, Florida Department of Transportation, (Current version).

FHWA

FHWA-IP-77-8 The Texas Quick-Load Method for Foundation Load Testing – User’s Manual

FHWA-TS-78-209 Guidelines for Cone Penetration Test - Performance and Design

FHWA-IP-84-11 Handbook on Design of Piles and Drilled Shafts Under Lateral Load

FHWA-RD-86-185 Spread Footings for Highway Bridges

FHWA-RD-86-186 Prefabricated Vertical Drains Vol. I, Engineering Guidelines

FHWA HI-88-009 Soils and Foundations Workshop Manual – Second Edition

FHWA-IP-89-008 The Pressuremeter Test for Highway Applications

FHWA-SA-91-042 Static Testing of Deep Foundations

FHWA-SA-91-043 Manual on the Cone Penetrometer Test

FHWA-SA-91-044 Manual on the Dilatometer Test

FHWA-SA-91-048 Com624P – Laterally Loaded Pile Analysis Program for the Microcomputer Version 2.0

FHWA-SA-92-045 EMBank- A Microcomputer Program to Determine One-Dimensional Compression Due to Embankment Loads

FHWA-SA-93-068 Soil Nailing Field Inspectors Manual

FHWA-SA-94-005 Advance Course on Soil Slope Stability: Volume I, Slope Stability Manual

FHWA-SA-94-034 CBEAR - Bearing Capacity Analysis of Shallow Foundations User's Manual,

FHWA-SA-94-035 The Osterberg CELL for Load Testing Drilled Shafts and Driven Piles

FHWA HI-95-038 Geosynthetic Design and Construction Guidelines

FHWA-RD-95-172 Load Transfer for Drilled Shafts in Intermediate Geomaterials

FHWA-RD-96-016 thru 019 Drilled and Grouted Micropiles: State of Practice Review Vol I – Vol IV

FHWA-SA-96-039 RSS Reinforced Slope Stability A Microcomputer Program User's Manual

FHWA-SA-96-069R Manual for Design & Construction Monitoring of Soil Nail Walls

FHWA-RD-96-179 thru 181 Determination of Pile Driveability and Capacity from Penetration Tests Vol I - Vol III

FHWA-HI-97-021 Subsurface Investigations

FHWA-RD-97-130 Design Manual for Permanent Ground Anchor Walls

FHWA-HI-98-034 Geotechnical Instrumentation

FHWA-RD-98-065 thru 068 Summary Report of Research on Permanent Ground Anchor Walls

FHWA-RD-99-170 Extrapolation of Pile Capacity From Non-Failed Load Tests

FHWA-IF-99-025 Drilled Shafts: Construction Procedures and Design Methods

FHWA-IF-04-021 Application of Geophysical Methods to Highway Related Problems

FHWA-NHI-05-042 and 043 Design and Construction of Driven Pile Foundations, Reference Manual Volumes I & II

FHWA-NHI-05-094 Load and Resistance Factor Design for Highway Bridge Substructures and Earth Retaining Structures

FHWA-NHI-06-019 and 020 Ground Improvement Methods, Reference Manual Volumes I & II

FHWA-NHI-07-071 Earth Retaining Structures Reference Manual

FHWA-NHI-10-024 thru 025 Design and Construction of Mechanically Stabilized Earth Walls and Reinforced Soil Slopes Volumes I & II

FHWA-HRT-13-046 Deep Mixing for Embankment and Foundation Support

- Geotechnical Engineering Circular No. 1 Dynamic Compaction
- Geotechnical Engineering Circular No. 2 Earth Retaining Systems
- Geotechnical Engineering Circular No. 4 Ground Anchors and Anchored Systems
- Geotechnical Engineering Circular No. 5 Evaluation of Soil and Rock Properties
- Geotechnical Engineering Circular No. 7 Soil Nail Walls
- Geotechnical Engineering Circular No. 8 Design And Construction Of Continuous Flight Auger Piles
- Geotechnical Engineering Circular No. 11 Mechanically Stabilized Earth Walls and Reinforced Soil Slopes

“Checklist and Guidelines for Review of Geotechnical Reports and Preliminary Plans and Specifications,” Federal Highway Administration, 1985. Revised 2003.

Military

NAVFAC DM-7.1 - Soil Mechanics, Department of the Navy, Naval Facilities Engineering Command, 1986.

NAVFAC DM-7.2 - Foundations and Earth Structures, Department of the Navy, Naval Facilities Engineering Command, 1986.

Engineering Classification and Index Properties for Intact Rock Technical Report No. AFWL-TR-65-116, Air Force Weapons Laboratory, New Mexico, 1966.

Geophysical Exploration for Engineering and Environmental Investigations, Engineering Manual 1110-1-1802, Department of Army, U.S. Army Corps of Engineers, 1995

Other Federal

U.S. Environmental Protection Agency, Land Treatment of Municipal Wastewater - Process Design Manual, 1981.

Earth Manual, US Department of Interior, Bureau of Reclamation, US Government Printing Office, Washington, D.C., 1994.

Misc.

Marchetti, Silvano, In-Situ Tests by Flat Dilatometer, Journal of the Geotechnical Engineering Division, ASCE, Vol. 106, No. GT3, March 1980.

Baldi, G., Bellotti R., Ghionna, V., Jamiolkowski, M., Marchetti, S. and Pasqualini, E. Flat Dilatometer Tests in Calibration Chambers, Use of Insitu Tests in Geotechnical Engineering, ASCE Specialty Conference, Geotechnical Special Publication No. 6, 1986. Schmertmann, John, Suggested Method for Performing the Flat Dilatometer Test, Geotechnical Testing Journal, ASTM, Vol. 9, No. 2, June 1986.

Standards For Onsite Sewage Disposal Systems, Rules of the Department of Health and Rehabilitative Services, Chapter 10 D-6, Florida Administrative Code.

Lambe, T. William, Soil Testing for Engineers, John Wiley & Sons, Inc. New York, NY, 1951.

Fang, Hsai-Yang, Foundation Engineering Handbook, Second Edition, Van Nostrand Reinhold Company, New York, 1990.

Dunnicliff, John, Geotechnical Instrumentation for Monitoring Field Performance, Wiley-Interscience, New York, 1993.

Duncan, J.M. & Buchignani, A.L., An Engineering Manual for Settlement Studies, Department of Civil Engineering, University of California, Berkeley, 1976.

Goble, G.G. & Rausche, Frank, GRLWEAP, Wave Equation Analysis of Pile Foundations, GRL & Associates, Inc., 1991.

Pile Driving Analyzer Manual, PAK, Pile Dynamics, Inc., Cleveland, Ohio, 1997

McVay, M. C., Townsend, F.C., and Williams, R.C. (1992), "Design of Socketed Drilled Shafts in Limestone" ASCE Journal of Geotechnical Engineering, Vol. 118, No. 10, October, 1992.