

PLANS PREPARATION MANUAL VOLUME 1

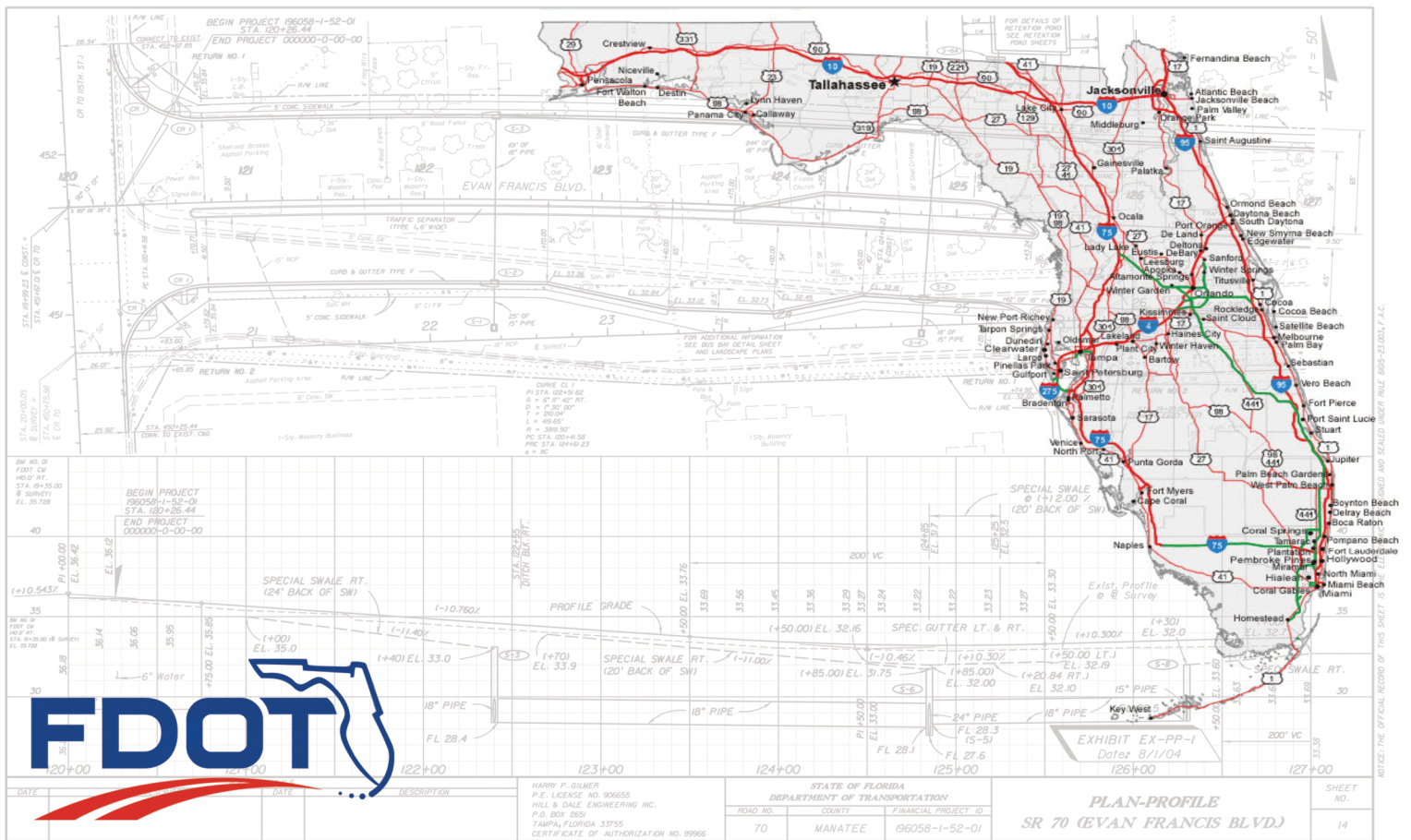

DESIGN CRITERIA AND PROCESS

JANUARY 2017

P LANS
PREPARATION
MANUAL

VOLUME

1

DESIGN
CRITERIA
AND
PROCESS



PLANS PREPARATION MANUAL

VOLUME 1



ROADWAY DESIGN OFFICE

TALLAHASSEE, FLORIDA

JANUARY 1, 2017 EDITION

<http://www.dot.state.fl.us/rddesign/PPMManual/PPM.shtm>

THIS PAGE LEFT BLANK INTENTIONALLY

PLANS PREPARATION MANUAL

REGISTRATION

The Department of Transportation has a contact database that will enable the Department to e-mail important information to registered users on topics selected by each user. The database will allow a user to update their e-mail address, topics of interest and any other information in their profile at any time. The information users provide will not be shared with any other company or agency.

All PPM users (and other Roadway Design manual users) must register their e-mail addresses in this contact database in order to receive future updates, notices, design memos, or other important information concerning the Department's design manuals. PPM users who have not already done so can register in the contact database at the following link:

<http://www2.dot.state.fl.us/contactmanagement/>

THIS PAGE LEFT BLANK INTENTIONALLY

STATE OF FLORIDA DEPARTMENT OF TRANSPORTATION

**SUGGESTIONS AND COMMENTS
PLANS PREPARATION MANUAL**

**NAME OF FIRM OR
FDOT DEPARTMENT:**

PHYSICAL ADDRESS:

**NAME OF PERSON
RESPONSIBLE FOR
SUGGESTIONS OR
COMMENTS:**

EMAIL ADDRESS:

TELEPHONE NO.:

FAX NO.:

**SUGGESTIONS
OR COMMENTS:**

(Comments or Suggestions may be attached as marked up copies of pages from the manual)

Please complete the requested information on a copy of this sheet and return to:

**FLORIDA DEPARTMENT OF TRANSPORTATION
ROADWAY DESIGN OFFICE
MAIL STATION 32
605 SUWANNEE STREET
TALLAHASSEE, FLORIDA 32399-0450
FAX NUMBER (850) 414-5261**

THIS PAGE LEFT BLANK INTENTIONALLY

Table of Contents

Introduction

Glossary of Terms

Chapter 1	Design Controls
Chapter 2	Design Geometrics and Criteria
Chapter 3	Earthwork
Chapter 4	Roadside Safety
Chapter 5	Utilities
Chapter 6	Railroad Crossing
Chapter 7	Traffic and ITS Design
Chapter 8	Pedestrian, Bicycle and Public Transit Facilities
Chapter 9	Landscape and Community Features
Chapter 10	Transportation Management Plan
Chapter 11	Stormwater Pollution Prevention Plan
Chapter 12	Right of Way
Chapter 13	Initial Engineering Design Process
Chapter 14	Final Engineering Design Process
Chapter 15	Update Engineering Design Process
Chapter 16	Design Submittals
Chapter 17	Engineering Design Estimate Process
Chapter 18	Quality Assurance and Quality Control
Chapter 19	Signing and Sealing Documents
Chapter 20	Plans Processing and Revisions
Chapter 21	Transportation Design for Livable Communities
Chapter 22	Lump Sum Project Guidelines
Chapter 23	Design Exceptions and Design Variations
Chapter 24	Federal Aid Project Certification
Chapter 25	Florida's Design Criteria for Resurfacing, Restoration and Rehabilitation (RRR) of Streets and Highways
Chapter 26	Bridge Project Development
Chapter 27	Hydraulic Data and Agency Permits
Chapter 28	Shop and Erection Drawings
Chapter 29	Structural Supports for Signs, Luminaires, and Traffic Signals
Chapter 30	Retaining Walls
Chapter 31	Geosynthetic Design
Chapter 32	Noise Walls and Perimeters Walls
Chapter 33	Reinforced Concrete Box and Three-Sided Culverts
Chapter 34	Monitor Existing Structures

THIS PAGE LEFT BLANK INTENTIONALLY

Approved:

Effective: January 1, 2017
Office: Roadway Design Office
Topic No.: 625-000-007

Department of Transportation

Introduction

Plans Preparation Manual, Volume 1

PURPOSE:

This *Plans Preparation Manual, Volume 1* sets forth geometric and other design criteria, as well as procedures, for Florida Department of Transportation (FDOT) projects. The information contained herein applies to the preparation of contract plans for roadways and structures.

AUTHORITY:

Sections 20.23(3)(a) and 334.048(3), Florida Statutes.

SCOPE:

This procedure impacts anyone preparing roadway and structures construction plans for the Department.

PROCEDURE:

The criteria in this manual represent requirements for the State Highway System which must be met for the design of FDOT projects unless approved Design Exceptions or Design Variations are obtained in accordance with procedures outlined in this manual.

Roadway and structures design is primarily a matter of sound application of acceptable engineering criteria and standards. While the criteria contained in this manual provide a basis for uniform design practice for typical roadway design situations, precise standards which would apply to individual situations must rely on good engineering practice and analyses.

Special requirements for Non-Conventional Projects, e.g., Design-Build Projects and all Non-Design-Bid-Build Public-Private-Partnership Projects, may be shown in a “Modification for Non-Conventional Projects” box as shown in the following example:

Modification for Non-Conventional Projects:
Delete PPM 7.2.6 and replace with the following:
7.2.6 Signing Project Coordination
The Design-Build firm must submit a master signing plan with the Technical Proposal. The master signing plan can be on a roll plot.

These boxes are located at the beginning of the chapter or after a section, paragraph or table which is to be modified. The requirements listed within these boxes are only applicable to Non-Conventional Projects.

The Author of a Request for Proposal (RFP) for a Non-Conventional project must use the standard boilerplate language as a starting point in developing RFPs on all Department Design-Build projects. **Section V** of the **Design-Build Boilerplate** establishes Department, FHWA and AASHTO criteria, procedures, guidelines and design codes that serve as design constraints to be used in the performance of the work. The governing regulations list in **Section V** cannot be modified without the approval of the State Construction Office. The standard boilerplate language is available at the FDOT Construction Office website:

<http://www.dot.state.fl.us/construction/DesignBuild/DBDocuments/DBDocsMain.shtm>

Pre-scoping questions have been developed to aid in the establishment of project constraints and requirements to be included in the RFP. The Pre-scoping questions can be found at:

<http://www.dot.state.fl.us/construction/DesignBuild/DBRules/DBRulesMain.shtm>

Situations will exist where these criteria will not apply. The inappropriate use of and adherence to these criteria does not exempt the engineer from the professional responsibility of developing an appropriate design. The engineer is responsible for identifying those criteria which may not apply to a particular design, and for obtaining the necessary Design Exception or Design Variation to achieve proper design.

1. PLANS PREPARATION MANUAL, VOLUME 1 - MANUAL ORGANIZATION

a. Background

The Florida Department of Transportation *Plans Preparation Manual (PPM)* was published in the current format in January 1998. The criteria in the 1998 PPM were given in metric units.

b. Organization

The *Plans Preparation Manual* is a two-volume manual. *Volume 1* contains the design criteria and process and *Volume 2* contains material concerning plans preparation and assembly.

2. DISTRIBUTION

This document is available electronically on the PPM web page:

<http://www.dot.state.fl.us/rddesign/PPMManual/PPM.shtm>

PPM users can register to receive notification of updates and *Roadway Design Bulletins* online through the Department's Contact Management Database at:

<http://www2.dot.state.fl.us/contactmanagement/>

For information on updates and *Roadway Design Bulletins*, contact:

Roadway Design Office, Mail Station 32

Telephone (850) 414-4310

FAX Number (850) 414-5261

<http://www.dot.state.fl.us/rddesign/>

3. REVISIONS AND UPDATES

Plans Preparation Manual (PPM) users are encouraged to submit comments and suggestions for changes to the manual to the State Roadway Design Office. When ideas or suggestions are received they will be reviewed by appropriate Roadway and/or Structures Design staff in a timely manner and will be coordinated with other offices affected by the proposed change. Items warranting immediate change will be made with the approval of the State Roadway Design Engineer and/or State Structures Design Engineer in the form of a *Design Bulletin*.

Roadway Design Bulletins are numbered based on the two digit calendar year and bulletin number (YY-##). Notices are sent to all users who are registered to receive notifications for **Roadway Design Bulletins** and updates to the **PPM**. Design Bulletins affecting the **PPM** will remain effective until either:

1. An official manual revision is published; or
2. The **Design Bulletin** is made void.

Roadway Design Bulletins are posted online at:

<http://www.dot.state.fl.us/rddesign/bulletin/>

Structures design issues, which are subject to modification and revision, will be processed in coordination with the State Structures Design Office. See the **Structures Manual** for more information on this process.

Proposed revisions are distributed in draft form to each District's Roadway Design Engineer or Structures Design Engineer. These experienced engineers provide the necessary technical and practical input on how the revision will potentially affect their District's operations and customers. Periodically, these engineers meet collectively with the State Roadway Design Office or the State Structures Design Office to discuss comments on the proposed revisions. Proposed revisions with comments are then presented to the District Design Engineers (DDE) for review and comment. Once the comments are addressed, the Florida FHWA Division Office is given the opportunity to review the revisions as per the Department's Partnership Agreement with FHWA.

The State Roadway Design Office will also coordinate proposed revisions or additions with affected offices within the Central Office. Substantive revisions that result in policy change may be coordinated with the Executive Committee for adoption.

Revisions and updates are adopted or rejected by the State Roadway Design Engineer (for Roadway Design issues) or the State Structures Design Engineer (for Structures Design issues). Requirements mandated by FHWA or State Rules will be coordinated with the DDEs and affected offices within the Central Office and are considered compulsory.

All revisions and updates will be coordinated with the Forms and Procedures Office prior to publishing to ensure conformance with and incorporation into the Department's Standard Operating System.

Notification of the adopted revisions and addenda will be distributed to registered users of the manual through the Department's Contact Management Database.

TRAINING:

None required.

FORMS ACCESS:

Documents marked as **Exhibits** provide only a starting point allowing users to change or alter the document as needed to fit specific situations. These Exhibits are not official forms of the Department. Templates for these documents are available online at:

<http://www.dot.state.fl.us/rddesign/PPMManual/NForms/PPMForm.shtm>

THIS PAGE LEFT BLANK INTENTIONALLY

GLOSSARY OF TERMS

In the application of the criteria in this manual, the following definitions are assigned for consistency of understanding and interpretation.

1. **Arterials:** Divided or undivided, relatively continuous routes that primarily serve through traffic, high traffic volumes, and long average trip lengths. Traffic movement is of primary importance, with abutting land access of secondary importance. Arterials include expressways without full control of access, US numbered routes and principal state routes. May be classified as urban or rural.
2. **Auxiliary Lane:** The designated widths of roadway pavement marked to separate speed change, turning, passing and climbing maneuvers from through traffic. They may also provide short capacity segments.
3. **Bicycle Lane:** A bicycle lane (bike lane) is a portion of a roadway (either with curb and gutter or a flush shoulder) which has been designated by striping and special pavement markings for the preferential use by bicyclists.
4. **Bicycle Way:** Any road, path or way which by law is open to bicycle travel, regardless of whether such facilities are signed and marked for the preferential use by bicyclists or are to be shared with other transportation modes. Examples include bicycle lanes, paved shoulders, shared use paths, and traffic lanes.
5. **C-D Roads:** Collector-Distributor Roads are limited access roadways provided within a single interchange, or continuously through two or more interchanges on a freeway segment. They provide access to and from the freeway, and reduce and control the number of ingress and egress points on the through freeway. They are similar to continuous frontage roads except that access to abutting property is not permitted.
6. **Collectors:** Divided or undivided routes which serve to link arterial routes with local roads or major traffic generators. They serve as transition link between mobility needs and land use needs. Collectors include minor state routes, major county roads, and major urban and suburban streets.
7. **Conventional Projects:** Projects for which the preparation of the contract documents is a 'stand-alone' effort resulting in Plans, Specifications and Estimates required to advertise a Construction Contract.

8. **Divided Highway:** A highway that provides a median separation between the traffic in opposite directions.
9. **Freeways:** Divided highways, with full control of access. Movement of traffic free of interference and conflicts is of primary importance. Essential elements include medians, grade separations, interchanges, and, in some cases, collector-distributor roads and frontage roads. Freeways include Interstate, toll road and expressway systems. May be classified as urban or rural.
10. **High Speed:** Descriptive term used to summarize all conditions governing the selection of Design Speeds 50 mph and greater.
11. **Highway:** A public road used for any mode of transportation.
12. **HOV Lane:** Special designated widths of pavement marked to provide travel lanes for high occupancy vehicles (HOV). They may be directly adjacent to other travel lanes or separated.
13. **Local Roads:** Routes which provide high access to abutting property, low average traffic volumes, short average trip lengths and on which through traffic movements are not of primary importance. Local roads include minor county roads, minor urban and suburban subdivision streets, and graded or unimproved roads.
14. **Low Speed:** Descriptive term used to summarize all conditions governing the selection of Design Speed of less than 50 mph.
15. **Low Volume and High Volume:** Descriptive terms used to describe certain operating characteristics and driver expectancy on highways. Criteria for some elements are selected according to these qualifying controls. Standards for these controls are given in the table following this section.
16. **Match Existing:** This term is used when the existing cross slopes are to remain. This is applicable to constant depth milling and resurfacing.
17. **Median:** A median is the portion of a highway separating opposing directions of the traveled way. Medians may be depressed, raised, or flush with the traveled way surface.

18. **Paratransit:** Comparable transportation service required by the American with Disabilities Act (ADA) for individuals with disabilities who are unable to use fixed route transportation systems. The specific requirements and parameters for this service, including eligibility and service requirements, are contained in 49 CFR Part 37, Subpart F.
19. **Pedestrian Access Route:** A continuous and unobstructed path of travel provided for pedestrians with disabilities within or coinciding with a pedestrian way.
20. **Pedestrian Way:** A space for pedestrian travel separated from traffic lanes. Sidewalks, shared use paths, footpaths and shoulders are considered to be pedestrian ways. However, footpaths and shoulders are not accessible facilities, since they lack specific improvements or provisions to accommodate persons using mobility aids.
21. **Ramp:** A turning roadway that connects two or more legs at an interchange. The components of a ramp are a terminal at each leg and a connecting road. The geometry of the connecting road usually involves some curvature and a grade.
22. **Roadway:** The portion of a highway, including shoulders and adjacent bicycle lanes, for use by vehicles and bicycles.
23. **Rural Areas:** Places outside the boundaries of concentrated populations that accommodate higher speeds, longer trip lengths and freedom of movement, and are relatively free of street and highway networks. Rural environments are surroundings of similar characteristics.
24. **Shoulder Break:** Point of intersection of the shoulder slope plane and the embankment or ditch slope plane; i.e. where the full-width shoulder slope “breaks” to front slope of 1:x.
25. **Strategic Intermodal System (SIS):** A transportation system comprised of facilities and services of statewide and interregional significance, including appropriate components of all modes. The highway component includes all designated SIS Highway Corridors, Emerging SIS Highway Corridors, SIS Intermodal Connectors, and Emerging SIS Highway Intermodal Connectors.

26. **Streets:** The local system which provides direct access to residential neighborhoods and business districts, connects these areas to the higher order road systems and offers the highest access to abutting property; sometimes deliberately discouraging through-traffic movement and high speeds.

Note: Local roads and streets are not generally a part of the State Highway System and therefore, may not be governed by the FDOT roadway design criteria, but by the ***Manual of Uniform Minimum Standards for Design, Construction and Maintenance for Streets and Highways and/or criteria established by the local government.***

27. **Traffic Lane/Traveled Way:** The designated widths of roadway pavement, exclusive of shoulders and bicycle lanes, marked to separate opposing traffic or vehicles traveling in the same direction. Traffic lanes include through travel lanes, auxiliary lanes, turn lanes, weaving, passing, and climbing lanes. They provide space for passenger cars, trucks, buses, recreational vehicles and, in some cases, bicycles.
28. **Travel Lane:** The designated widths of roadway pavement marked to carry through traffic and to separate it from opposing traffic or traffic occupying other traffic lanes. Generally, travel lanes equate to the basic number of lanes for a facility.
29. **Truck Traffic:** When significant, heavy, substantial, high percent, etc. truck traffic is used as a qualifying control, it means 10% of the AADT or 10% of the daily count (24 hr.)
30. **Urban Area:** A geographic region comprising as a minimum the area inside the United States Bureau of the Census boundary of an urban place with a population of 5,000 or more persons, expanded to include adjacent developed areas as provided for by Federal Highway Administration (FHWA) regulations. The FHWA Urban Boundary maps are available online at:
<http://www.dot.state.fl.us/rddesign/PPMManual/BufferMaps.shtm>
31. **Urbanized Area:** A geographic region comprising as a minimum the area inside an urban place of 50,000 or more persons, as designated by the United States Bureau of the Census, expanded to include adjacent developed areas as provided for by Federal Highway Administration regulations. Urban areas with a population of fewer than 50,000 persons which are located within the expanded boundary of an urbanized area are not separately recognized.

STANDARDS FOR LOW AND HIGH VOLUME HIGHWAYS IN ANNUAL AVERAGE DAILY VOLUMES

HIGHWAY TYPE	LOW VOLUME AADT	HIGH VOLUME AADT
FREEWAY - URBAN		
4-LANE FACILITY	57,000	69,000
6-LANE FACILITY	86,000	103,000
8-LANE FACILITY	114,000	138,000
FREEWAY - RURAL		
4-LANE FACILITY	46,000	56,000
6-LANE FACILITY	69,000	83,000
8-LANE FACILITY	92,000	111,000
ARTERIALS - URBAN		
2-LANE FACILITY	16,000	20,000
4-LANE FACILITY	37,000	43,000
6-LANE FACILITY	55,000	64,000
8-LANE FACILITY	69,000	80,000
ARTERIALS - RURAL		
2-LANE FACILITY	9,000	14,000
4-LANE FACILITY	38,000	47,000
6-LANE FACILITY	58,000	71,000
COLLECTOR - URBAN		
2-LANE FACILITY	11,000	16,000
4-LANE FACILITY	37,000	45,000
COLLECTOR - RURAL		
2-LANE FACILITY	8,000	13,000
4-LANE FACILITY	30,000	38,000

LOW VOLUME FACILITIES ARE HIGHWAY TYPES WITH PROJECTED DESIGN YEAR **AADT** VOLUME EQUAL TO OR LESS THAN THE LOW VOLUME VALUES SHOWN.

HIGH VOLUME FACILITIES ARE HIGHWAY TYPES WITH PROJECTED DESIGN YEAR **AADT** VOLUME EQUAL TO OR GREATER THAN THE HIGH VOLUME VALUES SHOWN.

Chapter 1

Design Controls

1.1	General	1-1
1.2	Traffic	1-1
1.3	Capacity and Level of Service.....	1-3
1.4	Roadway Functional and System Classification.....	1-4
1.5	RRR Design	1-4
1.6	Design Consistency and Driver Expectancy	1-4
1.7	Transportation Design for Livable Communities (TDLC).....	1-6
1.7.1	Policy Statement	1-6
1.7.2	Aesthetics	1-6
1.8	Access Management.....	1-7
1.9	Design Speed.....	1-11
1.9.1	Design Speed Coordination and Approvals	1-11
1.10	Public Involvement	1-13
1.11	Context Sensitive Solutions in Design.....	1-15
1.12	Design Vehicle	1-15

Tables

Table 1.8.1	Freeway Interchange Spacing	1-9
Table 1.8.2	Arterial Access Management Classifications & Standards.....	1-10
Table 1.8.3	Interim Access Management Standards	1-10
Table 1.9.1	Design Speed State Highway System - Non-SIS Facilities	1-12
Table 1.9.2	Minimum Design Speed SIS	1-13

Figures

Figure 1.12.1	Florida Interstate Semitrailer (WB-62FL)	1-16
---------------	--	------

Chapter 1

Design Controls

1.1 General

Designs for highway and street projects are based on established design controls for the various elements of the project such as width of roadway, side slopes, horizontal and vertical alignment, drainage considerations and intersecting roads. Selection of the appropriate criteria and standards is influenced by traffic volume and composition, desired levels of service, functional classification, terrain features, roadside developments, environmental considerations and other individual characteristics.

The identification of applicable design controls is basic to providing the desired level of service, optimum safety, and cost effectiveness.

1.2 Traffic

It is the Department's responsibility to provide for an interconnected transportation system to ensure the mobility of people and goods. In order to achieve these objectives, designers determine if the proposed improvements will satisfy future needs by comparing the forecast directional hourly volume with the traffic handling capacity of an improved facility. Project traffic forecasts and capacity are used to establish the number of through lanes, length of auxiliary lanes, signalization timings, right of way requirements, etc., so that the facility will operate at an acceptable level of service through the design year.

Roadway geometric design is based on project traffic for the design year. The design year for new construction and reconstruction projects is 20 years after the project is opened to traffic. The Design Hourly Volume (DHV) is determined through the use of the Department's Standard "K" factors, as provided by the FDOT Transportation Statistics Office. The Standard "K" factors can be found in the Department's Project Traffic Forecasting Handbook.

The traffic forecast is also used in pavement design to determine the vehicular loadings on the pavement in order to provide structural strength through the pavement's service life. On pavement rehabilitation, the design year for pavement design varies from 8 to

20 years based on the type of construction. The pavement design manuals provide guidance.

Traffic forecasts are developed during the Project Development and Environmental (PD&E) study of a project. A Traffic Report is generally required. When a PD&E study is not conducted, traffic forecasts are prepared during the plans design process. Project traffic used for design are attested to as shown in **Chapter 19** of this Volume.

The following traffic information should be available to the designer prior to or very early in the design process:

Modification for Non-Conventional Projects:

Delete the previous sentence and replace with the following:

See RFP for the following traffic information:

1. AADT for the current year, opening year (completion of construction) and design year.
2. Existing hourly traffic volumes over minimum of 24-hour period, including peak hour turning movements and pedestrian counts.
3. Directional distribution factor (D).
4. Standard K factor (K).
5. Truck factors (T) for daily and peak hour.
6. Design speed and proposed posted speed.
7. Design vehicle for geometric design.
8. Turning movements and diagrams for existing and proposed signalized intersections.
9. Special or unique traffic conditions, including during construction.
10. Crash history, including analyses at high crash locations within the project limits.
11. Recommendations regarding parking or other traffic restrictions.

1.3 Capacity and Level of Service

The AASHTO publication *A Policy on Geometric Design of Highways and Streets* and the Transportation Research Board *Highway Capacity Manual* provide the detailed analysis and calculation guides necessary for the number and configurations of lanes required and the resulting levels of service provided. As illustrated in those texts, gradients, roadside developments, number, spacing and types of crossings and intersections, traffic volumes, and signalization patterns all greatly influence capacity and level of service. Those factors, in addition to the roadway functional classification, have a direct influence on the design speed to be adopted at the preliminary design level.

Design of signalized intersections should ensure an adequate Level of Service through the design year of the facility, especially when right of way acquisition is being considered. The capacity of an at-grade arterial or collector is primarily controlled by its ability to move traffic through signalized intersections, rather than the mid-block through lane capacity.

Use the operational analysis methods in the *Highway Capacity Manual* for design of signalized intersections. Information or assumptions on basic intersection geometrics, lane utilization, movement-specific traffic volumes, etc., is provided by the designer. The primary output of the operational analysis method is Level of Service and delay at a signalized intersection; however, this method can be used to determine geometric requirements, signal timing or service flow volumes.

It is emphasized that signal timing is interactive with geometric design. Changes to geometrics, such as adding a turn lane, must consider changes to the signal timing simultaneously. Department-approved software, including the *Highway Capacity Software*, should be used to simulate the operation of independent or interconnected signals. Output from these programs can be used for the analysis and evaluation of proposed designs.

1.4 Roadway Functional and System Classification

The AASHTO publication *A Policy on Geometric Design of Highways and Streets, 6th Edition (2011)* presents an excellent discussion on highway functional classifications. *Florida Statutes, Title XXVI, Chapters 334, 335 and 336* give similar definitions, and establish classifications for road design in the State of Florida.

The Systems Planning Office, in compliance with *Rule Chapter 14-97* and the *Florida Statutes*, has developed a comprehensive Access Management Classification system for all segments of the State Highway System. The purpose is to enhance the functional integrity of the State Highway System, protect public safety and provide improved mobility of goods and people.

Functional and Access Management classification and the standards required by them are predetermined controls over which the designer has little choice.

1.5 RRR Design

Design criteria applicable for the State Highway System facilities are contained in *Chapter 25* of this volume, *Florida's Design Criteria for Resurfacing, Restoration and Rehabilitation (RRR) of Streets and Highways*.

1.6 Design Consistency and Driver Expectancy

Design consistency is achieved when the geometric features of the roadway are consistent with the operational characteristics expected by the driver. Inconsistencies normally relate to:

1. Changes in design speed.
2. Changes in cross section.
3. Incompatibility in geometry and operational requirements.

Changes in design speed may occur on a given stretch of roadway because portions of the highway were built as separate projects over an extended period of time. Inconsistencies may be due to a number of factors: changes in standards or FDOT policy, reclassification of the facility, and lack of necessary funding.

There are two major types of design inconsistencies relative to cross section. These are point inconsistencies and a general incompatibility between cross section and alignment. A point inconsistency may be, for example, the narrowing of lane widths, a narrow bridge, a lane drop, or a change from multilane section to two lanes.

A cross sectional inconsistency is usually the result of upgrading a highway cross section without upgrading the alignment. Sometimes pavements are widened and shoulders added on an older two lane highway. The wider cross section on an old alignment might convey a conflicting message to the driver and lead to an inappropriate expectancy based on the visual aspects of the cross section, because cross section features can be more apparent than the alignment.

Widening alone can measurably improve the safety characteristics of a road, particularly on very narrow, low-volume roads. Designers should, however, be aware of potential inconsistencies that frequently can be overcome with relatively low cost treatments. In the case of widened roads on old alignments, pavement markings, warning signs, and delineation devices can be very helpful to the driver.

Inconsistencies may also relate to incompatibility in geometric and operational requirements. Occasionally elements of the design appear to have been selected for the purpose of fitting together the geometric components conveniently and economically rather than for the purpose of satisfying operational requirements. An example of an inconsistency resulting from the incompatibility is a direct entry ramp that is intended to permit vehicles to enter the stream of traffic without coming to a complete stop but which, in reality, forces the vehicle to stop when a gap in the traffic stream is not immediately available.

Design inconsistencies can result in driver uncertainty, an increase in response time and an increase in the probability of inappropriate driver response.

Driver expectancy relates to the readiness of the driver to respond to events, situations, or the presentation of information. It can be defined as an inclination, based on previous experience, to respond in a set manner to a roadway or traffic situation. It should be stressed that the initial response is to the expected situation rather than the actual one.

Expectancy can affect the perception and use of information. In most circumstances, the expected and actual conditions are the same. However, when design inconsistencies occur and a driver's expectancy is incorrect, it takes longer to respond properly, there may be no response, or the response may be inappropriate to actual conditions.

There are certain elements in the design of various components of the roadway that particularly affect design consistency, driver expectancy, and vehicular operation. These components include horizontal and vertical alignment, embankments and slopes, shoulders, crown and cross slope, superelevation, bridge widths, signing and delineation, guardrail and placement of utility poles or light supports.

1.7 Transportation Design for Livable Communities (TDLC)

1.7.1 Policy Statement

Designs should consider the incorporation of TDLC features on the State Highway System when such features are desired, appropriate and feasible.

The incorporation of such features is a shared responsibility between the Department and local government. Design criteria for TDLC projects are in **Chapter 21** of this Volume.

1.7.2 Aesthetics

Highways are built first and foremost for functional purposes, but the designer should be sensitive to how the highway will be perceived by the users. Designing aesthetic treatments is more than just providing for landscape plantings. The roadway should blend into the landscape, avoiding large cuts and fills, and round side slopes into the existing terrain. Horizontal and vertical alignment should be coordinated so that a driver has an opportunity to gain a sense of the local environment. Combinations of horizontal and crest vertical curves, and broken-back curves should be avoided. Excessively long tangent sections become monotonous. Either curvature or other features should be added to maintain drivers' interest.

Application of the clear zone concept discussed in the chapter on Roadside Safety will result in a clean, uncluttered and pleasing roadside. Landscaping of the roadside should be considered early in the design process, so that plantings blend in with the geometric design. **Chapter 9** of this Volume discusses landscape design criteria. At times, extra right of way may be obtained for treatments if the need is identified early. Retention/detention ponds and other wetlands can be attractive if well designed and placed in a location where they can be viewed from the roadway.

Community Aesthetic Features placed in the right of way to represent the community are discussed in **Section 9.3** of this Volume.

Vistas of exceptional beauty should be accentuated by the roadway geometrics. Ideally, such vistas should be on the outside of horizontal curves, without excessive roadside appurtenances and signs to clutter the view.

"Streetscaping" techniques in urban areas include an emphasis on pedestrian accommodation, trees and other plantings, access control, careful signing, and zoning restrictions on commercial signs. Parkways and other roads specifically intended for pleasing aesthetics should be designed by a multidisciplinary team including landscape architects and planners.

Aesthetics and roadway design considerations and methods are also discussed in the ***Project Development and Environment Manual (Topic No. 650-000-001), Part 2, Chapter 15.***

1.8 Access Management

Unregulated access to the State Highway System was determined to be one of the contributing factors to congestion and functional deterioration of the system. Regulation of access was necessary to preserve the functional integrity of the State Highway System and to promote the safe and efficient movement of people and goods within the state. Under **F.S. 335.18**, the Legislature authorized the Department to develop rules to administer the "State Highway System Access Management Act". These are **Rule 14-96** and **14-97**. In addition, the Department has adopted the ***Median Opening and Access Management Decision Process (Topic No. 625-010-021)***, which further defines the principles and processes for the Department to implement the Access Management Statute and Rules.

Each district has established an Access Management Review Committee to guide actions in access management and median decisions through all the Department's processes, and has assigned various offices the responsibility to permit connections and administer other parts of the program. In order to adhere to the program, the designer must be familiar with the statute, the rules, adopted procedures and directives, and the district program. In addition to driveway connections, features such as median openings affect safe and efficient operation. It is critical that the designer know what access classification has been assigned to the highway segment under design and to determine what roadway features and access connection modifications are appropriate to adhere to the program.

During the PD&E phase, a conceptual access management plan is prepared for the preferred alternative. Access management issues are also addressed in the Preliminary Engineering (P.E.) Report. The designer should review these documents and the existing access management classification for information on access management decisions made during the PD&E process.

During the development of construction plans, the designer should evaluate the access connections within the project limits. Driveways and median openings should be considered in the analysis of safety and operational problems. Modifications or closures to access may be the solution in certain cases. **Rule 14-97.003(3)(b)** gives the Department the authority to alter, relocate or replace connections in order to meet current Department standards. Furthermore, **Rule 14-96.011** allows the FDOT to revoke a permit "...if the connection causes a safety or operational problem on the State Highway System substantiated by an engineering study...".

Rule 14-97 also provides guidance on the treatment of existing features in the highway improvement process:

14-97.003(3)(b)

(b) Existing lawful connections, median openings, and signals are not required to meet the access management standards. Existing access management features will generally be allowed to remain in place, but shall be brought into conformance with access management standards when significant change occurs or as changes to the roadway design allow.

In some cases where revisions are necessary due to operational or safety problems, it may not be possible to totally upgrade a median opening or connection to the newest standards because of existing conditions or constraints. In these cases, the designer should provide the best solution, based on good engineering practice. Early identification of access and median opening location in relation to individual parcels should be completed before the right of way phase. **Median Opening and Access Management Decision Process (Topic No. 625-010-021)** requires the following:

1. Any significant change to driveway access will be shown in plans or the driveway will be replaced in the same location, width and configuration (number of lanes).
2. Access design and impacts to a right of way acquisition parcel should be determined prior to the right of way phase.
3. Changes to access details or decisions must be coordinated with District Right of Way and General Counsel's offices in addition to the Access Management Review Committee.

Every owner of property that abuts a road on the State Highway System has a right to reasonable access to the abutting state highway but does not have a right to unregulated access to such highway. A means of reasonable access cannot be denied except on the basis of safety and operational concerns as provided in **Section 335.184, Florida Statutes**. Nothing in **Section 335.184** limits the Department's authority to restrict the operational characteristics of a particular means of access. Service roads provide reasonable access.

It should be noted that if there are any conflicts between these guidelines and the statute and rules, the statute and rules will govern.

Modification for Non-Conventional Projects:
See RFP for special requirements.

FLORIDA DOT ACCESS MANAGEMENT GUIDELINES RULE 14-97

Table 1.8.1 Freeway Interchange Spacing

Access Class	Area Type	Segment Location	Interchange Spacing (miles)
1	Area Type 1	CBD & CBD Fringe For Cities In Urbanized Areas	1.0
	Area Type 2	Existing Urbanized Areas Other Than Area Type 1	2.0
	Area Type 3	Transitioning Urbanized Areas And Urban Areas Other Than Area Type 1 or 2	3.0
	Area Type 4	Rural Areas	6.0

Table 1.8.2 Arterial Access Management Classifications & Standards

Access Class	Medians "Restrictive" physically prevent vehicle crossing. "Non-Restrictive" allow turns across at any point.	Connection Spacing (feet)		Median Opening Spacing (feet)		Signal Spacing (feet)
		>45 mph	≤45 mph	Directional	Full	
2	Restrictive with Service Roads	1320	660	1320	2640	2640
3	Restrictive	660	440	1320	2640	2640
4	Non-Restrictive	660	440			2640
5	Restrictive	440	245	660	*2640/ 1320	*2640/1320
6	Non-Restrictive	440	245			1320
7	Both Median Types	125		330	660	1320

* 2640 feet for >45 mph; 1320 feet for ≤45 mph

Table 1.8.3 Interim Access Management Standards

Posted Speed (mph)	Connection Spacing (feet)	Median Opening Spacing (feet)		Signal Spacing (feet)
		Directional	Full	
35 mph or less	245	660	1320	1320
36 - 45 mph	440	660	1320	1320
Over 45 mph	660	1320	2640	1320

1.9 Design Speed

Design speed is a principal design control that regulates the selection of many of the project standards and criteria used to design a roadway project. Many factors are considered during the selection of design speed. The AASHTO publication, ***A Policy on Geometric Design of Highways and Streets***, has a thorough discussion on design speed and these factors.

1.9.1 Design Speed Coordination and Approvals

As a principal design control, design speed is selected very early in the design process and must be documented in the project design file. The Engineer of Record must coordinate with the District Design Engineer (DDE), the District Traffic Operations Engineer (DTOE), and the responsible PD&E engineer to discuss the anticipated posted speed. Every effort should be made to **use as high a design speed as practical** to attain a desired degree of safety, mobility and efficiency. However, the design speed cannot be less than the project's proposed posted speed (existing posted speed if no change is proposed) or legal speed limit. On new construction and reconstruction projects, designers cannot include in their plans a posted speed higher than the design speed.

The District Design Engineer and the District Traffic Operations Engineer jointly approve the selected design speed with a declaration that the expected posted speed will not exceed the selected design speed. This is to be documented on the Typical Section Package as described in **Section 16.2.3** of this Volume. When agreement between the DDE and DTOE on the Design Speed cannot be reached, the DDE and DTOE will forward the matter to the District Director of Transportation Development and District Director of Transportation Operations for final resolution. In some cases it may be appropriate to select a higher design speed to match an expected posted speed and process a Design Exception or Design Variation for each design element that does not meet the criteria for the higher speed.

The modification of posted speed limits after the construction of a project has been completed is a decision made under the authority of the District Traffic Operations Engineer (***FDOT Procedure No. 750-010-011***). This is based on the 85th percentile speed determined through engineering and traffic investigations described in ***Speed Zoning for Highways, Roads and Streets in Florida, (FDOT Procedure No. 750-010-002)***. The DTOE typically conducts a speed investigation within one year after a new construction or reconstruction project is completed. When it is determined from this

speed study that a posted speed higher than the original design speed is warranted, the DTOE, working with the DDE, must process either a Design Exception or Design Variation for each design element that does not meet the criteria for the higher speed. When agreement between the DDE and DTOE cannot be reached, the DDE and DTOE will forward the matter to the District Director of Transportation Development and District Director of Transportation Operations for final resolution. Further explanation on how posted speed limits are developed can also be found on the State Traffic Operations web page:

<http://www.dot.state.fl.us/trafficoperations/FAQs/SpeedLimitFAQ.shtm>

While the selected design speed will establish minimum geometric requirements (e.g., minimum horizontal curve radius and sight distance), this does not preclude the use of improved geometry (flatter curves or greater sight distances) where such improvements can be provided as a part of economic design. The Engineer of Record is required to document, in a design speed matrix, any design features that were designed to speeds other than the project design speed. Increments of 5 mph should be used when selecting design speeds.

Table 1.9.1 provides a recommended range of design speeds for new construction and reconstruction projects on the State Highway System except for facilities on the Strategic Intermodal System (SIS). **Table 1.9.2** contains the minimum values for design speed for facilities on the SIS (including SIS Highway Corridors, Emerging SIS Highway Corridors, SIS Highway Intermodal Connectors and Emerging SIS Highway Intermodal Connectors).

For design speed on RRR projects on the State Highway System, see **Chapter 25** of this Volume. **Chapter 25** may also be used for RRR projects on SIS facilities, however, the minimum design speeds in **Table 1.9.2** are preferred, and should be selected with consideration for the proposed improvements defined for the facility in the **Corridor Management Plan**.

**Table 1.9.1 Design Speed
 State Highway System - Non-SIS Facilities**

Facility		Design Speed (mph)
Freeways	Rural	70
	Urban	50 - 70
Arterials	Rural	55 - 70
	Urban	40 - 60
Collectors	Rural	55 - 65
	Urban	35 - 50
TDLC		30 - 40

Table 1.9.2 Minimum Design Speed SIS

Area Type*	Existing or Emerging SIS Highway Corridor		SIS Highway Intermodal Connector or SIS Military Access Connector	
	Access Class 1	Access Class 2 or 3	On SHS	Off SHS
Rural	70	65	45	45
Urban	70	50**	45	45
Urbanized	60	50**	45	45

* Terms based on definitions contained in **SIS Procedure (Topic No. 525-030-260)**.

** For curb and gutter facilities where existing posted speed is 45mph or less and Access Management Class 3 is proposed, a design speed of 45mph may be used.

Note: For SIS facilities (including SIS Highway Corridors and Emerging SIS Highway Corridors), design speeds less than the above minimums must be submitted to the Director, Office of Design and approved by the Chief Engineer, following a review by the State Transportation Development Administrator, in accordance with the **SIS Procedure (Topic No. 525-030-260)**.

For SIS and Emerging SIS Highway Intermodal Connectors not on the State Highway System, design speeds less than the above outlined minimums must be approved by the District Design Engineer, following a review by the District Planning (Intermodal Systems Development) Manager in accordance with the **SIS Highway Component Standards & Criteria (Topic No. 525-030-260)**. Refer to **Chapter 2** of this Volume for design criteria.

Modification for Non-Conventional Projects:
Delete PPM 1.9 and see RFP for design speed.

1.10 Public Involvement

It is the policy (**Topic No. 000-525-050, Public Involvement Opportunities**) of the FDOT to promote public involvement opportunities and information exchange activities in all functional areas using various techniques adapted to local area conditions and project requirements.

Typically, when a project reaches the design phase, many of the project commitments and community issues have already been identified. However, this is not always true. Design alternatives still need to be reevaluated to determine their implications in relation

to community impacts. Any commitments made in previous phases would be communicated to designers, who will be responsible for carrying them out. If constraints arise that require design changes which affect the Department's ability to meet commitments, then the process would require follow-up with the affected community. In such cases, additional public involvement and community impact assessment may be necessary to address public concerns.

Projects may have potential community impacts that are not identified until the design phase, such as, but not limited to:

1. Impacts on public safety, including people with disabilities
2. School crossings or other areas of high pedestrian activity
3. Aesthetic features such as landscaping or tree replacement
4. Medians or access changes
5. Intersections and driveways
6. Audible signalized intersections
7. Accessibility of corridor businesses and neighborhoods
8. Wider sidewalks or improved bicycle facilities
9. Lighting
10. Transit
11. Transportation Design for Livable Communities
12. Maintenance of Traffic
13. Railroad crossings
14. Location and extent of storm water management facilities

Each district has developed Community Awareness Plan (CAP) guidelines to be implemented on all design projects for continued efforts in public involvement depending on the level of impact to the community.

Modification for Non-Conventional Projects:

See RFP for commitments and special CAP requirements.

1.11 Context Sensitive Solutions in Design

In order to plan, design, construct, maintain and operate the State Transportation System, “Context Sensitive Solutions” should be considered in all projects, not only TDLC projects. This design philosophy seeks transportation solutions that improve mobility and safety while complementing and enhancing community values and objectives. Context sensitive solutions are reached through joint effort involving all stakeholders.

It is recognized that the Department is expected to provide mobility and a quality of life that includes the protection of the natural resources and the cultural and social values of their community, issues such as funding, maintenance, traffic demand, impact on alternate routes, impact on safety and laws, and rules and regulations must be addressed early with key stakeholders.

Context sensitive solutions can be achieved without necessarily reducing criteria. The ability to develop a context sensitive solution requires an understanding of the operational effects of highway geometry. Designers have the challenging task of combining community desires with good highway design practice (design criteria and guidelines) to produce workable, acceptable solutions.

Modification for Non-Conventional Projects:

See RFP for special requirements.

1.12 Design Vehicle

One of the primary design controls for geometric highway design is based on the physical characteristics of vehicles that will utilize the facility. The controlling vehicle for design is called the design vehicle. **AASHTO’s A Policy on Geometric Design of Highways and Streets** provides some general guidance on the selection of a design vehicle. **AASHTO** also provides the dimensions and turning characteristics for a variety of standard design vehicles (P, SU, WB-40, WB-62, etc.).

Studies have shown that the WB-50 is no longer a majority in the truck population on Florida’s highways. The **Florida Statutes** allow truck-trailer combinations that are similar to the AASHTO WB-62 Interstate Semitrailer with some slight modifications. This modified WB-62 design vehicle used in Florida is defined here as the Florida

Interstate Semitrailer (WB-62FL). The WB-62FL is more representative of the truck population on Florida's highways than the WB-50. Therefore, the WB-62FL design vehicle should now be used in situations that previously called for a WB-50. In addition, the Florida's Turnpike and other truck routes allow tandem tractor trailers, so the AASHTO WB-109D should be used as the design vehicle for tandem truck routes.

When designing for a WB-62FL at intersections, the design elements (control radii, return radii, etc.) can be based on the criteria tables and figures in **AASHTO** for a WB-62. In addition, when designing features for complex or constrained intersections (roundabouts, multi-lane turns, directional median openings, ramps, etc.) the geometric design elements should be checked against the turning movement of a WB-62FL. The WB-62FL is described in **Figure 1.12.1**.

Figure 1.12.1 Florida Interstate Semitrailer (WB-62FL)

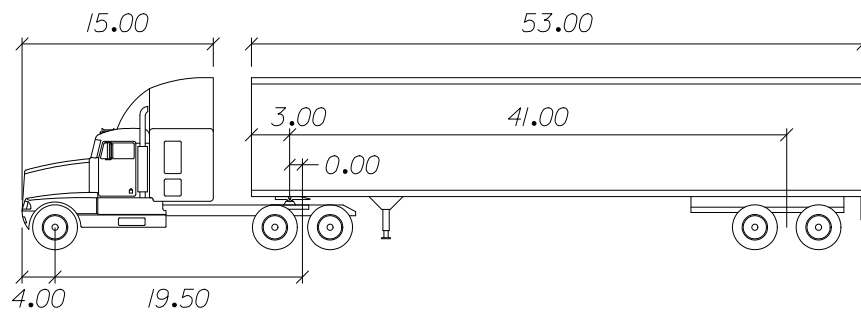

<i>WB-62FL</i>		<i>feet</i>
<i>Tractor Width :</i>	8.00	<i>Lock to Lock Time:</i> 6.00 seconds
<i>Trailer Width :</i>	8.50	<i>Steering Angle :</i> 28.40 degrees
<i>Tractor Track :</i>	8.00	<i>Articulating Angle:</i> 70.00 degrees
<i>Trailer Track :</i>	8.50	

Modification for Non-Conventional Projects:

See RFP for design vehicle requirements.

Chapter 2

Design Geometrics and Criteria

2.0	General	2-1
2.0.1	Railroad-Highway Grade Crossing Near or Within Project Limits	2-3
2.1	Lanes	2-4
2.1.1	Travel Lanes and Auxiliary Lanes.....	2-4
2.1.2	Other Lane Widths	2-5
2.1.3	Ramp Traveled Way Widths	2-6
2.1.4	Pedestrian, Bicycle and Public Transit Facilities.....	2-6
2.1.4.1	Pedestrian Facilities	2-6
2.1.4.2	Bicycle Facilities	2-7
2.1.4.3	Public Transit Facilities.....	2-7
2.1.5	Cross Slopes.....	2-7
2.1.5.1	Hydroplaning Risk Analysis	2-8
2.1.6	Roadway Pavement	2-11
2.1.6.1	Alternative Roadway Paving Treatments.....	2-11
2.1.6.2	Maintenance Memorandum of Agreement Requirements for Patterned Pavement.....	2-13
2.1.7	Transitions of Pavement Widths	2-15
2.1.8	Number of Lanes on the State Highway System	2-15
2.2	Medians	2-16
2.2.1	Median Width for Roadways.....	2-16
2.2.2	Median Policy for Multilane Facilities.....	2-17
2.2.3	Median Treatments on Bridges	2-17

2.3	Shoulders	2-18
2.3.1	Limits of Friction Course on Paved Shoulders	2-26
2.3.2	Shoulder Warning Devices (Rumble Strips)	2-26
2.3.3	Use of Curb	2-27
2.4	Roadside Slopes	2-27
2.5	Borders	2-27
2.5.1	Limited Access Facilities	2-30
2.6	Grades	2-31
2.7	Sight Distance	2-34
2.8	Curves	2-37
2.8.1	Horizontal Curves.....	2-37
2.8.1.1	Supplemental Alignment Control (Mainline)	2-37
2.8.1.2	Supplemental Alignment Control (Intersections)	2-41
2.8.1.3	Roadway Transitions.....	2-41
2.8.2	Vertical Curves.....	2-42
2.9	Superelevation	2-44
2.10	Vertical Clearance.....	2-50
2.10.1	Vertical Clearance Over Water.....	2-58
2.10.2	Horizontal Waterway Clearance	2-59
2.10.3	Regulatory Agency Requirements	2-59
2.10.4	Airspace Obstructions	2-60
2.11	Bridge Sections	2-62
2.12	Bridge Railings and Separators.....	2-67

2.13	Intersections.....	2-67
2.13.1	Roundabouts.....	2-67
2.13.1.1	Truck Apron.....	2-68
2.13.1.2	Lighting	2-69
2.13.1.3	Landscaping.....	2-69
2.13.1.4	Pavement Markings.....	2-69
2.13.2	Queue Length for Unsignalized Intersections	2-70
2.13.3	Offset Left Turn Lanes.....	2-70
2.14	Interchanges and Median Openings/Crossovers.....	2-72
2.14.1	Limited Access Right of Way Limits at Interchanges	2-72
2.14.2	Median Openings at Interchanges.....	2-74
2.14.3	Ramp Widths.....	2-75
2.14.4	Crossovers on Limited Access Facilities	2-76
2.15	Lighting Criteria	2-82
2.16	High-Speed Urban and Suburban Arterial Highways.....	2-82
2.16.1	Design Speed.....	2-83
2.16.2	Curbs	2-83
2.16.3	Pedestrian and Bicycle Facilities	2-83
2.16.4	Medians	2-83
2.16.5	Shoulders.....	2-84
2.16.6	Friction Course.....	2-84
2.16.7	Border Width	2-85
2.16.8	Grades	2-85
2.16.9	Horizontal Curves.....	2-85
2.16.10	Superelevation	2-86
2.16.11	Lateral Offset.....	2-86

Tables

Table 2.1.1	Lane Widths	2-4
Table 2.1.2	Lane Widths - Special.....	2-5
Table 2.1.3	Ramp Widths	2-6
Table 2.1.4	Maximum Algebraic Difference in Cross Slope at Turning Roadway Terminals.....	2-10
Table 2.2.1	Median Widths	2-16
Table 2.3.1	Shoulder Widths and Cross Slopes - Freeways	2-19
Table 2.3.2	Shoulder Widths and Cross Slopes - Arterials Divided	2-20
Table 2.3.3	Shoulder Widths and Cross Slopes - Arterials Undivided	2-21
Table 2.3.4	Shoulder Widths and Cross Slopes – Collectors Divided and Undivided.....	2-22
Table 2.5.1	Highways with Flush Shoulders.....	2-28
Table 2.5.2	Highways with Curb or Curb and Gutter in Urban Areas	2-29
Table 2.5.3	Limited Access Facilities	2-30
Table 2.6.1	Maximum Grades.....	2-32
Table 2.6.2	Maximum Change in Grade Without Vertical Curves.....	2-32
Table 2.6.3	Criteria for Grade Datum	2-33
Table 2.6.4	Grade Criteria for Curb and Gutter Sections.....	2-33
Table 2.7.1	Minimum Stopping Sight Distance.....	2-35
Table 2.7.2	Minimum Passing Sight Distance	2-36
Table 2.8.1a	Maximum Deflections without Horizontal Curves.....	2-39
Table 2.8.1b	Maximum Deflection for Through Lanes through Intersections.....	2-39
Table 2.8.2a	Length of Horizontal Curves	2-40
Table 2.8.2b	Arc Length (in feet) of Compound Curves with One-Half/Double Radii - Turning Roadways.....	2-40

Table 2.8.3	Maximum Curvature of Horizontal Curve (Using Limiting Values of "e" and "f").....	2-40
Table 2.8.4	Maximum Horizontal Curvature Using Normal Cross Slopes (-0.02)	2-41
Table 2.8.5	Minimum Lengths of Crest Vertical Curves Based on Stopping Sight Distance	2-42
Table 2.8.6	Minimum Lengths of Sag Vertical Curves Based on Stopping Sight Distance and Headlight Sight Distance	2-43
Table 2.9.1	Superelevation Rates for Rural Highways, Urban Freeways and High Speed Urban Highways ($e_{max} = 0.10$)	2-45
Table 2.9.2	Superelevation Rates for Urban Highways and High Speed Urban Streets ($e_{max} = 0.05$)	2-47
Table 2.9.3	Superelevation Transition Slope Rates for Rural Highways, Urban Freeways and High Speed Urban Highways	2-49
Table 2.9.4	Superelevation Transition Slope Rates for Urban Highways and High Speed Urban Streets	2-49
Table 2.10.1	Minimum Vertical Clearances for New Bridges.....	2-57
Table 2.10.2	Minimum Vertical Clearances for New Sign and Signal Structures	2-57
Table 2.10.3	FAA Notification Requirements	2-61
Table 2.14.1	Ramp Widths - Turning Roadways	2-75

Figures

Figure 2.1.1	Standard Pavement Cross Slopes.....	2-9
Figure 2.3.1.A	Shoulder Superelevation.....	2-23
Figure 2.3.1.B	Special Shoulder Superelevation.....	2-24
Figure 2.3.2	Typical Paving Under Bridge	2-25
Figure 2.9.1	Superelevation Rate For Rural Highways, Urban Freeways and High Speed Urban Highways ($e_{max} = 0.10$).....	2-46
Figure 2.9.2	Superelevation Rates for Urban Highways and High Speed Urban Streets ($e_{max} = 0.05$)	2-48
Figure 2.10.1	Clearances – Rural and Urban Interstates (Freeways), Arterials and Collectors, with Projected 20-Year ADT of 1500 or Greater	2-51
Figure 2.10.2	Clearances – Rural Arterials and Collectors with Projected 20-Year ADT of Less than 1500	2-52
Figure 2.10.3	Clearances – Urban Arterials and Collectors (Without Curb and Gutter) with Projected 20-Year ADT of Less than 1500	2-53
Figure 2.10.4.A	Clearances – Urban Arterials and Collectors (Curb and Gutter) ≤ 45 mph – Elevation of Bridge....	2-54
Figure 2.10.4.B	Clearances – Urban Arterials and Collectors (Curb and Gutter) ≤ 45 mph – Section through Bridge	2-55
Figure 2.10.5	Clearances – Urban Arterials and Collectors (Curb and Gutter) with Traffic Barrier.....	2-56
Figure 2.11.1	Partial Bridge Sections *	2-63
Figure 2.11.2	Bridge Section *	2-64
Figure 2.11.3	Partial Bridge Sections *	2-65
Figure 2.11.4	Bridge Section *	2-66
Figure 2.13.1	Standard Truck Apron Design.....	2-68
Figure 2.13.2	Roundabout Approach Arrow.....	2-69
Figure 2.13.3	Typical Opposing Left Turns (22' Median with Negative 10' Offset).....	2-70

Figure 2.13.4	Typical Opposing Left Turns (22' Median with Negative 1' Offset).....	2-71
Figure 2.13.5	Left Turn Offset Guidelines	2-72
Figure 2.14.1	Crossovers on Limited Access Facilities – 6 or More Lanes	2-79
Figure 2.14.2	Crossovers on Limited Access Facilities – 4 Lanes	2-80
Figure 2.14.3	Median Barrier Opening for Crossovers on Limited Access Facilities	2-81
Figure 2.16.3	Superelevation Rates for High-Speed Urban and Suburban Sections.....	2-86

THIS PAGE LEFT BLANK INTENTIONALLY

Chapter 2

Design Geometrics and Criteria

2.0 General

The implementation of design criteria is outlined in the following text.

1. **Design Criteria:** The design criteria presented in this manual are intended as the principal source of criteria for the design of new construction or major reconstruction projects on the Florida State Highway System.

These criteria are presented by subject for major design elements as fixed values or a range of acceptable values as defined by qualifiers.

Where design criteria appear in the [Design Standards](#), they will be consistent with the criteria in this manual. In addition, some criteria will remain in the other chapters of this manual. When conflicts are discovered, they should be brought to the attention of the State Roadway Design Engineer or State Structures Design Engineer, as applicable, for resolution.

Modification for Non-Conventional Projects:

Delete the last sentence of the above paragraph and replace with the following:
Where conflicts exist, the EOR must select the criteria proven to result in better safety performance.

On reconstruction projects, existing project features which were constructed to meet minimum metric design criteria, but are mathematically slightly less than equivalent minimum English design criteria, do not require Design Exceptions or Design Variations to remain.

Design criteria for Resurfacing, Restoration, and Rehabilitation (RRR) are presented in **Chapter 25** of this Volume and are applicable only on programmed RRR projects.

Modification for Non-Conventional Projects:

Delete the sentence above and see RFP for requirements.

Facilities on the Strategic Intermodal System (SIS) are subject to special standards and criteria for number of lanes, design speed, access, level of service and other requirements.

Design SIS and Emerging SIS Highway Intermodal Connectors on the State Highway System (SHS) in accordance with the SIS criteria contained in this manual. SIS and Emerging SIS Highway Intermodal Connectors on the local system (non-SHS) should also be designed in accordance with the SIS criteria contained in this manual, but the District may allow the use of the **Manual of Uniform Minimum Standards for Design, Construction and Maintenance for Streets and Highways** (commonly known as the "[Florida Greenbook](#)"), **Topic No. 625-000-015** depending on project specifics, with approval by the District Design Engineer.

Modification for Non-Conventional Projects:

Delete the last sentence of the above paragraph and see RFP for requirements.

Design Criteria for roads that are not part of the State Highway System should be obtained from the **Florida Greenbook**.

Modification for Non-Conventional Projects:

Delete the last sentence.

2. **Design Controls:** Design controls are characteristics and conditions that influence or regulate the selection of the criteria for project standards. It is the designer's responsibility to recognize and apply those controls applicable to the project.
3. **Design Standards:** The specific values selected from the design criteria become the design standards for a design project. These standards will be identified and documented by the designer.
4. **Project Parameters:** The properties or specific conditions with limits which require modification of design standards within these limits. The designer is responsible for establishing and documenting any project parameters and their limits, as part of the justification for deviations from project standards.

Modification for Non-Conventional Projects:

Delete the last sentence of the above paragraph.

Many design standard considerations are related directly to the design speed, including vertical and horizontal geometry and required sight distances. The minimum design values are very closely related to traffic safety and cannot be compromised without an approved Design Exception or Design Variation. See **Chapter 23** of this Volume.

Public facilities constructed or funded by FDOT (e.g., parking garages, weigh stations, operation centers, park & ride facilities) must comply with the criteria in this manual, FDOT [Design Standards](#), and other applicable Department manuals. Roads not on the State Highway System which are impacted by the construction of these public facilities should also be designed in accordance with Department criteria and standards, but the District may allow the use of the [Florida Greenbook](#) depending on project specifics.

Modification for Non-Conventional Projects:

Delete the last sentence of the above paragraph.

Roadway and bridge typical sections developed for projects are required to reflect the values and properties outlined in Items 1 - 4 of this section. Include the location and limits of such features as lanes, medians, shoulders, curbs, sidewalks, barriers, and railings on these typical sections. **Section 16.2.3** of this Volume gives the requirements for approval and concurrence of typical section packages.

Coordination is of primary importance on projects that contain both roadway and bridge typical sections. An integrated design and review process for the project to address the compatibility of the typical section features mentioned above will be completed by the Roadway and Structures Offices.

Example roadway typical sections are included in the exhibits in **Chapter 6** of **Volume 2**. Criteria regarding lanes, medians, and shoulders for bridges is located in **Section 2.11**. Subsequent sections of this chapter contain specific information and criteria regarding these and other typical section elements, as well as geometric features of both roadways and bridges.

2.0.1 Railroad-Highway Grade Crossing Near or Within Project Limits

Review of federal-aid projects is required to determine if a railroad-highway at-grade crossing is in or near the limits of the project. If such crossing exists, the project will be upgraded in accordance with **Section 6.2.4** of this Volume.

2.1 Lanes

Florida Department of Transportation (FDOT) criteria for lane widths and pavement slopes are given by highway type and area, through lanes, auxiliary lanes and other special lanes.

2.1.1 Travel Lanes and Auxiliary Lanes

Standard practice is to provide lane widths that are consistent with AASHTO Guidelines. See **Table 2.1.1**. Auxiliary lanes for speed change, turning and storage, and other purposes supplementary to through-traffic movement should be of the same width as the through lanes.

Table 2.1.1 Lane Widths

LANE WIDTHS (FEET)					
FACILITY		TRAVEL LANES	AUXILIARY LANES		
TYPE	AREA		SPEED CHANGE	TURNING (LT/RT/MED)	PASSING
FREEWAY	Rural	12	12	----	----
	Urban	12	12	----	----
ARTERIAL	Rural	12 ₆	12 ₆	12 ₆	12 ₆
	Urban	11 ₁	11 ₁	11 _{1,3}	11 ₁
COLLECTOR	Rural	12 _{5,6}	11 ₂	11 _{2,3}	11 _{2,4}
	Urban	11	11	11 ₃	11

1. 12 ft. for Design Speeds > 45 mph and for all undivided roadways
2. 12 ft. for 2-lane roadways
3. With severe R/W controls, 10 ft. turning lanes may be used where design speeds are 40 mph or less and the intersection is controlled by traffic signals. Median turn lanes must not exceed 15 ft.
4. 12 ft. when truck volume exceeds 10%.
5. 11 ft. for low volume AADT.
6. 11 ft. for divided roadways with Design Speeds ≤ 45 mph and within one mile of an urban area.

Modification for Non-Conventional Projects:

Delete footnote 3 in **PPM Table 2.1.1** above and see RFP for requirements.

2.1.2 Other Lane Widths

Lane widths for special lanes are given in **Table 2.1.2**.

Table 2.1.2 Lane Widths - Special

LANE WIDTHS (FEET)					
FACILITY		SPECIAL			
TYPE	AREA	EXPRESS/ HOV ₁	BICYCLE	OFF SYSTEM DETOUR	URBAN MULTI- PURPOSE ₃
FREEWAY	Rural	12	----	11 ₂	----
	Urban	12	----	11 ₂	----
ARTERIAL	Rural	12	5 ₅	11	----
	Urban	12	7 ₅	11	8 ₄
COLLECTOR	Rural	----	5 ₅	11	----
	Urban	----	7 ₅	11	8 ₄

1. Separated or concurrent flow.
2. For Freeway detours, provide at least one 12 ft. lane in each direction.
3. Urban multi-purpose lanes are generally used as refuge lanes but may be used for loading zones, bus stops, emergency access and other purposes. Parking that adversely impacts capacity or safety is to be eliminated whenever practical. Standard parking width is measured from face of curb, with a minimum width of 8 ft.
4. 10 ft. to 12 ft. lanes for commercial and transit vehicles.
5. If in or within one mile of an urban area, see Chapter 8 of this volume.

Modification for Non-Conventional Projects:

Delete the second sentence in footnote 3 and delete footnote 4 in **PPM Table 2.1.2** above and see RFP for requirements.

2.1.3 Ramp Traveled Way Widths

Ramp widths for tangent and large radii (500 ft. or greater) sections are given in **Table 2.1.3**. Ramp widths in other areas such as terminals are controlled by the curvature and the vehicle type selected as the design control and are given in **Table 2.14.1, Ramp Widths**. Typical details for ramp terminals are provided in the [Design Standards](#).

Table 2.1.3 Ramp Widths

RAMP WIDTHS (RAMP PROPER) FOR TANGENT AND LARGE RADII (≥ 500 ft.) SECTIONS	
ONE LANE RAMPS	15 ft.
TWO LANE RAMPS	24 ft.

For ramp widths at turning roadways see **Table 2.14.1**.

2.1.4 Pedestrian, Bicycle and Public Transit Facilities

2.1.4.1 Pedestrian Facilities

Consider sidewalks and pedestrian crossings on all projects. Although the standard sidewalk width is 5 feet, it may be desirable to create wider sidewalks in business districts, near schools, transit stops, or where there are other significant pedestrian attractors. Consult the District Pedestrian/Bicycle Coordinator during planning and design to establish appropriate pedestrian elements on a project-by-project basis. **Chapter 8** of this volume contains additional criteria for the accommodation of pedestrians.

Modification for Non-Conventional Projects:

Delete the above paragraph and replace with:

The standard sidewalk width is 5 feet. **Chapter 8** of this volume contains additional criteria for the accommodation of pedestrians.

2.1.4.2 Bicycle Facilities

Provide bicycle facilities as required by **Chapter 8** of this volume. Bicycle lanes on the approaches to bridges should be continued across the structure. Consult with the District Pedestrian/Bicycle Coordinator during planning and design to establish appropriate bicycle facility elements on a project-by-project basis. **Chapter 8** of this volume contains additional criteria for the accommodation of bicyclists.

Modification for Non-Conventional Projects:

Delete third sentence in above paragraph and see RFP for requirements.

2.1.4.3 Public Transit Facilities

Coordinate with the District Modal Development Office and local transit agency for the need for public transit facilities. **Chapter 8** of this volume contains additional guidelines for street side bus stop facilities, location and design.

Modification for Non-Conventional Projects:

Delete first sentence in above paragraph and see RFP for requirements.

2.1.5 Cross Slopes

For roadways, the maximum number of travel lanes with cross slope in one direction is three lanes except as shown in **Figure 2.1.1**, which prescribes standard pavement cross slopes. The maximum algebraic difference in cross slope between adjacent through lanes is 0.04. The maximum algebraic difference in cross slope between a through lane and an auxiliary lane at a turning roadway terminal is given in **Table 2.1.4**. **Chapter 4** on **Roadside Safety** and **Chapter 8** on **Pedestrian, Bicycle and Public Transit Facilities** (this volume) contain additional procedures and guidelines on slope design.

Cross slopes on bridges must be on a uniform, straight-line rate, typically 0.02, in each traffic direction, with no break in slope. The straight-line slope must be applied uniformly over all travel lanes and required shoulders in each direction of travel. Bridges with one-way traffic must have one, uniform cross slope, while bridges with two-way traffic may be designed with a crowned bridge deck section.

This cross slope criteria applies to all bridge decks whether of cast-in-place concrete, precast concrete, or open steel decking.

Use transitions to adjust for differences in cross slope between the approach roadway section and the required straight-line slope for bridge decks. Whenever possible the transition should be accomplished on the roadway section, outside the limits of the bridge and approach slabs. This will require detailing of the transition(s) in the roadway plans. Coordination between the Roadway, Drainage and Structures designers in the development of transitions is required to ensure compatibility and harmonizing at bridge approaches.

2.1.5.1 Hydroplaning Risk Analysis

A Design Variation is required when pavement cross slope does not meet the requirements shown in **Figure 2.1.1**. The hydroplaning risk analysis predicts the water film thickness on the pavement being analyzed and the speed at which hydroplaning may occur. This information may be used to provide justification for utilizing a non-compliant typical section when weighed against the cost of correcting pavement cross slope. Coordinate with the District Drainage Engineer to determine whether a hydroplaning analysis is needed.

When a hydroplaning risk analysis is performed, use the HP Program and the Design Guidance: Hydroplaning Risk Analysis. The Hydroplaning Tools can be downloaded under Design Aids at:

<http://www.dot.state.fl.us/rddesign/Drainage/ManualsandHandbooks.shtm>

Figure 2.1.1 Standard Pavement Cross Slopes

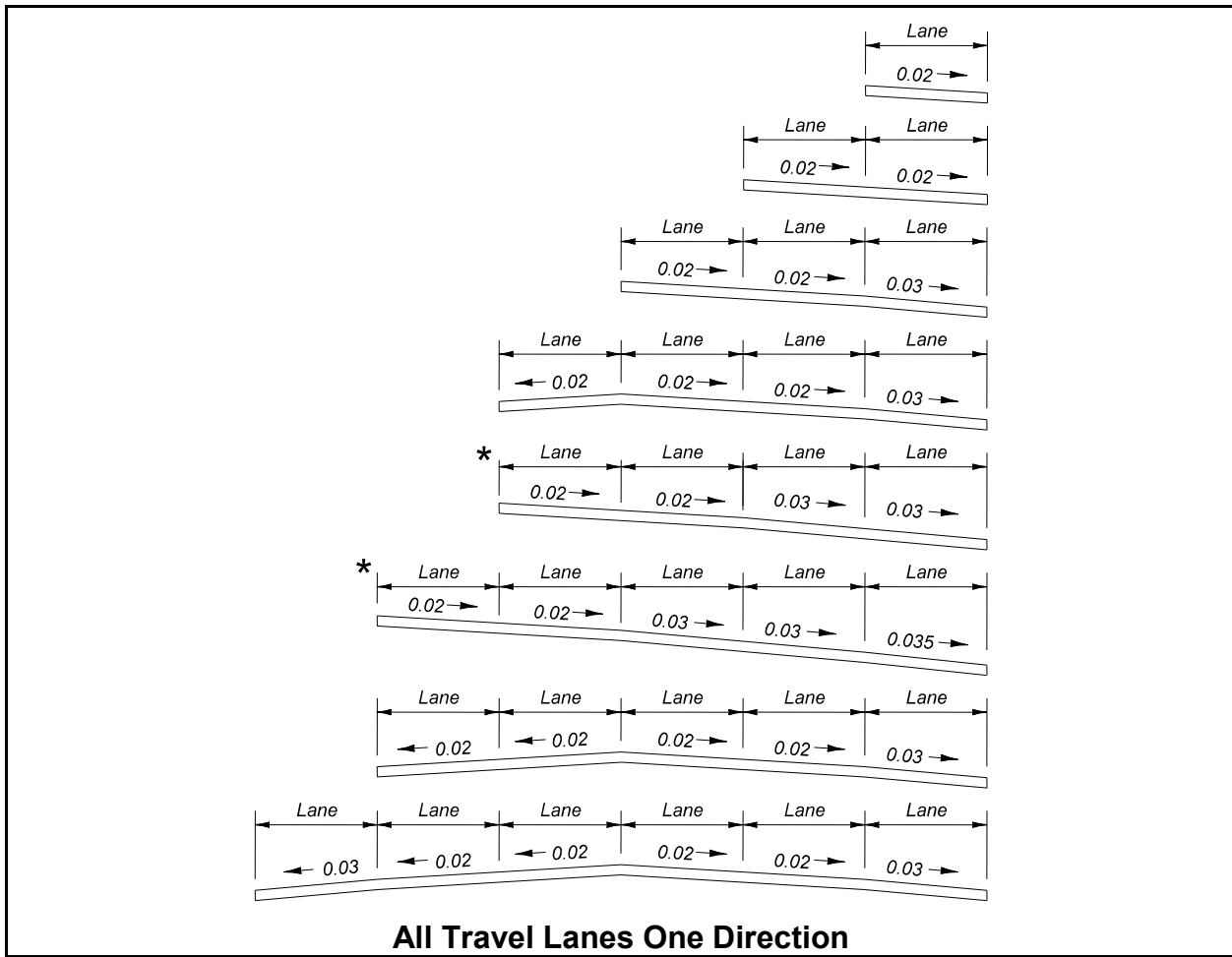

These sections show only the standard slopes for adjoining travel lanes; they do not prescribe needed lanes, lane usage or typical section requirements other than lane slope. These slopes are not applicable to parabolic crowns.

Maximum pavement cross slopes on tangent sections is 0.04.

The maximum change in cross slope between adjacent through lanes is 0.04.

Slopes on multi-purpose lanes may be 0.03 to 0.05. Portions of multi-purpose lanes that are reserved for parking and access aisles for the physically disabled must have cross slopes not exceeding 1:50 (0.02) in all directions.

*NOTE: For Design Speeds \leq 65mph, a longitudinal slope that does not exceed 5% is acceptable on these sections.

The remaining sections are applicable for all design speeds.

Table 2.1.4 Maximum Algebraic Difference in Cross Slope at Turning Roadway Terminals

Design Speed of Exit or Entrance Curve (mph)	Maximum Algebraic Difference in Cross Slope at Crossover Line (%)
Less than 35	6.0
35 and over	5.0

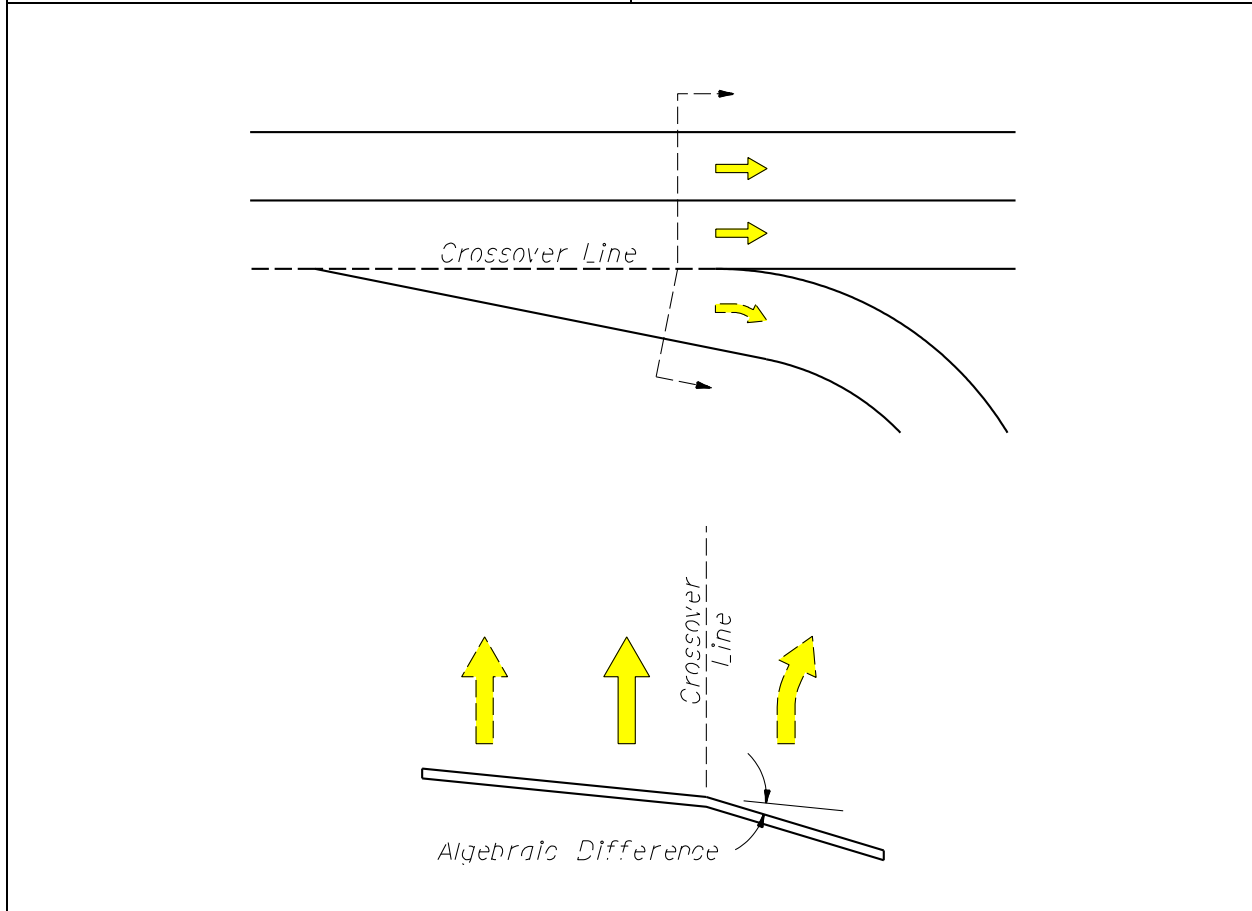

2.1.6 Roadway Pavement

The type of pavement usually is determined by analysis of the volume and composition of traffic, the soil conditions, the availability of materials, the initial cost and the estimated cost of maintenance.

Criteria and procedures for selecting the type of pavement and the structural design of the various surfacing courses are discussed in the Department's pavement design manuals.

2.1.6.1 Alternative Roadway Paving Treatments

Alternative paving treatments, such as patterned pavement and architectural pavers meeting **FDOT Specifications**, may be used for enhancing aesthetics and appearance when requested by a local community, and when the conditions and restrictions provided in this section are met. Patterned pavement treatments are covered under **Section 523** of the **FDOT Specifications** and are surface markings applied either as an overlay to the pavement surface or imprinted in the pavement surface. Architectural pavers are covered under **Section 526** of the **FDOT Specifications** and consist of brick pavers or concrete pavers placed on specially prepared bedding material.

These alternative pavement treatments are purely aesthetic treatments and are not considered to be traffic control devices. Use of either of these treatments is highly restricted as stated below. Even when all conditions and restrictions are met, any decision to use these treatments should consider that there may be potential adverse impacts to the traveling public as well as potential long term maintenance problems. Architectural pavers have been found to create significant ride-ability problems even on low speed roadways. Therefore, architectural pavers are prohibited within the traveled way on the State Highway System. Properly installed patterned pavement treatments do not significantly affect ride-ability; however, their use is also restricted since they are not likely to sustain their friction and wear characteristics for the full life of typical roadway pavement.

These paving treatments involve additional construction and maintenance costs not associated with typical roadway pavement. Therefore, obtain the appropriate agreements with the local maintaining agency. The additional funding for construction and assumption of responsibility for regular inspection and maintenance of the pavement treatment are to be provided by the local maintaining agency. In cases where existing alternative pavement is being removed as part of a Department project, replacement of such pavement must adhere to the requirements in this section regardless of the circumstances of the original installation and maintenance. Maintenance agreements for installations within the traveled way on the State Highway System must include the provisions outlined in **Section 2.1.6.2** for the duration of the installation.

The following restrictions apply:

Architectural Pavers:

1. Must not be used on the traveled way of the State Highway System.
2. May be used on local side streets (with a design speed of 35 mph or less), non-traffic medians and islands, curb extensions, sidewalks, borders, and other areas not subject to vehicle traffic.
3. Meet ADA requirements in areas subject to pedestrian traffic. See [Public Rights of Way Accessibility Guidelines \(PROWAG\) R301.5 and R301.7](#) and [Americans with Disabilities Act Accessibility Guidelines \(ADAAG\) 302 and 303](#) for surface requirements.

Patterned Pavement:

1. Use on the traveled way of the State Highway System is restricted to areas within marked pedestrian crosswalks where the design speed is 45 mph or less; however, patterned pavement cannot be used on pedestrian crosswalks across limited access roadway ramps. Use on pedestrian crosswalks with heavy truck traffic turning movements ($\geq 10\%$ trucks) should be avoided.
2. The pavement to which the treatment is applied must be of the same pavement type as, and continuous with, the adjoining pavement. For example, replacing flexible pavement with rigid patterned pavement within the limits of a crosswalk where the abutting pavement is to remain flexible pavement will likely result in pavement joint problems and adverse impacts to rideability. This type treatment is therefore not permitted. Replacing flexible pavement with rigid pavement for an entire intersection including crosswalks may be permitted with a Technical Special Provision submitted to the State Roadway Design Engineer for approval.
3. The initial treatment cannot be applied to any State Highway whose asphalt pavement surface is older than 5 years.
4. May be used in areas not subject to vehicle traffic such as median islands, curb extensions, sidewalks, and landscaping borders.
5. Meet ADA requirements in areas subject to pedestrian traffic. See **PROWAG R301.5 and R301.7** and **ADAAG 302 and 303** for surface requirements.

When architectural pavers are used, identify the location, type, pattern, shape and color in the plans. In addition, identify the project specific details and requirements for edge restraints, bedding material thickness, and base and sub-base materials and thicknesses, as appropriate in the plans, which are to be signed and sealed by a licensed Florida Professional Engineer.

When patterned pavement treatments are used, identify the location, patterned type (brick, stone, etc.), and surface color in the plans. Because local agencies must fund and maintain these treatments, product brands, colors and patterns may be specified in the plans as long as the brand is listed on the APL at the time of use.

Design Variations to any of the requirements in this Section are to be approved by the District Design Engineer.

2.1.6.2 Maintenance Memorandum of Agreement Requirements for Patterned Pavement

Prior to the installation of patterned pavement crosswalks in intersections on the State Highway System, a Maintenance Memorandum of Agreement is required to be entered into with the local government agency requesting this aesthetic enhancement to the project. This agreement is filed with the District Maintenance Office. This Agreement requires the local government agency to acknowledge that the installation and maintenance of patterned pavement is the total responsibility of the local agency, including contracting for friction testing with a qualified firm.

“Maintenance” of all patterned pavement crosswalks in these Agreements is to be defined, as a minimum, to include its frictional characteristics and integrity as follows:

1. Evaluate all lanes of each patterned crosswalk for surface friction within 60 days of project acceptance by the Department. Conduct the friction test using either a locked wheel tester in accordance with **FM 5-592 (Florida Test Method for Friction Measuring Protocol for Patterned Pavements)** or a Dynamic Friction Tester in accordance with **ASTM E1911**. **FM 5-592** can be accessed at the following link:

<http://www.fdot.gov/materials/administration/resources/library/publications/fstm/bynumber.shtm>

The initial friction resistance must be at least 35 obtained at 40 mph with a ribbed tire test (FN40R) or equivalent. Failure to achieve this minimum resistance will require all deficient crosswalk areas to be removed to their full extent (lane-by-lane) and replaced with the same product installed initially. If the Department determines that more than 50% of the lanes in the intersection require replacement, the entire intersection installation may be reconstructed with a different product on the Approved Products List (APL) or replaced with conventional pavement.

2. Approximately one year after project acceptance and every two years thereafter and for the life of the adjacent pavement, only the outside traffic lane areas of each patterned crosswalk must be tested for friction resistance in accordance

- with **ASTM E274** or **ASTM E1911**. Friction resistance must, at a minimum, have a FN40R value of 35 (or equivalent).
3. Send the results of all friction tests to the District's Warranty Coordinator with a cover letter either certifying that the crosswalks comply with the minimum friction criteria, or stating what remedial action will be taken to restore the friction.
 4. Failure to achieve the minimum resistance requires all lanes of the crosswalk to be friction tested to determine the extent of the deficiency. All deficient areas must be removed to their full extent (lane-by-lane) and replaced with the same product installed initially. If the Department determines that more than 50% of the lanes in the intersection require replacement, the entire intersection installation may be reconstructed with a different product on the APL or replaced with conventional pavement.
 5. When remedial action is required in accordance with the above requirements, the local agency must complete all necessary repairs at its own expense within 90 days of the date when the deficiency was identified. No more than two full depth patterned pavement repairs can be made to an area without first resurfacing the underlying pavement to 1" minimum depth.
 6. The Department will not be responsible for replacing the treatment following any construction activities in the vicinity of the treatment.
 7. Should the local agency fail to satisfactorily perform any required remedial work in accordance with this agreement, the Department reserves the right to replace the patterned pavement with conventional pavement (matching the adjacent pavement) and bill the local agency for this cost.

2.1.7 Transitions of Pavement Widths

When new pavement widths are not substantially greater than the joining pavement, grade differentials are slight and future widening is expected, striped transitions may be considered. An alternative approach is an abrupt change in width, with appropriate pavement markings, reflectors and rumble strips. The [Design Standards](#) contain additional criteria and details.

2.1.8 Number of Lanes on the State Highway System

For the number of lanes to be provided on the State Highway System, see **Section 335.02(3)** of the *Florida Statutes*.

Nothing in **s. 335.02(3), F.S.**, precludes a number of lanes in excess of ten lanes. However, before the Department may determine the number of lanes should be more than that, the availability of right of way and the capacity to accommodate other modes of transportation within existing rights of way must be considered.

Exceptions to **s. 335.02(3), F.S.** will be addressed on a case-by-case basis, with final approval resting with the Secretary of Transportation.

2.2 Medians

2.2.1 Median Width for Roadways

Median widths for roadways are given in **Table 2.2.1**.

Table 2.2.1 Median Widths

MEDIAN WIDTHS (FEET)	
TYPE FACILITY	WIDTH
FREEWAYS	
Interstate, Without Barrier	64 ¹
Other Freeways, Without Barrier	---
Design Speed ≥ 60 mph	60
Design Speed < 60 mph	40
All, With Barrier, All Design Speeds	26 ²
ARTERIAL AND COLLECTORS	
Design Speed > 45 mph	40
Design Speed ≤ 45 mph	22 ³
Paved And Painted For Left Turns	12 ⁴
<p>Median width is the distance between the inside (median) edge of the travel lane of each roadway.</p> <ol style="list-style-type: none"> 1. 88 ft. when future lanes planned. 2. Based on 2 ft. median barrier and 12 ft. shoulder. 3. On reconstruction projects where existing curb locations are fixed due to severe right of way constraints, the minimum width may be reduced to 19.5 ft. for design speeds = 45 mph, and to 15.5 ft. for design speeds ≤ 40 mph. 4. Restricted to 5-lane sections with design speeds ≤ 40 mph. On reconstruction projects where existing curb locations are fixed due to severe right of way constraints, the minimum width may be reduced to 10 ft. These flush medians are to include sections of raised or restrictive median for pedestrian refuge and to conform to Section 2.2.2 of this Volume and the Access Management Rules. 	

2.2.2 Median Policy for Multilane Facilities

Design multilane facilities with a design speed of 45 mph or greater with a raised or restrictive median. Multilane facilities with design speeds of 40 mph or less may be designed without a raised or restrictive median; however, sections of raised or restrictive medians or islands must be provided to:

- Enhance vehicular and pedestrian safety,
- Improve traffic efficiency, and
- Attain the standards of the Access Management Classification of that highway system.

2.2.3 Median Treatments on Bridges

For divided highways, the District will determine the desired distance based on the following:

1. Provide separate structures if the open space between the bridges would be 20 feet or more.
2. Provide a single structure if the open space between the bridges would be less than 10 feet.
3. A single structure is recommended when the open space between the bridges would be between 10 and 20 feet.

See **Figures 2.11.1** and **2.11.3** in this chapter for bridge sections. Consult with the District Structures Maintenance Engineer when the open space between the bridges would be between 10 feet and 20 feet.

The inspection and maintenance capabilities of each District Office's personnel and equipment will provide the basis for deciding on a single structure deck or twin bridges. If the total width for a single structure exceeds the capacity of district maintenance equipment (approximately 60 ft. reach), twin structures may be specified and the open distance between structures determined by the practical capability of the maintenance and inspection equipment. This is particularly important for girder superstructures because those areas that cannot be reached by topside equipment might require catwalks, ladders or other access features. Such features are to be accounted for in the initial selection of alternates as they will add to the cost of superstructures.

2.3 Shoulders

Roadway shoulder width, cross slope and superelevation criteria are provided in the criteria tables and figures. Paved outside shoulders, 5 ft. in width, are required on all new construction, reconstruction and lane addition projects for all highways except freeways, which generally require a 10 ft. paved outside shoulder.

Specific widths have also been adopted for interstate, expressway, single and double lane ramps and collector-distributor road shoulders. Total shoulder widths, paved shoulder widths, and widths of paved shoulder separations between through pavement edge and the near edge of any shoulder gutter are given for both right (outside) and left (inside) edges of the roadway. See **Tables 2.3.1 – 2.3.4** and **Figures 2.3.1 – 2.3.2**.

The [Design Standards, Index 104](#), provides additional details for paved shoulders.

Figures 2.11.1 and **2.11.2** include criteria for shoulder widths on various bridge sections. Where these widths differ from those required for roadways or ramps, decisions about the final values chosen for the project are to be coordinated between the Roadway and Structures Design Offices.

Generally, the outside shoulder width for bridges should be the same width as the approach roadway shoulder up to a maximum of 10 feet. On roadway alignments having 12 ft. shoulders with continuous barrier walls and closely spaced bridges, a 12 ft. bridge shoulder width may be considered. The decision to use 12 ft. bridge shoulder widths should be coordinated with the District Design Engineer.

Modification for Non-Conventional Projects:

Delete last sentence in above paragraph and see RFP for bridge shoulder width requirements.

For shoulder cross slope criteria on bridges see **Section 2.1.5**.

It is recommended to pave the median section and a 10 foot outside shoulder under overpass bridges. In addition, miscellaneous asphalt should be placed from the paved shoulder to the slope pavement. This pavement will provide additional safety, enhance drainage, reduce maintenance and improve appearance. See **Figure 2.3.2**.

For paved shoulders at railroad crossings see the [Design Standards, Index 560](#).

Table 2.3.1 Shoulder Widths and Cross Slopes - Freeways

HIGHWAY TYPE		WIDTH (FEET)								CROSS SLOPES				
		WITHOUT SHOULDER GUTTER				WITH SHOULDER GUTTER								
		FULL WIDTH		PAVED WIDTH		FULL WIDTH		PAVED WIDTH		NORMAL ¹				
		Outside	Median or Left	Outside	Median or Left	Outside	Median or Left	Outside	Median or Left	Outside ₆	Median or Left			
FREWAYS (Lanes One Way)	4-Lane or More	12	12	10	10	15.5	15.5	8	8	0.06	0.06			
	3-Lane	12	12	10	10	15.5	15.5	8	8		0.05			
	2-Lane	12	8	10	4	15.5	13.5	8	6					
	HOV Lane	N/A ₄	14	N/A ₄	10	N/A ₄	N/A ₄	N/A ₄	N/A ₄	N/A ₄	N/A ₄	0.05 ₂		
	1-lane Barrier-Separated HOV Lane ₅	6	4 ₅	6	4 ₅	N/A ₄	N/A ₄	N/A ₄	N/A ₄	N/A ₄	Same as Lane	Same as Lane ₅		
	2-lane Barrier-Separated HOV Lane ₅	10	6 ₅	10	6 ₅	N/A ₄	N/A ₄	N/A ₄	N/A ₄	N/A ₄	Same as Lane	Same as Lane ₅		
	1-Lane Ramp	6	6	4	2	11.5	11.5	4 ₃	4	0.06	0.05			
	2-Lane Ramp Non-Interstate	10	8	8	4	15.5	13.5	8	6					
	2-Lane Ramp Interstate	12	8	10	4	15.5	13.5	8	6					
	C-D Road 1-Lane	6	6	4	2	11.5	11.5	4	4					
	C-D Road 2-Lane	12	8	10	4	15.5	13.5	8	6					
	C-D Road 3-Lane	12	12	10	10	15.5	15.5	8	8					
	C-D Road > 3-Lane	12	12	10	10	15.5	15.5	8	8				0.06	
	Auxiliary Lane Climbing & Weaving	12	N/A ₄	10	N/A ₄	15.5	N/A ₄	8	N/A ₄				N/A ₄	
	Auxiliary Lane Mainline Terminal: 1-Lane Ramp	12	N/A ₄	10	N/A ₄	15.5	N/A ₄	8	N/A ₄				N/A ₄	N/A ₄
	2-Lane Ramp	12	N/A ₄	10	N/A ₄	15.5	N/A ₄	8	N/A ₄				N/A ₄	N/A ₄
Frontage Road	See COLLECTORS Table 2.3.4 . For local roads and streets see the FDOT <i>Manual of Uniform Minimum Standards for Design, Construction and Maintenance for Streets and Highways</i> .													

1. Shoulders must extend 4 ft. beyond the back of shoulder gutter and at a 0.06 cross slope back toward the gutter.
2. 0.06 when 4 lanes or more combined.
3. Shoulder pavement less than 6 ft. in width that adjoins shoulder gutter must be the same type, depth and cross slope as the ramp pavement.
4. This does not mean that a shoulder is unnecessary; rather, shoulder is not typically present at this location (i.e., it is not required when adjacent to the through lane).
5. If median side of HOV lane is not barrier-separated, use median shoulder requirements for a standard HOV lane. Refer to AASHTO's *Guide for High-Occupancy Vehicle Facilities* for additional information.
6. For projects constructed with concrete pavement, the first one or two feet (as determined by outside slab width) of the designated shoulder width must have the same cross slope (and superelevation) as the outside lane.

Table 2.3.2 Shoulder Widths and Cross Slopes - Arterials Divided

HIGHWAY TYPE		WIDTH (FEET)								CROSS SLOPES		
		WITHOUT SHOULDER GUTTER				WITH SHOULDER GUTTER						
		FULL WIDTH		PAVED WIDTH		FULL WIDTH		PAVED WIDTH		NORMAL ¹		
		Outside	Median or Left	Outside ^{2,7}	Median or Left	Outside	Median or Left	Outside	Median or Left	Outside ⁶	Median or Left	
A R T E R I A L S	4-Lane	12	12	5	4	15.5	15.5	8	8	0.06	0.06	
		10	10	5	4	15.5	15.5	8	8			
		8	8	5	4	13.5	13.5	6	6			
	3-Lane	12	12	5	0 ₄	15.5	15.5	8	8		0.05	
		10	10	5	0 ₄	15.5	15.5	8	8			
		8	8	5	0 ₄	13.5	13.5	6	6			
	2-Lane	12	8	5	0 ₄	15.5	13.5	8	6			0.06
		10	8	5	0 ₄	15.5	13.5	8	6			
	8	6	5	0 ₄	13.5	11.5	6	4				
	1-Lane Ramp	6 ₇	6	5	2	11.5 ₈	11.5	4 _{3,8}	4			
2-Lane Ramp	10	6	5	2	15.5	13.5	8	6				
C-D Road 1-Lane	6 ₇	6	5	2	11.5 ₈	11.5	4 ₈	4				
C-D Road 2-Lane	8	6	5	0	13.5	11.5	6	4				
Auxiliary Lane Climbing & Weaving	Same As Travel Lanes	N/A ₅	Same As Travel Lanes	N/A ₅	Same As Travel Lanes	N/A ₅	Same As Travel Lanes	N/A ₅	N/A ₅			
Auxiliary Lane Mainline Terminal: 1-Lane												
Ramp 2-Lane Ramp	8 12	N/A ₅ N/A ₅	5 10	N/A ₅ N/A ₅	11.5 ₈ 15.5	N/A ₅ N/A ₅	4 ₈ 8	N/A ₅ N/A ₅	N/A ₅ N/A ₅			
Auxiliary Lane At-Grade Intersection	Same As Travel Lanes	Same As Travel Lanes	5	0	11.5 ₈	N/A ₅	4 ₈	N/A ₅	0.05 - 0.06			
Frontage Road	See Collectors Table 2.3.4 . For local roads and streets see the FDOT Manual of Uniform Minimum Standards for Design, Construction and Maintenance for Streets and Highways .											

- Shoulders must extend 4 ft. beyond the back of shoulder gutter and have a 0.06 cross slope back toward the gutter.
 - Shoulders must be paved full width through rail-highway at-grade crossings, extending a minimum distance of 50 ft. on each side of the crossing measured from the outside rail. For additional information see the [Design Standards, Index No. 560 and 17882](#).
 - Shoulder pavement less than 6 ft. in width and adjoining shoulder gutter must be the same type, depth and cross slope as the ramp pavement.
 - Paved 2 ft. wide where turf is difficult to establish. Paved 4 ft. wide (a) in sag vertical curves, 100 ft. minimum either side of the low point, and (b) on the low side of superelevated traffic lanes extending through the curves and approximately 300 ft. beyond the PC and PT.
- LEGEND FOR VALUES**
 X High Volume Highways
 X Normal Volume Highways
 X Low Volume Highways
- This does not mean that a shoulder is unnecessary; rather, shoulder is not typically present at this location (i.e., it is not required when adjacent to through lane).
 - For projects constructed with concrete pavement, the first one or two feet (as determined by outside slab width) of the designated shoulder width must have the same cross slope (and superelevation) as the outside lane.
 - 7 ft. width in or within one mile of an urban area. Minimum 8 ft. full shoulder width when a 7 ft. paved shoulder is required.
 - 13.5 ft. full shoulder width and 6 ft. paved width in or within one mile of an urban area.

Table 2.3.3 Shoulder Widths and Cross Slopes - Arterials Undivided

HIGHWAY TYPE		WIDTHS (FEET)				CROSS SLOPES
		WITHOUT SHOULDER GUTTER		WITH SHOULDER GUTTER		NORMAL ^{1, 4}
		FULL WIDTH	PAVED WIDTH ^{2, 5}	FULL WIDTH	PAVED WIDTH	
ARTERIALS Undivided (lanes Two-Way)	Multilane ³	12 10 8	5 5 5	15.5 15.5 13.5	8 8 6	0.06
	2-Lane	12 10 8	5 5 5	15.5 15.5 13.5	8 8 6	
	Auxiliary Lane At-Grade Intersections	Same As Travel Lanes	5	11.5 ₆	4 ₆	
	Frontage Road	See COLLECTORS Table 2.3.4. For local roads and streets see the FDOT <i>Manual of Uniform Minimum Standards for Design, Construction and Maintenance for Streets and Highways.</i>				

1. Shoulders must extend 4 ft. beyond the back of shoulder gutter and have a 0.06 cross slope back toward the gutter.

2. Shoulders must be paved full width through rail-highway at-grade crossings, extending a minimum distance of 50 ft. on each side of the crossing measured from the outside rail. For additional information see the [Design Standards, Index No. 560](#) and [17882](#).

3. All multilane facilities must conform with **Section 2.2.2** of this Volume.

LEGEND X.....High Volume Highways
FOR X.....Normal Volume Highways
VALUES X.....Low Volume Highways

4. For projects constructed with concrete pavement, the first one or two feet (as determined by outside slab width) of the designated shoulder width must have the same cross slope (and superelevation) as the outside lane.

5. 7 ft. paved width in or within one mile of an urban area.

6. 13.5 ft. full shoulder width and 6 ft. paved width in or within one mile of an urban area.

Table 2.3.4 Shoulder Widths and Cross Slopes – Collectors Divided and Undivided

HIGHWAY TYPE		WIDTHS (FEET)								CROSS SLOPES	
		WITHOUT SHOULDER GUTTER				WITH SHOULDER GUTTER				NORMAL ¹	
		FULL WIDTH		PAVED WIDTH		FULL WIDTH		PAVED WIDTH			
		Outside	Median Or Left	Outside ^{2,7}	Median Or Left	Outside	Median Or Left	Outside	Median Or Left	Outside ⁶	Median Or Left
C O L L E C T O R S Divided (Lanes One-Way)	3-Lane	12 10 8	12 10 8	5 5 5	0 ₃ 0 ₃ 0 ₃	15.5 15.5 13.5	15.5 15.5 15.5	8 8 6	8 8 6	0.06	0.05
	2-lane	12 10 8	8 8 6	5 5 5	0 ₃ 0 ₃ 0 ₃	15.5 15.5 13.5	13.5 13.5 11.5	8 8 6	6 6 4		
	Auxiliary Lane At-Grade Intersection	Same As Travel Lanes	Same As Travel Lanes	5	4	11.5 ₈	N/A ₅	4 ₈	N/A ₅		
C O L L E C T O R S Undivided (Lanes Two-Way)	Multilane ⁴	12 10 8		5 5 5		15.5 15.5 13.5		8 8 6		0.06	
	2-Lane	12 10 8		5 5 5		15.5 15.5 13.5		8 8 6			
	Auxiliary Lane At-Grade Intersection	Same As Travel Lanes	Same As Travel Lanes			11.5 ₈		4 ₈			

1. Shoulders must extend 4 ft. beyond the back of shoulder gutter and have a 0.06 cross slope back toward the gutter.
2. Shoulders must be paved full width though rail-highway at-grade crossings, extending a minimum distance of 50 ft. on each side of the crossing measured from the outside rail. For additional information see [Design Standards, Index Nos. 560 and 17882](#).
3. The median shoulder may be paved 2 ft. wide in areas of the State where establishing and maintaining turf is difficult; however, shoulders must be paved 4 ft. wide (a) in sag vertical curves, 100 ft. minimum either side of the low point, and (b) on the low side of superelevated traffic lanes, extending through the curve and approximately 300 ft. beyond the PC and PT.
4. All multilane facilities must conform with **Section 2.2.2** of this volume.

LEGEND	X.....High Volume Highways
FOR	X.....Normal Volume Highways
VALUES	X.....Low Volume Highways
5. This does not mean that a shoulder is unnecessary; rather, shoulder is not typically present at this location (i.e., it is not required when adjacent to through lane).
6. For projects constructed with concrete pavement, the first one or two feet (as determined by outside slab width) of the designated shoulder width must have the same cross slope (and superelevation) as the outside lane.
7. 7 ft. width in or within one mile of an urban area.
8. 13.5 ft. full shoulder width and 6 ft. paved width in or within one mile of an urban area.

Figure 2.3.1.A Shoulder Superelevation

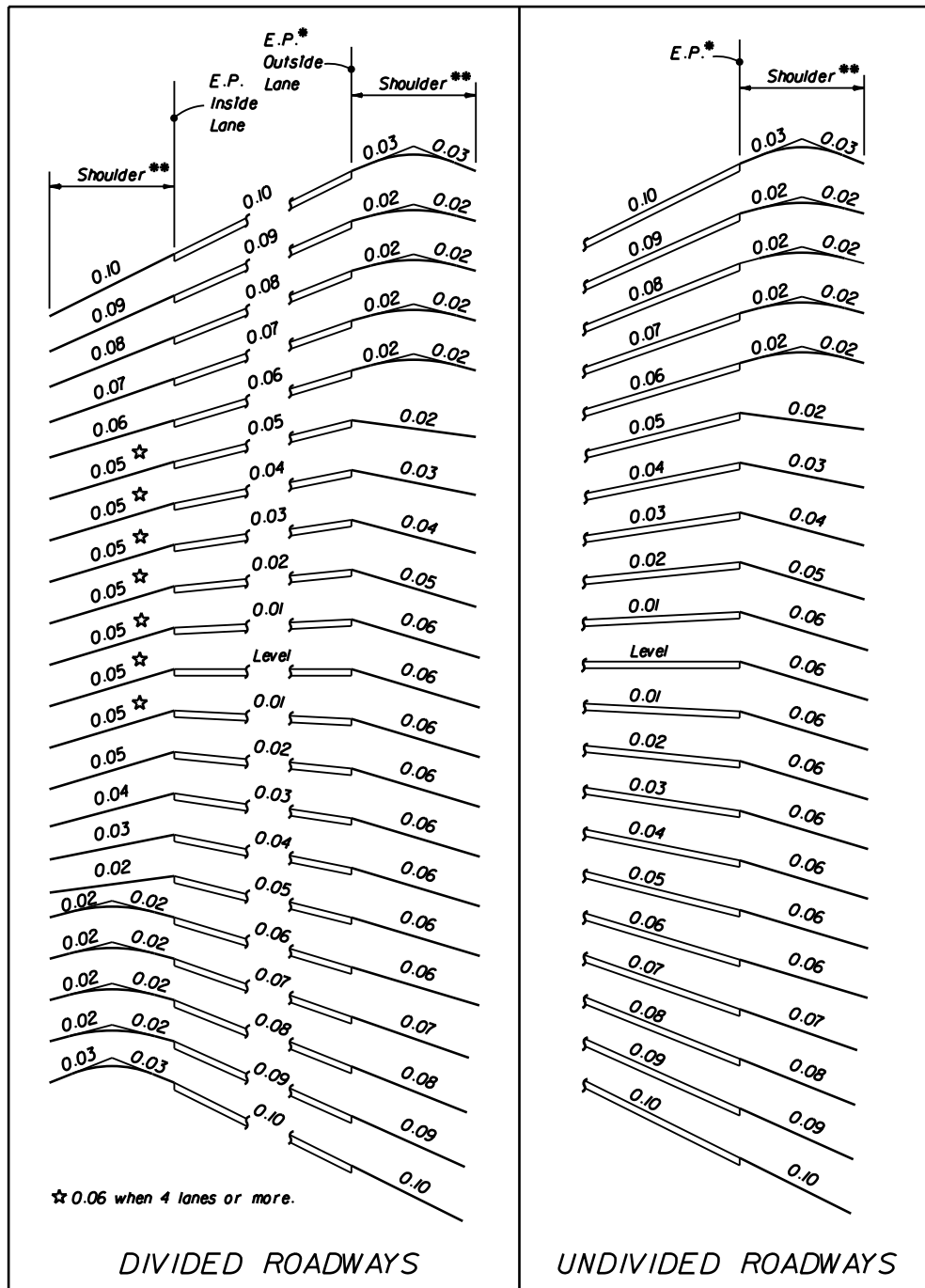

- * For projects constructed with concrete pavement, the shoulder must be superelevated about the outside edge of the outside slab.
- ** For shoulders with paved widths 5 feet or less (all Highway Types) see Special Shoulder superelevation details (**Figure 2.3.1.B**).

Figure 2.3.1.B Special Shoulder Superelevation

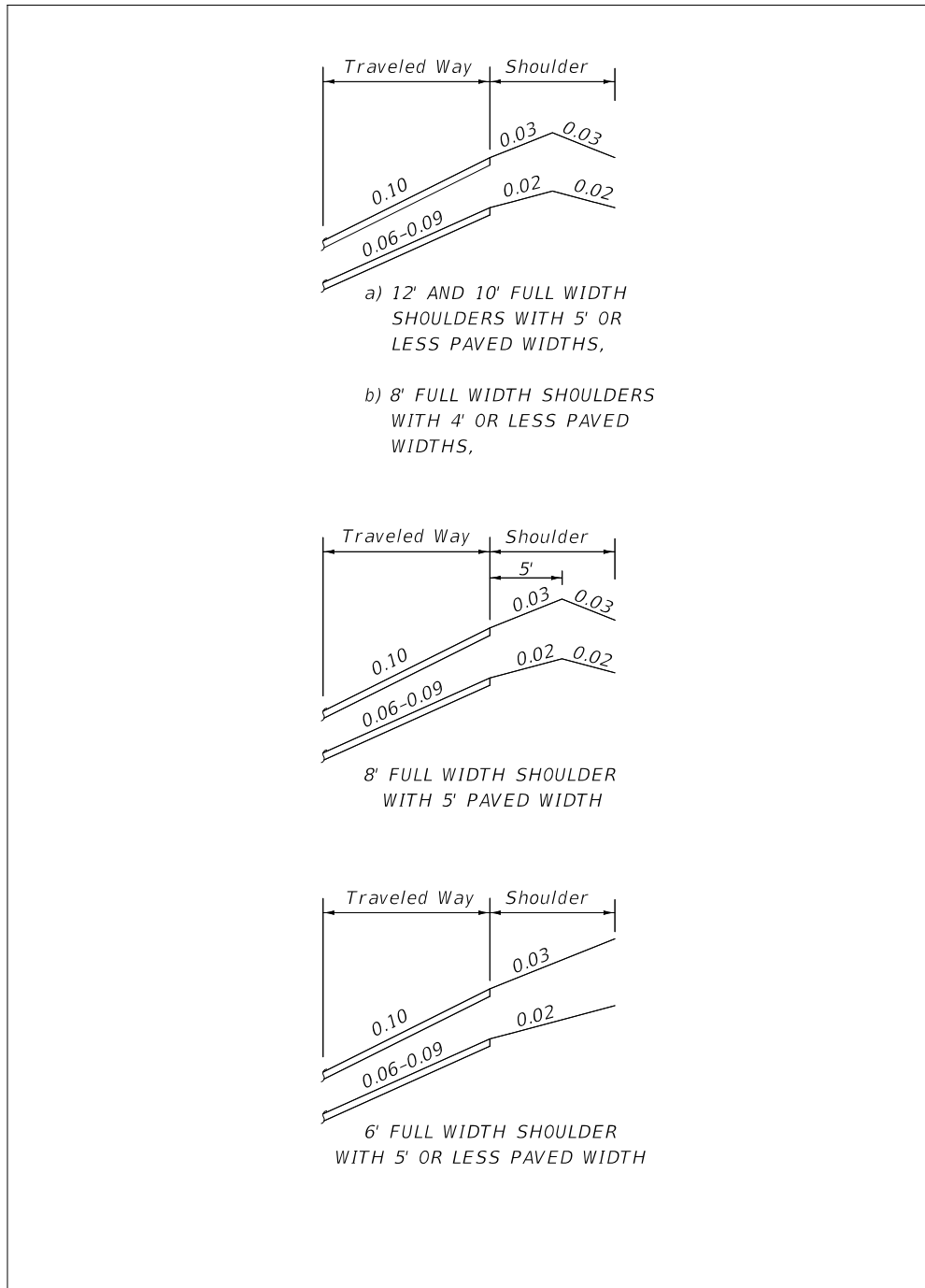
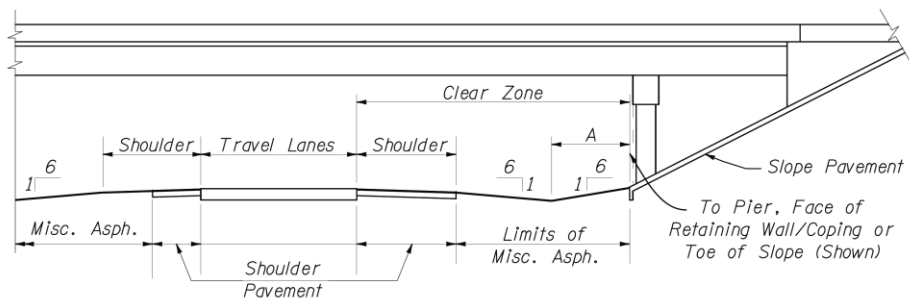
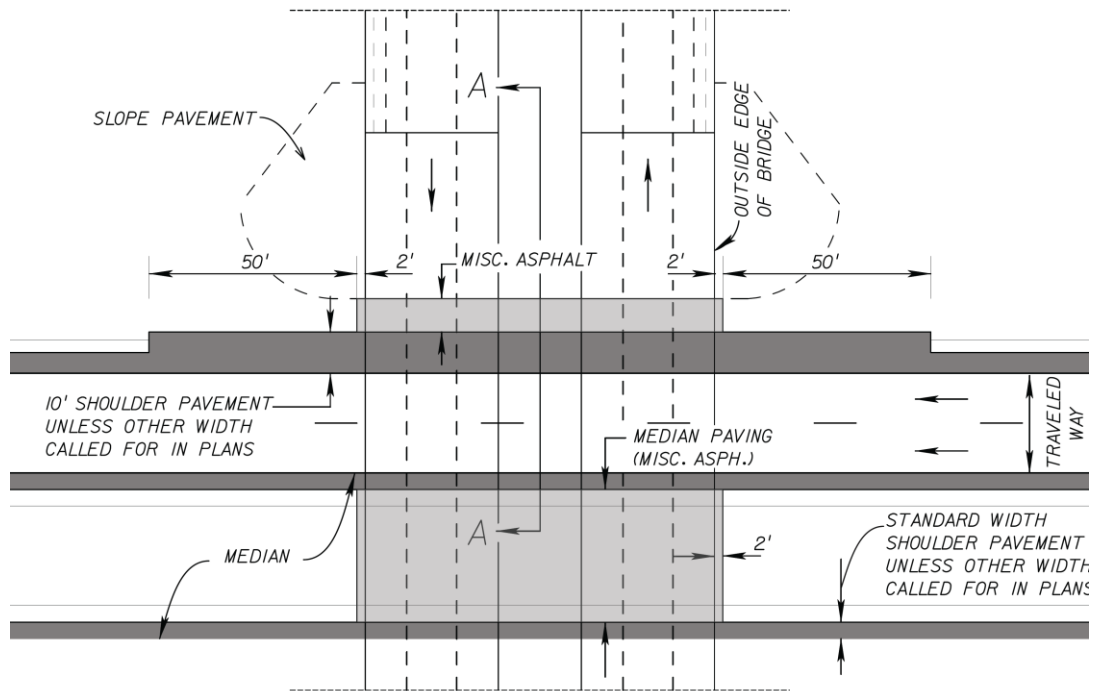

Figure 2.3.2 Typical Paving Under Bridge



SECTION A-A

FACILITY	A
FREEWAYS RURAL AND URBAN INTERSTATES (FREEWAYS), ARTERIALS, AND COLLECTORS, WITH PROJECTED 20-YEAR ADT OF 1500 OR GREATER	12'
RURAL ARTERIALS AND COLLECTORS WITH PROJECTED 20-YEAR ADT OF LESS THAN 1500.	8'
URBAN ARTERIALS AND COLLECTORS FLUSH SHOULDER ROADWAYS WITH PROJECTED 20-YEAR ADT OF LESS THAN 1500	6'

2.3.1 Limits of Friction Course on Paved Shoulders

On limited access facilities, extend the friction course 8 inches onto both the median and outside paved shoulders of roadways.

On non-limited access highways, extend the friction course the full width of the paved shoulder to accommodate bicyclist usage.

2.3.2 Shoulder Warning Devices (Rumble Strips)

The safety of freeways and other limited access facilities on the State highway system is to be enhanced by the installation of shoulder warning devices in the form of rumble strips. Include ground-in rumble strips in the design of projects on limited access facilities. Several types of applications have been tested. The ground-in strips provide the desired warning to the driver and consistency in application has been possible using this construction process.

These ground-in strips are installed using two patterns. The skip array is the standard array. These are used on both inside and outside shoulders on divided highway sections. Install the continuous array in advance of bridge ends for a distance of 1000 ft. or back to the gore recovery area for mainline interchange bridges. Other areas may be specified in plans.

The [Design Standards, Index 518](#), has been prepared to provide all needed details. This index also gives standards for raised rumble strips for use at structures where the bridge shoulder width is less than the width of the useable shoulder on the approach roadway. Notes for locations of raised rumble strip applications are also included on the index.

2.3.3 Use of Curb

See **Section 4.2.7.2** of this Volume, for information regarding curbs and their placement. Additionally, refer to **Section 2.16**, concerning the use of curbs along High Speed Urban and Suburban roadways.

2.4 Roadside Slopes

Criteria and details for roadside slopes are included in **Chapter 4** of this Volume.

2.5 Borders

Border widths for new construction or major reconstruction where R/W acquisition is required are as follows:

On highways with flush shoulders, the border is measured from the shoulder break to the right of way line. This border width accommodates (1) roadside design components such as signing, drainage features, guardrail, fencing and clear zone, (2) the construction and maintenance of the facility and (3) permitted public utilities. See **Table 2.5.1**.

On highways with curb or curb and gutter where clear zone is being provided, border width is to be based on flush shoulder requirements, but is measured from the outside edge of pavement to the right of way line. This border width accommodates (1) roadside design components such as signing, drainage features, guardrail, fencing and clear zone, (2) the construction and maintenance of the facility and (3) permitted public utilities. See **Table 2.5.1**.

On highways with curb or curb and gutter in urban areas, the border is measured from the outside edge of pavement to the right of way line. This border provides space for a buffer between vehicles and pedestrians, sidewalks with ADA provisions, traffic control devices, fire hydrants, storm drainage features, bus and transit features, permitted public utilities and space for aesthetic features such as sod and other landscape items. See **Table 2.5.2**.

On limited access facilities, the border width criteria are provided in **Section 2.5.1**.

Projects involving bridges will require coordination to match the features of the roadway with those of the bridge.

Modification for Non-Conventional Projects:

Delete sentence above and see RFP for requirements on projects involving bridges.

On existing streets and highways where R/W cannot be acquired or where the decision has been made to simply maintain and preserve the facility, reserve the border area for the functional and safety needs of the facility. The absolute minimum border under these conditions is 8 feet.

Table 2.5.1 Highways with Flush Shoulders

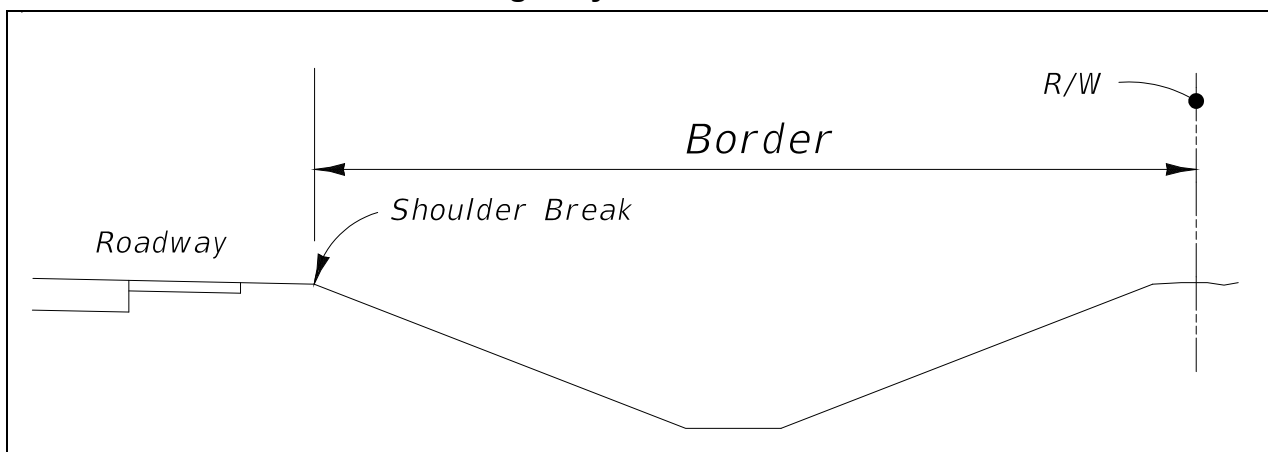

The diagram illustrates a highway cross-section. On the left, a 'Roadway' is shown with a 'Shoulder Break' indicated by a vertical line. To the right of the shoulder break is a sloped 'Border' area. A horizontal double-headed arrow labeled 'Border' spans the width of this area. On the far right, a vertical dashed line represents the 'R/W' (Right-of-Way) boundary.

BORDER	
TYPE FACILITY	WIDTH (FEET)
ARTERIALS COLLECTORS Design Speed > 45 mph	40
ARTERIALS COLLECTORS Design Speed ≤ 45 mph	33

Table 2.5.2 Highways with Curb or Curb and Gutter in Urban Areas

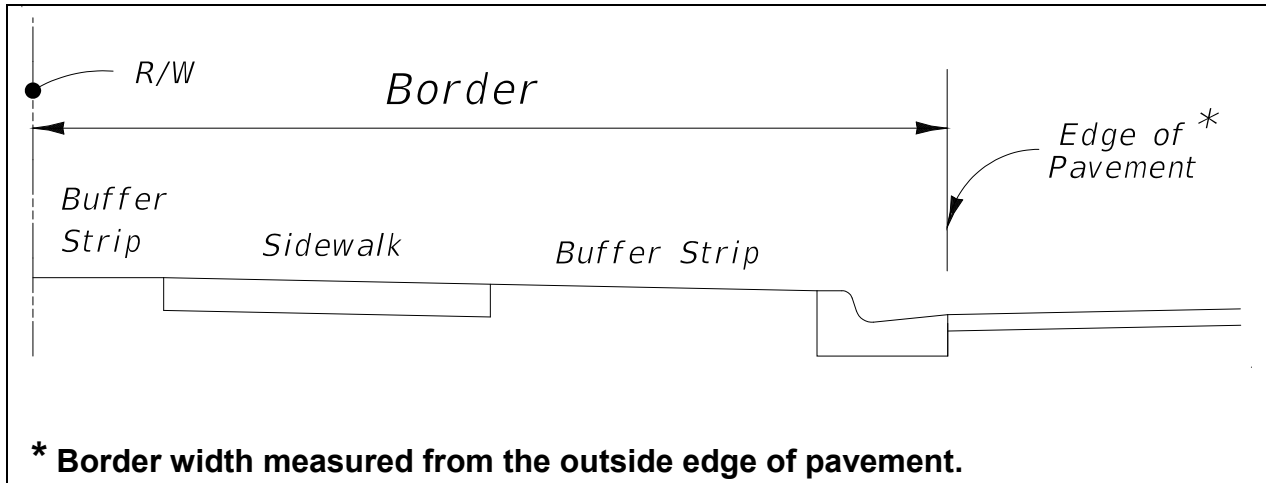

BORDER		
TYPE FACILITY	MINIMUM WIDTH (FEET)	
	TRAVEL LANES AT CURB OR CURB AND GUTTER	BICYCLE LANES OR OTHER AUXILIARY LANES AT CURB OR CURB AND GUTTER
ARTERIALS COLLECTORS Design Speed = 45 mph	14	12
ARTERIALS COLLECTORS Design Speed ≤ 40 mph	12	10
URBAN COLLECTOR STREETS Design Speed ≤ 30 mph	10	8

2.5.1 Limited Access Facilities

On limited access facilities, the border is measured from the edge of the outside edge of traveled way to the right of way line. This width may be reduced in the area of a crossroad terminal, as long as the design meets the requirements for clear zone, lateral offsets, drainage, maintenance access, etc.

Limited access facilities must be contained by fencing, or in special cases, walls or barriers. These treatments must be continuous and appropriate for each location. Treatment height and type may vary under special conditions. The treatment is typically placed at or near the limited access right of way line, but location may be adjusted based on site-specific conditions; e.g., ponds, trees, bridges. Placement information and additional data is included in the [Design Standards](#), *Indexes 800, 801, and 802*.

Modification for Non-Conventional Projects:

Delete third sentence in above paragraph and see RFP for requirements.

Table 2.5.3 Limited Access Facilities

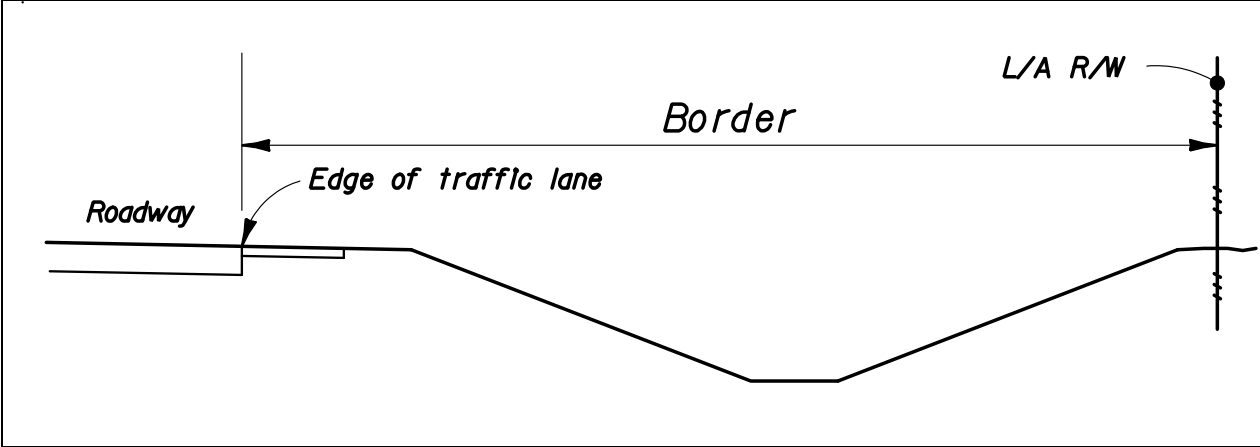

The diagram illustrates the cross-section of a limited access facility. On the left, a 'Roadway' is shown with a vertical line indicating the 'Edge of traffic lane'. A horizontal double-headed arrow labeled 'Border' extends from this edge to a vertical line on the right labeled 'L/A R/W'. The ground profile below shows a road surface that slopes down to a central ditch and then slopes back up to the right-of-way line.

BORDER	
TYPE FACILITY	WIDTH (FEET)
FREEWAYS (INCLUDING INTERCHANGE RAMPS)	94

2.6 Grades

The profile grade line defines the vertical alignment for roadway and bridge construction. As with other design elements, the characteristics of vertical alignment are influenced greatly by basic controls related to design speed, traffic volumes, functional classification, drainage and terrain conditions. Within these basic controls, several general criteria are considered. See **Tables 2.6.1 – 2.6.4**.

Minimum clearances for structures over railroads are given in **Table 2.10.1**. Additional information, including at-grade crossings, is given in **Chapter 6** of this Volume.

The Department's minimum for clearance over all highways is given in the criteria tables and figures. Exceptions to this policy will be permitted only when justified by extenuating circumstances and approved as a Design Variation or Design Exception.

The clearance required for the roadway base course above the Base Clearance Water Elevation is given in the criteria tables and figures. The relationship between the pavement elevation and the Design Flood Elevation is discussed in **Section 4.4 (3)** of the [FDOT Drainage Manual \(Topic No. 625-040-002\)](#). Turnpike facilities are generally used for Hurricane Evacuation. Design Turnpike mainline travel lanes to be above the 100 year flood plain elevation established by FEMA or other pertinent studies.

Design grades for structures over water to provide the minimum vertical clearance as stipulated in **Section 2.10**.

The [Design Standards](#) lists minimum covers and maximum fill heights for all types of culverts. For utility clearances, refer to the [Utility Accommodation Manual](#).

Table 2.6.1 Maximum Grades

MAXIMUM GRADES IN PERCENT														
TYPE OF HIGHWAY	AREA	DESIGN SPEED (mph)												
		FLAT TERRAIN						ROLLING TERRAIN						
		30	40	45	50	60	70	30	40	45	50	60	70	
FREEWAYS ¹	Rural	----	----	4	4	3	3	----	----	----	5	4	4	
	Urban	----	----	4	4	3	3	----	----	----	5	4	4	
ARTERIALS ³	Rural	----	5	5	4	3	3	----	6	6	5	4	4	
	Urban	8	7	6	6	5	----	9	8	7	7	6	----	
COLLECTORS ³	Rural	7	7	7	6	5	4	9	8	8	7	6	5	
	Urban	9	9	8	7	6	5	11	10	9	8	7	6	
	Industrial ²	4	4	4	3	3	----	5	5	5	4	4	----	
FRONTAGE ROADS	Require same criteria as Collectors.													
RAMPS	DESIGN SPEED (mph)		< 20		25 to 30		35 to 40		45 to 50					
	GRADES (%)		8		7		6		5					
One-way descending grades on Ramps may be 2% greater, in special cases.														
<ol style="list-style-type: none"> 1. Interstate designed to 70 mph will be restricted to 3% maximum grade. 2. Areas with significant (10% or more) heavy truck traffic. 3. On 2-lane highways critical length of upgrades must not be exceeded. Critical lengths are those which reduce the speeds of 200 lb/hp trucks by more than 10 mph. 														

Table 2.6.2 Maximum Change in Grade Without Vertical Curves

DESIGN SPEED (mph)	20	30	40	45	50	60	65	70
MAXIMUM CHANGE IN GRADE IN PERCENT	1.20	1.00	0.80	0.70	0.60	0.40	0.30	0.20

Table 2.6.3 Criteria for Grade Datum

CLEARANCE FOR THE ROADWAY BASE COURSE ABOVE THE BASE CLEARANCE WATER ELEVATION	
TYPE FACILITY	REQUIRED CLEARANCE
Freeways and Rural Multilane Mainline	3 ft.
Ramps (proper)	2 ft. ¹
Low Point on Ramps at Cross Roads	1 ft. ¹
Rural Two-lane with Design Year ADT Greater than 1500 VPD	2 ft. ¹
All Other Facilities Including Urban	1 ft. ¹

1. This clearance requires a reduction in the design resilient modulus (see the *Flexible Pavement Design Manual*). Notify the Pavement Design Engineer that the clearance is less than 3 feet.

Table 2.6.4 Grade Criteria for Curb and Gutter Sections

GRADES ON CURB AND GUTTER SECTIONS	
Minimum Distance Required between VPI's	250 ft.
Minimum Grade (%)	0.3 %

(See **Table 2.6.1** for Maximum Grades)

2.7 Sight Distance

Three aspects of sight distances should be considered:

1. Sight distances needed for stopping, which are applicable on all highways
2. Sight distances needed for the passing of overtaken vehicles, applicable only on two-lane highways
3. Sight distances needed for decisions at complex locations

The criteria used for stopping and decision sight distance are a driver's eye height of 3.5 feet and an object height of 0.5 feet. The criteria used for passing sight distance is an object height of 3.5 feet.

Sight distances greater than the minimum stopping sight distances in **Table 2.7.1** should be considered when drivers need additional time to make decisions. The AASHTO publication, ***A Policy on Geometric Design of Highways and Streets***, has a thorough discussion on decision sight distance.

Minimum stopping and passing sight distances are given in **Tables 2.7.1 – 2.7.2**.

Table 2.7.1 Minimum Stopping Sight Distance

MINIMUM STOPPING SIGHT DISTANCE (FEET) (For application of stopping sight distance, use an eye height of 3.5 feet and an object height of 0.5 feet above the road surface)														
DESIGN SPEED (mph)	GRADES OF 2% OR LESS													
	Interstate							All Other Facilities						
15	----							80						
20	----							115						
25	----							155						
30	----							200						
35	----							250						
40	----							305						
45	----							360						
50	----							425						
55	570							495						
60	645							570						
65	730							645						
70	820							730						
ADJUSTMENT IN DISTANCE FOR GRADES GREATER THAN 2%														
DESIGN SPEED (mph)	INCREASE IN LENGTH FOR DOWNGRADE (ft.)							DECREASE IN LENGTH FOR UPGRADE (ft.)						
	Grades													
	3%	4%	5%	6%	7%	8%	9%	3%	4%	5%	6%	7%	8%	9%
15	0	0	1	2	3	4	5	5	5	6	6	7	7	7
20	1	2	3	5	6	8	10	6	7	8	8	10	10	11
25	3	5	7	10	12	15	18	8	9	11	12	13	14	16
30	5	8	11	15	18	22	27	10	12	14	16	18	20	21
35	7	11	16	21	26	31	37	13	16	19	21	24	26	28
40	10	15	21	28	34	41	49	16	20	24	27	30	33	36
45	18	25	32	40	48	57	67	16	21	25	29	33	37	40
50	21	29	39	49	59	70	82	20	26	32	37	42	46	50
55	25	35	46	58	70	84	98	26	33	39	45	52	57	62
60	28	40	53	68	82	99	116	32	40	48	55	62	69	75
65	37	51	67	83	101	120	140	33	43	52	61	69	77	84
70	41	58	76	95	115	137	161	40	52	62	72	82	91	99

Table 2.7.2 Minimum Passing Sight Distance

MINIMUM PASSING SIGHT DISTANCE (FEET) (For application of passing sight distance, use an eye height of 3.5 feet and an object height of 3.5 feet above the road surface)											
DESIGN SPEED (mph)	20	25	30	35	40	45	50	55	60	65	70
2-Lane, 2-Way Facilities	710	900	1090	1280	1470	1625	1835	1985	2135	2285	2480

2.8 Curves

2.8.1 Horizontal Curves

Design speed is the principal factor controlling horizontal alignment. Several geometric standards related to design speed are very specific. Other criteria cannot be defined as specifically and require that judgments be made by designers in consideration of local conditions.

2.8.1.1 Supplemental Alignment Control (Mainline)

On projects which include roadways and bridges, coordination between the Roadway and Structures Design Offices may be necessary for those horizontal alignment issues affecting the location or geometry of the structure(s).

Avoid placing horizontal curves, PI's and superelevation transitions within the limits of a structure or approach slabs wherever practical. Because of the impact on the structure framing, spiral curves or alignments that result in skews greater than 45 degrees should be avoided. When skews greater than 45 degrees or spirals are necessary, submit specific justification including alternate framing concepts that relieve the severe skew effect to the District Design Engineer for concurrence.

Modification for Non-Conventional Projects:
Delete the last sentence in above paragraph.

Placement of stationing equations within the limits of a structure should be avoided on contract plans. Such equations unnecessarily increase the probability of error in both the design and construction phase.

Further guidelines have been established by the Department for lengths of horizontal curves, maximum deflections without curves, redirection of through lanes at intersections and minimum transition lengths between reverse curves. The criteria given are intended for use in establishing minimum lengths for both rural and urban conditions. See **Tables 2.8.1 – 2.8.4**.

For small deflection angles (5° or less), curves must be at least 500 ft. long and the minimum increased 100 ft. for each 1° decrease in the central angle (900 ft. for a 1° central angle).

For design, the aesthetic control given above should be considered where practical, but may be compromised where other considerations warrant such action. Discernment of alignment changes in an urban setting is normally minimal due to the masking effects of development, traffic signs, various items of interest and similar distracting stimuli.

For information on the maximum deflection without a curve, see **Table 2.8.1**.

When compound curves are necessary on open highways, the ratio of the flatter radius to the sharper radius cannot exceed 1.5:1. For turning roadways and intersections a ratio of 2:1 (where the flatter radius precedes the sharper radius in the direction of travel) is acceptable.

The length of compound curves for turning roadways when followed by a curve of one-half radius or preceded by a curve of double radius should be as shown in **Table 2.8.2b**.

Table 2.8.1a Maximum Deflections without Horizontal Curves

MAXIMUM DEFLECTION WITHOUT CURVE (DMS)			
TYPE FACILITY		V ≥ 45 mph	V ≤ 40 mph
Freeways		0° 45' 00"	N/A
Arterials and Collectors	Without Curb & Gutter	0° 45' 00"	2° 00' 00"
	With Curb & Gutter	1° 00' 00"	2° 00' 00"
Where V=Design Speed (mph)			

Table 2.8.1b Maximum Deflection for Through Lanes through Intersections

Design speed (mph)	20	25	30	35	40	45
Maximum Deflection	16° 00'	11° 00'	8° 00'	6° 00'	5° 00'	3° 00'

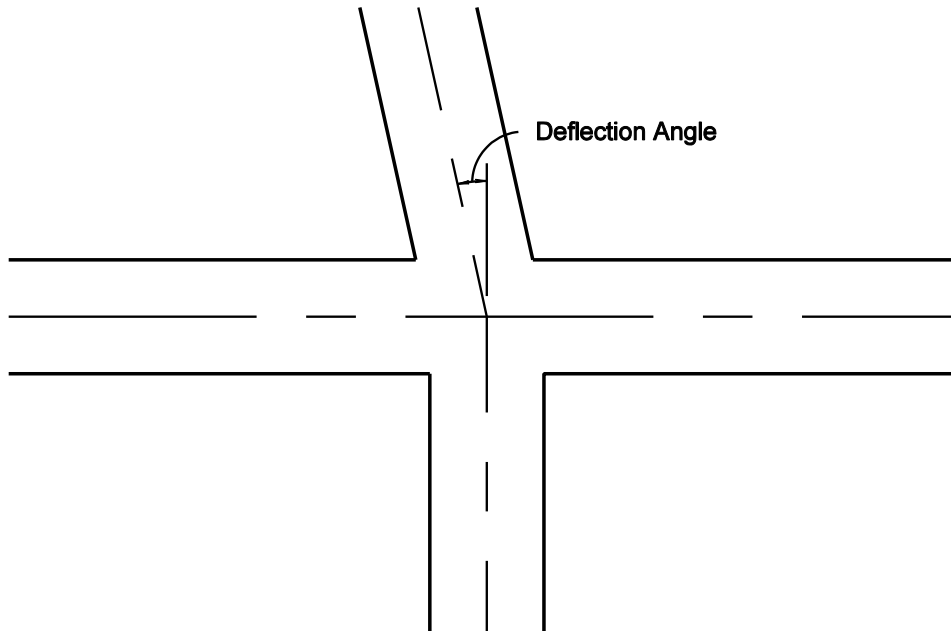

Table 2.8.2a Length of Horizontal Curves

LENGTH OF CURVE (FEET)	
Freeways	30V ¹
Arterials	15V ²
Collectors	15V ²
Where V = Design Speed (mph)	
1. When 30V cannot be attained, use the greatest attainable length, but not less than 15V. 2. When 15V cannot be attained, use the greatest attainable length, but not less than 400ft.	
Curve length must provide full superelevation within the curve of not less than 200 ft. (Rural) or 100 ft. (Urban)	

Table 2.8.2b Arc Length (in feet) of Compound Curves with One-Half/Double Radii - Turning Roadways

Radius (ft.)	100	150	200	250	300	400	≥ 500
Minimum Length	40	50	65	85	100	120	150
Desirable Length	65	70	100	120	150	180	200

Table 2.8.3 Maximum Curvature of Horizontal Curve (Using Limiting Values of "e" and "f")

MAXIMUM CURVATURE (Degrees)			
Design Speed (mph)	RURAL ENVIRONMENT (e max=0.10)	URBAN ENVIRONMENT (e max=0.05)	
		Without Curb And Gutter	With Curb And Gutter
30	24° 45'	20° 00'	20° 00'
35	17° 45'	14° 15'	14° 15'
40	13° 15'	10° 45'	10° 45'
45	10° 15'	8° 15'	8° 15'
50	8° 15'	6° 30'	6° 30'
55	6° 30'	5° 00'	---
60	5° 15'	---	---
65	4° 15'	---	---
70	3° 30'	---	---
Interstate: 3° 00' (Maximum Curvature) (e max=0.10)			

**Table 2.8.4 Maximum Horizontal Curvature
 Using Normal Cross Slopes (-0.02)**

MAXIMUM CURVATURE (Degrees)		
Design Speed (mph)	Curvature (e max = 0.10)	Curvature (e max = 0.05)
30	1° 30'	7° 00'
35	1° 15'	5° 00'
40	1° 00'	3° 45'
45	0° 45'	2° 45'
50	0° 30'	2° 00'
55	0° 30'	---
60	0° 15'	---
65	0° 15'	---
70	0° 15'	---

2.8.1.2 Supplemental Alignment Control (Intersections)

For redirection or offset deflection of through lanes through intersections, see the values given in **Table 2.8.1b**. Curves are not required for these angular breaks.

2.8.1.3 Roadway Transitions

Transition details have been developed and included in the [Design Standards](#). Transitions on curved alignment will require special design details in the contract plans.

2.8.2 Vertical Curves

Minimum lengths for crest and sag vertical curves are provided in **Tables 2.8.5 – 2.8.6**. K values for crest vertical curves are based on an eye height of 3.5' and an object height of 6".

**Table 2.8.5 Minimum Lengths of Crest Vertical Curves
 Based on Stopping Sight Distance**

K VALUES FOR CREST CURVES					
Design Speed (mph)	Interstate	All Other Facilities			
15	----	5			
20	----	10			
25	----	19			
30	----	31			
35	----	47			
40	----	70			
45	----	98			
50	----	136			
55	245	185			
60	313	245			
65	401	313			
70	506	401			
Length, L = KA Where: L = Minimum Length (feet) K = Constant A = Algebraic Difference In Grades (percent)					
K values for crest vertical curves are based on an eye height of 3.5' and an object height of 6".					
Interstates:	Lengths of crest vertical curves on Interstate mainlines are not to be less than 1000 ft. for open highways and 1800 ft. within interchanges.				
Service Interchanges:	K values for ramp crest vertical curves at interstate terminals are not to be less than the Interstate K values. K values for other ramp crest vertical curves are not to be less than the K values for All Other Facilities.				
System Interchanges:	K values for all crest vertical curves on systems interchanges are not to be less than the K values of the higher system.				
Arterials and Collectors:	The minimum lengths of crest vertical curves for highways with design speeds of 50 mph or greater are as follows:				
Design Speed (mph)	50	55	60	65	70
Minimum Length (ft.)	300	350	400	450	500
Low Speed Facilities:	The lengths of crest vertical curves are not to be less than 3 times the design speed (mph) expressed in feet.				

**Table 2.8.6 Minimum Lengths of Sag Vertical Curves
 Based on Stopping Sight Distance and Headlight Sight Distance**

K VALUES FOR SAG CURVES						
Design Speed (mph)	Interstate	All Other Facilities				
15	----	10				
20	----	17				
25	----	26				
30	----	37				
35	----	49				
40	----	64				
45	----	79				
50	----	96				
55	136	115				
60	157	136				
65	181	157				
70	206	181				
<p>Length, $L = KA$ Where: L = Minimum Length (feet) K = Constant A = Algebraic Difference In Grades (percent)</p>						
Interstates:	Lengths of sag vertical curves on Interstate mainlines are not to be less than 800 ft.					
Service Interchanges:	K values for ramp sag vertical curves at interstate terminals are not to be less than the interstate K values. K values for other ramp sag vertical curves are not to be less than the K values for All Other Facilities.					
System Interchanges:	K values for all sag vertical curves on systems interchanges are not to be less than the K values of the higher system.					
Arterials and Collectors:	The minimum lengths of sag vertical curves for highways with design speeds of 50 mph or greater are as follows:					
	Design Speed (mph)	50	55	60	65	70
	Minimum Length (ft.)	200	250	300	350	400
Low Speed Facilities:	The lengths of sag vertical curves are not to be less than 3 times the design speed (mph) expressed in feet.					

2.9 Superelevation

Superelevation rates of 0.10 maximum (rural) and 0.05 maximum (urban) are used by the Department on the State Highway System. Charts for these rates are in the criteria tables and figures. Additional data is contained in the [Design Standards, Indexes 510 and 511](#).

The standard superelevation transition places 80% of the transition on the tangent and 20% on the curve. In transition sections where the travel lane(s) cross slope is less than 1.5 %, provide one of the following grade criteria:

1. Maintain a minimum profile grade of 0.5%
2. Maintain a minimum edge of pavement grade of 0.2% (0.5% for curb and gutter).

When superelevation is required for curves in opposite directions on a common tangent, a suitable distance is required between the curves. This suitable tangent length should be determined as follows:

1. 80% of the transition for each curve should be located on the tangent.
2. The suitable tangent length is the sum of the two 80% distances, or greater.
3. Where alignment constraints dictate a less than desirable tangent length between curves, an adjustment of the 80/20 superelevation transition treatment is allowed (where up to 50% of the transition may be placed on the curve).

Table 2.9.1 Superelevation Rates for Rural Highways, Urban Freeways and High Speed Urban Highways ($e_{max} = 0.10$)

TABULATED VALUES										
Degree of Curve <i>D</i>	Radius <i>R</i> (ft.)	DESIGN SPEED (mph)								
		30	35	40	45	50	55	60	65	70
0° 15'	22,918	NC	NC	NC	NC	NC	NC	NC	NC	NC
0° 30'	11,459	NC	NC	NC	NC	NC	NC	RC	RC	RC
0° 45'	7,639	NC	NC	NC	NC	RC	RC	0.023	0.025	0.028
1° 00'	5,730	NC	NC	NC	RC	0.021	0.025	0.030	0.033	0.037
1° 15'	4,584	NC	NC	RC	0.022	0.026	0.031	0.036	0.041	0.046
1° 30'	3,820	NC	RC	0.021	0.026	0.031	0.037	0.043	0.048	0.054
	* <i>R</i> _{NC}									
2° 00'	2,865	RC	0.022	0.028	0.034	0.040	0.048	0.055	0.062	0.070
	* <i>R</i> _{RC}									
2° 30'	2,292	0.021	0.028	0.034	0.041	0.049	0.058	0.067	0.075	0.085
3° 00'	1,910	0.025	0.032	0.040	0.049	0.057	0.067	0.077	0.087	0.096
3° 30'	1,637	0.029	0.037	0.046	0.055	0.065	0.075	0.086	0.095	0.100
4° 00'	1,432	0.033	0.042	0.051	0.061	0.072	0.083	0.093	0.099	D _{max} = 3° 30'
5° 00'	1,146	0.040	0.050	0.061	0.072	0.083	0.094	0.098	D _{max} = 4° 15'	
6° 00'	955	0.046	0.058	0.070	0.082	0.092	0.099	D _{max} = 5° 15'		D _{max} = 6° 30'
7° 00'	819	0.053	0.065	0.078	0.089	0.098	D _{max} = 8° 15'			
8° 00'	716	0.058	0.071	0.084	0.095	0.100				
9° 00'	637	0.063	0.077	0.089	0.098	D _{max} = 10° 15'				
10° 00'	573	0.068	0.082	0.094	0.100					
11° 00'	521	0.072	0.086	0.097	D _{max} = 13° 15'					
12° 00'	477	0.076	0.090	0.099						
13° 00'	441	0.080	0.093	D _{max} = 17° 45'						
14° 00'	409	0.083	0.096							
15° 00'	382	0.086	0.098							
16° 00'	358	0.089	0.099							
18° 00'	318	0.093	D _{max} = 24° 45'							
20° 00'	286	0.097								
22° 00'	260	0.099								
24° 00'	239	0.100								
		D _{max} = 24° 45'								
* NC/RC and RC/e Break Points (Radius in feet)										
Break Points	DESIGN SPEED (mph)									
	30	35	40	45	50	55	60	65	70	
<i>R</i> _{NC}	3349	4384	5560	6878	8337	9949	11709	13164	14714	
<i>R</i> _{RC}	2471	3238	4110	5087	6171	7372	8686	9783	10955	
$e = NC$ if $R \geq R_{NC}$					$e = RC$ if $R < R_{NC}$ and $R \geq R_{RC}$					

NC = Normal Crown (-0.02) RC = Reverse Crown (+0.02)
*R*_{NC} = Minimum Radius for NC *R*_{RC} = Minimum Radius for RC

Rates for intermediate *D*'s and *R*'s are to be interpolated

Figure 2.9.1 Superelevation Rate For Rural Highways, Urban Freeways and High Speed Urban Highways ($e_{max} = 0.10$)

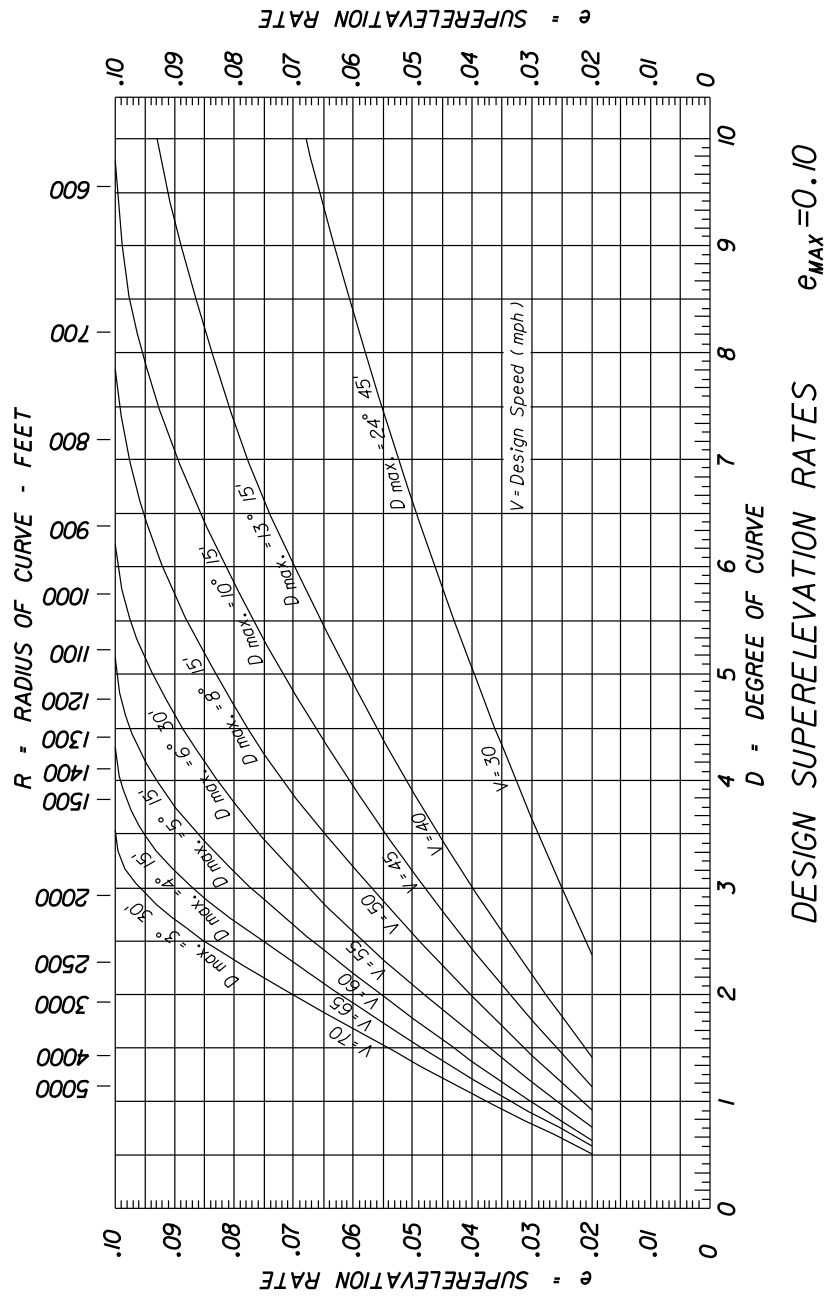

**Table 2.9.2 Superelevation Rates for Urban Highways
 and High Speed Urban Streets ($e_{max} = 0.05$)**

TABULATED VALUES						
Degree of Curve <i>D</i>	Radius <i>R</i> (ft.)	DESIGN SPEED (mph)				
		30	35	40	45	50
2° 00'	2,865	NC	NC	NC	NC	NC
2° 15'	2,546					RC
2° 45'	2,083				NC	
3° 00'	1,910				RC	
3° 45'	1,528			NC		
4° 00'	1,432			RC		
4° 45'	1,206					RC
5° 00'	1,146		NC			0.023
5° 15'	1,091		RC			0.027
5° 30'	1,042					0.030
5° 45'	996					0.035
6° 00'	955				RC	0.040
6° 15'	917				0.022	0.045
6° 30'	881				0.024	0.050
6° 45'	849				0.027	Dmax = 6° 30'
7° 00'	819	NC			0.030	
7° 15'	790	RC			0.033	
7° 30'	764				0.037	
7° 45'	739				0.041	
8° 00'	716			RC	0.045	
8° 15'	694			0.022	0.050	
8° 30'	674			0.025	Dmax = 8° 15'	
8° 45'	655			0.027		
9° 00'	637			0.030		
9° 30'	603			0.034		
10° 00'	573			0.040		
10° 30'	546		RC	0.047		
11° 00'	521		0.023	Dmax = 10° 45'		
11° 30'	498		0.026			
12° 00'	477		0.030			
13° 00'	441		0.036			
14° 00'	409	RC	0.045			
15° 00'	382	0.023	Dmax = 14° 15'			
16° 00'	358	0.027				
17° 00'	337	0.032				
18° 00'	318	0.038				
19° 00'	302	0.043				
20° 00'	286	0.050				
		Dmax = 20° 00'				

NC = Normal Crown (-0.02)

RC = Reverse Crown (+0.02)

Figure 2.9.2 Superlevation Rates for Urban Highways and High Speed Urban Streets ($e_{max} = 0.05$)

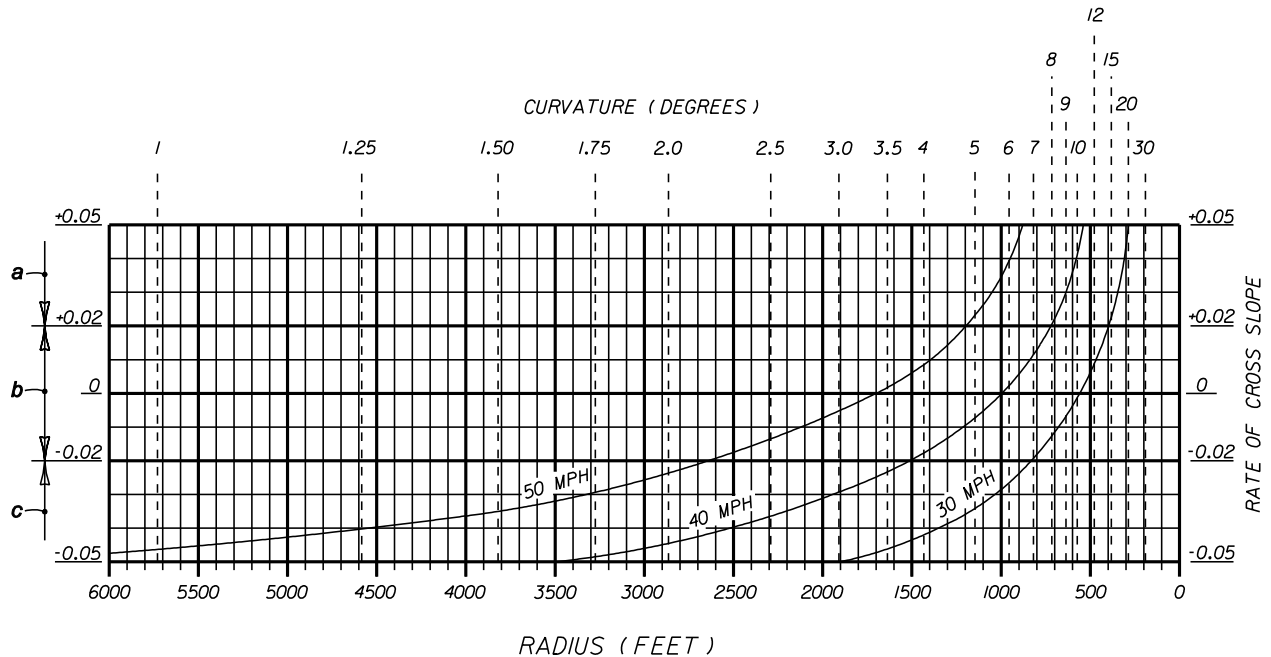

- When the speed curves and the degree of curve lines intersect above this line, the pavement is to be superelevated (positive slope) at the rates indicated at the lines intersecting points.
- When the speed curves and the degree of curve lines intersect between these limits, the pavement is to be superelevated at the rate of 0.02 (positive slope).
- When the speed curves and the degree of curve lines intersect below this line, the pavement is to have normal crown (typically 0.02 and 0.03 downward slopes).

Table 2.9.3 Superelevation Transition Slope Rates for Rural Highways, Urban Freeways and High Speed Urban Highways

SLOPE RATES FOR STRAIGHT LINE SUPERELEVATION TRANSITIONS				
SECTION	Design Speed (mph)			
	35-40	45-50	55-60	65-70
	SLOPE RATES			
2 Lane & 4 Lane	1:175	1:200	1:225	1:250
6 Lane	---	1:160	1:180	1:200
8 Lane	---	1:150	1:170	1:190

The length of superelevation transition is to be determined by the relative slope rate between the travel way edge of pavement and the profile grade, except that the minimum length of transition is 100 feet.

For additional information on transitions, see the [Design Standards, Index 510](#).

Table 2.9.4 Superelevation Transition Slope Rates for Urban Highways and High Speed Urban Streets

SLOPE RATES FOR STRAIGHT LINE SUPERELEVATION TRANSITIONS	
30 mph	1:100
40 mph	1:125
45-50 mph ¹	1:150

1. A slope rate of 1:125 may be used for 45 mph under restricted conditions.

The length of superelevation transition is to be determined by the relative slope rate between the travel way edge of pavement and the profile grade, except that the minimum length of transition is 50 ft. for design speeds under 40 mph and 75 ft. for design speeds of 40 mph or greater. For additional information on transitions, see the [Design Standards, Index 511](#).

2.10 Vertical Clearance

For bridges, sign structures, and signal structures, minimum vertical clearance is the least distance measured between the lowest bridge superstructure element, sign, signal, luminaire or support member and the traffic lane or shoulder directly below the element.

FDOT minimum vertical clearances for new structures are defined in the tables and figures that follow. For AASHTO minimum vertical clearance requirements, see *AASHTO's A Policy on Geometric Design of Highways and Streets*. Chapter 23 of this Volume also contains useful information.

For any construction affecting existing roadway or railroad over roadway bridge clearances (e.g., bridge widenings or resurfacing), FDOT minimum vertical clearance is 16'-0". If the minimum design vertical clearance is between 16'-0" and 16'-2", place a note in the plans as shown in **Section 10.4.1** of Volume 2.

For any construction affecting existing sign structure or pedestrian bridge clearances, FDOT minimum vertical clearance is 17'-0". For any construction affecting existing walk-in Dynamic Message Sign (DMS) structure clearances, FDOT minimum vertical clearance is 19'-0".

For any construction affecting existing signal clearances, FDOT minimum vertical clearance is 17'-0". Vertical clearances between 15'-0" and 17'-0" require a Design Variation. No Design Variations will be approved to allow signal clearances less than 15'-0".

Figure 2.10.1 Clearances – Rural and Urban Interstates (Freeways), Arterials and Collectors, with Projected 20-Year ADT of 1500 or Greater

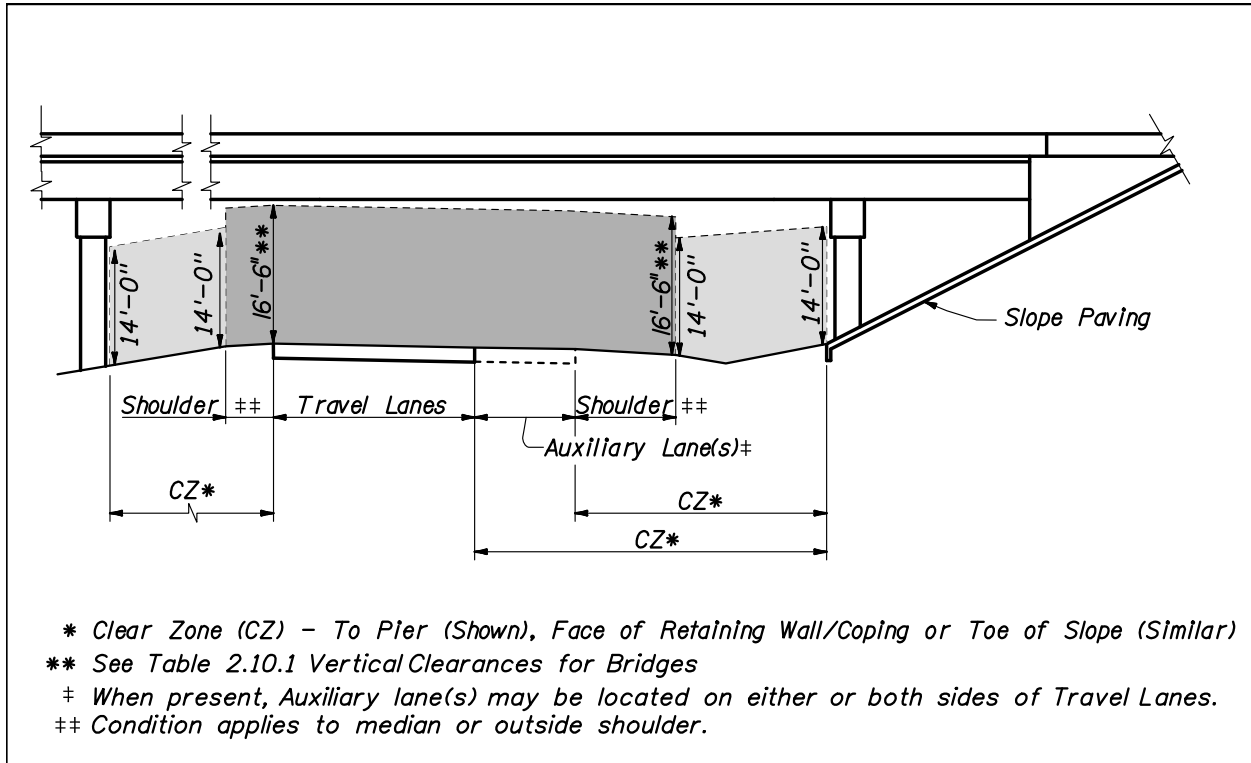
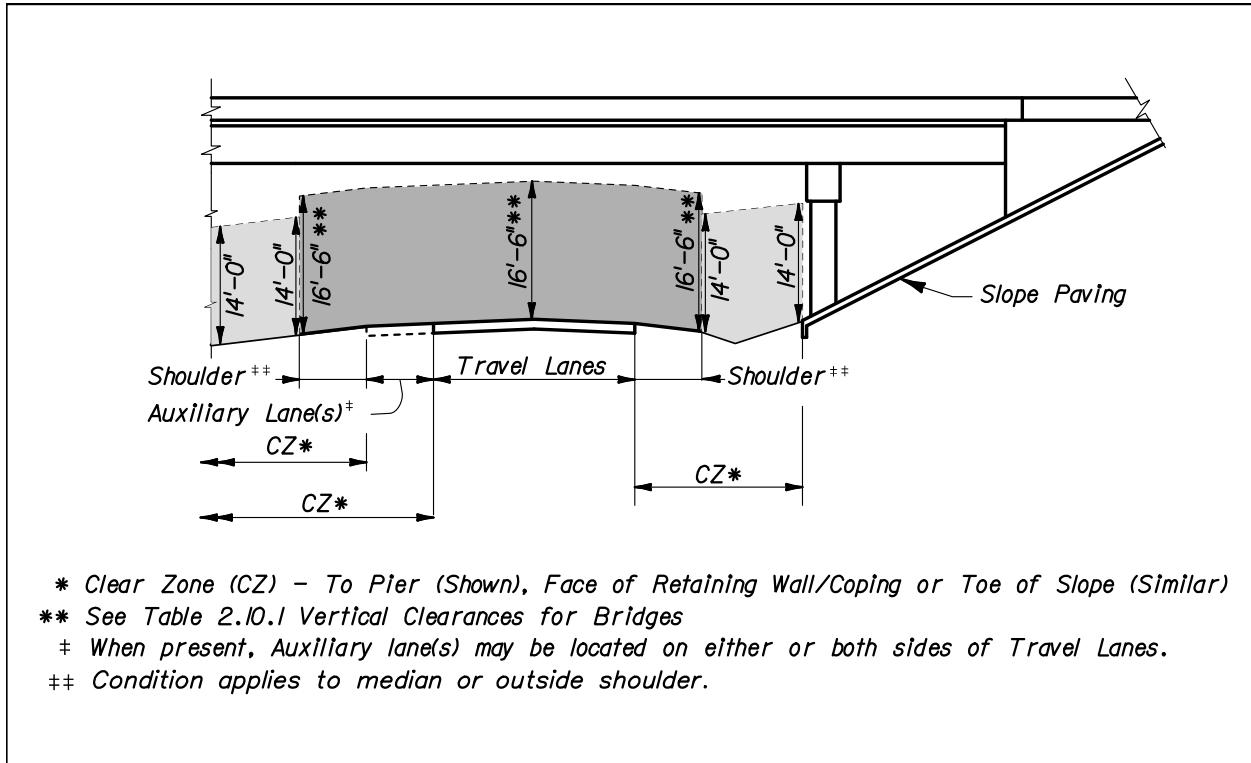
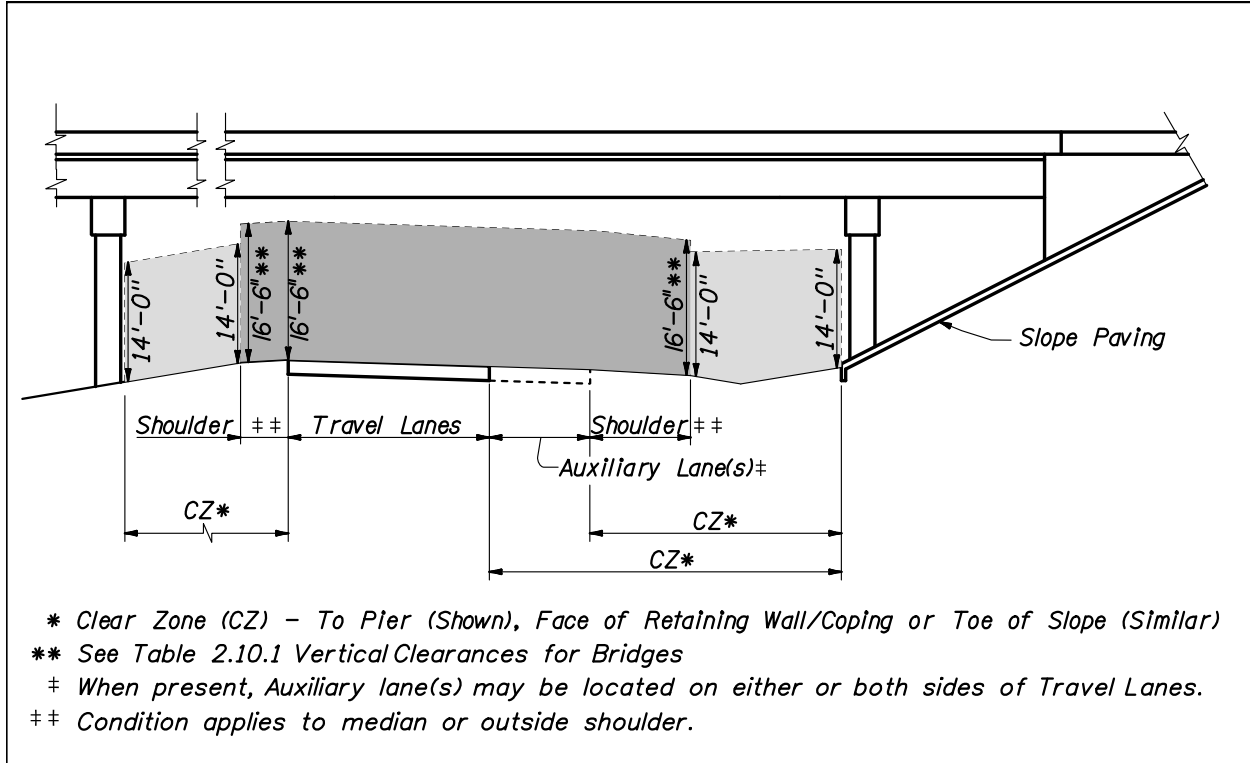

Figure 2.10.2 Clearances – Rural Arterials and Collectors with Projected 20-Year ADT of Less than 1500



**Figure 2.10.3 Clearances – Urban Arterials and Collectors
(Without Curb and Gutter) with Projected 20-Year ADT of Less than 1500**



**Figure 2.10.4.A Clearances – Urban Arterials and Collectors
(Curb and Gutter) ≤ 45 mph – Elevation of Bridge**

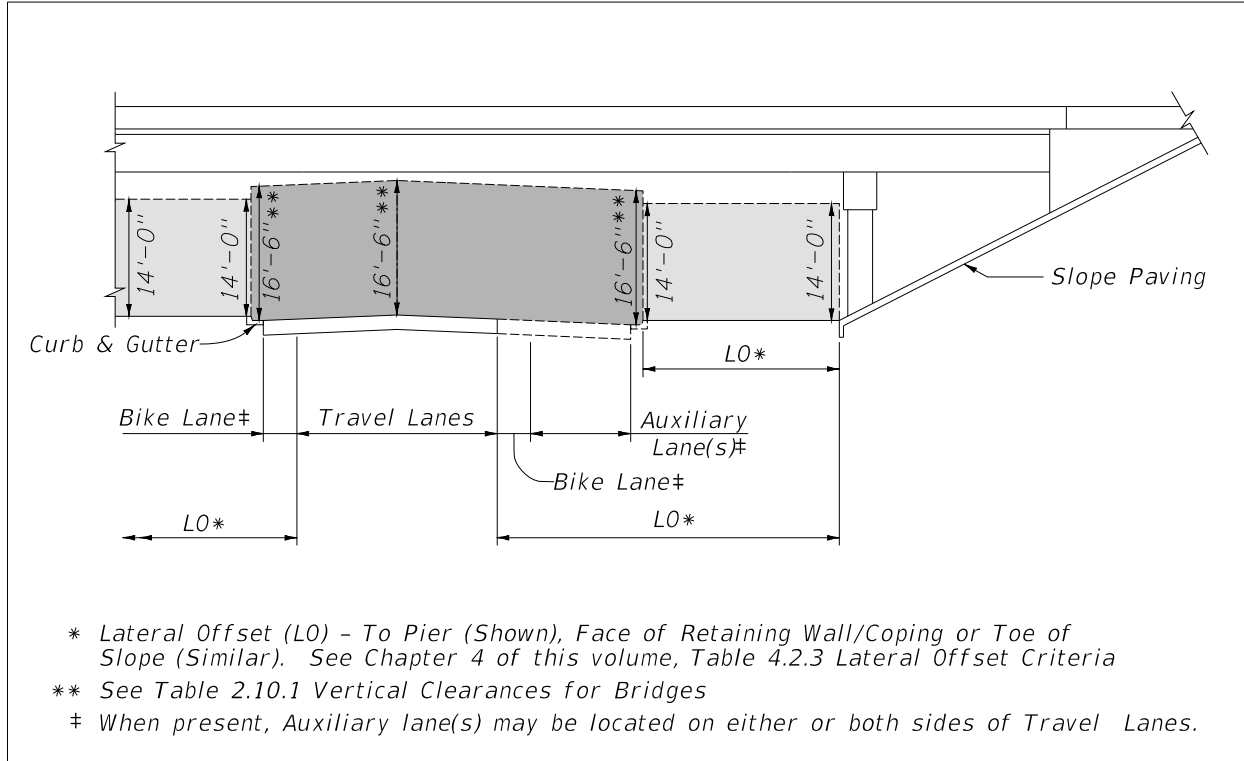

Figure 2.10.4.B Clearances – Urban Arterials and Collectors (Curb and Gutter) ≤ 45 mph – Section through Bridge

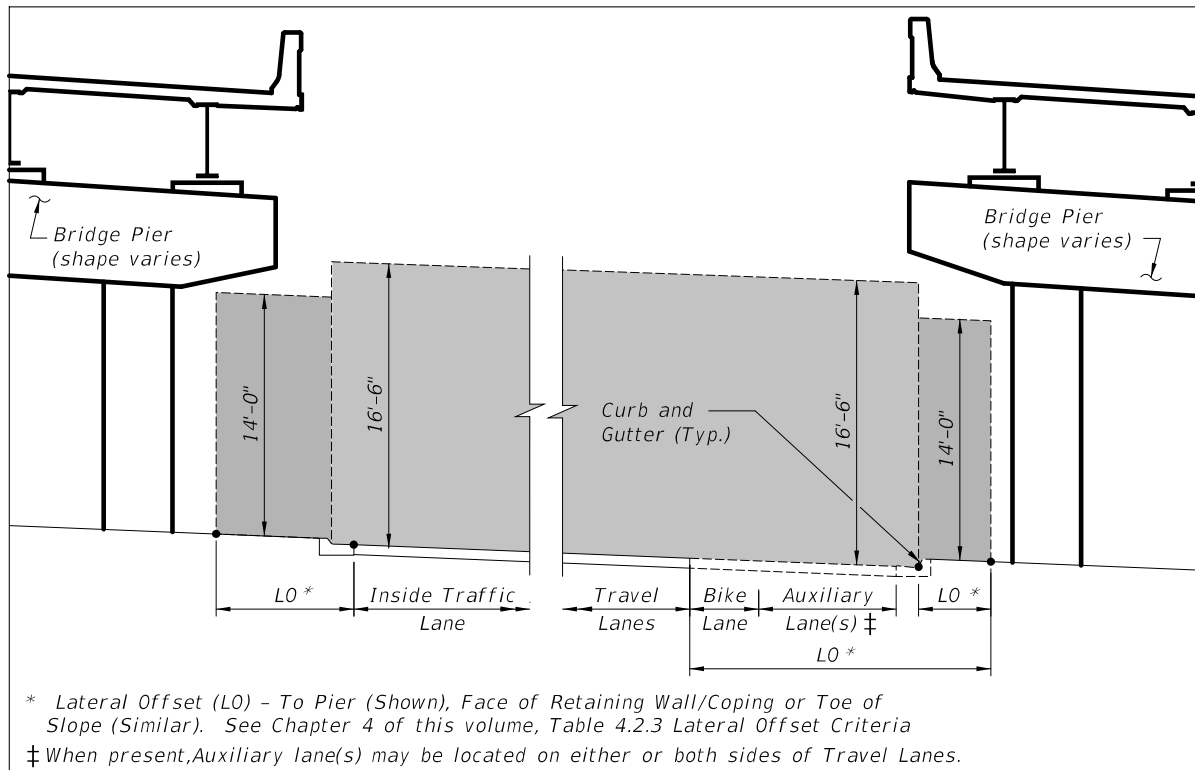

Figure 2.10.5 Clearances – Urban Arterials and Collectors (Curb and Gutter) with Traffic Barrier

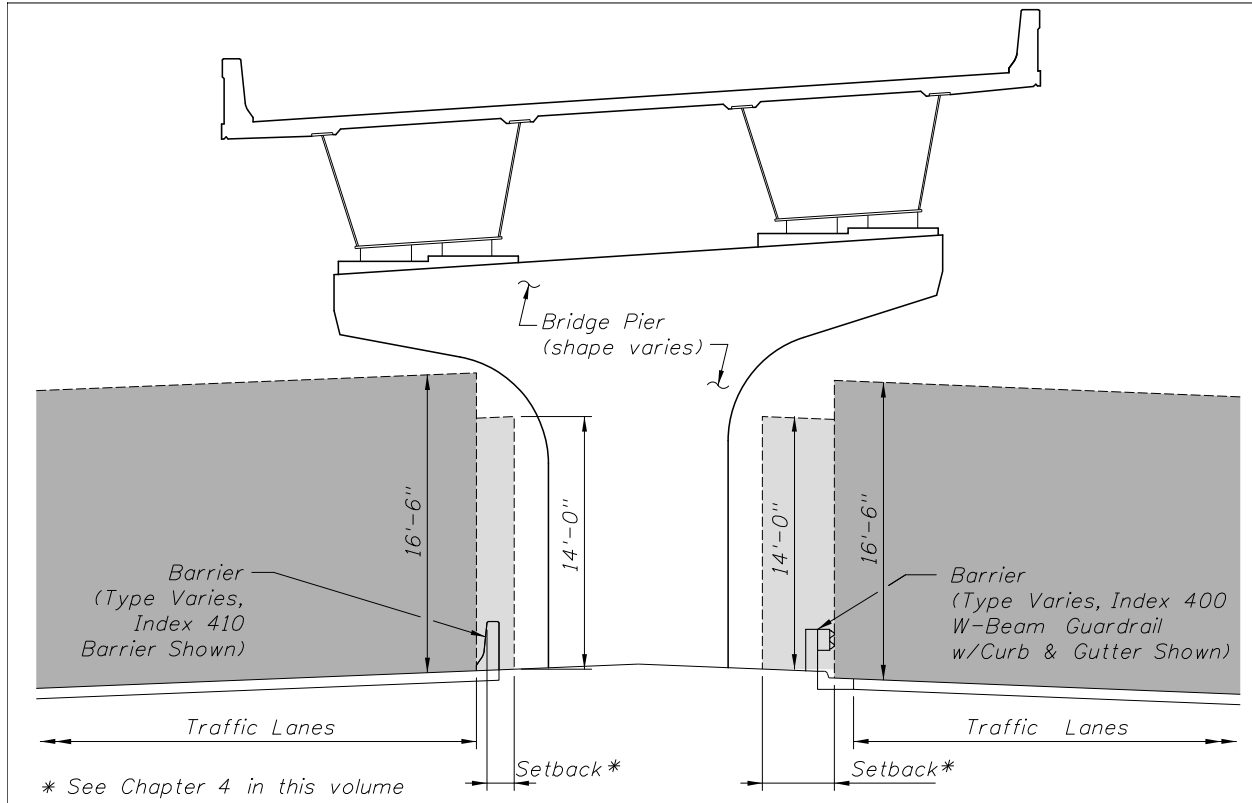

Table 2.10.1 Minimum Vertical Clearances for New Bridges

FACILITY TYPE (Freeways, Arterials, Collectors & Others) ¹	CLEARANCE
Roadway Over Roadway or Railroad Over Roadway	16'-6"
Roadway Over Railroad or Pedestrian Over Railroad	23'-6" ²
Pedestrian Over Roadway	17'-6"

1. For Clearance Over Waterways, see **Section 2.10.1** of this volume.
2. Over High Speed Rail Systems, see **Section 6.3.5** of this volume and the latest version of **American Railway Engineering and Maintenance-of-Way Association (AREMA)** guidelines, or the design office of the high speed rail line of interest for specific guidelines and specifications. Over Electrified Railroad, the minimum vertical clearance is 24 feet 3 inches. (See **Topic No. 000-725-003: South Florida Rail Corridor Clearance.**) Also see **Section 6.3.5** of this volume.

Table 2.10.2 Minimum Vertical Clearances for New Sign and Signal Structures

TYPE OF STRUCTURE	CLEARANCE
Overhead Sign Structures	17'-6"
Overhead Dynamic Message Sign Structures (Walk-in Type)	19'-6"
Signals on Span Wires, Mast Arms, or Other Structures	17'-6"

2.10.1 Vertical Clearance Over Water

The following criteria applies to the minimum vertical clearance over water:

1. **Environment:**

For concrete superstructures classified as moderately aggressive or extremely aggressive due to chloride content, the minimum vertical clearance is 12 ft. above Mean High Water (MHW).

Obtain the minimum vertical clearance for steel superstructures from the District Bridge Maintenance Engineer. This vertical clearance cannot be less than the above-specified clearance for concrete superstructures.

Modification for Non-Conventional Projects:

Delete the above paragraph and replace with the following:

For steel superstructures, the vertical clearance cannot be less than the above-specified clearance for concrete superstructures or as specified in the RFP.

2. **Drainage:**

The minimum vertical clearance between the design flood stage and the low member of bridges is two feet. This clearance is necessary to allow the majority of debris to pass without causing damage to the structure. This standard does not apply to culverts and bridge-culverts.

3. **Navigation:**

Provide the following minimum vertical clearance for navigational purposes:

- A. 6 feet above the Mean High Water for tidewater bays and streams
- B. 6 feet above the Normal High Water for freshwater rivers, streams, non-regulated/controlled canals, and lakes
- C. 6 feet above the control elevation for regulated/controlled lakes and canals

Minimal vertical at the navigable channel clearance is measured from the low point of the structural member of the bridge. Navigation lights are not considered in the vertical clearance.

Coastal bridges:

The vertical clearance of the superstructure must be a minimum of 1 ft. above the 100-year design wave crest elevation including the storm surge elevation and

wind setup. For bridge designs where this criterion cannot practically be met, refer to the ***FDOT [Drainage Manual](#), Section 4.9.5.***

Information on the Normal High Water, control water elevation, or Mean High Water can be obtained from the appropriate Drainage Design Engineer.

Widening of existing structures which do not meet the minimum vertical clearance criteria stated above (either before or after the widening) may be justified hydraulically and/or economically. However, the encroachment of vertical clearance criteria may be limited and must be approved by the agency having jurisdiction over the navigable waterway.

2.10.2 Horizontal Waterway Clearance

Provide the following minimum horizontal clearance:

1. 10 feet for crossings subject to boat traffic.
2. Consistent with debris conveyance needs and structure economy where no boat traffic is anticipated.

Horizontal clearance is defined as the unobstructed clear distance between piers, fender systems, culvert walls, etc. projected by the bridge normal to the flow.

2.10.3 Regulatory Agency Requirements

Vertical and horizontal clearances will also be subject to the requirements of the Coast Guard, Corps of Engineers, Water Management District, and any other regulatory agency having appropriate statutory jurisdiction or authority. Such regulatory agency requirements may exceed Department requirements.

2.10.4 Airspace Obstructions

Federal, state, and local regulations exist to protect the national airspace system. These regulations must be considered when planning and implementing construction that may adversely impact military or public-use aviation facilities (airport, seaport, or heliport), navigational aids, and instrument approach flight procedures in Florida.

FAA Notification:

Federal law, *Title 14 Code of Federal Regulations (CFR), Federal Aviation Regulations (FAR), "Part 77—Safe, Efficient Use, and Preservation of the Navigable Airspace"* requires that prior notification be given to the Federal Aviation Administration (FAA) regarding any construction or alteration (permanent or temporary) of structures that meet the specific criteria given in **Table 2.10.3**. Coordinate with the District Aviation Coordinator when a project is within 5 miles of an airport.

The FAA provides a Notice Criteria Tool via the Obstruction Evaluation/Airport Airspace Analysis (OE/AAA) website that can be used to determine whether notice is required. Refer to the OE/AAA Website (<https://oeaaa.faa.gov/>) for more information.

For further guidance on airspace obstructions (notification and permitting) refer to **Section 13.5.1, FDOT Aviation and Spaceports Office Coordination**, this volume.

Modification for Non-Conventional Projects:

See RFP for design build coordination of air space requirements.

Table 2.10.3 FAA Notification Requirements

FAA Notification Requirements for Construction or Alteration of Structures *	
1.	Any structure more than 200 feet above ground level (AGL) at its site.
2.	Any structure that is near an aviation facility and that penetrates an imaginary obstacle surface extending outward and upward at one of the following criteria: <ul style="list-style-type: none"> a. A slope of 100 to 1 (1 foot upward for each 100 feet outward) for a horizontal distance of 20,000 feet from the nearest point of the nearest military or public-use airport runway that is more than 3,200 feet in length (excludes heliports). b. A slope of 50 to 1 (1 foot upward for each 50 feet outward) for a horizontal distance of 10,000 feet from the nearest point of the nearest military or public-use airport runway no more than 3,200 feet in length (excludes heliports). c. A slope of 25 to 1 (1 foot upward for each 25 feet outward) for a horizontal distance of 5,000 feet from the nearest point of the nearest military or public-use heliport landing and takeoff area.
3.	Any highway, railroad, or other traverse way for mobile objects, of a height which, if adjusted upward by the amount shown below, would exceed a standard of paragraph 1 or 2 above: <ul style="list-style-type: none"> a. An adjusted height of 17 feet for an Interstate Highway that is part of the National System of Military and Interstate Highways where over-crossings are designed for a minimum of 17 feet vertical distance. b. An adjusted height of 15 feet for any other public roadway. c. An adjusted height of 10 feet or the height of the highest mobile object that would normally traverse the road, whichever is greater, for a private road. d. An adjusted height of 23 feet for a railroad. e. An adjusted height equal to the height of the highest mobile object that would normally traverse it, for a waterway or traverse way not previously mentioned.
4.	Any structure located directly on a public-use aviation facility property, including any facility that is currently existing, planned, proposed, or under construction.
5.	Any structure that is located in an instrument approach area and available information indicates it might exceed federal obstruction standards, if specifically requested by the FAA.
<p>* Note: Structures may include: Highways, roads, railroads, waterways, traverseways (parking or rest areas), bridges, overpasses, high-mast light poles, utility poles, antenna towers, buildings, signs or billboards, fences, or gates, plus temporary-use construction materials or equipment, including dirt piles and cranes, as well as natural growth, vegetation, and landscaping, depending on location in proximity to an aviation facility, navigational aid, or instrument procedure ground track.</p>	

2.11 Bridge Sections

Criteria regarding lanes, medians, and shoulders for various facilities is provided in the following partial bridge sections, **Figures 2.11.1 – 2.11.4**. Specific information and criteria regarding other typical section elements, as well as geometric features of bridges are found in the other sections of this chapter.

Figure 2.11.1 Partial Bridge Sections *

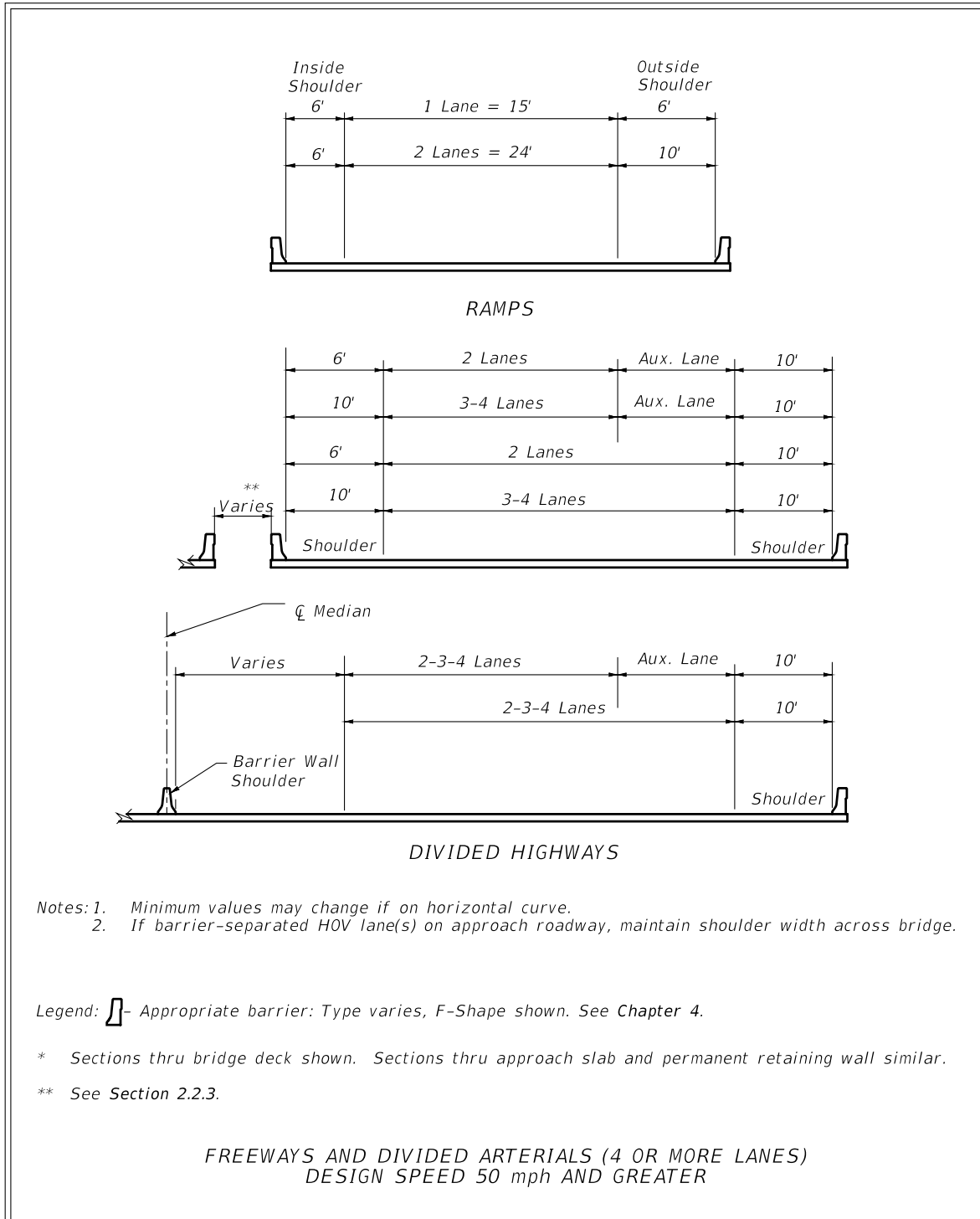

Figure 2.11.2 Bridge Section *

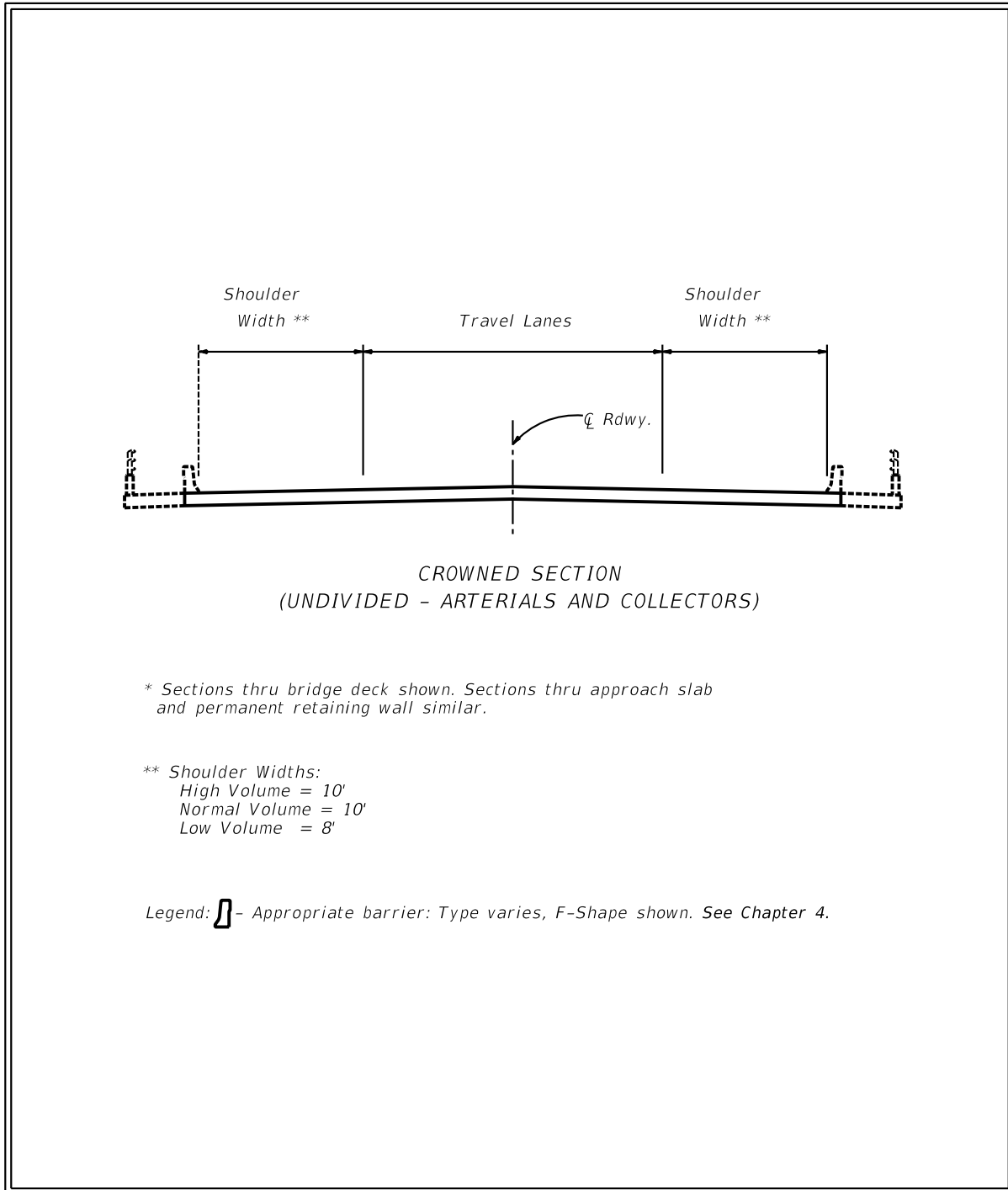

Figure 2.11.3 Partial Bridge Sections *

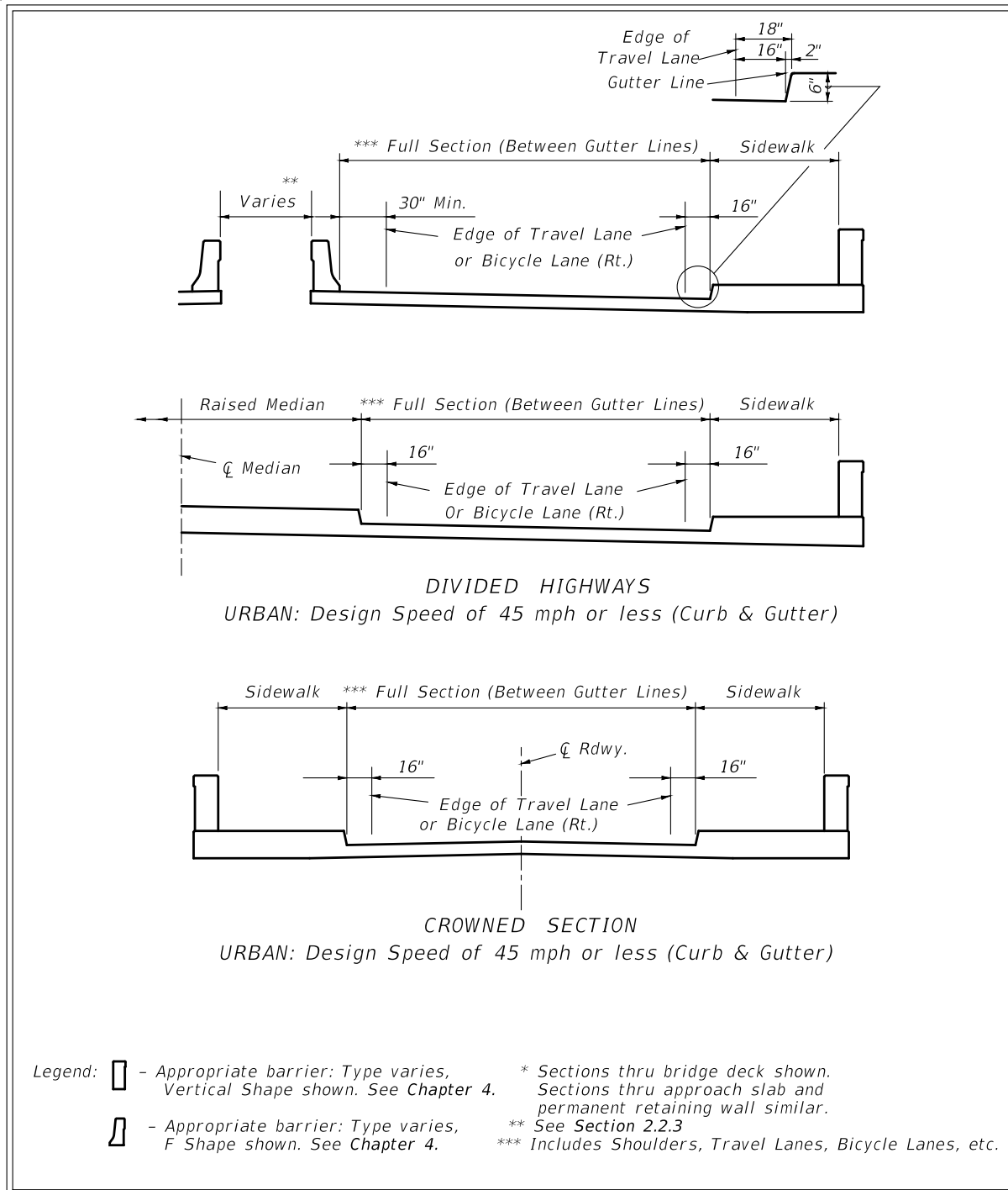
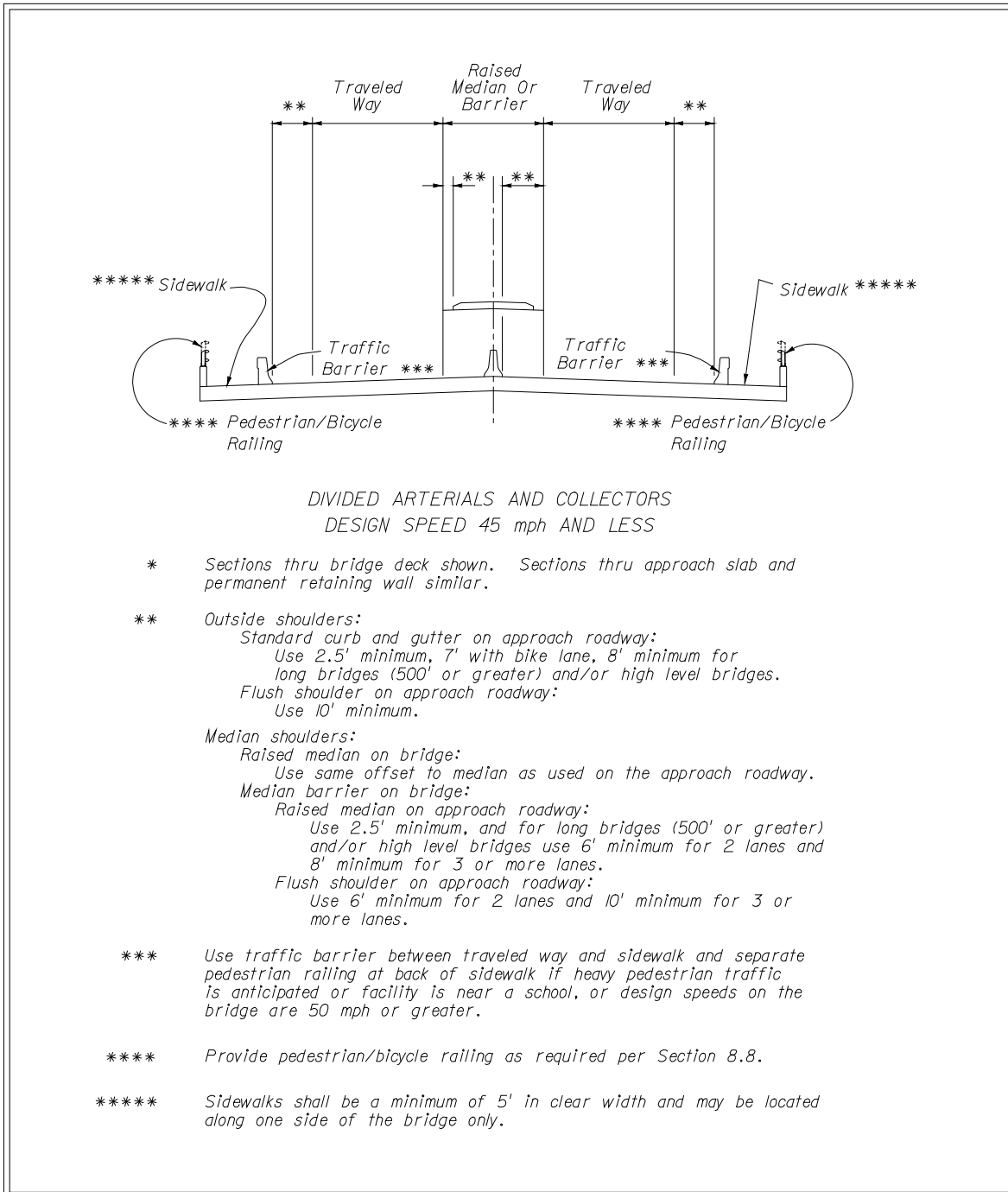

Figure 2.11.4 Bridge Section *



2.12 Bridge Railings and Separators

Design bridge railings and separators on new and reconstruction projects in accordance with the ***Structures Design Guidelines***. For more information regarding bridge traffic railings, refer to ***Chapter 4*** of this Volume.

2.13 Intersections

Design guides and criteria presented heretofore are also applicable to the proper design of intersections.

2.13.1 Roundabouts

The [*National Cooperative Highway Research Program \(NCHRP\) Report 672, Roundabouts: An Informational Guide*](#), is adopted by FDOT and establishes criteria and procedures for the operational and safety analysis of modern roundabouts in the United States. In addition, the [*Florida Intersection Design Guide*](#) contains Florida centric guidelines and requirements for evaluation and design of roundabouts in Florida.

Evaluate a roundabout alternative on new construction and reconstruction projects. An evaluation is also required for projects that propose new signalization or require a change in an unsignalized intersection control. An evaluation is not required for minor operational improvements such as changes to signal phasing, or for signal replacement projects where the primary purpose is to upgrade deficient equipment and installations.

A minimum of one of the following criteria must be met to construct a roundabout on the state highway system:

- **MUTCD** traffic signal warrants 1 or 2 is met.
- Documented high frequency of severe crashes.
- Context Sensitive Solution for the implementation of Complete Streets on a low speed facility.

While roundabouts may provide a community enhancement, they are not to be constructed on state roads solely for this purpose.

Use 20 year design traffic for roundabout evaluation and design. Roundabouts are not to be considered at locations where the design year total traffic volume entering the roundabout exceeds 25,000 AADT for a single-lane, or 45,000 AADT for two lanes.

Design roundabouts on state highways to accommodate the WB-62FL design vehicle.

Roundabout design must be approved by the State Roadway Design Engineer. See **Volume 2, Section 2.3.3** for the roundabout review submittal.

Modification for Non-Conventional Projects:

Delete the second paragraph above and see the RFP for requirements.

2.13.1.1 Truck Apron

A standard truck apron design to be used on the state highway system is presented in **Figure 2.13.1**.

Figure 2.13.1 Standard Truck Apron Design

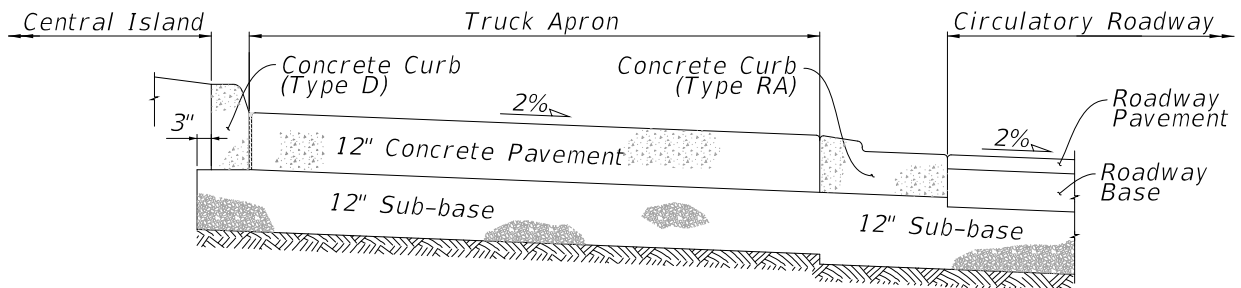

2.13.1.2 Lighting

Provide the minimum standard of lighting of 1.5 foot-candles on the roadway surface within the circulatory roadway, and at least 250 feet in advance of the yield lines on the approach roadways.

See **Chapter 7** of this volume for pedestrian lighting requirements.

2.13.1.3 Landscaping

Provide landscaping in the central island of roundabouts to increase visibility for approaching traffic. Follow guidance given in [NCHRP Report 672](#), **Chapter 9** when developing landscaping plans.

Coordination of landscape design in the early stages of plan development will assure that landscaping will be fully integrated into the roundabout design and all lighting and sight distance requirements will be satisfied. A landscaping maintenance agreement should be sought with the local agency when appropriate. When landscaping is to be maintained by FDOT, coordinate the proposed landscape design with District Maintenance staff.

See Chapter 9 of this Volume for additional Landscaping requirements.

2.13.1.4 Pavement Markings

A standard left-turn arrow with a dot, as shown in **Figure 2.13.2**, on the left-most lane of the approach to a multi-lane roundabout is recommended. Use standard arrows within the circulatory roadway.

Figure 2.13.2 Roundabout Approach Arrow

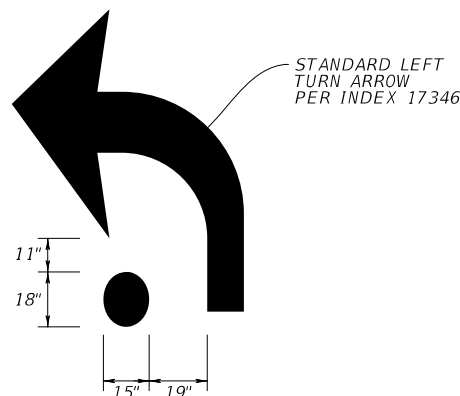

2.13.2 Queue Length for Unsignalized Intersections

Turn lanes should comply with the [Design Standards, Index 301](#) to the extent practical. The queue length provided should be based on a traffic study.

For low volume intersections where a traffic study is not justified, a minimum queue length of 50 ft. (2 vehicles) should be provided for rural areas and small urban areas; for other urban areas, a minimum queue length of 100 ft. (4 vehicles) should be provided.

2.13.3 Offset Left Turn Lanes

The alignment of opposing left-turn lanes and the horizontal and vertical curvature on the approaches are the principal geometric design elements that determine how much sight distance is available to a left-turning driver. Operationally, vehicles in the opposing left-turn lane waiting to turn left can also restrict the left-turning driver's view of oncoming traffic in the through lanes. The level of blockage depends on how the opposing left-turn lanes are aligned with respect to each other, as well as the type/size of vehicles in the opposing queue and their position in the opposing lane.

The offset distance is defined as the distance between the left edge of the turn lane and the right edge of the opposing turn lane. If the offset distance is to the left of the turn lane it is considered a negative offset, and if it is to the right of turn lane it is considered a positive offset.

The conventional method of designing left turn lanes is to place the left turn lanes adjacent to the through lanes. This design creates a negative offset which severely restricts the sight distance of the left-turning driver's view of oncoming traffic when another vehicle is in the opposing turn lane. **Figure 2.13.3** indicates the negative offset when the conventional design is used.

Figure 2.13.3 Typical Opposing Left Turns (22' Median with Negative 10' Offset)

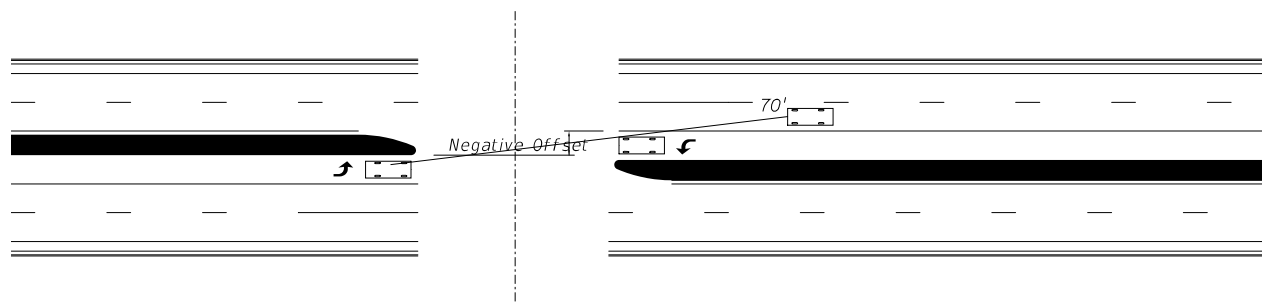

Consider using offset left-turn lanes on urban designs where median widths exceed 18 feet. Provide a four-foot traffic separator to channelize the left turn and provide separation from opposing traffic where adequate R/W exists.

Also consider offset left-turn lanes at rural intersections with high turning movements. For median widths 30 feet or less, use a parallel offset left-turn lane. Stripe the area between the offset left-turn lane and the traffic lane where vehicles are moving in the same direction. For medians wider than 30 feet, consider a tapered offset left-turn lane. **AASHTO Exhibit 9-98** illustrates the design of parallel and tapered left turn lanes. **Figure 2.13.4** indicates an offset left turn.

Figure 2.13.4 Typical Opposing Left Turns (22' Median with Negative 1' Offset)

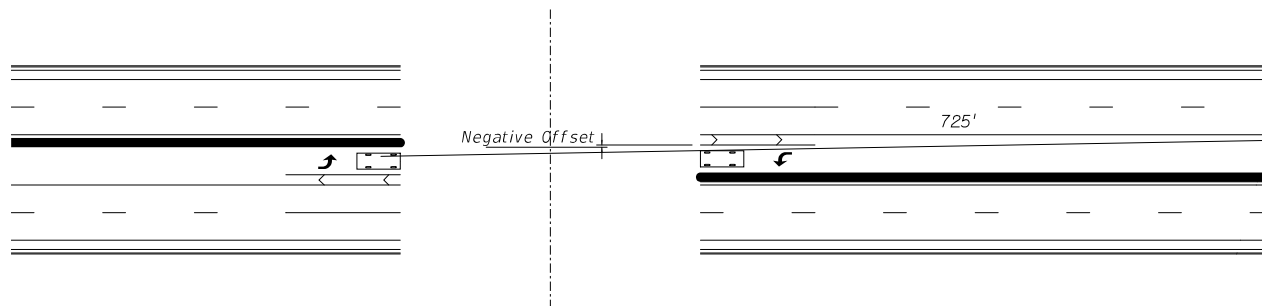

As illustrated in **Figure 2.13.4**, the sight distance is improved significantly by utilizing the offset left turn design even when a positive offset is not achieved. The graph in **Figure 2.13.5** is taken from the **Older Driver Highway Design Handbook**, and gives the left turn offset guidelines that may be considered for various design speeds and vehicle types.

Figure 2.13.5 Left Turn Offset Guidelines

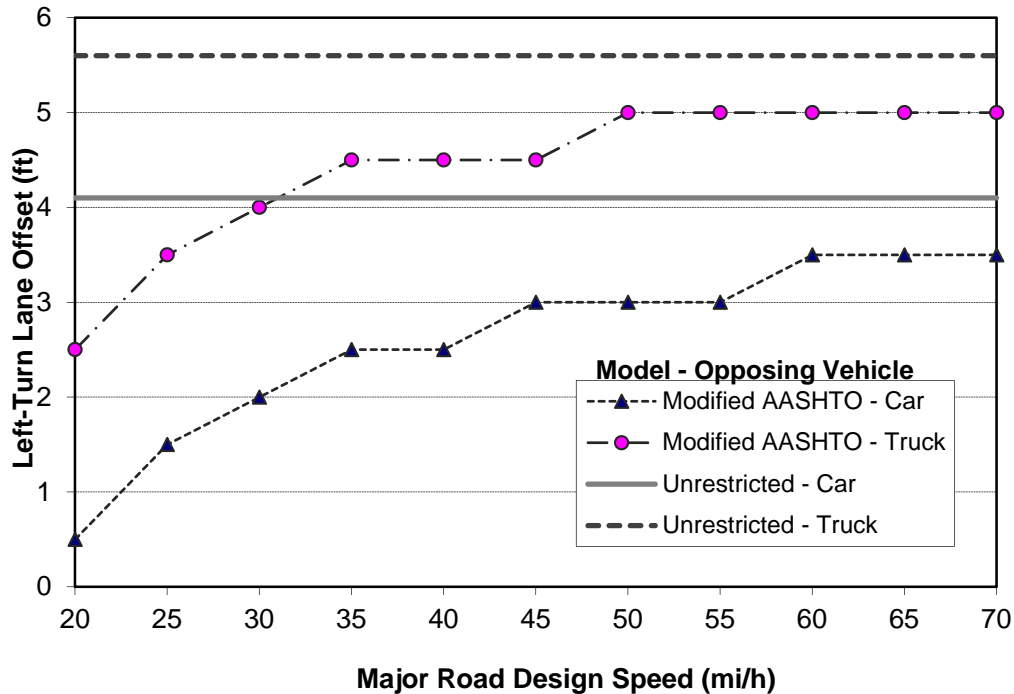

2.14 Interchanges and Median Openings/Crossovers

Design guides and criteria presented heretofore and in the [Design Standards](#) are also applicable to the proper design of interchanges with their inherent ramps, speed change, merging and weaving lanes. Where diamond ramps and partial cloverleaf arrangements intersect the crossroad at grade, an at-grade intersection is formed. In urbanized areas, high speed ramps, weaving areas and acceleration lanes are not appropriate. These ramp terminals should be designed as intersections consistent with the design speed and character of the roadway.

2.14.1 Limited Access Right of Way Limits at Interchanges

The following criteria will be used in establishing limited access limits along crossroads at interchanges:

1. For rural interchanges, limited access will extend along the crossroad to a point 300 ft. minimum beyond the end of the acceleration or deceleration taper. In the event these points are not opposite, the point most remote from the project will

be the control and the limited access on both sides will end at that station along the crossroad. Where no taper is used, the limited access will be carried to a point 300 ft. minimum beyond the radius point of the return. In this case also, the radius point most remote from the project will control.

2. For interchanges in urban areas, the criteria given above will apply except that the limited access will end a minimum of 100 ft. beyond the end of taper or the radius point of the return.
3. For unsymmetrical interchanges such as half-diamonds and partial clover leafs, etc., the limited access right of way along the crossroad on that side having no ramp will extend to a point opposite that point controlled by the ramp.
4. Limited access along crossroads overpassing limited access facilities (with no interchange) must be extended approximately 200 feet, measured from the mainline right of way line, along the crossroad. This distance may be reduced or omitted if the crossroad profile provides adequate sight distance for existing or proposed driveways. The fence is generally tied into the crossroad structure end bent unless required along the crossroad.
5. Any reduction in the values shown above for limited access limits must be approved by FHWA for interstate projects and by the District Design Engineer for non-interstate limited access facilities.

Access Management Rule 14-97 standards **14-97.003(3)** regulate the location of driveway connections and median openings in interchange areas on arterial roads. This standard should be applied in accordance with the District procedures for implementing the Rule, and should not be confused with minimum requirements for limited access right of way.

2.14.2 Median Openings at Interchanges

Median opening locations at interchanges on arterial roads must consider **Access Management Rule 14-97.003(3)(h) Interchange Areas** which states:

“Connections and median openings on a controlled access facility located up to 1/4 mile from an interchange area or up to the first intersection with an arterial road, whichever distance is less, shall be more stringently regulated to protect safety and operational efficiency of the SHS, as set forth below:

1. The 1/4 mile distance shall be measured from the end of the taper of the ramp furthest from the interchange.
2. With the exception of Access Class 2 facilities with posted speed limits over 45 MPH, the distance from the interchange ramp(s) to the first connection shall be at least 660 feet where the posted speed limit is greater than 45 MPH, or at least 440 feet where the posted speed limit is 45 MPH or less. This distance will be measured from the end of the taper for that particular quadrant of the interchange on the controlled access facility. For Access Class 2 facilities with posted speed limits over 45 MPH, the distance to the first connection shall be at least 1,320 feet.
3. The standard distance to the first full median opening shall be at least 2,640 feet as measured from the end of the taper of the off ramp.
4. Greater distances between proposed connections and median openings will be required when the Department determines, based on generally accepted professional practice standards, that the engineering and traffic information provided in the Rule Chapter 14-96, F.A.C., permit application shows that the safety or operation of the interchange or the limited access highway would be adversely affected.”

2.14.3 Ramp Widths

Ramp widths for interchange ramp terminal design are given in **Table 2.14.1**.

Table 2.14.1 Ramp Widths - Turning Roadways

RAMP WIDTHS			
RADIUS To Inside of Curve (FEET)	1-LANE ₃		2-LANE
	Traveled Way Width ₁ Case I-C ₂ One-lane, one-way operation – no provision for passing a stalled vehicle	Traveled Way Width ₁ + Outside Paved Shoulder Width Case II-B ₂ One-lane, one-way operation – with provision for passing a stalled vehicle	Traveled Way Width ₁ Case III-A ₂ Two-lane operation – either one-way or two-way
	FEET		
50	23	26	29
75	20	23	27
100	18	22	26
150	17	21	24
200	16	20	24
300	15	20	24
400	15	19	24
≥ 500	15	19	24

For widths on the ramp proper, see **Table 2.1.3**.

For case application, see **AASHTO** and the [Design Standards, Index No. 525](#).

- AASHTO adjustments do not apply.
- Note: A = Predominantly P vehicles, but some consideration for SU trucks.
 B = Sufficient SU vehicles to govern design, but some consideration for semitrailer combination trucks.
 C = Sufficient bus and combination trucks to govern design.
- Where accommodation of future resurfacing is a factor, consideration should be given to increasing the minimum width to 24 ft. where practical.

2.14.4 Crossovers on Limited Access Facilities

Permanent crossovers on freeways are sometimes necessary to avoid excessive travel distances for emergency vehicles, law enforcement vehicles, and maintenance vehicles. Median crossings will be allowed only when there is a clear documented request and need for such a feature; however they must be limited in number and very carefully located. The location of crossovers used for maintenance purposes should consider the needs of emergency and law enforcement vehicles and vice versa. Permanent crossovers should conform to the recommendations of **AASHTO's "Geometric Design of Highways and Streets"** (see Rural Freeway Medians). The location of all crossovers requires approval of the District Design Engineer. Note, this criteria does not apply to contra flow crossovers placed for facilitating hurricane evacuation, nor does it apply to temporary construction crossovers. For temporary construction crossovers, please see [Design Standards, Index Numbers 630 and 631](#).

The following AASHTO crossover recommendations are requirements on FDOT's Limited Access Facilities:

1. Not spaced closer than 3.0 miles apart.
2. Located only in areas with above-minimum stopping sight distance and without superelevated curves.
3. Not located within 1,500 feet of the end of a speed-change taper (of a ramp or facility widening/narrowing) or any structure (bridge, overpassing facility or overhead sign).
4. Not located where the median width is less than 25 feet.

Crossover locations that do not meet the above criteria require approval by the State Roadway Design Engineer and FHWA (FHWA on Interstate facilities only).

The following additional criteria are also placed on crossovers designed for FDOT's Limited Access Facilities:

1. Not located within 1.5 miles of any interchange.
2. Not located where the median width is less than 40'.
3. Not located in urban areas
4. Where continuous median barrier is present, openings for crossovers should not be greater than 5.0 miles apart between Interchanges.

Crossovers that do not meet these additional criteria require approval by the District Design Engineer.

Typical layouts for the design of median crossovers are provided in **Figures 2.14.1, 2.14.2** and **2.14.3**. These typical layouts will not cover all situations, but are provided as a guide for developing site-specific designs. Designs should accommodate the types of emergency vehicles expected to use the crossover. Law enforcement vehicles and typical ambulance sized vehicles can usually be easily accommodated. The typical layouts in **Figures 2.14.1, 2.14.2** and **2.14.3** will accommodate an SU design vehicle. To the extent practical, designs should accommodate larger emergency response vehicles such as fire trucks. This will require acquiring information from local emergency responders on the size and configuration of vehicles used. Except where median widths are wider than normal, fire trucks and other larger vehicles will likely not be able to make u-turns without encroaching or crossing travel lanes. As a minimum, designs should provide for the necessary minimum radii and width to allow the largest design vehicle to enter the crossover and stop as close to perpendicular to traffic as practical. All designs should be tested by superimposing the turning path of the design vehicle to insure the crossover will operate as expected.

On Interstate facilities, the Federal Highway Administration directs that median shoulders approaching the crossover utilize the standard shoulder width, or existing shoulder width. The FHWA believes the safety benefits derived by making the crossovers appear less conspicuous outweigh the benefits obtained by providing paved shoulders to accommodate acceleration and deceleration lanes for emergency vehicles, law enforcement, or other authorized vehicles.

Design the profile of the crossover to conform as close as practical with travel way shoulder slopes and median side slopes so that the crossover is inconspicuous as possible to traffic. The paved width of the crossover should not be any wider than that necessary to provide for the largest design vehicle. Shoulder width for the crossover should be 8' minimum. Side slopes of the crossover (parallel with the mainline travel way) must be 1V:10H or flatter. However, side slopes may be transitioned to match the slope of a pipe culvert safety end treatment where a culvert crossing underneath the crossover is necessary to provide for proper median drainage.

In locations where a median barrier is present, the length of the barrier opening should be minimized to the extent practical. As shown in **Figure 2.14.3**, the barrier ends on each side of the opening should be offset to the extent practical. Provide crashworthy end treatments or crash cushions to shield the barrier ends when the ends are within the clear zone and fall within the departure angle used to set length of need. Provide crashworthy end treatments or crash cushions when the angle between barrier ends is less than 30 degrees measured from the direction of mainline travel (see **Figure 2.14.3**).

Determine drainage requirements for each location and make appropriate provisions. The drainage culvert shown in the figures are for example only. Either a mitered end section (1:4) or preferably a u-endwall with grate (1:6) should be used for culverts parallel with the mainline. Note that in some cases existing median ditches are shallow and there will be minimal clearances available for even small size culverts. This requires that site-specific vertical and horizontal geometry be developed for each location rather than use a typical drawing.

A pavement design equivalent to a Limited Access shoulder pavement should be provided (1-1/2" Structural Course, Base Group 1 with a 12" Stabilized Subgrade).

Signing for permanent crossovers consists of a "No U-turn" sign (R3-4) with an "Official Use Only" plaque (FTP-65-06). To improve nighttime visibility for approaching emergency responders, install yellow RPM's placed outside the yellow edge line in advance of the crossover using the following pattern and spacing: 3 spaced 4" apart @ 1500', 2 spaced 4" apart @ 1000', and 1 @ 500' in advance of the crossover.

On reconstruction and RRR projects, evaluate the location of existing crossovers for conformance to the above criteria. Remove those that do not meet this criterion as a part of the project unless approved by the State Roadway Design Engineer and FHWA (FHWA approval on Interstate only).

Modification for Non-Conventional Projects:

Delete the last paragraph and replace with the following:

Evaluate the location of existing crossovers for conformance to the above criteria. Remove those that do not meet this criterion.

Figure 2.14.1 Crossovers on Limited Access Facilities – 6 or More Lanes

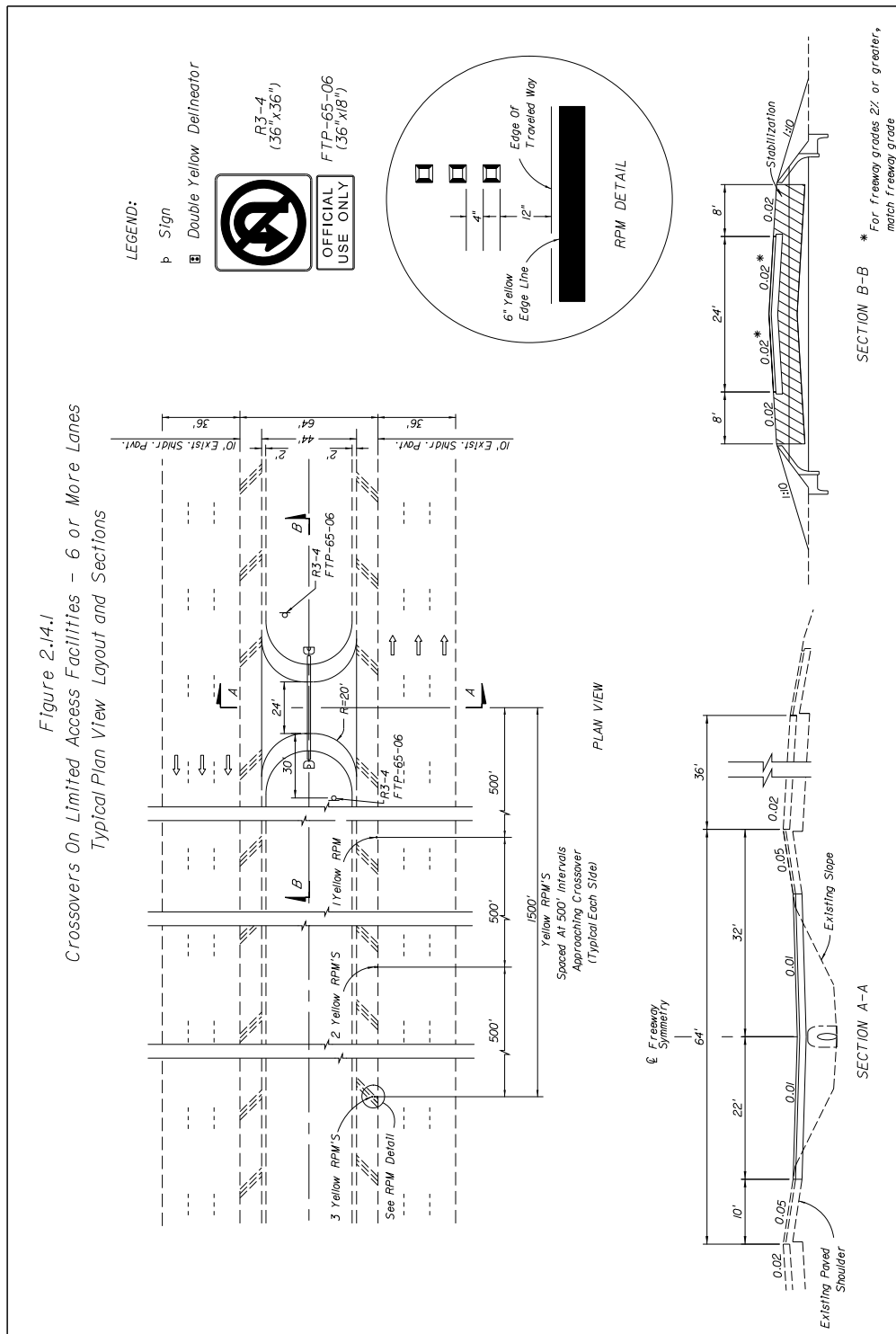

Figure 2.14.2 Crossovers on Limited Access Facilities – 4 Lanes

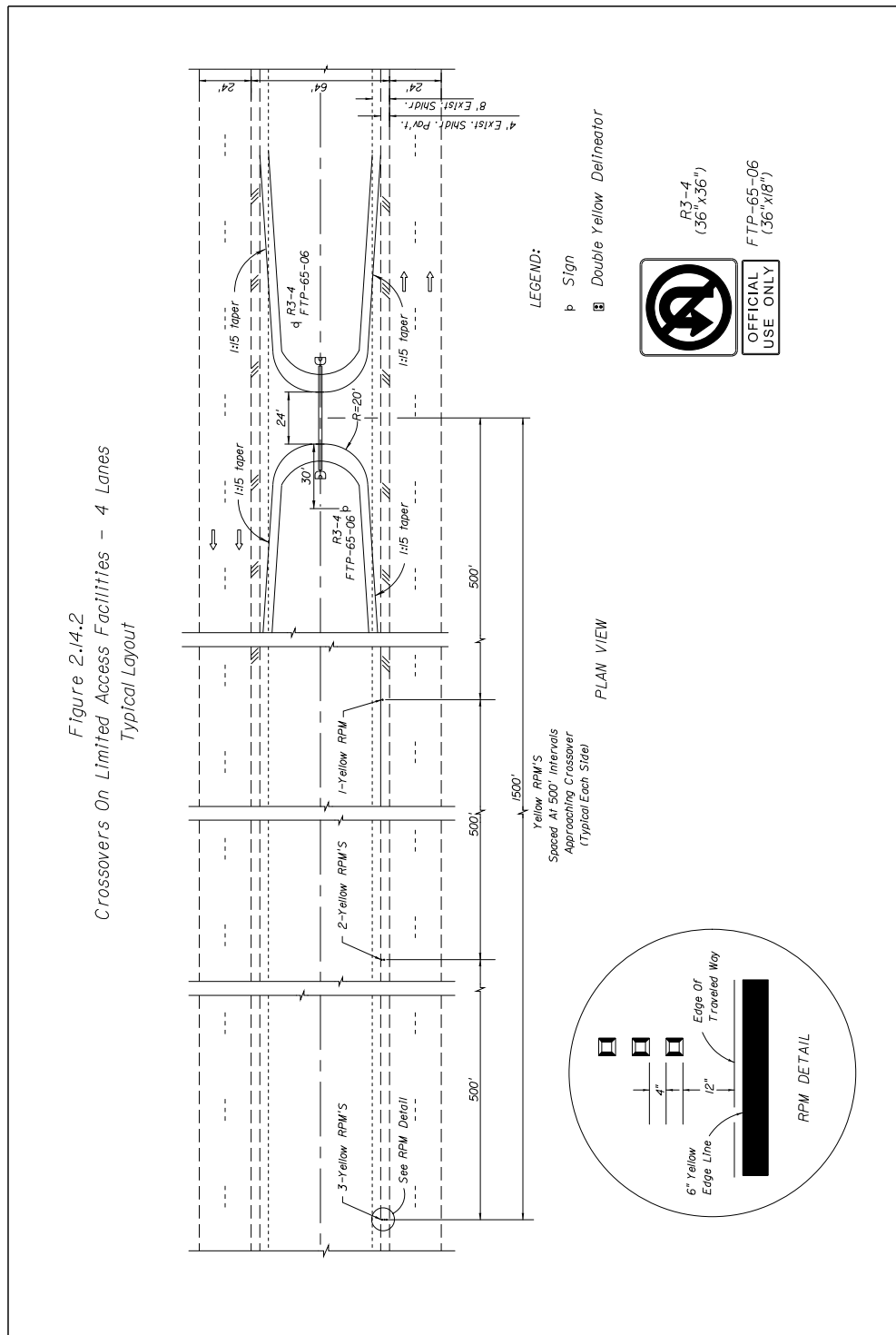
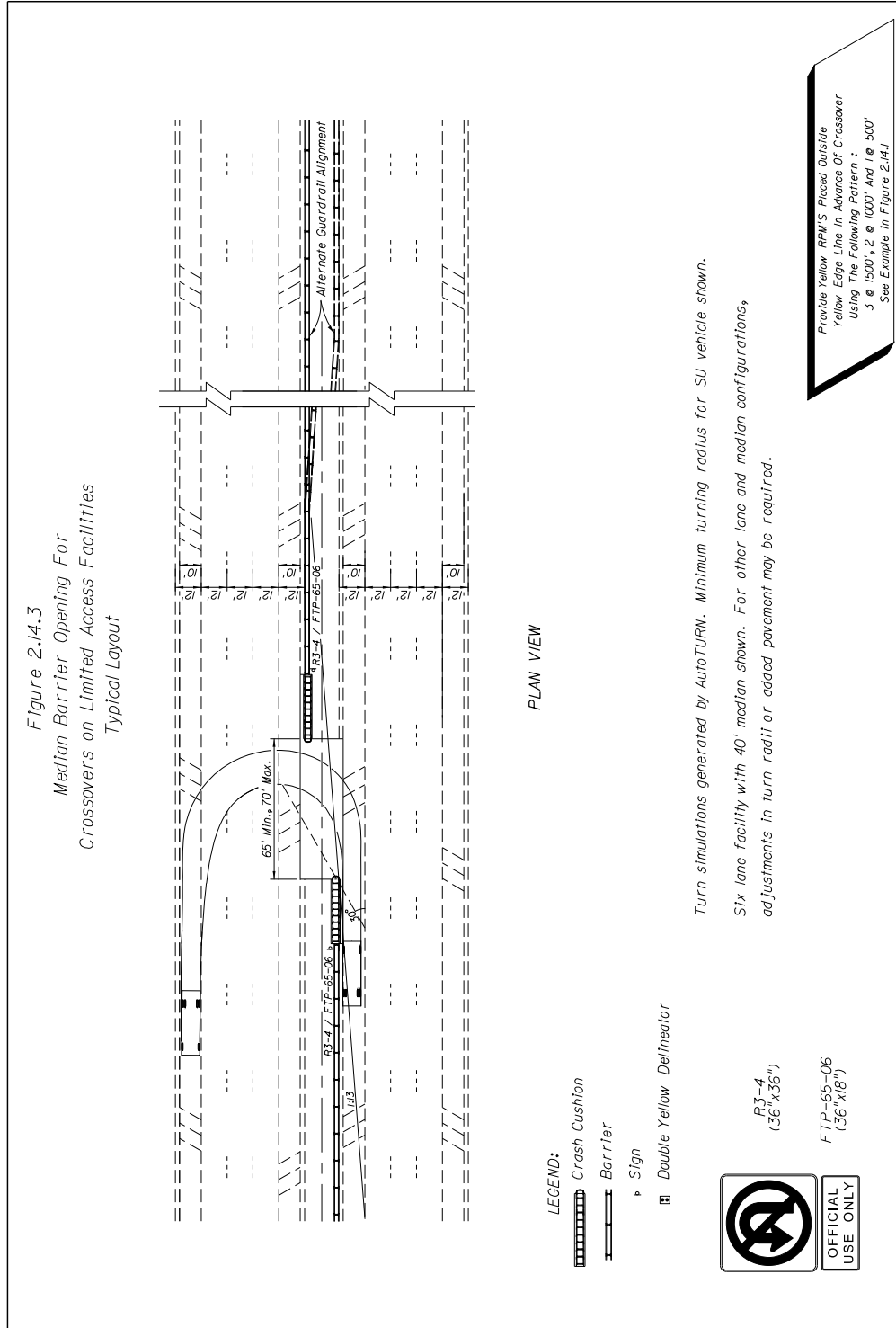

Figure 2.14.3 Median Barrier Opening for Crossovers on Limited Access Facilities



2.15 Lighting Criteria

Lighting Criteria is contained in **Chapter 7** of this volume.

2.16 High-Speed Urban and Suburban Arterial Highways

The two classifications of rural and urban are generally sufficient for the design of Florida's arterial highways; however, there are some areas that do not lend themselves to these classifications. These are transitional areas where conditions along the highway change from rural to urban or from urban to rural. Also, there are urban arterial highways where the anticipated operating speeds are higher than standard urban design speeds. Because of the undesirable effects of having curb and gutter on high speed highways, four-lane and six-lane high speed urban and suburban arterial highway typical sections have been developed to insure that these highways are designed consistently and to minimize the need to process design exceptions and variations. Typical sections for High-Speed Urban and Suburban Arterial Highways are located in **Chapter 6, Volume 2 Exhibits**.

Special design criteria in this section have been developed for these four-lane and six-lane high-speed urban and suburban arterial highways. For criteria and other guidance not listed below, the designer is to use the values that are commensurate with either a four-lane or six-lane rural arterial highway having the same design speed and traffic volumes. The use of these special criteria is restricted to facilities within FHWA Urban or Urbanized boundaries where right of way is constrained.

The design of the initial four-lane facility should also take into consideration the ultimate six-lane section that these roadways will have in the future. If an ultimate high speed six-lane section is planned, consideration should be made to acquire a minimum of 80 feet of right of way on each side and construction of 6.5-foot shoulders adjacent to the median as shown in the six-lane section. This can avoid future widening and curb relocation in the median as well as future right of way acquisition to obtain proper border and clear zone. In addition, special attention to the ultimate location of drainage structures, sidewalk offset and elevation, superelevation and curve radii can minimize the amount of reconstruction of these elements as well.

Modification for Non-Conventional Projects:

Delete the previous three paragraphs and see the RFP for requirements.

2.16.1 Design Speed

The maximum design speed of four-lane high-speed urban and suburban arterial highways is 55 mph. The maximum design speed of six-lane high-speed urban and suburban arterial highways is 50 mph.

2.16.2 Curbs

To minimize right of way requirements, the high-speed urban and suburban arterial highway typical section incorporates the use of curbs and a closed drainage system. The type of curb used within the clear zone on this section is restricted to the FDOT Type E shape (sloping curb not greater than 5 inches in height above adjacent pavement). This applies to both median and outside shoulder locations. Flush shoulders may be utilized on the outside as long as clear zone and other criteria requirements can be maintained. For additional information regarding curbs, see **Section 4.2.7.2** of this Volume.

2.16.3 Pedestrian and Bicycle Facilities

Include the following on four-lane and six-lane high-speed urban and suburban arterial highways:

- Sidewalks which provide accommodations for pedestrians
- Bicycle lanes which provide accommodations for bicyclists.

See **Section 2.16.5** and **Chapter 8** for additional information.

2.16.4 Medians

The minimum median width for four-lane and six-lane high-speed urban and suburban arterial highways may be reduced to 30 feet (inclusive of median shoulders) as opposed to 40 feet minimum required in **Table 2.2.1**. A 30-foot median provides sufficient width for a 30-foot clear zone. This median width also allows space at intersections for dual left turn lanes (11-foot lanes with 4-foot traffic separator), and directional median openings using 4-foot traffic separators. When this is done neither a Design Exception nor Design Variation is required.

Modification for Non-Conventional Projects:

Delete the previous paragraph and see the RFP for requirements.

2.16.5 Shoulders

The minimum median shoulder width for four-lane high speed urban and suburban arterial highways is 4 feet measured to the lip of the gutter. This provides for 5.5 feet of usable median shoulder to the curb face. The minimum median shoulder width for six-lane high-speed urban arterial highways is 6.5 feet measured to the lip of the gutter. This provides for 8 feet of usable median shoulder to the curb face. Under special circumstances (i.e., dual left turn lanes, directional median openings, etc.) it may be necessary to encroach into the median shoulder. In these locations only, the minimum median shoulder width may be reduced to 4 feet (measured to face of curb or separator) while maintaining the same median width.

Modification for Non-Conventional Projects:

Delete the last two sentences of the above paragraph.

The minimum outside shoulder width for four-lane and six-lane high speed urban and suburban arterial highways is 6.5 feet measured to the lip of the gutter. This provides for 8 feet of usable outside shoulder to the curb face.

For typical sections with outside flush shoulders refer to **Section 2.3** for required shoulder width.

2.16.6 Friction Course

Because of the higher speeds and the associated risk of hydroplaning, FC-5 friction course is to be provided to reduce surface water. The FC-5 friction course should be placed at the lip of the gutter in accordance with the [Design Standards, Index 300](#).

2.16.7 Border Width

The border width for all high-speed urban and suburban arterial highways is measured from the outside edge of the traveled way to the right of way line. For a design speed of 55 mph, the minimum border width is 35 feet. For a design speed of 50 mph, the minimum border width is 29 feet.

For typical section with outside flush shoulders refer to **Section 2.5** for required border width.

2.16.8 Grades

The maximum grade for four-lane and six-lane high-speed urban and suburban arterial highways is 6% for a 50 mph design speed, or 5% for a 55 mph design speed.

2.16.9 Horizontal Curves

The maximum deflection without horizontal curvature is commensurate with rural new construction and comparable design speeds.

2.16.10 Superelevation

When these urban and suburban typical sections are superelevated, the superelevation rates are based on the $e_{max} = 0.10$ calculations, however the maximum superelevation rate that may be used is 0.05 (See **Figure 2.16.3**). Superelevation transition rates are to be commensurate with those for rural highways with 50 or 55 mph design speeds.

Figure 2.16.3 Superelevation Rates for High-Speed Urban and Suburban Sections

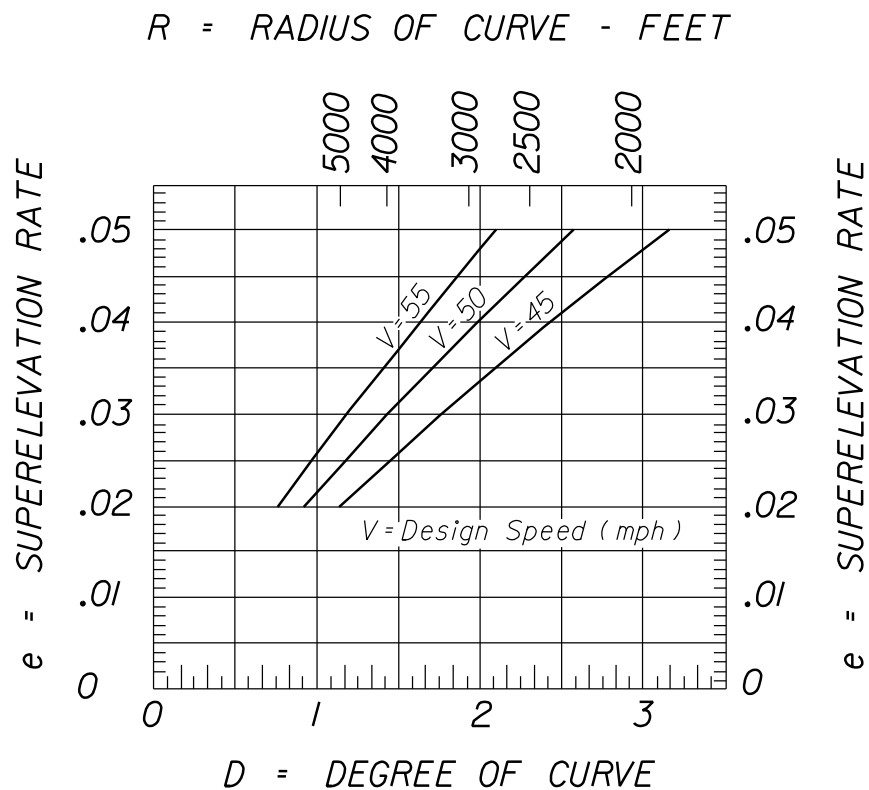

MAXIMUM DESIGN SUPERELEVATION RATE = 0.05
 (BASED ON $e_{max} = 0.10$)

2.16.11 Lateral Offset

Lateral offset requirements are to be commensurate with new construction conditions for flush shoulder highways. See **Chapter 4** of this Volume.

Chapter 3

Earthwork

3.1	General	3-1
3.2	Classification of Soils	3-3
3.3	Cross Sections - A Design Tool.....	3-3
3.4	Earthwork Quantities.....	3-4
3.4.1	Method of Calculating.....	3-4
3.4.2	Earthwork Tabulation	3-4
3.4.3	Earthwork Accuracy	3-5
3.4.3.1	Projects with Horizontal and Vertical Controlled Cross Sections	3-5
3.4.3.2	Projects without Horizontal and Vertical Controlled Cross Sections	3-6
3.4.4	Variation in Quantities	3-6
3.5	Earthwork Items of Payment	3-7
3.5.1	Guidelines for Selecting Earthwork Pay Items	3-7
3.5.2	Regular Excavation	3-8
3.5.3	Embankment	3-9
3.5.4	Subsoil Excavation	3-9
3.5.5	Lateral Ditch Excavation.....	3-10
3.5.6	Channel Excavation	3-11
3.5.7	Borrow Excavation (Truck Measure)	3-11
3.5.8	Regular Excavation (RRR Projects Only)- Lump Sum.....	3-12
3.5.9	Summary of Earthwork.....	3-13

Tables

Table 3.5.1 Guidelines for Selecting Earthwork Pay Items3-7

Figures

Figure 3.1.1 Cut and Fill Limits (With and Without Subsoil
Excavation)3-2

Figure 3.4.1 Format for the Tabulation of Earthwork Quantities3-4

Figure 3.5.1 Pond Template.....3-8

Figure 3.5.2 Undercut Detail of Plastic Material with
Relation to Side Ditches3-10

Exhibits

Exhibit 3-A Fill and Truck Adjustments3-12

Exhibit 3-B Summary of Earthwork Box
(Projects With Cross Sections).....3-13

Exhibit 3-C Summary of Earthwork Box
(Projects With Limited or No Cross Sections).....3-14

Chapter 3

Earthwork

Modification for Non-Conventional Projects:

Delete *PPM* Chapter 3.

3.1 General

Earthwork is a generic term for all items of work, materials and operations required to construct the excavated areas and the embankments of a project. *FDOT Specifications, Sections 120* and *125* define the terms, method of measure, basis of payment and pay items associated with earthwork.

In general, earthwork on a highway project consists of:

Embankment	Compacted fill material needed to construct the roadway, excluding the base and pavement portions of the roadway and shoulders.
Regular Excavation	Excavation necessary for the construction of the roadway, ditches, ponds, channel changes, etc.
Subsoil Excavation	Excavation, removal and disposal of any material that is unsuitable in its original position and that is excavated below the finished grading template.

The most important roadway operation involving earthwork is constructing the roadbed. The roadbed is constructed by excavating soil from cut sections and placing soil as embankments in fill sections. In cut sections, the roadbed is built below the original ground - the original ground is excavated to the elevation of the proposed roadbed. In fill sections, the roadbed is built above the original ground - the earth fill is on an embankment.

The finished grading template is defined as the finished shoulder and slope lines and bottom of the completed base or rigid pavement for most pavements. The Department occasionally uses stabilized bases and sand bituminous road mixes. For these, consider the finished grading template as the top of the finished base, shoulders and slopes.

Figure 3.1.1 Cut and Fill Limits (With and Without Subsoil Excavation)

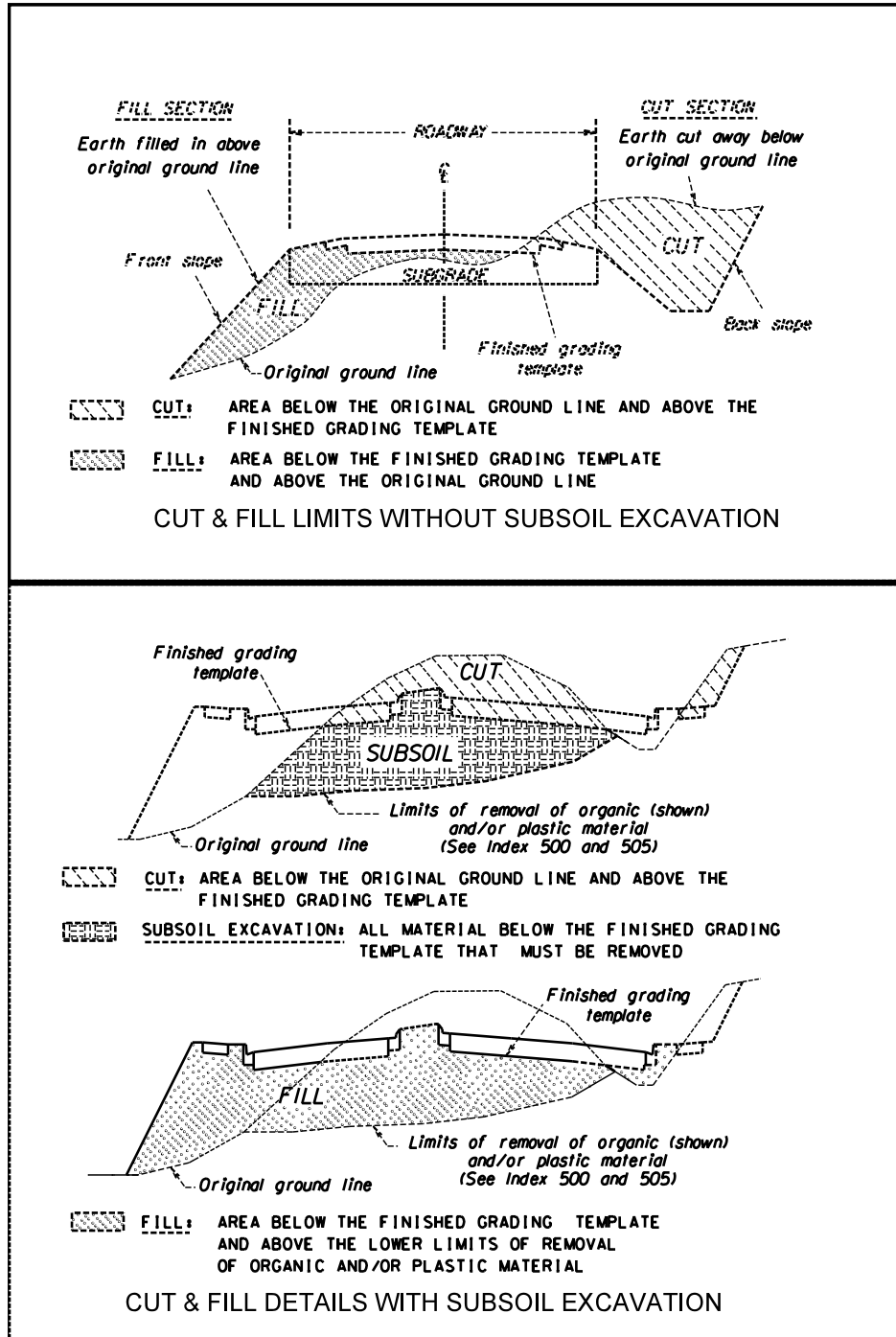

See the *Design Standards, Indexes 500 and 505*

3.2 Classification of Soils

The Department uses a system of soil classification that places materials into groups and subgroups based on soil fraction, liquid limit and plasticity index. This classification determines if and where the materials may be placed or left in their original position on a project. The soils survey, testing and classification of materials must be performed by a qualified geotechnical laboratory. The plans will include the information about the soil classification on the soil survey sheet and by showing the boring data soil boxes on the cross section sheets. If it is determined that an organic or plastic material must be removed below the finished grading template, the lower limits of removal of organic or plastic material will be shown to determine the area and volume of subsoil excavation. For more details, see **Volume 2** and the **Design Standards, Index 505**.

3.3 Cross Sections - A Design Tool

The details of cut and fill of earthwork are shown on the cross sections. The cross sections of the existing surface are usually obtained by location field survey or photogrammetry. The finished profile grades, typical section details, pavement design details, superelevation and horizontal alignments are used in combination to develop the finished template at each location where an existing cross section was obtained or generated. Sometimes it is advisable to develop and plot intermediate cross sections or half-sections to accurately determine quantities.

Cross sections cannot be finalized until late in the design process. However, preliminary cross section templates, developed early in the design process, can assist the designer in establishing many of the other design elements such as guardrail, shoulder gutter, inlets and special ditch grades. Preliminary cross sections are also used in performing the Soils Survey. Cross section templates should be plotted as soon as the alignment, grades and typical section details are established.

The interval selected for showing cross sections in the plans will vary according to project specific factors. For guidance see **Volume 2, Section 18.3**.

For resurfacing and minor widening and resurfacing projects, see **Section 3.5.8** of this chapter.

Additional criteria used for plotting the earthwork details are found in the **FDOT Specifications, Section 120**; the **Design Standards, Indexes 500** and **505**; and **Volume 2** of this manual.

3.4 Earthwork Quantities

3.4.1 Method of Calculating

Earthwork quantities can be accurately determined by computer or by manual calculation, if proper care is taken. Therefore, the specifications allow it to be designated for payment as the original plan quantity unless determined to be substantially in error. Earthwork quantities are calculated by the method of average end areas:

$$\text{CUBIC YARDS} = \frac{\text{EA1} + \text{EA2}}{2} \times \text{LENGTH} / 27$$

Each set of end areas for the different types of earthwork (subsoil excavation, regular excavation and embankment) are calculated separately and shown in the appropriate column on the cross section sheets, as indicated in **Volume 2** of this manual.

3.4.2 Earthwork Tabulation

Areas and volume for subsoil excavation, regular excavation and embankment are tabulated on the right hand side of the cross section sheet. The designer must be familiar with the control lines for earthwork operations in order to properly delineate and calculate earthwork quantities.

Figure 3.4.1 Format for the Tabulation of Earthwork Quantities

(Show the appropriate tabulation on the right side of the sheet)

**Projects With Limited or
 No Cross Sections**

See Example in *Section 3.5.9*
 of this chapter.

**Projects With
 Cross Sections**

SUBSOIL EXC.		REGULAR EXC.		EMBK.	
A	V	A	V	A	V

3.4.3 Earthwork Accuracy

There are two methods of documenting the earthwork quantities for projects. The most accurate and preferred method involves the preparation of cross sections to define the quantities of earthwork involved. This method is mandatory on all new construction and major reconstruction projects. The other method, using working typical sections, is only to be used on RRR type projects where it has been determined that the project is a candidate for payment by Regular Excavation, Lump Sum. It is critical that the designer choose which method is best suited for their project with input from construction.

The calculation of earthwork volumes is not simple but, when performed with care and properly checked, many of the inaccuracies common in earthwork quantity calculations can be avoided. The primary causes for inaccurate earthwork quantities are found to be errors in calculating end areas and choosing inappropriate intervals between the cross sections. Correct methods and techniques for computing earthwork quantities will eliminate the gross errors.

3.4.3.1 Projects with Horizontal and Vertical Controlled Cross Sections

1. Calculate end areas and volumes by computer, when possible, and print the calculations for verification and future use by others.
2. Plot cross section details at the largest scale the sheets will permit. Care should also be taken when plotting slopes that extend over long distances.
3. If end areas are calculated from cross sections manually, show the breakdown of areas, etc. on the **Design Backup** worksheets in the **Summary of Earthwork.xlsx** file.
4. When computing volumes, determine lengths between sets of end areas to compensate for volumes that do not run the entire lengths between the normal station lengths.
5. Properly use match lines and turning lines to divide end areas when separate lengths should be used to calculate volumes.
6. Reduce the interval between cross sections to 25 feet or less on ramps or sharp turning roadways, or determine and use the centroid of the section as the length for computing volumes.

7. Exclude bridge spans, large culverts or other exceptions where earthwork is not required.
8. Include quantities for fill slopes under bridges, at guardrail installations and at culvert extensions. Show extended shoulder slope on cross sections at guardrail locations (not steeper than 1:10 per the ***Design Standards, Index 400***).
9. Make sure that the fill for all subsoil excavation is included in either the embankment or borrow excavation (truck measure) quantities.

3.4.3.2 Projects without Horizontal and Vertical Controlled Cross Sections

1. Include PDF files of working typical cross sections in the \calculations sub-directory under the proper directory for all locations where there is a change in either the existing or proposed templates.
2. Working typicals should include the station limits of the typical, and the end areas of all cut and fill sections. Working typicals may be placed in the plans, but are not required.
3. The thickness of the base box is calculated on the most probable base option. A plan note should also be shown in the plans stating which option was used for calculating the earthwork quantities.
4. Extra fill material needed for the extended shoulder for guardrail placement should be documented on the ***Design Backup*** worksheets in the ***Summary of Earthwork.xlsx*** file with the final quantity being tabulated on the summary of earthwork. The quantity should be based on working typical sections showing the extended shoulder slope on cross sections at guardrail locations (not steeper than 1:10 per the ***Design Standards, Index 400***).

3.4.4 Variation in Quantities

When detailing and determining earthwork quantities, use the most probable base option within the optional base group. A plan note should also be shown in the plans stating which option was used for plotting the cross sections and calculating the earthwork quantities. The Specifications do not allow adjustment of the earthwork quantities that were designated to be paid as plan quantity because a base of different depth was chosen during construction.

3.5 Earthwork Items of Payment

3.5.1 Guidelines for Selecting Earthwork Pay Items

Table 3.5.1 Guidelines for Selecting Earthwork Pay Items

Description		Control Lines	Recommended Pay Item	
			Projects with Cross Sections	Projects with Limited or No Cross Sections
Earthwork operations above the original ground line and below the finished grading template	Fill	from original ground to the finished grading template	Embankment (CY)	Borrow Excavation (Truck Measure) (CY)
Earthwork operations below the original ground line and above the finished grading template	Cut	from original ground to the finished grading template	Regular Excavation (CY)	Regular Excavation (3-R Projects) (LS)
Earthwork operations below the original ground line and below the finished grading template	Cut	from the finished grading template or original ground, whichever is lower, to the lower limits of removal of organic or plastic material	Subsoil Excavation (CY)	Subsoil Excavation (CY)
	Fill	from the lower limits of removal of organic or plastic material removed to the finished grading template	Embankment (CY)	Borrow Excavation (Truck Measure) (CY)
With significant quantities of lateral ditch or channel excavation the designer may select to pay for separately		from finished ground to the finished grading template	Lateral Ditch Exc. Channel Exc. (CY)	N/A

3.5.2 Regular Excavation

This is the most general classification of earthwork excavation. When Lateral Ditch or Channel excavation pay items are not called for in the plans, the total quantity of all excavation must be paid for as Regular Excavation. Regular Excavation may include roadway, pond and ditch excavation. Roadway Excavation consists of the net volume of material excavated between the original ground line and the finished grading template of the roadway.

Retention or detention areas that require considerable excavation should be summarized separately and added to the Regular Excavation. This is especially important if there is a large quantity and the area is removed from the project by some distance.

Some environmental permits now require that the plans call for excavating additional depth below the finish elevation of the bottom of a pond or ditch. They also require that the area of extra depth be replaced with “blanket material” that will either allow for percolation or not allow for percolation as required by the permit. The drawing below shows the limits of pay for excavation in this situation. The depth and type of fill material must be identified in the plans.

Figure 3.5.1 Pond Template

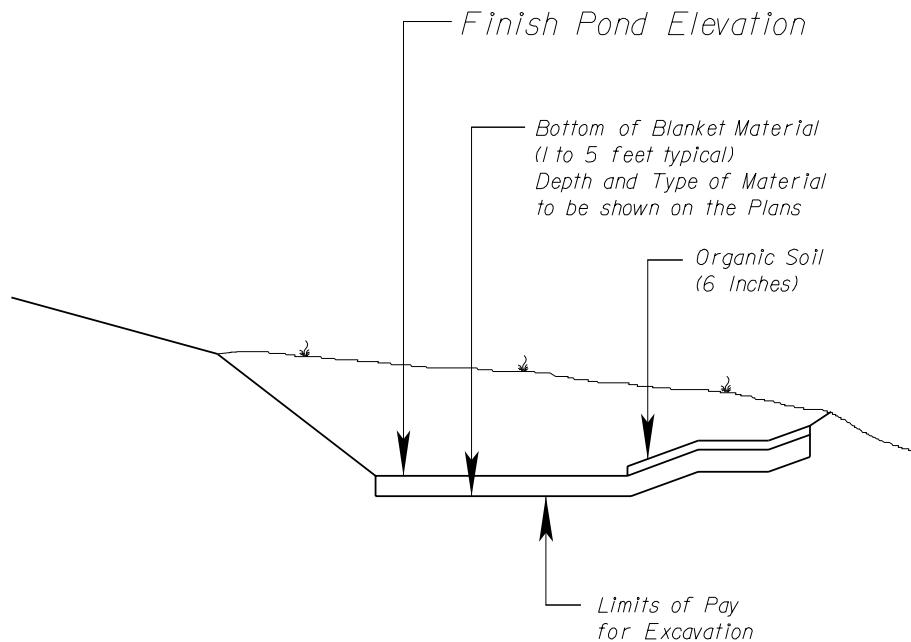

3.5.3 Embankment

This item includes placing material above the original ground line, or above the lower limits of removal of organic and/or plastic material to the finished grading template.

3.5.4 Subsoil Excavation

Subsoil Excavation consists of the excavation and disposal of any material that in its original position is excavated below the finished grading template or original ground, whichever is lower.

The soils investigation survey documents the organic and/or plastic material found on the project. Likewise, the cross sections and the earthwork calculations must use the lower limits of removal of organic or plastic material in determining the quantities for Subsoil Excavation.

Where future widening of the roadway is anticipated, specify the limits of removal necessary to accommodate the future widening.

At some locations the complete removal of organic or soft soils may not be practical due to the depth. Review the subsoil excavation with the Geotechnical Engineer of Record and where constructability concerns exist, consult with the District Geotechnical Engineer to review design alternatives. If a geosynthetic reinforced design is selected, refer to **Chapter 31, Volume 1** for plan content and design requirements. Additional information concerning geotechnical design can be found in the [Soils and Foundations Handbook](#).

Modification for Non-Conventional Projects:

Delete the above paragraph and see RFP for requirements.

Where subsoil excavation is required due to plastic soils, ensure that adequate drainage of the pavement subgrade is provided. **Figure 3.5.2** illustrates the required excavation undercut line (i.e., grade and extent of excavation bottom) for flush shoulder roadways. To accommodate normal undercuts, the side ditches should be at least 3.5 feet below the shoulder break. For curbed roadways, additional subsoil excavation may be needed beyond that shown in **Figure 3.5.2** or underdrains must be installed in accordance with [Design Standards, Index 500](#). Coordinate the removal of plastic materials with the

Drainage Engineer of Record, as it may affect various drainage design elements including the profile grade of the ditch bottoms.

Figure 3.5.2 Undercut Detail of Plastic Material with Relation to Side Ditches

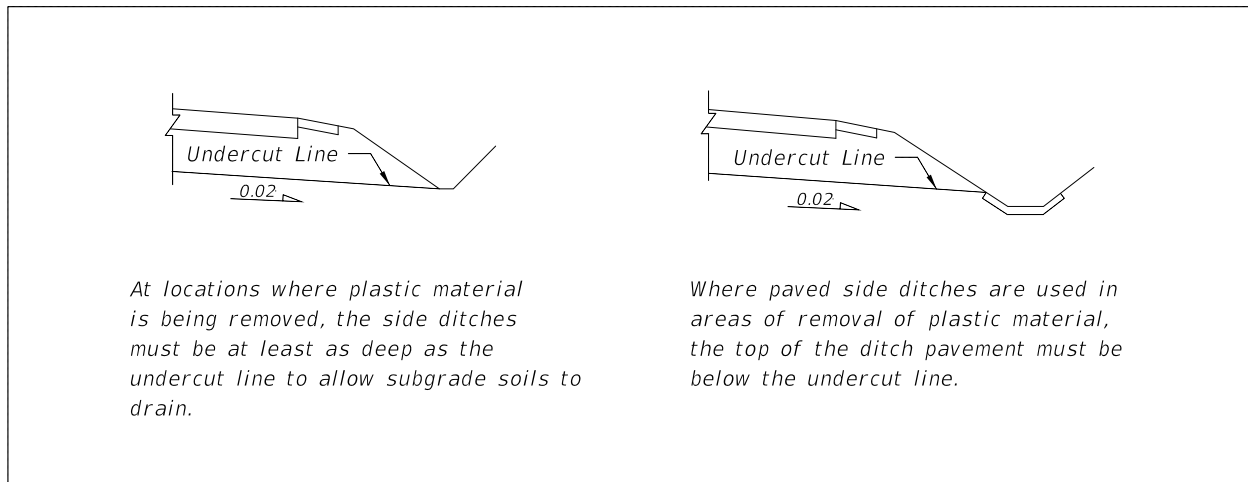

Tabulate subsoil excavation areas and volumes on the right side of the cross section sheets. The fill quantities (areas and volumes) must include areas and volumes required to fill the excavated areas created by subsoil removal. See example given in **Section 3.1** of this chapter.

Do not include the payment for subsoil excavation in the pay quantities for other items no matter how small the subsoil quantities.

Embankment (fill) or Regular Excavation (cut) should be used in conjunction with the pay item Subsoil Excavation. Both Embankment and Regular Excavation are plan quantity items. The quantities are based on line and grades shown in the plans and would allow construction personnel to field verify the quantities of material used on a project. Subsoil Excavation is a field measure item, and the final pay quantity will be determined by cross section taken when the removal of the material is completed.

3.5.5 Lateral Ditch Excavation

Excavation required to construct inlet and outlet ditches at structures, changes in channels of streams and ditches parallel to the right of way, but separated from the roadway template, may be designated by the designer as Lateral Ditch Excavation.

On projects with very little of this type of excavation, this earthwork is usually included in the Regular or Roadway Excavation. If there is a significant amount of Lateral Ditch Excavation, it should be detailed, calculated and summarized on separate cross section sheets and shown separately in the Earthwork Summary. For more details on lateral ditch cross sections, see **Volume 2** of this manual.

Excavation included for payment or that will be bid as work under **FDOT Specifications, Section 125, Excavation for Structures and Pipe**, must not be included again in Lateral Ditch or other excavation pay items.

3.5.6 Channel Excavation

The pay item for Channel Excavation consists of the excavation and satisfactory disposal of all material from the limits of the channel as shown in the plans. This work is generally called for by the plans and has lines, grades, typical sections and other details shown for excavating a channel change or a major modification to an existing channel or stream. This work may be significantly different from regular excavation or lateral ditch excavation, requiring draglines, barges or other special equipment. It should be detailed, calculated and summarized separately, in most cases.

3.5.7 Borrow Excavation (Truck Measure)

Borrow Excavation is the pay item used to indicate that the contractor is to furnish earthwork material from areas provided by him and generally outside the project limits, including material with a specific minimum bearing value for building up existing shoulders, when appropriate for the project.

Borrow material, if available, may be obtained from within the right of way of the project. Obtaining material from the project right of way must not create an unsafe condition or unprotected hazard. Apply proper design criteria to proposed excavation areas that will fill with water. The proposed borrow areas must be reviewed and coordinated with the District Environmental Coordinator to minimize environmental disturbance and promote a future original appearance.

When the designer chooses the method of payment as Borrow Excavation (Truck Measure), a fill adjustment must be made to the net total fill material calculated from the plans to allow for handling. An additional adjustment (truck) is added to obtain a representative volume of material required. This is not a plan quantity item, but it is very important that the most realistic determination of quantities possible be calculated by the

designer. Recommendations on fill and truck adjustment percentages should always be obtained from either the District Materials or Construction Office during the design process.

Exhibit 3-A Fill and Truck Adjustments

EXAMPLE: Fill (From Working Typical)	253 CY
Fill Adjustment (+20%) (253 x 0.20)	<u>51 CY</u>
Fill	304 CY
Truck Adjustment (+25%) (304 x 0.25)	<u>76 CY</u>
Borrow Excavation (Pay Item)	380 CY

Adjustment percentages shown are for example only. Contact District Materials or Construction Office for actual percentages to be used for each project.

3.5.8 Regular Excavation (RRR Projects Only)-Lump Sum

The Pay Item for Regular Excavation (RRR Projects Only) - Lump Sum is to be used on resurfacing or minor widening and resurfacing (RRR) projects that conform to the following guidelines:

1. There are limited or no cross sections on the project.
2. Existing typicals are reasonably consistent throughout the project.
3. If utility adjustments are a consideration on the project, the designer will need to be sure that sufficient data is available to allow the utility to be relocated or adjusted.
4. There are no right of way requirements on the project.
5. There is no change in the existing horizontal or vertical alignment.
6. There are no major special ditches on the project.
7. There are no major intersection modifications.
8. Show quantity of Excavation in Summary Box, but pay for as 1 Lump Sum.

Regular Excavation (RRR Projects Only) - Lump Sum can be used on projects other than RRR, but only if they are minor projects complying with the same listed guidelines.

Earthwork will be paid for as Borrow Excavation (Truck Measure) and Regular Excavation (RRR Projects Only) – Lump Sum. The designer will calculate these quantities based on information obtained from the field and the proposed typical section. The designer must conduct a thorough field review to ensure existing field conditions are accurately reflected in earthwork estimates.

3.5.9 Summary of Earthwork

A subtotal for each group or cross section (mainline, side street, pond 1, etc.) should be shown in the Summary of Earthwork box for each earthwork operation (subsoil excavation, regular excavation and embankment).

Below is an example of a summary of earthwork box for projects with cross sections. The summary should document all the groups' totals in one location. This summary should be shown on the Summary of Quantities Sheet.

**Exhibit 3-B Summary of Earthwork Box
 (Projects with Cross Sections)**

SUMMARY OF EARTHWORK					
PAY ITEM NO.	PAY ITEM DESCRIPTION	CY		DESIGN NOTES	CONSTRUCTION REMARKS
		P	F		
0120 1	REGULAR EXCAVATION	10000.0		MAINLINE	
		800.0		SIDE STREET NAME	
		1005.0		POND NO. 1	
	TOTAL	11805			
0120 3	LATERAL DITCH EXCAVATION	5000.0			
0120 4	SUBSOIL EXCAVATION	2080.0		MAINLINE	
		1100.0		SIDE STREET NAME	
	TOTAL	3180			
0120 6	EMBANKMENT	20000.0		MAINLINE	
		7000.0		SIDE STREET NAME	
	TOTAL	27000			

Below is an example of a summary of earthwork box that should be used for projects with limited or no cross sections. This summary should be shown on the Summary of Quantities Sheet. The summary should show all quantities and adjustments.

**Exhibit 3-C Summary of Earthwork Box
 (Projects with Limited or No Cross Sections)**

SUMMARY OF EARTHWORK					
PAY ITEM NO.	PAY ITEM DESCRIPTION	CY		DESIGN NOTES	CONSTRUCTION REMARKS
		P	F		
0120 2 2	BORROW EXCAVATION				
	FILL	253.0			
	GUARDRAIL LOCATIONS	70.0			
	CROSS DRAINS	100.0			
	SUB TOTAL	423.0			
	FILL ADJUSTMENT (20%) (423 X 0.20)	85.0			
	SUB TOTAL	508.0			
	TRUCK ADJUSTMENT (25%) (508 X 0.25)	127.0			
	TOTAL BORROW EXCAVATION	635			
0120 71	REGULAR EXCAVATION (3R PROJECTS ONLY)	200		LS-QTY FOR REFERENCE ONLY	

The pay items used will be:

Regular Excavation (RRR Projects Only) 1 (LS)
 Borrow Excavation (Truck Measure) 635 CY

Adjustment percentages shown are for example only. Contact District Materials or Construction Office for actual percentages to be used for each project.

Chapter 4

Roadside Safety

4.1	General	4-1
4.2	Roadside Features.....	4-2
4.2.1	Roadside Geometry	4-2
4.2.2	Roadside Slope Classification	4-2
4.2.3	Clear Zone Criteria	4-2
4.2.4	Lateral Offsets.....	4-7
4.2.5	Control Zones.....	4-11
4.2.6	Roadside Slope Criteria	4-17
4.2.6.1	New Construction Slope Criteria.....	4-17
4.2.6.2	RRR Slope Criteria.....	4-18
4.2.7	Drainage Features.....	4-20
4.2.7.1	Roadside Ditches	4-20
4.2.7.2	Curbs	4-23
4.2.7.3	Drainage Structures	4-24
4.2.7.4	Drainage Structures in RRR Projects	4-24
4.2.8	Traffic Separators.....	4-24
4.2.9	Signing, Lighting, Traffic Signals, and Other Similar Roadside Features	4-25
4.2.10	Roadside Flashing Beacon Assemblies	4-25
4.2.11	Mailbox Supports	4-25
4.2.12	Bus Benches and Transit Shelters	4-25
4.2.13	Breakaway Devices.....	4-26
4.2.14	Other Appurtenances	4-26
4.3	Roadside Hazards.....	4-27
4.3.1	Aboveground Hazards.....	4-27

	4.3.1.1	Aboveground Hazards in Work Zones	4-27
4.3.2		Canal Hazards	4-27
4.3.3		Drop-off Hazard.....	4-30
	4.3.3.1	Drop-offs in Work Zones.....	4-31
4.3.4		Additional Hazard Considerations	4-31
4.4		Longitudinal Barriers, Barrier Transitions, End Treatments & Crash Cushions	4-32
4.4.1		Standard Longitudinal Barriers	4-32
	4.4.1.1	Flexible Barrier	4-32
	4.4.1.2	Semi-Rigid Barrier	4-33
	4.4.1.3	Rigid Barrier	4-34
	4.4.1.4	Temporary Barriers	4-46
4.4.2		End Treatments.....	4-47
	4.4.2.1	Guardrail End Treatments	4-47
	4.4.2.2	Rigid Barrier End Treatments	4-48
	4.4.2.3	Temporary Barrier End Treatments	4-48
4.4.3		Crash Cushions.....	4-49
	4.4.3.1	Permanent Crash Cushions	4-49
	4.4.3.2	Temporary Crash Cushions.....	4-49
4.4.4		Barrier Transitions	4-50
4.4.5		Barrier Type Selection.....	4-50
	4.4.5.1	Longitudinal Barrier Selection.....	4-51
	4.4.5.2	End Treatment Selection.....	4-53
	4.4.5.3	Crash Cushion Selection.....	4-53
	4.4.5.4	Pier Protection.....	4-53
4.4.6		Barrier Placement	4-55
	4.4.6.1	Barrier Offset.....	4-55
	4.4.6.2	Grading Requirement	4-59
	4.4.6.3	Length of Need.....	4-60
	4.4.6.4	Median Barriers	4-60

4.4.6.5	Temporary Barriers	4-61
4.4.7	Warrants for Roadside Barriers.....	4-62
4.4.7.1	Evaluation of Roadside Hazards.....	4-62
4.4.7.2	Shielding Requirements.....	4-63
4.4.7.3	Warrants for Median Barrier.....	4-64
4.4.7.4	Positive Protection in Work Zones	4-64
4.5	Attachments to Barriers.....	4-65
4.5.1	Median Barrier Attachments.....	4-66
4.5.2	Existing Attachments to Median Barriers and Traffic Railings	4-66
4.5.3	Temporary Attachments to Barriers	4-67
4.6	Surface Finishes	4-67
4.7	Upgrading Existing Barrier Systems.....	4-68
4.7.1	Resetting Guardrail	4-69
4.7.2	Existing Longitudinal Roadway Barriers on RRR Projects	4-69
4.7.3	Existing End Treatments & Crash Cushions on RRR Projects	4-70
4.7.4	Bridge Traffic Railing on RRR Projects	4-71
4.7.5	Guardrail to Bridge Railing Transitions on RRR Projects	4-73
4.8	Non-Standard Roadside Safety Hardware	4-76

Tables

Table 4.2.1	Clear Zone Width Requirements	4-5
Table 4.2.2	Clear Zone Width Requirements for Work Zones.....	4-6
Table 4.2.3	Lateral Offset Criteria	4-8
Table 4.2.4	Roadside Slopes	4-19
Table 4.4.1	Roadway Barrier Type Selection	4-52
Table 4.4.2	Minimum Barrier Setback	4-58

Figures

Figure 4.2.1	Clear Zone Plan View.....	4-3
Figure 4.2.2	Basic Clear Zone Concept.....	4-3
Figure 4.2.3	Adjusted Clear Zone Concept	4-4
Figure 4.2.4	Intersection Radii	4-11
Figure 4.2.5	'T' Intersection.....	4-12
Figure 4.2.6	Right Turn Deceleration with Tangent	4-13
Figure 4.2.7	Right Turn Deceleration with Reverse Curve.....	4-13
Figure 4.2.8	Merge Section with Tangent.....	4-14
Figure 4.2.9	Merge Section with Reverse Curve	4-14
Figure 4.2.10	Service Facility Driveway	4-15
Figure 4.2.11	Business Driveway	4-15
Figure 4.2.12	Horizontal Curve	4-16
Figure 4.2.13	Roadway Deflection without Curve.....	4-17
Figure 4.2.14	Roadside Ditches – Bottom Width 0 to 4 feet	4-21
Figure 4.2.15	Roadside Ditches – Bottom Width \geq 4 feet	4-22

Figure 4.3.1	Minimum Offsets for Canal Hazards Rural and Urban Flush Shoulders	4-29
Figure 4.3.2	Minimum Offsets for Canal Hazards Urban Curb or Curb and Gutter	4-30
Figure 4.3.3	Drop-off Hazards in Urban Sections	4-31
Figure 4.4.1	Bridge Traffic Railings – F-Shapes	4-36
Figure 4.4.2	Bridge Traffic Railings – Vertical Shapes.....	4-37
Figure 4.4.3	Bridge Traffic Railings – Other Shapes	4-38
Figure 4.4.4	Bridge Traffic Railings – Median Traffic Railing and Traffic Railing/Noise Wall Combination	4-39
Figure 4.4.5	Bridge Railing – Pedestrian/Bicycle Railing (Index 820).....	4-40
Figure 4.4.6	Bridge Railing – Pedestrian/Bicycle Railing (Index 851 & 861).....	4-41
Figure 4.4.7	Bridge Railing – Pedestrian/Bicycle Railing (Index 825).....	4-42
Figure 4.4.8	Bridge Railing and Pedestrian/Bicycle Railing Retrofit.....	4-43
Figure 4.4.9	Bridge Railing and Bridge Parapet Fencing.....	4-44
Figure 4.4.10	Bridge Railing – Enclosed Fencing.....	4-45
Figure 4.4.11	Pier Protection Selection Flowchart (New Construction).....	4-54
Figure 4.4.12	Lateral Offset to Guardrail	4-56
Figure 4.4.13	Setback Distances for Discontinuous Elements	4-59

THIS PAGE LEFT BLANK INTENTIONALLY

Chapter 4

Roadside Safety

4.1 General

The design criteria contained in **Chapter 2** of this Volume has been developed to minimize the probability that a vehicle will depart the roadway. Design elements that affect roadside safety include horizontal alignment and superelevation, vertical alignment, drainage design, sight distance, lane widths, pavement and markings, cross slopes, median widths, shoulders and lighting.

The evaluation of Roadside Safety design elements is necessary to address the occasional errant vehicle that does depart the roadway. These design elements include roadside geometries, lateral offsets to potential hazards, and the use of shielding.

This Chapter contains roadside safety design criteria for three project types:

- New Construction
- Transportation Design for Livable Communities (TDLC)
- Resurfacing, Restoration and Rehabilitation (RRR) projects

New Construction criteria must be met for new and reconstruction projects, and for improvements included with RRR projects. The RRR criteria may be used for establishing the minimum requirements for intersection improvement projects with the understanding that when right of way is adequate, new construction criteria will be used to the maximum extent feasible. Refer to **Chapter 25** of this Volume for RRR criteria usage requirements. Certain conditions may allow TDLC criteria to be used in accordance with the requirements provided in **Chapter 21** of this Volume.

The **AASHTO Roadside Design Guide (AASHTO RDG)** provides the foundation for the development of specific criteria contained in this Chapter and the FDOT **Design Standards**.

4.2 Roadside Features

4.2.1 Roadside Geometry

Roadside geometry refers to the terrain features (slopes) that a vehicle will encounter when departing a roadway. The components of roadside geometry include front slopes, back slopes, and transverse slopes.

4.2.2 Roadside Slope Classification

Roadside Slopes include areas located beyond the edge of the traffic lane as shown in **Figures 4.2.2** and **4.2.3**. These areas are divided into the following classifications:

1. Traversable Slope – Smooth terrain, unobstructed by fixed objects, and sloped at 1:3 or flatter
2. Recoverable Slope – Traversable Slope 1:4 or flatter
3. Traversable Non-Recoverable Slope – Traversable Slope steeper than 1:4 and flatter than 1:3
4. Non-Traversable Slope – Rough, obstructed, or slopes steeper than 1:3
5. Critical Slope – Non-Traversable Slope steeper than 1:3

4.2.3 Clear Zone Criteria

Providing a sufficient amount of Recoverable Slope adjacent to the roadway provides an opportunity for an errant vehicle to safely recover. The amount of recoverable area provided beyond the traveled way is defined as the Clear Zone, and includes shoulders and bike lanes. The Clear Zone must be free of aboveground fixed objects, water bodies and Non-Traversable Slopes.

Traversable Back Slopes 1:3 or flatter may be located within the Clear Zone.

A clear zone width must be provided so that the sum of all Recoverable Slopes is equal to or greater than the required clear zone width obtained from **Table 4.2.1**. Clear zone widths may be widened based on crash history and horizontal curvature; see **AASHTO RDG, Section 3.1**. Visuals of the basic clear zone concepts are shown in **Figure 4.2.1** and **Figure 4.2.2**. For Roadside Slope Criteria, see **Section 4.2.6**.

Figure 4.2.1 Clear Zone Plan View

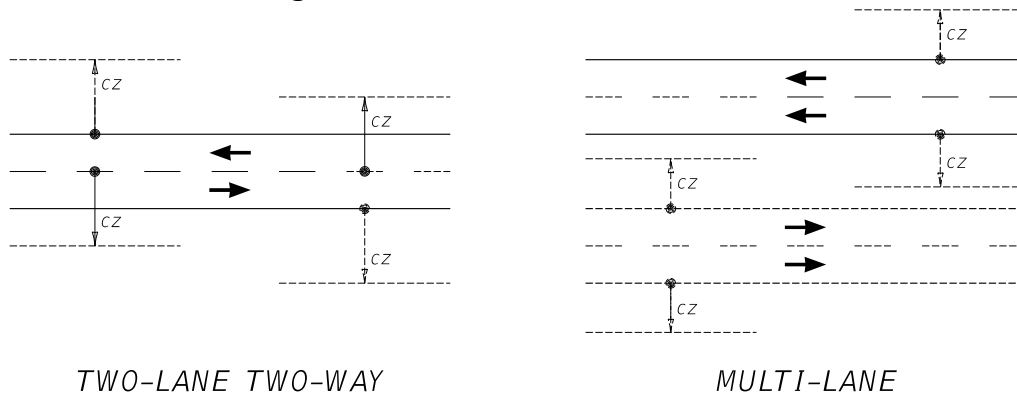
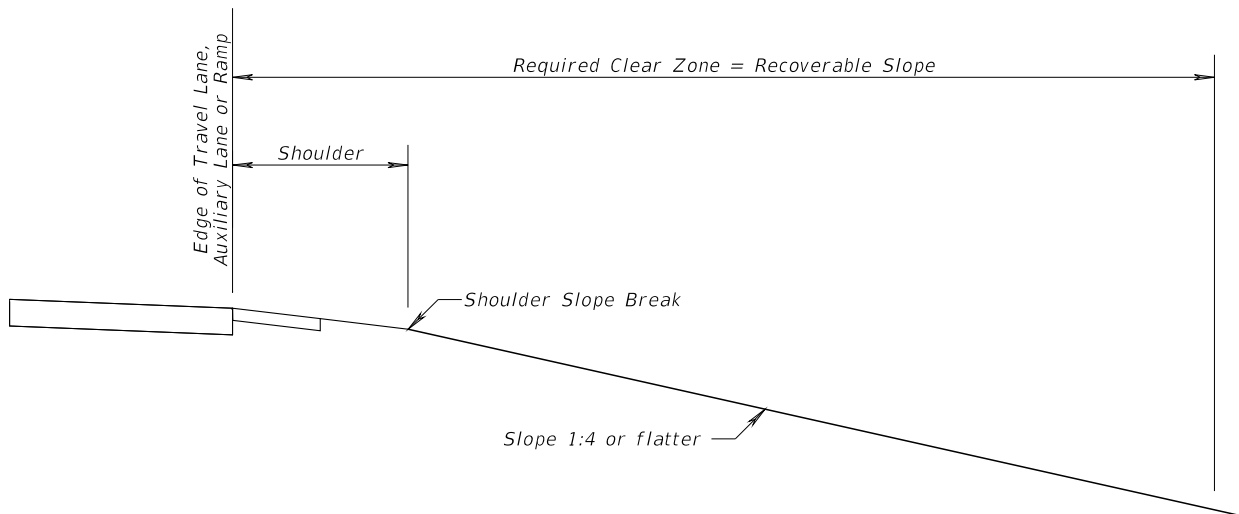

Figure 4.2.2 Basic Clear Zone Concept



When a Traversable Non-Recoverable Slope is present within the clear zone, extend the clear zone width until the amount of Recoverable Slope equals the required clear zone width obtained from **Table 4.2.1**. The additional width provided beyond the Traversable Non-Recoverable Slope is known as the Clear Run-out Area and is illustrated in **Figure 4.2.3**. The Clear Run-out Area should be a minimum of 10 feet wide when right of way is adequate.

Figure 4.2.3 Adjusted Clear Zone Concept

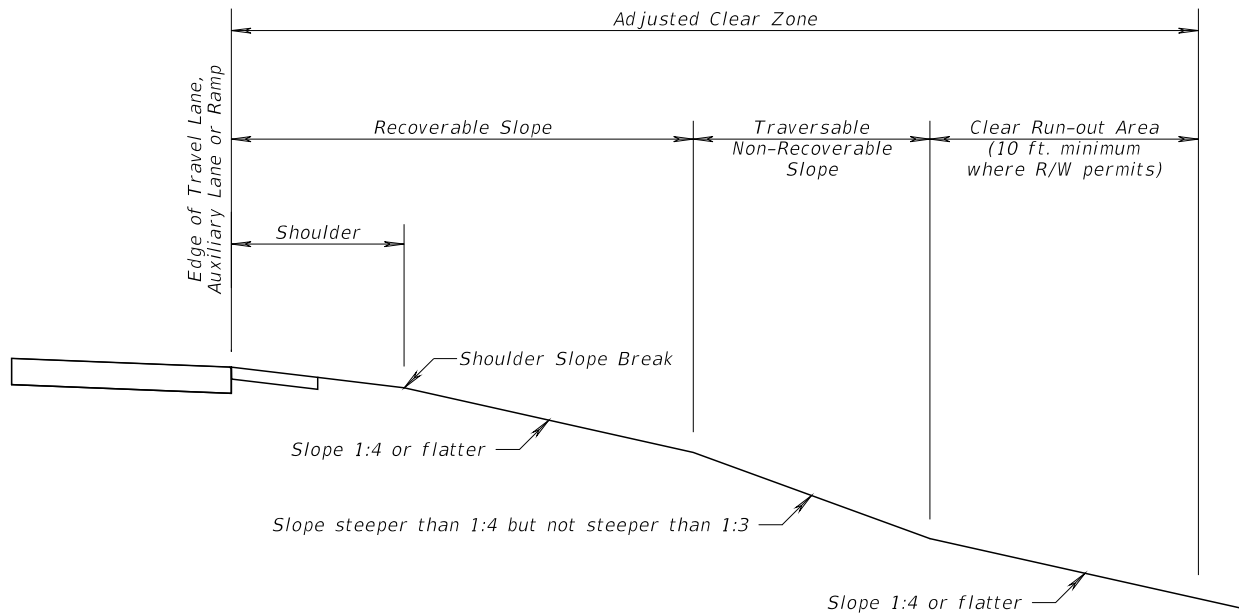

Table 4.2.1 Clear Zone Width Requirements

NEW CONSTRUCTION				
DESIGN SPEED (mph)	≥ 1500 AADT ⁽¹⁾		< 1500 AADT ⁽¹⁾	
	TRAVEL LANES & MULTILANE RAMPS (feet)	AUXILIARY LANES & SINGLE LANE RAMPS (feet)	TRAVEL LANES & MULTILANE RAMPS (feet)	AUXILIARY LANES & SINGLE LANE RAMPS (feet)
< 45	18	10	16	10
45	24	14	20	14
50	24	14	20	14
55	30	18	24	14
> 55	36	24	30	18
TDLC PROJECTS				
DESIGN SPEED (mph)		ALL LANE TYPES (feet)		
≤ 30		12		
35		14		
40		16		
RESURFACING, RESTORATION AND REHABILITATION (RRR) PROJECTS ⁽²⁾				
DESIGN SPEED (mph)	TRAVEL LANES & MULTILANE RAMPS (feet)		AUXILIARY LANES & SINGLE LANE RAMPS (feet)	
< 45	6		6	
45 ⁽³⁾	14		8	
> 45	18		8	
(1) Annual Average Daily Traffic (AADT) for projected 20-year traffic. (2) RRR Criteria does not apply to Interstate and Freeways (3) May be reduced to <45 mph widths if conditions more nearly approach those for lower speeds (40 mph or less).				

Clear Zone widths for work zones are provided in **Table 4.2.2**. Clear Zone widths in work zones are measured from the edge of Traveled Way defined by the Temporary Traffic Control (TTC) Plan.

Base the clear zone width within work zones on the regulatory speed established for construction; i.e. Work Zone Speed. For information on Regulatory Speeds within work zones refer to **Chapter 10** of this Volume.

Table 4.2.2 Clear Zone Width Requirements for Work Zones

WORK ZONE SPEED (mph)	TRAVEL LANES & MULTILANE RAMPS (feet)	AUXILIARY LANES & SINGLE LANE RAMPS (feet)
All Speeds w/Curb & Gutter	4' Behind Face of Curb	4' Behind Face of Curb
30 to 40	14	10
45 to 50	18	10
55	24	14
60 to 70	30	18

4.2.4 Lateral Offsets

Lateral offset is the lateral distance from a specified point on the roadway, such as the edge of traveled way or face of curb, to a roadside feature or object that is more than 4 inches above grade. Lateral offset requirements apply to all roadways. The requirements for various objects or features are based on:

- Design speed,
- Location; i.e. rural areas or within urban boundary,
- Flush shoulder or with curb,
- Traffic volumes, and
- Lane type; e.g. travel lanes, auxiliary lanes, and ramps.

Rural roadways typically have sufficient right of way, to provide the required clear zone widths. Therefore, lateral offset requirements for certain features and aboveground objects are based on maintaining the required clear zone width provided in **Table 4.2.1**.

In urban areas, lateral offsets based on clear zone requirements for rural highways should be provided. However, roadways with curbing in urban areas typically do not have sufficient right of way to provide the required clear zone widths. Therefore, lateral offset requirements for these roadways are based on offsets needed for normal operation and not on maintaining a clear roadside for errant vehicles.

Table 4.2.3 provides lateral offset requirements for roadside features and aboveground objects typically encountered and considered functionally necessary for normal operation of the roadway (e.g. signing, lighting, utilities, etc.). For crashworthy objects, meet or exceed the Lateral Offset requirements provided in **Table 4.2.3**. Locate objects that are not crashworthy as close to the right of way line as practical and no closer than the lateral offsets provided.

If an aboveground object is to be placed behind a barrier that is justified for other reasons, the lateral offset to the object may be reduced to meet the setback requirements (deflection distance) of the barrier, see **Section 4.4.6**. For permissible attachments to barriers, refer to **Section 4.5**.

Table 4.2.3 Lateral Offset Criteria

Design Element		Urban Curb or Curb and Gutter Design Speed ≤ 45 mph			All Other
		New Construction	RRR	TDLC	
Light Poles	Conventional ⁽¹⁾ Lighting	Do not locate in Medians, except in conjunction with barriers that are justified for other reasons			
	High Mast Lighting	4 feet from face of curb	1.5 feet from face of curb	1.5 feet from face of curb	20 feet from Travel Lane, 14 feet from Auxiliary Lane or Clear Zone width, whichever is less
Signal Poles and ⁽¹⁾ Controller Cabinets		Do not locate in Medians			
		4 feet from face of curb	1.5 feet from face of curb	1.5 feet from face of curb	Outside Clear Zone
Traffic Infraction Detectors		For Traffic Infraction Detector placement and installation specifications, refer to the State Traffic Engineering and Operations Office web page: http://www.dot.state.fl.us/trafficoperations/			
ITS Poles and Related Items	Pole and ⁽¹⁾ Other Aboveground Fixed Objects	Do not locate in Medians, except in conjunction with barriers that are justified for other reasons			
		4 feet from face of curb		1.5 feet from face of curb	Outside Clear Zone
	Equipment Shelters and Towers	Do not locate within the limited-access right of way, except as allowed by Policy No. 000-625-025 , Telecommunications Facilities on Limited Access Rights of Way.			
	Breakaway Objects	4 feet from face of curb		1.5 feet from face of curb	As Close to R/W as possible
(1) When location within sidewalk is necessary, provide a minimum 4 feet unobstructed sidewalk (not including width of curb).					

Table 4.2.3 Continued Lateral Offset Criteria

Design Element		Urban Curb or Curb and Gutter Design Speed ≤ 45 mph			All Other
		New Construction	RRR	TDLC	
Traffic ⁽¹⁾ Control Signs	Single and Multi-Column	Locate in accordance with Design Standards . Use breakaway supports whether inside or outside the clear zone			
	Overhead Sign Supports	Outside Clear Zone			
Aboveground ⁽²⁾ Fixed Utilities (AFUs)	New AFUs Other than mid-span poles	≥ 4 feet from face of curb and as close to R/W as practical		1.5 feet from face of curb and as close to R/W as practical	Outside Clear Zone, and as close to R/W as practical
	New AFUs ⁽³⁾ Mid-span poles at intersecting roadways	≥ 4 feet from face of curb			Outside Clear Zone, and as close to R/W as practical
	Existing AFUs	Relocate as close to the R/W as practical and no closer than the below offsets:			
4 feet from face of curb		1.5 feet ⁽⁴⁾ from face of curb	1.5 feet from face of curb	Outside ⁽⁴⁾ Clear Zone	
Trees	Where the diameter is or is expected to be > 4 inches measured 6 inches above the ground	4 feet from face of curb	1.5 feet ⁽⁵⁾ from face of curb	4 feet from face of curb (1.5 feet under constrained conditions)	Outside Clear Zone
<p>(1) When location within sidewalk is necessary, provide a minimum 4 feet unobstructed sidewalk (not including width of curb).</p> <p>(2) Aboveground Fixed Utilities are objects owned by a public or private utility agency that are more than 4 inches above the grade and are not accepted by FDOT as crashworthy (such as strain poles, down guys, telephone load pedestals, temporary supports, etc.)</p> <p>(3) Mid-span poles are new poles being installed as part of and within the alignment of an existing pole line.</p> <p>(4) Existing AFUs are not to be relocated for RRR Projects unless they are adjacent to added or widened lanes or have been hit 3 times in 5 years.</p> <p>(5) Requirements provided for Existing trees. Meet New Construction requirements for New Plantings.</p>					

Table 4.2.3 Continued Lateral Offset Criteria

Design Element	Urban Curb or Curb and Gutter Design Speed ≤ 45 mph			All Other
	New Construction	RRR	TDLC	
Railroad Grade Crossing Traffic Control Devices	Locate in accordance with <i>Design Standards, Index 17881</i> and <i>Index 17882</i>			
Roadways Overpassing Railroads	For Horizontal Clearances where roadways overpass railroads refer to <i>Chapter 6</i> of this Volume.			
Canal and Drop-off Hazards	See <i>Section 4.3</i>			
Bridge Piers and Abutments ^{(6) (7)}	The greater of the following: 16 feet from Edge of Travel Lane; or Outside Curb: 4 feet from face of curb Median: 6 feet from Edge of Traffic Lane (See <i>Section 4.4.5.4</i> for Pier Protection criteria and <i>Figures 2.10.4.A</i> and <i>2.10.4.B</i>)			Outside Clear Zone
Drainage Structures (e.g. Wingwalls, Endwalls, and Flared End Sections)	Refer to the <i>FDOT Drainage Manual</i>			
Mailboxes	Locate in accordance with <i>Design Standards, Index 532</i>			
Bus Benches and Transit Shelters	Locate in accordance with <i>Rule Chapter 14-20.003, Florida Administrative Code</i> . Transit bus benches must be located in accordance with <i>Rule Chapter 14-20.0032, F.A.C.</i>			
Other Roadside Obstacles ⁽¹⁾	4 feet from face of curb	1.5 feet from face of curb		Outside Clear Zone

(1) When location within sidewalk is necessary, provide a minimum 4 feet unobstructed sidewalk (not including width of curb).
 (6) Coordinate with Vertical Clearance requirements in *Section 2.10* of this Volume.
 (7) When shielding is used refer to setback requirements for barriers in *Section 4.4.6* and *Section 2.10* of this Volume.

4.2.5 Control Zones

Control Zones apply only to RRR projects and do not include Aboveground Fixed Utilities (AFUs).

Control Zones are high-risk areas in which roadway departures occur with greater frequency which increases the risk of impact with aboveground objects. To address this condition, lateral offset and clear zone width requirements in Control Zones are to be based on New Construction criteria. A Control Zone violation is when RRR lateral offset requirements are met, but New Construction criteria is not. Control Zone violations are to be treated as Design Variations.

Control Zones include the following:

1. A location where an aboveground object has been hit 3 times or more in the last 5 years.
2. Intersection Radii – Within the New Construction lateral offset of the return radii of an intersecting street from begin point of tangent (PT) to end point of tangent (PT), see **Figure 4.2.4**.

Figure 4.2.4 Intersection Radii

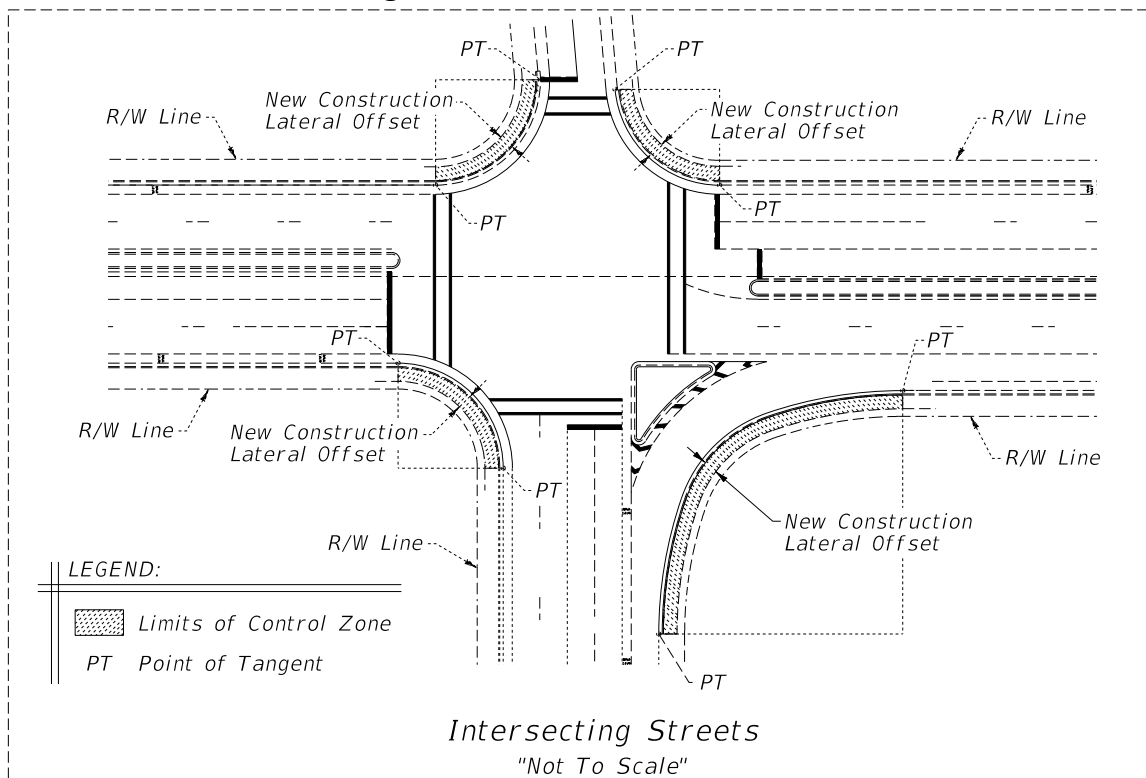

- 'T' Intersection – On the non-intersection side of 'T' intersections within the area directly across and between each radii return point of tangent (PT) extended to the New Construction lateral offset, see **Figure 4.2.5**.

Figure 4.2.5 'T' Intersection

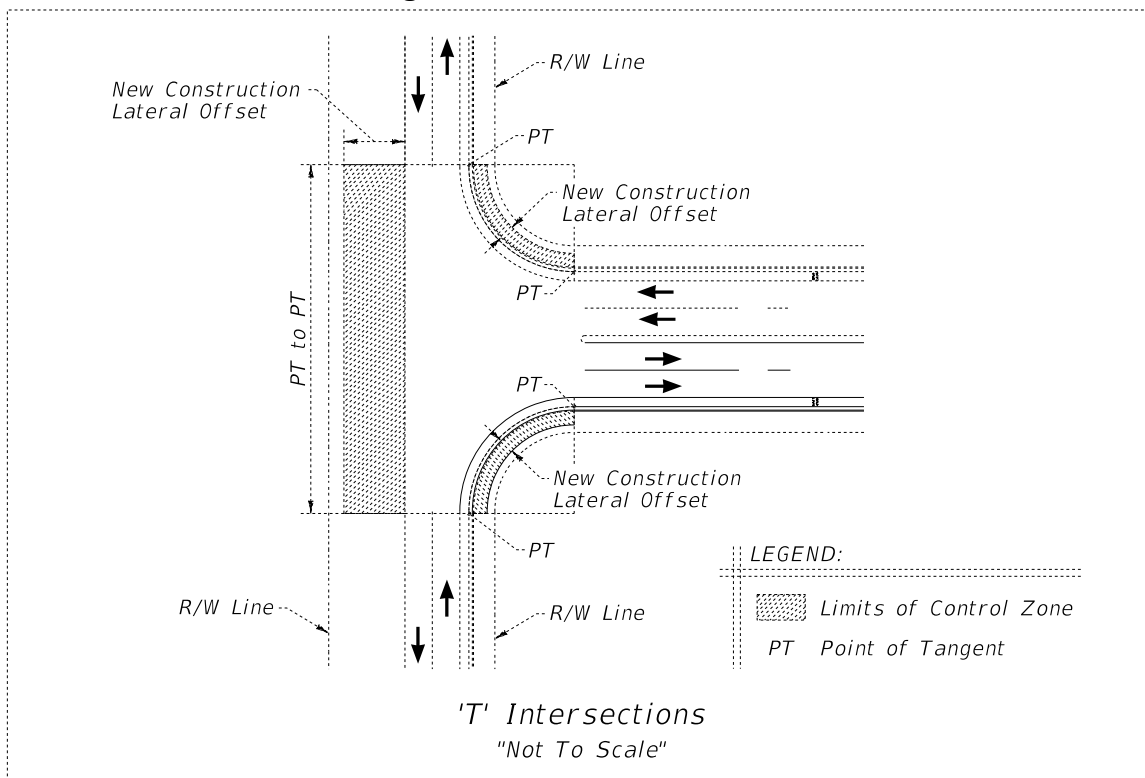

- Right Turn Deceleration – Within the New Construction lateral offset for a length of 100 feet measured downstream from the beginning of the full width lane, see **Figure 4.2.6** for right turn deceleration lane on a tangent. For right turn deceleration lane constructed with a reverse curve the beginning of the Control Zone starts at the point of intersection (PI), see **Figure 4.2.7**.
- Merge Section – Within the New Construction lateral offset for a length of 100 feet measured downstream from the beginning of the taper of a skewed merge section. See **Figure 4.2.8** for merge section constructed on a tangent. For merge section constructed with a reverse curve the beginning of the Control Zone starts at the point of intersection (PI), see **Figure 4.2.9**.
- Service Facility (i.e. alley way or easement) Driveway – For a distance of 3 feet from a driveway flare within the new construction lateral offset distance at the intersection of a dedicated intersecting service facility, see **Figure 4.2.10**.

Figure 4.2.6 Right Turn Deceleration with Tangent

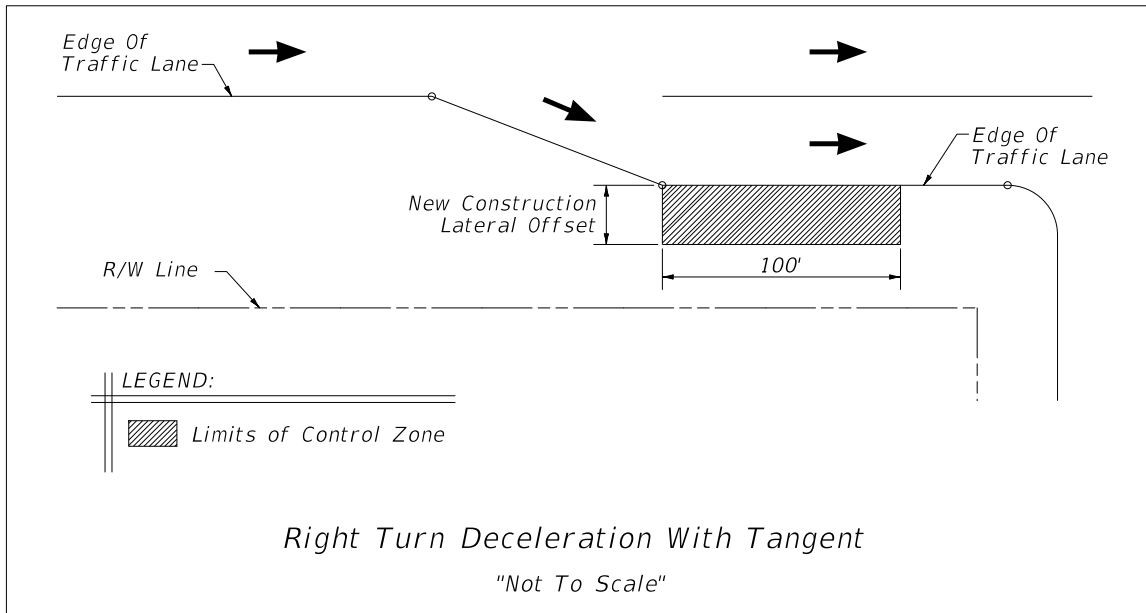

Figure 4.2.7 Right Turn Deceleration with Reverse Curve

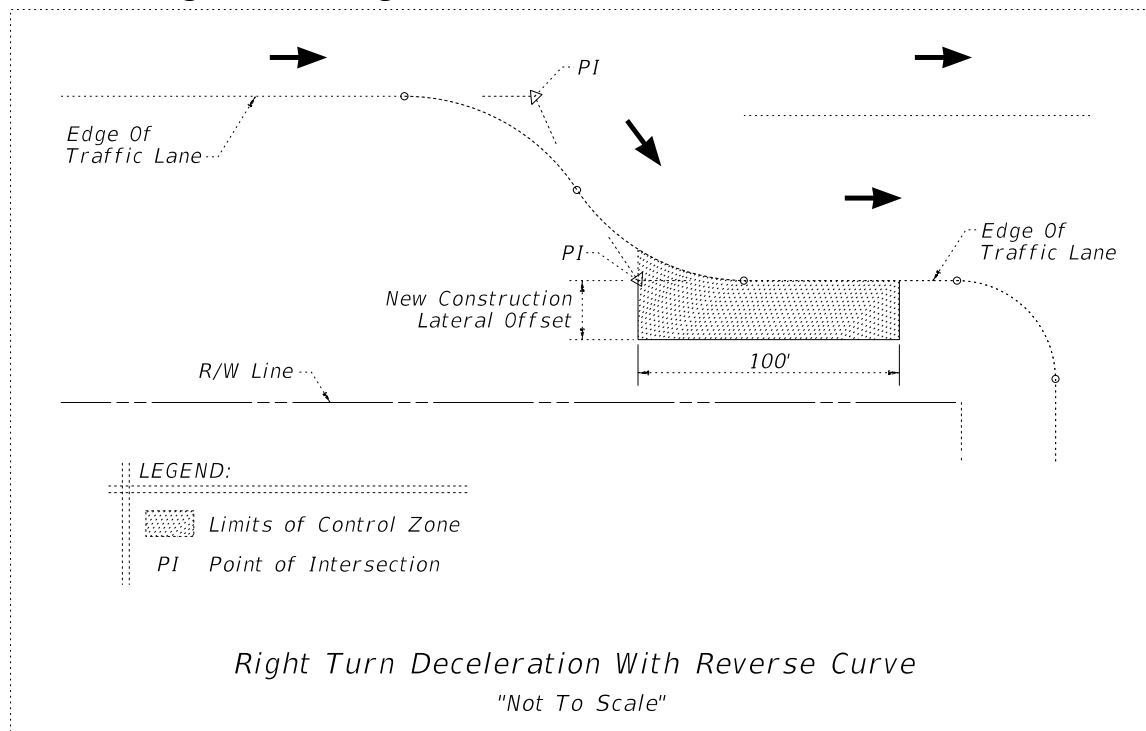

Figure 4.2.8 Merge Section with Tangent

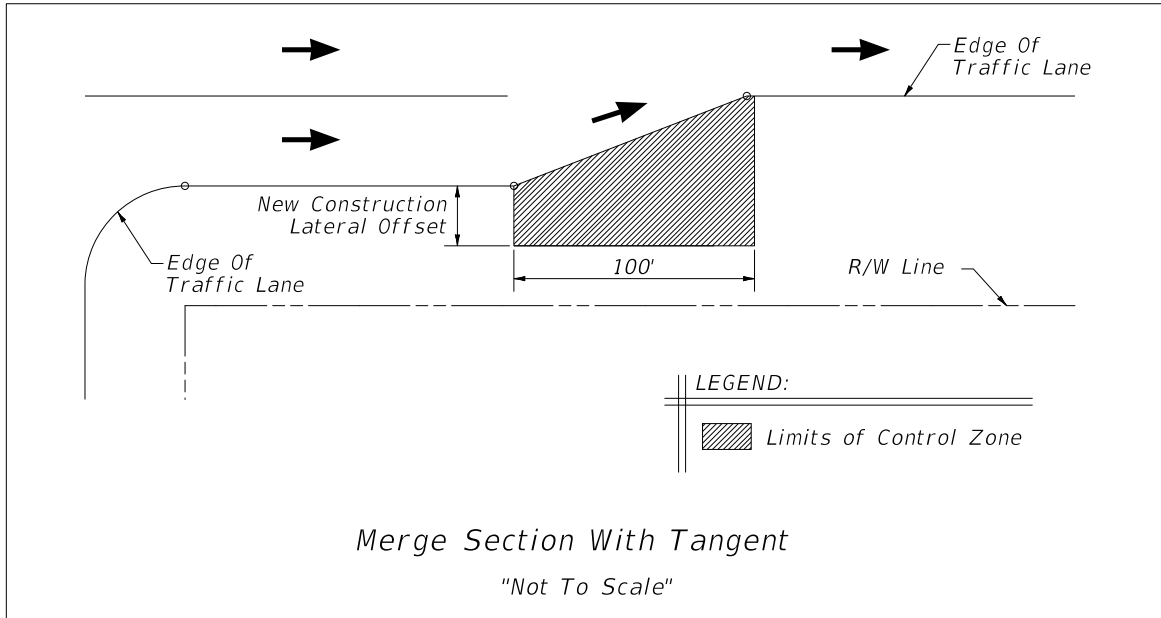

Figure 4.2.9 Merge Section with Reverse Curve

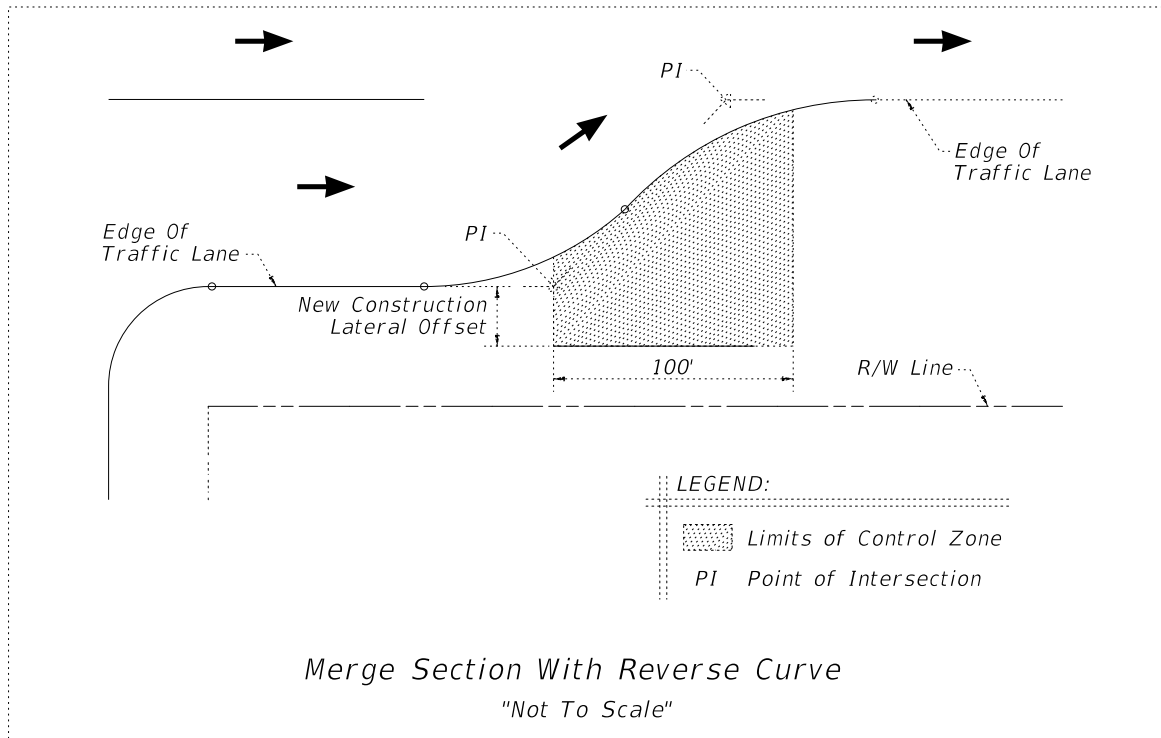
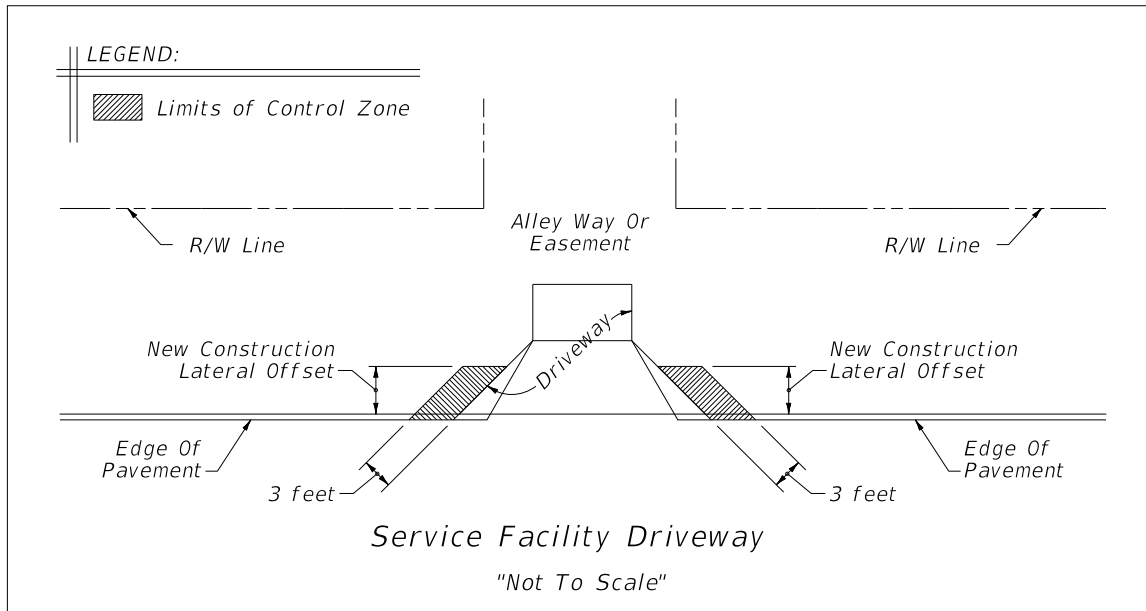
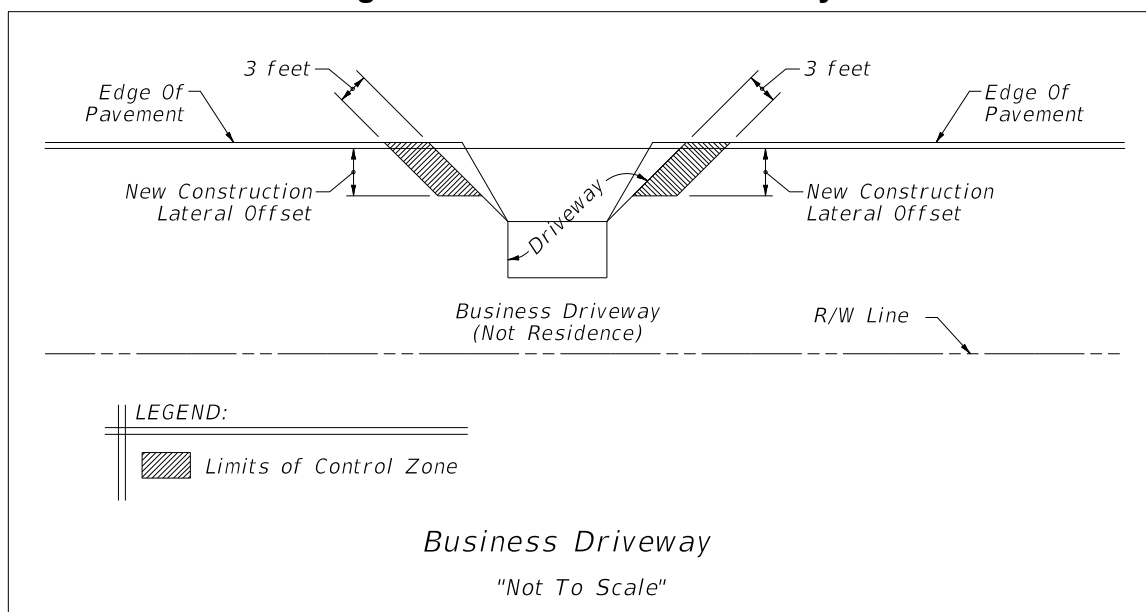

Figure 4.2.10 Service Facility Driveway



7. Business (i.e. non-residential) Driveway – For a distance of 3 feet from a driveway flare within the new construction lateral offset distance at the entrance turnout for use other than a private residence, see **Figure 4.2.11**.

Figure 4.2.11 Business Driveway



8. Horizontal Curves – Within the New Construction lateral offset in the outside area of a curve when the posted speed is greater than 35 mph and the curve radius is 3000 feet or less, see **Figure 4.2.12**.

Figure 4.2.12 Horizontal Curve

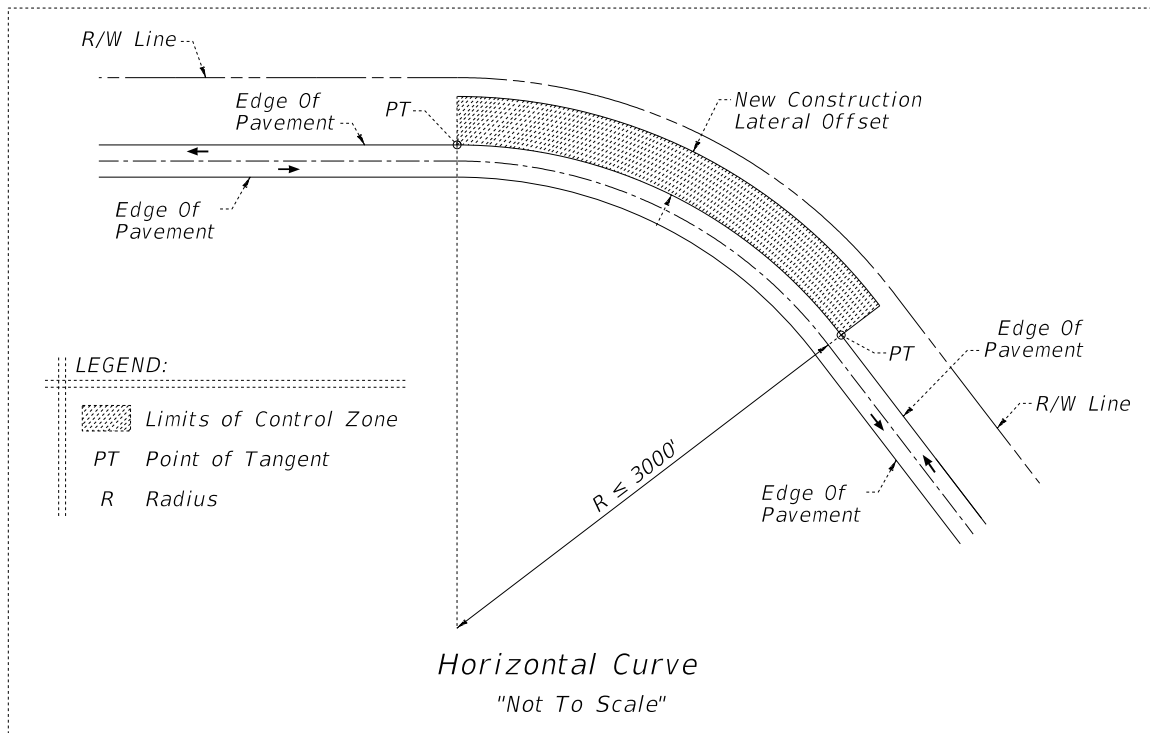

9. Roadway Deflection without Curves – Within the New Construction lateral offset of roadway alignments with a deflection (kink) of more than 5 degrees for a distance of 100 feet from the point of intersection of the deflection, see **Figure 4.2.13**.

Figure 4.2.13 Roadway Deflection without Curve

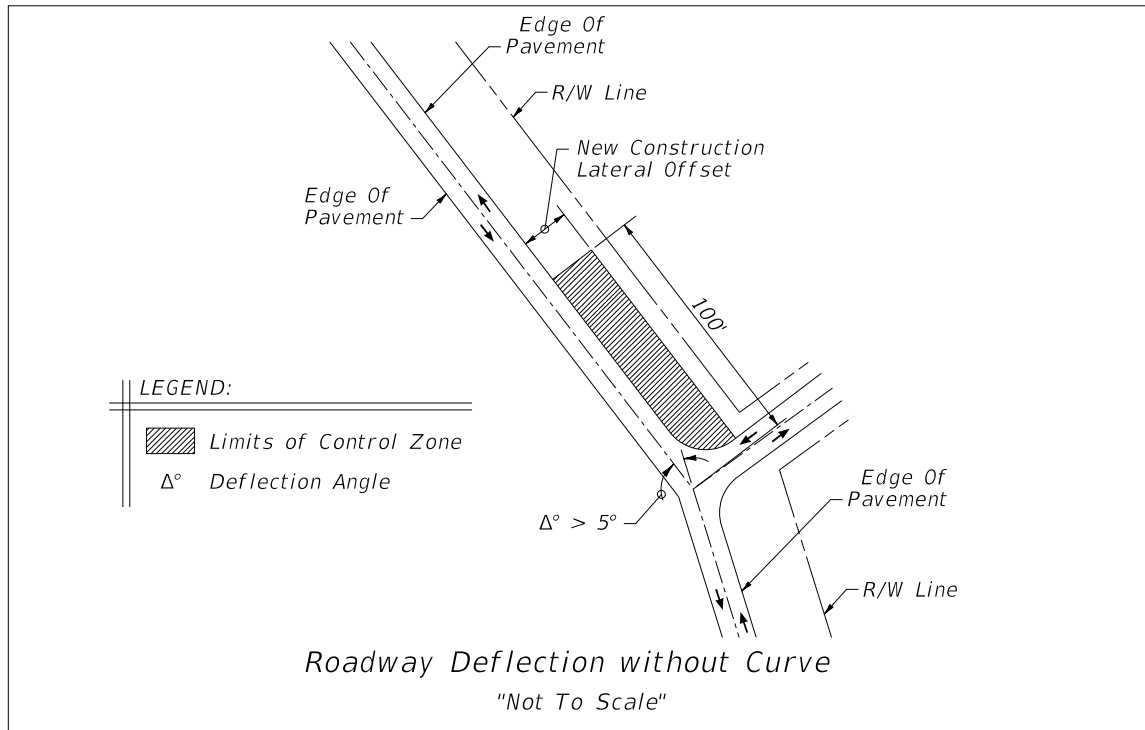

4.2.6 Roadside Slope Criteria

Roadside slopes consist of front slopes, back slopes, and transverse slopes.

4.2.6.1 New Construction Slope Criteria

New Construction Roadside Slope criteria is provided in **Table 4.2.4**.

For slopes steeper than 1:3, consider the associated long term erosion control and maintenance costs. Coordinate the use of these slopes with the District Drainage, Maintenance, and Landscape Architect's Offices. For sod or turf slopes steeper than 1:3 and higher than 20 feet, provide a 10 foot wide flat (1:10 or flatter) area at the top and toe with suitable access for maintenance equipment. For sod or turf slopes steeper than 1:3 and higher than 35 feet, include a 10 foot wide flat maintenance berm not more than every 35 feet from the top of the slope. Slopes steeper than 1:2 require coordination with the District Geotechnical Office.

Modification for Non-Conventional Projects:

Delete the second and last sentences in above paragraph and see RFP for requirements.

For retaining walls greater than 5 feet in height, provide a 10 foot flat area in front of the wall face with suitable access for maintenance vehicles. See **Structures Design Guidelines (SDG)**, Section 3.12 for information regarding partial height walls.

4.2.6.2 RRR Slope Criteria

Meet the Roadside Slope criteria provided in **Table 4.2.4** on RRR projects, except for the following:

1. Front Slopes:
 - a. For constrained conditions, new slopes at 1:4 may be constructed within the Clear Zone.
 - b. Existing 1:3 or flatter slopes within the Clear Zone may remain.
 - c. Flattening slopes of 1:3 or steeper at locations where run-off-the-road type crashes are likely to occur (e.g., on the outsides of horizontal curves) should be evaluated.
 - d. Existing front slopes steeper than 1:3 within the Clear Zone should be evaluated for shielding.
2. Back Slopes:
 - a. For constrained conditions, new slopes at 1:3 may be constructed within the Clear Zone.
 - b. Existing 1:2 or flatter slopes may remain.
 - c. Existing back slopes steeper than 1:3 within the clear zone should be evaluated for shielding.

When the above criteria are applied, RRR lateral offset and clear zone requirements must also be met.

Modification for Non-Conventional Projects:

Delete **Section 4.2.6.2** and see RFP for requirements.

Table 4.2.4 Roadside Slopes

TYPE OF FACILITY	RURAL & URBAN FREEWAYS, RURAL & URBAN ARTERIALS AND COLLECTORS, WITH AADT \geq 1500 ⁽²⁾ (INCLUDING SUBURBAN TYPICALS) DESIGN SPEED > 45 mph		RURAL ARTERIALS AND COLLECTORS WITH AADT < 1500 ⁽²⁾ , URBAN ARTERIALS AND COLLECTORS WITHOUT CURB & GUTTER ALL SPEEDS		URBAN ARTERIALS AND COLLECTORS WITH CURB & GUTTER DESIGN SPEED \leq 45 mph	
	Height ⁽¹⁾ of Fill (feet)	Rate	Height ⁽¹⁾ of Fill (feet)	Rate	Height ⁽¹⁾ of Fill (feet)	Rate
Front Slope	0.0 - 5 5 - 10 10 - 20 >20	1:6 1:6 to edge of Clear Zone then 1:4 1:6 to edge of Clear Zone then 1:3 1:2 (with guardrail)	0.0 - 5 5 - 20 >20	1:6 Where R/W is insufficient, 1:6 to edge of Clear Zone then 1:3 1:6 to edge of Clear Zone then 1:3. Where, R/W is insufficient, 1:6 to edge of Clear Zone then 1:2. 1:2 (with guardrail)	All	1:2 or to suit property owner, not flatter than 1:6. R/W cost must be considered for high fill sections in urban areas
Back Slope	All	1:4 or 1:3 with a standard width trapezoidal ditch and 1:6 front slope	All	1:4 when R/W permits or 1:3	All	1:2 or to suit property owner. Not flatter than 1:6.
Transverse Slopes	All	1:10 or flatter (freeways) 1:4 (others)	All	1:4	All	1:4

(1) Height of Fill is the vertical distance from the edge of the outside travel lane to the toe of front slope.
 (2) Annual Average Daily Traffic (AADT) for projected 20-year traffic.

4.2.7 Drainage Features

Drainage design is an important aspect of the long-term performance of a roadway, and to achieve an effective design, drainage features are necessary in close proximity to travel lanes. These features include ditches, curbs, and drainage structures (e.g. transverse/parallel pipes, culverts, endwalls, wingwalls, and inlets). The placement of these features are to be evaluated as part of roadside safety design. Refer to the Drainage Manual for information regarding proper hydraulic design.

When evaluating the design of roadside topography and drainage features, consider the future maintenance implications of the facility. Routine maintenance or repairs needed to ensure the continued function of the roadway slopes or drainage may lead to long-term expenses and activities, which disrupts traffic flow and exposes maintenance personnel to traffic conditions.

4.2.7.1 Roadside Ditches

Acceptable cross section slope criteria for roadside ditches within the clear zone is provided in **Figure 4.2.14** and **Figure 4.2.15**. These roadside ditch configurations are considered traversable, as described in the **AASHTO RDG**. Adjusted clear zone widths may be required for Non-Recoverable Slopes located within the clear zone (i.e. slopes steeper than 1:4 but flatter than 1:3, see **Section 4.2.3**). The application of the ditch cross section slopes must be coordinated with Roadside Slope Criteria included in **Section 4.2.6**.

The **Drainage Manual, Chapter 2** requires a minimum ditch bottom width of 5 feet to accommodate mitered end sections and maintenance mowers. Refer to the **Drainage Manual** for V-bottom ditch limitations. When a deviation from these requirements is approved by the District Drainage Engineer the ditch cross section slope criteria provided in **Figures 4.2.14** and **4.2.15** may be used

Figure 4.2.14 Roadside Ditches – Bottom Width 0 to 4 feet

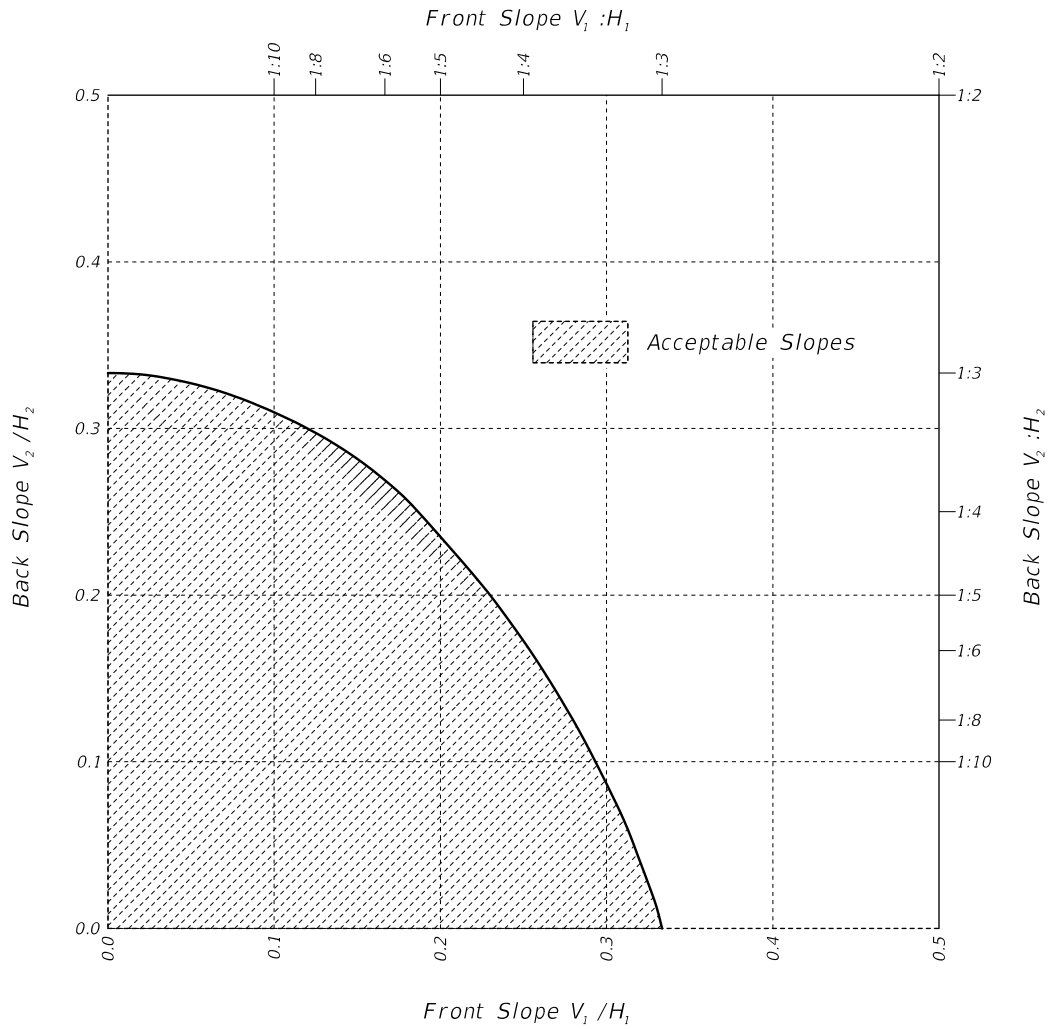
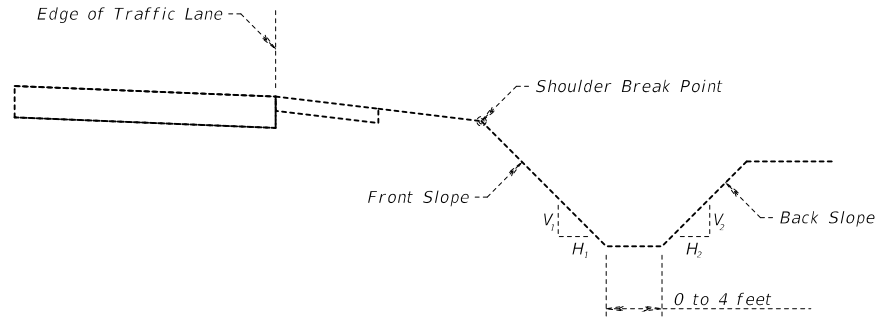

Ref: Figure 3-6, 2011 AASHTO Roadside Design Guide, 4th Edition

Figure 4.2.15 Roadside Ditches – Bottom Width \geq 4 feet

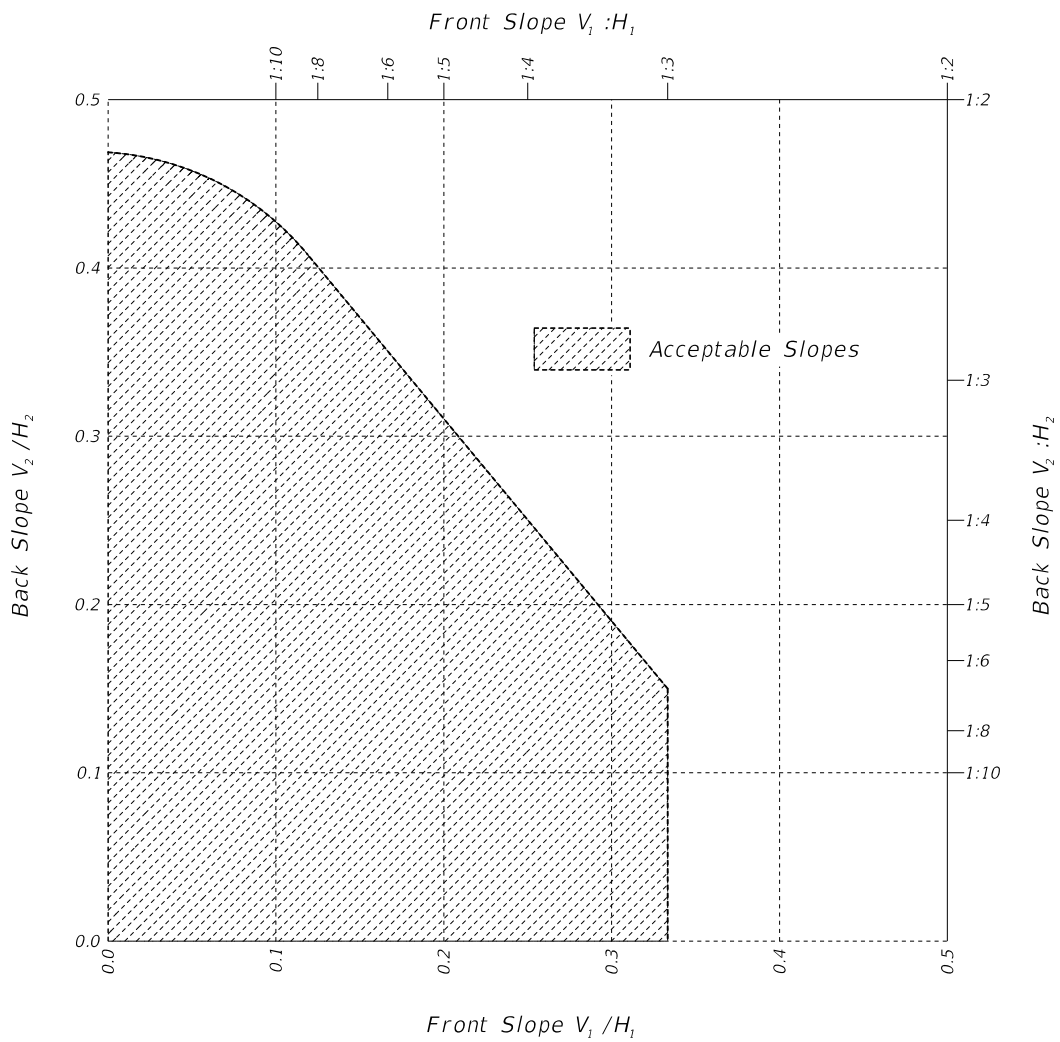
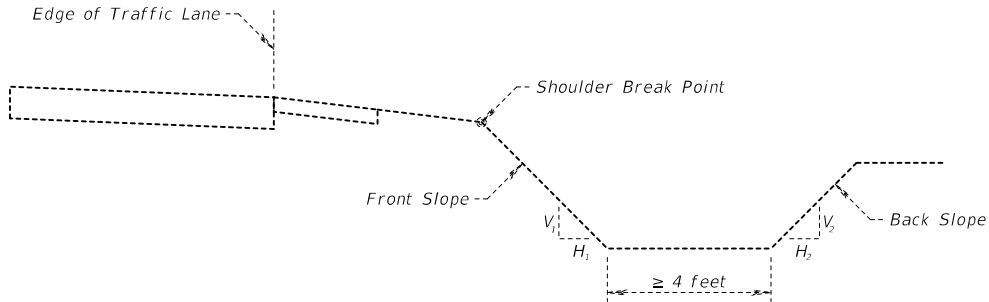

Ref: Figure 3-6, 2011 AASHTO Roadside Design Guide, 4th Edition

4.2.7.2 Curbs

Curbs with closed drainage systems are typically used in urban areas to minimize the amount of right of way needed. Curbs also provide a tangible definition of the roadway limits and delineation of access points. These functions are important in urban areas because of the following typical characteristics:

- Low design speed (Design Speed \leq 45 mph);
- Dense abutting development;
- Closely spaced intersections and accesses to property;
- Higher traffic, bicyclists and pedestrian volumes, and;
- Restricted right of way.

It should be noted that curbs have no redirection capabilities except at speeds less than the lowest design speeds used on the State Highway System. Therefore, curb should not be considered effective in shielding a hazard and is not to be used to reduce lateral offset requirements.

See *Design Standards, Index 300*, for standard FDOT curb shapes. Typical applications for FDOT roadways include Type E and Type F curbs. Both curb types have a sloped face; however, the Type E has a flatter face to allow vehicles to traverse it more easily. Shoulder Gutter is also frequently used along roadway fill sections and bridge approaches to prevent excessive runoff down embankment slopes. Refer to the Drainage Manual for Shoulder Gutter requirements.

Curbs are not permitted on high speed roadways (Design Speed $>$ 45 mph) except for high speed urban and suburban sections, median openings, and transit stops. Use only Type E curb on high speed roadways with the face of the curb placed at the following offsets:

- High Speed Urban and Suburban Section
 - See *Section 2.16* of this Volume for requirements.
- Directional Median Openings
 - See *Design Standards, Index 527*.
- Transit Stops
 - The curb face must be no closer to the edge of the traveled way than the required full width shoulder for a flush shoulder roadway.

4.2.7.3 Drainage Structures

Drainage structures, and their associated end treatments, located along the roadside should be implemented using either a traversable design or located outside the required clear zone. The various drainage inlets and pipe end treatments needed for an efficient drainage design typically contain curb inlets, ditch bottom inlets, endwalls, wingwalls, headwalls, flared end sections and/or mitered end sections. If not adequately designed or properly located, these features can create hazardous conditions (e.g. abrupt deceleration or rollovers) for vehicles. For detailed background information concerning traversable designs, refer to the **AASHTO RDG**.

Design Standards for drainage structures and end treatments are provided in the **Index 200 Series**. Drainage features shown in the **Design Standards** have the potential for conflict with a vehicle either departing the roadway or within a commonly traversed section of a roadway. Refer to the **Drainage Manual** for those standard drainage structures which are permitted within the Clear Zone.

4.2.7.4 Drainage Structures in RRR Projects

For RRR projects, evaluate existing drainage structures and end treatments located within the clear zone to determine if they present a potentially hazardous condition and whether or not the existing conditions necessitate relocation. At a minimum, review crash history and relocate any drainage structures impacted 3 times in 5 years. Side drains without mitered end sections, should be evaluated for replacement if they constitute an aboveground hazard.

New drainage structures added on RRR projects must meet New Construction location criteria.

4.2.8 Traffic Separators

Traffic separators are used to provide delineation of narrow roadway medians, manage access points and turning movements, provide for drainage, and offer pedestrian refuge areas. Refer to the **Section 2.16.4** of this Volume, the **Florida Intersection Design Guide**, and **Design Standards, Index 302** for additional information.

Bridge mounted traffic separators are intended to match up geometrically with adjacent roadway traffic separators or the face of curb. Design separators on new and reconstruction projects in accordance with the **Structures Design Guidelines**, and **Design Standards, Index 302**.

4.2.9 Signing, Lighting, Traffic Signals, and Other Similar Roadside Features

Locate devices in accordance with **Chapter 7** and the Lateral Offset requirements provided in **Section 4.2.4**. These devices may be installed within the lateral offset distance behind a traffic barrier, provided the barrier was justified for other reasons and the device is located within the barrier's Length of Need (See **Section 4.4.6**).

Sign supports and conventional light poles, except overhead cantilever, truss type or bridge or barrier wall mounted, must be breakaway as defined in the **AASHTO LRFD Specifications for Structural Supports for Highway Signs, Luminaires, and Traffic Signals** and the **AASHTO RDG**, unless installed behind a barrier. Sign supports must be of an acceptable and crashworthy design as detailed in the **Design Standards**.

Do not locate high mast lighting poles in gore areas within the runout length as defined in the **AASHTO RDG, Section 5.6.4**.

4.2.10 Roadside Flashing Beacon Assemblies

Roadside flashing beacon assemblies installed in accordance with **Design Standards, Index 11862** are considered crashworthy and are permitted within the clear zone. Locate in accordance with the offset in **Design Standards, Index 17302**. Other ground mounted flashing beacon assemblies located within clear zone must be either crash tested or located behind a barrier that has been justified for other reasons. Flashing beacon assemblies that are mounted on mast arms are exempt from this requirement.

4.2.11 Mailbox Supports

See **Design Standards** for requirements.

4.2.12 Bus Benches and Transit Shelters

Refer to **Table 4.2.3** for criteria on the placement of benches and shelters.

4.2.13 Breakaway Devices

The criteria for breakaway supports is covered in the *AASHTO RDG, Chapter 4*. Department-approved breakaway devices are covered in the *Design Standards* and included on the Approved Products List (*APL*).

Breakaway devices are designed to be impacted at normal bumper heights with vehicles traveling along relatively flat level ground. If impacted at a significantly higher point the breakaway mechanism may not function as designed resulting in non-activation or improper fracturing of the device. For this reason do not locate breakaway supports in ditches or along slopes steeper than 1:6.

4.2.14 Other Appurtenances

Locate these devices in accordance with the *Design Standards* and *Table 4.2.3*.

4.3 Roadside Hazards

4.3.1 Aboveground Hazards

An aboveground hazard is anything within the Clear Zone that is greater than 4 inches in height and is firm and unyielding or doesn't meet breakaway criteria. Evaluate the location of temporary and permanent aboveground hazards and ensure that their placement is in accordance with the Lateral Offset and Clear Zone requirements of **Section 4.2**.

Curbs are not considered an aboveground hazard when utilized in accordance with **Section 4.2.7.2**.

4.3.1.1 Aboveground Hazards in Work Zones

Aboveground hazards in work zones are to be considered part of the “work area” and treated with appropriate work zone traffic procedures included in the **Design Standards, Index 600 Series**. During non-working hours, place objects, materials, and equipment that constitute an aboveground hazard outside clear zone widths for work zones or behind a barrier.

4.3.2 Canal Hazards

A canal hazard is defined as an open ditch parallel to the roadway for a minimum distance of 1000 feet and with a seasonal water depth in excess of 3 feet for extended periods of time (i.e., 24 hours or more).

The lateral offset requirements for canal hazards exceed standard Clear Zone width criteria. Canal hazard lateral offsets are measured from the edge of travel lane, auxiliary lane or ramp to the top of the canal side slope nearest the road. Minimum required distances are as follows (see **Figures 4.3.1** and **4.3.2**):

- Not less than 60 feet for flush shoulder roadways with design speeds of 50 mph or greater.
- Not less than 50 feet for flush shoulder roadways with design speeds of 45 mph or less.
- Not less than 40 feet for curb or curb and gutter roadways.

When new canal or roadway alignment is required, provide distances greater than those above to accommodate future widening of the roadway.

On fill sections, provide a flat berm (1:10 or flatter slope) no less than 20 feet in width between the toe of the roadway front slope and the top of the canal side slope nearest the roadway.

When the slope between the roadway and the "extended period of time" water surface is 1:6 or flatter, the minimum distance can be measured from the edge of the travel lane, auxiliary lane, or ramp to the "extended period of time" water surface and a berm is not required.

In sections with ditch cuts, provide a minimum of 20 feet between the toe of the front slope and the top of the canal side slope nearest the roadway.

Using the following criteria, shield the canal hazard with an approved roadside barrier when the required minimum lateral offset cannot be met:

- Locate the barrier as far from the travel way as practical and outside of the Clear Zone where possible.
- Locate Guardrail no closer than 6 feet from the canal front slope.
- Locate High Tension Cable Barrier no closer than 15 feet from the canal front slope.

**Figure 4.3.1 Minimum Offsets for Canal Hazards
Rural and Urban Flush Shoulders**

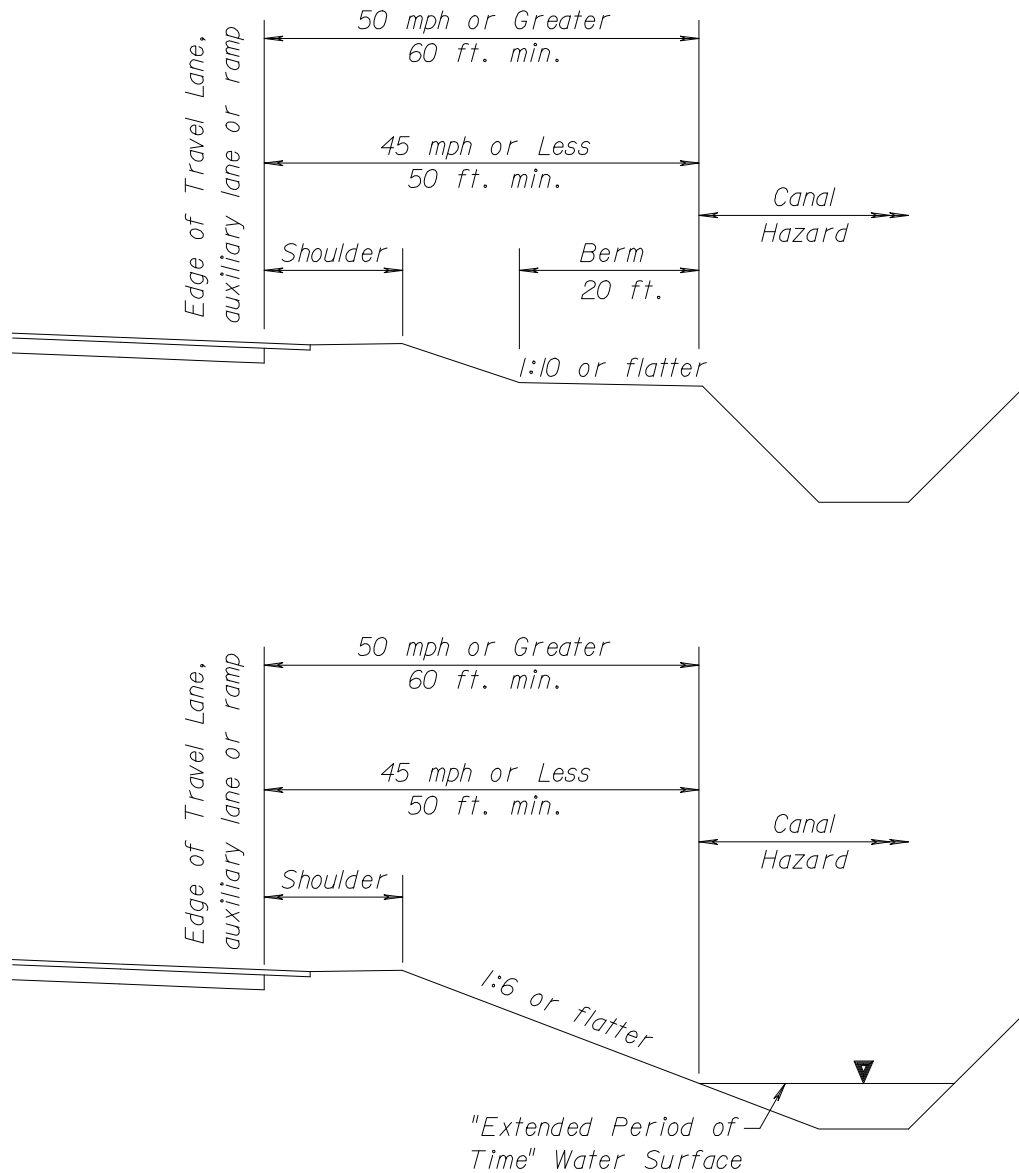

**Figure 4.3.2 Minimum Offsets for Canal Hazards
Urban Curb or Curb and Gutter**

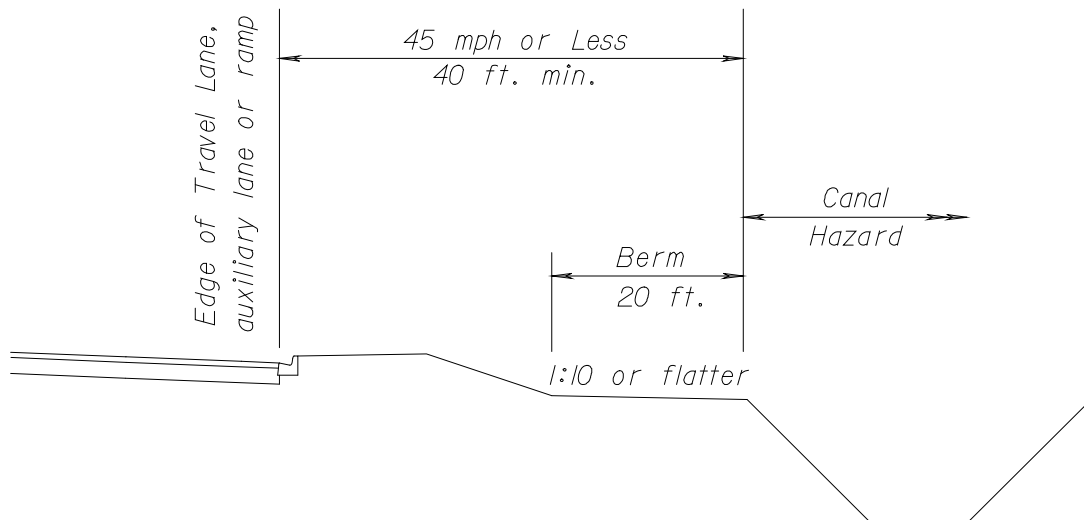

4.3.3 Drop-off Hazard

Drop-off hazards are defined as steep or abrupt downward slopes that can be perilous to vehicle occupants, pedestrians and cyclists. Shield any drop-off determined to be a hazard. Use the following guidelines in the identification of drop-off hazards for vehicles.

Drop-off hazards for vehicles:

1. Any vertical faced structure (e.g. retaining wall, wing-wall, etc.) located within the Clear Zone.
2. A drop-off of 6 feet or more with a slope steeper than 1:3 located within the Clear Zone.
3. In urban sections with curb or curb and gutter (Design Speed \leq 45 mph), a drop-off of 6 feet or greater with a slope steeper than 1:3 located within 22 feet of the traveled way (See **Figure 4.3.3**).
4. Drop-offs that have had 3 crashes within a 5 year period. Five years of crash data for a particular site can be obtained from the Safety Office.

For drop-off hazards for pedestrians and bicyclists, see **Section 8.8** of this Volume.

Figure 4.3.3 Drop-off Hazards in Urban Sections

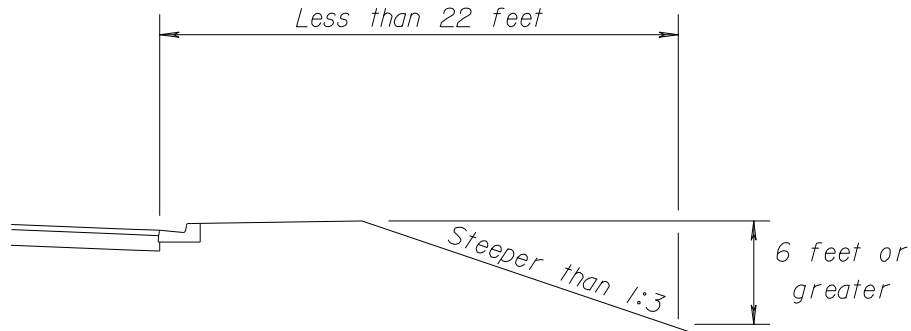

4.3.3.1 Drop-offs in Work Zones

For drop-off criteria in work zones see ***Design Standards, Index 600***. Anticipate drop-offs that are likely to occur during construction and provide the appropriate devices. For those projects where barrier wall would be needed and yet it is not practical, such as in urban areas where numerous driveways exist, add plan notes that require conditions to be returned to acceptable grade by the end of the day's operation.

4.3.4 Additional Hazard Considerations

Some roadside conditions may create situations which are hazardous for persons other than the motorist departing the roadway. Engineering judgment should be used when evaluating hazardous conditions, and should consider; roadway geometry, proximity to facility or building, level of activity, traffic conditions, etc. These conditions include, but are not limited to, bridge piers that are not designed for vehicle impact loads, bicycle and pedestrian facilities, residential buildings, schools, businesses, and the presence of personnel in work zones. Specific requirements for Bridge Pier Protection are provided in ***Section 4.4.5.4***, and for considerations regarding Positive Protection in Work Zones see ***Section 4.4.7.4***.

4.4 Longitudinal Barriers, Barrier Transitions, End Treatments & Crash Cushions

Roadside barriers, transitions, end treatments (trailing anchorages and approach terminals), and crash cushions must be full-scale crash tested in accordance with either ***NCHRP Report 350: Recommended Procedures for the Safety Performance Evaluation of Highway Features (NCHRP 350)*** or the ***AASHTO Manual for Assessing Safety Hardware, 2009 (MASH-09)***.

Bridge Traffic Railings must be evaluated and designed in accordance with the ***Structures Design Guidelines (SDG)***.

The criteria for crash testing specified in ***NCHRP 350*** and ***MASH-09*** provides six Test Levels (TL-1 thru TL-6) for the evaluation of roadside hardware suitability with consideration for vehicle type, mass, speed and impact angle. Each Test Level provides an increasing level of service in ascending numerical order. For additional information regarding appropriate application of Test Levels for Barrier Type Selection refer to ***Section 4.4.5*** and the ***AASHTO RDG***.

Barriers, transitions, and end treatments consist of both proprietary and non-proprietary devices. Non-proprietary/Standardized devices are detailed in the ***Design Standards***. Proprietary products are included on the ***APL***. These device address the majority of roadside needs on the State Highway System.

Non-standard roadside hardware (i.e. devices not included in either the ***Design Standards*** or the ***APL***) may sometimes be needed to address unique situations, but are not permitted without prior approval by the Structures Design Office (SDO) for traffic railings (e.g. bridges, noise walls and wall copings), or the Roadway Design Office (RDO) for other roadside hardware. For additional information on the use of Non-Standard Roadside Safety Hardware refer to ***Section 4.8***.

4.4.1 Standard Longitudinal Barriers

4.4.1.1 Flexible Barrier

Flexible Barrier systems provide the least severe impact conditions with the greatest deflections. The only Department-approved flexible barrier system is High Tension Cable Barrier (HTCB) and is currently available for implementation through the Departments ***Developmental Design Standards (DDS)*** process. Detailed information on the usage

requirements and design criteria of HTCB can be found on the Departments **DDS** Website (<http://www.dot.state.fl.us/rddesign/DS/Dev.shtm>), which includes the following:

- **Instructions for Developmental Design Standards (IDDS), D450**
- **Developmental Design Standards (DDS) Index D450**
- **Developmental Specification, Dev540**

When considering the use of a **Developmental Design Standards** device, review the **Developmental Design Standards Usage Process** included on the **DDS** Website (<http://www.dot.state.fl.us/rddesign/DS/Dev.shtm>).

4.4.1.2 Semi-Rigid Barrier

Semi-Rigid Barriers include the following:

1. W-Beam Guardrail – **Design Standards, Index 400**
 - a. General, TL-3 Guardrail – Post spacing at 6'-3" (TL-3, MASH)
 - b. Low-Speed, TL-2 Guardrail – Post spacing at 12'-6" (TL-2, MASH)
2. Modified Thrie-Beam Guardrail – **Design Standards, Index 400** (TL-4, NCHRP 350)

W-Beam Guardrail with posts at 6'-3" spacing, rail height of 2'-1" to center of panel and midspan splices, as detailed in **Design Standards, Index 400**, was developed based on the **31" Midwest Guardrail System (MGS)**. Compatible proprietary components may be referred by the 31" height.

TL-3 Guardrail installations may be used for all design speeds; however, installations on roadways with Design Speeds > 45 mph must have a minimum length of 75 feet, unless attached to a permanent rigid barrier.

The use of Low-Speed, TL-2 Guardrail is limited to flush shoulder roadways with Design Speeds ≤ 45 mph.

Installations of W-Beam Guardrail with 8-in offset blocks on wood or steel posts are detailed in **Design Standards, Index 400**. W-Beam guardrail may also be installed at a reduced post spacing (i.e. less than 6'-3") to reduce deflection of the system. Reduced post spacing may be used for all design speeds in accordance with spacing and setback requirements provided in **Table 4.4.2**.

The use of Thrie-Beam Guardrail panels is restricted to Modified Thrie-Beam, Thrie-Beam

Retrofits (e.g., Metal Traffic Railings) and Barrier Transitions only.

Although Modified Thrie-Beam has been crash tested to NCHRP 350, TL-4 requirements as a longitudinal barrier, it presents unique challenges due to a lack of proven options for end treatments and transitions. As a result, project specific details are required for Modified Thrie-Beam installations.

4.4.1.3 Rigid Barrier

For the purposes of design and evaluation, Rigid Barriers are assumed to exhibit no deflection under impact conditions; however, crash severity will likely be the highest of all barrier options. Rigid barrier includes Concrete Barriers and Traffic Railings. Concrete barriers are included for roadway applications and Traffic Railings are designed for structural applications (e.g. bridges, noise walls, and wall copings).

Modifications to Rigid Barriers require approval from Office of Design (SDO or RDO). Modifications may include but are not limited to the following:

- reinforcement details
- surface treatments
- material substitutions
- geometric discontinuities along the length of the barrier
- non-standardized attachments that do not meet the requirements of either this manual or **SDG**
- non-standardized and unfilled pockets or blockouts
- end transition details
- traffic face geometry

Rigid Barriers include the following:

1. Concrete Barriers (roadside applications):
 - a. Median – **Design Standards, Index 410** (TL-4, NCHRP 350)
 - b. Shoulder – **Design Standards, Index 410** (TL-4, NCHRP 350)
 - c. Pier Protection – **Design Standards, Index 411** (TL-5, NCHRP 350)
2. Traffic Railings (bridges, noise walls, and wall copings):
 - a. Bridges – **Design Standards, Index 420 thru 424** (TL-4, NCHRP 350) **Index 425** (TL-5, NCHRP 350)

- b. Thrie-Beam Retrofits – **Design Standards, Index 470 thru 476** (TL-4, NCHRP 350) **Index 477** (TL-2, NCHRP 350)
- c. Vertical Face Retrofits – **Design Standards, Index 480 thru 484** (TL-4, NCHRP 350)
Note: Use Tapered End Transition, **Index 484** Sheet 2 of 10, for Design Speed ≤ 40 mph only. Not permitted within the clear zone of approaching traffic unless site-specific justification is provided and approved by the District Design Engineer.
- d. Noise Wall – **Design Standards, Index 5210 thru 5215** (TL-4, NCHRP 350) (TL-5 option available from Structures Design Office)
- e. Wall Coping – **Design Standards, Index 6110 and 6120** (32" F-Shape and 42" Vertical, TL-4, NCHRP 350) (42" F-Shape, TL-5, NCHRP 350)

Design bridge railings in accordance with the **SDG**. On projects where an existing bridge is to remain, the bridge railings must be replaced or upgraded unless the railing meets criteria for new railings. Superseded FDOT Standard New Jersey Shape and F-Shape Traffic Railings conforming to the designs shown in the **Instructions for Design Standards (IDS), Index 402**, "A Historical Compilation of Superseded Florida Department of Transportation 'Structures Standard Drawings' for 'F' and 'New Jersey' Shape Structure Mounted Traffic Railings", are both structurally and functionally adequate.

Other former FDOT bridge traffic railings not listed above, and any other traffic railings that are not based on crash tested designs, are inadequate and must be replaced, retrofitted or an exception granted, as appropriate, using the criteria included in the **SDG**.

Details and typical applications of various bridge railings, including crashworthy pedestrian/bicycle railings and fencing, are provided in **Figures 4.4.1 – 4.4.10**.

Figure 4.4.1 Bridge Traffic Railings – F-Shapes

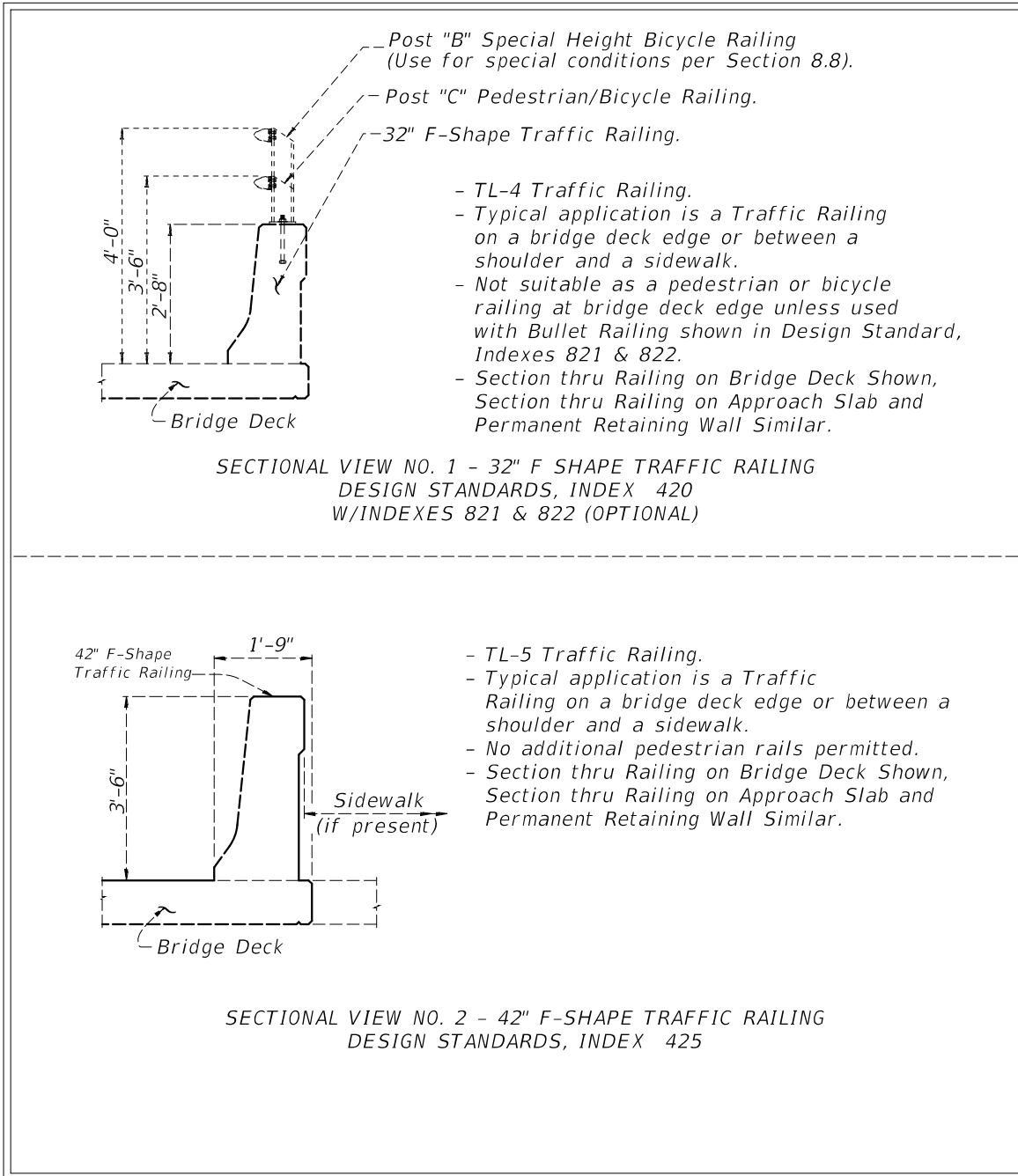

Figure 4.4.2 Bridge Traffic Railings – Vertical Shapes

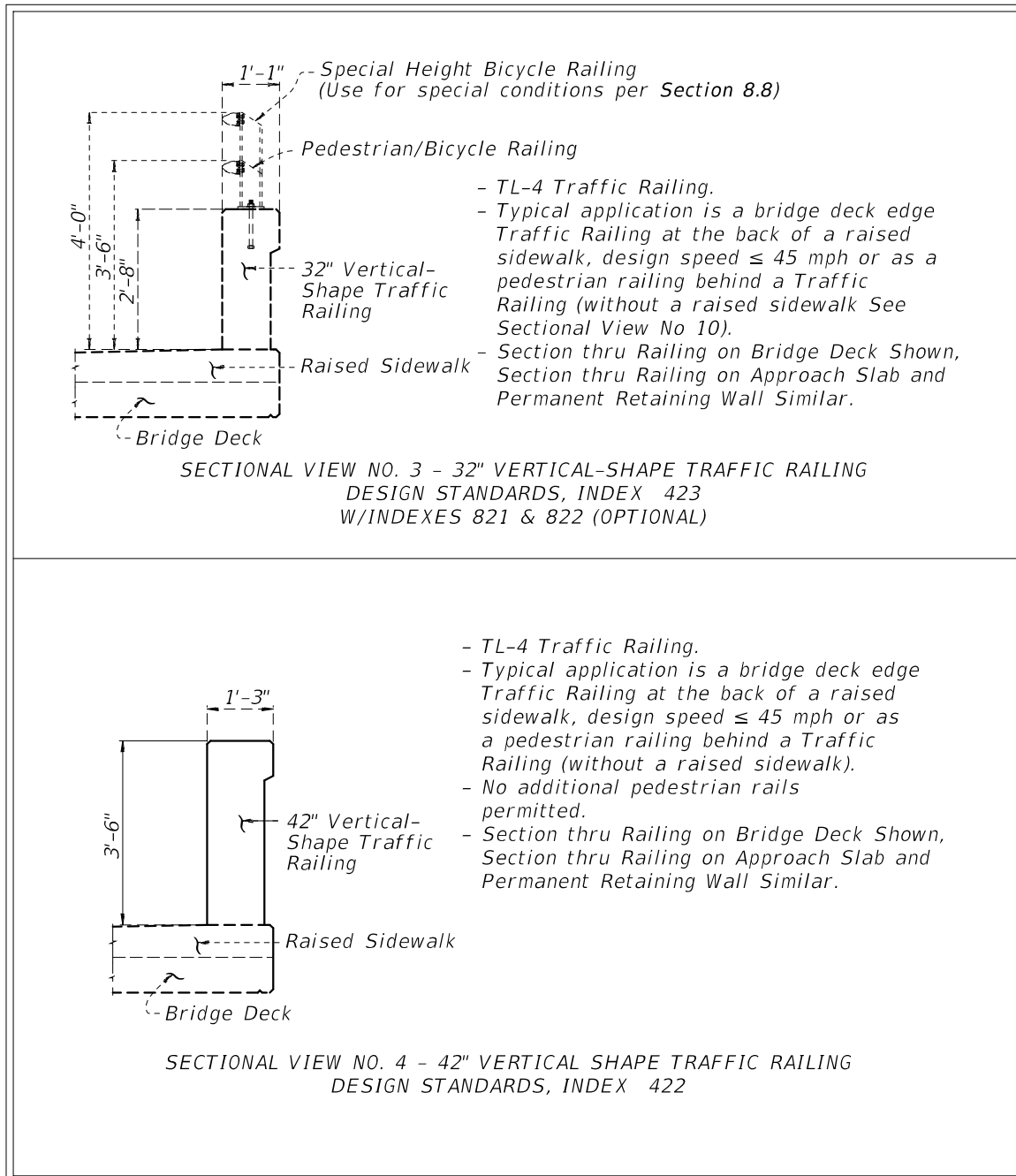

Figure 4.4.3 Bridge Traffic Railings – Other Shapes

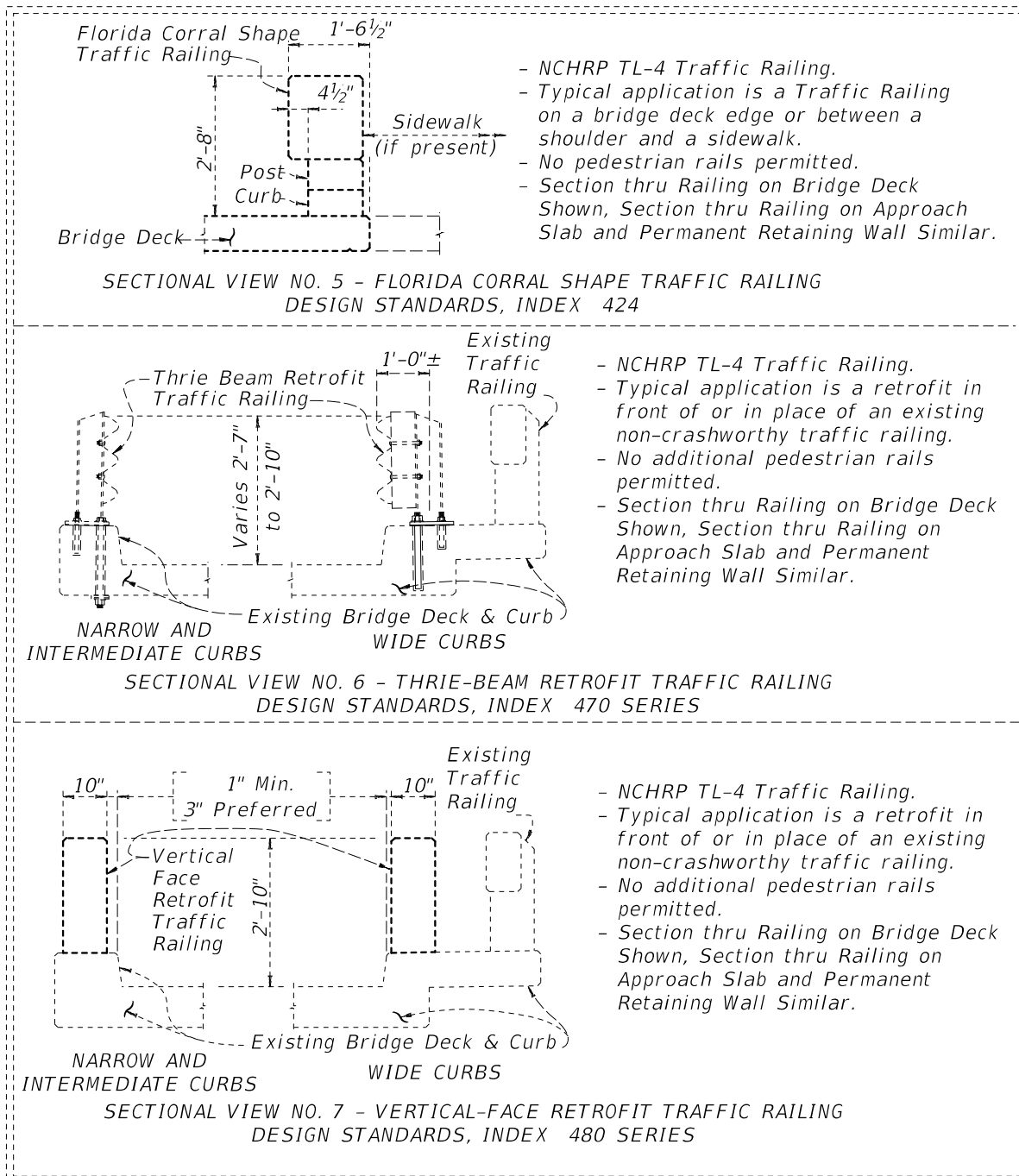

Figure 4.4.4 Bridge Traffic Railings – Median Traffic Railing and Traffic Railing/Noise Wall Combination

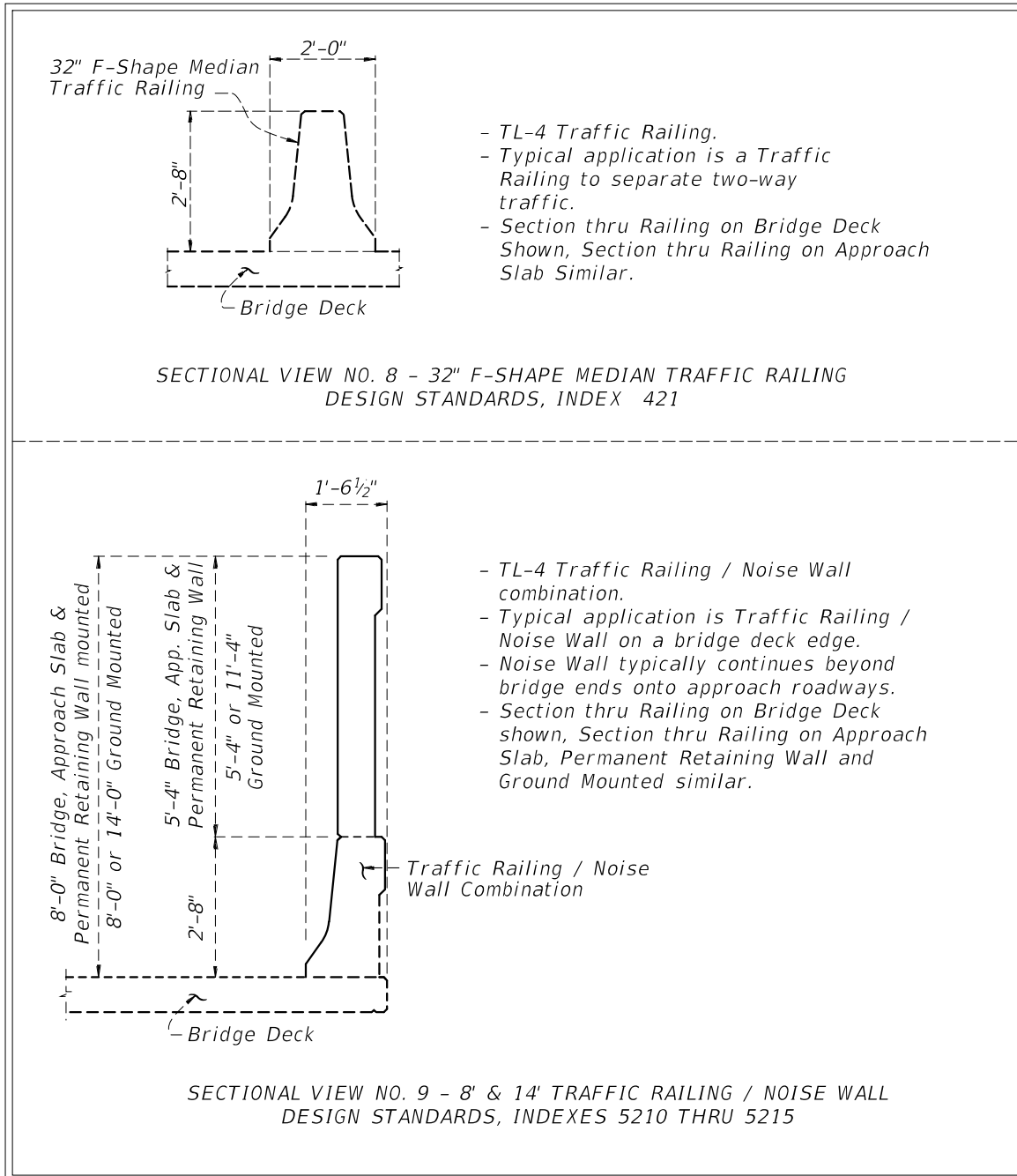

Figure 4.4.5 Bridge Railing – Pedestrian/Bicycle Railing (Index 820)

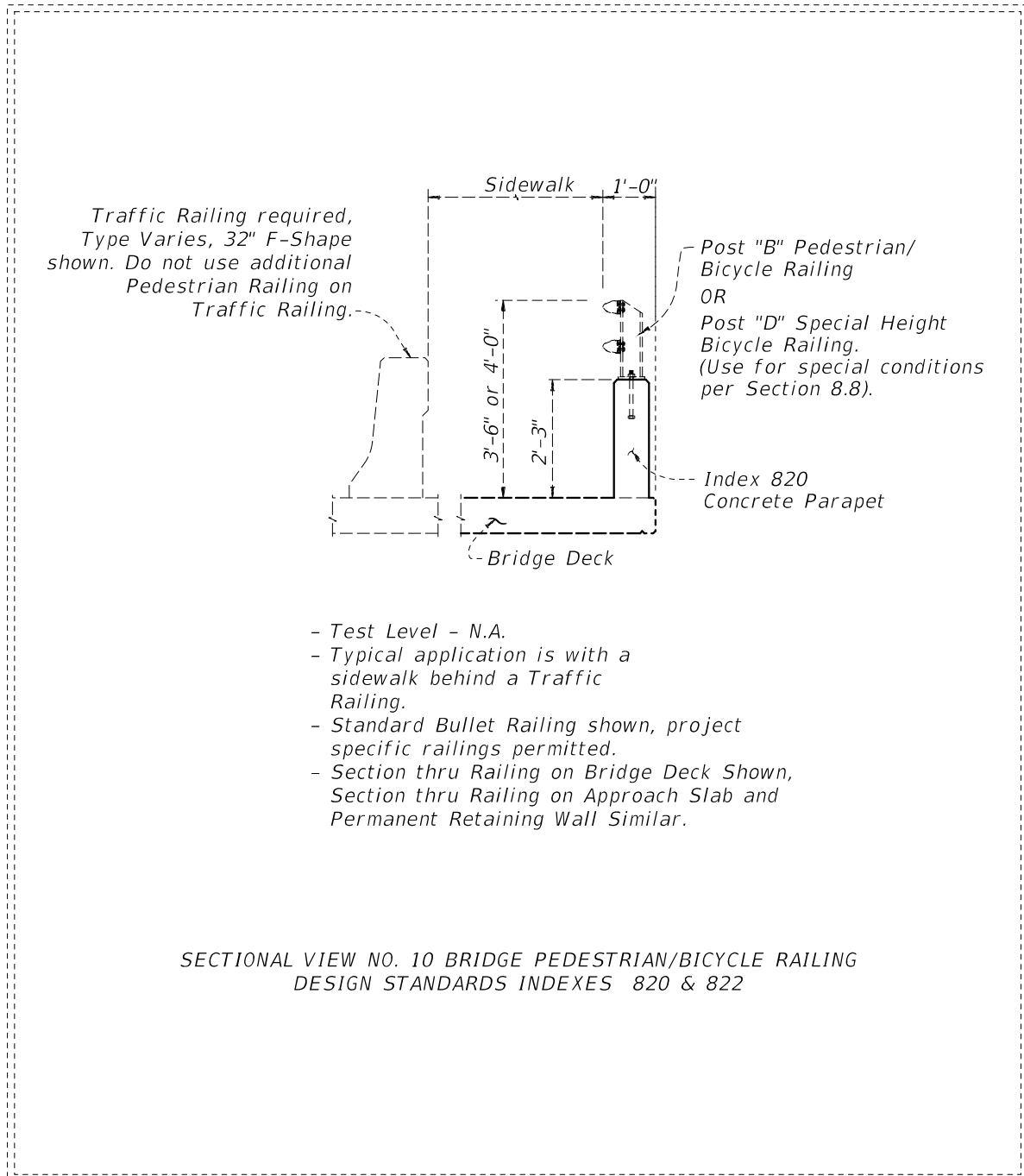

Figure 4.4.6 Bridge Railing – Pedestrian/Bicycle Railing (Index 851 & 861)

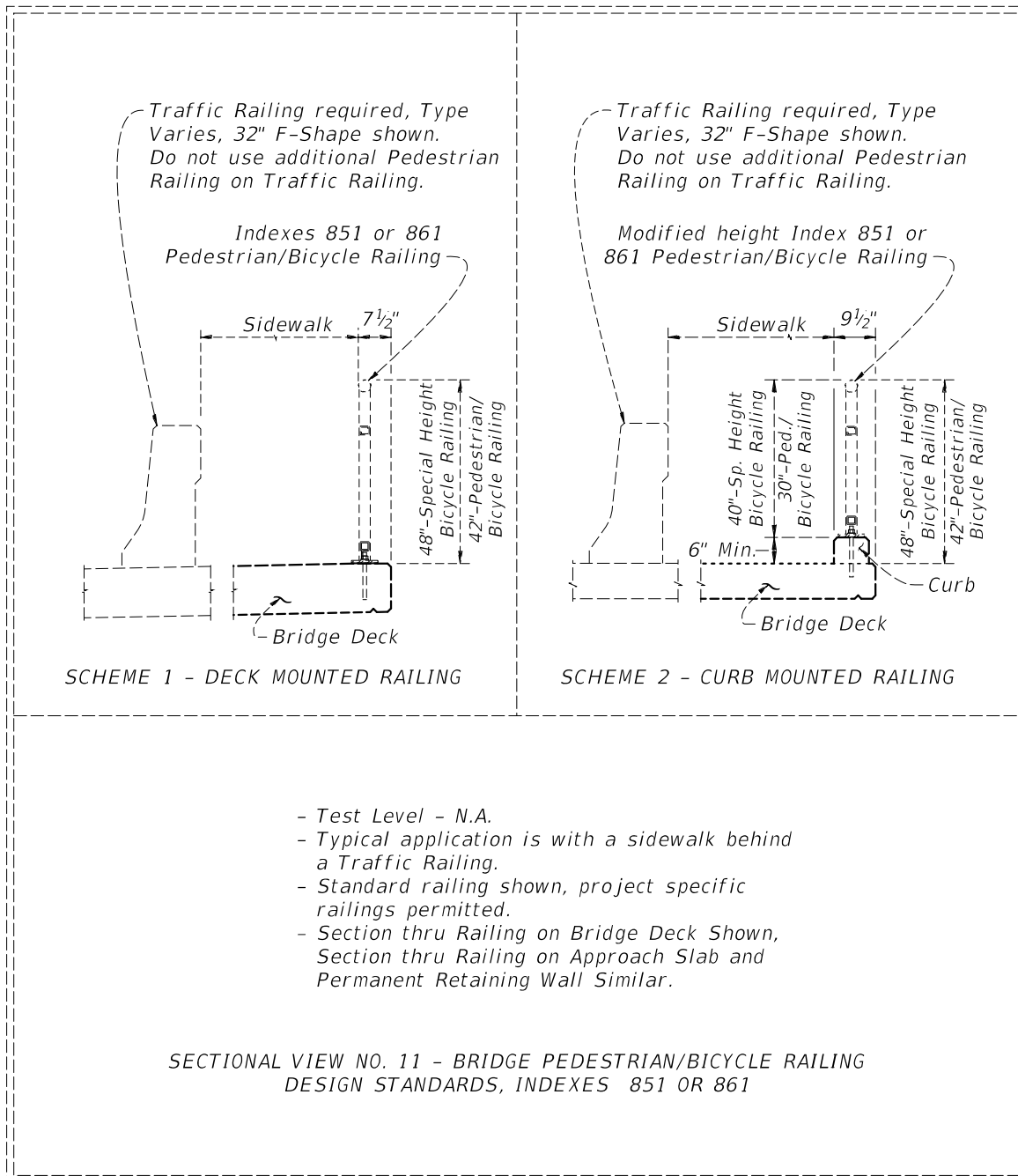

Figure 4.4.7 Bridge Railing – Pedestrian/Bicycle Railing (Index 825)

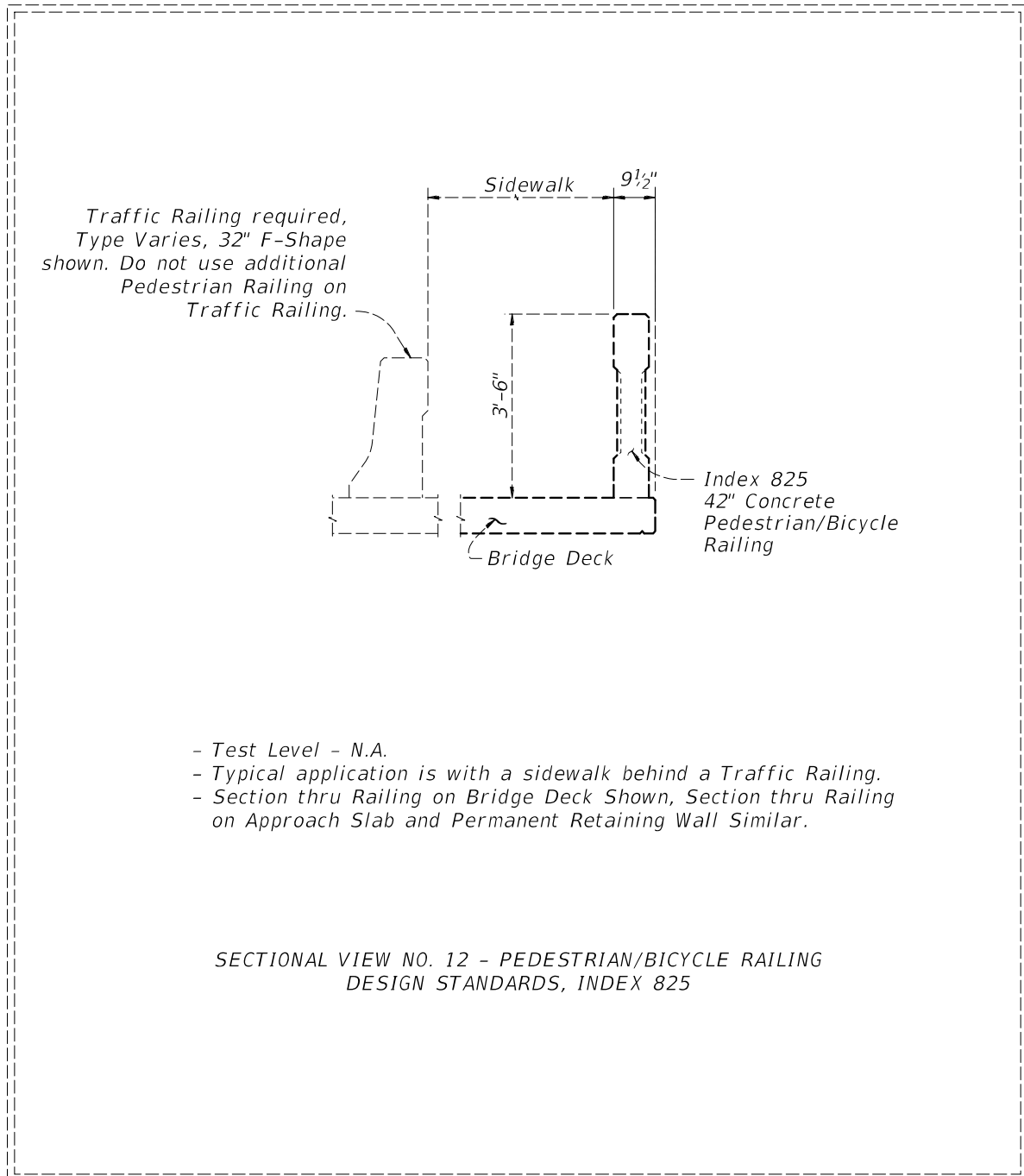

Figure 4.4.8 Bridge Railing and Pedestrian/Bicycle Railing Retrofit

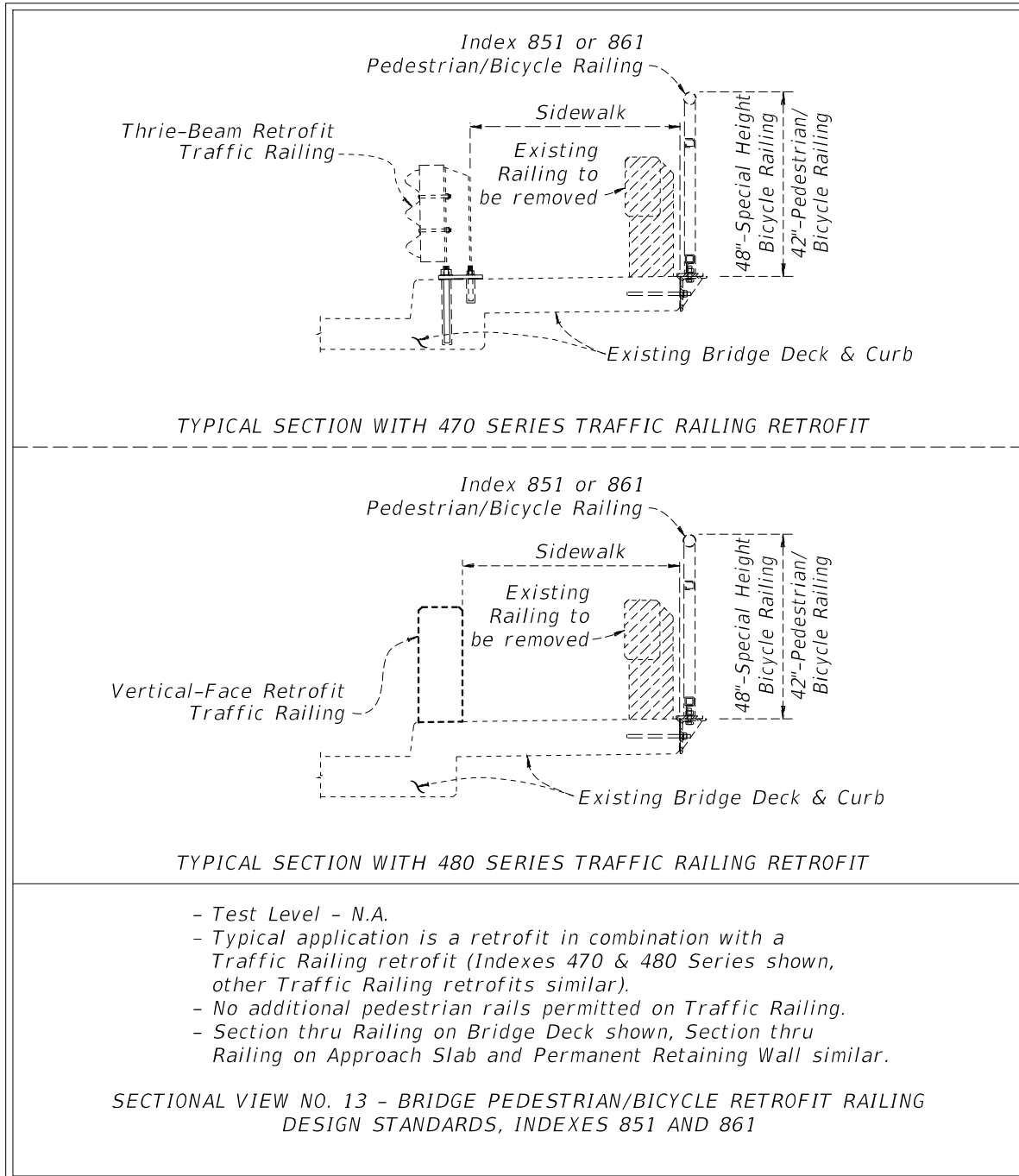

Figure 4.4.9 Bridge Railing and Bridge Parapet Fencing

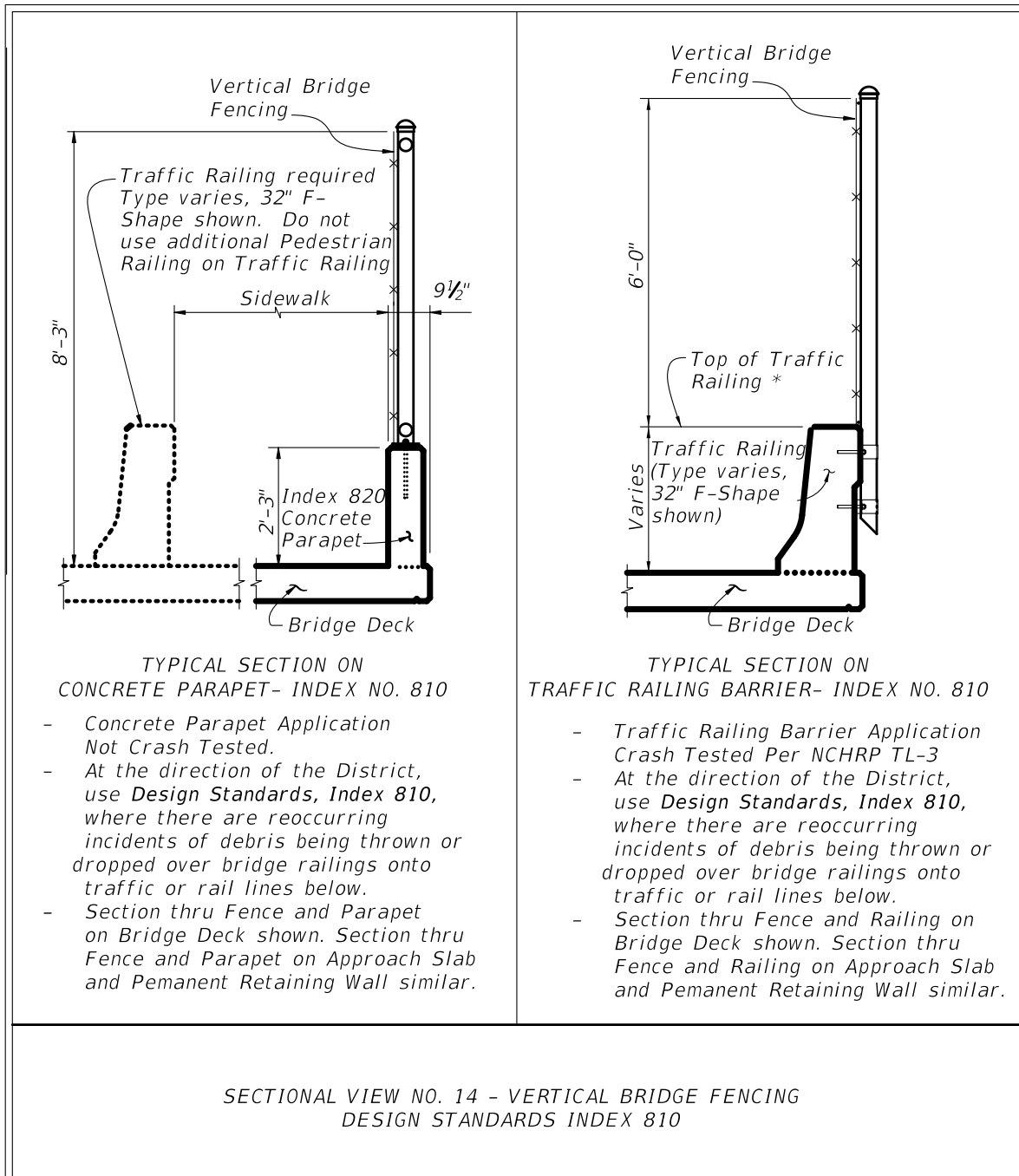
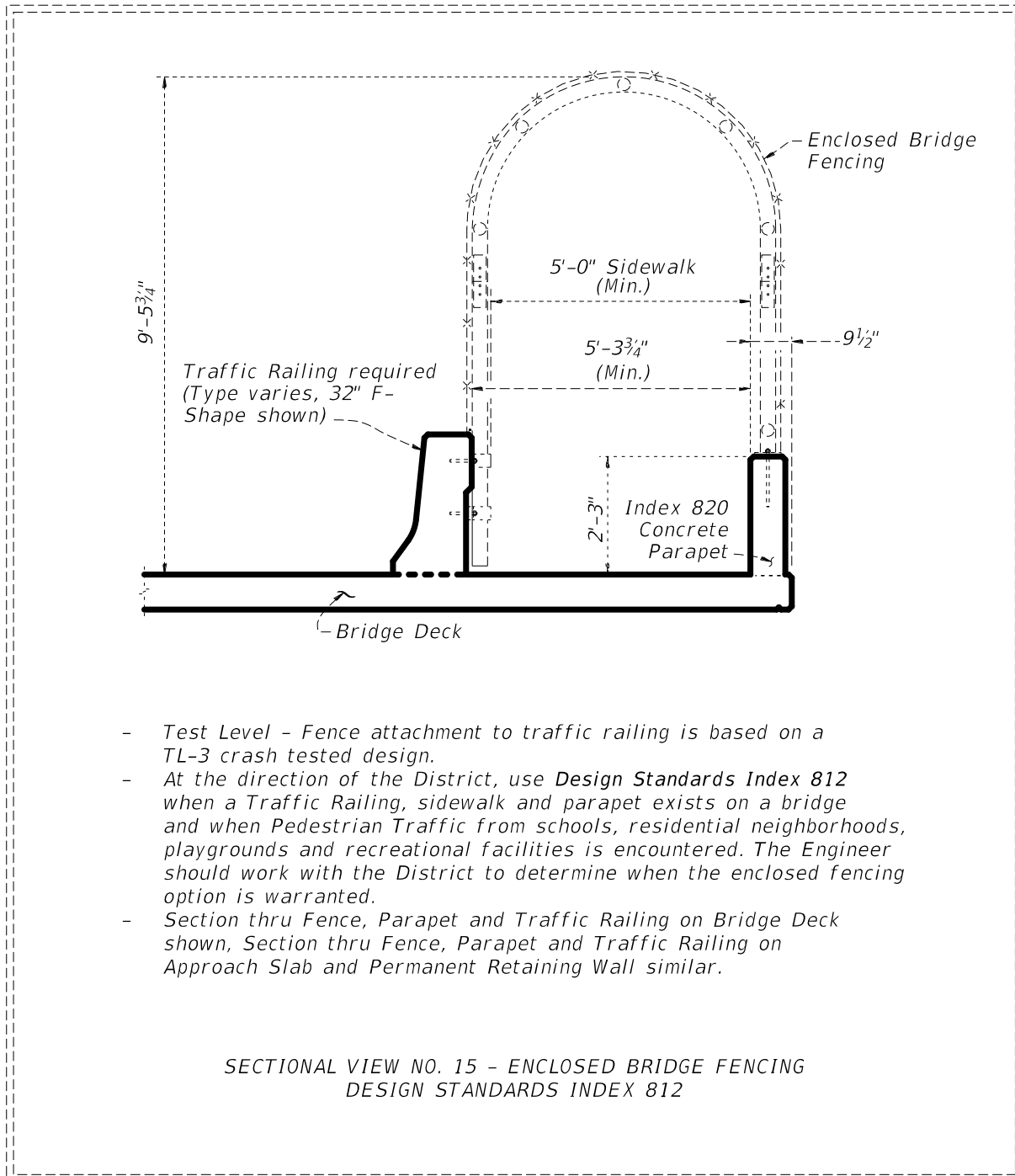

Figure 4.4.10 Bridge Railing – Enclosed Fencing



4.4.1.4 Temporary Barriers

Temporary Barriers are used in work zones to protect motorists and to safeguard construction workers while construction activities are taking place (i.e. Positive Protection).

Temporary Barriers include the following:

1. Low Profile Barrier – **Design Standards, Index 412** (TL-2, NCHRP 350)
2. Type K Barrier – **Design Standards, Index 414** (TL-3, NCHRP 350)
3. Proprietary Temporary Barrier – **Design Standards, Index 415 & APL** (TL-2 & TL-3, NCHRP 350 and MASH)

Low Profile Barriers are limited to Work Zone Speeds of ≤ 45 mph and required for urban applications where temporary barrier is needed within 100 feet of an intersection, residential driveway or business entrance. Use of other barriers is not permitted at these locations due to sight distance limitations. Transitions from Low Profile Barrier to other temporary barriers within a run of barrier (i.e. from begin length of need to end length of need) is not permitted.

Type K Barrier is a portable concrete barrier which has the capability of being anchored (i.e. staked or bolted) to limit deflections. See **Design Standards, Index 414** for specific requirements for the use of Type K Temporary Concrete Barrier. For requirements of portable concrete barriers used on bridges and retaining wall sections, see the **SDG, Section 6.7**. Refer to **Design Standards, Index 414** for details on transitioning between the Type K Temporary Concrete Barrier on bridges and other concrete barrier systems on the adjoining roadway.

Anchored (bolted) temporary barriers are not permitted on bridge superstructures that contain post-tensioned tendons within the concrete deck (top flange of concrete box girders) or on bridge superstructures consisting of longitudinally prestressed, transversely post-tensioned, solid, or voided concrete slab units.

Proprietary Steel Barriers, Water Filled Barriers and portable concrete barriers must be used in accordance with the Vendor drawings on the **APL** and **Design Standards, Index 415**. To allow for the use of **APL** devices the Plans should not refer specifically to 'Temporary Concrete Barrier', unless specific limitations are required. Proprietary steel barriers listed on the **APL** are capable of being anchored to limit deflections; however, barrier heights and drainage performance may limit some systems.

If Flexible (HTCB, **Index D450**) or Semi-Rigid (Guardrail, **Index 400**) barrier is used in a temporary configuration, or allowed to remain during a portion of the Temporary Traffic Control (TTC) Plan, requirements for the permanent application of barrier must be met (i.e. grading, deflection space, offset from Edge of Traveled Ways, etc.).

4.4.2 End Treatments

Longitudinal barrier ends which are not crashworthy are hazardous if they terminate within the Clear Zone of an approach direction. The Department's crashworthy end treatments for each barrier type (i.e. flexible, semi-rigid, and rigid) are detailed in the Design Standards.

Flexible barrier End Treatments are vendor-specific. For additional information regarding the end treatment of HTCB, refer to IDDS-D450, as referenced above.

4.4.2.1 Guardrail End Treatments

Guardrail End Treatments are necessary to provide crashworthy ends for approaches and anchorage of the guardrail system. For the guardrail to provide adequate redirective capabilities during a vehicle impact, anchorage of the system is needed for tensile (ribbon) strength to develop in the guardrail panels. Approach Terminals provide both anchorage of the guardrail system and a crashworthy approach. End Treatments for guardrail are categorized as follows:

1. Approach Terminals – required for guardrail ends within the Clear Zone of approaching traffic. Guardrail approach terminals must be a proprietary device listed on the **APL**. Approach Terminals are classified by Test Level (TL-2 for Design Speeds ≤ 45 mph or TL-3, which is acceptable for all Design Speeds) and as follows:
 - a. Flared – preferred terminal for locations where sufficient space is available to offset barrier end from approaching traffic.
 - b. Parallel – use only when sufficient space is not available for a flared terminal.
 - c. Double Face – preferred end treatment for double faced guardrail installations.
2. Crash Cushion – See **Section 4.4.3**.
3. Trailing End Anchorages (Type II) – required for anchoring of the trailing ends of guardrail. Trailing End Anchorages are considered non-crashworthy as an approach end treatment, and are not permitted as a guardrail end treatments on the approach end within the Clear Zone, unless shielded by another run of barrier. The Type II Trailing End Anchorage, is detailed in the **Design Standards, Index 400**.

4.4.2.2 Rigid Barrier End Treatments

Rigid Barrier ends must be terminated by either transitioning into another barrier system (e.g. guardrail), or by shielding with a Crash Cushion. Details and requirements are provided in the ***Design Standards***.

Sloped Concrete End Treatments (i.e., the 10' long vertical height transitions detailed on Sheets 12 and 13 of ***Design Standards, Index 410***) are not permitted within the clear zone of approaching traffic lanes unless site-specific justification is provided and approved by the District Design Engineer. When used, sloped end treatments are only permitted for Design Speeds < 40 mph and only when no other more crashworthy solution is available.

Treatment of the trailing end of rigid barriers is not required unless additional hazards exist beyond the rigid barrier or the barrier is within the clear zone of opposing traffic.

4.4.2.3 Temporary Barrier End Treatments

The required treatments for exposed ends of Temporary Barriers are:

1. Connecting to an existing barrier (smooth, structural connections are required - Refer to ***Design Standards, Indexes 410*** and ***414***, or the ***APL***);
2. Shield end with a crash cushion as detailed in the ***Design Standards*** or ***APL*** for the specific type of Temporary Barrier (i.e. Temporary Concrete, Steel, or Water Filled);
3. Attaching or Transitioning to a crashworthy end treatment as described above; or,
4. Flaring outside of the Work Zone Clear Zone (See ***Table 4.2.2***)

Design Standards, Index 415 provides details for shielding exposed ends of temporary concrete barrier wall using crash cushions. A minimum of four (4) units or 50 feet of bolted or staked Type K Barrier is required for temporary concrete barriers attached to a crash cushion.

No modifications to the end treatments included in the ***Design Standards*** or ***APL*** are permitted. Special conditions may require end treatments other than those included above. If this occurs, consult the State Roadway Design Office (RDO) and provide special details in the Plans.

4.4.3 Crash Cushions

Crash cushions (impact attenuators) are used to protect motorists from the exposed ends of barriers, fixed objects and other hazards within the clear zone. They are energy absorbing devices that may be redirective non-gating, or non-redirective gating. Crash cushions are classified based on Test Level and Design Speed, as shown for each system on their respective **APL** drawings.

The design of a crash cushion system must not create a hazard to opposing traffic. **APL** drawings provide details for transitions for optional barrier types with and without bi-directional traffic.

An impacting vehicle should strike the systems at normal height, with the vehicle's suspension system neither collapsed nor extended. Therefore, the terrain surrounding crash cushions must be flat (1:10 or flatter) in advance of and along the entire design length of the system. Do not locate curbs within the approach area of a crash cushion.

4.4.3.1 Permanent Crash Cushions

Permanent crash cushions must be redirective non-gating. Standard details of systems for typical installations shielding concrete barrier wall ends and guardrail ends can be found on the **APL** under **Section 544**. In addition, some of these systems have standard details for shielding wide hazards. For applications not covered in the **APL** drawings, crash cushion vendors normally provide design assistance for their systems. Special designs must be detailed in the Plans and based on meeting the performance criteria for the established design speed of the facility (i.e. barrier system Test Level).

4.4.3.2 Temporary Crash Cushions

Two types of temporary crash cushions are permitted; redirective non-gating crash cushions and non-redirective gating crash cushions. Redirective crash cushions will shield hazards by redirecting errant vehicles impacting the side of the crash cushion and decelerate errant vehicles from a direct, in-line impact at the terminus of the crash cushion by absorbing the energy.

Gating crash cushions are designed to decelerate errant vehicles from a direct, in-line impact at the terminus of the crash cushion by absorbing the energy, but provide no redirective capabilities for side impacts. Gating crash cushions are permitted only with prior approval from the State Roadway Design Office (RDO). They may be appropriate on low speed facilities and in work zones with higher speeds where only low impact angle

hits are expected. An adequate clear runout area must be provided beyond a gating crash cushion (between the departure line and the clear zone). Plan details for site specific design are required.

Approved temporary crash cushions for use on Department contracts are listed on the **APL** under **Section 102**. Sand barrel gating systems are not permitted.

Anchored (bolted) temporary crash cushions are not permitted on bridge superstructures that contain post-tensioned tendons within the concrete deck (top flange of concrete box girders) or on bridge superstructures consisting of longitudinally prestressed, transversely post-tensioned, solid, or voided concrete slab units.

4.4.4 Barrier Transitions

Guardrail transitions are necessary, whenever standard W-Beam guardrail converges with rigid barriers. Guardrail transitions must include sound structural connections, nested panels and additional posts for increased stiffness, as shown in the **Design Standards**. Use the guardrail transitions included in the **Design Standards** as follows:

1. General, Guardrail Approach Transition to Rigid Barrier – **Design Standards, Index 400** (Single or Double Face Guardrail, TL-3, MASH), Approved for all Design Speeds.
2. Low Speed, Guardrail Approach Transition to Rigid Barrier – **Design Standards, Index 400** (Single Face Guardrail only, TL-2, MASH), Approved for Design Speeds ≤ 45 mph only with Flush Shoulder or Curb.
3. Trailing End Transition Connection – **Design Standards, Index 400** (Test Level N/A), Approved for all Design Speeds.

Various other barrier transitions are detailed throughout the **Design Standards** and **APL** drawings for transitions from temporary barriers to permanent rigid barriers and transitions from variable height/shape rigid barriers.

4.4.5 Barrier Type Selection

The evaluation of numerous factors is required to ensure that the appropriate barrier type is selected for a given application. Provide consideration for the following factors when evaluating each particular site:

1. Barrier Placement requirements (see **Section 4.4.6**)

2. Traffic characteristics (e.g. vehicles types/percentages, volume, and growth)
3. Site characteristics (e.g. terrain, alignment, geometry, access facility type, access locations, design speed, etc.)
4. Expected frequency of impacts
5. Initial and replacement/repair costs
6. Ease of maintenance
7. Exposure of workers when conducting repairs/maintenance
8. Aesthetics



For additional information about considerations for barrier selections refer to the **AASHTO RDG**. Document barrier type selection decisions and warrants.

4.4.5.1 Longitudinal Barrier Selection

Refer to the **SDG** for barrier type and test level selection of Traffic Railings.

For Longitudinal Barriers along roadways, the three primary options are HTCB, W-Beam Guardrail, and Rigid Barriers. See **Table 4.4.1** for information regarding the standard barrier types and relevant selection characteristics.

Table 4.4.1 Roadway Barrier Type Selection

Barrier Type	Deflection Space Requirement (feet)	Order of Bias			Test Level	Design Vehicles
		Initial Cost	Vehicle Impact Severity	Maintenance Cost		
HTCB	12	 LOW	 LOW	 HIGH	TL-4 (NCHRP 350)	Passenger Car, Pickup Truck, & Single-Unit Truck
W-Beam Guardrail	5				TL-2 & TL-3 (MASH)	Passenger Car & Pickup Truck
Modified Thrie-Beam	3				TL-3 & TL-4 (NCHRP 350)	Passenger Car, Pickup Truck, & Single-Unit Truck
Rigid Barrier	0				HIGH	HIGH

Specific requirements for the selection of HTCB are provided in **IDDS-D450**.

Based on the limitations noted in **Section 4.4.1.2**, the use of Modified Thrie-Beam should be restricted to locations where site specific conditions warrant a more robust guardrail system but not the added cost of rigid barrier system.

4.4.5.2 End Treatment Selection

Select end treatments in accordance with **Section 4.4.2**, the **Design Standards** and the **Instructions for Design Standards (IDS)** for each applicable barrier type.

4.4.5.3 Crash Cushion Selection

Various types of energy absorbing devices eligible for use on Department projects as Crash Cushions can be found on the Approved Products List (**APL**). Detailed information about these systems is provided in the **Design Standards**, **APL**, and in each manufacturer's publications. Each system has unique physical and functional characteristics.

For permanent crash cushion applications, indicate in the Plans the location (station and side), barrier system (concrete barrier wall or guardrail), design length, design speed, crash test level, hazard width and length restriction requirements for each given location (in accordance with **Design Standards**, **Index 430**, and **Chapter 7** of Volume 2,).

Site characteristics and economics dominate crash cushion selection considerations. Some crash cushion systems are relatively low in initial cost, but usually must be completely replaced when struck, so are more appropriate in locations with a low likelihood of collision. There are a number of other systems that have higher initial costs but can be repaired after collisions relatively quickly and inexpensively, so are more appropriate where frequent collisions are anticipated. The ability of maintenance forces to perform routine maintenance and to place a crashed system back into service quickly should be a major consideration. Do not use crash cushions that require stocking unusual and expensive parts or those that are complex to replace.

4.4.5.4 Pier Protection

In addition to shielding bridge piers to protect motorists from a hazard within the Clear Zone, some bridge piers may need shielding for protection from damage due to design limitations (i.e. piers not designed for vehicular collision forces). Coordination with the Structural Engineer of Record is required to determine if pier protection is warranted.

The requirements for Pier Protection are outlined in the **SDG, Section 2.6**. The process for determining the appropriate level of Pier Protection for New Construction projects is presented in **Figure 4.4.11** (Pier Protection Selection Flowchart). For RRR and railroad requirements, refer to the **SDG**. Detail Pier Protection barrier in accordance with **Design Standards, Index 411**.

Figure 4.4.11 Pier Protection Selection Flowchart (New Construction)

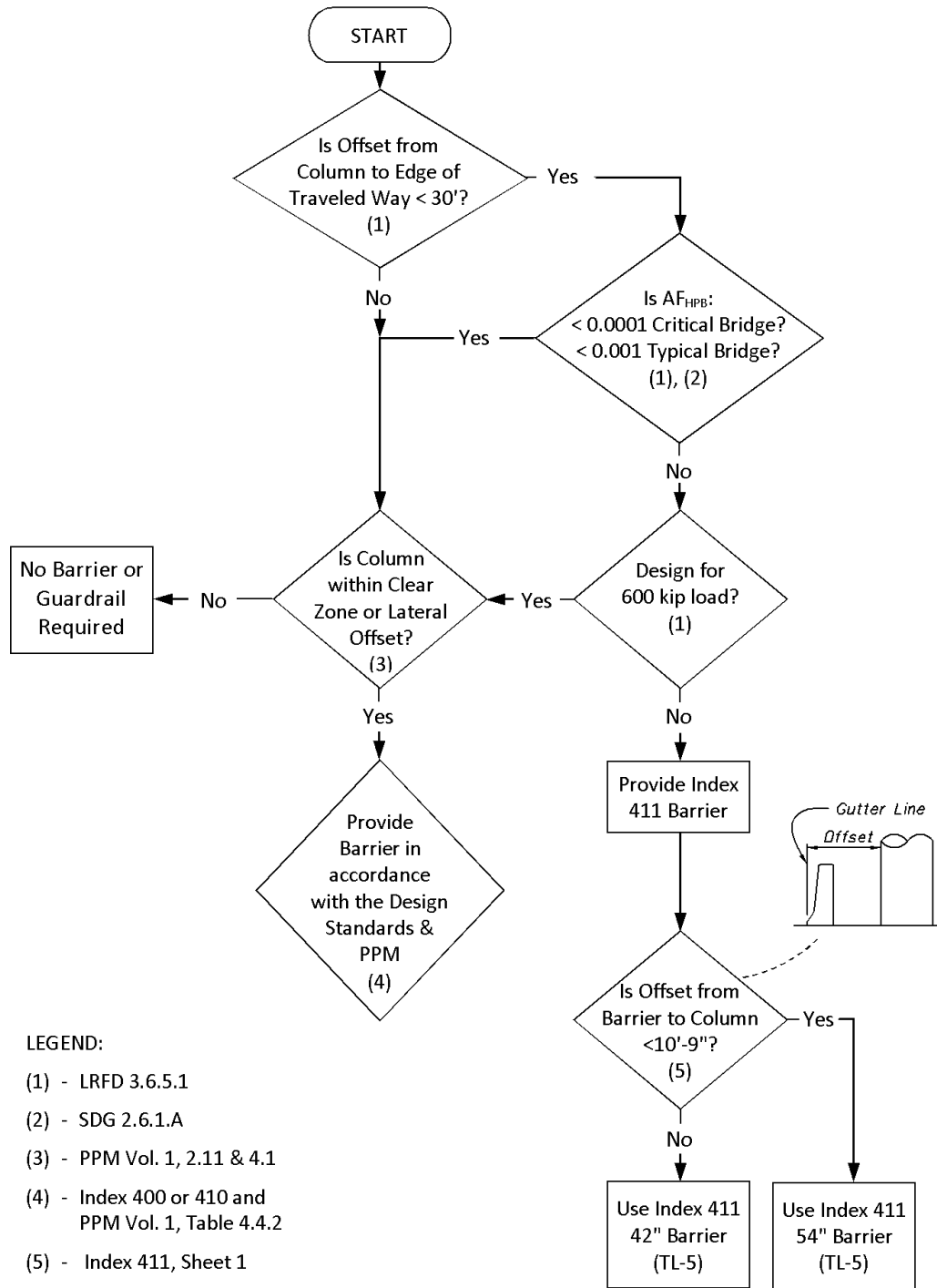

4.4.6 Barrier Placement

The primary design factors associated with barrier placement are:

1. Lateral Offset from the Edge of Traveled Way
2. Deflection Space Tolerance
3. Terrain Effects
4. Length of Need
5. Space for End Treatments
6. Outside Shoulder or Median Application

4.4.6.1 Barrier Offset

Offset roadside barriers as far from the travel lanes as practical with consideration for maintaining the proper performance of the barrier. See **IDDS-D450** for the barrier placement requirements for HTCB.

The standard offset for W-Beam Guardrail from the Edge of Traveled Way is the shoulder width plus 2 feet, not to exceed 12 feet. Requirements for guardrail offsets are illustrated in **Figure 4.4.12**. When curb is present, the preferred configuration is to place the face of the guardrail panel 5 inches from the face of curb. For design speeds ≤ 45 mph, placing the guardrail between 4 feet and 12 feet from the face of curb is also allowable.

The 12 feet maximum offset for guardrail is established to reduce the potential for impacts where the vehicle is behaving significantly different than the crash tested conditions (i.e. non-tracking, fish-tailing, excessive approach angle, etc.). Guardrail offsets greater than 12 feet require site-specific justification in accordance with **Section 4.4.7**, unless location is based on the requirements of **Section 4.4.6.4, Median Barrier** or **Section 4.3.2, Canal Hazards**.

Rigid Barrier is typically used when there are barrier deflection or right-of-way limitations. Rigid Barrier offsets should be based on site-specific conditions, but as far from the traveled way as possible.

Rigid Barrier, with the exception of F-Shapes with a height less than 42", may be used in combination with curbs, and provide an acceptable alternative to the areas excluded for guardrail use in **Figure 4.4.12**.

Figure 4.4.12 Lateral Offset to Guardrail

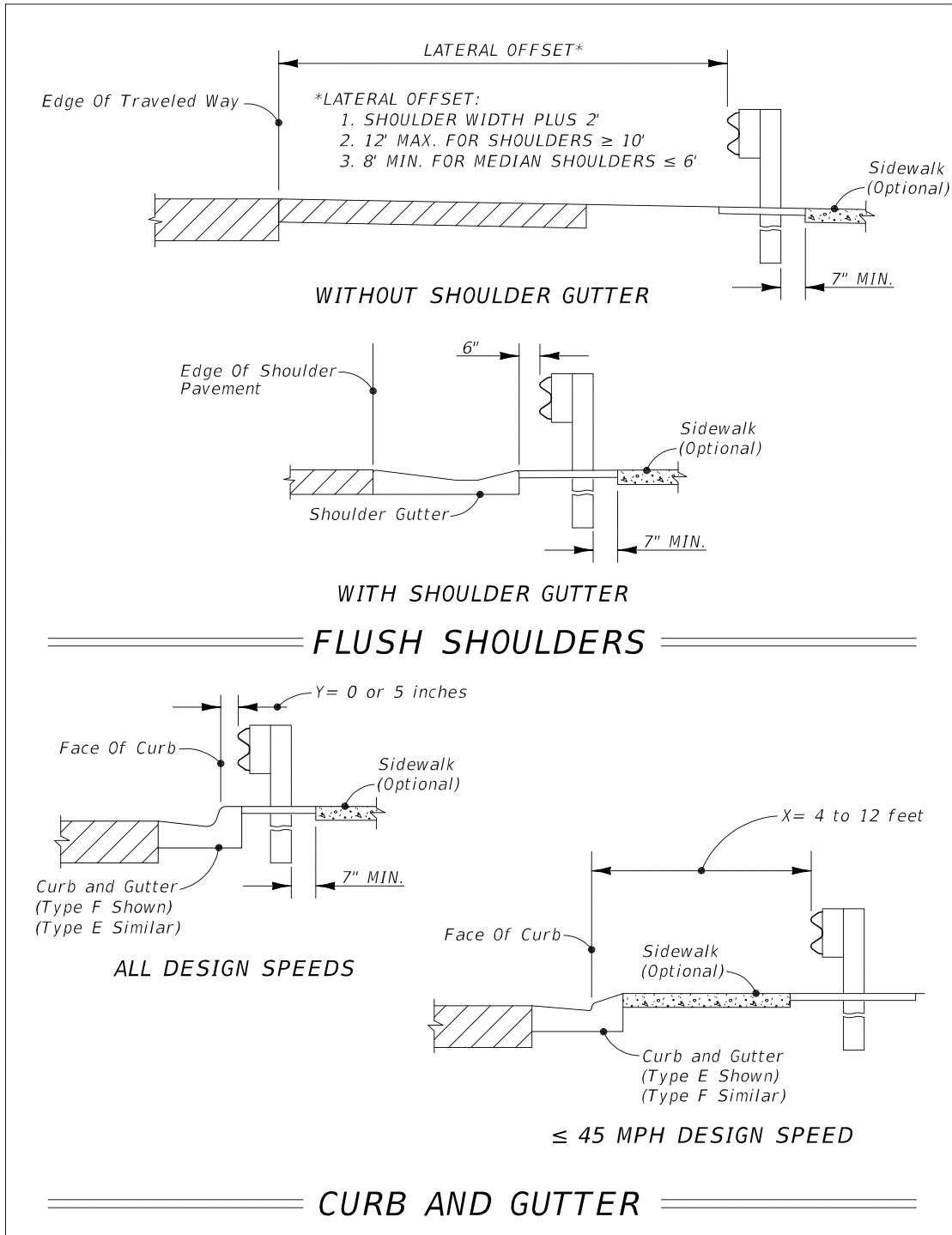

In addition to travel lane lateral offset considerations, an adequate setback must be provided behind the barrier to ensure proper function. For flexible and semi-rigid barriers the setback is based on deflection tolerances and is required to prevent the barrier from contacting aboveground objects.

For rigid barriers the setback is required to keep the area above and behind the barrier face free of obstructions that could penetrate or damage the vehicle compartment. This requirement is based on the Zone of Intrusion (ZOI) concept as described in the **AASHTO RDG**. **Table 4.4.2** provides the Setback requirements for FDOT standard barriers. Additionally, **Figure 4.4.13** includes setback distances to rigid barriers for discontinuous elements. These requirements do not apply to devices located within the setback distance detailed in the **Design Standards** (e.g. pedestrian/bicycle railing, fencing, noise walls, etc.).

**Table 4.4.2 Minimum Barrier Setback
 (Measured from the face of the barrier)**

Barrier Type	Setback Distance
Flexible Barrier	
High Tension Cable Barrier (HTCB)	12'-0"
Semi-Rigid Barrier	
W-Beam with Post Spacing @ 6'-3" (TL-3)	5'-0"
W-Beam with Post Spacing @ 12'-6" (TL-2)	5'-0"
W-Beam with Post Spacing @ 3'-1½" (½ Spacing)	3'-10"
W-Beam with Post Spacing @ 1'-6¾" (¼ Spacing)	3'-2"
Nested W-Beams with Post Spacing @ 3'-1½" (½ Spacing)	3'-0"
Nested W-Beams with Post Spacing @ 1'-6¾" (¼ Spacing)	2'-8"
Deep Post W-Beam installed on 1:2 Slope Break with Post Spacing @ 6'-3" (TL-3)	5'-6"
Modified Thrie-Beam with Post Spacing @ 6'-3"	3'-0"
Rigid-Barrier	
Concrete Barrier < 40" Height Non-crash Tested Continuous or Discontinuous Items	1'-6"
Concrete Barrier ≥ 40" Height Non-crash Tested Continuous or Discontinuous Items	0'-0"
Bridge Traffic Railing < 40" Height Non-crash Tested Continuous Items	5'-0"
Non-crash Tested Discontinuous Items	See Figure 4.4.13
Temporary Barriers	
See "Deflection Space" of applicable Design Standards, Index or APL drawing.	

Figure 4.4.13 Setback Distances for Discontinuous Elements

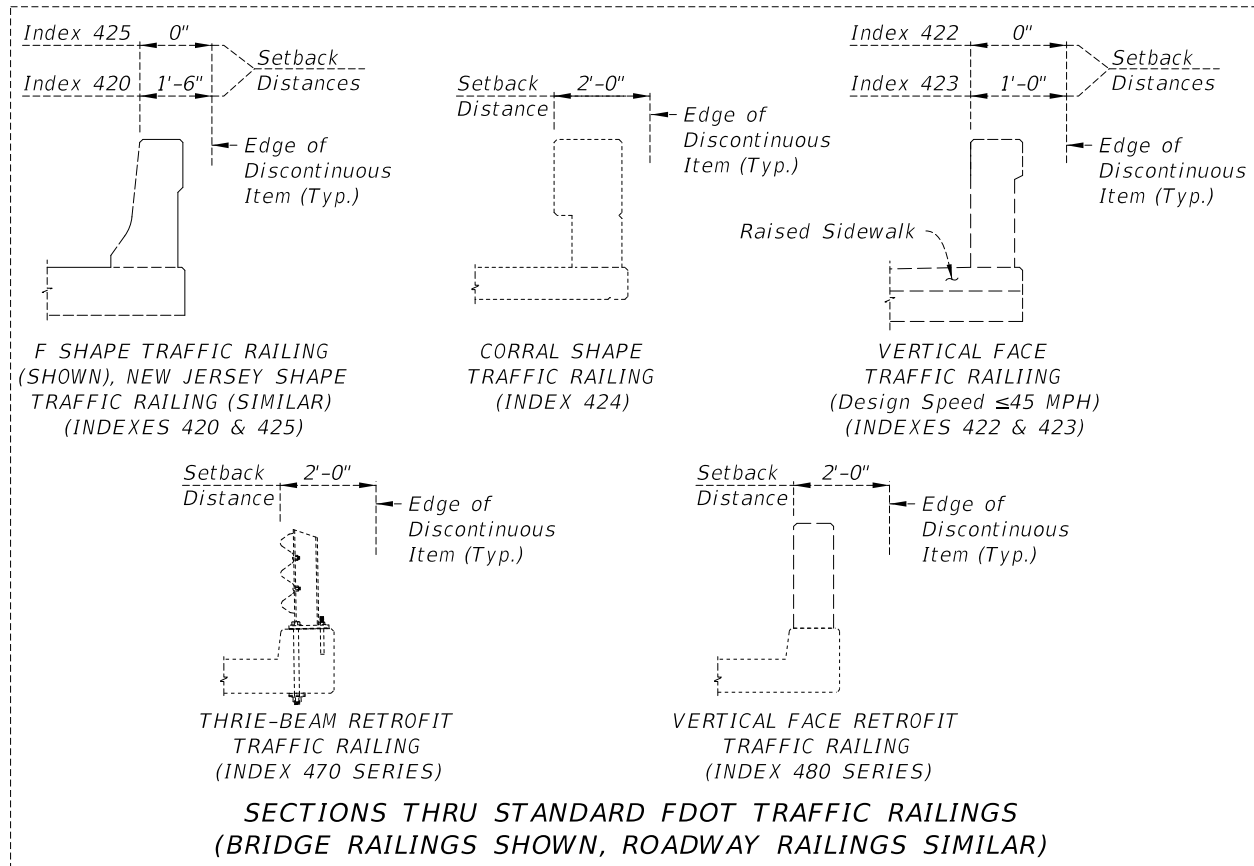

Noise Wall/Traffic Railing combinations located within the setback distance must be crash tested to or accepted as TL-4 under **NCHRP 350** or **MASH-09**. Other continuous items (e.g. glare screens and fences) located within this setback distance must be crash tested to or accepted as TL-3 under **NCHRP 350** or **MASH-09**.

See **Section 4.5** for additional information regarding discontinuous attachments to rigid barriers.

4.4.6.2 Grading Requirement

The terrain effects between the traveled way and a barrier can have a significant impact on whether or not a barrier will perform as intended. Proper grading around a barrier will ensure that as a vehicle approaches a barrier its suspension is not dramatically affected, causing the vehicle to underide or override a barrier.

Install barriers on slopes 1:10 or flatter. Continue the slope to a distance at least 2 ft. beyond the barrier (i.e. from either the guardrail post or rigid barrier) before providing a slope break.

With approval of the District Design Engineer and where conditions are constrained, the Deep Post guardrail option, as detailed in [Design Standards](#), Index 400 “Slope Break Condition”, may be used in lieu of providing a 2 ft. setback to the slope break point. Coordinate the use of the Deep Post guardrail option with the District Drainage Engineer and District Maintenance Engineer.

Modification for Non-Conventional Projects:

Delete the last paragraph and see RFP for requirements.

Grading is particularly important for barrier ends shielded by crashworthy devices. Provide for the grading requirements around the end treatments as shown in the **Design Standards**.

For superelevated roadway sections, a maximum 7% algebraic difference is permitted between the travel lanes and shoulder in advance of barriers. See **Section 4.4.6.5** for temporary barrier requirements in superelevated roadway sections.

4.4.6.3 Length of Need

The Length of Need (LON) for a particular barrier type is dependent on the design speed, the offset distance to the face of the barrier and the lesser distance to either the back of the hazard or to the clear zone. Establish Length of Need (LON) for installations using the requirements included in the **Instructions for Design Standards (IDS)** for Guardrail, **IDS-400** or the **Design Standards** for other standard barrier types. On all facilities, barrier requirements must consider traffic from both directions.

4.4.6.4 Median Barriers

This Section applies to barriers placed in the median for the mitigation of median crossover crashes (i.e., reduce the number of vehicles that might enter opposing lanes of traffic after traversing a median).

Locate median barrier in accordance with guidelines included in the **AASHTO RDG, Section 6.6** and in accordance the **Design Standards**.

The preferred barrier option for median applications is High Tension Cable Barrier (HTCB), provided the requirements of **IDDS-D450** can be met. Evaluate other barrier options when the deflection and placement requirements for HTCB cannot be met.

Include Rub Rail on double faced w-beam guardrail installations as shown in **Design Standards, Index 400**. Based on the shoulder width and as shown in **Figure 4.4.12**, locate double faced w-beam guardrail at a lateral offset of between 8 feet and 12 feet from the edge of traveled way. For medians with cross slopes of 1:6 or flatter, locate the barrier closest to the traveled way with the most likelihood or history of lane departure (e.g. outside of horizontal curves and sections with outside merge lanes). If median cross slopes greater than 1:6 exist, and HTCB is not feasible, install w-beam guardrail along both sides of the median or consider a grade separated (bifurcated) median with a concrete barrier.

Use concrete median barrier when the barrier offset requirements for flexible or semi-rigid barrier cannot be met or a higher test level barrier is justified. Implement concrete median barrier in accordance with **Design Standards, Index 410**.

4.4.6.5 Temporary Barriers

Installation instructions and flare rates are given in the **Design Standards, Indexes 412, 414, 415** and **600**.

A temporary or permanent pavement surface with a maximum cross slope of 1:10 is required when a Temporary Barrier is used. The paved surface must extend the full distance of the required deflection space behind the barrier.

Show or note the location of temporary barriers in the Temporary Traffic Control (TTC) Plans. Also provide a Work Area Access Plan for projects with work zones shielded with a barrier. For additional information regarding TTC Plans, refer to **Chapter 10** of this Volume.

The presence of barriers on both shoulders may eliminate any effective shoulder width or refuge area. The effective shoulder width is required to ensure an area is available for both disabled vehicles during normal traffic conditions and access for emergency responders during stopped conditions. Therefore, on interstate or freeway projects requiring barriers on both sides of the work zone traveled way, a minimum 10-foot lateral offset from the edge of the traveled way to the barrier is required on at least one side of

the roadway. Bridge construction and associated roadway approaches are exempt from this requirement. Providing this 10-foot lateral offset on arterials and collectors should be considered. For all other applications, provide the minimum lateral offset required per ***Design Standards, Index 415***.

When using existing barrier during a temporary traffic control operation or when 2-way traffic is placed on a facility that is normally one-way, the existing permanent or temporary barriers must be modified as necessary to ensure their proper crashworthiness during the temporary situation. This will include eliminating non-crashworthy end treatments, snag points or other protrusions normally angled away or hidden from approaching vehicles.

Existing permanent barriers used during temporary traffic control operations must meet grading, offset, and setback (i.e. deflection space) requirements for the permanent installation.

Temporary barriers, as defined in **Section 4.4.1.4**, located in superelevated roadway sections must be installed on the same roadway cross slope as the travel lanes (i.e. no slope break in advance of the barrier).

4.4.7 Warrants for Roadside Barriers

The evaluation of Roadside Safety is highly dependent on site specific conditions and constraints which are unique to a given situation. Therefore the determination as to when shielding is warranted for given hazardous roadside feature must be made on a case-by-case basis, and generally requires engineering judgment. It should be noted that the installation of roadside barriers presents a hazard in and of itself, and as such, the designer must analyze whether or not the installation of a barrier presents a greater risk than the feature it is intended to shield. The analysis should be completed using the *Roadside Safety Analysis Program (RSAP)* or in accordance with the *AASHTO Highway Safety Manual (HSM)*. Refer to **Section 23.5** of this Volume for guidance on evaluating the benefits of shielding using *RSAP* or the *HSM*.

4.4.7.1 Evaluation of Roadside Hazards

Roadside barriers are recommended when hazards exist within the clear zone, hazards cannot be cost effectively eliminated or corrected, and collisions with the hazards are more serious than collisions with the barriers.

The following conditions within the clear zone are normally considered more hazardous than a roadside barrier:

1. Drop-off Hazards, as defined in **Section 4.3.3**.
2. Bridge piers, abutments and railing ends.
3. Non-traversable culverts, pipes and headwalls.
4. Non-traversable parallel or perpendicular ditches and canals.
5. Canals, ponds and other bodies of water (other than parallel ditches).
6. Parallel retaining walls with protrusions or other potential snagging features.
7. Retaining walls at an approach angle with the edge of pavement larger than 7 degrees (1:8).
8. Non-breakaway sign or luminaire supports.
9. Trees greater than 4 inches in diameter measured 6 inches above the ground.
10. Utility poles.
11. Aboveground hazards.

In addition to the above hazards, there are other conditions which merit barrier consideration, such as nearby pedestrian or bicycle facilities, schools, residences or businesses.

4.4.7.2 Shielding Requirements

If natural or man-made hazards, including slopes steeper than 1:3, occur within the clear zone, implement one of the following treatments, in order of priority:

Modification for Non-Conventional Projects:

Delete the sentence above and replace with the following:

If natural or man-made hazards, including slopes steeper than 1:3, occur within the clear zone, apply the following treatments, in order of priority:

1. Eliminate the hazard.
 - a. Remove the hazard.
 - b. Relocate the hazard outside the clear zone.
 - c. Make the hazard traversable or crashworthy.
2. Shield the hazard with a longitudinal barrier or crash cushion.
3. Leave the hazard unshielded when any of the following apply:
 - Longitudinal barrier or crash cushion would be a greater hazard than the

- hazard to be shielded; or
- The likelihood of striking the hazard is negligible; or
- The expense of shielding the hazard outweighs the benefits in terms of crash reduction as determined through the use of **RSAP** or **HSM** analyses.

If crash data or safety reports indicate that early treatment of the hazards will result in fewer or less severe crashes, implementing those treatments should be the first order of work.

4.4.7.3 Warrants for Median Barrier

Provide a median barrier on interstate and expressway facilities where reconstruction reduces the median width to less than what is required for the facility. Deviation from this criteria is not permitted. An **RSAP** or **HSM** analysis may be used to evaluate barrier alternatives and supplement the following requirements.

On Interstate and expressway projects, review crashes that occurred in the most recent 5-year period within the limits of 1 mile in advance of the exit ramp gore to 1 mile beyond the entrance ramp gore. If one or more are determined to be cross median crashes, provide shielding with a median barrier. The District may require shielding outside these areas after reviewing the most recent 5-year crash history.

For High Speed (Design Speed \geq 50 mph), High Volume facilities that lack full access control, the most recent 5-year cross median crash history must also be reviewed for potential shielding with a median barrier. For these facilities, alignment, sight distance, design speed, traffic volume, median width and frequency of median openings should be evaluated on a case-by-case basis for implementation of median barrier.

4.4.7.4 Positive Protection in Work Zones

For locations where work zone traffic barriers are required, refer to **Design Standards, Index 600**. Work zone traffic barriers are positive protection devices and temporary barriers that can be easily relocated. They have four specific functions:

1. Protect traffic from entering work areas, such as excavations or material storage sites;
2. Provide positive protection for workers;
3. Separate two-way traffic; and,
4. Protect construction such as false work for bridges and other exposed objects.

The designer should anticipate when and where barriers will be needed and include this information and the quantities on the Plans. At a minimum, consider positive protection devices in work zone situations that place workers at increased risk from vehicular traffic, and where positive protection devices offer the highest potential for increased safety for workers and road users, such as:

1. Work zones that provide workers no means of escape from vehicular traffic (e.g., tunnels, bridges, etc.);
2. Long duration work zones (e.g., two weeks or more at the same location) resulting in substantial worker exposure to vehicular traffic;
3. Projects with anticipated Work Zone Speeds \geq 45 mph, especially when combined with high traffic volumes;
4. Work operations that place workers close to travel lanes open to traffic; or,
5. Roadside hazards, such as drop-offs or unfinished bridge decks, that will remain in place overnight or longer.

4.5 Attachments to Barriers

Attachments to flexible or semi-rigid barriers (discontinuous or continuous) not detailed in the **Design Standards** are not permitted.

Design and detail attachments to rigid barriers in accordance with **SDG 1.9**. Provide setback distances as shown in **Table 4.4.2** and **Figure 4.4.13** to non-crash tested discontinuous items (e.g., light poles, sign supports, traffic signal controller boxes, flood gauges, etc.) that are attached to or behind rigid barriers located along the outside shoulder. Discontinuous items located within these setback distances must be crash tested to or accepted as TL-3, at a minimum, under **NCHRP 350** or **MASH-09** as attachments to traffic railings.

For continuous items attached to rigid barriers, refer to the requirements of **Section 4.4.6.1**.

Design Standards, Index 11871 can only be used to mount permanent signs to rigid barriers along the shoulder if there is insufficient space for **Design Standards, Index 11870**, and when the sign is critical to safety. Otherwise, use **Design Standard, Index 11870**.

Fender access ladders are exempt from these requirements. Sign panels may be placed within the given setback distances, however the setback to the sign support must be increased to assure sign panels do not extend past the top inside face of the traffic railing.

4.5.1 Median Barrier Attachments

Only median barrier mounted lighting in accordance with ***Design Standards, Index 17515*** will be permitted. Overhead sign supports may be located on median traffic railings to reduce span or cantilever lengths and provide more cost effective designs. When placing overhead sign supports on rigid barriers within the median, project specific details that supplement ***Design Standards, Index 410*** (i.e. foundation and reinforcement details) are required to be shown in the Plans.

Do not place single column sign supports on median traffic railings unless AASHTO or FDOT requirements for sign visibility cannot be met by placing the sign supports on the outside shoulder of the roadway or outside shoulder of bridge or roadway traffic railing as shown in ***Figure 4.4.13***. If single column sign supports must be attached to or placed on a median traffic railing, utilize ***Design Standards, Index 11871***. For permanent signs, ***Design Standards, Index 11871*** can only be used for the signs listed in ***Section 7.2.5*** of this Volume.

These requirements also apply to attachments made to back-to-back outside shoulder concrete barriers and traffic railings that are located so close together that the required setback distances cannot be provided for both barriers. However, the concrete traffic railings and supporting decks shown in ***Figure 4.4.13*** that are located back-to-back are exempt from these requirements.

4.5.2 Existing Attachments to Median Barriers and Traffic Railings

Evaluate existing rigid barrier attachments on a case-by-case basis to ensure they are installed in accordance with the provisions of this Section and ***Design Standards, Index 11870, Index 11871, or Index 17515***. Remove existing attachments not meeting these requirements.

4.5.3 Temporary Attachments to Barriers

For temporary/work zone signs, when ***Design Standards, Index 600*** cannot be achieved for post mounted signs, and concrete barrier or traffic railing exists, use ***Design Standards, Index 11871***.

For additional information on the attachment and design of Temporary Lighting in combination with temporary barrier, refer to ***Section 10.12.13*** of this Volume.

4.6 Surface Finishes

Class 5 coatings, tints or stains may be applied to roadway concrete barriers in order to be compatible with the treatment of bridge or retaining wall mounted traffic railings or for corridor uniformity. Approval by the District Design Engineer is required for the use of Class 5 coatings, tints or stains on the outside of concrete roadside barriers. Approval by the Chief Engineer is required for the use of Class 5 coatings, tints or stains on median barriers and the inside and top surfaces of concrete roadside barriers. Abrupt changes of aesthetic treatment of barriers/railings/parapets from a bridge to a roadway should be avoided. See ***SDG, Section 1.4.5*** for the policy on bridge, noise wall and retaining wall surface finishes.

The Department will cover the cost for coating, tints or stains on roadway concrete barriers only as described above. If a Local Maintaining Agency desires a roadway concrete barrier with coatings, tints or stains and the concrete barrier does not qualify for such treatment as determined by the Department, the barrier may be treated with approval by the District Secretary. The Local Maintaining Agency must provide the additional construction funding for the coatings, tints, or stains and must commit to cover the associated maintenance costs for the service life of the barrier.

Modification for Non-Conventional Projects:

Delete ***PPM Section 4.6*** and see RFP for requirements.

4.7 Upgrading Existing Barrier Systems

When existing barrier is present on a project for which reconstruction of the roadside is not required, including RRR projects, the barrier should be reviewed for deficiencies. In making this determination, investigate the existing installation and determine if the barrier meets adequate structural, functional and crashworthy requirements. Any barrier installation which is found to be non-crashworthy or crash tested prior to **NCHRP 350** test criteria must be removed or replaced. The investigation should consider the following at a minimum:

1. Whether there is a need for the barrier. If cost effective, the hazard should be removed, relocated, or redesigned and the barrier removed.
2. Length of Need.
3. Proper guardrail panel height.
4. Adequate offset at terminal end.
5. Proper deflection distance between the barrier and the shielded object.
6. Proper placement with respect to the traveled way.
7. Proper placement with respect to the face of curb.
8. Placement on the proper slope.
9. Adequate clear recovery area behind gating end terminals.
10. The overall condition of the barrier installation (e.g. corrosion of metal components, erosion around posts, degradation of wood blockouts/posts, etc.)
11. Post type, condition and spacing.
12. Existing unshielded hazards. For RRR projects, existing roadside hazards within the project corridor should be evaluated for adequate end treatment applications.

In some cases the deficiencies are so obvious that the best course of action is readily apparent. However, many times the deficiencies are marginal and the extent of the barrier upgrade must be based on engineering judgment. Factors which should be considered are:

1. Nature and extent of barrier deficiency.
2. Past crash history.
3. Cost effectiveness of recommended improvement.
4. Whether future scheduled reconstruction or RRR work in the 5 year work program will address the deficiency.

In addition to the above evaluation requirements, roadside safety hardware on RRR projects must comply with the requirements of the following Sections.

4.7.1 Resetting Guardrail

For installations of guardrail where the barrier is determined to be deficient or requires relocating due to other work, but otherwise determined to consist of panels in good condition, the guardrail may be reset. If the guardrail system is determined to be non-reusable, remove and replace with new guardrail. Refer to **Specification, Section 538** for additional information on reusable and non-reusable guardrail components.

When resetting existing guardrail, the guardrail will be reinstalled as **31" Guardrail** reusing existing guardrail panels and posts (steel only) as shown in the current **Design Standards, Index 400**. This resetting requires panels be reinstalled with the panel splices located at the midspan. As such, consideration must be given to the effect this will have on the overall system length and if adjustments to the Begin/End Guardrail Station are needed.

Rigid-Barrier Approach Transitions, Approach End Terminals and Trailing Anchorages must be replaced with new hardware, panels, and posts when resetting guardrail.

4.7.2 Existing Longitudinal Roadway Barriers on RRR Projects

Existing longitudinal guardrail sections that do not conform to **31" Guardrail** must be upgraded or replaced on RRR projects, with the following exceptions:

1. **27" Guardrail** – Existing W-Beam guardrail installations installed to a 1'-9" mounting height (27" top height), meeting the requirements of the **2013 Design Standards** with regards to delineation, height, grading, mounting hardware, and consisting of crashworthy end treatments tested to at least **NCHRP 350**, is acceptable and allowed to remain in place.
2. **Thrie-Beam Guardrail** – Existing Thrie-Beam guardrail meeting the installation requirements of **2013 Design Standards**, and consisting of crashworthy end treatments tested to at least **NCHRP 350**, is acceptable and allowed to remain in place.
3. **Steel Blocks** – Existing **27" Guardrail** constructed with steel blocks, which is not being evaluated for upgrading according to the criteria above, may remain in place for projects with Design Speeds ≤ 45 mph.

Replacing or resetting existing **27" Guardrail** to meet the **31" Guardrail** mounting height requirement is at the discretion of the District. Typically, if 50% or more of an existing run of **27" Guardrail** is affected or if the existing installation is extended by 50% or more, the entire run should be replaced or reset with **31" Guardrail**.

Modification for Non-Conventional Projects:

Delete the last paragraph and see RFP for requirements.

Existing concrete barriers conforming to the current **Design Standards, Index 410**, New Jersey shape barriers, and approved vertical faced concrete barriers may remain in place. Other concrete barrier shapes must be replaced.

Replacements and new installations must conform to the current **Design Standards**.

See **Section 4.4.5.4** and **SDG, Section 2.6**, for barrier requirements for Pier Protection.

4.7.3 Existing End Treatments & Crash Cushions on RRR Projects

Ends treatments and crash cushions which have not been crashed tested and approved for use under at least **NCHRP 350** must be removed and replaced.

Existing guardrail end treatments must be upgraded or replaced unless they conform to one of the systems identified on the **APL**, the current **Design Standards**, or the **2013 Design Standards**.

Replacements and new installations must conform to the current **Design Standards**.

End treatments for concrete barrier ends should be evaluated on a case-by-case basis to ensure adequate Length of Need (LON) and crashworthiness. Review the crash history in the vicinity of concrete barrier ends which are not protected by a crash cushion or otherwise transitioned to a guardrail approach end terminal (i.e. Sloped Concrete End Treatments).

4.7.4 Bridge Traffic Railing on RRR Projects

Bridge mounted traffic and pedestrian railings must meet the requirements specified in the *SDG, Sections 6.7* and *6.8*, respectively, except for the cases identified herein. FDOT policy is to bring bridge traffic and pedestrian railings to current standards on bridges that are being widened or rehabilitated and to evaluate them for possible replacement or retrofitting on RRR projects. Bridge traffic and pedestrian railings are required to be evaluated for conformance to current criteria and standards whenever any improvements are made to any bridge or its approach roadway.

An existing structurally continuous narrow or recessed curb post-and-beam bridge traffic railing within a RRR project may be left in place when the following three criteria are met:

1. No structural work is being performed on the bridge;
2. The existing approach roadway alignment or cross section is to remain unchanged; and,
3. There is no crash history or evidence of any impact into the bridge traffic railing.

Evaluate the need to retrofit these railings for compliance with pedestrian railing criteria on a case-by-case basis and retrofit as necessary. See *IDS-404* for details of structurally continuous narrow and recessed curb post-and-beam bridge traffic railings.

An existing structurally continuous wide curb post-and-beam bridge traffic railing within a RRR project may be left in place if the above three criteria are met and the Design Speed is ≤ 45 mph. See *IDS-405* for details of structurally continuous wide curb post-and-beam bridge traffic railings.

The *Design Standards, Index 470* and *480 Series*, (used in conjunction with *Design Standards, Index 402*), may be used to retrofit existing obsolete structurally continuous post-and-beam bridge traffic railings and approach guardrail transitions when the bridge traffic railing does not meet the criteria listed above. See *IDS-477* for details of obsolete structurally continuous post and beam traffic railings. For additional information, see the *IDS's* for the entire *Index 470* and *480 Series*.

All other existing obsolete bridge traffic railings within a RRR project must be brought up to current standards, or a Design Variation must be obtained for the project, providing that railing replacement or retrofit, or entire bridge replacement, is scheduled within a reasonable time.

The Thrie-Beam Guardrail Retrofit and Vertical Face Retrofit shown in the **Design Standards, Index 470** and **480 Series** respectively, are suitable for retrofitting specific types of obsolete bridge traffic railings. These retrofits provide a more economical solution for upgrading obsolete traffic railings when compared with replacing the obsolete traffic railings and portions of the bridge decks that support them. As these retrofits do not provide for any increase in clear width of bridge deck, and in a few cases actually decrease clear width slightly, they should only be considered for use on existing bridges where adequate lane and shoulder widths are present. Detailed guidance and instructions on the use of these retrofits is included in the **IDS's** for the **Index 470** and **480 Series**.

Superseded FDOT Standard Traffic Railings conforming to the designs shown in **IDS-402**, "A Historical Compilation of Superseded Florida Department of Transportation "Structures Standard Drawings" for "F" and "New Jersey" Shape Structure Mounted Traffic Railings", are both structurally and functionally adequate.

Existing bridge traffic railing retrofits constructed in accordance with **1987** through **2000 Roadway and Traffic Design Standards, Index 401, Scheme 16**, "Guardrail Continuous Across Bridge" may be left in place provided the following four criteria are met:

1. The retrofit railing is in good condition.
2. There is not a history of severe crashes at the site.
3. The bridge is not on an Interstate or a high-speed-limited-access facility.
4. The dimension from the center of the W-beam guardrail to the roadway surface is at least 1'-9" (1" tolerance acceptable).
5. Approach Transition must be in accordance with the **2013 Design Standards, Index 403**.

Existing bridge traffic railing retrofits constructed in accordance with **1987** through **2000 Roadway and Traffic Design Standards, Index 401, Schemes 1 and 19** "Concrete Safety Barrier" may be left in place provided the height of the railing is at least 2'-5" measured from the roadway surface.

Other former FDOT bridge traffic railings not listed above and any other traffic railings that are not based on crash tested designs are inadequate and must be replaced, retrofitted, or receive a Design Variation, as appropriate, using the criteria included in the **SDG**.

Remove existing fences other than those in compliance with **Design Standards, Indexes 810** or **812**, and existing pedestrian railings that are mounted on existing traffic railings located between the shoulder and the sidewalk (a.k.a. "inboard" traffic railings). Replace or retrofit the existing pedestrian railing or fence rather than completely removing it if there is a documented issue of traffic incidents involving pedestrians (at the site before installation of the existing pedestrian railing or fence on the inboard traffic railing) that would likely reoccur if the existing installation were to be removed. Use **Design Standards, Indexes 810** or **812**, or another crashworthy pedestrian railing or fence that is compatible with the traffic railing, as appropriate. Retrofit existing bullet-type railings that are to remain on inboard traffic railings and that do not have the bullet railing member(s) oriented towards the traffic side of the railing to match **Design Standards, Index 821**.

Retrofit existing installations of **Design Standards, Index 821**, and other similar bullet-type railings, to include rail splice assemblies and tapered end transitions as shown on **Design Standards, Index 822** if they are not present. Retrofit the ends of other existing crashworthy traffic railing mounted pedestrian railings to include a similar tapered end transition, or other appropriate approach end transition, if one is not present.

Remove existing non-crashworthy pedestrian railings and fences that are not mounted on existing traffic railings if they are located within the lateral offset as defined in **Table 4.2.3, "Lateral Offset to Other Roadside Obstacles"**, unless there is a documented issue of traffic incidents involving pedestrians at the site before installation of the existing pedestrian railing or fence that would likely reoccur if it were to be removed.

4.7.5 Guardrail to Bridge Railing Transitions on RRR Projects

For guardrail to bridge rail transition requirements, whether bridge traffic railing is retrofitted or not, meet the requirements of this Section.

Existing guardrail to bridge traffic railing approach and trailing end transitions must be upgraded or replaced unless they conform to one of the following systems:

1. For approach ends of existing standard New Jersey Shape and F-Shape bridge traffic railings:
 - a. The nested Thrie-Beam approach transition shown as in the current **Design Standards** or the **2013 Design Standards, Index 400**.

- b. For retrofitted installations, the appropriate nested Thrie-Beam transition shown in the current **Design Standards** or the **2013 Design Standards, Index 402**.
 - c. For a design speed ≤ 45 mph the nested w-beam approach transition shown as **Detail J** in the **1998 Roadway and Traffic Design Standards, Index 400**, Sheet 7 of 21. This detail is also shown in the **2000 Roadway and Traffic Design Standards, Index 401**, Sheet 1 of 9.
 2. For approach ends of existing bridge traffic railing retrofits constructed in accordance with the **1987 through 2000 Roadway and Traffic Design Standards, Index 401, Schemes 1 and 19, "Concrete Safety Barrier"**:
 - a. The appropriate nested Thrie-Beam transition shown in **Design Standards, Index 402**.
 - b. For design speeds ≤ 45 mph the w-beam approach transition shown as **Detail J** in the **1987 Roadway and Traffic Design Standards, Index 400**, Sheet 9 of 13, upgraded as shown in the **2013 Design Standards, Index 403** by the installation of a nested section of W-beam guardrail, additional guardrail posts and offset blocks and a transition block if a curb is not present beyond the bridge end.
 - c. For design speeds ≤ 45 mph the nested W-beam approach transition shown as **Detail J** in the **1998 Roadway and Traffic Design Standards** Sheet 7 of 21, upgraded as shown in the **2013 Design Standards, Index 403** by the installation of a transition block if a curb is not present beyond the bridge end.
 3. For trailing ends of existing bridge traffic railing retrofits constructed in accordance with the **1987 through 2000 Roadway and Traffic Design Standards, Index 401, Schemes 1 and 19, "Concrete Safety Barrier"**:
 - a. In the absence of additional hazards on the trailing end, no end treatment is required.
 - b. When additional hazards are present on the trailing end, a w-beam trailing end treatment as shown in **Design Standards, Index 400**.
 4. For approach ends of existing structurally continuous Post and Beam bridge traffic railings that are not being retrofitted per **Section 4.7.4**:
 - a. A custom designed nested Thrie-Beam approach transition based the current **Design Standards, Index 400**.
 - b. A nested Thrie-Beam approach transition based on the current **Design Standards, Indexes 402, 404 or 405**.

- c. A custom designed nested Thrie-Beam approach transition based on the **1987 through 2000 Roadway and Traffic Design Standards, Index 401, Scheme 29.**
5. For trailing ends of existing structurally continuous Post and Beam bridge traffic railings that are not being retrofitted, per **Section 4.7.4:**
 - a. In the absence of additional hazards on the trailing end, no end treatment is required.
 - b. When additional hazards are present on the trailing end, a w-beam trailing end treatment as shown in the current **Design Standards, Index 400** or the **1987 through 2000 Roadway and Traffic Design Standards, Index 401.**
 - c. When additional hazards are present on the trailing end, a custom designed nested Thrie-Beam approach transition based on any design listed in No. 4 above.

Guardrail replacements and new installations connecting to standard New Jersey Shape and F-Shape bridge traffic railings must conform to the current **Design Standards, Index 400.** For guardrail retrofits connecting to existing bridge traffic railings, see the current **Design Standards, Indexes 402 or 477** and their associated **IDS.**

Guardrail replacements, retrofits and new installations connecting to structurally continuous post and beam bridge traffic railings must conform to **Design Standards, Indexes 404 or 405** and their **IDS's.** See the **IDS** for details of structurally continuous post and beam traffic railings.

4.8 Non-Standard Roadside Safety Hardware

The **APL** includes proprietary devices and products that have been evaluated for compliance with FDOT **Standard Specifications for Road and Bridge Construction** and the **Design Standards**. The majority of proprietary roadside safety hardware eligible for use on the State Highway System are identified on the **APL**. However, the devices included on the **APL** may not cover every roadside safety application. Unique situations will sometimes require unique devices. Examples of available devices that are not covered by the **APL** include but are not limited to barrier wall gates, aesthetic guardrail, temporary steel barriers, and crashworthy stop gates. When the need arises for a unique crashworthy device not included on the **APL**, carefully investigate the applicability of the device for the situation, as well as the crash performance characteristics of the device. For some of these devices, the State Roadway Design Office (RDO) may have information and be of assistance in establishing the appropriateness of the device for a given situation.

If a device not included on the **APL** or barrier system not detailed in the **Design Standards** is deemed appropriate the following supporting documentation is required for approval:

1. FHWA, Federal-Aid Reimbursement Eligibility Letter
2. Crash Test Reports, including review of test results. Performance characteristics must be reviewed, including post impact vehicle behavior and post impact test article deflection, debris scatter, etc.
3. Compatibility with adjacent and/or connecting standard roadside safety devices.
4. Maintenance requirements and characteristics, including coordination with the District Maintenance Office.
5. For devices such as barrier gates, operational plans and training as appropriate.

The use of Non-Standard Roadside Safety Hardware must be approved by the State Roadway Design Office (RDO).

Project specific plan details, technical special provisions (TSP), and method of payment will be required and must be coordinated with the appropriate Department Offices.

Other barrier designs may be required by specific site conditions. Site specific conditions are identified and detailed in the plans on a project-by-project basis.

Chapter 5

Utilities

5.1	General	5-1
5.2	Utility Work Schedules and Agreements	5-2
5.3	Utility Locates.....	5-2
5.3.1	Quality Levels for Utility Locates	5-3

THIS PAGE LEFT BLANK INTENTIONALLY

Chapter 5

Utilities

5.1 General

The designer is to make reasonable efforts to accommodate all existing utilities and any utilities to be constructed during the project. The designer is also responsible for identifying needed utility work (such as the removal, relocation, de-energizing, deactivation, or adjustment of utilities) and obtaining the agreements or orders to schedule this work. Consequently, coordination between the Department and the Utility Agency/Owner (UAO) is to be accomplished throughout the design process.

Utility work is necessary for but not limited to, the following conditions:

1. When utilities lie within the vertical and horizontal construction limits, plus the reasonably required distance for working room necessary for operation of equipment normally used for the particular type of construction, or for compliance with OSHA (**29 CFR Part 1926**), NESC or other regulations.
2. When utilities lie within the horizontal limits of the project and within 12 inches below the ground surface or the excavation surface on which the Contractor operates construction equipment, or within 12 inches below the bottom of any stabilizing course specified in the plans.
3. When utilities lie within the normal limits of excavation for underground drainage facilities or other structures. Such normal limits must extend to side slopes along the angle of repose, as established by sound engineering practice, unless the Contract Documents require support of the excavation sides by sheeting.

Design features that reduce or avoid utility conflicts may be more expensive; however, those expenses may be offset by savings in construction time and the total associated savings for the FDOT project and the utilities. Additional guidance for accommodating utilities within the highway rights of way are given in the AASHTO publications ***A Guide for Accommodating Utilities within Highway Right-of-Way*** and ***A Policy on Geometric Design of Highways and Streets*** and in the TRB publication ***Policies for Accommodation of Utilities on Highway Rights-of-Way***.

5.2 Utility Work Schedules and Agreements

In order to certify the project in accordance with **Utility Work Agreements and Certification Process Topic No. 710-010-050**, the designer, with assistance from the District Utilities Office and the Office of General Counsel, will obtain the necessary **Utility Work Schedules (Form 710-010-05)**, relocation agreements, and any required payments to or by the Department for Utility Work. When an agreement cannot be obtained, the designer must coordinate with the District Utilities Office and the Office of General Counsel to pursue any needed order to relocate.

Modification for Non-Conventional Projects:
Delete PPM 5.2 and see RFP for requirements.

5.3 Utility Locates

It is the responsibility of the designer, with the assistance of the District Utility Office to determine the locations and Quality Levels necessary to obtain the needed utility information. The description of the information obtained from each Quality Level of locate is provided in **Section 5.3.1**.

It is the responsibility of the UAOs to provide Quality Level “D”, “C” and “B” locates on request. In some instances the UAOs can provide Quality Level “A” locate information.

Quality Level “A” locate information is to be obtained when proposed construction operations are suspected to be within three feet (3’) of major utilities. Major utilities are those underground and aboveground utilities that if damaged or required to relocate would cause high construction costs to the UAO, other utilities, or FDOT. The UAO may be able to provide this information; however, it is the responsibility of the Designer to obtain this level of information when needed and when the UAO will not be providing this information. The decision to proceed to construction without this information must be made with consultation with the District Utility Office, appropriate construction personnel and the UAO.

5.3.1 Quality Levels for Utility Locates

The following identifies the key elements within the quality level of utility locates in ascending order about which Subsurface Utility Engineering is applied:

- Quality Level “D” - Existing Records
- Quality Level “C” - Surface Visible Feature Survey
- Quality Level “B” - Designating
- Quality Level “A” - Locating

A detailed description of the scope of work to be included to achieve the various Quality Levels follows:

Quality Level “D” locates are information obtained solely from a review of utility records for facilities that may be affected by the project. The comprehensiveness and accuracy of such information is highly limited. Even when existing information for a utility in a particular area is accurate, there are often other underground systems that are not shown on any records.

Quality Level “D” may be appropriate for use early in the development of a project to determine the presence of utilities. Applicable records may include previous construction plans in the area, conduit maps, direct-buried cable records, distribution maps, transmission maps, service record cards, “as-builts” and record drawings, field notes, county, city, UAO or other geographic information system databases, circuit diagrams, or oral histories. The records should be reviewed for indications of additional available records, duplicate information, and credibility of such duplicate information, and need for clarification by UAO’s. The end product of a Quality Level “D” would be a utility composite drawing or equivalent. The engineer should also make professional judgments regarding the validity and location of topographic features on records versus current topographic features (when available) and conflicting reference of utilities. The engineer should indicate the quality levels, utility type and/or ownership, date of depiction, accuracy of depicted appurtenances, end points of any utility data, active, placed out of service, size, condition, number of jointly buried cables, and encasement.

Quality Level “C” locates are information obtained to augment Quality Level “D” information. This involves topographic surveying of visible, above ground utility features such as poles, hydrants, valve boxes, circuit breakers, etc. If previously surveyed, check survey accuracy and completeness for applicability with the existing project. Correlate applicable utility records to the surveyed features, taking into account the geometries and indications on the records of these surface features. Determine when records and features do not agree and resolve discrepancies. Additional resolution may result from

consultation with UAOs. Quality Level “C” may be appropriately used early in the development of a project and will provide better data than Quality Level “D” information alone. Designers cannot be sure their design is appropriate nor can construction proceed without caution when using information for underground utilities based only on Quality Level “D” and “C” locates.

Quality Level “B” locates are information obtained to augment Quality Level “C” information. Quality Level “B” locates are information obtained through the use of designating technologies (e.g., geophysical prospecting technologies). This is an application using scanning technologies, most of which have very specific capabilities and limitations that vary with site conditions. Applying a variety of techniques is essential to the process of preparing a comprehensive horizontal map of utilities and other underground structures on the site. Designating technologies are capable of providing reasonable horizontal information but provide limited vertical information. Mark the indications of utilities on the ground surface for subsequent survey. Care should be taken to differentiate markings placed on the ground for design purposes from those placed on the ground for damage prevention purposes. Survey all markings that indicate the presence of a subsurface utility. This survey should be to the accuracy and precision dictated by the project’s survey control. Depict all designated utilities. Correlate the designated utilities’ depictions with utility records and/or surveyed appurtenances to identify utilities that may exist but were not able to be designated. Resolve differences between designated utilities and surveyed appurtenances. Recommend to the project owner additional measures to resolve differences if they still exist.

Quality Level “A” locates provide the highest level of accuracy of utility locations in three dimensions. This Quality Level may apply manual, mechanical, or nondestructive (e.g., vacuum excavation) methods to physically expose utilities for measurement and data recording. Quality Levels “B”, “C”, and “D” locates are incorporated in Quality Level “A” locates. The designer should obtain Quality Level “A” locates at highway/utility conflict points where verified information is necessary. Select an appropriate method of gathering data that will achieve the accuracies and precision required by the project. These accuracies are currently typically set to one half (0.5) inch vertical and to applicable horizontal survey and mapping accuracy as defined by the project owner. Excavate test holes exposing the utility to be measured in such a manner that protects the integrity of the utility to be measured. Comply with applicable utility damage prevention laws, permits, and specifications and coordinate with Utility and other inspectors, as required. Determine (a) the horizontal and vertical location of the top and/or bottom of the utility referenced to the project survey datum; (b) the elevation of the existing grade over the utility at a test hole referenced to the project survey datum; (c) the outside diameter of the utility and configuration of non-encased, multi-conduit systems; (d) the utility structure material composition, when reasonably ascertainable; (e) the benchmarks and/or project

survey data used to determine elevations; (f) the paving thickness and type, where applicable; (g) the general soil type and site conditions; and (h) such other pertinent information as is reasonably ascertainable from each test hole site. Resolve differences between depicted Quality Level "A" data and other quality levels.

THIS PAGE LEFT BLANK INTENTIONALLY

Chapter 6

Railroad Crossing

6.1	General	6-1
6.2	At-Grade Crossings.....	6-1
6.2.1	Devices	6-1
6.2.2	Surfaces.....	6-2
6.2.3	Quiet Zones	6-2
6.2.4	Railroad Crossing Near or Within Project Limits	6-3
6.2.5	Bicycle and Pedestrian Facilities	6-3
6.3	Grade Separations	6-4
6.3.1	Bridge Width.....	6-4
6.3.2	Lateral Offset to Face of Structures	6-4
6.3.2.1	Adjustments for Track Geometry	6-6
6.3.2.2	Adjustments for Physical Obstructions	6-6
6.3.2.3	Required Foundation Clearances	6-6
6.3.3	Crash Walls.....	6-6
6.3.4	Vertical Clearance.....	6-6
6.3.5	Special Considerations	6-7
6.3.6	Widening of Existing Overpasses	6-7
Tables		
Table 6.3.3	Horizontal Clearances for Railroads	6-5
Figures		
Figure 6.1	Track Section	6-5
Figure 6.2	Section Thru Tracks	6-8

THIS PAGE LEFT BLANK INTENTIONALLY

Chapter 6

Railroad Crossing

6.1 General

This chapter provides requirements for highway-railroad crossings on the State Highway System. Coordinate projects involving a railroad crossing with the Department's Rail Office in accordance with [Section 341.302, Florida Statutes](#).

State-owned rail corridors include the Central Florida Rail Corridor and South Florida Rail Corridor.

Other railroad companies currently operating in the state of Florida include:

1. CSX Transportation, Incorporated
2. Norfolk Southern Corporation
3. Florida East Coast Railway Company

Additional shortline railroad companies and terminal switching companies also operate in the state of Florida.

6.2 At-Grade Crossings

Selection of the warning devices to be used is a function of the geometrics of railroad-highway grade crossing, including the alignment, profile, sight distance and cross section of both the roadway and the railroad. The roadway should cross the railroad at an angle of or near 90 degrees.

Design considerations are discussed in Chapter 7 of the [Florida Greenbook](#) and the *AASHTO Policy on Geometric Design*.

6.2.1 Devices

Traffic control devices for railroad-highway grade crossings consist primarily of signs, pavement markings, flashing light signals and automatic gates. Consider the following

when designing these devices:

- Roadway type,
- Volume of vehicular traffic,
- Volume of railroad traffic,
- Speed of vehicular traffic,
- Volume of pedestrian and bicycle traffic,
- Crash data, and
- Geometrics of the crossing.

Standards and criteria for design, placement, installment and operation of traffic control devices are located in the [Manual on Uniform Traffic Control Devices \(MUTCD\)](#), the Department's [Design Standards, Index 17882](#), and [Rule 14-57.013, Florida Administrative Code \(F.A.C.\)](#).

When preemptive signals are used in advance of a railroad crossing, they must be placed so as not to obstruct the view of the crossing signals.

6.2.2 Surfaces

The roadway travel lanes at a railroad crossing should be constructed for a suitable length with all-weather surfacing. A roadway section equal to the current or proposed cross section of the approach roadway should be carried through the railroad crossing. The railroad crossing surface itself should have a riding quality equivalent to that of the approach roadway. When selecting the type of crossing and the material to be used in its construction, consideration should be given to the character and volume of traffic using the roadway. The District Rail Coordinator should be consulted in selecting the material.

The [Design Standards, Index 560](#) contains details for the construction of crossings.

6.2.3 Quiet Zones

An at-grade railroad crossing within a designated Quiet Zone must comply with the [Code of Federal Regulations \(C.F.R.\), Part 222](#) and the [Design Standards, Index 17882](#). Quiet Zone means a segment of a rail line that includes public highway-railroad crossings at which locomotive horns are not routinely sounded. Coordinate with the Department's

Rail Office to determine if a highway-railroad crossing is located within a designated Quiet Zone.

A crossing within a Quiet Zone that involves either the State Highway System or state-owned rail lines, allowable CFR Supplemental Safety Measures (as identified in [C.F.R., Part 222, Appendix A](#)) include:

- Gates with medians, or channelization using Type IV concrete traffic separators or Type F curb and gutter. Use of temporary channelization devices is not permitted.
- Four quadrant gate systems
- One-way streets with gates
- Permanent crossing closures (for off-system roads only; refer to Florida Greenbook)

The railroad crossing should be evaluated to determine if driveways, minor side streets, or turn lanes in close proximity to the crossing require an additional gate.

6.2.4 Railroad Crossing Near or Within Project Limits

Review of federal-aid projects is required to determine if a railroad-highway at-grade crossing is in or near the limits of the project. If such crossing exists, the project will be upgraded to meet the latest [MUTCD](#) requirements in accordance **Title 23 United States Code (U.S.C.), Chapter 1, Section 109(e)** and **C.F.R. 646.214(b)**. These requirements are located in **Chapter 8** of the [MUTCD](#). “Near the terminus” is defined as being either of the following:

1. If the project begins or ends between the crossing and the MUTCD-mandated advanced placement distance for the advanced (railroad) warning sign. See [MUTCD, Table 2C-4](#) (Condition B, column “0” mph) for this distance.
2. An intersection traffic signal within the project is connected to the crossing’s flashing light signal and gate.

6.2.5 Bicycle and Pedestrian Facilities

Extend proposed or existing sidewalks, bike lanes or shared use paths through the rail crossing. For additional information refer to **Chapter 8** of this Volume.

6.3 Grade Separations

For underpasses, the bridge carries the railway and must be designed and constructed to carry railway loadings in conformance with the [*American Railway Engineering and Maintenance-of-Way Association \(AREMA\) Manual for Railway Engineering*](#), latest edition. For overpasses, the bridge carries highway traffic and must be designed and constructed to carry highway loadings. In either case, adequate clearances between the facilities must be provided.

Clearances, geometrics, utilities, provisions for future tracks, and maintenance road requirements for off-track equipment will involve negotiations with the governing railroad company. The railroad's review and approval, including need for and location of crash walls, are based on the completed BDR/30% Structures Plans.

Prepare the Structures Plans in accordance with the criteria obtained from the governing railroad company, the *Plans Preparation Manual*, and the [*Structures Detailing Manual*](#).

See **Figure 6.1** for dimensions, which must be obtained from the railroad company before preparing the BDR/30% Structures Plans. The District Rail Coordinator is an additional reference source available to the designer.

6.3.1 Bridge Width

For Roadway over Railroad, the highway bridge width is determined from the approved typical section; see **Chapter 2** of this Volume. For Railroad over Roadway, the rail bridge width will be based on project specific requirements.

6.3.2 Lateral Offset to Face of Structures

Measure lateral offset in accordance with **Figure 6.1** and **Table 6.3.3**. The governing railroad company may accept a waiver from standard offset requirements for designs involving widening or replacement of existing overpasses. Consult the FDOT's Rail Office when such action is being considered.

Lateral offset is measured from the centerline of outside track to the face of pier cap, bent cap, or any other adjacent structure. Minimum lateral offsets are shown in **Table 6.3.3**; however adjustments may be required for certain physical features and obstructions.

Figure 6.1 Track Section

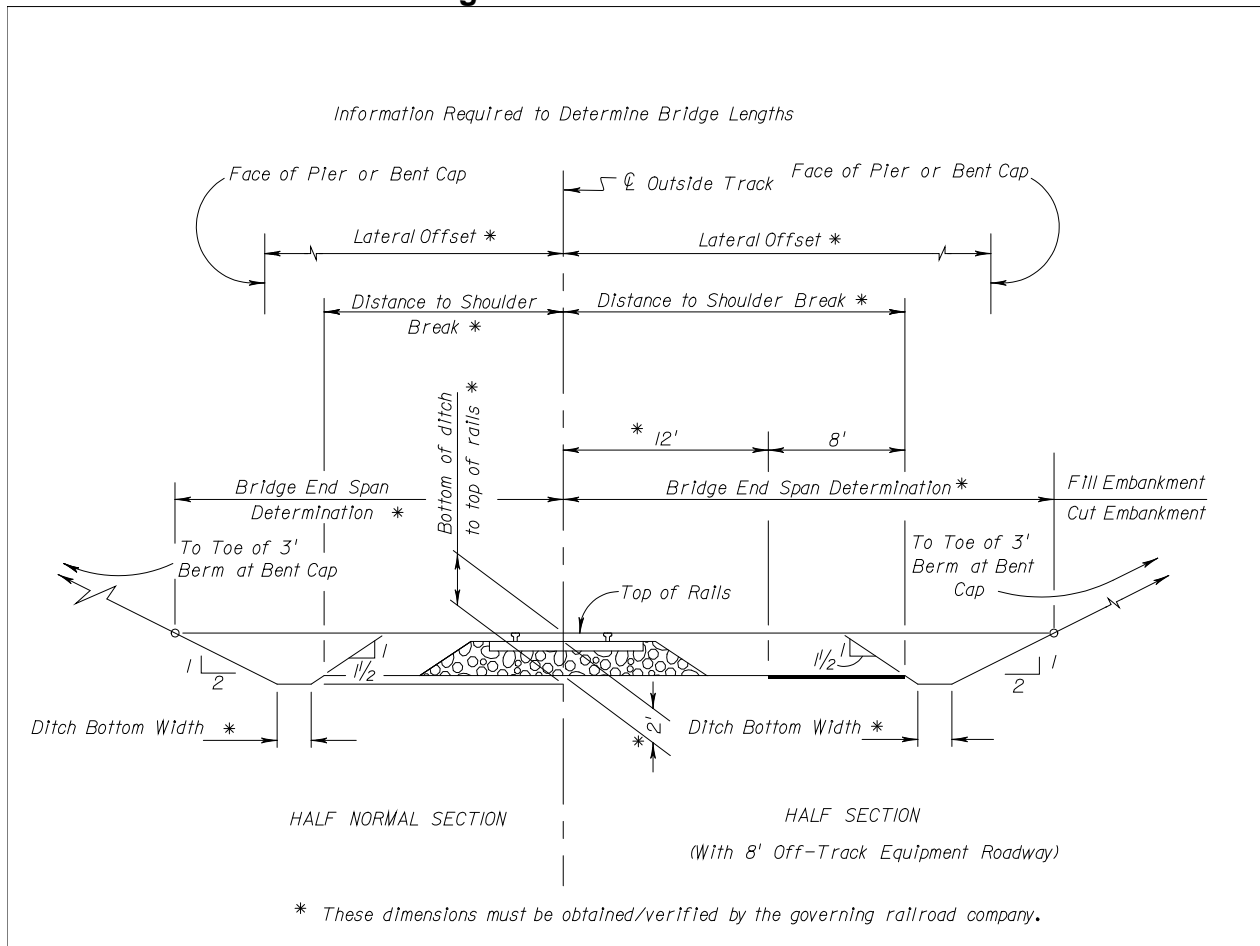

Table 6.3.3 Lateral Offsets for Railroads

Minimum Clearance Requirements	Normal Section	With 8 ft. Required Clearance for Off-Track Equip.	Temporary Falsework Opening
With Crash Walls*	18 ft.	22 ft.	10 ft.
Without Crash Walls	25 ft.	25 ft.	N/A

* See the **Structures Design Guidelines, Section 2.6.7** for crash wall requirements.

The additional 8 ft. clearance for off-track equipment must be provided only when specifically requested in writing by the railroad.

6.3.2.1 Adjustments for Track Geometry

When the track is on a curve, increase the minimum lateral offset by a rate of 1.5 inches for each degree of curvature. When the track is superelevated, increase the minimum lateral offset on the inside of the curve by 3.5 inches horizontally per inch of superelevation. Meet lateral offset requirements found in the [AREMA Manual for Railway Engineering](#) for extremely short radius curves.

6.3.2.2 Adjustments for Physical Obstructions

Columns or piles should be kept out of the ditch to prevent obstruction of drainage. Provide adequate lateral offset to avoid the need for crash walls unless extenuating circumstances dictate otherwise.

Figure 6.1 shows horizontal dimensions from the centerline of track to the points of intersection of a horizontal plane at the rail elevation with the embankment slope. This criteria may be used to establish the preliminary bridge length which normally is also the length of bridge eligible for FHWA participation; however, surrounding topography, hydraulic conditions, and economic or structural considerations may warrant a decrease or an increase of these dimensions. Coordinate these dimensions with the governing railroad company.

6.3.2.3 Required Foundation Clearances

Place edges of footings no closer than 11 feet from centerline of the track to provide adequate room for sheeting.

6.3.3 Crash Walls

See the [Structures Design Guidelines](#) for crash wall requirements.

6.3.4 Vertical Clearance

See *Table 2.10.1* of this Volume for minimum vertical clearances. Vertical clearance is the least distance between the bottom of the superstructure and the top of the highest rail utilized anywhere within the lateral offset determined by **Section 6.3.3** and **Table 6.3.3**. If a track is identified as an electrified railroad, the minimum vertical clearance is 24 feet

3 inches. This provision is based on the FDOT's **South Florida Rail Corridor Clearance Policy for 25 KV service (Topic No. 000-725-003)**. This provision also applies to tracks identified as candidates for future electrification.

6.3.5 Special Considerations

1. Shoring and Cribbing requirements during construction should be accounted for in the preparation of the preliminary plans to assure compliance with the clearance criteria set forth herein. See **Figure 6.2**.
Anything encroaching within 10 feet of the centerline of the track (e.g., cofferdams, footings, excavation) requires approval by the governing railroad company.
2. Overpasses for electrified railroads may require protection screens.
3. Sometimes the substructure supports may be located between tracks or an outside track and the off-track equipment road.
4. Drainage from the section of the bridge above railroad right of way must be drained away from the railroad right of way. Open scuppers are to be no closer than 25 feet to the centerline of the nearest track.

6.3.6 Widening of Existing Overpasses

The requirements for widening existing overpasses are as follows:

1. If existing horizontal or vertical clearances are less than those required for a new structure, it is required that the new portion of the structure be designed so as not to encroach into the existing clearances.
2. Minimum vertical clearance should take into account the track grade and the cross slope of the bridge superstructure. Therefore, it is generally more desirable to widen on the ascending side of the bridge cross slope.
3. Minimum lateral offset should take into account future changes to track geometry, physical obstructions or foundation clearances.
4. Temporary construction vertical clearances less than 22 feet and lateral offsets less than 10 feet must be approved by the governing railroad company. On high volume rail lines, it may not be possible to reduce already restricted vertical clearances.
5. If widening requires construction of new widened approach fills, it is required that the same consideration be given to drainage design as required on new bridges.

Evaluate the need for crash wall protection if new substructures provide less than 25 feet lateral offset from center line of track.

The BDR/30% Structures Plans must show a cross section at right angles to the centerline of the track where the centerline of bridge intersects the centerline of track. In situations where the substructure is not parallel to the track, or the track is curved, sections perpendicular to the centerline of the tracks must be furnished at each substructure end.

If the railroad is in an existing cut section, plan approvals will be considered by the governing railroad company on an individual location basis. Factors to be considered will be the length, depth, and type material of the existing cut section.

Figure 6.2 Section Thru Tracks

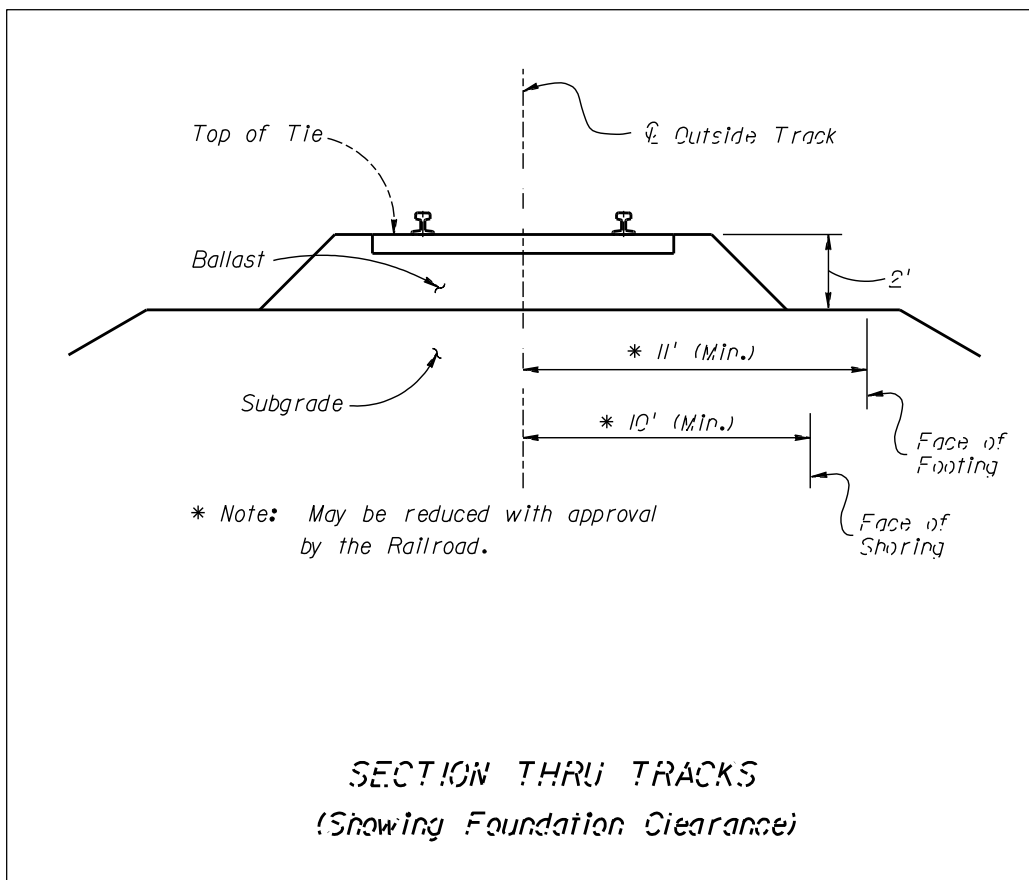

Chapter 7

Traffic and ITS Design

7.1	General	7-1
7.1.1	Railroad-Highway Grade Crossing Near or Within Project Limits.....	7-2
7.1.2	Attachments to Barriers.....	7-2
7.2	Signing	7-3
7.2.1	Design Criteria	7-3
7.2.2	Overhead Signs on Freeways and Expressways.....	7-3
7.2.3	Local Street Names on Guide Signs.....	7-4
7.2.4	External Lighting of Overhead Signs	7-4
7.2.5	Signs on Median Barriers and Traffic Railings	7-4
7.2.6	Signing Project Coordination	7-5
7.2.7	Signing for Bridges with Steel Decks.....	7-6
7.2.8	Delineators, Object Markers and Express Lane Markers	7-6
7.2.9	Roadside Flashing Beacon Assembly	7-7
7.2.10	Internally Illuminated Street Name Signs.....	7-7
7.2.11	Exit Ramp Intersections	7-8
7.3	Lighting	7-11
7.3.1	Design Criteria	7-11
7.3.2	Design Methodology.....	7-11
7.3.2.1	Analysis Zones.....	7-12
7.3.2.2	Analysis for Pedestrian Lighting at Signalized Intersections.....	7-13
7.3.2.3	Analysis of Roundabouts.....	7-19
7.3.2.4	Analysis of Midblock Crosswalks.....	7-19
7.3.3	Lighting Justification	7-22

7.3.4	Lighting Project Coordination	7-22
7.3.5	Voltage Drop Criteria.....	7-23
7.3.6	Existing Lighting During Construction.....	7-23
7.3.7	Grounding	7-24
7.4	Traffic Signals	7-25
7.4.1	Design Criteria	7-25
7.4.2	Certification and Specialty Items	7-25
7.4.3	Stop Line Location	7-25
7.4.4	Controller Assemblies	7-25
7.4.5	Left Turn Treatments.....	7-26
7.4.6	Signal Preemption	7-28
7.4.7	Intersection Design - Lane Configuration	7-29
7.4.8	Signal Loops	7-31
7.4.9	Grounding and Electrical Bonding	7-31
7.4.10	Mast Arm Supports.....	7-31
7.4.11	Traffic Signal Project Coordination	7-32
7.4.12	LED Light Sources	7-33
7.4.13	Pedestrian Countdown Signal Applications	7-34
7.4.14	Number of Signal Heads for Through Lanes	7-34
7.4.15	Backplates	7-34
7.4.16	Span Wire Assemblies	7-34
7.5	Intelligent Transportation System (ITS) Components	7-35
7.5.1	Design Criteria	7-35
7.5.2	ITS Device Approval and Compatibility	7-35
7.5.3	Required Information.....	7-36
7.5.4	Motorist Information Systems.....	7-36
7.5.4.1	Dynamic Message Sign (DMS).....	7-36
7.5.4.2	Highway Advisory Radio.....	7-38
7.5.4.3	Road Weather Information System.....	7-39

7.5.5	Video Equipment.....	7-39
	7.5.5.1 Closed-circuit Television Systems	7-39
	7.5.5.2 Video Display Systems	7-41
7.5.6	Network Devices	7-41
	7.5.6.1 Managed Field Ethernet Switch.....	7-41
	7.5.6.2 Device Server.....	7-42
7.5.7	Fiber Optic Cable and Interconnect.....	7-42
	7.5.7.1 Fiber Optic Cable	7-43
	7.5.7.2 Fiber Optic Conduit	7-43
	7.5.7.3 Fiber Optic Splices and Terminations	7-43
	7.5.7.4 Fiber Optic Cable Designating System	7-43
	7.5.7.5 Pull, Splice, and Junction Boxes.....	7-44
7.5.8	Infrastructure	7-45
	7.5.8.1 Grounding and Lightning Protection	7-45
	7.5.8.2 CCTV Pole and Lowering Device	7-46
	7.5.8.3 ITS Field Cabinet.....	7-46
	7.5.8.4 Equipment Shelter.....	7-47
7.5.9	Vehicle Detection and Data Collection	7-48
7.6	Pavement Markings	7-49
	7.6.1 Selection of Pavement Marking Material	7-49
	7.6.1.1 Standard and Refurbishment Thermoplastic.....	7-51
	7.6.1.2 Rumble Striping.....	7-51
	7.6.1.3 Profiled Thermoplastic.....	7-52
	7.6.1.4 Preformed Thermoplastic	7-52
	7.6.1.5 Permanent Tape.....	7-53
	7.6.1.6 Two Reactive Components	7-53
	7.6.2 Work Zone Pavement Markings	7-54
	7.6.3 Refurbishment Applications.....	7-54

7.6.4	No-Passing Zones.....	7-54
7.6.5	Pavement Marking Project Coordination	7-55
Tables		
Table 7.3.1	Conventional Lighting – Roadways and Signalized Intersections.....	7-19
Table 7.3.2	High Mast Lighting - Roadways.....	7-20
Table 7.3.3	Signalized Intersection Lighting Urban 3 to Urban 5 Designated Areas*	7-20
Table 7.3.4	Midblock Crosswalk Lighting	7-20
Table 7.3.5	Sign Lighting	7-21
Table 7.3.6	Underdeck Lighting - Roadways.....	7-21
Table 7.3.7	Rest Area Lighting.....	7-21
Figures		
Figure 7.2.1	Typical Layout for Diamond Interchange Exit Ramp	7-9
Figure 7.2.2	Typical Layout for Partial Cloverleaf/Trumpet Exit Ramp	7-10
Figure 7.3.1	Vertical Illuminance Calculation for Near Side Movement	7-15
Figure 7.3.2	Vertical Illuminance Calculation for Right Turn Approach.....	7-16
Figure 7.3.3	Vertical Illuminance Calculation for Left Turn Approach.....	7-17
Figure 7.3.4	Typical Lighting Layout for Large Intersection	7-18
Figure 7.6.1	Pavement Marking Material Selection	7-50

Chapter 7

Traffic and ITS Design

7.1 General

Traffic control devices and intelligent transportation system (ITS) deployments are necessary to help ensure highway safety by providing the orderly and predictable movement of all traffic, motorized and non-motorized, throughout the highway transportation system, and to provide such guidance and warnings as are needed to ensure the safe and informed operation of individual elements of the traffic stream. The design and layout of signs, signals, pavement marking and lighting should complement the basic highway design.

Projects including signing, lighting, traffic signals, pavement marking and ITS must comply with the Department's [Standard Specifications](#), [Design Standards](#), [Traffic Engineering Manual \(TEM\)](#), [Structures Manual, Volume 3](#), and [Manual on Uniform Traffic Studies \(MUTS\)](#) in addition to the following documents:

[Manual on Uniform Traffic Control Devices \(MUTCD\)](#) - This manual was adopted by the Department as the uniform system of traffic control for use on the streets and highways of the State. This action was in compliance with [Chapter 316.0745](#) of the *Florida Statutes*. The *MUTCD* is therefore the basic guide for marking. The requirements of the *MUTCD* must be met, as a minimum, on all roads within the State. Where the Department's documents indicate criteria which is more stringent than the *MUTCD*, the FDOT criteria must be followed.

[Standard Highway Signs, FHWA](#) - This manual contains detailed drawings of all standard highway signs and pavement marking messages. Each sign is identified by a unique designation. Signs and pavement markings not included in this manual or in the *Design Standards* are to be detailed in the plans.

Roadway Lighting Design Guide, AASHTO - This document is the basic guide for highway lighting. It includes information on warranting conditions and design criteria.

AASHTO LRFD Specifications for Structural Supports for Highway Signs, Luminaires, and Traffic Signals and **FDOT Structures Manual** - These documents provide structural design criteria.

Refer to **Chapter 29** of this Volume for information regarding structural support requirements. Refer to **Chapters 23, 24 and 25** of Volume 2 for information regarding plan requirements.

7.1.1 Railroad-Highway Grade Crossing Near or Within Project Limits

Federal-aid projects with a railroad-highway grade crossing near or within the project limits should refer to **Section 6.2.4**.

7.1.2 Attachments to Barriers

Refer to **Chapter 4** of this Volume for information regarding proposed attachments to bridge traffic railings, concrete median barrier walls, concrete shoulder barrier walls or the evaluation of existing attachments.

7.2 Signing

7.2.1 Design Criteria

Refer to the *MUTCD, Design Standards*, and *Chapter 4* of this Volume for acceptable sign locations. Sign supports are to be breakaway unless the sign is bridge or barrier wall mounted, or placed outside the clear zone.

Provide a 4 feet clear width, not including the width of curb, when a sign is located within a sidewalk.

7.2.2 Overhead Signs on Freeways and Expressways

Section 2A.17 of the *MUTCD* lists thirteen optional conditions where overhead signs have value on freeways and expressways. This section specifies the specific conditions which will apply for certain locations. Locations other than those required by the *MUTCD* or noted below will utilize ground mounted signs.

Use overhead signs for freeway and expressway Exit Direction signs when any of the following conditions exists:

1. Interchange Spacing \leq 3 Miles
2. Left Exit on a Freeway
3. Three or More Through Lanes (When Determined by the District Design Engineer to be Appropriate)

Use overhead signs for freeway and expressway Advance Guide signs when any of the following conditions exists:

1. Interchange Spacing \leq 3 Miles
2. Left Exit on a Freeway
3. Freeway to Freeway Interchange (1/2 mile and 2 mile, 1 mile required by *MUTCD*)

This criteria is not intended to restrict the use of overhead signs where there is insufficient space for post mounted signs or where there is restricted sight distance.

Place overhead advance guide signs over the shoulder with the edge of the sign aligned with the edge of the traveled way unless otherwise shown in the **MUTCD**. Extend overhead exit signs over the ramp. If a barrier is present to shield another hazard, the upright should be located near the back of the barrier with proper setback for barrier performance.

7.2.3 Local Street Names on Guide Signs

Standard practice is to use route numbers on guide signs to designate roadways. When the local name for a roadway is more familiar than the route number, the local street name may be used. The decision to use a local name should be coordinated with the District Traffic Operations Engineer because it often requires a larger sign panel.

7.2.4 External Lighting of Overhead Signs

Provide external lighting of overhead signs only for the following conditions:

1. Horizontal curves with radii of 880 feet or less in rural areas.
2. Horizontal curves with radii of 2500 feet or less in urban areas.
3. In sag vertical curves with a K value of 60 or less.

Show sign lighting requirements on the Guide Sign Worksheet when sign lighting is required. Include sign lighting calculations in the Lighting Design Analysis Report.

7.2.5 Signs on Median Barriers and Traffic Railings

For information regarding attachments to barrier, refer to **Section 4.5** of this Volume. Utilize **Design Standards, Index 11871** when attaching the following permanent sign supports to a median traffic railing:

- No U-Turns (R3-1) w/ Official Use Only (FTP 65-06)
- Left Lane Ends (W9-1)
- Lane Ends Merge Right (W9-2)
- Merge Symbol (W4-2)

No other permanent signs are to be attached to median traffic railings. **Design Standards, Index 11871** may be used for temporary or work zone signs when **Design Standards, Index 600** cannot accommodate post mounted signs within existing conditions.

7.2.6 Signing Project Coordination

Coordination with other offices and agencies is a very important aspect of project design. The offices discussed in this section are those that are typically involved in a signing and marking project, however there may be other offices or agencies involved.

Roadway Design – Typically, the designer of a signing and pavement marking project receives the base sheets and any required cross sections from the roadway designer. Base sheets may be created from existing plans when the signing project is not part of an active roadway design project.

Utilities - The District Utilities Engineer provides the coordination between the designer and the various utilities that may be involved in the signing project. The Utilities Section may assist in identifying or verifying conflicts with overhead and underground utilities. The District Utilities Engineer should be contacted as early in the design phase as possible.

Structures Design - The Engineer of Record for Structures Design provides the design of the sign structure and foundation for overhead cantilever and overhead truss sign assemblies. The Engineer of Record should be contacted early in the design phase to allow adequate time for coordination with the Geotechnical Engineer in obtaining the necessary soils information.

Right of Way – Contact the State Outdoor Advertising and Logo Manager on any project affecting business logo structures. Refer to **Section 13.5.5** of this Volume for requirements and additional information.

Modification for Non-Conventional Projects:

Delete **PPM 7.2.6** and replace with the following:

7.2.6 Signing Project Coordination

The Design-Build firm must submit a master signing plan with the Technical Proposal. The master signing plan can be on a roll plot.

7.2.7 Signing for Bridges with Steel Decks

Place Slippery When Wet signs (W8-5) in advance of all movable and non-movable bridges with steel decks. Refer to **Section 2.1** of the *Traffic Engineering Manual*. This requirement applies only to temporary bridges.

7.2.8 Delineators, Object Markers and Express Lane Markers

An object marker is used to mark obstructions within or adjacent to the roadway. The *MUTCD* describes four object markers and how they are to be used. A Type 1 or Type 3 object marker is used to mark obstructions within the roadway. A Type 2 or Type 3 object marker is used to mark obstructions adjacent to the roadway. A Type 4 object marker (end-of-roadway marker) is used to alert users of the end of the road.

A delineator is a guidance device rather than a warning device. The *MUTCD* and *Design Standards, Index 17345* illustrate the use of delineators along the edge of freeways, expressways and interchange ramps. A delineator may be a flexible or a non-flexible type. District maintenance offices generally have a preference on which should be specified.

Modification for Non-Conventional Projects:

Delete the last sentence of the above paragraph and see RFP for requirements.

A delineator is also used to mark both rural and urban median openings. In general, flexible delineators are used on urban median openings and non-flexible are used on rural median openings. A high visibility median delineator should be used on traffic separators at the following locations:

- Multilane intersections where additional visibility is required for the marking of the traffic separator,
- Where the separator is obstructed due to crest vertical curves,
- Intersections where the alignment thru the intersection is not straight, and
- Where traditional flexible delineators are constantly being replaced.

Use high performance delineators only on urban roadways where the posted speed is 45 mph or less, and where;

- The delineator is being used to maintain lane position,
- The delineator is being used to restrict vehicle movements,
- The delineator is subject to being frequently hit.

An Express Lane Marker is similar to a high performance delineator except for the height and speed application. Express Lane Markers may be used on projects where it is not feasible to provide a physical barrier between managed and general use lanes. The [Express Lanes Handbook](#) published by the Systems Planning Office provides additional guidance on the use of Express Lane Markers.

The particular type of object marker or delineator must be identified in the plans by the use of the pay item.

Modification for Non-Conventional Projects:

Delete the last sentence and replace with the following:

The particular type of object marker or delineator must be identified in the plans.

7.2.9 Roadside Flashing Beacon Assembly

Flashing beacon signs may be supported on single or double sign post configurations.

Refer to *Design Standards, Index 11862* for additional information.

7.2.10 Internally Illuminated Street Name Signs

Do not exceed 9 feet in width for an internally illuminated street name sign. For span wire systems, the sign must be mounted to the strain poles. On mast arm supports, the sign may be mounted to the support or to the arm. When mounted to the arm, the distance between the upright and the near side edge of the sign will not be greater than 10 feet.

The design of the street name sign must be in accordance with **Traffic Engineering Manual, Section 2.2**. Utilize the following text attributes in descending order of preference:

- 10-inch upper case with 8-inch lower case, Type EM font
- 10-inch upper case with 8-inch lower case, Type E font
- 8-inch upper case with 6-inch lower case, Type EM font
- 8-inch upper case with 6-inch lower case, Type E font

7.2.11 Exit Ramp Intersections

The standard for signing and pavement marking at exit ramp intersections is illustrated in **Figures 7.2.1** “Diamond Interchange Exit Ramp” and **7.2.2** “Partial Cloverleaf/Trumpet Interchange Exit Ramp” and described as follows:

1. Include MUTCD “optional” signs; second DO NOT ENTER, second WRONG WAY sign, and ONE WAY signs.
2. Include NO RIGHT TURN and NO LEFT TURN signs.
3. Use 3.5 feet by 2.5 feet WRONG WAY signs mounted at 4-foot height and include a retroreflective strip on sign supports.
4. Include 2-4 dotted guide line striping for left turns between ramps entrances/exits and cross-streets.
5. Include retroreflective yellow paint on ramp median nose where applicable.
6. Include a straight arrow and route interstate shield pavement marking in left-turn lanes extending from the far-side ramp intersection through the near-side ramp intersection to prevent premature left turns. Refer to **Traffic Engineering Manual (TEM)**, Section 4.2.4 “Route Shields for Wrong Way Treatment” for additional information.
7. Include a straight arrow and ONLY pavement message in outside lane approaching the ramp exit.

Figure 7.2.1 Typical Layout for Diamond Interchange Exit Ramp

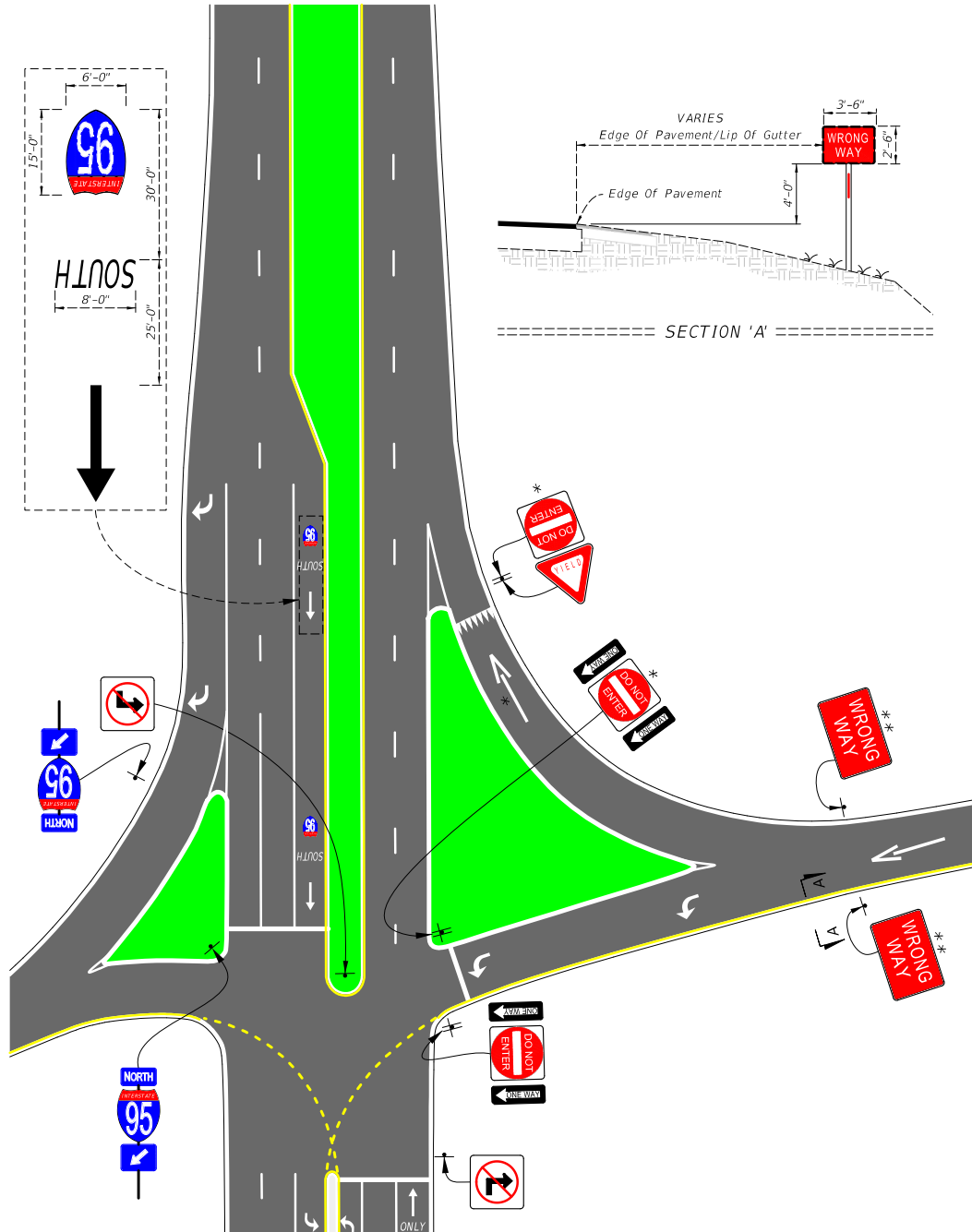

*Include if connecting road is undivided; i.e. traversable median.

**Mount sign 4 feet above edge of pavement and include retroreflective strip.

Figure 7.2.2 Typical Layout for Partial Cloverleaf/Trumpet Exit Ramp

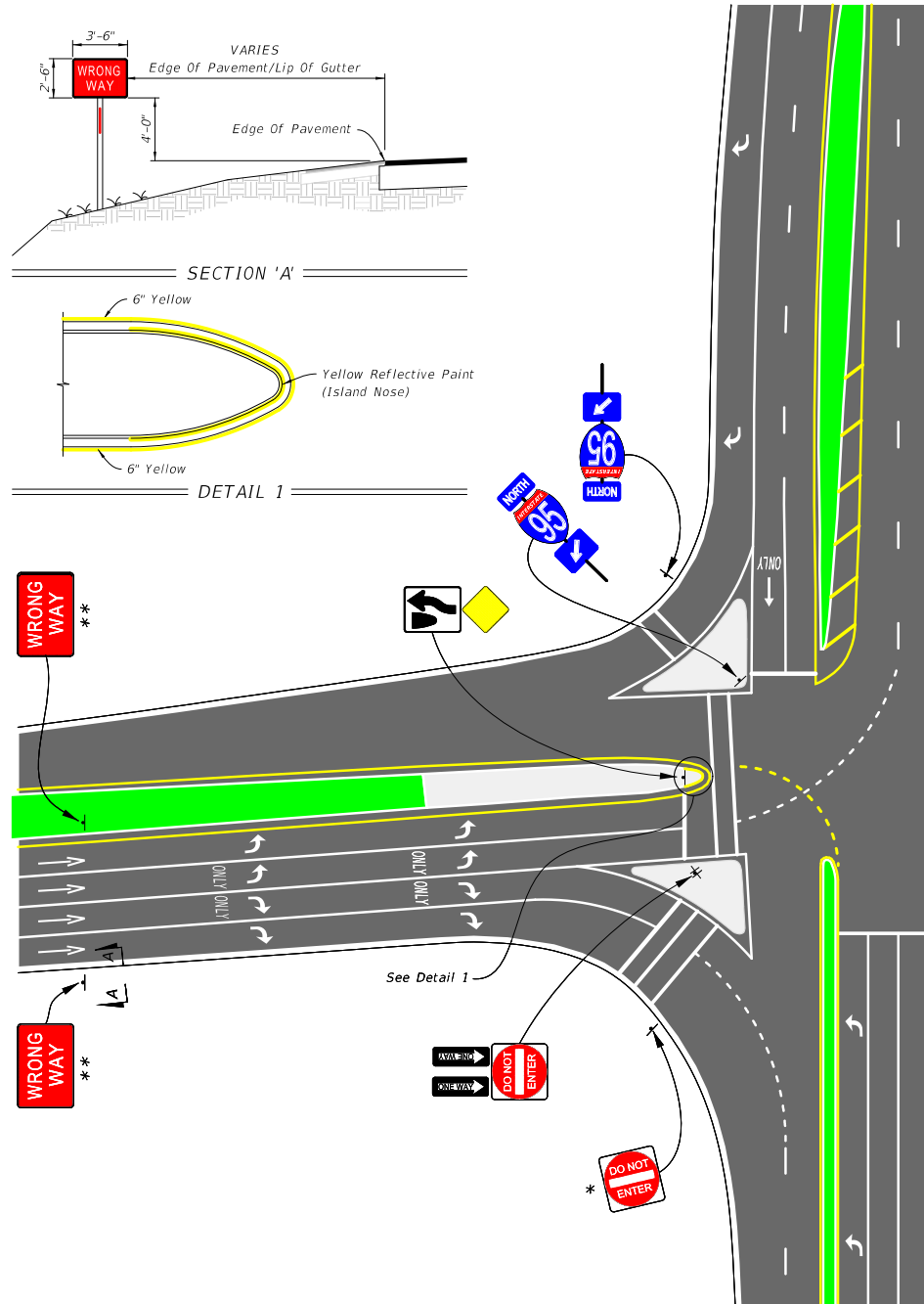

*Include if connecting road is undivided; i.e. traversable median.

**Mount sign 4 feet above edge of pavement and include retroreflective strip.

7.3 Lighting

7.3.1 Design Criteria

Use the illuminance method for all lighting design. The design values for light levels given by the **AASHTO Roadway Lighting Design Guide** are maintained values. These maintained values have been adjusted for Department assigned light loss and maintenance factors and are provided in **Tables 7.3.1 - 7.3.7** as required light level criteria.

The **AASHTO Roadway Lighting Design Guide** permits either the illuminance technique or the luminance technique to be used in the design of highway lighting. The luminance technique requires a complex design process and knowledge of the reflective characteristics of the pavement surface used. These reflective characteristics change as the pavement ages and with variations in weather conditions. It is for these reasons that the luminance technique is not allowed.

Mounting height (M.H.) for conventional lighting is the vertical distance from the roadway surface at the edge of the travel lane to the light source, regardless of lateral placement of the pole. Pole setback is the horizontal distance from the edge of the travel lane to the pole.

Do not tilt cobra head type fixtures. Pole top mounted fixtures may be tilted up to 5 degree for roadway lighting projects. Pole top mounted fixtures may be tilted in excess of 5 degrees when used at weight stations, agricultural stations and rest areas.

All lights not bridge or barrier wall mounted and installed within the clear zone, must be breakaway or shielded by an approved barrier. Refer to **Chapter 4** of this Volume for additional information on roadside safety design.

7.3.2 Design Methodology

Use the polygon method for all photometric calculations. Establish illumination points within the polygon at 15 foot intervals longitudinally and 5 foot intervals transversely along the roadway for roadway segments. Establish illumination points within the polygon at 5 foot intervals longitudinally and 5 foot transversely along the roadway for signalized intersections.

Refer to [RCI Features & Characteristics Handbook](#), Urban Classification – Feature 124 for additional information concerning urban designations Urban 1 through Urban 5.

7.3.2.1 Analysis Zones

Establish independent analysis zones for each signalized intersection and for each roadway segment between signalized intersections. Roadway segments and signalized intersection segments are to meet the criteria shown in **Table 7.3.1**. New or reconstructed signalized intersections located in Urban 3 or larger designated areas are to meet the criteria in **Table 7.3.3**.

Analyze signalized intersection segments using one analysis zone bounded by the back of sidewalks and the signalized intersection stop bars on each approach.

The termini for each roadway segment will be either the lighting project limits or the signalized intersection stop bars. The boundary of each roadway segment is described as follows:

Flush Shoulder Facilities:

1. Analyze divided roadway segments with grassed medians using two analysis zones; i.e. one for each direction of travel. Each zone will be bounded by the outside and median shoulder points.
2. Analyze multi-lane undivided roadway segments using two analysis zones; i.e. one for each direction of travel. Each zone will be bounded by the outside shoulder point and the centerline of the roadway.
3. Analyze two and three lane roadway segments as one analysis zone bounded by the outside shoulder points.

Curb and Gutter Facilities:

1. Analyze divided roadway segments with grassed medians using two analysis zones; i.e. one for each direction of travel. Each zone will be bounded by the back of sidewalk and the back of the median curb and gutter.
2. Analyze multi-lane undivided roadway segments, including roadways with two-way left turn lane, using two analysis zones; i.e. one for each direction of travel. Each zone will be bounded by the back of sidewalk and the centerline of the roadway.

Freeway Facilities:

Establish independent analysis zones for the mainline roadway segments, ramp segments and crossroad segments at interchanges. Freeway segments are to meet the criteria in **Table 7.3.2**.

The termini for each freeway mainline segment will be the lighting project limits. Logical termini for the other freeway segments will be determined by the designer. The boundary of each freeway segment is described as follows:

1. Analyze divided mainline roadway with grassed median using two analysis zones, one for each direction of travel; i.e. one zone for each direction of travel. Each zone will be bounded by the outside and median shoulder points.
2. Analyze barrier separated mainline roadway as one analysis zone bounded by the outside shoulder points of each direction of travel.
3. Analyze each ramp segment as one analysis zone bounded by the shoulder points. For interchange lighting where there is no continuous freeway lighting, the average illuminance criteria must be maintained to the end of the ramp tapers.
4. Analyze crossroad segments based on the criteria given above for flush shoulder or curb and gutter facilities.

7.3.2.2 Analysis for Pedestrian Lighting at Signalized Intersections

Pedestrian lighting criteria in **Table 7.3.3** applies to new or reconstructed signalized intersections located within Urban 3 or larger designated areas.

Vertical illuminance is the primary design value to be used to measure pedestrian visibility. Research has determined that visibility of pedestrians in crosswalks at intersections is a function of:

- the background illuminance,
- luminaire location in relation to the approach vehicle,
- luminaire mounting height,
- the distance from the luminaire to the crosswalk, and
- the photometrics of the luminaire.

The vertical illuminance calculation method to be used at intersections will be the variable light meter aimed toward the driver's location. This calculation will provide the vertical illumination level of a pedestrian which the driver sees approaching the crosswalk. This type of vertical illumination calculation is outlined in the *IESNA Design Guide for Roundabout Lighting (DG-19-08)*. When performing this calculation, the driver's location

from the crosswalk must be established. Use the stopping sight distance for the nearside approach based on the posted speed of the near approach roadway. Use the stopping sight distance for the turning movement approaches based on the operating speed for each specific turning radius.

The vertical illuminance must be calculated for three movements for each intersection approach. The first is the thru movement and the near side crosswalk; the second is the right turn movement and crosswalk on the adjacent side street; and the third is the left turn movement and the crosswalk on the side street. **Figures 7.3.1 through 7.3.3** indicate each of these three movements and the corresponding crosswalk area that must be analyzed. The vertical illuminance grid points are to be on a line centered in the crosswalk with a horizontal point spacing of 1.65 feet at a height of 5 feet above the pavement. The grid points are oriented toward the approaching driver, which is different from the vertical grids for sidewalks where the grids are parallel to the main pedestrian flow.

Many of the design features of existing intersections limit the placement of lighting fixtures to meet the vertical illumination requirements of an intersection approach. Therefore, the criteria in **Table 7.3.3** will apply only to approaches where the placement of lighting fixtures can be accomplished without modification of the intersection design.

Figure 7.3.1 Vertical Illuminance Calculation for Near Side Movement

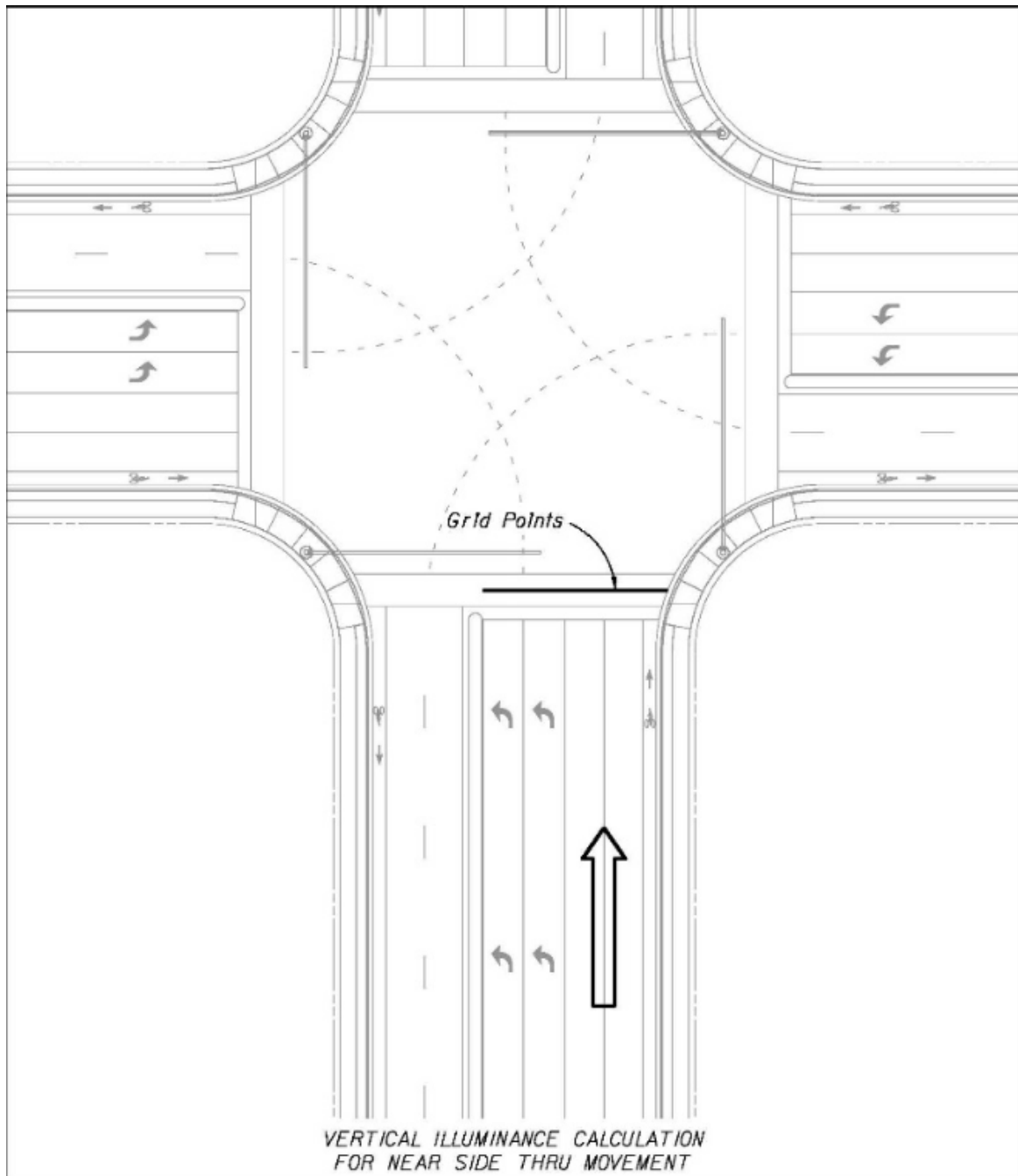

Figure 7.3.2 Vertical Illuminance Calculation for Right Turn Approach

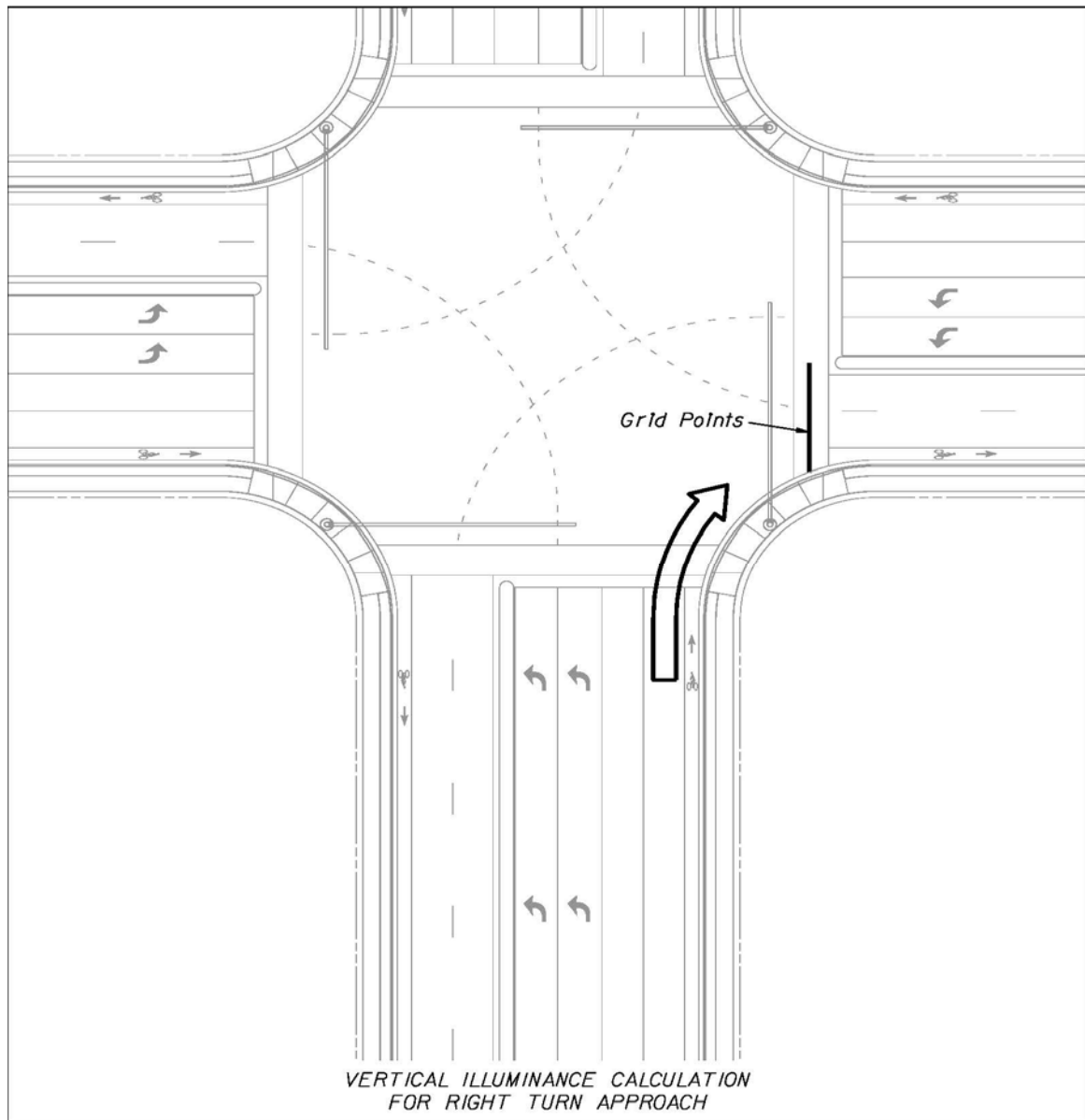

Figure 7.3.3 Vertical Illuminance Calculation for Left Turn Approach

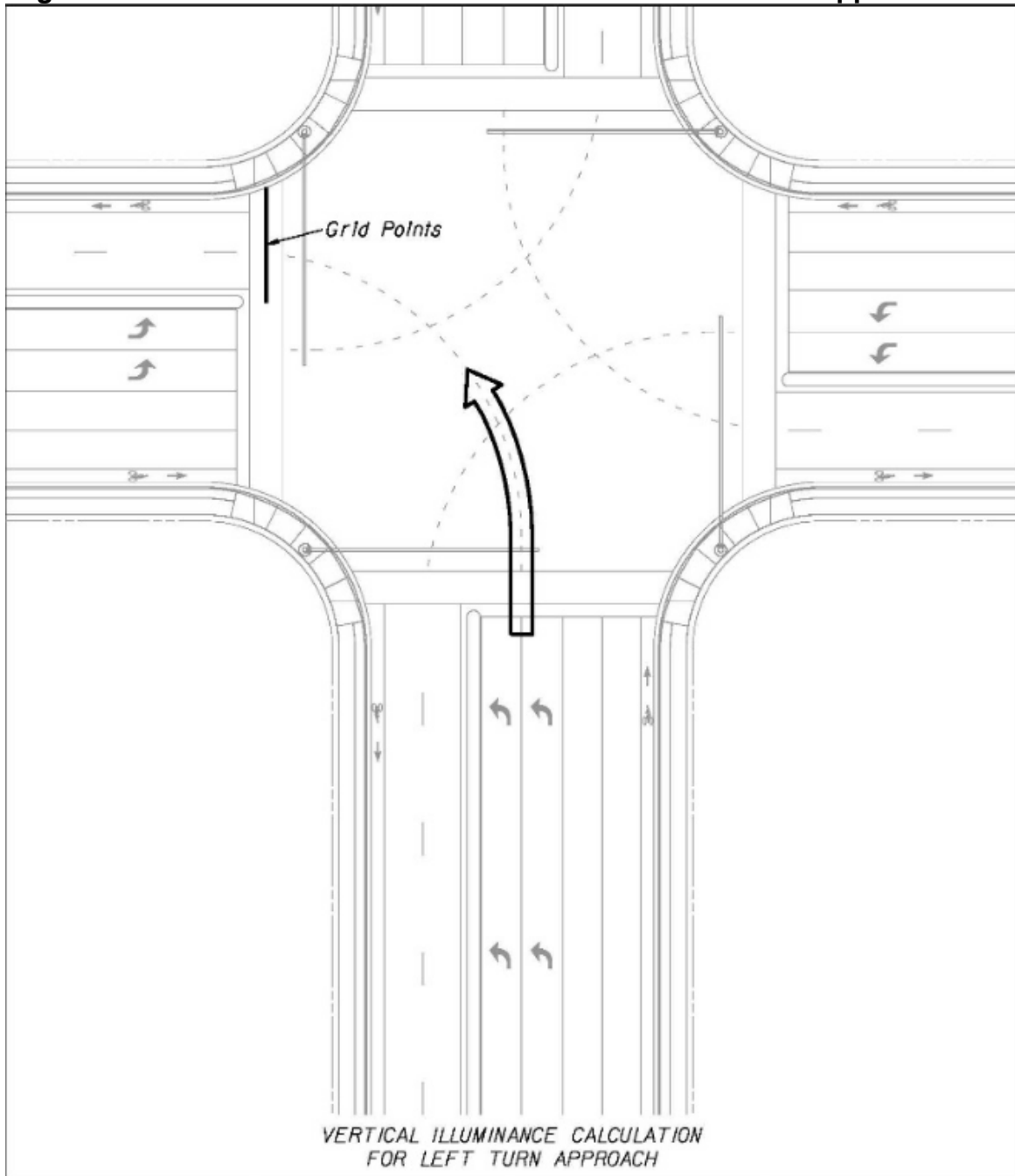
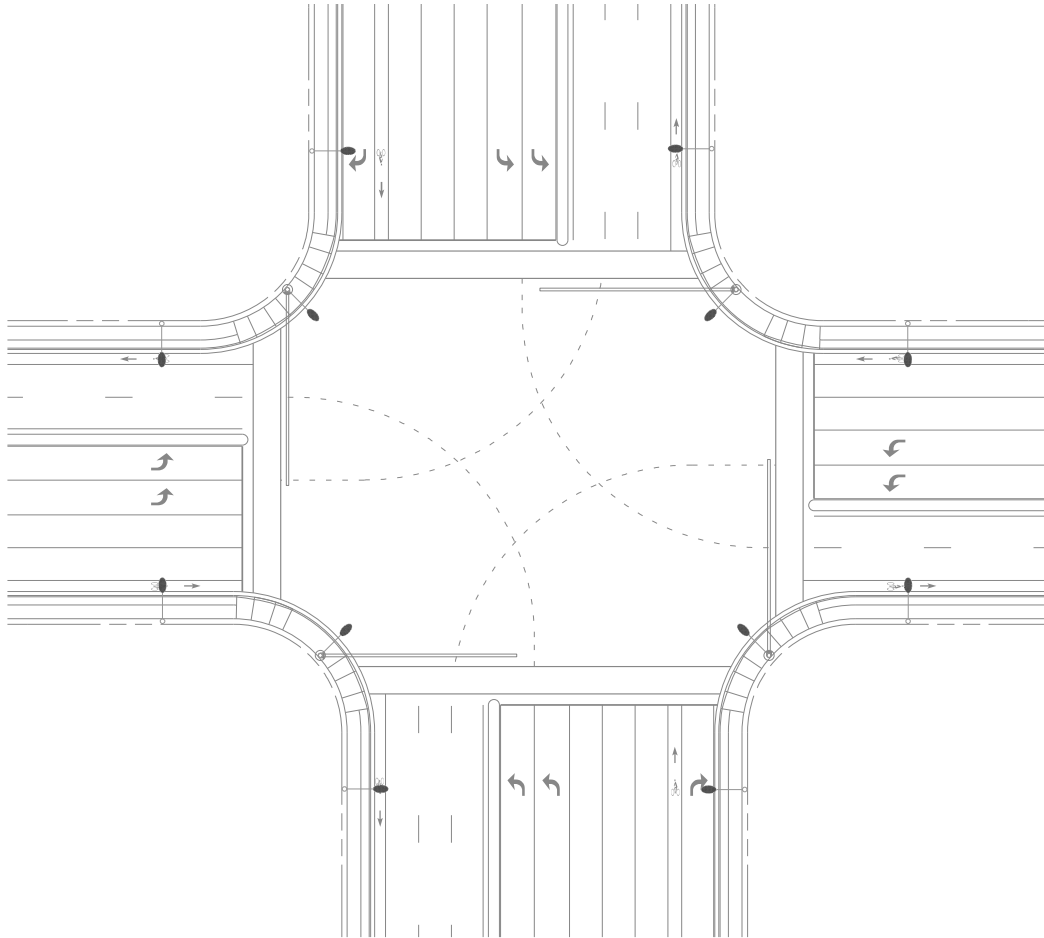

Figure 7.3.4 shows the typical lighting layout for a large intersection. The crosswalk and luminaire locations must be coordinated to optimize the vertical illumination level.

Figure 7.3.4 Typical Lighting Layout for Large Intersection



7.3.2.3 Analysis of Roundabouts

The criteria in **Table 7.3.3** will apply to all roundabouts where pedestrian features are provided. Calculate the vertical illuminance for the crosswalk on each near side approach and for each right turn movement in accordance with the methodology outlined in **Section 7.3.2.2**.

7.3.2.4 Analysis of Midblock Crosswalks

The criteria in **Table 7.3.4** will apply to all midblock crosswalks. Calculate the vertical illuminance for the crosswalk on each near side approach in accordance with the methodology outlined in **Section 7.3.2.2**.

Table 7.3.1 Conventional Lighting – Roadways and Signalized Intersections

ROADWAY CLASSIFICATIONS	ILLUMINATION LEVEL AVERAGE INITIAL HORIZONTAL FOOT CANDLE (H.F.C.)	ILLUMINATION UNIFORMITY RATIOS		VEILING LUMINANCE RATIO
		AVG./MIN.	MAX./MIN.	Lv(max)/Lavg
INTERSTATE, EXPRESSWAY, FREEWAY & MAJOR ARTERIALS	1.5	4:1 or Less	10:1 or Less	0.3:1 or Less
ALL OTHER ROADWAYS	1.0	4:1 or Less	10:1 or Less	0.3:1 or Less
*SIDEWALKS AND SHARED USED PATHS	2.5	4:1 or Less	10:1 or Less	-----

Note: * These values are intended for facilities separate from the roadway. Use illumination levels of the roadway for facilities within the range of the proposed or existing light poles.

Table 7.3.2 High Mast Lighting - Roadways

ROADWAY CLASSIFICATIONS	ILLUMINATION LEVEL AVERAGE INITIAL (H.F.C.)	ILLUMINATION UNIFORMITY RATIOS	
		AVG./MIN.	MAX./MIN.
INTERSTATE, EXPRESSWAY, FREEWAY & MAJOR ARTERIALS	0.8 to 1.0	3:1 or Less	10:1 or Less
ALL OTHER ROADWAYS	0.8 to 1.0	3:1 or Less	10:1 or Less

**Table 7.3.3 Signalized Intersection Lighting
 Urban 3 to Urban 5 Designated Areas***

ROADWAY CLASSIFICATIONS	ILLUMINATION LEVEL AVERAGE INITIAL FOOT CANDLE		ILLUMINATION UNIFORMITY RATIOS		VEILING LUMINANCE RATIO
			AVG./MIN.	MAX./MIN.	L _v (max)/L _{avg}
MAJOR ARTERIALS	Horizontal (H.F.C.)	3.0	4:1 or Less	10:1 or Less	0.3:1 or Less
	Vertical (V.F.C.)	2.3**	N.A.	N.A.	N.A.

Notes: * Urban 3 to Urban 5 Designated Area are defined in the [RCI Features & Characteristics Handbook](#), Urban Classification – Feature 124, Urban Size

** Vertical illumination value is only valid for new projects or where the intersection is being reconstructed. The vertical illumination is a target value and may not be achievable for all traffic movements.

Table 7.3.4 Midblock Crosswalk Lighting

AMBIENT LUMINANCE	VERTICAL ILLUMINATION LEVEL AVERAGE INITIAL FOOT CANDLE (V.F.C.)
LOW	2.3
MEDIUM & HIGH	3.0

Table 7.3.5 Sign Lighting

AMBIENT LUMINANCE	ILLUMINATION LEVEL AVERAGE INITIAL (H.F.C.)	ILLUMINATION UNIFORMITY RATIOS	
		MAX./MIN.	
LOW	15 - 20	6:1	
MEDIUM & HIGH	25 - 35	6:1	

Table 7.3.6 Underdeck Lighting - Roadways

LUMINAIRE TYPE	LIGHT SOURCE	MOUNTING LOCATION
PIER CAP	150 watt to 250 watt HPS	Pier or Pier Cap

Notes:

1. The light levels for underdeck lighting should be equal to the adjacent roadway lighting.
2. The only luminaire to be used for underdeck lighting is a wall mount fixture.

Table 7.3.7 Rest Area Lighting

AREA ILLUMINATED	ILLUMINATION LEVEL AVERAGE INITIAL (H.F.C.)	ILLUMINATION UNIFORMITY RATIOS	
		AVG./MIN.	MAX./MIN.
ENTRANCE & EXIT	1.5	4:1 or Less	10:1 or Less
INTERIOR ROADWAYS	1.5	4:1 or Less	10:1 or Less
PARKING AREAS	1.5	4:1 or Less	10:1 or Less

7.3.3 Lighting Justification

Lighting benefits motorists by improving their ability to see roadway geometry and other vehicles at extended distances ahead. This results in greater driver confidence and improved safety, particularly in inclement weather.

The procedure for roadway lighting justification is found in Chapter 14 of the [MUTS](#).

All interchanges on the interstate highway system are to be lighted to assure consistency and to meet driver expectations. A warrant analysis will be required but will not be used as the determining factor for the installation of lighting at these interchanges.

7.3.4 Lighting Project Coordination

Coordination with other offices and agencies is a very important aspect of project design. The offices discussed in this section are normally involved in lighting projects, however, there may be others.

Roadway Design - Typically the designer of a lighting project receives the base sheets for lighting design and any required cross sections from the roadway designer. Base sheets may be created from existing plans when the lighting project is not part of an active roadway design project.

Utilities - The District Utilities Engineer provides the coordination between the designer and the various utilities that may be involved in the project. The Utilities Section may assist in identifying or verifying conflicts with overhead and underground utilities.

The Utilities Engineer should be contacted as soon as pole locations are set and the electrical load has been determined. The designer should coordinate with the utility company providing power on the preferred location for the electrical service.

Drainage - Coordinate with the Drainage Section to assure that high water tables, stormwater retention areas, or other water bodies will not be a problem with the proposed location of light poles and the light pole pull boxes.

Structures Design - Standard foundation design for conventional and high mast light poles are provided in the *Design Standards*. A foundation design is only required in special cases. The Engineer of Record for Structures Design determines the foundation

design for high mast poles based on soil information. The Engineer of Record should be contacted early in the design phase to allow adequate time for coordination with the Geotechnical Engineer in obtaining soil borings.

Coordinate locations and attachments of lights and conduits on bridge structures with the bridge structural designer. Include light and conduit locations, and attachment details in the plans. Refer to **Structures Design Guidelines, Section 1.9** for details and restrictions related to bridge attachments.

Typically, the District Traffic Operations Engineer in conjunction with the District Utilities Engineer obtains the required maintenance agreements. The designer should coordinate with these offices to ensure that this activity is either underway or scheduled.

Any lighting project, especially high mast, adjacent to or in the vicinity of an airport, may present a potential problem. Coordinate with the District Aviation Coordinator when a project is within 5 miles of an airport.

Modification for Non-Conventional Projects:

Delete **PPM 7.3.4** and replace with the following:

7.3.4 Lighting Project Coordination

The Lighting Engineer of Record is responsible for all necessary coordination.

7.3.5 Voltage Drop Criteria

When determining conductor sizes for lighting circuits, the maximum allowable voltage drop from the service point on any one circuit is 7%.

7.3.6 Existing Lighting During Construction

The maintenance of existing lighting will be the responsibility of the contractor only if the lighting is affected by the construction. The contractor should not be expected to replace lamps and pole knockdowns or to repair wiring if these problems are not caused by the

construction work. As an example, a milling and resurfacing project should have no effect on the roadway lighting and the contractor should not be responsible for the maintenance of the lighting system.

The plans must specify the scope of the contractor's responsibility for the maintenance of existing lighting.

7.3.7 Grounding

The grounding requirements for lighting systems, as shown in the *Design Standards* are as follows:

1. Install 20' of ground rod at each conventional height light pole and at each pull box.
2. Install 40' of ground rod at each electrical service point.
3. At each high mast pole, install an array of 6 ground rods 20' in length, as shown in the *Design Standards, Index 17502*.

The above lengths of ground rod will be installed at each pole, pull box and service point, and the cost will be incidental to the unit or assembly being installed.

7.4 Traffic Signals

7.4.1 Design Criteria

The lateral offset requirements for signal poles and controller cabinets are given in **Chapter 4** of this Volume. Final location of these devices must be based on the safety of the motorist, visibility of the signal heads, ADA requirements, and access by maintenance.

The criteria in the following sections supplement the *MUTCD*.

7.4.2 Certification and Specialty Items

Traffic control signals and devices installed in Florida are required to be certified by the Department. The Traffic Engineering and Operations Office in the Central Office is charged with the responsibility of certifying traffic control equipment. If requiring new equipment types or types not typically used, contact Central Office Traffic Engineering to determine the certification status of the equipment. Noncertified equipment cannot be used.

7.4.3 Stop Line Location

A stop line that is not properly located invites violation by the motorist. The *MUTCD* specifies the minimum and maximum distances from the signal head to the stop line for adequate visibility. The traffic signal designer must ensure that this requirement is met.

Instead of relocating the signal heads, the stop lines at many intersections have been moved from their proper location to comply with these requirements. The tendency for the motorist is not to stop at the new stop line location, but rather to creep beyond the stop line. This could in some cases result in valid calls being dropped, thereby increasing delay and decreasing the overall efficiency of the intersection.

7.4.4 Controller Assemblies

Controller Timings: The development of controller timings is a basic part of traffic signal design. A recent ruling from the Board of Professional Engineers stated that the development of timings is considered engineering and therefore requires the signature and seal of a professional engineer.

All traffic signal designs on state and local roadways must include initial timings of all controllers in the plans set. If the timings provided in the plans are not implemented, it will be the responsibility of the agency providing the timings to insure they were prepared under the supervision of a professional engineer.

Future Intersection Expansion: Any planned intersection improvements, should be considered in the signal design. The controller type, cabinet type and the number of load switches are examples of design features that may be affected by future intersection improvements. It is the responsibility of the signal design engineer to determine if the current design should include capabilities for future improvements.

Upgrade of Existing Controller Assemblies: For projects requiring an upgrade to an existing controller assembly, the assembly may either be expanded or replaced. Minor expansions include the addition of load switches, new controller timings, and/or new controller unit if the cabinet is properly wired. These may be made in the field; therefore, expansion is the logical choice. On the other hand, major expansions include cabinet rewiring or any work requiring the removal of the cabinet back panel. Major expansions in the field will not be allowed and replacement of the assembly is required. Contact the District Traffic Operations Engineer before making the decision to expand or replace an existing controller assembly.

Modification for Non-Conventional Projects:

Delete the last sentence of the above paragraph and see RFP for controller modification requirements.

7.4.5 Left Turn Treatments

The guidelines given below should be followed when determining signal treatments for left turns.

1. Single Turn Lane
 - a. Protected/Permissive Phasing

Option #1: A five-section cluster or a separate turn signal head may be used for this location. If a separate turn signal head is used, it should be positioned over the center of the left turn lane. If a five-section cluster is used, it should be installed over the lane line between the left turn lane and through lane. The five-section cluster can serve as one of the two indications required for the through traffic.

Option #2: A flashing yellow arrow signal indication may be used. A flashing yellow arrow must use a separate four section head positioned over the center of the left turn lane.

- b. Protected Phasing - A separate signal head for the left turn lane with red, yellow and green arrow indications should be positioned over the center of the left turn lane.
2. Dual Turn Lanes – Use only protected phasing; i.e. permissive movements will not be allowed. A single three-section head with red, yellow, and green arrow indications should be centered over each turn lane. These heads are in addition to the dual indications required for the thru movement.
3. Separated Turn and Thru Lanes – For signal operation guidelines for separated left turn and thru lanes, see [Section 3.2 of the Traffic Engineering Manual](#).
4. Single Lane Approach on Stem of "T" – Two three-section heads are required as minimum.
5. Two Approach Lanes on Stem of "T"

Option #1: The approach may display two three-section heads with circular indications on all sections.

Option #2: The approach may display a five-section cluster in conjunction with a three-section head. If the lanes are exclusive left and right turn lanes, then the five-section cluster should be placed over the center of the lane line and the three-section head over the major movement lane. If one of the lanes is a shared left and right lane, then the five-section cluster should be placed over the center of this lane and the three-section head over the center of the other lane.

Option #3: The approach may display two three-section heads for the major movement and a single three-section head for the secondary movement.

6. Three Approach lanes on Stem of "T"

Option #1: The approach may display two three-section heads for the major movement and one for the secondary movement (Exclusive left and right turn lanes).

Option #2: The approach may display a five-section cluster in conjunction with three-section head (exclusive left and right turn lanes). The five-section cluster should be placed over the center of the lane line separating the left turn lane(s)

from the right turn lane(s). The three-section head should be placed over the other lane line to provide dual indication for the major movement.

Option #3: When the middle lane is a shared left and right turn lane, then a five-section cluster should be placed over the center of this lane and a three-section head placed over each of the other two lanes. Each head must contain green and yellow arrow indications in this situation.

Modification for Non-Conventional Projects:

Add the following sentence:

7. Coordinate requirements with the local maintaining agency.

NOTE:

1. For all cases, the approach must display "dual indications". This means that there will be at least two heads with identical indications on the major approach. For example, if a green arrow is displayed on one head of the major movement or approach then a green arrow must be displayed on the second head.
2. The same signal display option should be used throughout an urban area to provide consistency in display to the motorist.
3. The use of advance and/or overhead lane use signs should be used as a supplement to pavement arrows on stems of signalized "T" intersections.

7.4.6 Signal Preemption

Check each intersection to determine if there is a requirement for signal preemption. Refer to [Department Procedure 750-030-002](#) for information on the conditions for which preemption is required, or should be considered.

Modification for Non-Conventional Projects:

Delete **PPM** 7.4.6 and coordinate requirements with the local maintaining agency.

7.4.7 Intersection Design - Lane Configuration

The engineer responsible for the traffic signal design may be asked to verify the number and configuration of traffic lanes required for an intersection to function properly when signalized. For this calculation use the Design Hourly Volume (DHV) based on the Department's Standard K factor and not a peak to daily (P/D) ratio based on a 24-hour count.

The K, D, and T factors convert the two-way AADT volumes to a one-way Design Hourly Volume. This is appropriate for the total approach movements. The AM and PM peak turning movement counts on each approach should be addressed individually. Current turning movement counts should be taken to determine the percentage of turns for each approach. These percentages should then be applied to the DHV for each approach volume to determine the turning volumes that should be used for the turn lane design calculations. These values should be compared to the movement counts supplied by Planning and the greater of the two values used for the design of turn lanes. The District Planning Office should be contacted to determine if recent counts are available and also if any use changes are planned which would require adjustments to the turn percentages found in the current counts.

Storage lanes for left turns can affect the capacity and safety of intersections. The storage length of a left turn lane is a critical design element. The queue of left turn vehicles in a storage lane of inadequate length may extend into the through lanes. The result is loss of capacity for the through lanes. The queue of through vehicles may also extend beyond the entrance of a short left turn storage lane, blocking access to the storage lane. Either case results in a less efficient operation of the intersection and may cause last minute lane changes, thereby increasing the possibility of conflicts.

Turn lanes should comply with the ***Design Standards, Index 301***. The available queue length provided should be based on a traffic study.

The important factors that determine the length needed for a left turn storage lane are:

1. The design year volume for the peak hour (see discussion above).
2. An estimate for the number of cycles per hour.

NOTE: If the cycle length increases, the length of the storage for the same traffic also increases.

3. The signal phasing and timing.

There are several techniques used to determine necessary storage length. The following are suggested guidelines for left turn lanes.

1. Where protected left turn phasing is provided, an exclusive turn lane should be provided.
2. Left turn lanes should be provided when turn volumes exceed 100 vehicles per hour (VPH) and may be considered for lesser volumes if space permits.
3. For signalized intersections, the following formula may be used, assuming an average vehicle length of 25 feet.

$$Q = \frac{(2.0)(DHV)(25)}{N}$$

Where:

- Q = design length for left turn storage in ft.
- DHV = left turn volume during design peak hour, in VPH.
- N = number of cycles per hour for peak hour, use N = 30 as default.

Note: Computer programs, such as **TRANSYT-7F**, are used to develop signal phasing and timing. One of the outputs of these programs is the queue length. For projects where traffic signal timing is included as a part of the project, the output of these programs should be considered in determining storage length.

4. Where left turn volumes exceed 300 vph, a double left turn should be considered.
5. When right of way has already been purchased, and the designer has to choose between a long wide grass median or a long left turn lane, the storage length for the left turn should be as long as practical without hindering other access.

Right turn lanes are provided for many of the same reasons as left turn lanes. Right turns are, however, generally made more efficiently than left turns. Right turn storage lanes should be considered when right turn volume exceeds 300 vph and the adjacent through volume also exceeds 300 vehicles per hour per lane (vphpl). The introduction of right turn lanes can impact pedestrian crossing distances at signalized intersections; therefore, additional analysis may be required to weigh the impacts of increased pavement width and signal operations.

7.4.8 Signal Loops

Traffic signal loops are detailed in the *Design Standards, Index 17781* and are suitable for most locations.

The traffic signal design for each intersection must include the requirement for type and placement of loops. *Design Standards, Index 17781* allows for minor modifications in size and placement of the loops. These modifications are used only when required by site conditions for a particular location.

7.4.9 Grounding and Electrical Bonding

The grounding requirements for traffic signal components, as shown in the Design Standards, are as follows:

1. Install 20' of ground rod at each signal pole, mast arm, pedestrian signal, etc. and at each pull box.
2. Install 40' of ground rod at each electrical service and controller cabinet.

The above lengths of ground rod will be installed at each component, and the cost will be incidental to the unit or assembly being installed.

Design Standards, Index 17736 requires a bond wire connecting all poles, controllers, mast arms and pedestrian signal pedestals. This conductor is incidental to the cost of the signal installation.

7.4.10 Mast Arm Supports

Meet the following criteria for new signals installed on the State Highway System:

1. Intersections within the ten mile coastline boundary, as defined by the State Traffic Engineering Office Implementation Guidelines (aka mast arm policy area):
Signals must be supported by galvanized mast arms, with the signal head(s) rigidly attached to the mast arm, along corridors within the ten mile coastline boundary. When it is impractical to use a mast arm or overhead rigid structure within the ten mile coastline boundary, a two point span wire assembly with adjustable hangers must be used and a Design Variation must be approved in accordance with *Chapter 23* of this

Volume. The Department will cover the cost for a galvanized mast arm only. If the Local Maintaining Agency wants a painted mast arm, they must provide the additional funding and commit to cover the maintenance cost.

Modification for Non-Conventional Projects:

Delete the last three sentences of the above paragraph and see RFP for requirements.

2. Signalized Intersections outside the ten mile coastline boundary:

Signals along all corridors outside the ten mile coastline boundary must be supported by two point span wire assembly with adjustable hangers. If the Local Maintaining Agency prefers a mast arm, they must provide funding for the incremental increase in construction cost, and if the requested mast arm is to be painted, they must also commit to cover the maintenance costs.

Modification for Non-Conventional Projects:

Delete the last sentence of the above paragraph and see RFP for requirements.

Utilize an underground communication cable infrastructure for those signals operating as part of an advanced traffic management system on these designated corridors.

Orient mast arm signal structures approximately 90° to approach traffic; i.e. mast arms diagonal to traffic are not allowed.

Signs on mast arms will be restricted to required regulatory and street name signs.

7.4.11 Traffic Signal Project Coordination

Coordination with other offices and agencies is a very important aspect of project design. The offices discussed in this section are normally involved in signal projects, however there may be others.

Roadway Design – Typically, the designer of a signal project receives the base sheets for design and any required cross sections from the roadway designer. Base sheets may be created from existing plans when the signal project is not part of an active roadway design project.

Utilities - The District Utilities Engineer provides the coordination between the designer and the various utilities that may be involved in the project. The Utilities Section may assist in identifying or verifying conflicts with overhead and underground utilities.

The designer should coordinate with the utility company providing power on the preferred location for the electrical service.

Structures Design - The Engineer of Record for Structures Design provides the design of the traffic signal mast arms and strain poles, including the design of the foundation. The Engineer of Record should be contacted early in the design phase to allow adequate time for coordination with the Geotechnical Engineer in obtaining the necessary soils information.

Coordinate locations and attachments of traffic signals and conduits on bridge structures with the bridge structural designer. Include traffic signal and conduit locations and attachment details in the plans. Refer to **Structural Design Guidelines, Section 1.9** for details and restrictions related to bridge attachments.

Pedestrian and Bicycle Coordinator - The District Pedestrian/Bicycle Coordinator should be consulted to assure that all potential pedestrian and bicyclist concerns have been considered.

Modification for Non-Conventional Projects:

Delete **PPM 7.4.11** and replace with the following:

7.4.11 Traffic Signal Project Coordination

The Traffic Signal Engineer of Record is responsible for all necessary coordination.

7.4.12 LED Light Sources

The Light Emitting Diode (LED) is the standard light source for all signal indications.

7.4.13 Pedestrian Countdown Signal Applications

The countdown pedestrian signal is the standard head device on all projects that include pedestrian signal installations. Refer to *Traffic Engineering Manual, Section 3.9*, for criteria related to pedestrian signal installation and operation.

7.4.14 Number of Signal Heads for Through Lanes

Place a three-section head over the center of each lane for approaches of two or more lanes. When a single left turn lane is provided, a five-section cluster can serve as one of the indications required for the inside through lane.

7.4.15 Backplates

Install louvered backplates on all signal sections for all approaches. Retroreflective backplate borders are required for all backplates where the posted speed for the approach is 45 mph or greater. Retroreflective borders are recommended for all backplates where the posted speed for the approach is less than 45 mph.

7.4.16 Span Wire Assemblies

Use either perpendicular spans, box spans or drop box spans for all traffic signal span wire assemblies. Signs on span wires will be restricted to required regulatory signs.

Diagonal span assemblies may be used for flashing beacon installations. A Design Variation is required for any other diagonal installation. The Design Variation must be signed by both the District Design Engineer and the District Traffic Operations Engineer.

Modification for Non-Conventional Projects:

Delete the last two sentences of the above paragraph.

7.5 Intelligent Transportation System (ITS) Components

The plans preparation information provided in this section applies to the placement and installation of ITS devices and systems along Florida's roadways. Specifications for traffic control devices, including ITS device requirements as adopted by the Department are published by the State Program Management Office and are available online at the FDOT Web site. Plans involving ITS devices must also include provisions for grounding and surge suppression to protect equipment and to ensure human safety.

7.5.1 Design Criteria

ITS design criteria, in general, require that devices and systems be able to gather, analyze, and distribute accurate information to support the overall goal of improving the safety, efficiency, mobility, security, and integration of transportation systems. Designers must consider the strengths and limitations of various technologies for collecting, analyzing, and disseminating information, and select devices that are most appropriate for a specific application.

Many ITS devices have specific placement and configuration requirements that must be met for the equipment to perform properly. Designers must be familiar with the strengths and limitations of various devices and technologies prior to incorporating them into their designs. Other general considerations for ITS designs include promoting safety for road users, monitoring traffic and travel conditions, supporting traffic management operations, providing equipment access for maintenance personnel, and disseminating useful information to motorists.

If the project involves Intelligent Transportation Systems (ITS) technologies, requirements specified in FDOT Procedure (Topic Number: 750-040-003) must be followed. This is to ensure compliance with Code of Federal Regulations (CFR) Chapter 23 Part 940 Section 940.11, and Department requirements. Authorization of federal funds for construction or implementation of the project, and subsequent reimbursement of approved expenditures cannot proceed until after compliance with this procedure is demonstrated. Lateral offset requirements for poles, sign structures, field cabinets, and communication hubs for deployments must conform to those provided in **Chapter 4** of this Volume. Any deviation or alternative or special design must be coordinated with the District Design Engineer.

7.5.2 ITS Device Approval and Compatibility

ITS devices are traffic control devices and follow approval requirements discussed in **Section 7.4.2**.

Ensure that devices which share communications networks or provide related functions are compatible with each other and will not interfere with the operation of other devices or systems. Incorporate features and functions that allow interoperability with other ITS deployments throughout the region and state including existing Regional Transportation Management Center (TMC) hardware and software. Examples of general design characteristics that promote interoperability include:

1. Systems and products based on open architectures and standards.
2. Systems and products that are scalable and nonproprietary.
3. Compatibility with the Department's SunGuide® Software System directly or via support of one or more of its related Interface Control Documents (ICDs).

7.5.3 Required Information

The basic information necessary for ITS plans includes device placement (mounting height, attachment type, position along roadway) and installation requirements (including communication, cabinet details, and power), roadway geometrics, street names, construction stationing, milepost information or reference points, right of way lines, location of utilities, and presence of other roadside features such as vegetation, landscaping, or existing devices that may impact device locations in the field.

Requirements for a complete set of ITS project plans are found in **Chapter 29** of **Volume 2**.

7.5.4 Motorist Information Systems

7.5.4.1 Dynamic Message Sign (DMS)

DMS sign types include walk-in, front-access, or embedded with monochrome (typically amber text), full-color, or tri-color displays. Select the appropriate sign type based upon project-specific needs.

Design the DMS and support structure in accordance with **Chapter 29** of this Volume. The DMS should be centered over the roadway on mid- or full-span structures.

The DMS should be positioned to be legible from the roadway, taking into account the display characteristics of DMS technology (e.g., the vertical and horizontal viewing angles of the LED displays). Placement of a DMS installation should be determined by project-specific needs, as well as the following general design criteria:

1. The DMS design should take into account the message library proposed for use on the project, including text and graphics. Utilize DMS capable of displaying minimum character heights per the MUTCD, Section 2L.04.
2. Placement on freeways prior to interchanges that offer alternate routes.
 - a. In advance of 1-mile exit signing.
 - b. Maintain minimum 800-foot spacing between existing and planned overhead static sign panels and other signs, per the MUTCD. DMS should be installed on support structures without any static signage, except for changeable message elements. Consider increased spacing when conditions allow.
 - c. Maintain minimum of 1450-foot distance from decision points (meets MUTCD/AASHTO Green Book requirements).
 - d. In advance of interchanges where interstates meet to allow for advance messaging of traffic conditions on both roadways. Consider locations that are two exits before major interchanges as well as immediately prior to the interchange.
3. Placement on arterials prior to major intersections and interchanges.
 - a. At a distance approximately 1/4 to 1/2 mile in advance of major intersections and interchanges.
 - b. At a location at least 600 feet from adjacent signalized intersections.
 - c. At a location where the DMS is continuously visible to motorists for at least 600 feet.
 - d. At a location where no existing or planned guide signs exist within the 600-foot minimum visibility distance.
 - e. At a location with minimum interference from lighting, adjacent driveways, side streets, or commercial signage.
 - f. At locations where no historical neighborhoods exist.
4. Placement in advance of high crash locations and traffic bottlenecks.
5. At a location where sufficient space is available between the edge of travel lanes and the right of way limits. The space must be wide enough to allow the DMS structure to be located within the right of way limits, while meeting the minimum clear zone requirement.
6. At a location where no conflict with underground or overhead utilities exists.
7. Placement that accommodates access for service and maintenance.
8. Placement in advance of major system interchanges.

9. Placement along key commuter or evacuation corridors.
10. At a location downstream of rural interchanges in order to inform entering traffic of conditions ahead.

The sign housing must be mounted with a minimum vertical clearance height as specified in **Table 2.10.4**.

7.5.4.2 Highway Advisory Radio

A highway advisory radio (HAR) system design must include all the equipment necessary for the operator to record verbal messages from onsite or remote locations, and to continually broadcast live, prerecorded, or synthesized messages from roadside transmission sites. HAR designs must also include highway signs with remotely operated flashing beacons to notify motorists of HAR broadcasts.

Refer to the Federal Communications Commission (FCC) regulations in **CFR Title 47, Part 90.242** relating to the operation of travelers' information stations. Additional information on licensing issues, frequency allocation, and other specifics may be obtained by contacting the FDOT ITS Telecommunications Office.

Placement of a HAR installation should be determined by project-specific needs, as well as the following general design criteria:

1. Ability to transmit a meaningful message that can be received by motorists traveling through the broadcast zone.
2. Placement prior to freeway interchanges that offer alternate routes.
3. Placement in advance of high crash locations and traffic bottlenecks.
4. Placement that accommodates access for service and maintenance.
5. Placement along key commuter or evacuation corridors.
6. Placement of flashing beacon signs within the HAR coverage area prior to exit signs or DMS associated with an interchange.
7. Wood poles are often recommended by HAR manufacturers for antenna mounting to reduce interference that may occur with conductive poles. Check antenna requirements of proposed HAR manufacturers.

7.5.4.3 Road Weather Information System

Locate the environmental sensor station (ESS) associated with the road weather information system (RWIS) where its weather observations will be the most representative of the roadway segment of interest.

The poles or structures on which weather instruments are mounted are frequently installed within a range of 30 to 50 feet from the roadway's edge to avoid the effects of passing traffic (e.g., heat, wind, splash), yet still be able to detect the weather conditions affecting motorists there. The location of ESS poles, towers, or other structures must conform to the lateral offset requirements in **Chapter 4** of this Volume.

Avoid standing water or locations where billboards, surrounding trees or other vegetation would affect the weather measurements. Median placement of an ESS on a divided highway is generally not feasible unless the median is 100 feet or wider. For more siting criteria, refer to the [**FHWA's Road Weather Information System \(RWIS\) Environmental Sensor Station Siting Guidelines, Publication No. FHWA-HOP-05-026.**](#)

Consider the communication link the RWIS installation requires for transmitting the weather data. FDOT RWIS deployments commonly utilize Ethernet communications over a fiber optic network. Satellite-based data collection packages using standards for National Oceanic and Atmospheric Administration (NOAA) and certification standards version 2 (CS2) certification for Geostationary Operational Environmental Satellite (GOES) transmission have also been deployed as part of a statewide wind speed warning system. Use of satellite-based systems must be coordinated with the FDOT ITS Telecommunications Office.

7.5.5 Video Equipment

7.5.5.1 Closed-circuit Television Systems

Closed-circuit television (CCTV) systems consist of roadside cameras, communication devices, as well as camera control and video display equipment at one or more remote monitoring locations that allow surveillance of roadway and traffic conditions for traffic and incident management. Cameras are also required for visual confirmation of dynamic message signs and ramp signal operation, as well as security purposes.

CCTV device placement and overall system design should be determined by project-specific needs, as well as the following general design criteria:

1. A camera on the interstate should be located to obtain a complete view of roadway features including lanes, shoulders, ramps, emergency stopping sites, and accident investigation sites. Cameras at interchanges should be able to view arterial traffic.
2. Camera location should provide the ability to view any nearby DMS for message verification.
3. Camera location should provide the ability to view crossing features (e.g., streets, rail, bridges).
4. Lateral offset to camera structures must be in accordance with **Chapter 4** of this Volume.
5. Device placement should accommodate service and maintenance access with minimal impact on traffic. For example, the use of lowering devices to allow cameras to be lowered from the pole top to ground level for servicing with little or no disruption of traffic.

Coordinate the CCTV placement with other design features to assure a clear unobstructed view. Position the camera to reduce the risk that critical views will be blocked by the mounting structure.

Designs and plans must specify camera mounting height. Mounting height should be determined based upon project specific needs, as well as the following general design criteria:

1. Required viewing distance.
2. Roadway geometry and lane configuration.
3. Roadway classification (i.e., arterial or freeway).
4. Life-cycle cost, including maintenance impacts.
5. Environmental factors, such as glare from the horizon or from headlights.
6. Vertical clearance.

All camera housings, enclosures, lowering devices, and mounts must be designed to withstand sustained wind loads and gust factors according to **Chapter 29** of this Volume.

Refer to **Design Standards, Index 18111** or **Index 18113** for CCTV camera pole and foundation requirements.

7.5.5.2 Video Display Systems

Video display equipment is utilized in the TMC for viewing CCTV images and other information obtained from field locations. It is important to develop a video display system design plan that is based on a detailed, documented analysis of the control center room dimensions, the operator's console desk layout, various distances from the operator's seating position to the video wall display, and the viewing angles to the display wall at the proposed mounting height for the display supporting structure.

Consider any potential limitations introduced or imposed by existing facility construction that may hinder the installation of the video wall display. The video display components should be capable of being brought into the TMC control room and assembled in place without having to make modifications to existing doorways, walls, floors, or ceilings.

7.5.6 Network Devices

Network devices include a variety of Internet Protocol (IP)-addressable electronic equipment used for the collection and dissemination of video, traffic data, and other information. Coordinate with the local District's IT staff to obtain network specific requirement and information for communication network design. Network devices designed on a project must be compatible with existing network equipment currently in operation.

Due to the critical nature of the network equipment described below, the complexity of the electronics, and harsh environmental conditions at installation locations, designs utilizing network devices should facilitate immediate replacement of defective or damaged units with minimal system downtime.

Consideration should be given to designs that promote open architecture, non-proprietary systems, as well as survivability and reliability. Designers should consider solutions that provide immunity to single-point failure and implement redundant paths for reliability and survivability.

7.5.6.1 Managed Field Ethernet Switch

The managed field Ethernet switch (MFES) is an environmentally hardened field device that provides Ethernet connectivity from the remote ITS device installation location to the network trunk interconnection point. Consider distance limitations for common Ethernet media types when developing the design. Consider fiber optic connection to devices

outside the local cabinet if the design requires additional protection from transients or interference that may be induced on copper-based interconnects.

Provide an Ethernet port for the connection of each planned ITS field device along with spare capacity.

7.5.6.2 Device Server

The device server encapsulates serial data in network packets and transports the packets across IP networks. Designs generally include device servers when remote field devices must connect to an Ethernet network, yet only possess serial communication interfaces.

Equipment that may require the use of device servers include vehicle detection systems, RWIS stations, and other low-speed data output devices.

7.5.7 Fiber Optic Cable and Interconnect

The following sections describe the various fiber optic facilities that are used for device control and data communications between ITS field devices, TMCs, regional transportation management centers (RTMCs), and other identified stakeholder facilities. Designs that include network facilities must meet project-specific needs, as well as include the following information:

1. Facility diagrams illustrating facility routes.
2. General network topology.
3. Network diagrams, including communication hub details
4. External network connections and demarcation points

Include special provision **SP0071101-Tolls** in the contract documents when there are existing communication cables that transmit toll system information near areas where work is to be performed. This special provision expands requirements for preservation of property to specifically address repair of toll collection system components damaged by the contractor. The special provision also makes the contractor responsible for revenue loss that results from such damage.

7.5.7.1 Fiber Optic Cable

Fiber optic cable is utilized in FDOT's statewide network infrastructure to provide data and device control communications between TMCs, RTMCs, ITS devices, and other identified stakeholder facilities.

7.5.7.2 Fiber Optic Conduit

The type of fiber optic cable installation will determine the design for the conduit needed. For example, use polyvinyl chloride (PVC), fiberglass, or high-density polyethylene (HDPE) conduit for fiber optic cable that is exposed or placed underground along the roadway.

Indicate in the plans the innerduct type, size, and quantity when specific conduit is required. Proposed conduit systems should avoid chronic wet locations.

7.5.7.3 Fiber Optic Splices and Terminations

Fiber optic splices provide a continuous optical path for transmission of optical pulses from one length of optical fiber to another. Plans must identify splice points and provide splicing diagrams that detail the interconnection of specific fiber strands to be constructed, their origination and final destination points, and expected link loss.

Plans must identify existing fiber optic cables in the vicinity of the work and the location of the nearest full splices in the existing cables, including distance in each direction. This information is necessary to identify the cable(s) and splice(s) that would need to be reconstructed in the event they are damaged during construction. Damaged cables are replaced to the nearest existing full splices.

Fiber optic cables must be terminated using a fiber patch panel (FPP). The FPP allows connection of optical fibers to the electronic equipment and devices located throughout the network. Coordinate selection of connector types and other fiber optic system components with the local District ITS staff.

7.5.7.4 Fiber Optic Cable Designating System

The fiber optic cable designating system provides visual notification of the presence of

the underground fiber optic conduit/cable system, and provides a mechanism for electronically locating the physical presence of the conduit system below ground. The designating system provides a means to identify, locate, and protect the statewide fiber optic network between RTMCs, TMCs, ITS devices, and other facilities.

The designating system may consist of several components, including electronic markers, above-ground route markers, locate wire, access points, and buried cable warning tape.

The design and construction of the designating system should meet the following functional requirements based on project needs:

1. Provide visual notification of the presence of the conduit.
2. Inform the public of potential hazards and provide contact information for conduit system marking prior to planned excavation.
3. Provide an end-to-end electrical conductor (locate wire) attached to the conduit system for conductive facility locating.
4. Provide above-ground access to the locate wire.

7.5.7.5 Pull, Splice, and Junction Boxes

Provide access points using pull, splice, or junction boxes according to the type, size, and quantity necessary for the project. Consider the following minimum functional requirements for access points:

1. Provide at-grade access to fiber optic cables housed within conduit systems used for FDOT ITS communications.
2. Provide assist points to aid in fiber optic cable installation.
3. Provide protection for the fiber optic cable.
4. Provide adequate space for storing cable slack/coils and splice enclosures.
5. Make certain that pull boxes and splice boxes provide sufficient space for entry and routing of the fiber optic cables.

Place access points at the following locations:

1. All major fiber optic cable and conduit junctions.
2. At all planned or future splice locations.

3. Every 2,500 feet in a continuous straight conduit section if no fiber optic cable splice is required.
4. At a maximum of 1,000 to 1,500 feet in metropolitan areas.
5. On each side of a river or lake crossing and at each end of a tunnel.
6. On each side of an above-ground conduit installation (i.e., attachment to bridge or wall).
7. All turns in the conduit system.

Splice boxes are preferred for access points on fiber optic cable backbone routes. Access or fiber splices to existing fiber optic backbone cables must only be made at the nearest existing splice box. Use pull boxes for access points when the conduit system extending from the backbone to the ITS field devices requires an access point to house only fiber optic drop cables.

7.5.8 Infrastructure

7.5.8.1 Grounding and Lightning Protection

Effective grounding and lightning protection is generally achieved through a combination of three primary techniques: proper bonding and installation of grounding rods, air terminals, and surge protective devices (SPDs). These three methods work concurrently to protect ITS equipment installed in the field and must be incorporated, as applicable, in ITS design plans.

When developing plans that include these systems consider existing geological and other physical characteristics (e.g. rock formations, underground utilities, gravel deposits, soil types and resistivity, and groundwater) at proposed installation locations that may affect the design or layout of grounding systems. . Include in the plans any pertinent survey data gathered during plans development, such as soil resistivity measurements.

Placement and layout of grounding arrays should be planned in such a way that grounding paths from the down cable to the primary electrode are as straight as possible. Provide details in the plans related to cable routing and other installation details required to maximize the efficiency of grounding and SPDs.

Grounding and SPD placement and overall system design should be determined by project-specific needs, as well as the following general design criteria:

1. Follow best practices defined in the NFPA 780 Standard for the Installation of Lightning Protection Systems and NFPA 70, National Electric Code.
2. Place SPD equipment so that grounding connections are as short and straight as possible.
3. Conductor routing must avoid bending and provide physical separation between low-voltage and high-voltage signal paths.
4. Avoid routing unprotected wires or grounding wires parallel or adjacent to protected wiring.

7.5.8.2 CCTV Pole and Lowering Device

Provide a lowering device for pole-mounted devices where height precludes easy access using a bucket truck. Coordinate with the local District ITS office on the use and selection of lowering devices.

If designs call for a lowering device to be attached to an existing pole or similar structure, ensure that the design includes external conduit for housing the cabling, the necessary mounting box hardware at the top of the structure, and any other component details required for installation (e.g., air terminal, etc.).

Consider the placement of all devices on the pole and how they may affect the ability to utilize the lowering device. Use of lowering device should not require an operator to stand directly beneath the equipment while it is being lowered.

7.5.8.3 ITS Field Cabinet

Base the location of the cabinet on safety of the motorist, visibility of roadside devices, and safe access by maintenance staff. ITS field cabinets can be base mounted on a concrete pad, structure mounted, or pole mounted. Coordinate placement with existing and proposed drainage features to prevent cabinet flooding. Consider safety features such as service slabs and railings for cabinets placed at locations with slopes steeper than 1:2.

Size the cabinet to accommodate the equipment to be installed inside. In addition, the cabinet size should account for ease of access to the equipment and the ability to achieve proper ventilation. The placement of devices in the cabinet must be consistent throughout a project. If a specific cabinet orientation or door swing is required, this can be shown in the plans.

7.5.8.4 Equipment Shelter

The lateral offset to equipment shelters must be in accordance with the requirements of **Chapter 4** of this Volume.

Though equipment shelters are prefabricated in large part, include the following in the plans:

1. Details of the site layout, including the shelter dimensions, site preparation work, fencing, landscape, conduit and pull box installation, as well as details for electrical, lighting, grounding, alarm, and HVAC systems necessary to accommodate the types and quantity of equipment the shelter will house.
2. Details that illustrate the equipment layout inside the shelter, including positioning of overhead cable trays, the quantity and placement of standard EIA/TIA 19-inch racks, demarcation and patch panels, and the equipment placement within each rack.
3. Details of back-up power systems such as UPS, generator, fuel tank, security cameras, security alarms, and other security features.

7.5.9 Vehicle Detection and Data Collection

Perform a technology assessment and select a vehicle detection technology that supports the data collection needs for the project.

Prepare a design that details a complete detection assembly, including all other necessary components to be supplied and constructed. Detail in the drawings the exact location and placement of system components, and include installation details for the required cables. Design the cabling installation according to the manufacturer's recommendations.

For vehicle detection systems, such as those utilizing video, microwave, magnetic field, or AVI technologies, the designer should consult with the device manufacturers to ensure that placement and installation plans facilitate proper operation of a particular device type. Be aware of a technology's capabilities and limitations in a given location in order to create a design that is capable of achieving the required levels of detection accuracy.

7.6 Pavement Markings

Pavement marking design must comply with *FDOT Standard Specifications*, *FDOT Design Standards*, *FDOT Traffic Engineering Manual (TEM)* and *FDOT Manual on Uniform Traffic Studies (MUTS)*.

Manual on Uniform Traffic Control Devices (MUTCD) - The *MUTCD* was adopted by the Department as the uniform system of traffic control for use on the streets and highways of the State. This action was in compliance with **Chapter 316.0745** of the *Florida Statutes*. The *MUTCD* is therefore the basic guide for pavement marking. The requirements of the *MUTCD* must be met, as a minimum, on all roads in the State. Where FDOT documents indicate criteria which is more stringent than the *MUTCD*, the FDOT criteria should be followed.

7.6.1 Selection of Pavement Marking Material

Use the flowchart shown in **Figure 7.6.1** as a tool to assist in determining the appropriate pavement marking material.

Once the pavement marking material is selected from **Figure 7.6.1**, verify the project meets the criteria discussed in **Sections 7.6.1.1** through **7.6.1.6**.

Figure 7.6.1 Pavement Marking Material Selection

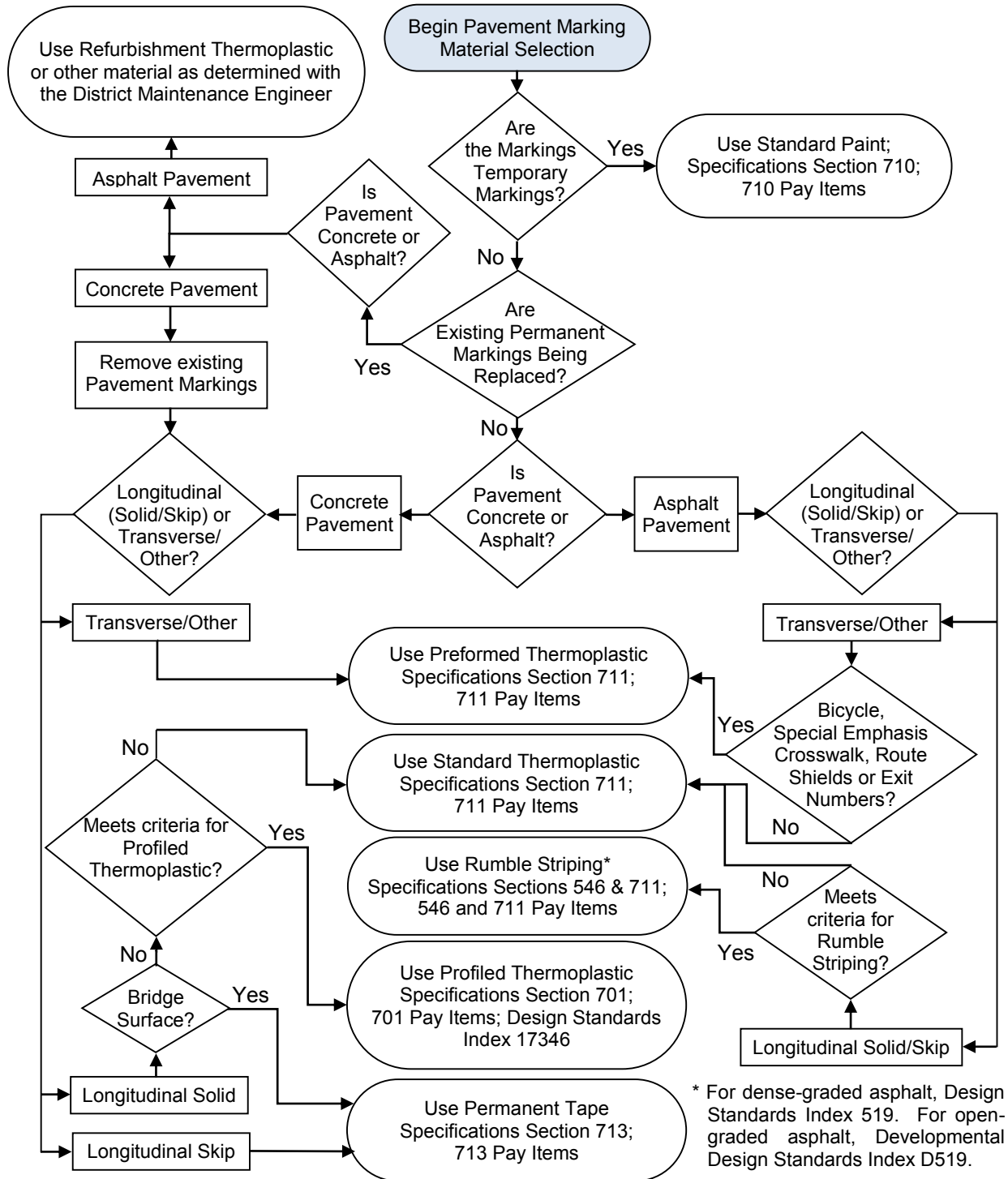

7.6.1.1 Standard and Refurbishment Thermoplastic

Use Standard Thermoplastic traffic stripes and markings unless Rumble Striping, Profiled Thermoplastic, Preformed Thermoplastic or Permanent Tape is required. Standard Thermoplastic is not used on bridge structures with concrete riding surfaces due to vibration and durability issues.

Refurbishment Thermoplastic is the placement of new thermoplastic material on existing pavement markings. Refurbishment Thermoplastic is not to be used on concrete riding surfaces; i.e. concrete pavement and bridge structures. Remove existing stripes and markings from concrete surfaces before placing new stripes and markings.

The performance of Refurbishment Thermoplastic has been evaluated by the Department for a period of 36 months. Coordinate with the District Maintenance Engineer to determine if Refurbishment Thermoplastic is appropriate. If Refurbishment Thermoplastic cannot be applied without exceeding the maximum thickness of 0.15 inch, remove the existing stripes and markings before placing new stripes and markings.

Coordinate with the District Maintenance Engineer to determine if black paint contrast is required for skip lines, messages and arrows.

Modification for Non-Conventional Projects:

Delete the last two paragraphs above and see the RFP.

7.6.1.2 Rumble Striping

Rumble Striping provides an audible and vibratory effect and is used on asphalt pavement as a countermeasure for lane departures and centerline crossover crashes. Rumble Striping is created by utilizing the grinding process as shown in [DDS](#), **Index D519**. Thermoplastic markings are installed over the ground-in rumble strips producing “Rumble Striping”. Contrast marking is not used with Rumble Striping.

For flush shoulder roadways with a posted speed of 50 mph or greater, see Usage Criteria in the **Instructions for Developmental Design Standards (IDDS)** for Index D519 (IDDS-D519) to determine if the Index D519 should be requested and used on the project.

7.6.1.3 Profiled Thermoplastic

Profiled Thermoplastic provides an audible and vibratory effect and is used on concrete pavement as a countermeasure for lane departure and centerline crossover crashes. Contrast marking is not used with Profiled Thermoplastic markings.

Use Profiled Thermoplastic for edge line(s) and centerline striping on flush shoulder roadways with a posted speed of 50 mph or greater. Do not exclude sections of the project where the posted speed has been reduced due to restricted horizontal or vertical geometry (i.e. Advisory Speed). Refer to ***Design Standards, Index 17346*** for additional information.

Use Profiled Thermoplastic on concrete limited access roadways with concrete shoulders in lieu of shoulder ground-in rumble strips. Refer to ***Design Standards, Index 518*** for additional information.

Profiled Thermoplastic markings may be used for edge lines on two-lane roadways that do not have paved shoulders.

Profiled Thermoplastic markings may be used for edge lines on bridges with narrow shoulders as a countermeasure for barrier impacts.

7.6.1.4 Preformed Thermoplastic

Use Preformed Thermoplastic on all pavement types for the following markings:

- Bicycle Markings and Shared use Path Markings (see [Design Standards, Index 17347](#))
- Special Emphasis Crosswalks (see [Design Standards, Index 17346](#))
- Route Shields (see [TEM](#))
- Ramp Exit Numbers (see [Design Standards, Index 17346](#))

Use Preformed Thermoplastic on concrete riding surfaces (i.e., concrete pavement and bridge structures) for the following markings:

- White dotted Lines (2'-4') with trailing black contrast; i.e. 2 feet white Preformed Thermoplastic plus 2 feet black Preformed Thermoplastic. Use only the alternating skip pattern.

- Arrows, Messages and Symbols. Black contrast border is required for design speeds 45 mph and less. Black contrast block is required for design speeds greater than 45 mph.

7.6.1.5 Permanent Tape

Use Permanent Tape on all concrete riding surfaces (i.e. concrete pavement and bridge structures) for the following markings:

- White skip lines (10'-30') with trailing black contrast; i.e. 10 feet white tape plus 10 feet black tape. Use only the alternating skip pattern.
- White dotted lines (6'-10') with trailing black contrast; i.e. 6 feet white tape plus 6 feet black tape. Use only the alternating skip pattern.
- White dotted lines (3'-9') with trailing black contrast; i.e. 3 feet white tape plus 3 feet black tape). Use only the alternating skip pattern.
- Yellow skip lines (10'-30'). Do not use contrast.

Use Permanent Tape for centerlines and edge lines on bridges with concrete riding surfaces. Do not use contrast.

Remove existing stripes and markings from concrete surfaces before placing new permanent tape.

7.6.1.6 Two Reactive Components

Two Reactive Components may be used as an alternative to Standard Thermoplastic markings for edge lines and skip lines on asphalt pavement and only edge lines on concrete pavement.

Two Reactive Components pavement markings may be feasible for large projects. The use of Two Reactive Components pavement markings must be approved by both the District Maintenance Engineer and the District Construction Engineer.

For existing asphalt pavement, contact the District Maintenance Engineer to determine if black paint contrast is required for skip lines, messages and arrows.

Modification for Non-Conventional Projects:

Delete the last two paragraphs above and see the RFP.

7.6.2 Work Zone Pavement Markings

Use Standard Paint for work zone markings on asphalt and concrete pavement. The performance of Standard Paint has been evaluated by the Department for a period of 6 months.

Use Removable Tape for transitions on the final asphalt surface.

Consider using Refurbishment Thermoplastic when a work zone phase is expected to last for more than a year under heavy traffic volumes.

7.6.3 Refurbishment Applications

For refurbishment markings, consider the following factors:

- Service life of pavement
- Thickness and conditions of existing markings
- Traffic volumes
- Cost of markings
- Other special requirements such as contrast needs or rumble striping

7.6.4 No-Passing Zones

Follow the procedures contained in the *Manual on Uniform Traffic Studies, (MUTS)* for determining the limits of no-passing zones.

Limits of pavement markings for no-passing zones will be established by one of the following methods:

1. On projects where existing roadway conditions (vertical and horizontal alignments) are to remain unaltered by construction, the no-passing zones study will be accomplished as part of the design phase. The limits of the no-passing zones will be shown on the plans.
2. On projects with new or altered vertical and horizontal alignments, limits for no-passing zones will be established during construction. The required traffic study and field determination of limits will be performed by the designer during post design. Sufficient time must be included to accomplish the required field operations without delaying or interfering with the construction process.

7.6.5 Pavement Marking Project Coordination

Coordination with other offices and agencies is a very important aspect of project design. The offices discussed in this section are typically involved in a signing and marking project, however there may be other offices.

Roadway Design - The designer of pavement marking project receives the base sheets for design from the roadway designer. Base sheets may be created from existing plans when the pavement marking project is not part of an active roadway design project.

Modification for Non-Conventional Projects:

Delete **PPM** 7.6.5 and see the RFP.

THIS PAGE LEFT BLANK INTENTIONALLY

Chapter 8

Pedestrian, Bicycle and Public Transit Facilities

8.1	General	8-1
	8.1.1 Pedestrians and Bicyclists	8-1
	8.1.2 Transit	8-4
8.2	References.....	8-4
8.3	Pedestrian Facilities	8-5
	8.3.1 Sidewalks.....	8-5
	8.3.2 Curb Ramps.....	8-7
	8.3.3 Detectable Warnings	8-8
	8.3.4 Crosswalks	8-8
	8.3.4.1 Crosswalks at Intersections	8-9
	8.3.4.2 Midblock Crosswalks	8-10
	8.3.5 Railroad Crossing	8-11
8.4	Bicycle Facilities	8-12
	8.4.1 Bicycle Lanes	8-13
	8.4.2 Bicycle Lane Between Through Lane and Right Turn Lane, Bus Bay or Parking Lane (Keyhole).....	8-14
	8.4.2.1 Keyhole Locations	8-14
	8.4.2.2 Green Color Bicycle Lanes	8-14
	8.4.3 Paved Shoulders	8-22
	8.4.4 Wide Curb Lanes	8-22
	8.4.5 Shared Lane Markings (Sharrows)	8-22
	8.4.6 Bicycle Route Systems	8-23
	8.4.6.1 United States Bicycle Routes	8-24
8.5	Drainage and Utility Considerations	8-26
8.6	Shared Use Paths	8-26
	8.6.1 Considerations	8-26

8.6.2	Widths	8-27
8.6.3	Cross Slopes	8-27
8.6.4	Grades	8-27
8.6.5	Lateral Offset	8-28
8.6.6	Vertical Clearance	8-28
8.6.6	Vertical Clearance	8-29
8.6.7	Design Speed	8-29
8.6.8	Horizontal Alignment	8-29
	8.6.8.1 Minimum Radii	8-29
	8.6.8.2 Stopping Sight Distance	8-30
8.6.9	Vertical Alignment	8-31
8.6.10	Separation between Shared Use Path and Roadway ...	8-31
8.6.11	Path Railings	8-32
8.6.12	Lighting	8-32
8.6.13	Signing, Pavement Marking, and Signalization	8-32
8.7	Bridges, Overpasses, and Underpasses	8-33
8.7.1	Design Criteria	8-33
8.7.2	Prefabricated Steel Truss Bridges on FDOT Projects	8-36
	8.7.2.1 Qualification of Prefabricated Steel Truss Pedestrian Bridge Producers	8-37
	8.7.2.2 Design and Detailing Responsibilities	8-37
	8.7.2.3 Plans Development	8-38
8.8	Drop-off Hazards for Pedestrians and Bicyclists	8-43
8.9	Strategic Intermodal System Highway Component Standards and Criteria	8-46
8.10	Public Transit Facilities	8-46
	8.10.1 Boarding and Alighting Areas	8-47
	8.10.2 Street-Side Facilities	8-50
	8.10.3 Exclusive Transit Running Ways	8-51

Tables

Table 8.1.1	Bicycle Facilities	8-2
Table 8.4.1	U. S. Bicycle Route Criteria	8-25
Table 8.6.1	Maximum Grade Lengths	8-28
Table 8.6.2	Minimum Radii for Horizontal Curves on Shared Use Paths.....	8-30
Table 8.6.3	Minimum Stopping Sight Distances	8-31

Figures

Figure 8.3.1	Pedestrian Crossing Options.....	8-12
Figure 8.4.1	Bike Lane with Separate Right Turn Lane	8-17
Figure 8.4.2	Bike Lane with Right Turn Drop Lane	8-18
Figure 8.4.3	Bike Lane with Channelized Right Turn Lane	8-19
Figure 8.4.4	Bike Lane with Free Flow Channelized Right Turn Lane	8-20
Figure 8.4.5	Bike Lane with Bus Bay	8-21
Figure 8.6.1	Sign Placement on Shared Use Paths	8-32
Figure 8.7.1	Pedestrian/Shared Use Path Bridge Typical Section	8-35
Figure 8.7.2	Prefabricated Pedestrian Bridge Standard Truss Configurations	8-41
Figure 8.7.3	Prefabricated Pedestrian Bridge Standard Truss Member Shapes	8-41
Figure 8.7.4	Prefabricated Pedestrian Standard Bridge Cross-Sections.....	8-42
Figure 8.8.1	Drop-Off Hazards for Pedestrians and Bicyclists	8-45
Figure 8.10.1	Accessible Boarding and Alighting Area for Flush Shoulder Roadways with Connection to Roadway	8-48

Figure 8.10.2	Accessible Boarding and Alighting Area for Flush Shoulder Roadways with Connection to Sidewalk	8-49
Figure 8.10.3	Bus Stop and Bus Bay Categories	8-52
Exhibits		
Exhibit 8-A	Sample Steel Truss Pedestrian Bridge Plans	8-53

Chapter 8

Pedestrian, Bicycle and Public Transit Facilities

8.1 General

8.1.1 Pedestrians and Bicyclists

[Section 335.065, Florida Statutes](#), *Bicycle and pedestrian ways along state roads and transportation facilities* establishes the following requirements:

- “(1)(a) Bicycle and pedestrian ways shall be given full consideration in the planning and development of transportation facilities, including the incorporation of such ways into state, regional, and local transportation plans and programs. Bicycle and pedestrian ways shall be established in conjunction with the construction, reconstruction, or other change of any state transportation facility, and special emphasis shall be given to projects in or within 1 mile of an urban area.
- (b) Notwithstanding the provisions of paragraph (a), bicycle and pedestrian ways are not required to be established:
1. Where their establishment would be contrary to public safety;
 2. When the cost would be excessively disproportionate to the need or probable use;
 3. Where other available means or factors indicate an absence of need.”

In addition to this manual and the Department’s Design Standards, the **[United States Department of Justice 2010 Americans with Disabilities Act \(ADA\) Standards for Accessible Design](#)** and the **[United States Department of Transportation 2006 ADA Standards for Transportation Facilities](#)** guide the design of pedestrian facilities in the public right of way. Where the ***2010 ADA Standards for Accessible Design*** or ***2006 ADA Standards for Transportation Facilities*** do not address a specific issue, the draft **[Proposed Guidelines for Pedestrian Facilities in the Public Right-of-Way \(PROWAG\)](#)** provides best practices.

The **[Florida Accessibility Code](#)** contains scoping and technical requirements for accessibility to sites, facilities, buildings and elements by individuals with disabilities.

If the design criteria contained within the PPM for pedestrian and bicycle facilities are not met, a Design Variation is required. Reference which of the three conditions under **Section 335.065 (1)(b), Florida Statutes** support not providing a bicycle or pedestrian facility in the documentation.

Sidewalks and shared use paths are appropriate pedestrian facilities for all types of projects and locations. Beyond one mile of an urban area where only occasional pedestrian traffic is expected, a shoulder (paved and unpaved) would meet the need for a pedestrian way. **Table 8.1.1** identifies appropriate bicycle facilities for various types of projects. The [Urban Area 1-Mile Buffer Maps](#) are posted in conjunction with the PPM.

Table 8.1.1 Bicycle Facilities

Location	Condition	Type of Work		
		New Construction, Reconstruction	Resurfacing, Restoration, Rehabilitation (RRR) ^{1,2,3}	Traffic Operations, Intersection Improvements
In or within one mile of an urban area	All	Buffered Bicycle Lane	Buffered Bicycle Lane, Bicycle Lane, Wide Curb Lane, or Shared Lane with Shared Lane Markings (acceptable for posted speed 35 mph or less)	Buffered Bicycle Lane, Bicycle Lane, Wide Curb Lane, or Shared Lane with Shared Lane Markings (acceptable for posted speed 35 mph or less)
Beyond one mile of an urban area	Curb and Gutter	Buffered Bicycle Lane	Buffered Bicycle Lane, Bicycle Lane, Wide Curb Lane, or Shared Lane with Shared Lane Markings (acceptable for posted speed 35 mph or less)	Buffered Bicycle Lane, Bicycle Lane, Wide Curb Lane, or Shared Lane with Shared Lane Markings (acceptable for posted speed 35 mph or less)
	Flush Shoulder	Paved Shoulder	Paved Shoulder	Paved Shoulder

1. When no bicycle facilities exist, the widening of curbed sections for the project length to provide bicycle facilities may disproportionately affect the scope and cost of a RRR project, especially if reconstruction of the curb, sidewalk, and/or drainage system is required, additional right of way is needed, or utilities are impacted. No Design Variation is necessary, however, include a statement similar to the following in the project file:

“Bicycle facilities have been considered for this project but will not be provided, due to insufficient width between existing curb lines to provide bicycle facilities without substantial reconstruction of the roadway, drainage system and sidewalk (and/or requires additional right of way). Reconstruction (and/or right of way acquisition) is outside the scope of this project.”
2. Substantial widening of an existing curbed section is outside the scope of a RRR project and is considered reconstruction.
3. See **Section 25.4.19** for options on RRR projects with existing roadways where no widening is planned.

Bicyclists and pedestrians should be expected on all of Florida’s state roadways except where restricted on limited access facilities and interstate highways (**Section 316.091 Florida Statutes**).

Coordinate with the District Pedestrian/Bicycle Coordinator during the project development and implementation process. Coordination with the District ADA Coordinator may also be necessary.

When considering “other available means” in accordance with **F.S. 335.065 (1)(b)(3)** (above), an alternate route or facility to serve cyclists and pedestrians should:

- Meet the design criteria for bicycle and pedestrian facilities on state roadways.
- Provide access to the same services, origination and destination sites, and transit connections as the project corridor.
- Not result in a significant increase in travel time or trip length, exposure to motorized traffic or substantial elevation changes.
- Provide appropriate locations to cross limited access, arterial or collector roadways, or rail corridors.

8.1.2 Transit

Provide connectivity between pedestrian or bicycle facilities and transit facilities.

Where transit service is provided or planned to be established, coordinate with the following:

- District Pedestrian and Bicycle Coordinator
- District Modal Development Office Coordinator
- District ADA Coordinator
- District Public Transportation staff
- Local public transit provider(s)

Coordination will be required to determine the optimum location of boarding and alighting areas, transit shelters and bus bays.

Modification for Non-Conventional Projects:

Delete **PPM** 8.1.2 and see the RFP for requirements.

8.2 References

1. [United States Department of Justice 2010 Americans with Disabilities Act \(ADA\) Standards for Accessible Design](#)
2. [United States Department of Transportation 2006 Americans with Disabilities Act \(ADA\) Standards for Transportation Facilities](#)
3. [Proposed Guidelines for Pedestrian Facilities in the Public Right-of-Way \(PROWAG\)](#)
4. [Florida Accessibility Code](#)
5. [FDOT Design Standards](#)
6. [FDOT Structures Manual, Current Edition](#)
7. [FDOT Traffic Engineering Manual](#)
8. [FDOT Manual on Uniform Traffic Studies \(MUTS\)](#)
9. [2013 Accessing Transit Design Handbook](#)

10. [Manual on Uniform Traffic Control Devices \(MUTCD\)](#)
11. [Shared Use Path Level of Service Calculator, A User's Guide \(FHWA\)](#)
12. [NCHRP Report 672 Roundabouts: An Informational Guide, Second Edition](#)
13. [AASHTO Guide for the Development of Bicycle Facilities](#)
14. [AASHTO Guide for the Planning, Design, and Operation of Pedestrian Facilities](#)
15. [AASHTO Guide for Geometric Design of Transit Facilities on Highways and Streets, 1st Edition](#)
16. [Highway Capacity Manual 2010](#)
17. [AASHTO LRFD Bridge Design Specifications, Current Edition](#)
18. [Transportation Research Board \(TRB\) Guidelines for the Location and Design of Bus Stops adapted from TCRP Report 19. Washington D.C.: National Academy Press](#)
19. [NACTO Urban Streets Design Guide](#)
20. [ITE/CNU Recommended Practice: Designing Walkable Urban Thoroughfares](#)

8.3 Pedestrian Facilities

Provide separate walking areas, such as sidewalks or shared use paths, on roadways and bridges in or within one mile of the urban area, except where prohibited by Florida Statutes. Design sidewalks and shared use paths to comply with accessibility requirements. Refer to **Section 8.6** for further information on designing shared use paths.

8.3.1 Sidewalks

Sidewalks are walkways parallel to the roadway and designed for use by pedestrians. Sidewalks should be provided along both sides of roadways that are in or within one mile of an urban area. If sidewalks are constructed on the approaches to bridges, they should be continued across the structure. If continuous sidewalks are constructed on only one side of the street, pedestrians should be provided access to facilities and services located on the opposite side of the street.

Modification for Non-Conventional Projects:

Delete the second sentence of the above paragraph and see RFP for additional requirements.

The minimum width of a sidewalk is 5 feet when the sidewalk is separated from the back of curb by 2 feet or more. If the sidewalk is located adjacent to the curb, the minimum width of sidewalk is 6 feet. Wider sidewalks are appropriate in locations where higher levels of pedestrian activity are expected.

Grades on sidewalks must not exceed 5% when not adjacent to a travel way unless accessible ramps are provided. There should be enough sidewalk cross slope to allow for adequate drainage; however, to comply with ADA requirements, the maximum cross slope is 2%. A clear 1-foot wide graded area with a maximum 1:6 slope should be provided adjacent to the sidewalk. Edge drop-offs should be avoided. When drop-offs cannot be avoided, they should be shielded as discussed in **Section 8.8**.

Provide a 5-foot wide (minimum) sidewalk that connects a transit stop or facility with an existing sidewalk or shared use path.

Evaluate the appropriate termini for pedestrian facilities (i.e., connect to existing sidewalk, pedestrian crossing or access point). Contact the District Pedestrian/Bicycle Coordinator for input on making a determination regarding continuous passage.

For roadways with flush shoulders, place new sidewalks in the following order of desirability:

- (1) As near the right of way line as possible.
- (2) Outside of the clear zone.
- (3) Five feet beyond the limits of the full width shoulder.
- (4) At the limits of the full width shoulder.

Sidewalks are not to be constructed directly adjacent to the roadway or shoulder pavement. Nearing intersections, the sidewalk should be transitioned as necessary to provide a more functional crossing location that also meets driver expectation. Further guidance on the placement of stop or yield lines and crosswalks is provided in the [MUTCD, Part 3](#) and the **Design Standards, Indexes 17344** and **17346**.

8.3.2 Curb Ramps

A continuous accessible pedestrian route, including curb ramps, landings and transition areas (e.g., depressed corners, raised street crossings, flush roadway connections) are required along pedestrian networks. Additional information and details for curb ramps and landings are provided in the [Design Standards, Index 304](#).

Include sidewalk curb ramps at the following locations:

- All intersections and turnouts with curbed returns. Include a landing at the top of each ramp.
- On curbed roadways between intersections where a crosswalk has been established

Pull boxes, manholes (and other utility covers), and other types of existing surface features in the location of a proposed curb ramp or detectable warning should be relocated. When relocation is not feasible, adjust the feature to meet the ADA requirements for surfaces (including the provision of a nonslip top surface, and adjustment to be flush with and at the same slope as the adjacent surface).

Curb ramps should be in line with the crossing and must provide a maximum slope of 1:12 (8.3 percent). At intersections where more than one road is crossed, provide curb ramps at both ends of each crossing. Crossings are required to meet the same grade and cross slope requirements as sidewalks. Where criteria for maximum cross slope cannot be met, process a Design Variation and provide the minimum attainable cross slope. When following the profile grade of the roadway, curb ramp slopes should not exceed 15 feet in length.

Evaluate existing driveways and turnouts for compliance to ADA requirements. Nonconforming driveways are not required to be upgraded if it is not feasible within the scope of the project.

Provide transition slopes (flared sides) where a pedestrian circulation path crosses the curb ramp. The maximum slope of transition slopes is 1:10, measured parallel with and adjacent to the curb line.

8.3.3 Detectable Warnings

Install detectable warnings to cover the full width of the walking surface and 2 feet deep. They are required on sidewalks and shared use paths at the following locations:

- curb ramps and transition areas at street crossings
- cut-through pedestrian refuge islands or medians six feet wide or greater
- pedestrian at-grade rail crossings
- commercial driveways with a stop sign, yield sign, or traffic signal
- boarding and alighting areas adjacent to the roadway at bus stops where there is an at-grade connection to the roadway
- edges of rail boarding platforms not protected by screens or guards

Detectable warnings should not be placed where sidewalk intersects urban flared turnouts or sidewalks that run continuously through residential driveways. Do not place detectable warnings on transition slopes or over grade breaks. Further guidance on detectable warnings is provided in [Design Standards](#), **Index 304**.

The detectable warning systems on the APL are designed to work with concrete surfaces. In areas where the pedestrian facility has an asphalt surface, such as a shared use path, specify an appropriate detectable warning system. In these cases, consider including a short section of concrete that will accommodate any system.

8.3.4 Crosswalks

Crosswalks occur at all intersections (whether marked or not) and on any portion of a roadway distinctly indicated for pedestrian crossing by lines or other markings on the surface. Crossings should be convenient and minimize the pedestrian's exposure in the roadway. Crosswalks are defined in **Florida Statutes 316.003(6)**.

There are a number of treatments that may be used to help pedestrians safely cross the roadway, whether crossing at an intersection or midblock. A marked crosswalk is one of these tools. Marking of crosswalks helps drivers better identify the intersection and guides pedestrians to the best crossing location.

The criteria provided in this section do not apply to school crossings.

Additional guidance on marked crosswalks can be found in the [*FDOT Traffic Engineering Manual Section 3.8, AASHTO Guide for the Planning, Design, and Operation of Pedestrian Facilities*](#) and [*FHWA's Safety Effects of Marked vs. Unmarked Crosswalks at Uncontrolled Locations: Executive Summary and Recommended Guidelines*](#).

8.3.4.1 Crosswalks at Intersections

Provide marked crosswalks at all side streets where a pedestrian facility meets the roadway. As roadway volumes, speeds and number of travel lanes increase, marked crosswalks are best used in conjunction with other treatments (including signals, signs, beacons, curb extensions, raised medians, refuge islands, and enhanced overhead lighting).

When separated right turn lanes are used, place crosswalks so that an approaching motorist has a clear view of the pedestrian, and the crossing distance is minimized.

Coordinate with the District Traffic Operations Office for new marked crosswalks at uncontrolled intersection locations (without signals, stop or yield signs). Supplement marked crosswalks on an uncontrolled leg of an intersection with other treatments (which may include beacons, signals, curb extensions, raised medians, raised traffic islands, or enhanced overhead lighting) when any of the following conditions exist:

- (1) Where posted speeds are greater than 40 mph.
- (2) On a roadway with 4 or more lanes without a raised median or raised traffic island that has an ADT of 12,000 or greater.
- (3) On a roadway with 4 or more lanes with a raised median or raised traffic island that has or is projected to have (within 5 years) an ADT of 15,000 or greater.

Use Special Emphasis crosswalk markings at signalized intersections on all approaches, mid-block crossings, and school crossings per ***Design Standards, Index 17346***.

Use standard crosswalk markings for stop or yield-controlled intersections where pedestrian facilities are present as shown in ***Design Standards, Index 17346***.

Roundabouts present a unique challenge for the design of pedestrian crossings. In a roundabout, the crosswalk markings should comply with the ***MUTCD, Part 3, NCHRP Report 672 Roundabouts: An Informational Guide, Second Edition*** and the [*FDOT Traffic Engineering Manual*](#).

8.3.4.2 Midblock Crosswalks

Midblock crosswalks can be used to supplement the pedestrian crossing needs in an area between intersections. This can provide pedestrians with a more direct route to their destination. Midblock crosswalks should be illuminated, marked and signed in accordance with the *MUTCD*, [Traffic Engineering Manual](#), (Section 3.8) and *Design Standards, Index 17346*.

In addition to the requirements in **Section 8.3.4.1**, the following conditions also apply:

- (1) Midblock crosswalks should not be located where the spacing between adjacent intersections is less than 660 feet
- (2) Midblock crosswalks should not be located where the distance from the crosswalk to the nearest intersection (or crossing location) is less than 300 feet
- (3) Do not place midblock crosswalks in locations where the crossing distance exceeds 60 feet (unless a median or a crossing island is provided)
- (4) Do not place midblock crosswalks in locations where the sight distance for both the pedestrian and motorist is not adequate (stopping sight distance per **Table 2.7.1**)
- (5) Do not place midblock crosswalks in locations where the ADA cross slope and grade criteria along the crosswalk cannot be met.

An engineering study is required before a marked midblock crosswalk is installed at an uncontrolled location. This study is required to examine such factors as sight distance for pedestrians and vehicles (stopping sight distance), traffic volume, turning volumes near proposed crosswalk location, roadway width, presence of a median, lighting, landscaping, drainage, traffic speed, adjacent land use (pedestrian generators / destinations), pedestrian volume and existing crossing patterns. Midblock crosswalks should only be used in areas where the need truly exists, and the engineering study will help to determine if an uncontrolled midblock crosswalk is a viable option. Refer to the Department's [Traffic Engineering Manual, \(Section 3.8\)](#) and [Manual on Uniform Traffic Studies \(MUTS\)](#).

If site conditions are identified that would obstruct the placement of a justified midblock crosswalk, include additional features in the design to remedy these conditions.. Features like overhead signing can help alert motorists and be used to light the crossing. Curb extensions or bulb-outs can improve sight distance and decrease the crossing distance. Adjustment of the profile on the roadway crossing may be required to improve the cross slope of the crosswalk.

8.3.5 Railroad Crossing

Provide an ADA accessible route for pedestrians at railroad crossings by extending proposed or existing sidewalks or shared use paths through the rail crossing. The surface of the crossing must be:

- Firm, stable and slip resistant,
- Level and flush with the top of rail at the outer edges of the rails, and
- Area between the rails aligns with the top of rail.

Place detectable warnings on each side of the railroad crossing as illustrated in **Figure 8.3.1**.

The edge of the detectable warning nearest the rail crossing is to be located between 6 and 15 feet from the centerline of the nearest rail. Where gates are provided, detectable warnings are to be placed a minimum of 4 feet from the side of the gates opposite the rail.

An audible device, such as a bell, is used in conjunction with the traffic control signals, if traffic control signals are in operation at a crossing that is used by pedestrians or bicyclists. Additional information is located in the [MUTCD](#) regarding additional signals, signs, or pedestrian gates and designing crossings for shared use paths.

Flangeway gaps are necessary to allow the passage of train wheel flanges; however, they pose a potential hazard to pedestrians who use wheelchairs because the gaps can entrap the wheelchair casters. A maximum flangeway gap is required for all at-grade pedestrian rail crossings of 2½" for all non-freight rail track and 3" for freight rail track.

Figure 8.3.1 Pedestrian Crossing Options

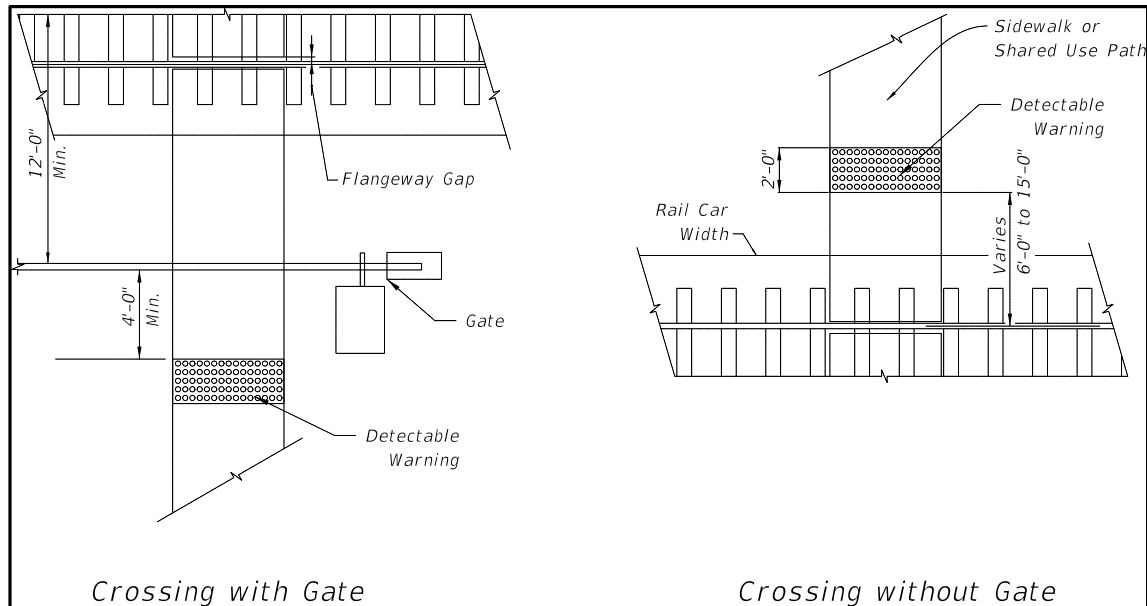

8.4 Bicycle Facilities

Appropriately designed and located bicycle facilities play an important role in supporting safe bicycle travel. Bicycle facilities include buffered bicycle lanes, conventional bicycle lanes, paved shoulders, wide curb lanes, low speed shared lanes (posted speed 35 mph or less), shared use paths, traffic control devices, and bicycle parking facilities.

Measures that can considerably enhance a corridor's safety and capacity for bicycle travel are:

1. Providing bicycle facilities.
2. Maintaining a smooth, clean riding surface, free of obstructions. This includes ensuring drainage inlets and utility covers that cannot be moved out of the travel way are flush with grade, well seated, and use bicycle-compatible inlets, grates and covers.
3. Responsive and appropriate traffic control devices, consistent with guidance in the **MUTCD**, including providing bicycle oriented directional signage.

8.4.1 Bicycle Lanes

Where required by **Table 8.1.1**, provide a bicycle lane for each direction of travel on the roadway. The bicycle lane is defined as the area between the edge of travel lane and the edge of pavement. Bicycle lanes are to be marked in accordance with **Design Standards, Index 17347** and the **MUTCD**. Shared use paths do not meet the requirement for bicycle lanes.

For new construction or reconstruction projects, both curbed and flush shoulder roadways, the standard width of a buffered bicycle lane is 7 feet. For high-speed curbed arterials, the standard width of a buffered bicycle lane is 6.5 feet.

For RRR projects, the distribution of available roadway width may require a bicycle lane other than the standard buffered bicycle lane (refer to **Section 25.4.19.2** of this Volume). When providing a bicycle lane on a RRR project, the options in the order of priority are:

1. 7-foot buffered bicycle lane
2. 6-foot buffered bicycle lane
3. 5-foot conventional bicycle lane
4. 4-foot conventional bicycle lane

The width of the buffer zone for the 6 foot and 7 foot buffered bicycle lane is depicted in **Design Standards, Index 17347**. A Buffered Bicycle Lane should not exceed 7 feet in width. For RRR projects, any additional pavement width that results from restricting the Buffered Bicycle Lane to 7 feet should be applied to the outside travel lane.

At an intersection approach, the buffer striping will transition to a double 6 inch wide stripe using a 2/4 skip pattern. The transition will begin 150 feet in advance of an intersection to provide sufficient distance for an automobile or truck to merge into the bicycle lane before turning right. The buffer striping will not be broken at low-volume or residential driveways.

When a guardrail or other barrier exists and the roadway pavement is continuous to the face of the barrier, the minimum bicycle lane width is 5 feet. Refer to **Section 8.4.2** of this chapter when the bicycle lane is adjacent to a right-turn lane or bus bay.

Bicycle lanes are one-way facilities and carry bicycle traffic in the same direction as adjacent motor vehicle traffic. On one-way streets, bicycle lanes should generally be placed on the right side of the street. A bicycle lane on the left side of the street can be considered if it will substantially reduce the number of potential conflicts, such as those caused by frequent bus traffic, heavy right-turn movements, high-turnover parking lanes, or if there is a significant number of left-turning bicyclists.

8.4.2 Bicycle Lane Between Through Lane and Right Turn Lane, Bus Bay or Parking Lane (Keyhole)

8.4.2.1 Keyhole Locations

In new construction, reconstruction and traffic operations projects, at locations with right turn lanes, bus bays or parking lanes, provide a bicycle lane, known as a keyhole lane, between the through lane and the right turn lane, bus bay or parking lane. The width of the keyhole lane should be the same as the width of the approaching bicycle lane; i.e. a 7-foot keyhole lane for an approaching 7-foot buffered bicycle lane. However, the minimum width of the keyhole lane is 5 feet.

For bicycle lanes adjacent to parking lanes, a 7-foot wide buffered bicycle lane should be provided using a 3-foot buffer adjacent to the parking lane hatched with 10-foot diagonal spacing. Shared lane markings should be used if width is inadequate for the 7-foot buffered bicycle lane.

When a RRR project includes the addition or modification of a right turn lane or bus bay, provide a 5-foot minimum width bicycle lane between the through lane and the right turn lane or bus bay, if existing right of way is adequate.

When a RRR project has an existing right turn lane without a bicycle lane between the through lane and right turn lane, bus bay or parking lane, a bicycle lane should be provided. Factors to be considered include the opportunity to provide a continuous alignment, reduce the potential for conflicts with turning vehicles, and availability of right of way.

8.4.2.2 Green Color Bicycle Lanes

The Federal Highway Administration (FHWA) has issued an Interim Approval for the use of green colored pavement in marked bicycle lanes and in extensions of bicycle lanes through intersections and other traffic conflict areas. In accordance with the conditions of the interim approval, FDOT has requested and received permission from FHWA for locations on the State Highway System. The Interim Approval may be found at the following website:

http://mutcd.fhwa.dot.gov/res-interim_approvals.htm

Green colored bike lanes are optional and may be used to enhance the conspicuity of bicycle lane conflict areas. The following guidelines apply to their use on the State Highway System.

Green color bicycle lanes are permitted at any of the following traffic conflict areas when the speed limit of the roadway is greater than 35 mph:

- a. The bike lane crosses a right turn lane
- b. Traffic in a channelized right turn lane crosses a bike lane
- c. The bike lane is adjacent to a dedicated bus bay
- d. A bike lane transitions across a free-flow merge lane or lane addition, such as at an interchange

Green colored pavements cannot replace or be used in lieu of required markings for bike lanes as defined in this **Chapter** and the **MUTCD**, and will only supplement such markings. When used in conjunction with white skip lines, such as when extending a bike lane across a right turn lane or access to a bus bay, the transverse colored marking must match the 2'-4' white skip line pattern of the bike lane extension. Start the green colored pavement as a solid pattern 50 feet in advance of the skip striping, match the 2'-4' skip through the conflict area, and then resume the solid color for 50 feet after the conflict area, unless such an extent is interrupted by a stop bar, an intersection curb radius or bike lane marking. Include details of each installation and associated pavement markings in the plans. **Figures 8.4.1 – 8.4.5** illustrate how the green portion of the bike lane may be marked. Refer to **Design Standards, Indexes 17346** and **17347** for details on pavement markings.

Materials used to color the bike lane green must:

- be non-reflective
- meet [FDOT Specification 523, Patterned Pavement](#), and
- fall within the color parameters defined by FHWA in their interim approval.

During the first three years of the installation, the District will review annually the crash reports in the conflict area to assess if the green colored pavement is improving the safety of the bike lane. These assessments will be reported to the State Roadway Design Engineer.

Obtain approval for site specific installations of green colored bicycle lanes from the District Design Engineer, and provide a copy of the approval to the State Roadway Design Engineer. The addition of green colored pavement to bicycle lanes per these criteria does not require a local agency maintenance agreement. FDOT may fund the assessment of need, but will be responsible for the design, construction and maintenance of the green colored pavement if its need has been demonstrated in accordance with the requirements above.

Modification for Non-Conventional Projects:

Delete the last sentence in the above paragraph and see RFP for requirements.

Figure 8.4.1 Bike Lane with Separate Right Turn Lane

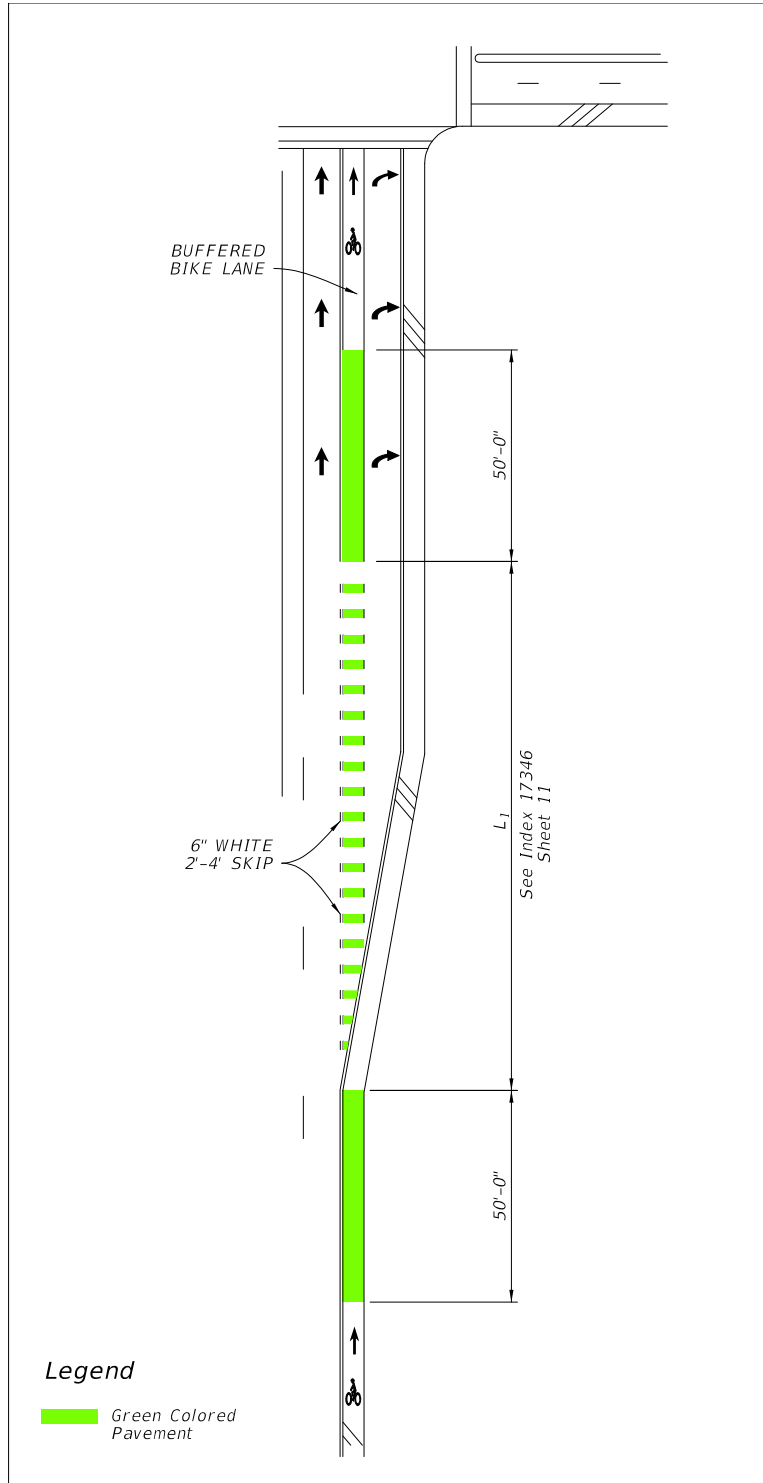

Figure 8.4.2 Bike Lane with Right Turn Drop Lane

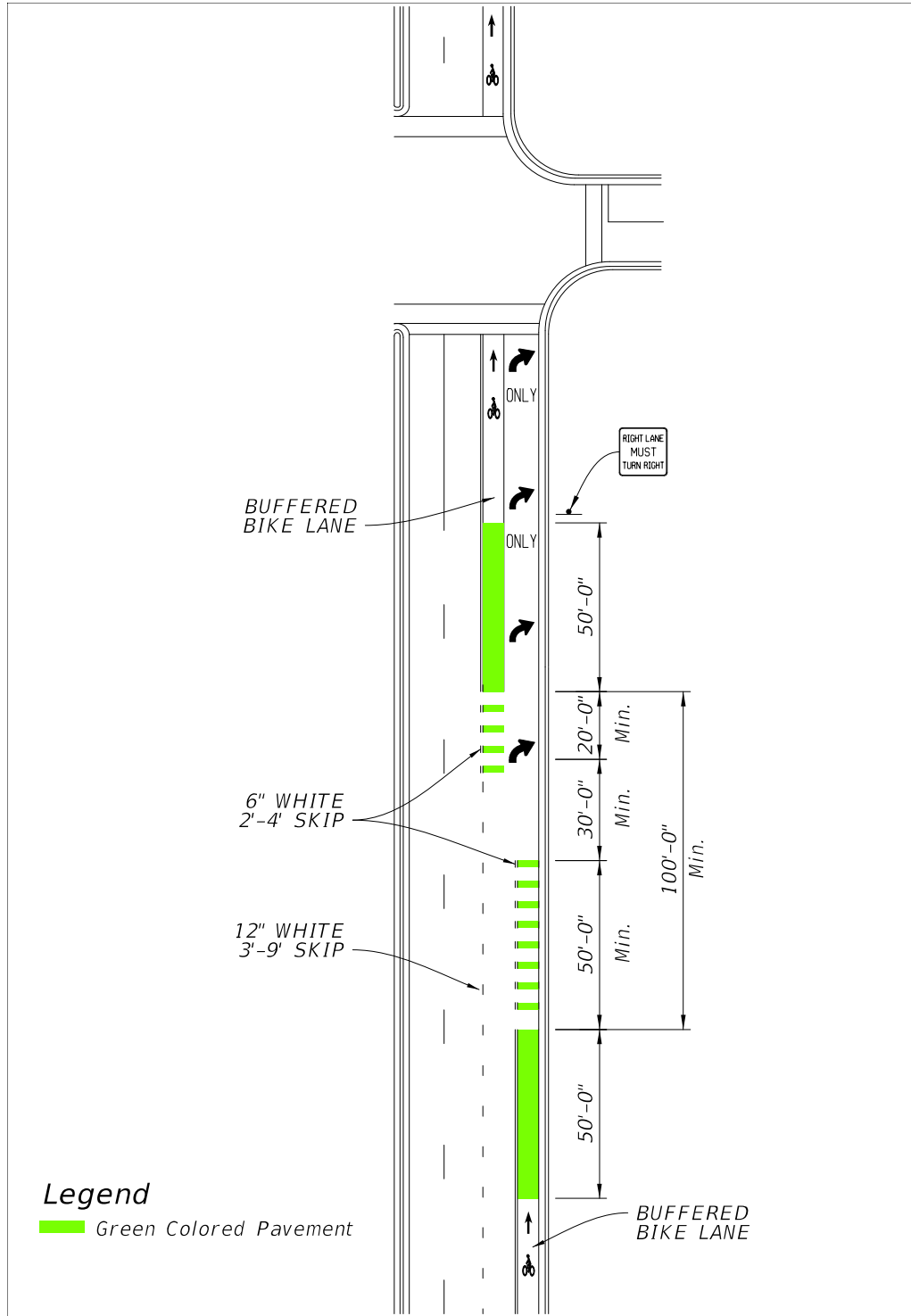

Figure 8.4.3 Bike Lane with Channelized Right Turn Lane

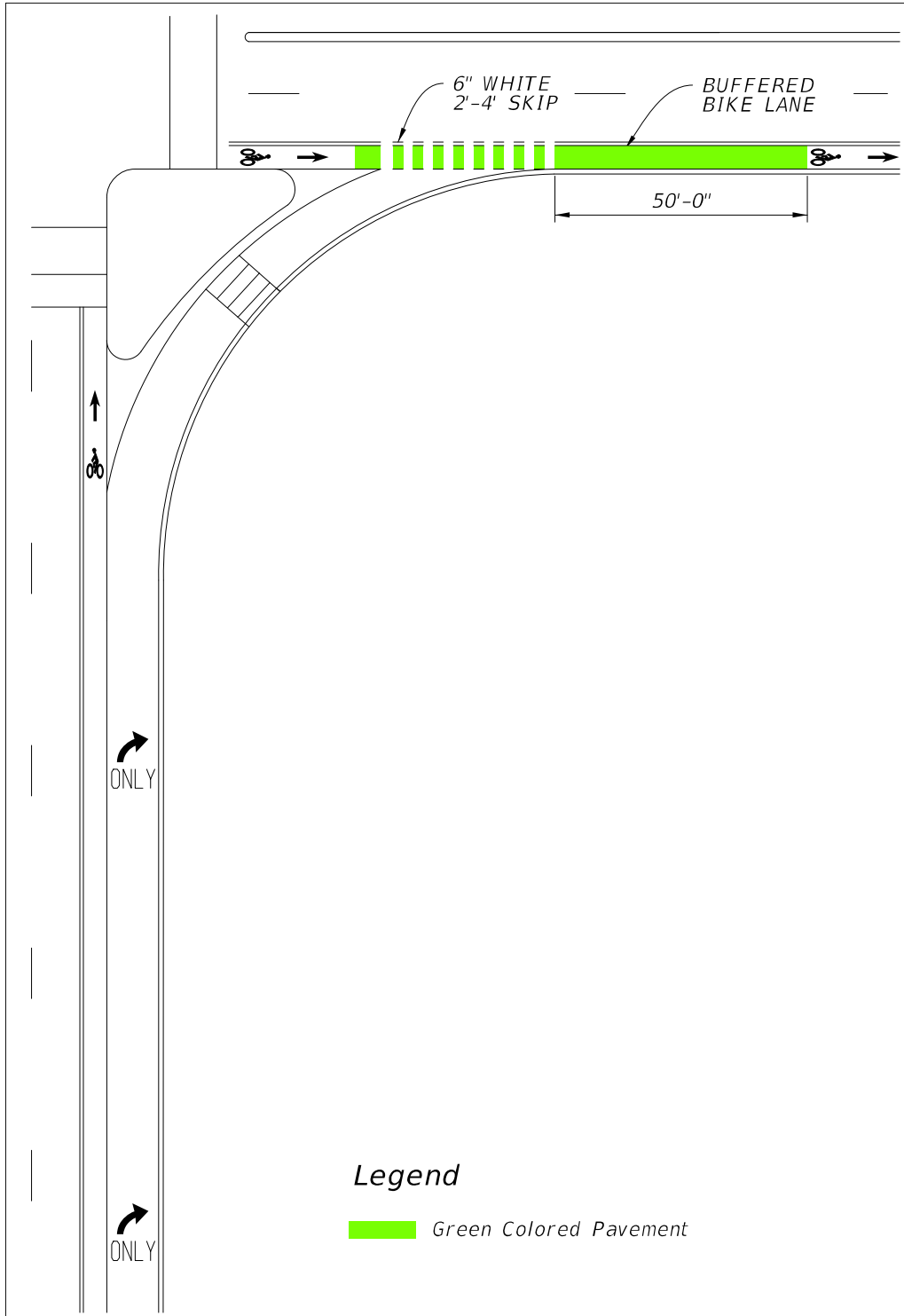

Figure 8.4.4 Bike Lane with Free Flow Channelized Right Turn Lane

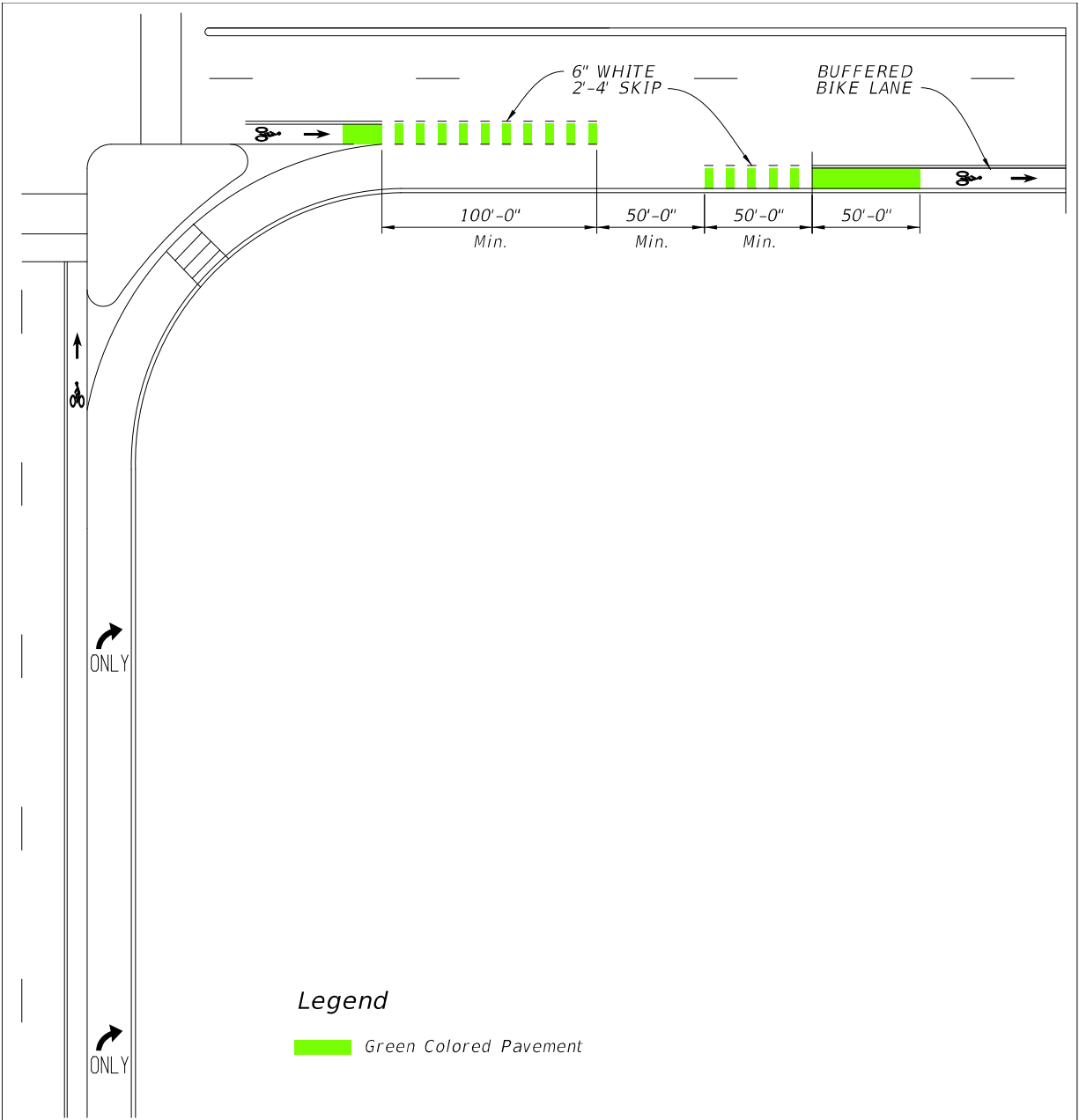
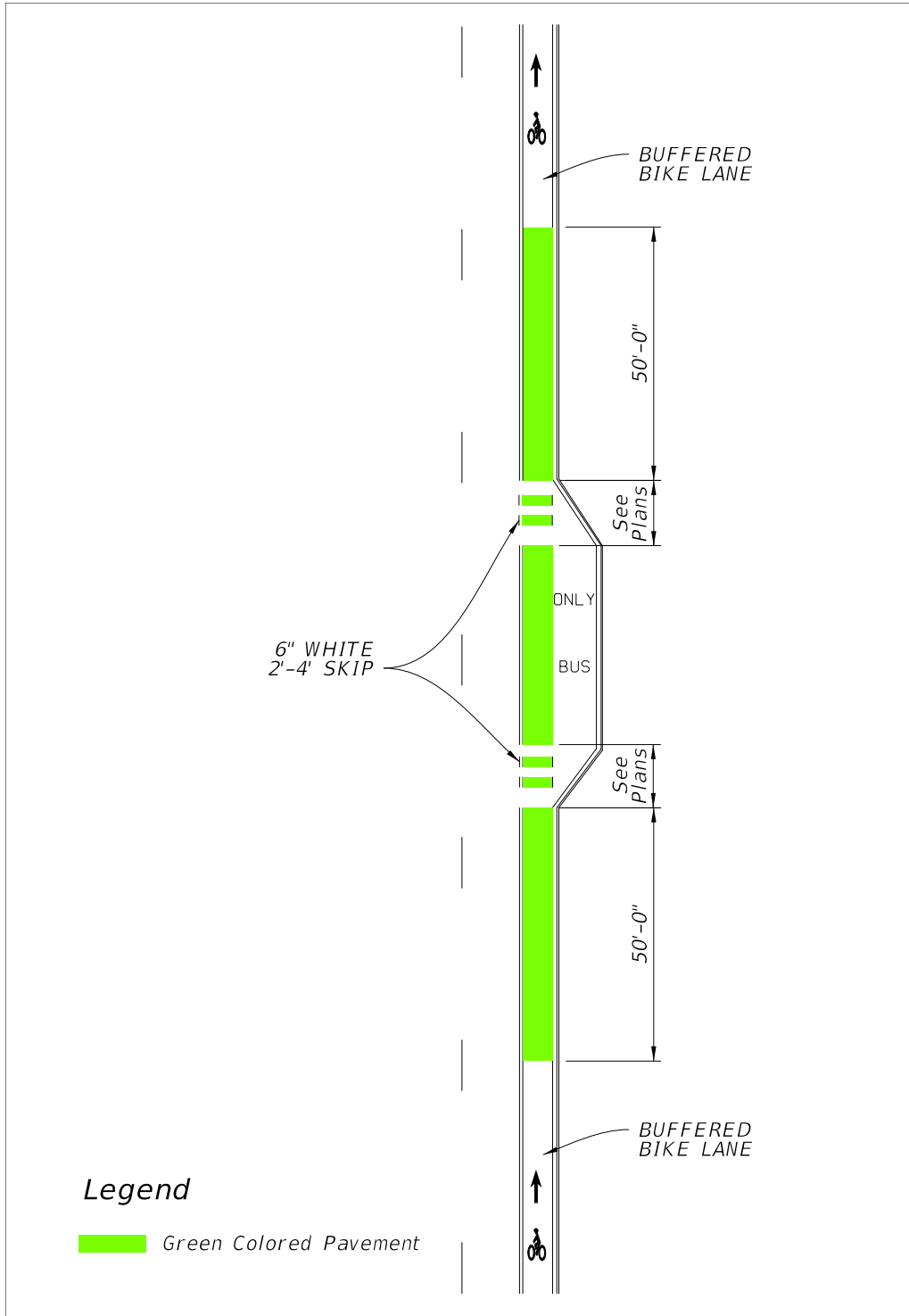

Figure 8.4.5 Bike Lane with Bus Bay



8.4.3 Paved Shoulders

A paved shoulder is a portion of a roadway which has been delineated by edge line striping, and may include bicycle lane pavement markings or signing. In or within 1 mile of an urban area, mark the paved shoulder as a bicycle lane in accordance with **Section 8.4.1**. When used, rumble striping is to be applied to the line dividing the bike lane from the travel lane. For additional information, see **Section 2.3** and **Section 7.6.1.2** of this Volume, and **Design Standards, Index 519** or **D519**. Paved shoulders must be 5 feet in width for new construction and reconstruction projects. An existing paved shoulder of at least 4 feet in width is considered to be a bicycle facility; however a minimum 5-foot clear width between the traveled way and the face of curb, guardrail or other roadside barrier is required.

8.4.4 Wide Curb Lanes

Wide curb lanes are through lanes which provide a minimum of 14 feet in width, which allows most motor vehicles to pass cyclists safely within the travel lane. Wide curb lanes do not meet Department requirements for bicycle facilities on new construction or reconstruction projects. However, in some conditions, such as RRR projects, they may be the only practical option for a bicycle facility.

8.4.5 Shared Lane Markings (Sharrows)

The shared lane marking is an optional pavement marking for shared lane roadways. It may be used to assist bicyclists on a roadway open to bicycle travel where no bicycle lane or paved shoulder exists or is feasible. Shared lane markings should be limited to roadways with a posted speed of 35 mph or less. They are not intended to be placed on all roadways that do not have a marked bike lane, or on shared use paths. Shared lane markings provide guidance to cyclists in their lateral positioning, especially on roadways with on-street parking or lanes that are too narrow to share side by side with a motor vehicle. They also help to discourage wrong way riding and encourage safer passing of bicyclists by motorists. Shared lane markings may be used to identify an alternate route as part of an approved temporary traffic control plan.

Modification for Non-Conventional Projects:

Delete the third sentence of the above paragraph and replace with the following:
Shared lane markings are limited to roadways with a posted speed of 35 mph or less.

Following are conditions where shared lane markings should be considered on the State Highway System:

- In conjunction with on-street parking
- Where forward sight distance is limited due to horizontal or vertical curvature
- Where gaps exist between bicycle facilities or between an existing bicycle facility and an urban center, school, park, or transit hub
- When the roadway has an average bicycle crash history of 3 or more per mile, over a 3 year period

Install shared lane markings in accordance with ***Design Standards, Index 17347*** and the ***MUTCD***.

8.4.6 Bicycle Route Systems

Bicycle routes include roadways or shared use paths designated through signage, pavement markings or mapping. They provide directional and distance information, and aid bicyclists in wayfinding, especially in complex urban locations or along established long distance bicycle routes. Do not terminate bicycle routes at a barrier. Follow the guidance in the ***MUTCD, Part 9*** when including information directing bicyclists around temporary interruptions in a route.

The decision whether to provide bicycle route systems should be based on the suitability of the particular roadway or shared use path for bicycle travel and the need for wayfinding information. Evaluations of suitability should include roadway width, volume, speed, and types of traffic, parking conditions, grade, sight distance, and connectivity to services, significant destinations, and local transit or regional transportation hubs. Other considerations include location and condition of drainage grates, railroad crossings, pavement surface, signals responsive to bicycles, and maintenance schedules. Further guidance on signing bicycle route systems is provided in the ***MUTCD, Part 9***.

8.4.6.1 United States Bicycle Routes

The U.S. Bicycle Route System is a network of bicycle routes that span multiple states and are of national or regional significance. These routes are nominated for national designation by State Departments of Transportation (DOTs), and designated and catalogued by the [American Association of State Highway and Transportation Officials \(AASHTO\)](#).

Florida has adopted a policy entitled [U.S. Numbered Bicycle Routes, Topic No. 000-525-060](#) in support of the national route system.

Table 8.4.1 identifies criteria to use when selecting a route within a USBR corridor. These criteria provide an objective process for evaluating route options, but should be followed by a subjective review of the highest scored candidates to establish the final route. Reflecting on the specific purpose of the corridor can help to narrow final route selection. Route options are scored on a scale from 3 = Fulfills selection criteria to 0 = Does not contribute to meeting selection criteria. NA may be used when the criteria does not apply.

Table 8.4.1 U. S. Bicycle Route Criteria

Macro Criteria	3	2	1	0	NA
Within USBR corridor, with an emphasis on intrinsic scenic and cultural qualities of the corridor itself.					
Provides access to scenic, cultural, historical and recreational destinations. (May not be directly on route but are nearby.)					
Links major metropolitan areas to connect cyclists to transportation hubs or major attractions.					
Provides reasonably direct route in connecting cities or attractions along the corridor.					
Supports natural connections between adjoining states, Canada, or Mexico.					
Includes or intersects major existing and planned bicycle routes (interstate, cross-state, or intrastate) that are suitable for travel by touring bicycles.					
Micro Criteria	3	2	1	0	NA
Meets established state or local design criteria for on-road facilities and shared use paths. (Low volume or low speed roads without specific accommodation can be appropriate. High traffic roads may be necessary as short links.)					
Utilizes already established and successful routes or paths					
Easy to follow with limited turns; is well marked or has easily identified permanent landmarks to enable navigation.					
Connects to at least one neighboring state's USBR or another country's suitable roadway, bicycle route, or trail system.					
Provides access to services and amenities. Daily needs include food, water and overnight accommodations (including camping) at appropriate intervals (40-60 miles). Amenities and services not required daily include restaurants, libraries, and bicycle shops.					
Ferry or shuttle crossings of water bodies or other barriers have regularly scheduled service available to cyclists. An alternate route should be identified for when ferries or shuttles are out of service (seasonal) or when scheduled service is infrequent.					
Considers difficulty of the region's topography, avoiding extreme climbs. Topography considerations should be balanced against scenic values, points of interest, access to services, and route directness.					
Total					

8.5 Drainage and Utility Considerations

Drainage inlets, grates and utility covers are potential problems for bicyclists. When a new roadway is designed, grates and covers should be kept out of bicyclists' expected path. For RRR projects refer to **Section 25.4.19.2** of this volume. Refer to [Section 3.7 Hydraulic Openings and Protective Treatment](#) of the [Department's Drainage Manual](#) and **Design Standards** for further information in selecting appropriate grates and inlet tops.

See **Chapter 4** of this volume for lateral offsets for light poles.

8.6 Shared Use Paths

Shared use paths are paved facilities physically separated from motorized vehicular traffic by an open space or barrier and either within the highway right of way or an independent right of way. Shared use paths are used by bicyclists, pedestrians, skaters, runners and others. Since shared use paths serve as pedestrian facilities, they are required to be accessible. In addition to the requirements of this manual for accessible pedestrian facilities, the bicycle's operating characteristics will govern the design of shared use paths. The term *path* as used in this section refers to these paved shared use paths. An example typical design is provided for guidance in **Volume 2, Exhibit TYP-20**.

8.6.1 Considerations

Shared use paths adjacent to a roadway may be considered if the following conditions are met:

1. The path will be separated from the roadway.
2. There will be few access points or roadways crossing the path.
3. There will be adequate access to local streets and other facilities along the path.
4. There is a commitment to provide path continuity with other bikeways throughout the corridor.

Shared use paths are not replacements for on-street bicycle lanes. Within a roadway right of way, bicycle lanes are the safest, most efficient bicycle facility. When paths are located immediately adjacent to roadways, some operational problems are likely to occur:

1. Paths require one direction of bicycle traffic to ride against motor vehicle traffic, which is contrary to the normal Rules of the Road. Motorists are not in the habit of scanning for traffic from that direction.
2. At path ends, bicyclists riding against traffic will tend to continue to travel on the wrong side of the street, as do bicyclists getting on to a path. Wrong-way travel by bicyclists is a major cause of bicycle/automobile crashes and should be discouraged.
3. Many bicyclists will use the roadway instead of the path because they have found the roadway to be safer, less congested, more convenient, or better maintained.

8.6.2 Widths

The appropriate paved width for a shared use path is dependent upon context, volume and mix of users. Typically, widths range from 10 to 14 feet, with the wider values applicable to areas with high use and/or a wider variety of users (bicyclists, pedestrians, joggers, and skaters). The need to provide for larger emergency or maintenance vehicles or manage steep grades can also affect appropriate width. The minimum width for a two-directional shared use path is 10 feet. [FHWA's Shared Use Path Level of Service Calculator](#) may be used as a guide in determining when a width greater than the minimum might be needed.

Design curb ramps to be the same width as the path. At locations where the path narrows from the typical width warning signs or pavement markings in conformance with the MUTCD should be used.

8.6.3 Cross Slopes

To meet ADA requirements, the maximum cross slope on shared use paths is 2%.

8.6.4 Grades

To meet ADA requirements, the maximum longitudinal grade is 5%. Grades greater than 5% should be considered ramps and designed accordingly. Maximum ramp slopes are 8.33% and can have a maximum rise of 30 inches, with a level landing at least 60 inches in length.

To accommodate bicyclists, grades should not exceed 5%, since steeper grades cause difficulties for many bicyclists. If the terrain makes it necessary to use steeper grades on short sections, the following restrictions are recommended:

Table 8.6.1 Maximum Grade Lengths

Grade (%)	Maximum Length
6%	For up to 800 feet
7%	For up to 400 feet
8%	For up to 300 feet
9%	For up to 200 feet
10%	For up to 100 feet
11+%	For up to 50 feet

NOTE: When using a longer grade, 4 to 6 feet of additional width should be added to the path to allow some bicyclists to dismount and walk their bicycles. Clear distances and sight distances should be adjusted to accommodate longer grades.

Refer to **Section 8.6.9** for controls on grade changes.

8.6.5 Lateral Offset

Provide a minimum 4-foot lateral offset to obstruction on both sides of a shared use path. Maintain a 2-foot wide graded area with a maximum 1:6 slope adjacent to both sides of the path.

Edge drop-offs should be avoided. When drop-offs cannot be avoided they should be shielded as discussed in **Section 8.8**.

See **Figure 8.6.1** in **Section 8.6.13** for lateral offset criteria for signs on shared use paths.

8.6.6 Vertical Clearance

Provide a minimum 8-foot vertical clearance to obstructions. A 10-foot vertical clearance is desirable when equestrians or maintenance and emergency vehicles are to be accommodated. A 10-foot vertical clearance is also desirable for underpasses and tunnels.

Modification for Non-Conventional Projects:

Delete **Section 8.6.6** and replace with the following:

8.6.6 Vertical Clearance

Provide a minimum 8-foot vertical clearance to obstructions. See RFP for additional requirements.

8.6.7 Design Speed

For paths in relatively flat areas (grades less than or equal to 4%), use a design speed of 18 mph. When a downgrade exceeds 4 percent, a design speed of 30 mph should be used.

8.6.8 Horizontal Alignment

8.6.8.1 Minimum Radii

The minimum radius of curvature based upon superelevation for a shared use path is calculated based upon the following formula:

$R = [V^2/15*(e/100 \pm f)]$ where:

R = Minimum radius of curvature (feet)

V = Design speed (mph)

e = rate of bikeway super elevation (percent)

f = coefficient of friction

The effective superelevation is usually limited to the existing 2% cross slope and may be positive or negative. If a transition is needed, then a minimum 75-foot transition should be used. See **Table 8.6.2** for minimum radii for shared use paths. Further information on calculating the minimum radii may be found in the [**AASHTO Guide for the Development of Bicycle Facilities, 2012.**](#)

Table 8.6.2 Minimum Radii for Horizontal Curves on Shared Use Paths

Design Speed	Superelevation	Friction Factor	Minimum Radius (ft.)
18	2%	0.27	74
18	-2%	0.27	86
30	2%	0.21	261
30	-2%	0.21	316

8.6.8.2 Stopping Sight Distance

The minimum stopping sight distances for a shared use path are calculated based upon the following formula:

$$S = \left[\frac{V^2}{(30 \times (f \pm G))} \right] + 3.67V$$

Where:

S = Stopping sight distance (feet)

V = Velocity (mph)

f = coefficient of friction (use 0.16 for typical bike)

G = grade (feet/feet)

The minimum stopping sight distance for a cyclist travelling 18 mph on a level shared use path is 134 feet. Additional values are given in **Table 8.6.3**. For a shared use path the object height is assumed 0.0 feet and the eye height is 4.5 feet. Further information on calculating the minimum stopping sight distances may be found in the **AASHTO Guide for the Development of Bicycle Facilities, 2012**.

Table 8.6.3 Minimum Stopping Sight Distances

MINIMUM STOPPING SIGHT DISTANCE (FEET)														
Design Speed	GRADES													
	-9%	-8%	-7%	-6%	-5%	-4%	-3%	3%	4%	5%	6%	7%	8%	9%
18 MPH	Use 30 MPH Values					156	149	123	120	118	115	113	111	109
30 MPH	539	485	444	410	383	Use 18 MPH Values								

8.6.9 Vertical Alignment

The minimum length of vertical curve necessary to provide minimum stopping sight distance at various speeds on crest vertical curves is selected by using the formula listed below:

When $S > L$: $L = 2S - (900 / A)$ $L = \text{Min. Length of Vertical Curve (ft.)}$

$A = \text{Algebraic Grade Difference (\%)}$

When $S < L$: $L = AS^2 / 900$ $S = \text{Stopping Sight Distance (ft.)}$

8.6.10 Separation between Shared Use Path and Roadway

Provide a separation between a shared use path and the roadway when they are located adjacent to each other. This demonstrates to both path users and motorists that the shared use path is a separate facility. Minimum separation is as follows:

- On low speed (45 mph or less) flush shoulder roadways the inside edge of the path is to be at least 5 feet from the edge of the paved shoulder.
- On high speed (greater than 45 mph) flush shoulder roadways the inside edge of the path is to be at least 5 feet from the shoulder break.
- On curbed roadways the edge of the path is to be at least 4 feet from the back of curb, with consideration of other roadside obstructions (e.g. signs and light poles).

8.6.11 Path Railings

Provide railings or fences as indicated in **Section 8.8**.

8.6.12 Lighting

Lighting for shared use paths is important and should be considered where riding at night is expected, such as paths serving college students or commuters. Lighting should also be considered through underpasses or tunnels. Lighting standards are provided in **Table 7.3.1** of this Volume.

8.6.13 Signing, Pavement Marking, and Signalization

The **MUTCD** regulates the design and use of all traffic control devices on shared use paths. **Figure 8.6.1** provides the minimum criteria for the placement of signs along or over a shared use path. Signs on shared use paths should follow the dimensions provided in **Table 9B-1 Bicycle Sign and Plaque Sizes, MUTCD**. Guidance on the placement of stop or yield lines and crosswalks on roadways intersecting with shared use paths is provided in the **MUTCD, Part 3**.

Figure 8.6.1 Sign Placement on Shared Use Paths

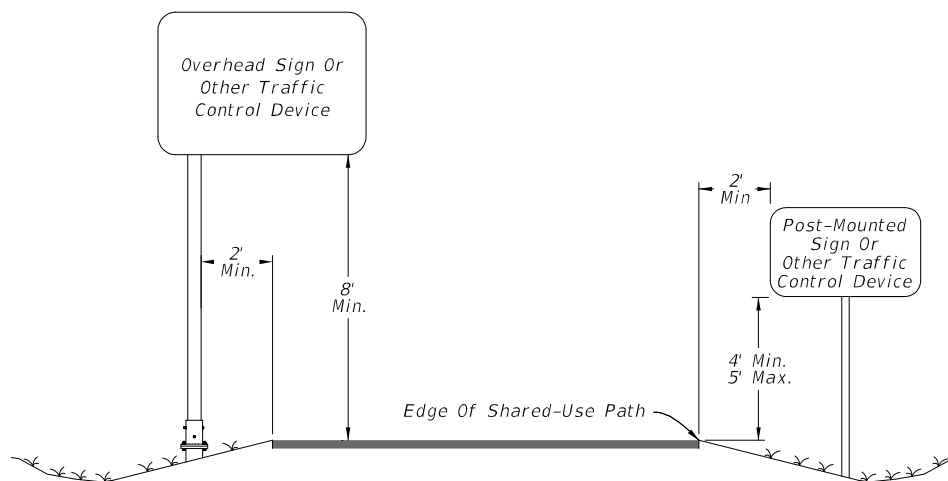

Consult the **Design Standards** and **MUTCD** for all signage, pavement markings and signals, especially at railroad crossings and roadway intersections.

8.7 Bridges, Overpasses, and Underpasses

A bridge, overpass, or underpass may be necessary to provide pedestrian and bicycle continuity to sidewalks, bicycle lanes and shared use paths. Provide accommodations for bicyclists on pedestrian bridges; i.e., provide an alternative to stairs.

8.7.1 Design Criteria

Design overpasses and bridges in accordance with the criteria established below:

1. ***FDOT Structures Design Guidelines – Chapter 10.***
2. ***Section 8.2*** of this Volume.
3. The minimum clear width for new FDOT pedestrian bridges is:
 - a. On a pedestrian structure - 8 feet.
 - b. On a shared use path structure - 12 feet.
 - c. If the approach sidewalk or path is wider than these minimums, the clear width of the structure should match the approach width. The desirable clear width should include an additional 2-foot wide clear area on each side.
4. Vertical clearance criteria is found in ***Table 2.10.1*** of this Volume. Account for future widening of the roadway below when determining required lateral offset.
5. Ramps
 - a. Comply with ADA requirements. Additional information is provided on the website: [***Production Support Office - Accessibility Issues \(ADA\) Website***](#)
 - b. Ramps (routes with grades >5%) should be provided at all pedestrian separation structures. Consider providing stairways in addition to ramps.
 - c. Design ramps with the least possible grade, but in no case more than 8.33% with a maximum 30-inch rise. Provide level landings that are 5-feet long at the top, intermediate, and bottom portions of the ramp.
 - d. Provide full-length pedestrian ADA handrails on both sides of pedestrian ramps.
6. Railing and Fencing
 - a. Provide railing and fencing options in accordance with the [***SDG Chapter 10.***](#)
 - b. Refer to ***Chapter 4, Figures 4.4.9*** and ***4.4.10*** of this Volume for vehicular fencing options.
 - c. Provide full or partial screening on pedestrian bridges crossing FDOT right of way in order to reduce the likelihood of objects being dropped or thrown onto

the roadway below. See **Figure 8.7.1** for example of full screening.

- d. Pedestrian bridges on FDOT right of way but not crossing FDOT right of way are not required to be screened.
- e. Check with local authorities for guidance on screening for FDOT pedestrian bridges crossing local rights of way.
- f. The use of chain link fence on ramps of the pedestrian bridges will be determined on a project-by-project basis.

Modification for Non-Conventional Projects:

Add the following sentence:

- g. When fencing is required, the limits of fencing is from the beginning of the approach slab at Begin Bridge to the end of the approach slab at End Bridge, unless otherwise indicated in the RFP.

See **Chapter 26** of this Volume for review requirements based on pedestrian bridge structure category.

Pedestrian underpasses are generally undesirable; however, if one is provided, the geometrics and lighting requirements should be discussed with the Department Project Manager and the District Pedestrian/Bicycle Coordinator. Local law enforcement personnel may need to be consulted to assure public safety, emergency accessibility and other desirable features.

Figure 8.7.1 Pedestrian/Shared Use Path Bridge Typical Section

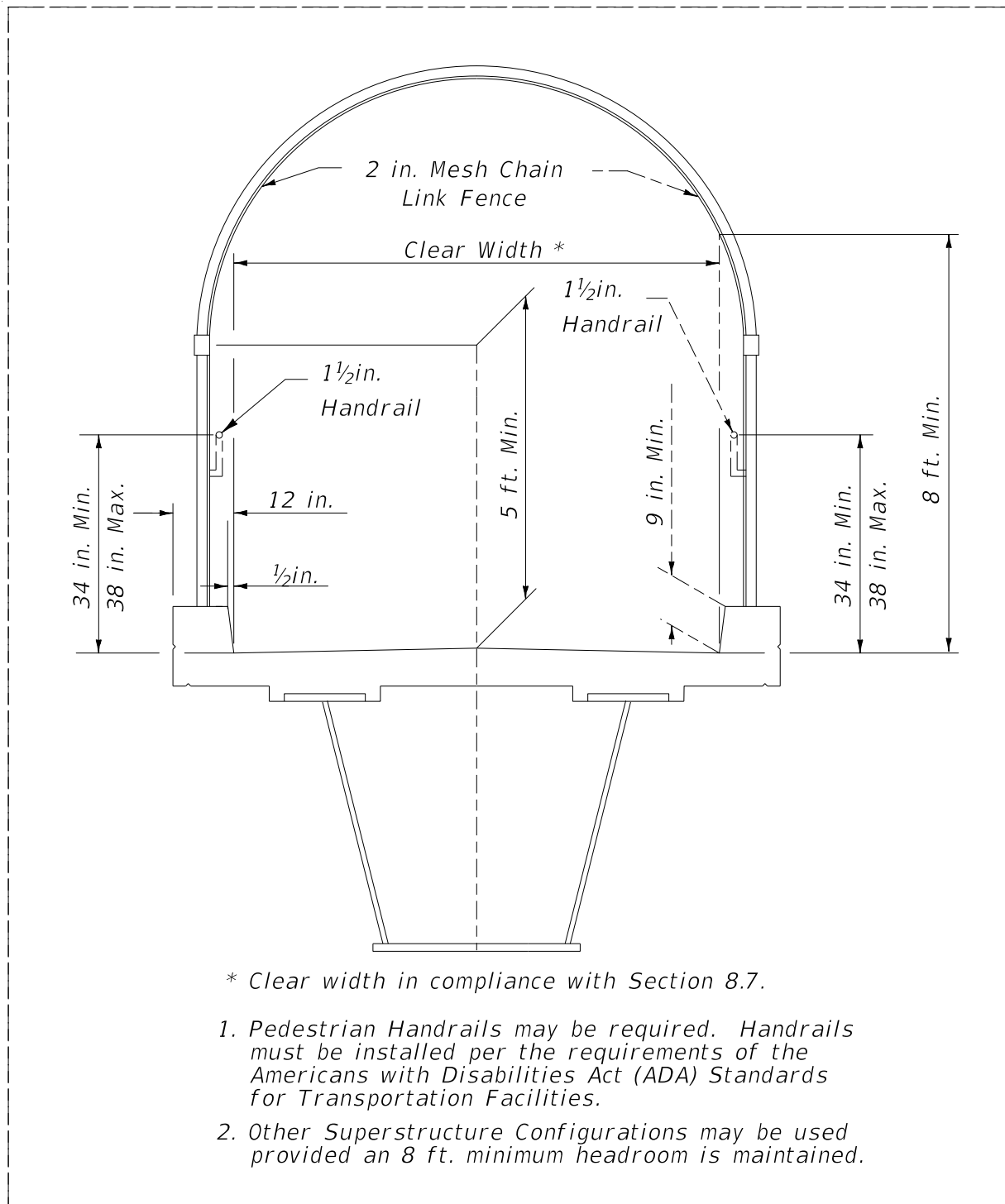

8.7.2 Prefabricated Steel Truss Bridges on FDOT Projects

In many situations it makes good engineering and economic sense to utilize prefabricated steel truss bridges for pedestrian crossings. These bridges can be stand-alone structures or a hybrid structure with adjoining spans of other types (FIB, deck slab, steel I-girder, etc.). The provisions of this article apply only to the spans on a bridge that are comprised of prefabricated steel trusses. The term steel truss bridge as applied in this article refers only to stand-alone steel truss structures or to the steel truss spans of a hybrid bridge structure.

The Department may elect to use prefabricated truss bridges on FDOT projects if the following conditions are met:

1. The steel truss span lies within a tangent horizontal alignment.
2. The maximum length of the steel truss span does not exceed 200 feet.
3. The width of the steel truss span is constant.
4. The steel truss span supports have a skew angle not to exceed 20°.

When these criteria are not met provide a complete set of bridge details in the plans.

Modification for Non-Conventional Projects:

Delete **PPM** 8.7.2 and replace with the following:

8.7.2 Prefabricated Steel Truss Bridges on FDOT Projects

Prefabricated steel truss bridges can be stand-alone structures or a hybrid structure with adjoining spans of other types (FIB, deck slab, steel I-girder, etc.). The provisions of this article apply only to the spans on a bridge that are comprised of prefabricated steel trusses. The term steel truss bridge as applied in this article refers only to stand-alone steel truss structures or to the steel truss spans of a hybrid bridge structure.

See RFP for requirements.

8.7.2.1 Qualification of Prefabricated Steel Truss Pedestrian Bridge Producers

Use prefabricated steel truss pedestrian bridges from providers included on the Department's List of Qualified Metal Fabrication Facilities. For information on the facility qualification process see **Articles 11.1.5** and **11.1.6** of the [FDOT Materials Manual](#).

8.7.2.2 Design and Detailing Responsibilities

The project Engineer of Record (EOR) is responsible for the design and detailing of the steel truss bridge substructure and foundation including end bents, piers, pile foundations, and/or spread footings. The project EOR is also responsible for the design and detailing of approach structures (non-steel truss bridge spans, walls, ramps, steps, approach slabs, etc.).

The Contractor's EOR is responsible for the design and detailing of the steel truss bridge superstructure including trusses, deck, bridge railing, floor beams, bridge joints, bearing assemblies and anchor bolts.

Modification for Non-Conventional Projects:

Delete **PPM** 8.7.2.2 and replace with the following:

8.7.2.2 Design and Detailing Responsibilities

The Engineer of Record (EOR) is responsible for the design and detailing of the steel truss bridge foundation, substructure and superstructure. The EOR is also responsible for design and detailing of approach structures (non-steel truss bridge spans, walls, ramps, steps, approach slabs, etc.). The steel truss bridge superstructure including trusses, deck, bridge railing, floor beams, bridge joints, bearing assemblies and anchor bolts must be included as part of the superstructure component submittal.

8.7.2.3 Plans Development

To allow equal opportunity for all qualified pedestrian bridge producers to participate, the pedestrian bridge plans should have the flexibility to accommodate multiple alternate superstructure designs. When a prefabricated steel truss pedestrian bridge is warranted, adhere to the following procedure when developing the plans:

1. Using **Figures 8.7.2, 8.7.3, and 8.7.4**, coordinate with the District Project Manager to select allowable truss configurations, truss member shapes, and bridge cross sections. A box truss bridge cross-section is required for spans greater than 150 feet.

If project specific aesthetic requirements warrant the use of truss configurations not included in **Figure 8.7.2** the project EOR can specify additional truss configurations. However, a minimum of two steel truss pedestrian bridge producers must be capable of satisfying the aesthetic requirements.

2. Develop a Plan and Elevation sheet and Bridge Typical Section to be submitted with the BDR/30% plans.
3. After the BDR/30% plans have been approved, send out a Prefabricated Pedestrian Bridge Invitation to Participate (ITP) to all prefabricated pedestrian steel truss bridge producers on the Department's List of Qualified Fabrication Facilities. Send the ITP through registered mail with return receipt to confirm delivery. Contact information for all qualified producers can be found at the following web address:

<http://www.dot.state.fl.us/statematerialsoffice/quality/programs/qualitycontrol/materialslistings/postjuly2002.shtm>

The ITP is intended to solicit qualified producers for information required to design the foundation and substructure of the steel truss pedestrian bridge. The ITP cover letter should contain the following elements with links to websites as appropriate and applicable:

- Introduction with brief project description
- Project Requirements
 - Design Specifications Requirements
 - Construction Specifications Requirements
 - Design Standards Requirements
 - Bridge Typical Section
 - Allowable Truss Options
 - Painting Requirements

- Pedestrian Fence/Railing Requirements
- Vehicular Loading Requirements
- Project Specific Aesthetic Requirements
- Project Geometry including Vertical Clearance Requirements for Each Span
- Participation Requirements
- Submittal Requirements

Include the following items in the ITP package:

- Hard copy:
 - Invitation to Participate Cover Letter
 - Project Location Map
 - Plan and Elevation
 - Bridge Typical Section and Pedestrian Fence Concept
 - Pedestrian Bridge Data Sheet
- Electronic files:
 - PDF file with all of the above
 - Pedestrian Bridge Data Sheet in CADD format

For a sample Prefabricated Pedestrian Bridge ITP complete with all hard copy attachments see **Exhibit 8-A**. To aid plan development CADD cells for the Pedestrian Bridge Data Sheet and Plan and Elevation sheet (2 of 2) are available in the FDOT Structures Cell Library. For the current FDOT Engineering/CADD Systems Software downloads follow the link below:

<http://www.dot.state.fl.us/ecso/downloads/software/software.shtm>

4. Upon delivery the pedestrian bridge, producers must acknowledge receipt of the ITP package.
5. In order to be eligible to participate in the project the pedestrian bridge producers must provide a completed Pedestrian Bridge Data Sheet as outlined in the ITP on or before the specified due date (prior to 60% plans submittal). The completed Data Sheets must be electronically signed and sealed by the pedestrian bridge producer's EOR for inclusion in the final plan set.

The project EOR assigns a unique sheet number to each data sheet. The sheet numbers will be identified with the prefix BP (e.g., BP-1, BP-2, BP-#) and the data sheets will be placed at the end of the numbered sequence of the bridge plans. This will allow the Pedestrian Bridge Data Sheets to have independent sheet numbers as plan development progresses.

6. After all ITP responses are received the project EOR must design and detail the foundation and substructure to accommodate the superstructure designs of all eligible pedestrian bridge producers. The design must envelope the most extreme loading conditions and geometry of all alternates.
7. A Public Interest Finding is required for Federal Aid projects when only one Interest for Participation letter is received.
8. Include the following notes in the plans:
 - Eligible Steel Truss Pedestrian Bridge Producers

Included in this plan set are Pedestrian Bridge Data Sheets submitted by bridge producers eligible to participate in this project. Producers who failed to submit a data sheet are excluded from participation. No Cost Savings Initiative Proposal will be accepted for the truss superstructure portion of the project. Contact information for the eligible producers is included in the data sheet.
 - Shop Drawing Submittal

Prior to fabrication the Contractor's EOR must submit signed and sealed superstructure shop drawings, technical specifications, and design calculations to the Engineer for review and approval.
9. Include the following Pay Item note in the plans:
 - Prefabricated Steel Truss Pedestrian Bridge Span

Prefabricated Steel Truss Pedestrian Bridge Span will be paid for at the contract unit price per square foot of deck area under Pay Item No. 460-7 Prefabricated Steel Truss Pedestrian Bridge, SF. This pay item includes furnishing and installing the prefabricated steel truss pedestrian bridge superstructure including steel trusses, floor system, deck, bearing assemblies, deck joints, and bridge railing/fencing. Payment for this pay item is based on the plan quantity. Portions of pedestrian bridge outside the limits of the steel truss span are paid for under individual pay items.

Figure 8.7.2 Prefabricated Pedestrian Bridge Standard Truss Configurations

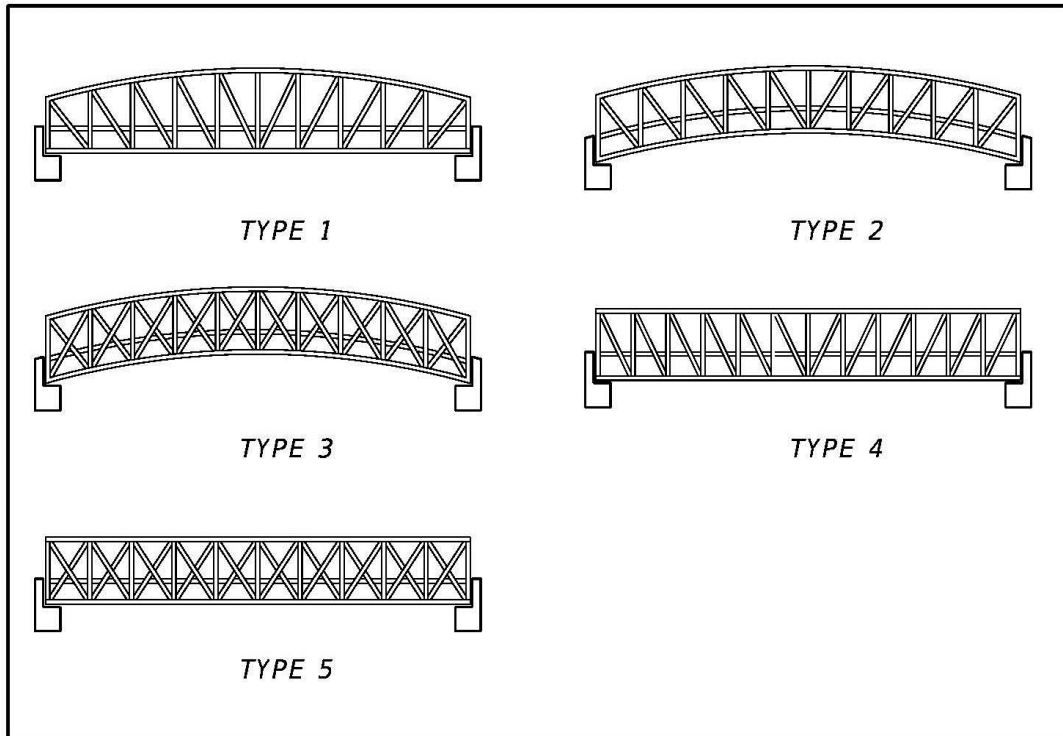

Figure 8.7.3 Prefabricated Pedestrian Bridge Standard Truss Member Shapes

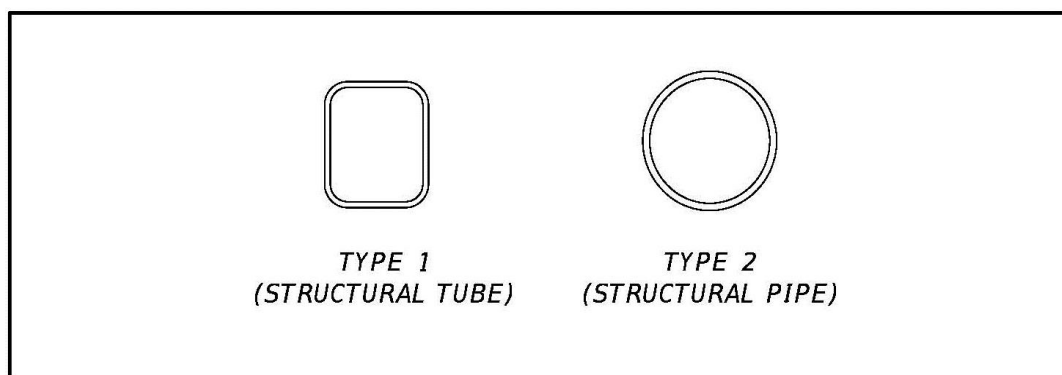
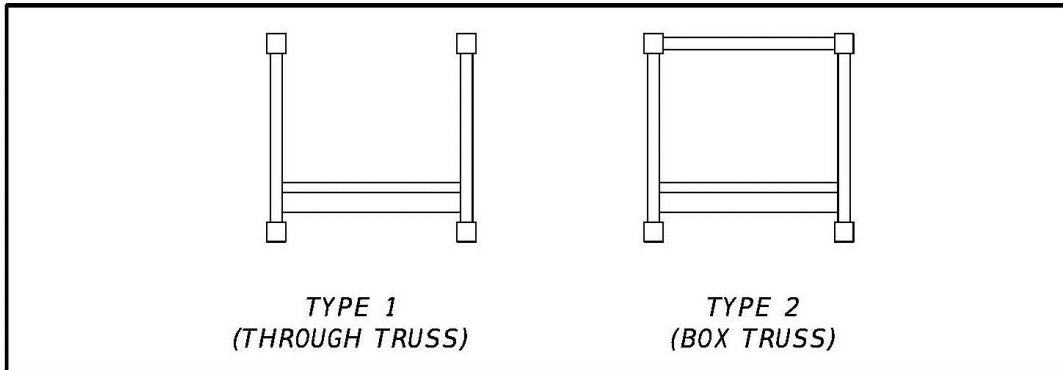

Figure 8.7.4 Prefabricated Pedestrian Standard Bridge Cross-Sections



Modification for Non-Conventional Projects:

Delete **PPM** 8.7.2.3 and see RFP for requirements.

8.8 Drop-off Hazards for Pedestrians and Bicyclists

Drop-off hazards are defined as steep or abrupt downward slopes that can be perilous to pedestrians and cyclists. Shield any drop-off determined to be a hazard using railing or fencing as described in this section. Pedestrian/Bicycle Picket Railings (***Design Standards, Index 850 or 860 Series***) and the Pipe Guiderail (***Design Standards, Index 870 and 880***) have not been crash tested, and are not to be placed within the lateral offset of the roadway.

The standard height for pedestrian/bicycle railing is 42 inches. Provide a 48 inch tall pedestrian/bicycle railing when all three of the following conditions exist:

1. Bicyclists are permitted to travel within 3 feet of the railing.
2. The path is on a downward grade steeper than 5%.
3. There is a horizontal curve having a radius less than that specified for the design speed of the bicycle facility. Taller railing should not extend more than 20 feet beyond the point of tangency of the horizontal curve.

The following guidelines will be useful in standardizing the identification and treatment of drop-off hazards for pedestrians and cyclists.

There are two cases that require shielding as shown in ***Figure 8.8.1***. Depending on the depth of the drop-off and severity of the conditions below, shielding may be necessary for cases other than described above.

However, in determining if shielding a drop-off hazard would be feasible for protecting pedestrians and cyclists, the following should be considered:

1. The engineer should consult the District Bicycle/Pedestrian Coordinator regarding pedestrian and cyclist traffic and their routes.
2. Installing fencing or railings are two ways to shield the drop-offs. Fencing is generally intended for use in rural areas along paths and trails. Railing is generally intended for urbanized areas, locations attaching to bridge rail or along concrete walkways. Pedestrian/Bicycle Railings are adequate for shielding all drop-offs but are generally intended for use on drop-offs greater than 60 inches. Pipe Guiderail is adequate for shielding drop-offs which are 60 inches or less.
3. Along continuous sections where the drop-off varies above and below the 60 inch threshold, for uniformity the engineer may consider using only one of the railing types adequate for shielding all drop-offs.

4. Care should be taken when using railing or fencing near intersections or driveways as they could obstruct the driver's line of sight. To reduce the need for railings, as a sidewalk or shared use path approaches an intersection, consider extending cross drains and side drains to minimize drop-offs.

Where Pedestrian/Bicycle Railing is used, the Department will cover the cost only for standard galvanized steel or standard aluminum railing. If the Local Agency desires a painted railing, they are required to provide the additional funding and commit to cover the maintenance cost. The Department will also only cover the cost of the standard Infill Panel Types shown in the **Design Standards**. If the Local Agency desires a railing having Custom Infill Panels which increases the cost over standard infill panels, they are required to provide the additional funding to cover this initial premium cost. In addition, a maintenance agreement will be needed to address the responsibilities associated with maintaining Custom Infill Panels.

Modification for Non-Conventional Projects:

Delete the above paragraph. See the RFP for requirements.

Figure 8.8.1 Drop-Off Hazards for Pedestrians and Bicyclists

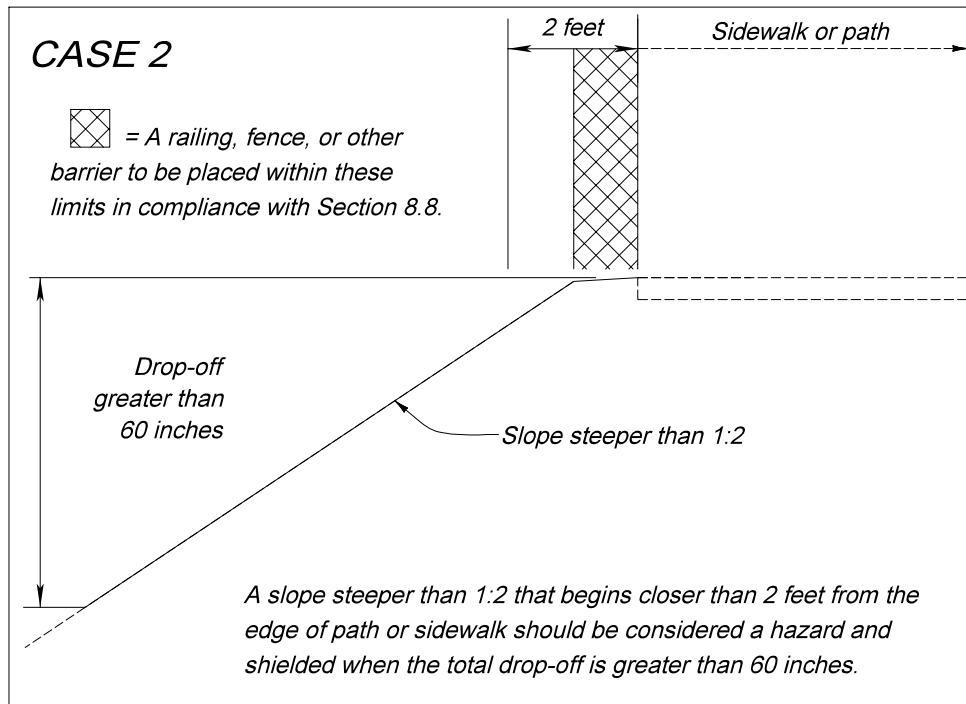
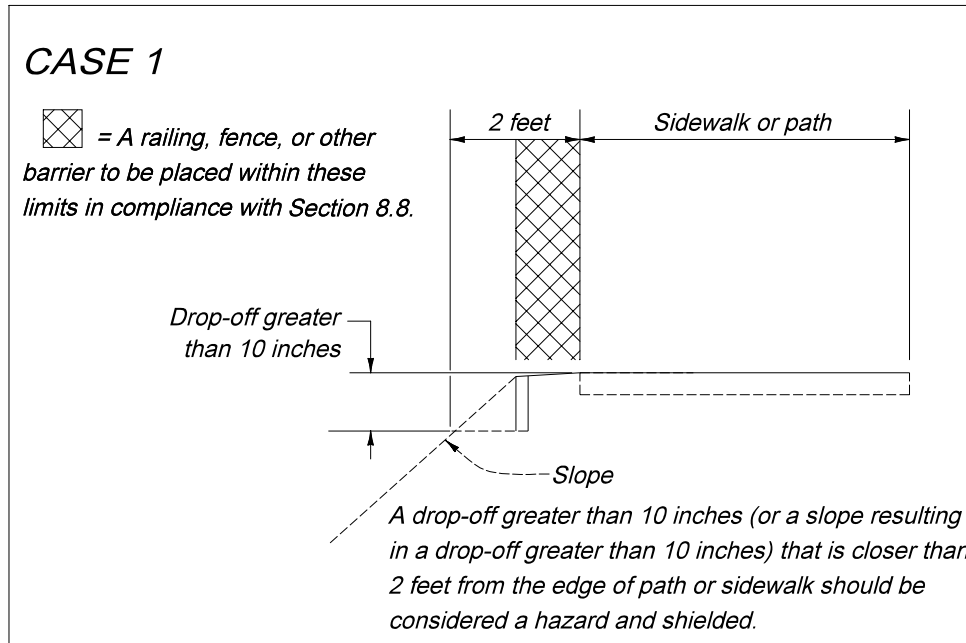

8.9 Strategic Intermodal System Highway Component Standards and Criteria

Department Procedure No. 525-030-260, Strategic Intermodal System (SIS) Highway Component Standards and Criteria, relates the SIS Highway Component to the design standards, design criteria, level of service standards, and processes used by the Department. The Procedure provides guidance to Metropolitan Planning Organizations (MPOs) for the development of transportation plans and programs for metropolitan areas that provide for the operation and integrated management of transportation systems and facilities, including bike and pedestrian facilities.

[***Florida Statute 316.091***](#) provides guidance for travel by bicyclists and pedestrians on limited access facilities. The ***Statute*** establishes a pilot program to allow travel by bicyclists on certain facilities.

8.10 Public Transit Facilities

When a project includes a public transit route, curb side and street side transit facilities for bus stops should be considered in the roadway design process.

The FDOT [***Accessing Transit: Version III, 2013 Design Handbook for Florida Bus Passenger Facilities***](#) provides guidance relating to provisions for curb side and street side facilities. Refer to ***Chapter 4, Table 4.2.3*** of this Volume for criteria on the placement of shelters and benches. Coordination with the District Modal Development Office and/or local public transit provider(s) is necessary in developing the plans.

Additional guidance on the design of transit facilities is available in the 2014 AASHTO publication, ***A Guide for Geometric Design of Transit Facilities on Highways and Streets, 1st Edition***. This guide provides a comprehensive reference of current practice in the geometric design of transit facilities on streets and highways, including local buses, express buses, and bus rapid transit operating in mixed traffic, bus lanes, and high-occupancy vehicle lanes, as well as bus-only roads within street and freeway environments. It also covers streetcars and Light Rail Transit running in mixed traffic and transit lanes, and within medians along arterial roadways. The guide is designed for use by public agencies, practitioners, and developers in need of basic information about planning, locating, sizing, designing, and implementing transit facilities along roadways.

8.10.1 Boarding and Alighting Areas

Boarding and alighting areas help to create an accessible bus stop by providing a raised platform that is compatible with a bus that kneels or extends a ramp. A boarding and alighting area must have a firm, stable, and slip-resistant surface with a minimum clear length of 8 feet (measured perpendicular to the curb or roadway edge), and a minimum clear width of 5 feet (measured parallel to the roadway). Firm, stable, and slip resistant boarding and alighting areas are required if amenities such as benches or shelters are added to a bus stop. Boarding and alighting areas are not required at bus stops on flush shoulder roadways where only a bus stop sign is provided. Coordinate with the appropriate public transit provider(s) to determine compatibility with equipment and transit vehicles.

Modification for Non-Conventional Projects:

Delete the last sentence above and see the RFP for requirements.

The slope of the boarding and alighting area parallel to the roadway should be the same as the roadway. For drainage purposes, a maximum slope of 1:50 (2%) (measured perpendicular to the roadway) is allowed.

On flush shoulder roadways, the boarding and alighting area should be constructed at the shoulder break (or edge of shoulder pavement on roadways with a design speed of 45 mph or less) to create an accessible bus stop, as shown in **Figures 8.10.1** and **8.10.2**. The raised area provides a landing that is compatible with a bus that kneels or extends a ramp with a slope of 1:6 or less. Bus stops should be located in close proximity to existing intersections, and with sidewalk access. The boarding and alighting area is to:

- (1) Use a Type E curb and gutter (5" curb height)
- (2) Be connected to the sidewalk along the roadway; or to the roadway when no sidewalk is present

A sidewalk and/or ramp provided with the boarding and alighting area must be a minimum of 5 feet in width; and the ramp must not exceed a slope of 1:12. A detectable warning is required where a sidewalk associated with a boarding and alighting area connects to the roadway at grade. Except for the area adjacent to the 5-inch curb, the areas surrounding the boarding and alighting area must be flush with the adjacent shoulder and side slopes and designed to be traversable by errant vehicles. On the upstream side of the landing, a maximum slope of 1:12 should be provided, and may be grass or a hardened surface. The boarding and alighting area (and ramp and level landing if needed) are to be constructed with 6-inch thick concrete.

Figure 8.10.1 Accessible Boarding and Alighting Area for Flush Shoulder Roadways with Connection to Roadway

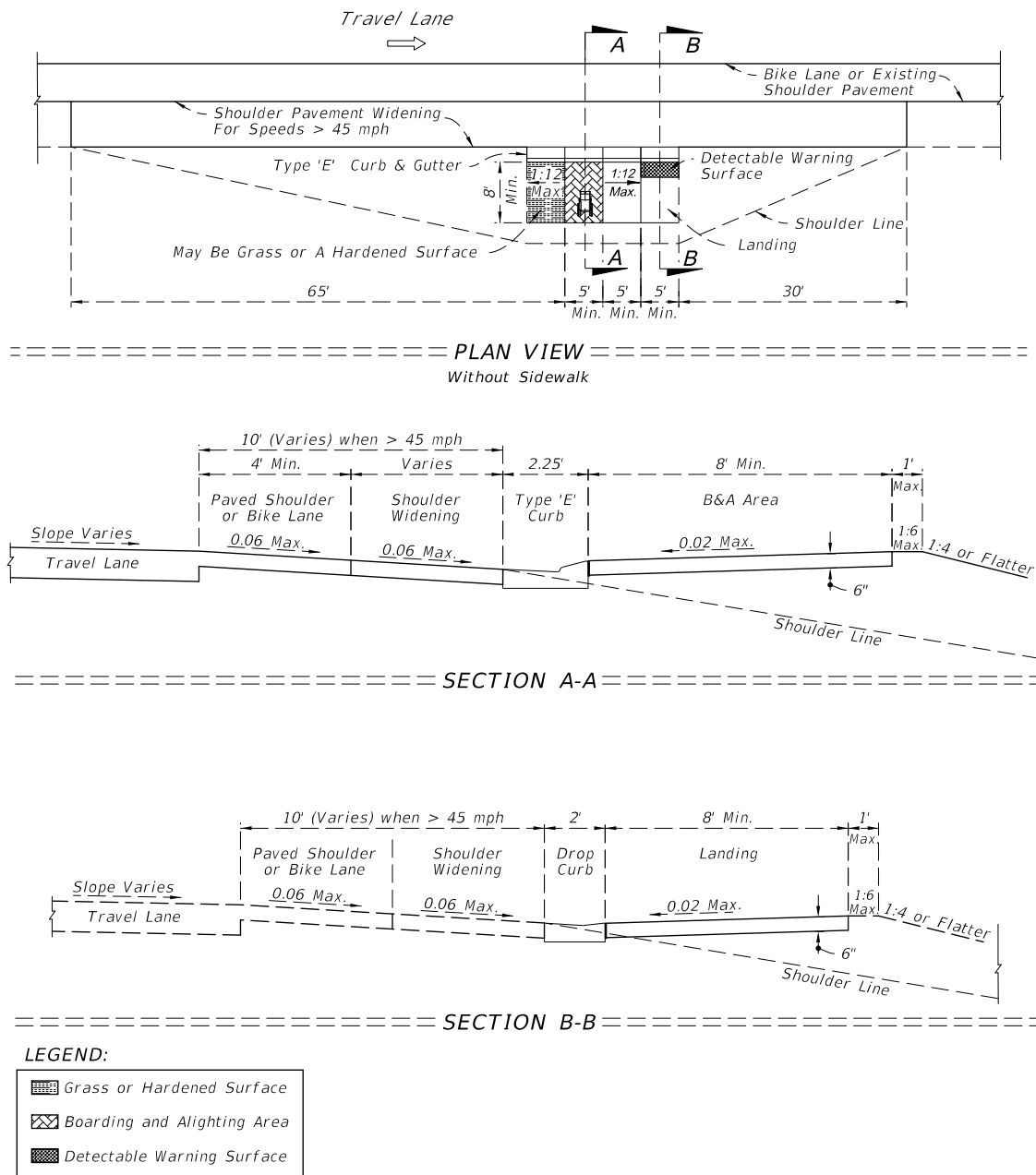
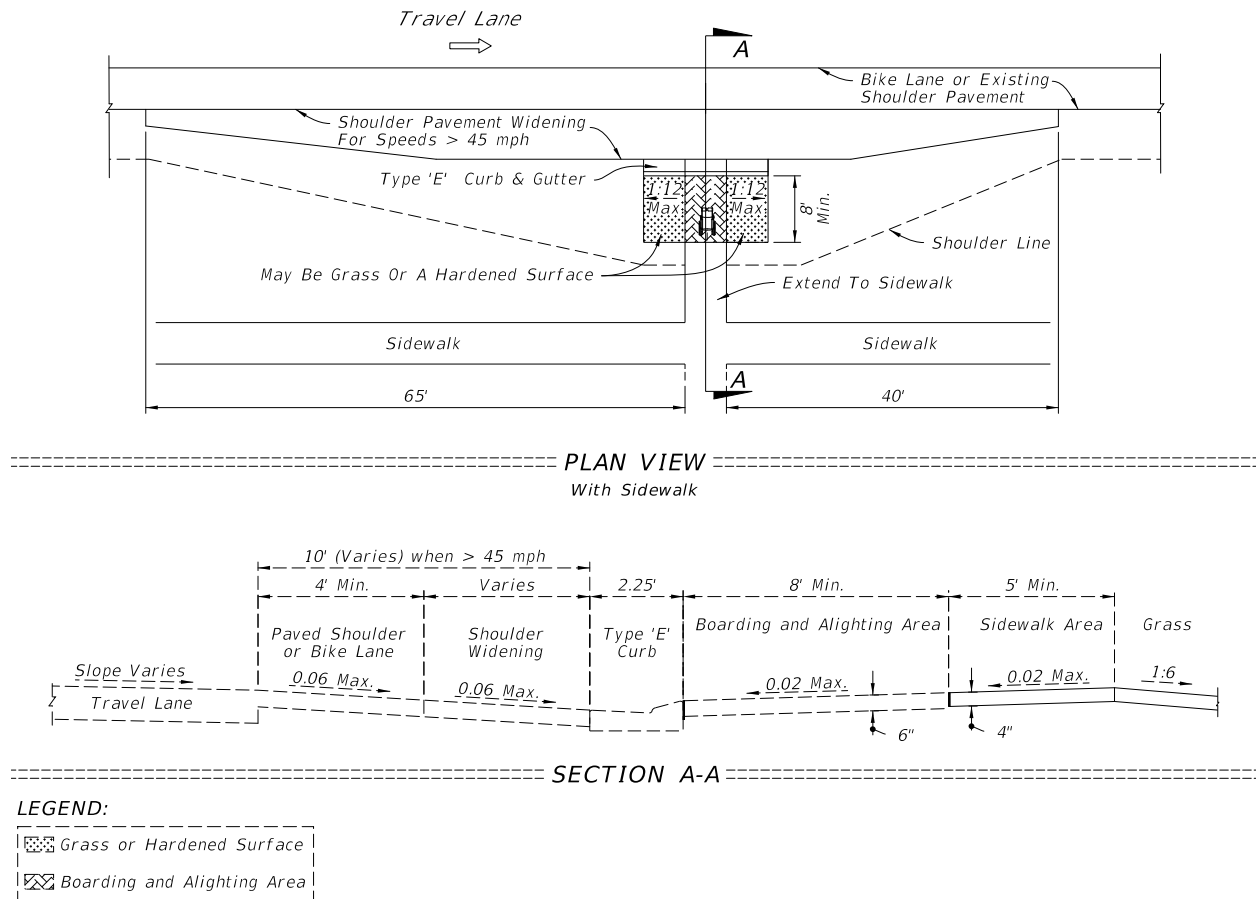

Figure 8.10.2 Accessible Boarding and Alighting Area for Flush Shoulder Roadways with Connection to Sidewalk



8.10.2 Street-Side Facilities

Bus stop locations can be categorized as far-side, near-side and midblock stops. Bus stops may be designed with a bus bay or pullout to allow buses to pick up and discharge passengers in an area outside of the travel lane. This design feature allows traffic to flow freely without the obstruction of stopped buses. See **Figure 8.10.3** for typical details for the bus stop and bus bay categories. **Chapter 2** of the [Accessing Transit Handbook](#) provides additional information for each facility. The greater distance placed between waiting passengers and the travel lane increases safety at a stop. Bus bays are encouraged on roadways with high operating speeds, such as roads that are part of the Urban Principal Arterial System. For a particular bus stop, a high frequency of crashes involving buses is a good indicator for the need of a bus bay. Bus bays are classified as closed, open or bulbs. Illustrations for various bus bay configurations are provided in the **Accessing Transit Handbook** on the Public Transit Office website.

At a specific location, a balance must be obtained based on the designer's judgment and input from the applicable transit agencies. In locations where the traffic volumes exceed 1,000 vehicles per hour per lane, it is difficult to maneuver the bus into the bay and back into the travel lane. Incorporating an acceleration distance, signal priority, or a far-side (rather than near-side or midblock) placement, are potential solutions when traffic volumes exceed 1,000 vehicles per hour per lane.

The total length of the bus bay should allow room for an entrance taper, a stopping area, and an exit taper as a minimum. However, in some cases it may be appropriate to consider providing acceleration and deceleration lanes depending on the volume and speed of the through traffic. This decision should be based upon site specific conditions. **Accessing Transit Handbook** provides detailed bus bay dimensions for consideration when right of way is unlimited and access points are limited.

8.10.3 Exclusive Transit Running Ways

The [Typical Sections for Exclusive Transit Running Ways](#) is a guide not a standard. This guide is intended to be a starting point for designing exclusive transit running ways. Case-by-case evaluation of sites and corridors is essential in producing design drawings that are feasible and effective.

This guide presents conceptual typical sections for exclusive transit running ways that may see application in Florida. Typical section elements, general dimensions, analysis considerations, and intersection operations considerations are identified for the following scenarios:

- Concurrent flow curb bus lanes
- Concurrent flow median bus lanes
- Contraflow bus lane on a one-way street
- Contraflow bus lane on a two-way street
- At-grade two-way busway on a two-way street
- At-grade reversible one-lane median busway on a two-way street
- At-grade exclusive busway in roadway right-of-way
- At-grade exclusive busway in separate right-of-way
- Exclusive bus street
- Shoulder-running bus lanes on an uninterrupted flow highway.

These scenarios are described in more detail in [Typical Sections for Exclusive Transit Running Ways](#) guide on the Public Transit Office website.

Figure 8.10.3 Bus Stop and Bus Bay Categories

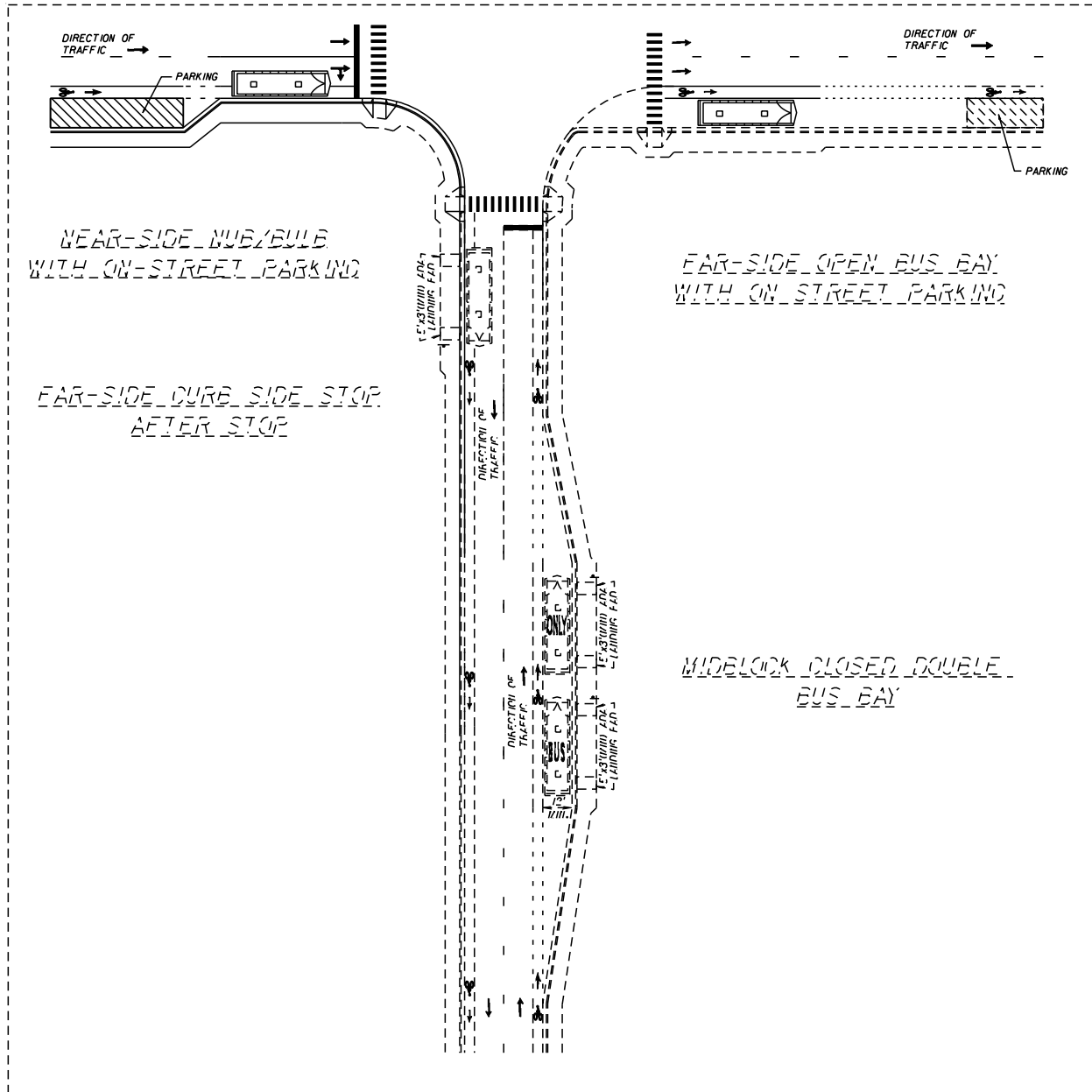

Exhibit 8-A Sample Steel Truss Pedestrian Bridge Plans, Sheet 1 of 8

(prepare on Department letterhead)

FLORIDA DEPARTMENT OF TRANSPORTATION

DISTRICT 3

PREFABRICATED PEDESTRIAN BRIDGE

INVITATION TO PARTICIPATE

Project: CR 250 over Ruby Creek Pedestrian Bridge

Financial Project Number: 217664-1-52-01

Federal Aid Project Number(s): SF2-349-R

Date: March 15, 2011

Introduction:

The Florida Department of Transportation is currently preparing bid documents for the construction of a steel truss pedestrian bridge adjacent to County Road 250 crossing Ruby Creek in Jefferson County. The superstructure of the proposed bridge is to be provided by a steel truss pedestrian bridge producer who is prequalified to work on FDOT projects. This invitation to participate is being sent to all prequalified producers to solicit information needed by the project EOR to design the foundation and substructure of the proposed bridge. Enclosed are the following materials:

- Hard Copy
 - Project location map
 - Bridge Typical Section and Pedestrian Fence Concept
 - Plan and Elevation (P&E) (2 sheets)
 - Pedestrian Bridge Data Sheet
- Electronic
 - PDF file with all of the above
 - Pedestrian Bridge Data Sheet in CADD format

Exhibit 8-A Sample Steel Truss Pedestrian Bridge Plans, Sheet 2 of 8

Project Requirements:

1. Design Specifications: as specified in *FDOT Structures Design Guidelines (SDG) Article 10.4*.
<http://www.dot.state.fl.us/structures/StructuresManual/CurrentRelease/StructuresManual.shtm>
2. Construction Specifications:
FDOT Standard Specifications for Road and Bridge Construction, current edition.
<http://www.dot.state.fl.us/programmanagement/>
3. Design Standards:
FDOT Design Standards, current edition.
<http://www.dot.state.fl.us/rddesign/DesignStandards/Standards.shtm>
4. Allowable Truss Options: All allowable Truss options are indicated on P&E sheet 2 of 2 (Attached).
5. Paint: Paint all structural steel in accordance with *Sections 560* and *975* of the *Specifications*. Paint all structural steel with a high performance top coat system. The color of the finish coat must conform to Federal Standard No. 595, Color No. 36622.
6. Pedestrian Fence: Bridge Fence consistent with bridge rail concept and *SDG Article 10.12*.
7. Vehicular Loading: Vehicular Loading per *AASHTO LRFD Guide Specifications* for the Design of Pedestrian Bridges is not required.
8. Geometry: For project geometry see attached P&E sheets.

Participation:

To be eligible to participate on this project pedestrian bridge producers must:

- Acknowledge receipt of this ITP
- Be on the FDOT List of Qualified Fabrication Facilities.
- Submit a response to this ITP on or before June 10, 2011 to the project EOR.

Submittal:

Provide completed pedestrian bridge data sheet as follows:

- Bearing Plate Dimensions Table – for each span provide bearing dimensions as shown to the nearest 1/8th inch.

Exhibit 8-A Sample Steel Truss Pedestrian Bridge Plans, Sheet 3 of 8

- Bearing Plate Locations & Bridge Seat Elevations Table – for each substructure unit provide dimensions as shown to the nearest 1/8th inch and bridge seat elevation to the nearest 0.001 feet.
- Bridge Reactions Table – for each span provide loads as indicated to the nearest 0.1 kip.
- Company Contact Information Table – in the contact information block provide company name, address, contact person, phone number, and e-mail address.
- Florida PE Seal and Signature – provide seal and signature of Florida PE responsible for the work.

Submit response to:

John Doe, PE
XYZ Engineers, Inc.
123 East Main Street
Tampa, Florida 33607

By submitting a response to this invitation to participate the pedestrian bridge producer is agreeing to satisfy all project requirements listed above if selected.

Exhibit 8-A Sample Steel Truss Pedestrian Bridge Plans, Sheet 4 of 8

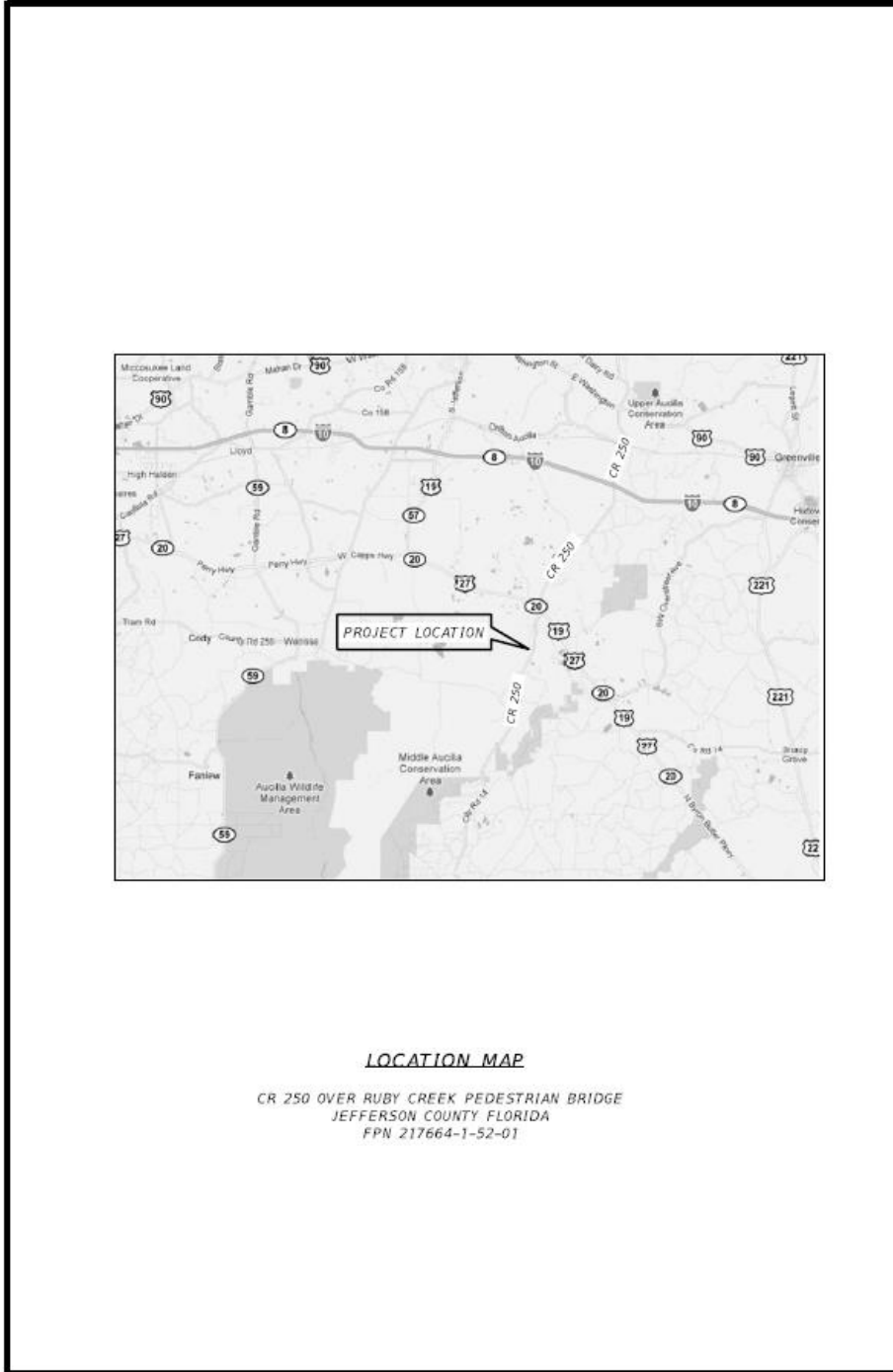

Exhibit 8-A Sample Steel Truss Pedestrian Bridge Plans, Sheet 5 of 8

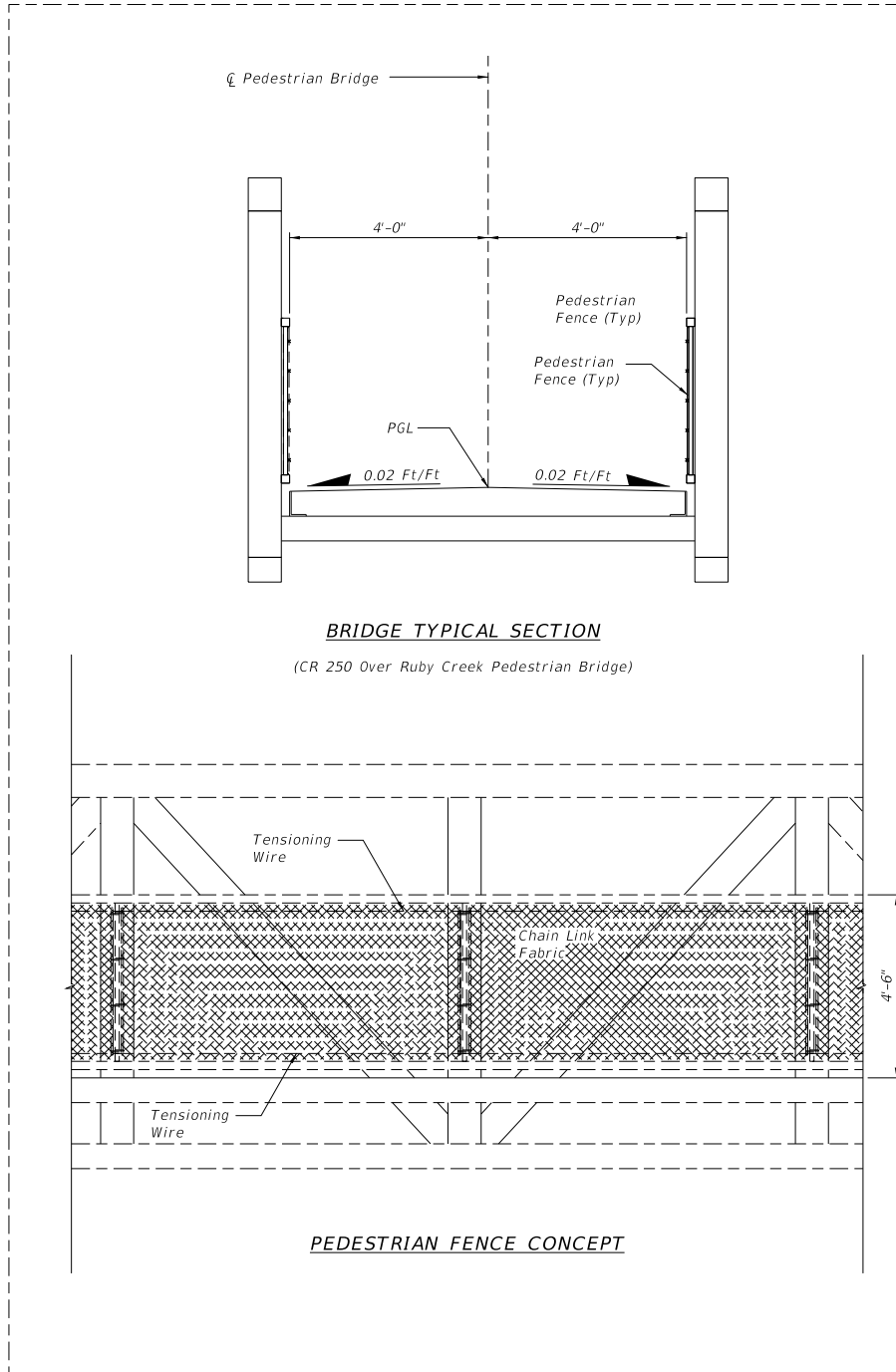

Exhibit 8-A Sample Steel Truss Pedestrian Bridge Plans, Sheet 6 of 8

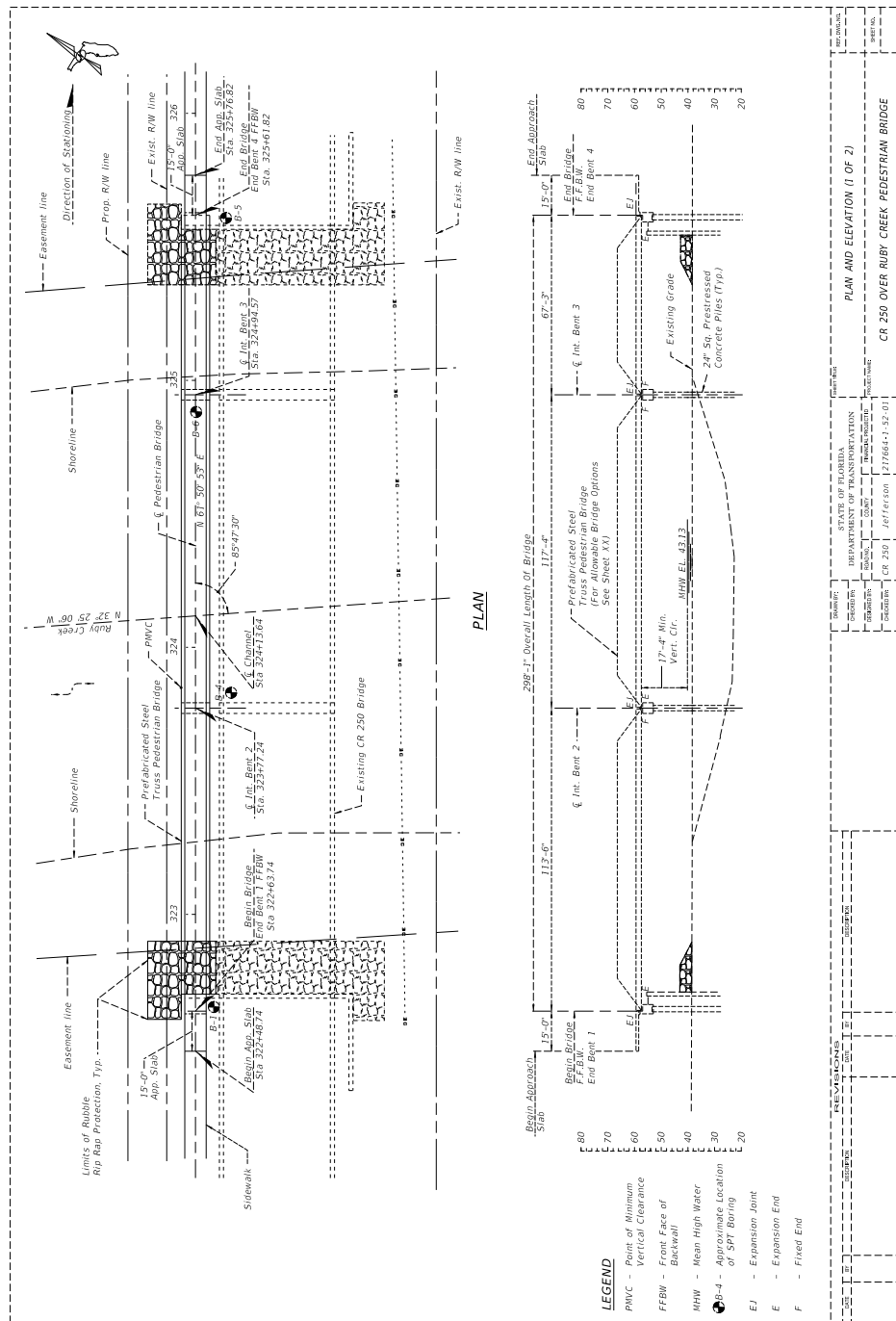

Exhibit 8-A Sample Steel Truss Pedestrian Bridge Plans, Sheet 7 of 8

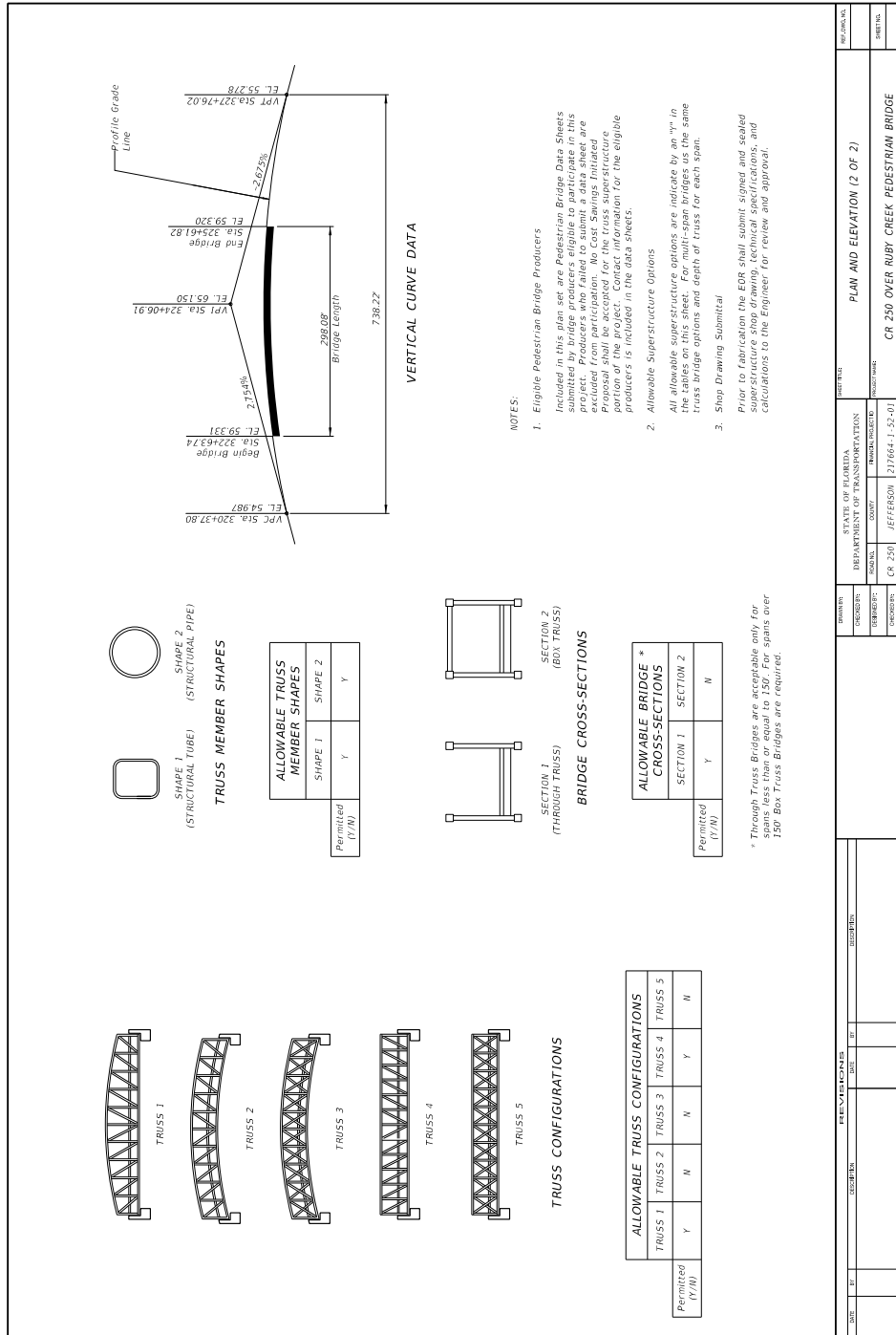

Exhibit 8-A Sample Steel Truss Pedestrian Bridge Plans, Sheet 8 of 8

TYPICAL END BENT
TYPICAL INTERMEDIATE PIER/BENT
PARTIAL PLAN

TYPICAL END BENT
TYPICAL INTERMEDIATE PIER/BENT
PARTIAL ELEVATION

BEARING PLATE DIMENSIONS

SPAN	G	H	J	K
1	(in.)	(in.)	(in.)	(in.)
2				
3				
4				

COMPANY CONTACT INFORMATION

COMPANY	
ADDRESS	
CONTACT	
PHONE	
E-MAIL	

BRIDGE REACTIONS

	SPAN 1	SPAN 2	SPAN 3	SPAN 4
DEAD LOAD	P (KIP)	T (KIP)	P (KIP)	T (KIP)
UNIFORM LIVE LOAD	L (KIP)	L (KIP)	L (KIP)	L (KIP)
VEHICLE LOAD	V (KIP)	V (KIP)	V (KIP)	V (KIP)
WIND UPLIFT	W (KIP)	W (KIP)	W (KIP)	W (KIP)
WIND LEeward	W (KIP)	W (KIP)	W (KIP)	W (KIP)
WIND TRANSVERSE	W (KIP)	W (KIP)	W (KIP)	W (KIP)
WIND VERTICAL	W (KIP)	W (KIP)	W (KIP)	W (KIP)
THERMAL				

BEARING PLATE DETAILS

EXPANSION

FIXED

LEGEND

- P - Unfactored Vertical Load each Bearing Plate (4 per Span)
- T - Unfactored Transverse Load each Bearing Plate (4 per Span)
- L - Unfactored Longitudinal Load each Bearing Plate (4 per Span)
- V - Unfactored Vertical Load each Bearing Plate (4 per Span)
- W - Unfactored Wind Load each Bearing Plate (4 per Span)

Construction Specifications for Road and Bridge Construction - current Edition and supplements thereof.

DESIGN SPECIFICATIONS

- Structures Manual, current Edition and supplements thereof
- American Association of State Highway and Transportation Officials (AASHTO) Load and Resistance Factor (LRFD) Bridge Design Specifications
- AASHTO LRFD Guide Specifications for the Design of Pedestrian Bridges, current Edition
- FDOT Plans Preparation Manual, current Edition.

PEDESTRIAN BRIDGE DATA

PROJECT NO.	CR 250 OVER RUBY CREEK PEDESTRIAN BRIDGE
DATE	12/20/17
DESIGNER	JEFFERSON
SCALE	AS SHOWN

Chapter 9

Landscape and Community Aesthetic Features

9.1	General	9-1
9.1.1	References.....	9-2
9.2	Landscaping.....	9-3
9.2.1	Design Intent.....	9-3
9.2.2	Design Elements	9-4
9.2.3	Maintenance Plan	9-5
9.2.4	Cost Estimate.....	9-7
9.3	Community Aesthetic Features (CAF).....	9-8
9.3.1	Categories and Criteria	9-8
9.3.2	CAF Approval Process	9-12
9.3.2.1	Concept Phase.....	9-13
9.3.2.2	Final Phase	9-13
9.4	Place Name Signs.....	9-15
9.5	Blue Star Memorial Markers and Flag Poles	9-15

THIS PAGE LEFT BLANK INTENTIONALLY

Chapter 9

Landscape and Community Aesthetic Features

9.1 General

"Landscape" or "Landscaping" means any vegetation, mulches, irrigation systems, and site amenities, such as, street furniture, specialty paving, tree grates, walls, planters, fountains, fences, and lighting (excluding public utility street and area lighting), as defined in ***Rule Chapter 14-40, Florida Administrative Code, Highway Beautification and Landscape Management***. Landscaping may be constructed as a stand-alone project or as a component of a roadway project or Community Aesthetic Feature.

Community Aesthetic Features (CAF) are enhancements installed in/on the Department's right-of-way, structures, or facilities for the sole purpose of representing, reflecting, or recognizing nearby community cultural and/or natural values and resources, or to enhance the sense of place through which a highway passes. These features are designed, maintained, and entirely paid for by the local governmental entity. The CAF may be constructed by the local governmental entity or included as part of a Department project.

9.1.1 References

Additional information regarding landscape plans may be found in:

1. ***Florida Accessibility Code for Building Construction***
2. ***Florida-friendly Best Management Practices for Protection of Water Resources***
3. ***Florida's Best Native Plants; 200 Readily Available species***, Gil Nelson, 2003, University Press of Florida
4. ***Florida Building Code***
5. ***Highway Beautification Policy # 000-650-011***
6. ***FDOT Design Standards***
7. ***FDOT Drainage Manual***
8. ***FDOT Utility Accommodation Manual***
9. ***FDOT Voluntary Code of Conduct regarding Invasive exotic plants***
10. ***FDOT-Florida Highway Landscape Guide.***
11. ***Florida Power and Light-Right Tree for Right Place:***
http://www.fpl.com/residential/trees/right_tree_right_place.shtml
12. ***Highway Landscape, Beautification, and Plan Review Procedure (Topic No. 650-050-001)***
13. ***Identification & Biology of Non-Native Plants in Florida's Natural Areas***, Langeland and Burks, 1998, University of Florida
14. ***Rule Chapter 14-40, Florida Administrative Code, Highway Beautification and Landscape Management***
15. ***Transit Cooperative Research Program Report 19 – Guidelines for the Location and Design of Bus Stops*** (for additional guidance in areas where transit is present)
16. ***Turf and Landscape Irrigation Best Management Practices, Irrigation Association, December 2010***
17. ***Rule Chapter 62-610, Florida Administrative Code, www.flrules.org***
18. ***Sections 125.568, 166.048, 255.259, 335.167, 369.251, 373.185, 373.227, and 581.091 Florida Statutes (F.S.), www.leg.state.fl.us/statutes***
19. ***Florida's Highway Beautification Programs, www.MyFloridaBeautiful.com***

9.2 Landscaping

9.2.1 Design Intent

Landscaping is designed to complement and enhance the natural and man-made environment. This may include irrigation systems and site amenities such as street furniture, specialty pavement, tree grates, walls, planters, fountains, fences, and lights. Include the following elements in the plans:

1. Large plants as defined in the ***Basis of Estimates Manual*** pay item 580 with combined value of 50% or more of the estimated value of all plants specified in the plans.
2. Plant selection and placement that:
 - a. Is consistent with the Department's Highway Beautification Policy, Topic Number 000-650-011
 - b. Preserves visibility of community aesthetic features, permitted outdoor advertising signs, and highway signing
 - c. Adheres to agreed maintenance requirements established by District Landscape Architect, District Maintenance Engineer, or maintenance agreement
 - d. Complements the performance and function of existing stormwater systems
 - e. Adheres to [Florida Friendly Landscaping](#), **Section 335.167, F.S.** The Department uses, and requires the use of, Florida-friendly landscaping practices, as defined in [Florida Statutes Chapter 373.185](#), in the construction and maintenance of all new state highways, wayside parks, access roads, welcome stations, and other state highway rights-of-way constructed upon or acquired after June 30, 2009
 - f. Minimizes soil erosion
 - g. Avoids conflicts with existing and proposed ITS devices, above and below ground utilities
3. When a part of the Contract Documents, Irrigation system design that:
 - a. Avoids overspray into the roadway, sidewalks, or any other paved surfaces, buildings, transit stops, etc.
 - b. Complies with state and local requirements (e.g., ***Florida Building Code***, ***Water Management Districts***, ***Florida Administrative Code***, etc.)

- c. Promotes water conservation (e.g., control system technologies including SMART irrigation technologies, reclaimed and reuse sources, etc.)
- d. Uses durable materials that are traffic rated and ultraviolet light resistant

9.2.2 Design Elements

Plans should consider the following elements:

1. Conservation of natural roadside growth (vegetation), scenic vistas and natural features.
2. Relocation of existing vegetation.
3. Selective clearing and thinning of existing vegetation.
4. Natural regeneration and succession of native plants.
5. Florida native plants with known provenance (original source of plants stock) to be as close to planting site as possible.
6. Plant selection and placement that minimizes impacts to natural areas.
7. Recycled and recyclable materials.
8. Texture and structure of existing soils or the need to remove and replace with soils appropriate for plants to grow in value.
9. Abilities, resources, and preferences of the maintaining entity.

The Landscape should be designed to permit sufficiently wide, clear, and safe pedestrian walkways, bicycle ways, and transit waiting areas. Requirements for sight distances and clearance to obstructions must be observed, especially at intersections.

Landscaping cannot screen from view a legally permitted outdoor advertising sign. The extent of the screening prohibition is provided in **Section 479.106(6), Florida Statutes (F.S.)**. Additional information is found in **Rule Chapter 14-10 and 14-40, Florida Administrative Code (F.A.C.)**. Irrigation systems must adhere to any additional requirements set forth by local governmental entity and water management districts.

When a legally erected and permitted outdoor advertising sign is within the project limits (adjacent to the right of way), and there is no permitted view zone, the landscape architect will notify the sign permittee that a highway landscape project is proposed. An example letter and other useful information are available at www.myfloridabeautiful.com. The sign permittee will have 30 days to establish a view zone by submitting an **Application to**

Permit Vegetation Management at Outdoor Advertising Sign (Form 650-050-06) that proposes a view zone (see **Rule 14-10.056, F.A.C.**). If an **Application to Permit Vegetation Management at Outdoor Advertising Sign** is submitted within 30 days, a view zone will be established in accordance with the provisions of **Rule Chapter 14-10, F.A.C.**, upon approval of the application by the Department. If the sign owner does not respond to the notice within the 30-day time frame provided, and the specific location of the view zone is not established by permit or agreement, the view zone will be within an area beginning at a point on the edge of pavement perpendicular to the edge of the sign facing nearest the highway and continuing in the direction of approaching traffic for a distance of 350 feet for posted speed limits of 35 miles per hour or less and 500 feet for posted speed limits over 35 miles per hour (see **Section 479.106(6), F.S.**). Contact information for any permitted sign may be obtained by contacting the State Outdoor Advertising Administrator, Florida Department of Transportation, 605 Suwannee Street, MS 22, Tallahassee, Florida 32399-0450.

Modification for Non-Conventional Projects:

Delete **PPM** 9.2.2 and see the RFP for requirements.

9.2.3 Maintenance Plan

A performance based maintenance plan for all proposed landscape improvements, including the irrigation system, must accompany the landscape plans. A performance based maintenance plan describes the desired or required end result necessary to achieve the design intent; not the day to day maintenance activities. This may be on separate plan sheets or written documents. This maintenance plan will not be part of the construction contract documents, and does not affect the contractor's responsibility during the plant establishment period. The maintenance plan is intended to make sure that the landscape architect and the maintaining entity responsible for maintenance understand what resources and practices will be necessary to maintain the irrigation system and its components to ensure safety, efficient water delivery, conservation of water resources, and to maintain the landscape in a safe and vigorous condition that meets the project objectives many years after construction is completed. The intent of design elements, such as to screen a view, maintain a clear sight distance, watering schedule, or assist with water retention, must be included in a description of the project, accompanied by a written or graphic guide describing the performance requirements of the maintaining entity. The maintenance plan defines the limits of the maintenance activities that will be performed. When necessary, the maintenance plan must include a temporary traffic

control plan. The maintenance plan must also include performance requirements necessary to maintain and manage the following, as applicable:

1. Sight distance
2. Lateral offset and vertical clearance
3. Accessibility
4. Plant health, form, height and spread
5. Turf (mowing)
6. Mulch thickness and cover
7. Edges
8. Weeds and litter
9. Irrigation system(s) (see irrigation performance requirements listed below)
10. Erosion control
11. Hardscape, lighting, benches, and site amenities
12. Invasive plant management
13. Other requirements necessary for the design intent to be fulfilled

Include the following performance requirements for the irrigation system in the maintenance plan:

1. The frequency of scheduled inspections
2. Reporting parameters for performance conditions
3. Detailed requirements associated with the system components inspection against the original design parameters
4. Adjustments necessitated over time as the landscape matures
5. A written or graphic guide describing the plant water needs across changing weather conditions at the station or zone level

The maintenance plan must also include performance requirements necessary to maintain and manage the following:

1. Performance of backflow prevention
2. Water supply and pressure requirements
3. Desired operating pressure for pressure regulators
4. Filters and filtration requirements

5. Operation of controller, including battery backup
6. Sensors
7. Valve flow and operation
8. Flow regulators
9. Head adjustment and spray pattern
10. Testing requirements
11. Manufacturer specifications and user manuals
12. Winterization requirements (if applicable)
13. Future audit requirements
14. Other requirements necessary for the performance intent to be fulfilled

A maintenance cost estimate based on performance expectations described in the maintenance plan must be provided independently from the plans. Consult with the District Landscape Architect and District Maintenance staff when developing the cost estimate. The estimate allows the maintenance entity to evaluate the landscape plan and determine if revisions are necessary. When the landscape and irrigation project is to be maintained by a local governmental entity, the maintenance plans will become an exhibit to the maintenance agreement. When maintained by the Department, maintenance plans are exhibits for landscape maintenance contracts. The designer should meet with the local governmental entity during development of the maintenance plan.

For Landscape Plan contents refer to **Chapter 26** of Volume 2.

9.2.4 Cost Estimate

A cost estimate for all proposed landscaping must accompany the landscape plans. The cost estimate must include a total unit cost for each individual plant type and size, as tabulated on **Exhibit LD-1, Chapter 26** in Volume 2. The breakout cost for large plants and small plants must include all incidental costs associated with the landscape plans, as defined in **Chapter 26** in Volume 2. This must be on separate plan sheets or written documents. This cost estimate will not be part of the construction contract documents. The cost estimate is intended solely for use by the Department. This estimate is to be provided to the Project Manager.

Modification for Non-Conventional Projects:

Delete **PPM 9.2.4**.

9.3 Community Aesthetic Features (CAF)

Communities may have an active interest in placing aesthetic features on the Department's right-of-way. Community Aesthetic Feature projects must meet the Department's requirements governing safety, access, and maintenance of the highway.

The **Community Aesthetic Feature Agreement** ([Form Number 625-010-10](#)) must be executed by the local governmental entity and the Department prior to any construction in/on the Department's right-of-way, structures, or facilities. This agreement provides for the removal and/or relocation of the Community Aesthetic Feature at the local governmental entity's expense should it not be maintained by the local governmental entity, or if the Department needs the right-of-way for transportation purposes. A Deposit, Performance Bond, or Letter of Credit is required as part of the Community Aesthetic Feature agreement. See F.S. 334.187 for requirements.

Final plans for placing a Community Aesthetic Feature within the Department's right-of-way must be accompanied by a resolution of the local governmental entity indicating their full financial responsibility for the feature's design, construction and maintenance during its lifespan. (See **Sections 9.3.1** and **9.3.2** for submittal and approval requirements.)

9.3.1 Categories and Criteria

Community Aesthetic Features, as defined in **Section 9.1**, consist of two categories:

- Public Art (Stand Alone or Affixed)
- Local ID Markers (Stand Alone or Affixed)

While there are some criteria unique to each category, all Community Aesthetic Features must meet the following criteria:

1. Except where parking is available, select a site and lay out the site plan to deter drivers from stopping within the roadway. If drivers are expected to stop or park, provide for parking in the plan. If public access is available, all Department Standards and Specifications must be met, including ADA requirements. Prohibit public access to the Community Aesthetic Feature when it is located within the interstate, interchange, or limited access right-of-way.
2. The feature must not contain any signs as defined in the **2009 Manual on Uniform Traffic Control Devices (MUTCD), Part 1, Chapter 1A.13**, traffic control features, auditory devices, reflective surfaces, flashing lights, moving parts or moving illumination.

3. The feature must not contain any advertising per the **MUTCD** and **23 C.F.R., 1.23** which prohibits advertising on, or commercial use of the right of way. Commercial advertising on state right of way is also prohibited by **Chapter 479, Florida Statutes**, including charitable, fraternal, religious, or political signs, symbols, logos, banners or any other such device.
4. Lighting of the feature must not be directed at motorists, bicyclists or pedestrians. For lighting criteria see **Section 7.3, Table 7.3.3** of this Volume. When located near an airport, the feature must not create a hazard as defined by **Section 333.01(3), F.S.**
5. In absence of feature lighting, any messages or text included on Local ID Markers must be retroreflective. Decorative or accent lighting must not include any strobe effects, flashing lights, moving parts, or moving illumination.
6. Local ID Markers (Stand-Alone or Affixed) are not allowed on limited access facilities unless they are part of an overall aesthetic treatment plan that can include landscaping and other aesthetic components.
7. Local ID Markers intended to represent the geographic boundary of the county, municipality, sovereign nation or unincorporated area should be located in close proximity to the actual geographic boundary of that area. Remove existing standard geographic boundary guide signs, and/or non-official signs or structures, at or near the location.
8. Do not install Local ID Markers in both the median and roadside at a given location.
9. CAF installations within limited access right-of-way, which are visible from the Interstate mainline, require FHWA approval.
10. CAFs are not allowed within the median of an interstate or limited access facility.
11. One Stand-Alone feature will be allowed per mainline interchange approach (for a maximum of two installations). The local governmental entity must select one site from amongst the ramp and the mainline, along the outside of a ramp, or the area inside a loop ramp.
12. The feature must meet all applicable building codes and design criteria for similar structures or landscaping placed adjacent to the highway's right of way, including wind loading commensurate with highway signs in the area.
13. The feature must not cause adverse impacts to property access, air quality, noise, water quality, wetlands, floodplain encroachments, endangered or threatened species or their critical habitat, historical resources, or create public controversy.

14. The feature, including amenities (landscape, fencing, etc.), must not obstruct any signs or interfere with any sight distance, sight triangle, or view zone (see **Section 9.2.2**).
15. The final design of all CAFs must be signed and sealed by a responsible professional licensed in Florida.
16. All CAF submittals must include a Submittal/Approval Letter (**Exhibit 23-A**) signed by the applicant and the DDE or Turnpike Design Engineer.

In addition, CAFs must meet the following criteria:

A. Public Art – Stand-Alone:

1. All roadways:
 - a. The location must be outside the appropriate clear zone and should be as close to the right-of-way line as practical.
 - b. The structure may not display messages with text, or contain any words or alpha-numeric characters.
 - c. The artist's insignia may be inscribed or etched on a small plaque affixed to the artwork, or placed on the artwork itself. The insignia must not be visible from the roadway so as to avoid distraction to drivers or bicyclists.
 - d. The object's highest point must not be greater in elevation than 25 feet above the nearest point of the roadway.
2. Urban roadways:
 - a. The feature may be placed in the median of urban roadways with curb or curb and gutter, where:
 - i. The Design Speed is less than or equal to 45 mph.
 - ii. Right-of-way is restricted.
 - iii. A minimum offset of four feet from the face of curb is provided.

B. Public Art – Affixed:

1. The feature may not display any messages with text, or contain any words or alpha-numeric characters.
2. The artist's insignia may be inscribed or etched on a small plaque affixed to the artwork, or placed on the artwork itself. The insignia must not be visible from the roadway so as to avoid distraction to drivers or bicyclists.
3. For bridges, the feature must not reduce the vertical clearance over the roadway.

4. For art wraps affixed to traffic control cabinets:
 - a. Do not obstruct cabinet vents with the art wrap.
 - b. The DDE should coordinate with the District Traffic Operations Office during the review process.
 - c. Art wrap themes can be approved for general use by a local government entity.
 - d. A CAF Agreement will be required for these features.
 - e. Any maintaining agency, other than a local government, must coordinate approvals and maintenance through the appropriate local government entity.

C. Local ID Marker – Stand-Alone:

1. All roadways:
 - a. The location must be outside the appropriate clear zone and should be as close to the right-of-way line as practical.
 - b. The structure may contain text such as the name of the municipality, county, or community area (as defined in [Chapter 14-51.041, F.A.C.](#)) with a short phrase or message. The words “Exiting” or “Leaving” are not permitted.
 - c. The object’s highest point must not be greater in elevation than 25 feet above the nearest point of the roadway.
2. Urban roadways:
 - a. The feature may be placed in the median of urban roadways with curb or curb and gutter, where:
 - i. The Design Speed is less than or equal to 45 mph.
 - ii. Right-of-way is restricted.
 - iii. A minimum offset of four feet from the face of curb is provided.
3. Interstates and Limited Access Facilities:
 - a. Placement on interstate and limited access routes should be well outside the minimum clear zone at 50 feet minimum (100 feet preferred) from the edge of the travel lane or ramp, whether guardrail is present or not. The 50 foot minimum/100 foot preferred lateral placement will help to minimize driver distraction, and reduce the likelihood that vertical structures will become storm debris blown across the roadway.
 - b. The maximum letter height allowed is four feet.
 - c. A short phrase or message is not allowed.

D. Local ID Marker – Affixed:

1. All roadways:
 - a. The feature may contain text such as the name of the municipality, county or community area (as defined in [Chapter 14-51.041\(2\)\(c\), F.A.C.](#)) with a short phrase. The words “Exiting” or “Leaving” are not allowed.
 - b. For bridges, the feature must not reduce the vertical clearance over the roadway.
2. Interstates and Limited Access Facilities:
 - a. The maximum letter height allowed is four feet.
 - b. A short phrase or message is not allowed.

9.3.2 CAF Approval Process

The application process is conducted in two phases, the Concept Phase and the Final Phase. The Concept Phase includes District coordination with the applicant to ensure that the proper Community Aesthetic Feature category is selected, the corresponding criteria is achievable and acceptable, and the conditions of the Agreement are acceptable.

The District Design Engineer (DDE) or Turnpike Design Engineer will then submit a concept drawing and documentation to the State Roadway Design Engineer (SRDE). This documentation must include a Submittal/Approval Letter (**Exhibit 23-A**) signed by a representative of the requesting entity and the DDE/Turnpike Design Engineer. Upon review by the Roadway Aesthetic Community of Practice (RA CoP) and the SRDE, conceptual approval may be granted. Should conceptual approval be granted, the signed Submittal/Approval Letter will be returned via e-mail to the DDE and is intended to indicate that the Central Office is in agreement with the concept, and that any proposed Design Variations are acceptable. Otherwise, conceptual approval will be denied with comments. For applications on interstate right-of-way, the District should coordinate with the FHWA District Transportation Engineer prior to submitting to the SRDE.

The Final Phase includes the preparation and review of all final documents. The DDE will forward the Submittal/Approval Letter and final documents with a recommendation for approval to the SRDE. The SRDE will review the application and provide approval to place the feature, or deny the submittal with comments. Features on the Interstate System will also require final approval by FHWA.

When any of the requirements in Section 9.3.1 are not met, a Design Variation must be approved by the SRDE.

9.3.2.1 Concept Phase

Informal coordination may take place at any time between the District and the entity desiring to place a feature on the Department's right-of-way. The District should work with the applicant to resolve issues related to feature category, compliance with criteria, optimum location for placement, and identification of possible Design Variations. Before submittal to the SRDE, the local governmental entity must submit a written request to the DDE to place the Community Aesthetic Feature in the Department's right-of-way. A request for Conceptual Phase Approval must include at a minimum:

1. The designation of the feature category.
2. A conceptual drawing/rendering showing the top, front, and side views of the feature with labeled dimensions, material designations including connections, proposed lighting configuration, and any alpha-numeric characters.
3. A draft site plan dimensioning the location of the feature in relation to the roadway and the right-of-way.
4. The design speed of all adjacent roadways.
5. A citation of the governing **Design Standards**, **Criteria** and **Building Codes** to which the feature will be designed.
6. If the feature is to be affixed to a bridge:
 - a. Designate the bridge owner.
 - b. Declare what the impact is to the bridge loading.
7. The Signature/Approval Letter (**Exhibit 23-A**) signed by the applicant and the DDE.

9.3.2.2 Final Phase

Upon conceptual approval by the SRDE, the local governmental entity may choose to begin the Final Phase. The conceptual approval is valid for one year, at which time the local governmental entity may request an extension from the DDE. The Final Phase submittal includes the following documents:

1. Site Plans, including a Traffic Control Plan if temporary maintenance of traffic will be required to place and/ or maintain the feature.

2. Structural Plans including a wind load analysis.
3. Local Governmental Entity Resolution.
4. Executed **Community Aesthetic Feature Agreement**.
5. Signature/Approval Letter (**Exhibit 23-A**) signed by the applicant and the DDE.

Upon final approval by the SRDE and, if applicable, FHWA, the District will notify the local governmental entity that it may proceed with the placement of the feature. The Final Phase approval is valid for one year, at which time the local governmental entity may request an extension from the DDE.

9.4 Place Name Signs

All signs within the Department's right-of-way are regulated by the **MUTCD, Part 2**. Signs for general information, services, tourist destinations, and recreational/cultural interest areas all have specific chapters in the **MUTCD** which specify sign color, size and lettering requirements. Destination signs are classified in the **MUTCD** as Guide Signs and are also regulated therein.

Place Name Signs within the Department's right-of-way are regulated by the Department. Requirements for Place Name Signs are located in [Rule Chapter 14-51, F.A.C., Part IV Place Name Signs](#). Place name signs located off the Department right of way must conform to **Section 479.16, F.S.**

<http://www.dot.state.fl.us/trafficoperations/>

Customized Place Name Signs, previously included in **Chapter 14-51.043, F.A.C.**, are now considered Local ID Markers, as indicated in **Section 9.3.1**.

9.5 Blue Star Memorial Markers and Flag Poles

Blue Star Memorial Markers and Flag Poles are not considered Community Aesthetic Features and are not covered by this chapter. These markers are managed through the Local FDOT Maintenance and Traffic Operations offices.

THIS PAGE LEFT BLANK INTENTIONALLY

Chapter 10

Transportation Management Plan

10.1	General.....	10-1
10.2	References	10-2
10.2.1	Design Standards	10-2
10.3	Transportation Management Plan (TMP).....	10-3
10.3.1	Transportation Management Plan Components.....	10-6
10.3.1.1	Temporary Traffic Control (TTC) Plans.....	10-6
10.3.1.1.1	TTC Plan Development.....	10-8
10.3.1.1.2	TTC Plan Phase Submittals	10-12
10.3.1.2	Transportation Operations (TO).....	10-13
10.3.1.3	Public Information (PI)	10-14
10.4	Coordination	10-15
10.4.1	Coordination of TTC Plans with Structures Discipline .	10-17
10.4.1.1	General	10-17
10.4.1.2	Overhead Bridge Related Construction Activities	10-18
10.4.1.3	Temporary Structures	10-19
10.4.1.4	General Coordination	10-19
10.5	Temporary Traffic Control Training	10-20
10.6	Temporary Traffic Control Devices	10-20
10.7	Signs	10-21
10.7.1	Advance Warning Signs.....	10-21
10.7.2	Length of Construction Sign.....	10-21
10.7.3	Project Information Sign.....	10-21

10.7.4	Existing Signs	10-22
10.8	Lighted Units.....	10-22
10.8.1	Arrow Boards.....	10-22
10.8.2	Portable Changeable Message Signs.....	10-22
10.8.3	Temporary Traffic Signals.....	10-28
10.9	Channelizing Devices	10-28
10.9.1	Type III Barricades.....	10-29
10.9.2	Separation Devices.....	10-29
10.10	Pavement Markings.....	10-29
10.10.1	Removing Pavement Markings	10-29
10.10.2	Raised Retroreflective Pavement Markers (RPM).....	10-29
10.10.3	Work Zone Pavement Markings.....	10-29
10.11	Roadside Safety Hardware for Work Zones.....	10-30
10.12	Temporary Traffic Control Plan Details	10-30
10.12.1	Taper Lengths.....	10-30
10.12.2	Intersecting Road Signing and Signals	10-31
10.12.3	Sight Distance.....	10-32
10.12.4	Pedestrians and Bicyclists	10-32
10.12.4.1	Pedestrian Requirements	10-32
10.12.4.2	Bicycle Requirements.....	10-33
10.12.5	Superelevation.....	10-34
10.12.6	Lane Widths.....	10-34
10.12.7	Lane Closure Analysis	10-34
10.12.8	Traffic Pacing Design.....	10-47
10.12.9	Detours, Diversions, and Lane Shifts	10-60
10.12.10	Roadside Hazards	10-61

10.12.11	Drop-offs in Work Zones	10-61
10.12.12	Narrow Bridges and Roadways.....	10-61
10.12.13	Existing Highway Lighting	10-61
10.12.14	Work Area Access	10-63
10.12.15	Railroads	10-64
10.12.16	Temporary Raised Rumble Strip Sets.....	10-64
10.12.17	Pay Items and Quantities.....	10-64
10.13	Speed Zoning	10-65
10.13.1	Regulatory Speeds in Work Zones	10-65
10.14	Law Enforcement Services	10-66
10.14.1	Use of Speed and Law Enforcement Officers	10-67
10.14.2	Use of Traffic Control Officer.....	10-67
10.14.3	Coordination, Documentation and Payment.....	10-68
10.14.4	Other Uses of Law Enforcement.....	10-69
10.15	Motorist Awareness System (MAS)	10-70
10.15.1	Portable Regulatory Signs (PRS).....	10-70
10.15.2	Radar Speed Display Unit (RSDU)	10-71
10.15.3	Speed and Law Enforcement Officer	10-71

Tables

Table 10.1	Common Bridge Related Overhead Work Activities Requiring the Removal of Traffic Below	10-18
Table 10.2	Taper Length Criteria for Work Zones	10-31
Table 10.3	Minimum Radii for Normal 0.02 Cross Slopes.....	10-34

Exhibits

Exhibit 10-A	Changeable Message Signs Worksheet.....	10-25
Exhibit 10-B	Lane Closures.....	10-36
Exhibit 10-C	Traffic Pacing.....	10-48

Chapter 10

Transportation Management Plan

10.1 General

The need to improve the capacity of, and to rehabilitate Florida's highways, has greatly increased the frequency of highway construction taking place immediately adjacent to or under traffic. The traveling public, as well as construction and inspection personnel are exposed to conflicts that may become hazardous. In addition to the safety issue, the potential delays to the public, as traffic is interrupted by construction, can be significant. As a result, all traffic, including motor vehicles, transit, bicyclists and pedestrians must be accommodated through construction zones with minimum delay and exposure to unsafe conditions.

Definition: Maintenance of Traffic (MOT) – Department-wide terminology for Temporary Traffic Control (TTC).

10.2 References

The following references contain the basic criteria and other required information for work zone traffic control in Florida:

1. The ***Manual on Uniform Traffic Control Devices for Streets and Highways, (MUTCD)***, Federal Highway Administration. ***Part VI*** of the ***MUTCD*** deals specifically with work zone traffic control. Other parts of the ***MUTCD*** may also be useful in designing a temporary traffic control plan.
2. ***Policy on Geometric Design of Highways and Streets, AASHTO.***
3. ***Roadside Design Guide, AASHTO, Chapter 9.***
4. ***Design Standards, Indexes 412, 414, 415, the 600 Series and 17347.***
5. ***Standard Specifications for Road and Bridge Construction.***
6. ***Basis of Estimates Manual.***
7. ***FDOT Accessing Transit Guide, Chapter 4.6.***
8. ***AASHTO Guide for the Development of Bicycle Facilities, Fourth Edition, Chapter 7.***

10.2.1 Design Standards

The [Design Standards, Index 600 Series](#), contains information specific to the Federal and State guidelines and standards for the preparation of temporary traffic control plans and for the execution of traffic control in work zones, for construction and maintenance operations and utility work on the State Highway System. Requirements in the [Design Standards](#) are based on the high volume nature of state highways. For highways, roads and streets off the State Highway System, the local agency (city/county) having jurisdiction, may adopt requirements based on the minimum requirements provided in the ***MUTCD***.

Modification for Non-Conventional Projects:
Delete the last sentence and see the RFP for requirements.

10.3 Transportation Management Plan (TMP)

A Transportation Management Plan (TMP) is required for minimizing activity-related traffic delay and crashes.

All TMPs share the common goal of congestion relief during the project period by managing traffic flow and balancing traffic demand with highway capacity through the project area.

TMPs are required for significant projects which are defined as:

1. A project that, alone or in combination with other concurrent projects nearby, is anticipated to cause sustained work zone impacts.
2. All Interstate system projects within the boundaries of a designated Transportation Management Area (TMA) that occupy a location for more than three days with either intermittent or continuous lane closures.

For significant projects, a multi-discipline TMP team may be formed to handle the planning, coordination, implementation, monitoring, and evaluation details of the TMP elements. Depending on the project logistics, the team composition may vary from project to project. The TMP team may include representatives from the entities as follows:

1. PD& E
2. Design
3. Traffic Operations
4. Construction
5. District Bicycle/Pedestrian Coordinator
6. Transit
7. FHWA
8. Local government (county and/or city)
9. Public Information
10. Others as deemed necessary (e.g., State Police, hospitals, etc.).

A TMP consists of strategies to manage the work zone impacts of a project. Its scope, content, and degree of detail may vary based upon the expected work zone impacts of the project. A TMP includes three components: (1) Temporary Traffic Control (TTC) plan

component, (2) Transportation Operations (TO) component, and (3) Public Information (PI) component. For individual projects that have less than significant work zone impacts, the TMP must consist of a TTC plan that addresses all TO and PI issues. When multiple projects are in the same corridor or on corridors within the same traffic area, it may be possible to develop a single corridor or regional TMP.

1. The Temporary Traffic Control plan component describes TTC measures to be used for facilitating road users through a work zone or an incident area. The TTC plan plays a vital role in providing continuity of reasonably safe and efficient road user flow and highway worker safety when a work zone, incident, or other event temporarily disrupts normal road user flow. The scope of the TTC plan is determined by the project characteristics. The TTC plan must either be a reference to specific Design Standard Index drawing(s) or be designed specifically for the project.
2. The Transportation Operations component of the TMP must include the identification of strategies that will be used to mitigate impacts of the work zone on the operation and management of the transportation system within the work zone impact area. Typical TO strategies include, but are not limited to, demand management, corridor/network management, safety management and enforcement, and work zone traffic management. The scope of the TO component must be determined by the project characteristics.
3. The Public Information component of the TMP must include communications strategies that seek to inform affected road users, the general public, area residences and businesses, and appropriate public entities about the project, the expected work zone impacts, and the changing conditions on the project. This may include traveler information strategies. Integrate the PI component in the project's Community Awareness Plan (CAP) if the district's CAP guidelines include communications strategies addressed above. The scope of the PI component must be determined by the project characteristics.

Public information should be provided through methods best suited for the project, and include, but not be limited to, information on the project characteristics, expected impacts, closure details, changes to bike and pedestrian routes and facilities, and commuter alternatives.

Public information campaigns serve two main purposes in TMPs. They inform the public about the overall purpose of the project to generate and maintain public support; and they encourage changes in travel behavior during the project to minimize congestion. Because they give travelers the information they need to make their own travel choices; public information campaigns can be the single most effective of all TMP elements.

Develop and implement TMPs in sustained consultation with stakeholders; e.g., other transportation agencies, railroad agencies/operators, transit providers, freight movers, utility suppliers, police, fire, emergency medical services, schools, business communities, and regional transportation management centers.

Consideration of TMPs must begin at the Project Development and Environmental (PD&E) study stage. Impacts on traffic, traffic handling options, constructability, and design features and constraints, as they affect traffic and transit operations, are to be evaluated for each alternate alignment studied. The Environmental Document and Preliminary Engineering Report (PER) must specifically address the TMP.

As the design progresses, use the TMP material from the PD&E study as the basis, and include the following as applicable:

Design features and constraints. Length of the project, lane configuration, transit stops, bicycle lanes, sidewalks and grade differentials between existing and proposed, interchanges and intersections, pavement materials, storm drains, roadway lighting, utilities and bridge features are some of the design element decisions that may be influenced by work zone traffic control considerations.

Contract specifications. Provisions such as time restrictions on construction activities; incentive-disincentive clauses; daily, weekly and seasonal restrictions and special materials may be necessary. Time restrictions could include work stoppages for Manatee (or other endangered/protected species) inhabitation, sporting events, holidays or other special considerations. Coordinate with local agencies as to the dates of local events or other community sensitive issues. Specify public relations activities such as media releases, television and radio spots, and handbills.

Modification for Non-Conventional Projects:

Delete the last sentence and replace with the following:

Public relations activities such as media releases, television and radio spots, and handbills will be specified in RFP.

Other actions. Actions may need to be taken by the Department prior to or during construction that may not be a contract requirement. Examples are dealing with the media and local businesses, provisions for mass transit options to commuters, notification of changes to pedestrian and bicycle routes and facilities, service

patrols, improvements to alternate routes, coordination with other projects and maintenance activities, and special inspection requirements.

Public input. On very large and complicated projects, it will be necessary to involve the public through informal public meetings to be held early in the design of a project. Close coordination with city and county officials will be necessary. Citizen and business advisory committees may be established as sources of input.

Utility work. If contract utility work is anticipated in conjunction with or during the highway construction, the Temporary Traffic Control plan must account for and adequately protect all work activities. The phasing of construction activities must be compatible with the utility work. Utilities, whose work affects traffic, are required to have a TTC plan by FHWA. This requires early and effective coordination with utilities.

10.3.1 Transportation Management Plan Components

10.3.1.1 Temporary Traffic Control (TTC) Plans

A TTC plan is a set of specific plan sheets, references to standard (typical) layouts, and/or notes on roadway plans describing how traffic will be controlled through a work zone. All projects and work on highways, roads and streets must have a temporary traffic control plan, as required by Florida Statute and Federal regulations. All work must be executed under the established plan and Department approved procedures. The TTC plan is the result of considerations and investigations made in the development of a comprehensive plan for accommodating traffic through the construction zone. These considerations include the design itself, contract specifications, and plan sheets.

TTC plan sheets detail the proper delineation of traffic through the work zone during all construction phases. The complexity of the TTC plan varies with the complexity of the traffic problems associated with a project. Many situations can be covered adequately with references to specific sections from the [Manual on Uniform Traffic Control Devices \(MUTCD\)](#), or the [Design Standards, Index 600 Series](#). Specific TTC plan sheets are required in the plans set whenever project conditions are not specifically addressed in a typical layout from the manuals noted above. This is usually the case for complex projects; therefore references to the [Design Standards](#), as well as specific TTC plan sheets, will likely be necessary.

A temporary traffic control plan must address the appropriate following information for the mainline and any affected crossroads, side streets, and ramps:

1. The location of all advance warning signs.
2. Temporary pavement markings, (including RPM's and Shared Lane Markings).
3. Location of temporary barriers and end treatments.
4. Temporary drainage design.
5. Channelizing devices at special locations.
6. Locations for special devices such as portable changeable message signs (PCMS), arrow panels, radar speed display units (RSDU), portable regulatory signs (PRS) and temporary signals.
7. PCMS messages for each phase.
8. Signal timing for each phase, including temporary actuation, to maintain all existing actuated or traffic responsive mode signal operations for main and side street movements for the duration of the Contract (Check with Traffic Operations Engineer).
9. Location and geometry for transitions, detours, and diversions.
10. Typical sections for each phase of work on all projects, except simple resurfacing projects, in order to show lane widths, offsets, barrier locations and other features influencing traffic control.
11. The proposed regulatory speed(s) for each phase.
12. References to specific [MUTCD](#) or [Design Standards, Index 600 Series](#) drawings. Do not make a general reference to the [Design Standards, Index 600 Series](#) in the plan notes as **Section 102-9 of the [Standard Specifications for Road and Bridge Construction](#)** includes a general reference to the index.
13. Appropriate quantities, pay items and pay item notes.
14. Resolve any conflicts between permanent signing and markings and work zone signing and markings.
15. Key strategies such as service patrol, law enforcement, public service announcements, night work, etc.
16. General notes.
17. Address the need for maintaining existing roadway lighting.
18. Work area access plan.

19. Temporary traffic control for bicyclists and pedestrians
20. Address the need for transit operations to safely stop along the roadway to board and discharge passengers, and to maintain transit stop signage.
21. Provide temporary business/residential access as needed.

Modification for Non-Conventional Projects:

Delete item 13 in the above list.

Chapter 19 in Volume 2 explains the required information for specific TTC plan sheets.

Consideration must also be given to adjoining, intersecting or sequential work zones. This can be a particular problem with maintenance operations, bridge or roadway projects under different contracts, and operations of other jurisdictions or utilities. When such work must take place, the operations must be coordinated and taken into account in the TTC plan so that the motorist encounters one, consistently designed, work zone.

Update TTC plans for project designs "on the shelf" prior to contract letting.

10.3.1.1.1 TTC Plan Development

The following step-by-step process should be followed by designers when preparing temporary traffic control plans:

Step #1 Understand the Project

1. Review the scope.
2. Field reviews. Examine the plans early in the plans development process.
3. Look at plan-profiles and cross sections for general understanding.
4. Review PD&E study for any constraints.
5. Consider transit and bicycle/pedestrian needs during construction.
6. Coordinate with the District Bicycle/Pedestrian Coordinator.
7. For complex projects consider developing a TTC plan study and other possible strategies such as public awareness campaigns, alternate route improvements, service patrols, etc.

Step #2 Develop Project Specific Objectives

What are your objectives? Examples might be:

1. Use barrier wall to separate workers from traffic (See **Chapter 4** of this Volume).
2. Close road if adequate detour exists.
3. Maintaining 2-way traffic at all times.
4. Maintaining roadway capacity during peaks.
5. Maintaining business/resident access.
6. Maintaining transit operations.
7. Maintain existing bicycle and pedestrian access.
8. Minimize wetland impacts.
9. Expedite construction.

Step #3 Investigate TTC Plan Alternatives

Develop some rough alternatives considering what could be used to accomplish the work, such as constructing temporary pavement and/or temporary diversions, using auxiliary lanes, placing 2-way traffic on one side of divided facility, using detour routes, etc.

Designers should check condition of any proposed detour routes. If the detour route is off the state system, additional documentation of the agreements with local agencies will be required (See **Section 10.12.9**). The design should prevent or minimize interruption of local transit operations.

Step #4 Develop a Construction Phasing Concept

1. Examine existing facility versus what is to be built. This is a major task on jobs other than resurfacing.
2. Coordinate with bridge designer.
3. Involve the Construction office as early as practical for input on alternate traffic control plans.
4. If a temporary ACROW Series 300 panel bridge is required see [Instructions for Design Standards](#) for **Index 21600 (IDS 21600)** for more information. If

a temporary ACROW Series 700 panel bridge is required contact the State Maintenance Office for additional information.

Note: Because of the limited quantity of Department owned ACROW Series 700 bridging that is available, special coordination with the State Maintenance Office is required for its use.

5. Color or mark the plan-profile sheets to show existing roadway versus new construction. Then, check station by station, the plan sheet against cross section sheets. Make notes on plan sheets as to drop-offs or other problems. Use profile grade lines or centerlines for reference points.
 6. List out major tasks to be completed, such as:
 - Construct new WB Roadway
 - Construct new EB Roadway
 - Construct frontage roads
 - Construct bridge/flyover
- Note:** The designer may need input from construction personnel or even contractors' representatives in determining construction phases.
7. Make notes on plan sheets or notepad as to "decisions" that you make along the way.

Step #5 Examine/Analyze Alternatives Which Meet Objectives (for each phase)

Evaluate proposed alternatives that meet the stated objectives.

1. Examine pros and cons of various alternatives.
2. Consider how much work and expense is involved for each alternative.
3. Consider detour/transition locations, signal operations during construction, how to handle buses, bicycles, pedestrians, service vehicles, etc.

Step #6 Develop Detailed TTC Plan

Select the alternatives that meet the objectives of the overall plan. Add details such as:

1. Detour/transition geometrics and locations.

2. If lane closures are needed, use the lane closure technique discussed in **Section 10.12.7** to determine time frame for closures.
3. Advanced signing scheme and locations, revisions needed to existing signs including guide signs, and proposed signs for all work activities lane closures, detours, etc., on mainline, side roads, crossroads and ramps.
4. Need for portable traffic signals, changeable message signs, and barriers.
5. How existing operations will be maintained side streets, businesses, residents, bikes, pedestrians, buses bus stops, etc.
6. Revisions to signal phasing and/or timing during each TTC plan phase.
7. Regulatory speed desired for each phase.
8. All pay items and quantities needed for TTC plan.
9. How existing auxiliary lanes will be used and any restriction necessary during construction.
10. Typical sections for each phase.
11. Outline key strategies to be used:
 - Service patrol
 - Law Enforcement
 - Public service announcements
 - Night work
 - Motorist Awareness System (MAS)
12. Need for alternate route improvements.

10.3.1.1.2 TTC Plan Phase Submittals

TTC plan phase submittals include the following:

1. **Phase I** a typical section for each phase as well as a description of the phasing sequence and work involved.
2. **Phase II** a majority of the TTC plan completed (75 90%), including the information outlined in **Section 10.3.1.1**, and a list of the pay items needed.
3. **Phase III** a final TTC plan, including all notes, pay items and preliminary quantities.

Note: The construction office estimates the duration for each phase of construction during Phase III review. The designer will finalize the quantities in the plans and Designer Interface after receiving the estimated durations for construction.

Modification for Non-Conventional Projects:

Delete **PPM 10.3.1.1.2** and replace with the following:

10.3.1.1.2 TTC Plan Phase Submittals

TTC plan phase submittals include the following:

1. **Technical Proposal** - a typical section for each phase as well as a description of the phasing sequence and work involved.
2. **90% Component Plans Submittal** - a majority of the TTC plan completed, including the information outlined in **Section 10.3.1.1**.
3. **Final Plans** - a final TTC plan, including all notes.

10.3.1.2 Transportation Operations (TO)

Many work zone impact management strategies can be used to minimize traffic delays, improve mobility, maintain or improve motorist and worker safety, complete road work in a timely manner, and maintain access for businesses and residents. The table below presents various work zone management strategies by category. This set of strategies is not meant to be all-inclusive, but offers a large number to consider, as appropriate, in developing TMPs.

Transportation Operations (TO) Strategies			
Demand Management	Corridor/Network Management	Work Zone Traffic Management	Safety Management and Enforcement
Transit services improvements	Signal timing/coordination improvements	Speed limits reduction or variable speed limits	ITS for traffic monitoring and management
Transit incentives	Temp. traffic signals	Temp. traffic signal	Transportation Management Center (TMC)
Shuttle services	Intersection improvements	Temp. barrier	Aerial surveillance
Ridesharing/ carpooling incentives	Bus turnouts	Crash Cushions	Milepost markers
Park-and-Ride promotion	Turn restrictions	Automated flagger assistance devices (AFAD)	Service patrol
HOV lanes	Truck restrictions	On-site safety training	Local detour routes
Variable work hours	Dynamic lane close system	TMP inspection team meetings	Contract support for incident management
Telecommuting	Ramp closures		Incident/emergency response plan
	Railroad crossing controls		Law enforcement

10.3.1.3 Public Information (PI)

A work zone public information and outreach campaign involves communicating with road users, the general public, area residences and businesses, and appropriate public entities about a road construction project and its implications for safety and mobility. The PI component may be integrated in the project's Community Awareness Plan (CAP) if the district's CAP guidelines include public information communications strategies. Detailed information on Public Information can be found in the ***Project Development and Environment Manual (PD&E Manual) Chapter 11*** and the ***Public Involvement Handbook***. Both documents are available on the State Office of Environmental Management's web site at: <http://www.dot.state.fl.us/emo/>

Start developing and implementing a public information and outreach campaign well before road construction begins and ongoing monitoring throughout the life of the project will be necessary. Planning and implementing a public information and outreach campaign involves a set of key steps that will be coordinated and outlined in a public information and outreach plan:

- 1. Determine the appropriate size and nature of the public information and outreach campaign.** The size and nature of a public information and outreach effort will be determined by the characteristics of a project, its location, and the anticipated impacts of a road construction project. Address the size and duration of the project, the amount of delay anticipated, special traffic and safety conditions such as heavy truck traffic, changes to bicycle and pedestrian routes and facilities, and disruptions to other modes and key facilities such as airports, stadiums, and hospitals.
- 2. Identify resources.** In most cases, public information and outreach spending will need to be part of a road construction project budget. In addition, campaign managers will also need to tap existing resources, an operating 511 system and the Lane Closure Information System (LCIS) for example, and leverage external resources such as free media coverage.
- 3. Identify partners.** Working with a range of partners to design and implement an information and outreach campaign will strengthen the strategies employed and may reduce the costs to the agency. Partners include, among others, State and local agencies, major employers, and business and neighborhood associations, and local bicycle clubs or advocacy groups.
- 4. Identify target audiences.** A key to any communication strategy is to identify the target audience(s). This will help to determine the types of messages that need to be conveyed and the best ways of communicating those messages.

5. **Develop the message(s).** The messages communicated by the campaign should provide project information to maintain safety and minimize delay, and should indicate that the agency cares about the traveling public, including transit riders, pedestrians, cyclists, and motorists. More specific messages might include details of the work zone, travel times through the work zone, alerts regarding the need for cyclists to share or control a travel lane, and alternate routes and modes of transportation.
6. **Determine communication strategies.** How information is communicated will depend on the audiences, the messages to be conveyed, and the campaign budget. The ***Public Involvement Handbook*** discusses a wide range of strategies for communicating information about a project.
7. **Determine communication timing.** Begin public information and outreach before work commences to develop partnerships and inform the public about the project, its anticipated impacts, and additional sources of ongoing project information. Early contact and coordination with bicycle groups (such as Metropolitan Planning Organization Bicycle/Pedestrian Advisory Committees or bike clubs) helps mitigate friction later in the program.

10.4 Coordination

Work zone traffic control requires the coordination of a number of agencies and other interested parties. Begin planning and coordination early in a project design.

Traffic control is a joint responsibility of design (both roadway and bridge), construction and traffic operations personnel. Coordination is necessary by all three parties in the development of TMPs. Both traffic operations and construction personnel must routinely review TMPs during Phase I and Phase II plans to ensure that the plan is sound and constructible and bid items are complete and quantities reasonable. With subsequent reviews of Phase III plans, designers are also encouraged to contact contractors for ideas on Temporary Traffic Control Plans.

Modification for Non-Conventional Projects:

Delete the last two sentences of the above paragraph and replace with the following:
Both traffic operations and construction personnel must routinely review TMPs during plans preparation to ensure that the plan is sound and constructible.

Temporary traffic control plans should also be reviewed with other appropriate entities such as maintenance, FHWA, community awareness teams, general public, transit agencies, businesses, freeway coordinator management teams, and local agencies. Initial reviews should be made by construction and traffic operations no later than the Phase II plans stage with subsequent reviews of Phase III plans. Input from local governmental and law enforcement agencies should be obtained early in the process, such as during the PD&E study and the Phase I plans stage.

Modification for Non-Conventional Projects:

Delete the last two sentences of the above paragraph and replace with the following:

Initial reviews should be made by construction and traffic operations no later than the 90% Component Plans. Input from local governmental and law enforcement agencies should be obtained early in the process, such as during the PD&E study and the Technical Proposal stage.

Adjoining work zones may not have sufficient spacing for standard placement of signs and other traffic control devices within their traffic control zones. These situations can occur when separate contracts adjoin each other (separate bridge and roadway contracts are a typical example), utility work performed separately from roadway work or when maintenance activities are performed adjacent to a construction project. Where such restraints or conflicts occur, or are likely to occur, resolve the conflicts in order to meet driver expectations.

10.4.1 Coordination of TTC Plans with Structures Discipline

10.4.1.1 General

To facilitate the development of an optimal design minimizing traffic disruption and construction costs, the roadway engineer and structures engineer must collaborate with each other prior to completion of Phase II roadway plans or the Bridge Development Report (BDR), whichever is earlier. For very complex urban projects, this collaboration should begin as early as the PD&E phase of the project.

Modification for Non-Conventional Projects:

Delete *PPM 10.4.1.1* and replace with the following:

10.4.1.1 General

To facilitate the development of an optimal design minimizing traffic disruption and construction costs, collaboration between the roadway engineer and structures engineer is required.

10.4.1.2 Overhead Bridge Related Construction Activities

In accordance with [Design Standards, Index 600](#) there are several overhead work activities that must be executed in the absence of traffic below. **Table 10.1** provides work durations and corresponding traffic control techniques for several common overhead bridge related work activities. The work activity durations given in the table assume a best case scenario in which the Contractor has optimized resources and work planning in advance to minimize traffic disruption.

Table 10.1 Common Bridge Related Overhead Work Activities Requiring the Removal of Traffic Below

Work Activity	Duration	Traffic Control Technique
Bridge Demolition	2 to 3 days per span	Detour or Median Crossover
Beam Placement Simple Span	30 minutes per beam	Traffic Pacing, Detour, or Median Crossover
Beam Placement Continuous Steel I-Beam	60 minutes per beam	Detour or Median Crossover
Beam Placement Continuous Steel Box Girder	90 minutes per girder, depending on the complexity of the connections	Detour or Median Crossover
Form Placement	4 hours per lane	*Lane Shift, Lane Closure, Detour or Median Crossover
Deck Concrete Placement	3 hours per span	*Lane Shift, Lane Closure, Detour or Median Crossover
Span Sign Structure Placement	20 to 25 minutes per structure	Traffic Pacing, Detour or Median Crossover
Segment Placement from Land Based Cranes (Balanced Cantilever)	2.5 hours per segment	*Lane Shift, Lane Closure, Detour or Median Crossover
*The decision to close the entire roadway using a detour or median crossover versus closing a lane with a lane shift or lane closure is largely a function of the project geometry (i.e., skew angle, segment length, etc.). Develop a plan view showing the segment layout, temporary towers, traffic lanes, and shoulders to determine which traffic control configuration is appropriate.		

10.4.1.3 Temporary Structures

Many common construction techniques require the use of temporary structures to allow for the installation of the permanent structure. Examples of temporary structures used routinely for the construction of highway structures include temporary stability towers and temporary sheet pile walls. Temporary stability towers are commonly used for the erection of segmental bridges constructed in balanced cantilever, steel plate girders, and steel box girders. Temporary sheet pile walls are commonly used for the construction of pier footings or to facilitate the installation of MSE wall straps. It is important to show the location of all temporary structures in each phase of the TTC Plan to assure there are no conflicts with temporary traffic patterns. See **Chapter 4** of this Volume to determine if temporary structures must be shielded.

When using a temporary ACROW panel bridge, indicate in the Temporary Traffic Control Plans, the use of the “Legal Weight Only” sign in accordance with [Design Standards, Index 17355](#). All signage must be in place before the temporary structure is opened to traffic. See [Design Standards, Index 21600 Series](#) and the associated [Instructions for Design Standards \(IDS 21600\)](#) for more information.

10.4.1.4 General Coordination

The Engineer of Record must ensure that:

- Proper coordination with the structural engineer is conducted to assure that all required temporary structures are accurately reflected in each phase of the Temporary Traffic Control Plans.
- There is adequate protection (temporary barrier walls) of temporary stability towers from adjacent traffic.
- Temporary Traffic Control Plans facilitate the placement of MSE wall straps. Strap lengths are typically 70% to 80% of the wall height.
- All critical temporary wall locations are identified in the wall plans and each phase of the traffic control plans.
- The required minimum numbers of traffic lanes remain in service for each phase of construction.
- Assumed construction activity durations should be achievable.
- Ingress and egress of work zones is accommodated.

- All traffic control commitments (minimum number of traffic lanes, design speeds, traffic movements, lane and shoulder widths, etc.) are accommodated for all work activities in each phase.
- The coordination has been completed with all local agencies affected by the structural activities.

10.5 Temporary Traffic Control Training

The Department has prescribed temporary traffic control training requirements outlined in the [Temporary Traffic Control \(Maintenance of Traffic\) Training Handbook](#).

10.6 Temporary Traffic Control Devices

Temporary Traffic Control devices/methods that are available for use include:

1. Signs (warning, regulatory and guide)
2. Lighted units (arrow panels, illumination devices, temporary signals and changeable message signs)
3. Channelizing devices (cones, tubular markers, plastic drums, vertical panels, longitudinal channelizing devices and Types I, II and III barricades)
4. Markings (pavement markings, raised retroreflective pavement markers, delineators, and removal of conflicting markings)
5. Roadside Safety Hardware (portable concrete barriers, guardrail and crash cushions) See **Chapter 4** of this volume
6. Flaggers
7. Law Enforcement
8. Motorist Awareness System (MAS)

The **MUTCD** contains detailed instructions on the use of traffic control devices. Special design considerations applicable to Florida are discussed in the following sections.

Do not place traffic control devices in locations where they will block transit stops, sidewalks or bicycle lanes.

10.7 Signs

For all work zone signs, when [Design Standards, Index 600](#) cannot be achieved for post mounted signs and barrier or traffic railing exists, use temporary signs per [Design Standards, Index 11871](#).

10.7.1 Advance Warning Signs

The TTC plan must identify the advance construction warning signs, including legends and location. These include signs such as "Road Work Ahead" and "Road Work One Mile". The TTC plan must provide the advanced warning signs, legends and locations for all proposed operations that require signing. These include diversions, detours, lane closures, and lane shifts, on the mainline as well as crossroads. The sequence for advance signing must be from general to more specific. As an example: Road Work Ahead (general), Left Lane Closed Ahead (more specific), and Merge Right (specific).

10.7.2 Length of Construction Sign

The length of construction sign (G20-1) bearing the legend "Road Work Next X Miles" is required for all projects of more than 2 miles in length. Locate the sign at begin construction points.

10.7.3 Project Information Sign

The Project Information Sign shown in Index 600 is required for all contracts with more than 90 days of contract time. This sign should be located approximately 500 feet in advance of the first advance warning sign or as close to be beginning of the project as practical, on each mainline approach. This sign may be omitted if physical constraints prohibit placement of this sign due to its size. Show the Project Information Sign in the TTC plans with the common name of the roadway (I-10; SR 5; US 1) and the phone number of the district office responsible to answer project specific questions.

10.7.4 Existing Signs

Remove or relocate existing signs (e.g., regulatory or warning) that conflict with the TTC plan in order to complement the work zone conditions; e.g., if a stop sign on an existing side road is needed, use the existing sign and show the location that it is to be relocated to. Modify existing guide signs to show changes made necessary by the construction operations.

If permanent guide signs are to be removed during construction, make provisions for temporary guide signing. The temporary sign must be black on orange with the legend designed in accordance with [MUTCD](#) requirements for permanent guide signing whenever possible.

10.8 Lighted Units

10.8.1 Arrow Boards

Use arrow boards to supplement other devices for lane closures on multilane roadways. Do not use arrow boards for lane shifts. Refer to the current [MUTCD](#) for further information.

Show arrow board locations on the TTC plan, along with any necessary notes concerning the use of this device.

10.8.2 Portable Changeable Message Signs

Use portable changeable message signs (PCMS) to supplement a traffic control zone. As a supplemental device, it cannot be used to replace any required sign or other device. These devices are used to provide information to the motorist about construction schedules, alternate routes, expected delays, and detours. Use portable changeable message signs in complex, high density work zones. Messages must be simple, with a minimum number of words and lines and must include no more than two displays of no more than three lines each with 8 characters per line. The TTC plan must include the location and messages to be displayed.

The message displayed must be visible and legible to the motorist at a minimum distance of 900 ft. on approach to the signs. Cycle messages so that two message cycles are displayed to a driver while approaching the sign from 900 ft. at 55 mph.

Use PCMS units as indicated below:

1. To supplement conventional traffic control devices in construction work areas and placed approximately 500 to 800 ft. in advance of potential traffic problems, or
2. 0.5 to 2 miles in advance of complex traffic control schemes that require new and/or unusual traffic patterns for the motorists.

A PCMS is required for night time work that takes place within 4 ft. of the traveled way.

Typical Conditions

Consistent with the factors described above, PCMS messages must be considered under the following conditions:

1. Road closures
2. Ramp closures
3. Delays created by:
 - Congestion
 - Crashes
 - Lane closures
 - Two-way traffic on divided highway
 - Multiple lane closures
 - Unexpected shifts in alignment

Message Selection

Programmed messages must provide appropriate information for the conditions likely to be encountered. Place the programmed messages in the TTC plan. Consider the following items in the development of a message:

1. **Message elements - not necessarily in order**
 - Problem statement (where?)

- Effect statement (what?)
- Attention statement (who?)
- Action statement (do?)

2. Message format

- Will vary depending on content
- "Where" or "what" will generally lead
- "Who" and "do" follow in that order
- "Who" often understood from "where"

3. Display format

- Discrete, with entire message displayed at once is most desirable
- Sequential is OK, 2 parts maximum
- Run-on moving displays prohibited
- One abbreviation per panel display desirable, two abbreviations are the maximum. Route designation is considered as one abbreviation and one word. Guidelines for abbreviations are provided on the following pages. Refer to the [**Traffic Engineering Manual**](#) for approved messages.

Exhibit 10-A Changeable Message Signs Worksheet

Location of board: _____

Used: from ____ - ____ - ____ at ____ : ____ am/pm

to ____ - ____ - ____ at ____ : ____ am/pm

Message programmed by: _____

MESSAGE 1

MESSAGE 2

Timing:

Message 1 will run ____ . ____ seconds.

Message 2 will run ____ . ____ seconds.

**STANDARD ABBREVIATIONS FOR USE
 ON CHANGEABLE MESSAGE SIGNS**

Standard abbreviations easily understood are:

<u>WORD</u>	<u>ABBREV.</u>	<u>WORD</u>	<u>ABBREV.</u>
Boulevard	BLVD	Normal	NORM
Center	CNTR	Parking	PKING
Emergency	EMER	Road	RD
Entrance, Enter	ENT	Service	SERV
Expressway	EXPWY	Shoulder	SHLDR
Freeway	FRWY, FWY	Slippery	SLIP
Highway	HWY	Speed	SPD
Information	INFO	Traffic	TRAF
Left	LFT	Travelers	TRVLR
Maintenance	MAINT	Warning	WARN

Other abbreviations are easily understood whenever they appear in conjunction with a particular word commonly associated with it. These words and abbreviations are as follows:

<u>WORD</u>	<u>ABBREV.</u>	<u>PROMPT</u>
Access	ACCS	Road
Ahead	AHD	Fog*
Blocked	BLKD	Lane*
Bridge	BRDG	[Name]*
Chemical	CHEM	Spill
Construction	CONST	Ahead
Exit	EX, EXT	Next*
Express	EXP	Lane
Hazardous	HAZ	Driving
Interstate	I	[Number]
Major	MAJ	Accident
Mile	MI	[Number]*
Minor	MNR	Accident
Minute(s)	MIN	[Number]*
Oversized	OVRSZ	Load
Prepare	PREP	To Stop
Pavement	PVMT	Wet*
Quality	QLTY	Air*
Route	RT	Best*
Turnpike	TRNPK	[Name]*

Vehicle	VEH	Stalled*
Cardinal Directions	N, E, S, W	[Number]
Upper, Lower	UPR, LWR	Level

*** = Prompt word given first**

The following abbreviations are understood with a **prompt** word by about 75% of the drivers. These abbreviations may require some public education prior to usage.

<u>WORD</u>	<u>ABBREV.</u>	<u>PROMPT</u>
Condition	COND	Traffic*
Congested	CONG	Traffic
Downtown	DWNTN	Traffic
Frontage	FRNTG	Road
Local	LOC	Traffic
Northbound	N-BND	Traffic
Roadwork	RDWK	Ahead [Distance]
Temporary	TEMP	Route
Township	TWNNSHP	Limits

*** = Prompt word given first**

Certain abbreviations are prone to inviting confusion because another word is abbreviated or could be abbreviated in the same way. **DO NOT USE THESE ABBREVIATIONS:**

<u>ABBREV.</u>	<u>INTENDED WORD</u>	<u>WORD ERRONEOUSLY GIVEN</u>
WRNG	Warning	Wrong
ACC	Accident	Access (Road)
DLY	Delay	Daily
LT	Light (Traffic)	Left
STAD	Stadium	Standard
L	Left	Lane (Merge)
PARK	Parking	Park
RED	Reduce	Red
POLL	Pollution (Index)	Poll
FDR	Feeder	Federal
LOC	Local	Location
TEMP	Temporary	Temperature
CLRS	Clears	Color

10.8.3 Temporary Traffic Signals

Design and detail in the plans temporary signalization at existing, temporary and new intersections using the following criteria:

- Temporary poles and span wire assemblies
 - For temporary signals installed for less than 1 year, design all signal supports for a 70 MPH wind speed. See ***FDOT Structures Manual, Volume 3*** for additional requirements.
 - See Lateral Offset Criteria in ***Chapter 4*** of this Volume for placement of temporary traffic signal supports.

Frequently, portable or temporary traffic signals will be a preferred alternative to a flagger. Also, existing signal operations may need to be revised to accommodate the construction operations. The TTC plan must identify all existing actuated or traffic responsive mode signal operations for main and side street movements that are to be maintained for the duration of the Contract. In addition, the TTC plan must identify the specific alterations (physical location, and preliminary phasing and timing) necessary for existing signals any portable signals. Include signal installation plans for each phase of construction in the TTC plan. Include traffic control signal requirements or responsibilities in the Technical Special Provisions. Signal displays and location must meet [MUTCD](#) requirements. If temporary signals are used where a pedestrian crossing is present, either existing or temporary, the pedestrian must be accommodated in the signal timing.

Temporary Signal Plans or modifications to existing signals must be reviewed by the appropriate section in the district for structural soundness and signal function.

10.9 Channelizing Devices

Cones, Type I and II barricades, vertical panels, drums, longitudinal channelizing devices (LCDs) and tubular markers may be used as channelizing devices at the contractor's option in accordance with [Design Standards, Index 600](#). Do not further restrict the Contractor's options of channelizing devices.

Include the quantity of the number of channelizing devices in the plans. Load this quantity under the pay item for channelizing devices. Always include this quantity in the plans and do not assume the contractor will only use cones and tubular markers. If the contractor

chooses to use cones or tubular markers, payment will be made under the pay item for MOT, Lump Sum.

10.9.1 Type III Barricades

Use two Type III barricades to block off, close, or partially close a road or ramp.

10.9.2 Separation Devices

When diverting traffic from a normally divided highway to an undivided condition is unavoidable, opposing traffic must be separated either with temporary barrier or temporary traffic separators as shown in [Design Standards, Index 600 Series](#). The use of striping, raised retroreflective pavement markers, and complementary signing, either alone or in combination is not considered acceptable for separation purposes.

10.10 Pavement Markings

10.10.1 Removing Pavement Markings

Existing pavement markings that conflict with temporary work zone traffic patterns must be obliterated where operations will exceed one work period. Painting over existing pavement markings is not permitted.

10.10.2 Raised Retroreflective Pavement Markers (RPM)

Raised Retro-Reflective Pavement Markers (RPM) are required as a supplement to all lane lines in the TTC transition area. For further direction on the use of RPMs in the work zone, refer to the [Design Standards, Index 600](#).

10.10.3 Work Zone Pavement Markings

See **Chapter 7** of this Volume for guidance on types of Work Zone Pavement Markings.

Removing paint from the roadway creates an undesirable scarring of the pavement surface. Transition areas that use paint to mark lane lines, should be milled and resurfaced; i.e. provide a clean surface (friction course) for the placement of permanent markings.

10.11 Roadside Safety Hardware for Work Zones

See **Chapter 4** of this Volume for additional information and requirements.

10.12 Temporary Traffic Control Plan Details

The [Design Standards](#), **Indexes 601** through **670**, are layouts of work zone traffic control for typical conditions. Reference these indexes only if project conditions are nearly the same as the typical layout. Otherwise, prepare specific plan sheets or details. Some conditions that will require specific plan sheets include:

1. Construction work zones near railroad crossings.
2. Detours and signing to reroute vehicles exceeding legal weights where temporary ACROW panel bridges are present. Coordinate with State Bridge Evaluation Engineer (Office of Maintenance) to determine signing and if necessary the preparation of detour plans for rerouting vehicles exceeding legal weights. See **IDS 21600** for more information.
3. Work not covered by a typical layout.
4. Nighttime work requiring special lighting, oversized or additional devices.
5. Ramps and intersections that interrupt the standard layout.
6. Sight distance restrictions such as horizontal or vertical curves.
7. Lane or shoulder configurations that do not match the standards.
8. Special considerations during installation, intermediate traffic shifts and removal.
9. Complex projects, including add-lane projects, which involve many phases, traffic shifts, entrances and exits.
10. Special plan and notes detailing bus pullover bay/bus stop configuration.

When designing layouts, consider the following sections:

10.12.1 Taper Lengths

Minimum taper lengths in the [Design Standards](#) are shown on individual Index sheets when applicable. When an Index sheet is not used, calculate the minimum taper length by the formulas shown below **Table 10.2**.

Table 10.2 gives the criteria for the lengths of the various taper types.

Table 10.2 Taper Length Criteria for Work Zones

Type of Taper	Taper Length
UPSTREAM TAPERS	
Merging Taper	L Minimum
Shifting Taper	1/2 L Minimum
Shoulder Taper	1/3 L Minimum
Two-way Traffic Taper	100 ft. Maximum
DOWNSTREAM TAPERS	
	100 ft. per lane

Formulas for L are as follows:

For speed limits of 40 mph or less:

$$L = WS^2/60$$

For speed limits of 45 mph or greater:

$$L = WS$$

"L" is the length of the taper in feet

"W" is the width of lateral transition in feet

"S" is the posted regulatory speed for the work zone.

10.12.2 Intersecting Road Signing and Signals

Signing for the control of traffic entering and leaving work zones by way of intersecting highways, roads and streets must be adequate to make drivers aware of work zone conditions. Under no condition will intersecting leg signing be less than a "Road Work Ahead" sign. The designer must include these signs in the estimated quantity for Construction warning signs.

Modification for Non-Conventional Projects:

Delete the last sentence of the above paragraph.

Existing traffic signal operations that require modification in order to carry out work zone traffic control must be as approved by the District Traffic Operations Engineer (DTOE) identified in the TTC plans. If lane shifts occur, signal heads may have to be adjusted to maintain proper position. The designer determines the need for temporary traffic detection for traffic actuated signals. Include all necessary signal adjustments in the TTC plan.

10.12.3 Sight Distance

See "Sight Distance" note on sheet 2 of *Index 600* in the [Design Standards](#) for requirements.

10.12.4 Pedestrians and Bicyclists

Transportation plans and projects must provide safe and continuous routes for pedestrians and bicyclists. In developing Temporary Traffic Control (TTC) Plans, when an existing pedestrian way or bicycle way is located within a traffic control work zone, accommodation must be maintained and provision for the disabled must be provided. Except on Limited Access facilities, all roadways are considered bikeways regardless of whether a bicycle-specific facility is present.

When existing pedestrian facilities are disrupted, closed or relocated in a TTC zone, the temporary facility or route must be detectable and include accessibility features consistent with the features present in the existing facility. See *Chapter 6D of the MUTCD* for additional guidance.

10.12.4.1 Pedestrian Requirements

There are three threshold requirements in planning for pedestrian safety in work zones on highways and streets:

1. Pedestrians must not be led into direct conflicts with work site vehicles, equipment or operations.
2. Pedestrians must not be led into direct conflicts with mainline traffic moving through or around the work site.
3. Pedestrians must be provided with a safe, convenient travel path that replicates as nearly as possible the most desirable characteristics of sidewalks or other walkways.

Pedestrian accommodations through work zones must include provisions for the disabled at the same or greater level of accessibility as the existing facility. Temporary traffic control devices for vehicular traffic are not allowed within the pedestrian travel path.

At transit stops, provisions must be made to ensure passengers have the ability to board and depart from transit vehicles safely. See FDOT's **Accessing Transit** for guidance on transit stops.

Signing and Pedestrian Longitudinal Channelizing Devices (LCDs) must be used to channelize pedestrians safely through the work zone, in accordance with **Design Standard, Indexes 600 and 660**. Whenever pedestrians are detoured or diverted (at an intersection, midblock, onto a temporary walkway, etc.), designers must detail the pedestrian way in the Temporary Traffic Control Plans. Reference to Index 660 may be made only when the project conditions are similar in size and scope to the typical applications shown in the Index. The designer must include quantities for pedestrian LCDs:

- At each closed sidewalk/pedestrian way location, for the full width of the sidewalk/pedestrian way.
- To delineate both sides of the path of a temporary walkway.

10.12.4.2 Bicycle Requirements

There are several requirements in planning for bicyclists in work zones on highways and streets:

1. Bicyclists must not be led into direct conflicts with mainline traffic, work site vehicles, or equipment moving through or around traffic control zones.
2. Bicyclists should be provided with a travel route that replicates the most desirable characteristics of a wide paved shoulder or bicycle lane through or around the work zone.
3. If the work zone interrupts the continuity of an existing shared use path or bike route system, provide signs directing bicyclists through or around the work zone and back to the path or route.
4. The bicyclist should not be directed onto the same path used by pedestrians unless the path is designed for bicycle traffic

10.12.5 Superelevation

Horizontal curves constructed in conjunction with temporary work zone diversions, transitions, and crossovers should have the required superelevation. Under conditions where superelevation is not used, the minimum radii that can be applied are listed in the **Table 10.3**. Superelevation must be included with the design whenever the minimum radii cannot be achieved.

Table 10.3 Minimum Radii for Normal 0.02 Cross Slopes

SPEED (mph)	MINIMUM RADIUS (feet)
65	3130
60	2400
55	1840
50	1390
45	1080
40	820
35	610
30	430

10.12.6 Lane Widths

Existing lane widths of through roadways should be maintained through work zone travel ways wherever practical. The minimum widths for work zone travel lanes must be 10 ft. for all roadways other than Interstate. On Interstate highways, the minimum width for work zone travel lanes is 11 ft., except at least one 12 ft. lane in each direction must be provided.

10.12.7 Lane Closure Analysis

The lane closure analysis is a process used by designers to calculate the peak hour traffic volume and the restricted capacity for open road and signalized intersections. The analysis will determine if a lane closure should or should not be allowed and the time of day or night a lane closure could occur without excessive travel delay.

For all projects under reconstruction, the existing number of lanes must remain open to traffic when construction is not active. Do not allow lane closures in excess of one work day on Limited Access construction where only two traveled lanes in one direction exist. If it becomes necessary to have a long-term lane closure on a four lane Interstate, provide sufficient documentation to the District Secretary for approval.

For widening or major reconstruction on Limited Access facilities, the Temporary Traffic Control Plan will keep the existing number of traffic lanes open at all times throughout the duration of the construction project.

Exhibit 10-B includes the lane closure analysis worksheets and two sample analyses. The sample **Lane Closure Worksheet (Exhibit 10-B, Sheet 3 of 11)** has been cross referenced to the **Lane Closure Symbols and Definitions** sheets (**Exhibit 10-B, Sheets 1 & 2 of 11**) with circled numbers. The circled numbers correspond to the numbers of the symbols and definitions. The symbols and definitions sheets show the designer where to find the necessary information to fill out the lane closure worksheet.

Fill out the top part of the lane closure worksheet and complete the formulas to calculate the hourly percentage of traffic at which a lane closure will be permitted (see **Exhibit 10-B, Sheets 6 & 8 of 11**). Transfer these percentages to the graph on the **Lane Closures 24 Hour Counts** sheet (**Exhibit 10-B, Sheet 5 of 11**). Draw a line across the graph representing the percentage for both open road and signalized intersections (see **Exhibit 10-B, Sheets 7 & 9 of 11**). Plot the hourly percentages (hourly volume divided by total volume) on the graph. Any hourly percentage extending above the restricted capacity percentage lines for open road or signalized intersections indicated lane closure problems. The bottom of the graph gives times for AM and PM. By coordinating the lane closure problem areas to the time of day, a designer knows when to restrict lane closure.

Many of Florida's roadways have directional peak hour traffic volumes, with inbound morning traffic, and outbound afternoon traffic. Doing a composite lane closure analysis would in many cases require night work. However, if a separate lane closure analysis is calculated for inbound and outbound separately, a lane closure may be allowed and the contractor could work in daylight hours, (See **Exhibit 10-B, Sheets 10 & 11 of 11**).

Exhibit 10-B Lane Closures Sheet 1 of 11

Symbols and Definitions

1. **ATC** = Actual Traffic Counts. Use current traffic counts. Traffic counts can be obtained from the Office of Planning, or you may need to get traffic counts done. The designer needs hourly traffic volumes with a total traffic volume for a 24-hour period (see **Exhibit 10-B, Sheet 7 of 11**).
2. **P/D** = Peak Traffic to Daily Traffic Ratio. Highest hourly volume divided by the total 24-hour volume. Convert the percentage to a decimal on the Lane Closure Worksheet (see **Exhibit 10-B, Sheet 7 of 11**).
3. **D** = Directional Distribution of peak hour traffic on multilane roads. This factor does not apply to a two-lane roadway converted to two-way, one-lane. The directional distribution can be obtained from the Office of Planning.
4. **PSCF** = Peak Season Conversion Factor. Many counties in Florida have a significant variance in seasonal traffic. The designer shall use the PSCF for the week in which the actual traffic count was conducted. The Office of Planning has tables showing Peak Season Conversion Factors for every county in Florida. (See sample table of values on **Exhibit 10-B, Sheet 4 of 11**).
5. **RTF** = Remaining Traffic Factor is the percentage of traffic that will not be diverted onto other facilities during a lane closure. Convert the percentage to a decimal on the Lane Closure Worksheet. This is an estimate that the designer must make on his own, or with help from the Office of Planning. Range: 0% for all traffic diverted to 100% for none diverted.
6. **G/C** = Ratio of Green to Cycle Time. This factor is to be applied when lane closure is through or within 600 ft. of a signalized intersection. The Office of Traffic Engineering has timing cycles for all traffic signals.
7. **V** = Peak Hour Traffic Volume. The designer calculates the peak hour traffic volume by multiplying the actual traffic count, times peak to daily traffic ratio, times directional factor, times peak seasonal factor, times remaining traffic factor. This calculation will give the designer the expected traffic volume of a roadway at the anticipated time of a lane closure.

Exhibit 10-B Lane Closures, Sheet 2 of 11 Symbols and Definitions (Continued)

8. **C** = Capacity of a 2L, 4L 6L, or 8L roadway with one lane closed, and the remaining lane(s) unrestricted by lateral obstructions. The capacity of a 4L, 6L, or 8L roadway is based on lane closure in only one direction (see Lane Closure Capacity Table on **Exhibit 10-B, Sheet 3 of 11**).
9. **RC** = Restricting Capacity of the above facilities by site specific limitations detailed in the Temporary Traffic Control plans which apply to travel lane width, lateral clearance and the work zone factor. The work zone factor only applies to two lane roadways (see the tables on **Exhibit 10-B, Sheet 4 of 11** to obtain the Obstruction Factor and Work Zone Factor).
10. **OF** = Obstruction Factor which reduces the capacity of the remaining travel lane(s) by restricting one or both of the following components: Travel lane width less than 12 ft. and lateral clearance less than 6 ft. (see TTC plan and Obstruction Factor Table in **Exhibit 10-B, Sheet 4 of 11**).
11. **WZF** = Work Zone Factor (WZF) is directly proportional to the work zone length (WZL). The capacity is reduced by restricting traffic movement to a single lane while opposing traffic queues. The WZF and WZL only apply to a two lane roadway converted to two way, one lane (see the Work Zone Factor Table on **Exhibit 10-B, Sheet 4 of 11**).
12. **TLW** = Travel Lane Width is used to determine the obstruction factor (see TTC plan and the Obstruction Factor Table on **Exhibit 10-B, Sheet 4 of 11**).
13. **LC** = Lateral Clearance is the distance from the edge of the travel lane to the obstruction. The lateral clearance is used to determine the obstruction factor (see TTC plans and Obstruction Factor Table on **Exhibit 10-B, Sheet 4 of 11**).

Exhibit 10-B, Lane Closures, Sheet 4 of 11
Lane Closures – Capacity Adjustment Factors
Peak Season Conversion Factor (PSCF) Sample

1998 Peak Season Factor Category Report for Tropic County							
WK	Dates	SF	PSCF	WK	Dates	SF	PSCF
9	02/22 – 02/28/98	1.14	1.48	15	04/05 – 04/11/98	0.86	1.12
10	03/01 – 03/07/98	1.04	1.35	16	04/12 – 04/18/98	0.87	1.13
11	03/08 – 03/14/98	0.94	1.22	17	04/19 – 04/25/98	0.90	1.17
12	03/15 – 03/21/98	0.83	1.08	18	04/26 – 05/02/98	0.93	1.21
13	03/22 – 03/28/98	0.84	1.09	19	05/03 – 05/09/98	0.96	1.25
14	03/29 – 04/04/98	0.85	1.11	20	05/10 – 05/16/98	0.99	1.29

Obstruction Factors (OF)

Lateral Clearance (LC) (feet)	Travel Lane Width (TLW) (feet)			
	12	11	10	9
6	1.00	0.96	0.90	0.80
4	0.98	0.94	0.87	0.77
2	0.94	0.90	0.83	0.72
0.0	0.86	0.82	0.75	0.65

Work Zone Factors (WZF)

WZL (ft.)	WZF	WZL (ft.)	WZF	WZL (ft.)	WZF
200	0.99	2200	0.87	4200	0.78
400	0.97	2400	0.86	4400	0.77
600	0.96	2600	0.85	4600	0.77
800	0.95	2800	0.84	4800	0.76
1000	0.93	3000	0.83	5000	0.75
1200	0.92	3200	0.82	5200	0.75
1400	0.91	3400	0.81	5400	0.74
1600	0.90	3600	0.80	5600	0.73
1800	0.89	3800	0.80	5800	0.73
2000	0.88	4000	0.79	6000	0.72

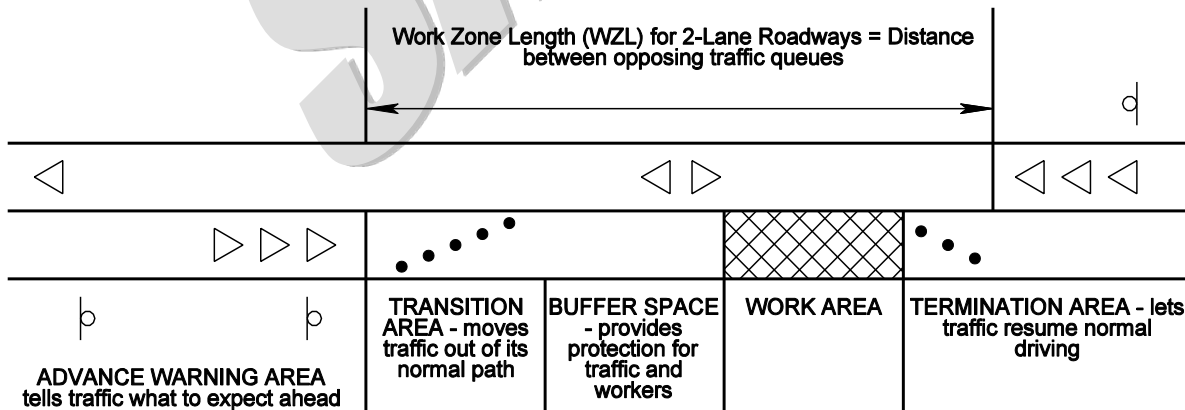

Exhibit 10-B Lane Closures, Sheet 5 of 11

LANE CLOSURES
24 HOUR COUNTS

TIME	AM HOURLY VOLUME	ATC %	PM HOURLY VOLUME	ATC %	DATE
12 - 1	_____	_____	_____	_____	_____
1 - 2	_____	_____	_____	_____	_____
2 - 3	_____	_____	_____	_____	DESIGNER _____
3 - 4	_____	_____	_____	_____	_____
4 - 5	_____	_____	_____	_____	_____
5 - 6	_____	_____	_____	_____	_____
6 - 7	_____	_____	_____	_____	_____
7 - 8	_____	_____	_____	_____	FINANCIAL PROJECT ID _____
8 - 9	_____	_____	_____	_____	_____
9 - 10	_____	_____	_____	_____	_____
10 - 11	_____	_____	_____	_____	_____
11 - 12	_____	_____	_____	_____	_____
		TOTAL	_____	_____	LOCATION _____

HOURLY VARIATION OF DAILY TRAFFIC

- CONCLUSION -
 ROUND TO THE NEAREST 1/2 HOUR CONSERVATIVELY

OPEN ROAD LANE CLOSURE

SIGNALIZED LANE CLOSURE

Exhibit 10-B Lane Closures, Sheet 6 of 11
LANE CLOSURE WORKSHEET

FINANCIAL PROJECT ID: 123456-7-89-10 FAP NO.: NA

COUNTY: Tropic DESIGNER: Yates

NO. EXISTING LANES: 2 SCOPE OF WORK: Widen

and Resurface

Calculate the peak hour traffic volume (V)

$$V = ATC \underline{15000} \times P/D \underline{0.083} \times D \underline{NA} \times PSCF \underline{1.17} \times RTF \underline{0.75} = \underline{1092}$$

LANE CLOSURE CAPACITY TABLE

Capacity (C) of an Existing 2-Lane – Converted to 2-Way, 1-Lane = 1400 VPH
 Capacity (C) of an Existing 4-Lane – Converted to 1-Way, 1-Lane = 1800 VPH
 Capacity (C) of an Existing 6-Lane – Converted to 1-Way, 2-Lane = 3600 VPH
 Capacity (C) of an Existing 8-Lane – Converted to 1-Way, 3-Lane = 5400 VPH

Factors restricting Capacity:

$$TLW \underline{10} \quad LC \underline{4} \quad WZL \underline{3200} \quad G/C \underline{0.64}$$

Calculate the Restricted Capacity (RC) at the Lane Closure Site by multiplying the appropriate 2L, 4L, 6L, or 8L Capacity (C) from the table above by the Obstruction Factor (OF) and the Work Zone Factor (WZF). If the Lane Closure is through or within 600 ft. of a signalized intersection, multiply the RC by the G/C Ratio.

$$RC \text{ (Open Road)} = C \underline{1400} \times OF \underline{0.87} \times WZF \underline{0.82} = \underline{999}$$

$$RC \text{ (Signalized)} = RC \text{ (Open Road)} \underline{999} \times G/C \underline{0.64} = \underline{639}$$

If $V \leq RC$, there is no restriction on Lane Closure

If $V > RC$, calculate the hourly percentage of ADT at which Lane Closure will be permitted

$$RC \text{ (Open Road)} \underline{999}$$

$$\text{Open Road \%} = \frac{\quad}{(ATC \underline{15000} \times D \underline{1.00} \times PSCF \underline{1.17} \times RTF \underline{0.75})} = \underline{7.59} \%$$

$$\text{Signalized \%} = \text{Open Road \%} \underline{7.59} \times G/C \underline{0.64} = \underline{4.86} \%$$

Plot 24 hour traffic to determine when Lane Closure permitted. (See **Exhibit 10-B, Sheet 7 of 11**)

NOTE: For Existing 2-Lane Roadways, D = 1.00.

Work Zone Factor (WZF) applies only to 2-Lane Roadways.

For $RTF < 1.00$, briefly describe alternate route: **25% of existing traffic diverted on Bullard Blvd., north on Newhall Lane, then east on Xanders Expressway.**

Exhibit 10-B Lane Closures, Sheet 7 of 11

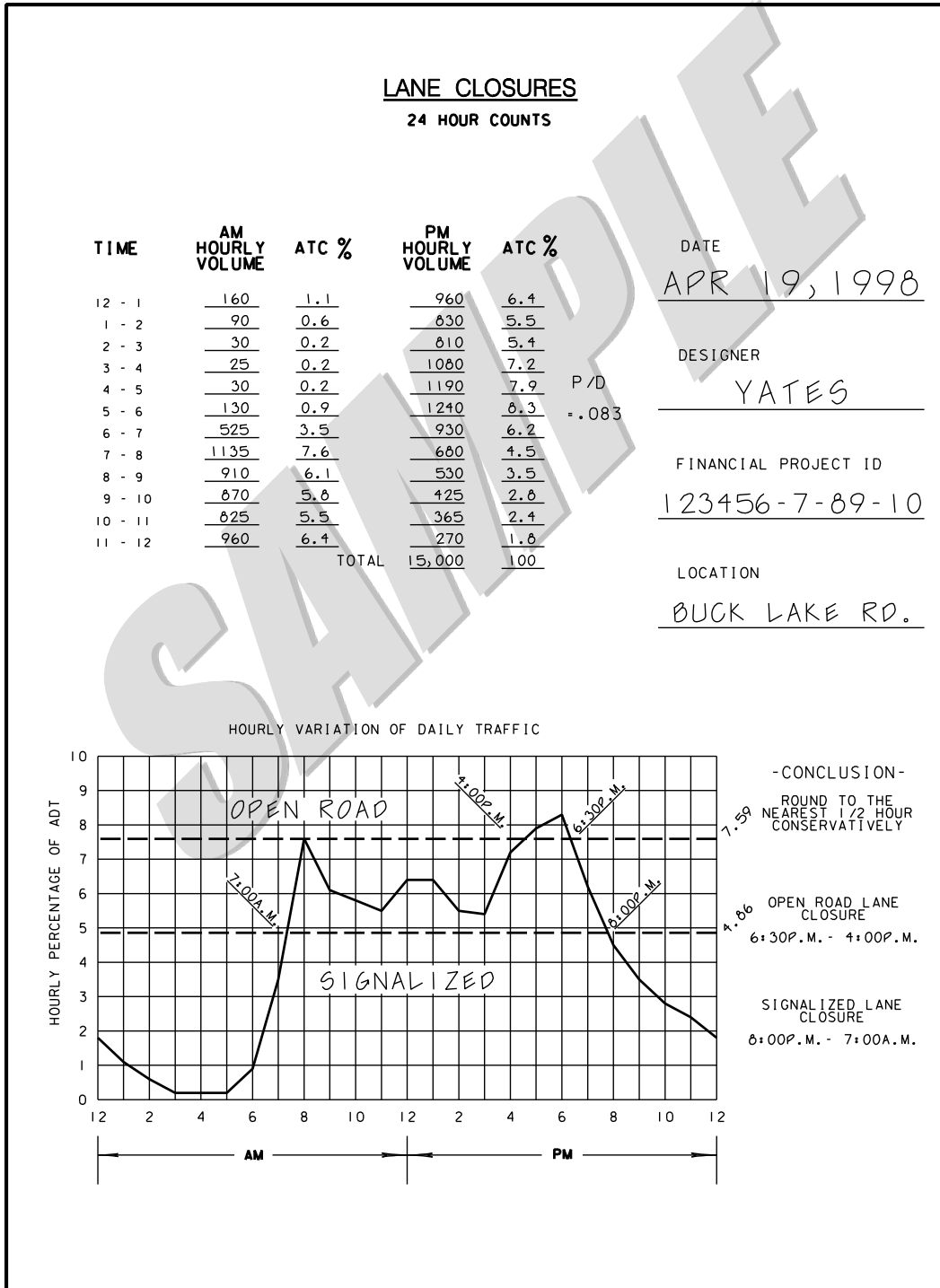

Exhibit 10-B Lane Closures, Sheet 8 of 11

LANE CLOSURE WORKSHEET

FINANCIAL PROJECT ID: 123456-7-89-10 FAP NO.: NA

COUNTY: Tropic DESIGNER: Giddens

NO. EXISTING LANES: 4 SCOPE OF WORK: Resurface

Calculate the peak hour traffic volume (V)

$$V = ATC \underline{30000} \times P/D \underline{0.083} \times D \underline{0.55} \times PSCF \underline{1.17} \times RTF \underline{1.00} = \underline{1602}$$

LANE CLOSURE CAPACITY TABLE

Capacity (C) of an Existing 2-Lane – Converted to 2-Way, 1-Lane = 1400 VPH
Capacity (C) of an Existing 4-Lane – Converted to 1-Way, 1-Lane = 1800 VPH
Capacity (C) of an Existing 6-Lane – Converted to 1-Way, 2-Lane = 3600 VPH
Capacity (C) of an Existing 8-Lane – Converted to 1-Way, 3-Lane = 5400 VPH

Factors restricting Capacity:

TLW 11 LC 6 WZL NA for 4L G/C 0.74

Calculate the Restricted Capacity (RC) at the Lane Closure Site by multiplying the appropriate 2L, 4L, 6L, or 8L Capacity (C) from the table above by the Obstruction Factor (OF) and the Work Zone Factor (WZF). If the Lane Closure is through or within 600 ft. of a signalized intersection, multiply the RC by the G/C Ratio.

$$RC \text{ (Open Road)} = C \underline{1800} \times OF \underline{0.96} \times WZF \underline{1.00} = \underline{1728}$$

$$RC \text{ (Signalized)} = RC \text{ (Open Road)} \underline{1728} \times G/C \underline{0.74} = \underline{1279}$$

If $V \leq RC$, there is no restriction on Lane Closure

If $V > RC$, calculate the hourly percentage of ADT at which Lane Closure will be permitted

RC (Open Road) 1728

$$\text{Open Road \%} = \frac{\text{RC (Open Road)}}{\text{ATC} \times P/D \times D \times PSCF \times RTF} = \underline{8.95\%}$$

$$\text{Open Road \%} = \frac{\text{RC (Open Road)}}{\text{ATC} \underline{30000} \times D \underline{0.55} \times PSCF \underline{1.17} \times RTF \underline{1.00}}$$

$$\text{Signalized \%} = \text{Open Road \%} \underline{8.95} \times G/C \underline{0.74} = \underline{6.62\%}$$

Plot 24 hour traffic to determine when Lane Closure permitted. (See **Exhibit 10-B, Sheet 9 of 11**)

NOTE: For Existing 2-Lane Roadways, D = 1.00.

Work Zone Factor (WZF) applies only to 2-Lane Roadways.

For $RTF < 1.00$, briefly describe alternate route: NA

Exhibit 10-B Lane Closures, Sheet 9 of 11

LANE CLOSURES

24 HOUR COUNTS

TIME	AM HOURLY VOLUME	ATC %	PM HOURLY VOLUME	ATC %
12 - 1	320	1.1	1920	6.4
1 - 2	180	0.6	1660	5.5
2 - 3	60	0.2	1620	5.4
3 - 4	50	0.2	2160	7.2
4 - 5	60	0.2	2380	7.9
5 - 6	260	0.9	2480	8.3
6 - 7	1050	3.5	1860	6.2
7 - 8	2270	7.6	1360	4.5
8 - 9	1820	6.1	1060	3.5
9 - 10	1740	5.8	850	2.8
10 - 11	1650	5.5	730	2.4
11 - 12	1920	6.4	540	1.8
TOTAL			30,000	100

DATE
APR 19, 1998

DESIGNER
GIDDENS

FINANCIAL PROJECT ID
123456-7-89-10

LOCATION
BUCK LAKE RD.

HOURLY VARIATION OF DAILY TRAFFIC

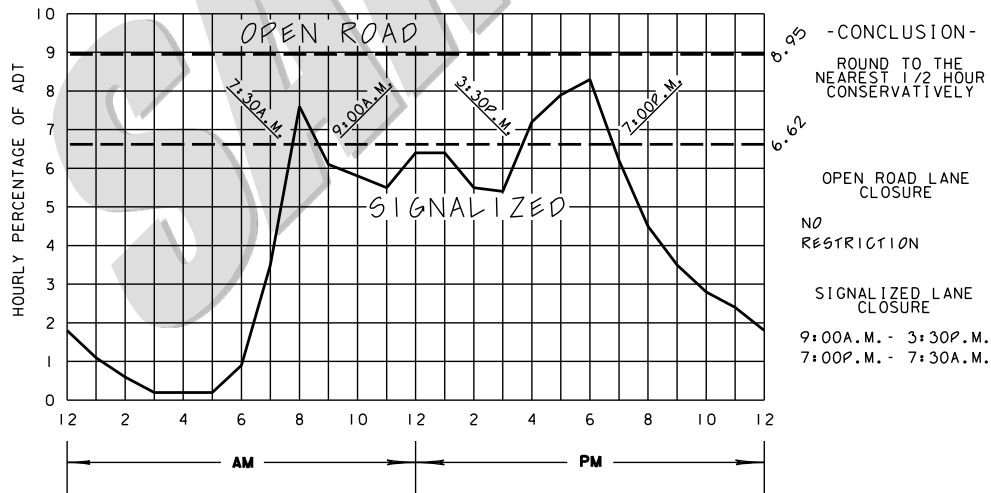

Exhibit 10-B Lane Closures, Sheet 10 of 11

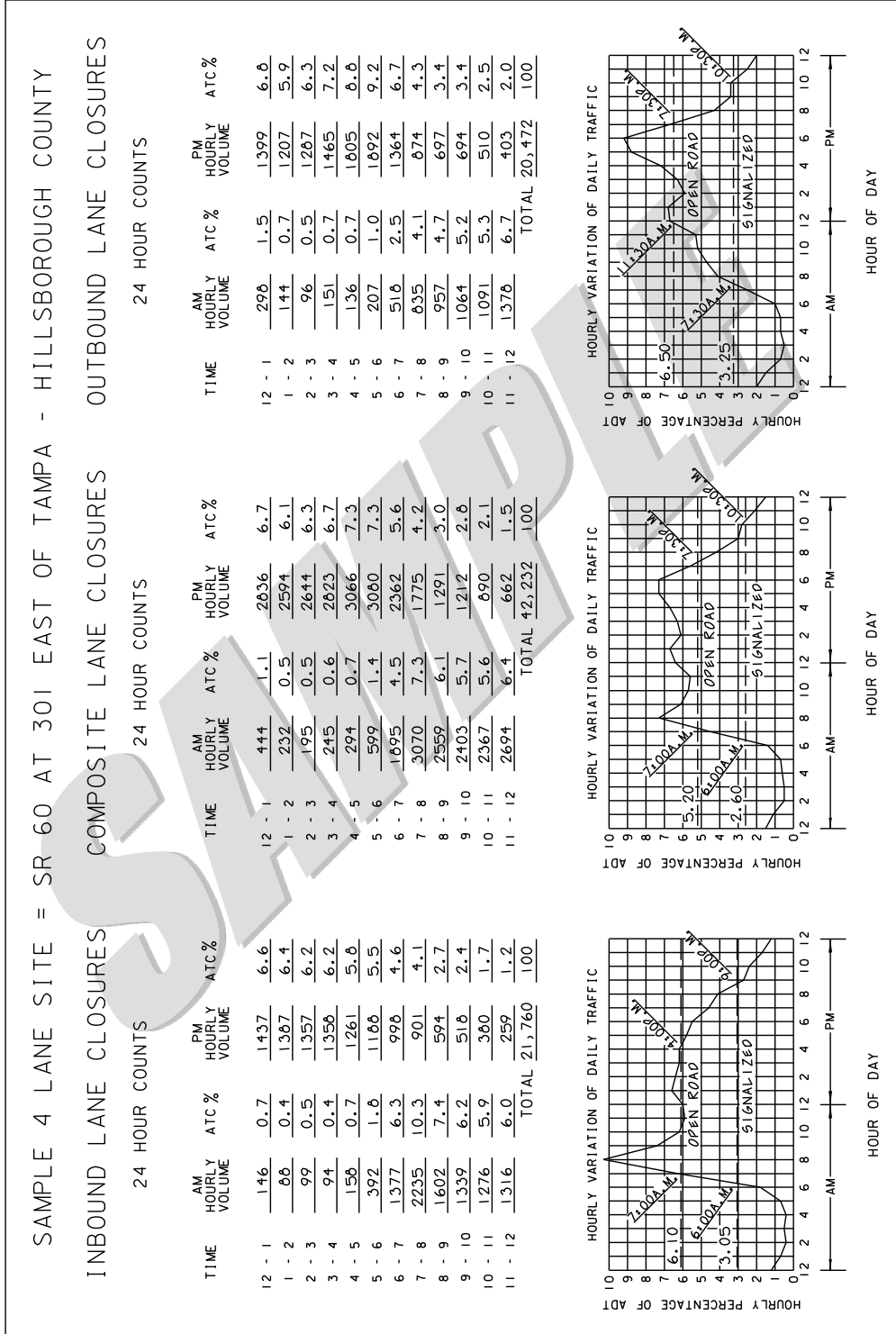

Exhibit 10-B Lane Closures, Sheet 11 of 11

LANE CLOSURE WORKSHEET SUMMARY LANE SAMPLE WITH SIGNIFICANT AM-PM PEAKS SAMPLES = INBOUND (WB), COMPOSITE (EB & WB), OUTBOUND (EB) SITE = SR 60 @ US 301 EAST OF TAMPA, HILLSBOROUGH CO.			
COMPONENT	INBOUND	COMPOSITE	OUTBOUND
ADT	21,760	42,232	20,472
P/D	0.103	0.073	0.092
D	1.00	0.60	1.00
PSCF	1.17	1.17	1.17
RTF	1.00	1.00	1.00
V	2622	2164	2203
TLW	12	12	12
LC	0	0	0
C	1800	1800	1800
OF	0.86	0.86	0.86
RC (OPEN ROAD)	1548	1548	1548
G/C	0.50	0.50	0.50
RC (SIGNAL)	774	774	774
% OPEN ROAD	6.10	5.20	6.50
% SIGNAL	3.05	2.60	3.25
LANE CLOSURE	7:00 AM	7:00 AM	11:30 AM
(OPEN ROAD)	4:00 PM	7:30 PM	7:30 PM
LANE CLOSURE	6:00 AM	6:00 AM	7:30 AM
(SIGNAL)	9:00 PM	10:30 PM	10:30 PM

10.12.8 Traffic Pacing Design

A traffic pacing design is prepared to provide adequate work time for overhead construction on limited access highways. Traffic pacing is a traffic control technique that facilitates short duration overhead work operations by pacing traffic at a slow speed for a predetermined distance upstream of the work area. The Department frequently uses this technique for installing overhead sign structures, replacing sign panels, installing cantilever trusses and, when site conditions allow, placing bridge beams. Traffic pacing may also be used by utility companies for the installation of utility crossings. Based on the required work time and other inputs such as traffic volumes, regulatory speed and pacing speed, the designer will prepare a traffic control plan that defines the allowable pacing hours, pacing distance, location of warning signs, interchange ramp closures and other critical information.

The Traffic Control Plan will document the layout and required resources for the pacing operation. The designer will assess the geometric conditions to ensure that sight distance and other geometric conditions are addressed. [Design Standards, Index 655](#) provides a basis for the traffic pacing operation and the development of the Traffic Control Plan. **Index 655** includes details of the four stages of a pacing operation and additional information related to:

1. Signing
2. Use of changeable message signs and attenuators
3. Use of traffic control officers
4. Contractor requirements

If it is determined that a pacing operation will be used, the designer must obtain concurrence from the Captain of the Florida Highway Patrol troop who will assist in the operation.

Exhibit 10-C contains definitions, and the procedure for calculating the pacing distance and the time intervals during which a pacing operation will be allowed.

Exhibit 10-C Traffic Pacing Sheet 1 of 12

Definitions

1. **HTD** = Hourly Traffic Demand in vehicles / hour. Hourly traffic volumes will be required for each hour in the analysis period. Hourly traffic volumes may be obtained from the Project Traffic Report, the Office of Planning or from field data collection. Use the most recent values available.
2. **t_w** = Work Duration in minutes. This is the work time allotted for overhead construction. This value is usually between 10 and 30 minutes, and input in 5 minute increments.
3. **S_p** = Pacing Speed in MPH. This is the speed that the pacing vehicles travel and is usually 10, 15 or 20 MPH.
4. **S_r** = Regulatory Speed in MPH. This is the posted speed on the roadway segment.
5. **L** = Total Pacing Distance in miles. This is the total distance that the pacing vehicles are traveling at the pacing speed. It includes the distance required to clear traffic past the work area, and the distance required to provide the work duration. This distance is measured upstream from the work area.
6. **FHV** = Heavy-vehicle adjustment factor. This factor is used to convert hourly traffic to equivalent passenger cars. Heavy vehicles include trucks, busses and recreational vehicles.
7. **P_t** = Percent Trucks (%).
8. **FLOW_A** = Traffic Demand Flow Rate in passenger cars per hour per lane. This is the traffic flow rate approaching the pacing operation from the upstream direction.
9. **FLOW_B** = Forced Traffic Flow Rate in passenger cars per hour per lane. This is the traffic flow rate within the queue.
10. **FLOW_C** = Congested Traffic Flow Rate in passenger cars per hour per lane. This is the traffic flow rate of the vehicles escaping the queue.
11. **QGR** = Queue Growth Rate in MPH. The rate that the queue grows from the time the pacing operation begins until the pace cars exit the roadway.

Exhibit 10-C Traffic Pacing, Sheet 2 of 12

Definitions (Continued)

12. **QDR** = Queue Dissipation Rate in MPH. The rate that the queue dissipates after the pace cars exit the roadway.
13. **SW_A** = Speed of Shockwave 'A' in MPH. The speed of the shockwave at the boundary between traffic 'FLOWA' and traffic 'FLOWB'.
14. **SW_B** = Speed of Shockwave 'B' in MPH. The speed of the shockwave at the boundary between traffic 'FLOWB' and traffic 'FLOWC'.
15. **DENSITY_A** = Free Flow Density in vehicles / mile. The traffic density under free flow conditions.
16. **DENSITY_B** = Forced Flow Density in vehicles per mile. The traffic density under forced flow conditions.
17. **DENSITY_C** = Congested Flow Density in vehicles per mile. The traffic density under congested flow conditions.
18. **N** = Number of Lanes
19. **T_{total}** = Total time to conduct the pacing operation. The time from when the pace cars enter the roadway until the queue has dissipated and normal traffic flow is restored.
20. **ATC** = Actual Traffic Counts. Traffic counts can be obtained from the Office of Planning or collected on the project site. The designer needs hourly traffic volumes for a 24 hour period.
21. **PSCF** = Peak Season Conversion Factor. The Office of Planning publishes tables with the PSCF for each county in Florida. Each county table has a PSCF for the week that the traffic counts were collected. The factor converts the ATC to Peak Season Traffic representing the highest daily traffic for the year.
22. **AADT** = Annual Average Daily Traffic. In lieu of actual traffic counts, use AADT provided by the Office of Planning. Adjust the AADT to peak season hourly traffic by applying the model correction factor and the hourly distribution factors.

Exhibit 10-C Traffic Pacing, Sheet 3 of 12

Definitions (Continued)

23. **MOCF** = Model Correction Factor. The MOCF converts AADT to peak season traffic.
24. **HDF** = Hourly Distribution Factors. Multiply the AADT by the HDT to obtain the traffic volume for a particular hour. The Office of Planning publishes hourly distribution factors for regions of the state.
25. **C** = Capacity. The capacity of the roadway under free flow conditions in passenger cars per hour per lane.
26. **Pc/h/l_n** = passenger cars per hour per lane. Pc/h/l_n represents the traffic volume or capacity of one lane adjusted for heavy vehicles.
27. **T_D** = Time to dissipate the queue in minutes. TD is the amount of time beginning at the point when the pacing vehicles leave the roadway until the traffic returns to normal operating conditions.
28. **Q_{max}** = the maximum queue length. The maximum queue length occurs when the pacing vehicles reach the work zone.
29. **Speed_c** = the average speed of passenger cars when the roadway reaches capacity.

Exhibit 10-C Traffic Pacing, Sheet 4 of 12

Worksheets

FINANCIAL PROJECT ID: _____ FAP NO: _____

COUNTY: _____ DESIGNER: _____

STATE ROAD / LOCAL ROAD NAME: _____

SCOPE OF WORK: _____

SECTION NO: _____ MILE POST LIMITS: _____

DIRECTION OF TRAVEL (NB, SB, EB or WB): _____

Project Inputs:

1. Regulatory Speed (S_r) = _____
2. Pacing Speed (S_p) = _____
3. Work Duration (t_w) = _____
4. Number of Lanes (N): _____
5. Percent Trucks (P_t): _____
6. Peak Season Conversion Factor (PSCF) or
7. Model Correction Factor (MOCF) = _____
8. 24-hour Traffic Volumes:

Hour	AM Traffic Volume	Hour	PM Traffic Volume
24 - 1		12-13	
1 - 2		13-14	
2 - 3		14-15	
3 - 4		15-16	
4 - 5		16-17	
5 - 6		17-18	
6 - 7		18-19	
7 - 8		19-20	
8 - 9		20-21	
9 -10		21-22	
10-11		22-23	
11-12		23-24	

Exhibit 10-C Traffic Pacing, Sheet 5 of 12

Worksheets (Continued)

STEP 1: Calculate the hourly percentage of peak season traffic for each hour of the day (in pcphpl) and plot the 24 hour traffic percentages.

A. Calculate the Heavy Vehicle Adjustment Factor, $F_{HV} = 1 + \left(\frac{P_t}{100}\right) 0.5$

B. If using actual traffic counts calculate the hourly traffic demand as follows:

$$HTD_i = \frac{(ATC_i)(PSCF)(F_{HV})}{N}$$

If using Annual Average Daily Traffic calculate the hourly traffic demand as follows:

$$HTD_i = \frac{(AADT)(MOCF)(HDF)(F_{HV})}{N}$$

C. Calculate the percent capacity, $\%C = \frac{HTD_i}{C} (100)$ where:

C = 2,400 pc/h/ln for 70 mph regulatory speed

C = 2,300 pc/h/ln for 65 mph regulatory speed

C = 2,250 pc/h/ln for 60 mph regulatory speed

C = 2,220 pc/h/ln for 55 mph regulatory speed

C = 2,150 pc/h/ln for 50 mph regulatory speed

Hour	AM Hourly Traffic Demand	Percent Capacity	Hour	PM Hourly Traffic Demand	Percent Capacity
24 - 1			12-13		
1 - 2			13-14		
2 - 3			14-15		
3 - 4			15-16		
4 - 5			16-17		
5 - 6			17-18		
6 - 7			18-19		
7 - 8			19-20		
8 - 9			20-21		
9 - 10			21-22		
10-11			22-23		
11-12			23-24		

Exhibit 10-C Traffic Pacing, Sheet 6 of 12

Worksheets (Continued)

HOURLY VARIATION OF DAILY TRAFFIC

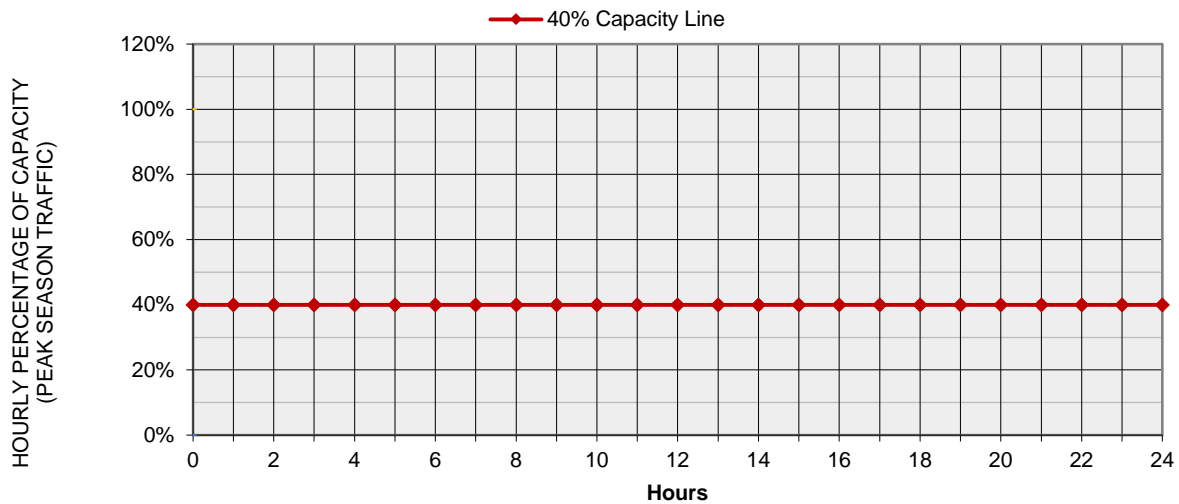

STEP 2: Calculate the Pacing Length, L.

$$L = S_p \left(\frac{t_w}{60} \right) \left(\frac{S_p}{S_r - S_p} + 1 \right)$$

STEP 3: Calculate the Maximum Queue Length, Q_{max}

$$FLOW_A = HTD_i$$

$$DENSITY_A = \frac{FLOW_A}{S_r}$$

$$FLOW_B = 1,800 \text{ pcphph (based on a 2.0 sec headway)}$$

$$DENSITY_B = \frac{FLOW_B}{S_p}$$

$$SW_A = \frac{FLOW_B - FLOW_A}{DENSITY_B - DENSITY_A}$$

$$QGR = S_p - SW_A$$

$$Q_{max} = QGR \left(\frac{L}{S_p} \right)$$

Exhibit 10-C Traffic Pacing, Sheet 7 of 12
Worksheets (Continued)

STEP 4: Calculate the Time to Dissipate the Queue, T_D .

$$FLOW_C = 2,400 \text{ pcphpl (assumed capacity value)}$$

$$DENSITY_C = \left(\frac{FLOW_C}{Speed_C} \right) \text{ where:}$$

$$Speed_C = 53 \text{ mph (for 70 mph regulatory speed)}$$

$$Speed_C = 50 \text{ mph (for 50 – 65 mph regulatory speed)}$$

$$SW_B = \left(\frac{FLOW_C - FLOW_B}{DENSITY_C - DENSITY_B} \right)$$

$$QDR = SW_A - SW_B$$

$$T_D = \left(\frac{Q_{max}}{QDR} \right) 60$$

STEP 5: Calculate the Total Time to Conduct the Pacing Operation, T_{total} .

$$T_{total} = \left(\frac{L}{S_p} \right) 60 + T_D$$

Label the pacing window chart by designating the time(s) that a pacing operation can begin and the time(s) after which a pacing operation cannot begin. The time that a pacing operation can begin is the point at which the percent capacity falls below 40%. The time after which a pacing operation cannot be started is the point at which the percent capacity reaches 40% minus T_{total} . Use one hour increments only.

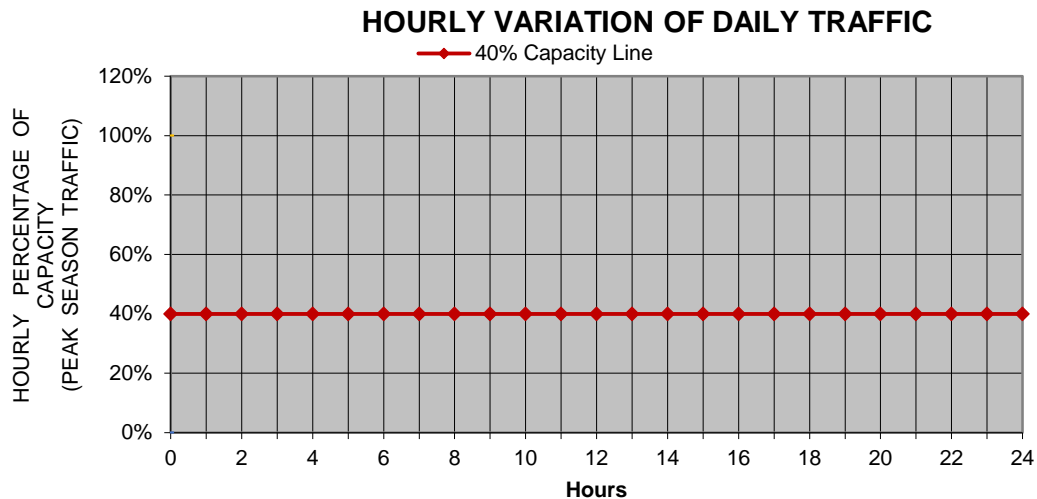

Exhibit 10-C Traffic Pacing, Sheet 8 of 12
Worksheets (Continued)

FINANCIAL PROJECT ID: 123456-7-89-10 FAP NO: NA
COUNTY: Tropic DESIGNER: John Smith
STATE ROAD / LOCAL ROAD NAME: I-4 @ Lee Road
SCOPE OF WORK: Replace Overhead Sign
SECTION NO: 75280 MILE POST LIMITS: 2.300
DIRECTION OF TRAVEL (NB, SB, EB or WB): East Bound

Project Inputs:

1. Regulatory Speed (S_r) = 65 MPH
2. Pacing Speed (S_p) = 20 MPH
3. Work Duration (t_w) = 25 minutes
4. Number of Lanes (N) = 3
5. Percent Trucks (P_t) = 6.71
6. Peak Season Conversion Factor (PSCF) = 1.04
7. 24-hour Traffic Volumes:

Hour	AM Traffic Volume	Hour	PM Traffic Volume
24 - 1	1406	12-13	6118
1 - 2	772	13-14	6390
2 - 3	599	14-15	6771
3 - 4	591	15-16	6675
4 - 5	942	16-17	6607
5 - 6	2116	17-18	5989
6 - 7	5666	18-19	5810
7 - 8	7302	19-20	5078
8 - 9	7173	20-21	4139
9 - 10	6719	21-22	3563
10-11	6275	22-23	3008
11-12	6067	23-24	2276

Exhibit 10-C Traffic Pacing, Sheet 9 of 12
Worksheets (Continued)

STEP 1: Calculate the hourly percentage of peak season traffic for each hour of the day (in pcphpl) and plot the 24 hour traffic percentages.

A. Calculate the Heavy Vehicle Adjustment Factor,

$$F_{HV} = 1 + \left(\frac{P_t}{100}\right) 0.5 = 1 + \left(\frac{6.71}{100}\right) 0.5 = 1.034$$

B. Using actual traffic counts calculate the hourly traffic demand (*Hour 1 shown*)

$$HTD_i = \frac{(ATC_i)(PSCF)(F_{HV})}{N}$$

$$HTD_1 = \frac{(1406)(1.04)(1.034)}{3} = 504 \text{ pcphpl}$$

C. Calculate the percent capacity, $\%C = \frac{HTD_1}{C} \times 100$ where:

$C = 2,300$ pc/h/ln for 65 mph regulatory speed (*Hour 1 shown*)

$$\%C = \frac{HTD_1}{C} \times 100 = \frac{504}{2300} \times 100 = 21.9\%$$

Hour	AM Hourly Traffic Demand	Percent Capacity	Hour	PM Hourly Traffic Demand	Percent Capacity
24 - 1	504	21.90%	12-13	2193	95.40%
1 - 2	277	12.00%	13-14	2290	99.90%
2 - 3	215	9.40%	14-15	2427	105.50%
3 - 4	212	9.20%	15-16	2393	104.00%
4 - 5	338	14.70%	16-17	2368	104.00%
5 - 6	758	33.00%	17-18	2147	93.30%
6 - 7	2031	88.30%	18-19	2083	90.60%
7 - 8	2617	113.80%	19-20	1820	79.10%
8 - 9	2571	111.80%	20-21	1484	64.50%
9 -10	2408	104.70%	21-22	1277	55.50%
10-11	2249	97.80%	22-23	1078	46.90%
11-12	2174	94.60%	23-24	816	35.50%

Exhibit 10-C Traffic Pacing, Sheet 10 of 12
Worksheets (Continued)

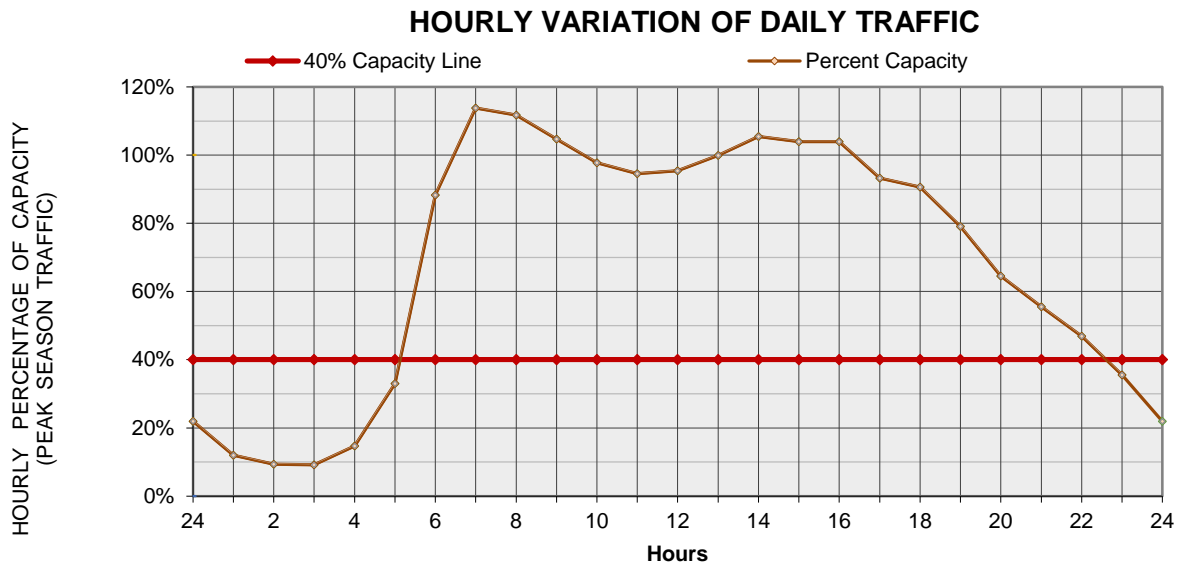

STEP 2: Calculate the Pacing Length, L .

$$L = S_p \left(\frac{t_w}{60} \right) \left(\frac{S_p}{S_r - S_p} + 1 \right) = 20 \left(\frac{25}{60} \right) \left(\frac{20}{65 - 20} + 1 \right) = 12.04 \text{ miles}$$

STEP 3: Calculate the Maximum Queue Length, Q_{max} , for hour 5 (4am to 5am).

$$FLOW_A = HTD_5 = 338$$

$$DENSITY_A = \frac{FLOW_A}{S_r} = \frac{338}{65} = 5.20 \frac{pc}{mi} / l$$

$$FLOW_B = 1,800 \text{ pcphpl (based on a 2.0 sec headway)}$$

$$DENSITY_B = \frac{FLOW_B}{S_p} = \frac{1800}{20} = 90 \frac{pc}{mi} / l$$

$$SW_A = \frac{FLOW_B - FLOW_A}{DENSITY_B - DENSITY_A} = \frac{1800 - 338}{90 - 5.20} = 17.24 \text{ mph}$$

$$QGR = S_p - SW_A = 20 - 17.24 = 2.76 \text{ mph}$$

$$Q_{max} = QGR \left(\frac{L}{S_p} \right) = 2.76 \left(\frac{12.04}{20} \right) = 1.66 \text{ miles}$$

Exhibit 10-C Traffic Pacing, Sheet 11 of 12
Worksheets (Continued)

STEP 4: Calculate the Time to Dissipate the Queue, T_D .

$$FLOW_C = 2,400 \text{ pcphpl (assumed capacity value)}$$

$$DENSITY_C = \left(\frac{FLOW_C}{Speed_C} \right) \text{ where:}$$

$$Speed_C = 50 \text{ mph (for 50 - 65 mph regulatory speed)}$$

$$DENSITY_C = \left(\frac{FLOW_C}{Speed_C} \right) = \left(\frac{2400}{50} \right) = 48 \frac{pc}{mile}$$

$$SW_B = \left(\frac{FLOW_C - FLOW_B}{DENSITY_C - DENSITY_B} \right) = \left(\frac{2400 - 1800}{48 - 90} \right) = -14.29$$

$$QDR = SW_A - SW_B = 17.24 - (-14.29) = 31.53 \text{ mph}$$

$$T_D = \left(\frac{Q_{max}}{QDR} \right) 60 = \left(\frac{1.66 \text{ mi}}{31.53 \text{ mph}} \right) 60 = 3.16 \text{ min}$$

STEP 5: Calculate the Total Time to Conduct the Pacing Operation, T_{total} .

$$T_{total} = \left(\frac{L}{S_p} \right) 60 + T_D = \left(\frac{12.04}{20} \right) 60 + 3.16 = 39.3 \text{ min}$$

HOURLY VARIATION OF DAILY TRAFFIC

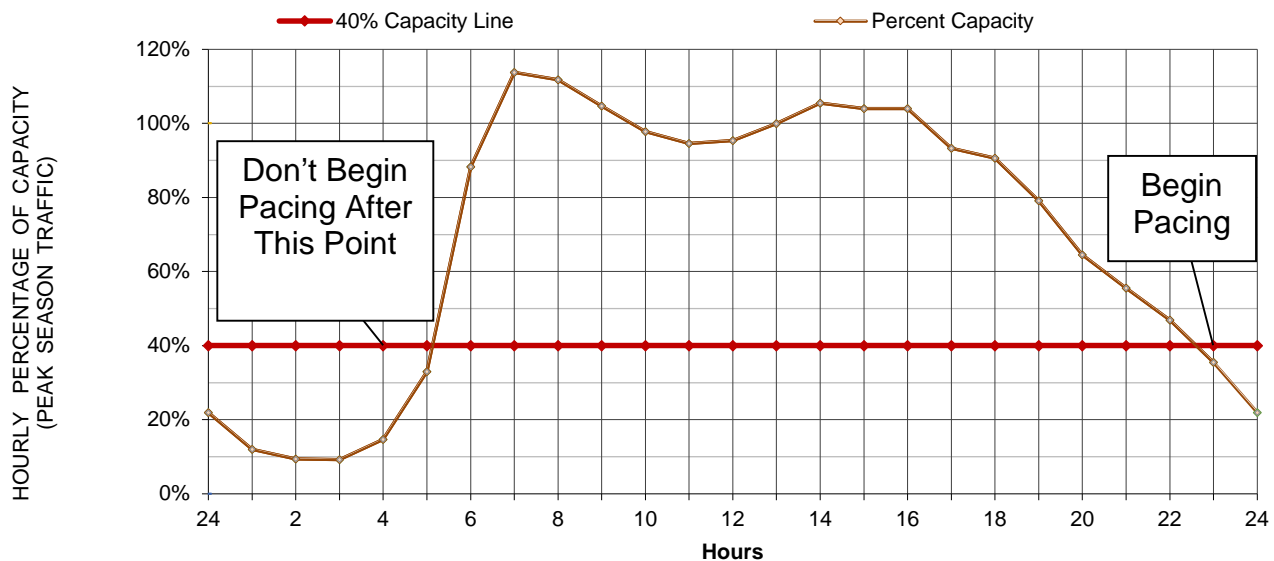

Exhibit 10-C Traffic Pacing, Sheet 12 of 12

Worksheets (Continued)

Traffic Pacing Report

I-4 at Lee Road (Section 75280 EB)
 Sign Replacement at mile post 2.300

Regulatory Speed = 65 mph
 Pacing Speed = 20 mph
 Work Duration = 25 min

Number of Lanes = 3
 Percent Trucks = 6.71
 Traffic Demand:

Hour	AM Hourly Traffic Demand	Percent Capacity	Hour	PM Hourly Traffic Demand	Percent Capacity
24 - 1	504	21.90%	12-13	2193	95.40%
1 - 2	277	12.00%	13-14	2290	99.90%
2 - 3	215	9.40%	14-15	2427	105.50%
3 - 4	212	9.20%	15-16	2393	104.00%
4 - 5	338	14.70%	16-17	2368	104.00%
5 - 6	758	33.00%	17-18	2147	93.30%
6 - 7	2031	88.30%	18-19	2083	90.60%
7 - 8	2617	113.80%	19-20	1820	79.10%
8 - 9	2571	111.80%	20-21	1484	64.50%
9 - 10	2408	104.70%	21-22	1277	55.50%
10-11	2249	97.80%	22-23	1078	46.90%
11-12	2174	94.60%	23-24	816	35.50%

HOURLY VARIATION OF DAILY TRAFFIC

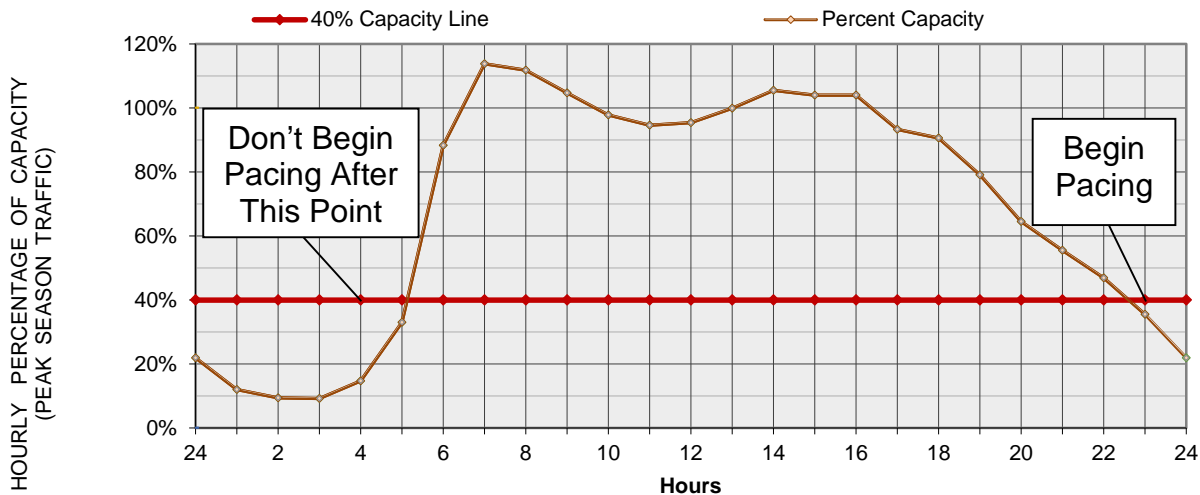

10.12.9 Detours, Diversions, and Lane Shifts

A **detour** is the redirection of traffic onto an alternate route, using state roads, county roads, or city streets, to bypass the work zone. A **diversion** is a special detour onto a temporary roadway adjacent to the existing or permanent roadway. A **lane shift** is the redirection of traffic onto a different section of the permanent roadway or shoulder.

Detour signing is usually done under the direction of the traffic engineer who has authority over the roadway to be used. The detour must be signed clearly so drivers can traverse the entire detour and return to the original roadway. When detours are required, the geometry of the detour route must be compared against the type of traffic being routed through the detour. For example, detouring of traffic which includes large trucks and transit vehicles will require certain pavement widths, turning radius, and overhead clearance (including low power lines, span wires, and low hanging tree limbs). The structural capacity of the detour pavement should also be considered.

When proposing a temporary ACROW panel bridge as part of the MOT Plan, incorporate appropriate signage in the MOT plan to restrict those temporary bridges to legal weight limits only. The sign must read "legal weight only". All bridge weight restriction signs must be in conformance with [Design Standards, Indexes 17355](#) and [17357](#). Place "Slippery When Wet" (W8-5) signs in advance of all ACROW panel bridges. Detours rerouting vehicles exceeding legal weights where temporary ACROW type bridges are present must be coordinated through the Office of Maintenance.

When detours are off of the state system, the designer must coordinate with the local agency. The designer must document that the local agency approves the detour route. The design must prevent or minimize interruption of local transit operations and emergency services. The designer must coordinate with any affected local transit operations and emergency services and must document that the affected agencies have been informed of the detour route.

A Special Detour is a diversion or lane shift that requires temporary pavement. Payment for the work of constructing, maintaining, and subsequently removing the special detour (earthwork, base, asphalt, etc.) will be paid for as a Special Detour, Pay Item 102-2 (Lump Sum). Traffic control devices, warning devices, barriers, signing, and pavement markings for special detours are to be tabulated in the plans and paid for under their respective pay items. Reference the [Basis of Estimates Manual](#) to make sure that the appropriate items are included in this lump sum.

Modification for Non-Conventional Projects:
Delete the above paragraph.

Include sufficient detail for diversion geometry and temporary drainage in TTC plans. Provide a minimum 2 ft paved shoulder for diversions and lane shifts. For offsets to barriers and special considerations (i.e. refuge areas or emergency vehicle access), see **Chapter 4** of this Volume. Show the radius of curvature and taper lengths. Diversions must be designed and operated as close to the normal speed as possible. When speed reductions are necessary, the reduction must be in accordance with the [Design Standards, Index 600](#). The recommended minimum radius of curvature (without superelevation) for diversions is shown in **Table 10.3**.

10.12.10 Roadside Hazards

For definitions of roadside hazards and the required shielding of these hazards, see **Chapter 4** of this Volume and [Design Standards, Index 600](#).

10.12.11 Drop-offs in Work Zones

See **Chapter 4** of this Volume for requirements related to drop-offs in work zones.

10.12.12 Narrow Bridges and Roadways

See **Chapter 4** of this Volume for additional guidance and considerations for placing temporary barrier.

10.12.13 Existing Highway Lighting

Use the following design guidelines to determine how existing highway lighting is to be preserved during construction:

1. Design for and designate a construction phasing that calls for the new or relocated lighting system to be constructed and placed in service before the existing lighting system is removed or taken out of service.

2. Design a temporary lighting system that is located beyond the required lateral offset.
3. Design a temporary lighting system which utilizes structural supports that are crashworthy or shielded by a crashworthy barrier that was installed for other purposes.
4. Design a temporary lighting system that is attached to and located behind, permanent or temporary concrete barriers/traffic railings and that meets the illumination requirements per **Section 7.3** of this Volume. Do not install Temporary Barrier Wall for the sole purpose of supporting or protecting the temporary lighting system.
 - Design temporary lighting attached to and located behind permanent or temporary concrete barriers/railings as follows:
 - Do not locate structural supports for temporary lighting on the back side of permanent or temporary barriers/traffic railings, i.e. which face away from traffic, where the back side of the barriers/traffic railings are within the lateral offset of other traffic lanes.
 - Attach structural supports to the back face of temporary and permanent barriers/traffic railings using brackets that do not protrude above the top of the barrier/traffic railing.
 - Use undercut anchor systems designed in accordance with **Structures Design Guidelines Section 1.6** to attach brackets to barriers/traffic railings. Position anchors so as to avoid the reinforcing steel within the barrier/traffic railing.
 - Design the luminaire pole, support brackets and anchors for a 70 mph wind speed.
 - Do not design luminaire pole, support brackets and anchors for vehicular impact loads.
 - For structural supports attached behind permanent concrete barriers/traffic railings, provide a minimum setback distance from the top edge of the traffic face of the barrier/traffic railing to the traffic face of the luminaire pole in accordance with **Figure 4.4.13** (see **Section 4.4** of this Volume).
 - For structural supports attached to and located behind **Design Standards, Index 414** (Type K Temporary Concrete Barriers), provide a minimum setback distance of 1'-6" from the top edge of the traffic face of the barrier to the traffic face of the luminaire pole. To minimize the potential for damaging reinforcing steel during the installation of the anchors, attach

brackets within the middle portion, where there is large spacing between the vertical steel reinforcing bars, of the Type K Barrier Unit.

- Structural supports for temporary lighting may be attached to and located behind Type K Temporary Concrete Barrier that is bolted or staked down utilizing the details shown on the standard.
 - The supports attached to Type K Temporary Concrete Barrier must not encroach into the required deflection distance when the barrier is protecting an above ground hazard.
5. Do not design temporary lighting if steps 1 thru 4 cannot be achieved.

10.12.14 Work Area Access

The TTC plan will evaluate consider the need for a work area access plan. This is a constructability issue in which the designer addresses the question of how the contractor is to get materials and equipment into the work area safely. This is a particularly critical issue on high speed facilities (such as the Interstate) where barrier wall is used to protect median work areas. Evaluate the need for the design and construction of temporary acceleration and deceleration lanes for the construction equipment. The following must be evaluated in the design, planning and operation of work zones.

1. Anticipate types of work zones likely to create ingress/egress problems. Examples are median work spaces requiring work vehicles to merge into/out of high-speed traffic and work activities that will generate frequent delivery of materials such as paving projects and the delivery of fill material.
2. Include access to the work area in TTC Plan. When operations require access and it is not addressed in the plan, the Worksite Traffic Supervisor in the field must address the issue within the limits of their authority.
3. Consider construction vehicle size, configuration and turning path/radius requirements in addressing ingress/egress.
4. For haul route crossing details see [Design Standards, Index 606](#). For non-limited access facilities crossover details see [Design Standards, Index 630](#) and [631](#); for limited access facilities see [Design Standards, Index 665](#).
5. Adequate acceleration/deceleration space for work vehicles should be provided.
6. The location of access openings must provide good sight distance for oncoming traffic.

7. In extreme conditions lane closures must be evaluated.
8. Openings in barrier walls must be planned to ensure that ends are properly protected and that the walls do not create sight problems.
9. Ingress/egress condition may justify lowering the speed limit.
10. Warning signs for truck ingress/egress conditions are available ([Design Standards, Index 600](#)) and must be used when appropriate. Special warning signs may be necessary.
11. Evaluate the use of portable changeable message signs.

10.12.15 Railroads

Evaluate railroad crossings that are affected by a construction project to ensure that the Temporary Traffic Control Plan does not cause queuing of traffic across the railroad tracks. Evaluate the Plan's signal timing, tapers, lane closures and distance to intersections as compared to projected peak traffic volumes. The effects of the temporary traffic control plan on interconnected traffic signals and railroad signals must be evaluated to avoid conflicting or ineffective signal controls.

10.12.16 Temporary Raised Rumble Strip Sets

Use temporary raised rumble strips in accordance with [Design Standards, Index 603](#).

10.12.17 Pay Items and Quantities

The [Basis of Estimates Manual](#) contains detailed instructions on calculating many of the MOT quantities.

Modification for Non-Conventional Projects:

Delete PPM 10.12.17 .

10.13 Speed Zoning

10.13.1 Regulatory Speeds in Work Zones

Establish regulatory speeds to route vehicles safely through the work zone as close to normal highway speeds as possible. Temporary Traffic Control Plans (TTC plans) for all projects must include specific regulatory speeds for each phase of work. This can either be the posted speed or a reduced speed. Note the speed in the TTC plans: this includes indicating the existing speed if no reduction is made. By virtue of **Florida Statute 316.187**, all regulatory speeds must be established on the basis of a traffic and engineering investigation. Designers must only reduce speed when the temporary geometry requires it. The justification for establishing work zone regulatory speeds different from normal speed limits must be included in the project file. The TTC plan and the project file will suffice as the traffic and engineering investigation.

When field conditions warrant speed reductions different from those shown in the TTC plan, the contractor must submit to the construction project engineer for approval by the Department, a signed and sealed study to justify the need for further reducing the posted speed. Otherwise, the engineer may request the District Traffic Operations Engineer (DTOE) to investigate the need. It will not be necessary for the DTOE to issue regulations for regulatory speeds in work zones due to the revised provisions of **Florida Statute 316.0745(2)(b)**.

Modification for Non-Conventional Projects:
Delete last two sentences in the above paragraph.

Regulatory speed signs in rural areas (Interstate and Non-Interstate) are to be preceded by a "Reduced Speed Ahead" sign positioned as follows:

- Interstate (Rural) - 1000 ft. in advance
- Non-Interstate (Rural) - 500 ft. in advance

Urban areas, ordinarily do not require an advance sign, however, the sign may be included at the designer's option.

The regulatory speed and “Reduced Speed” Ahead signs are to be paid for under the pay item for Construction Work Zone Signs (per each per day).

Modification for Non-Conventional Projects:

Delete the above sentence.

If the existing regulatory speed is to be used, consideration should be given to supplementing the existing signs when the construction work zone is between existing regulatory speed signs. For projects where the reduced speed conditions exist for greater than 1 mile in rural areas (Non-Interstate) and on Rural or Urban Interstate, additional regulatory speed signs are to be placed at no more than 1 mile intervals. Engineering judgment should be used in the placement of additional signs. For urban situations (Non-Interstate), additional regulatory speed signs are to be placed at a maximum of 1000 ft. apart.

The regulatory speed must not be reduced more than 10 mph below the posted speed, and never below the minimum statutory speed for the class of facility, without the approval of the District Traffic Operations Engineer and the appropriate District Director (See the [Design Standards, Index 600](#)).

On projects with interspaced work activities (such as interstate resurfacing), speed reductions must be located in proximity to those activities which merit a reduced speed, and not “blanketed” for the entire project.

The TTC plan phase notes must indicate when to remove the regulatory reduced speed limit signs.

When the regulatory speed is changed in a work zone, the permanent speed limit signs are to be removed or covered during the period when the work zone regulatory speed zones are in effect.

10.14 Law Enforcement Services

Work zones may require law enforcement services to protect both the workers and motorists during construction or maintenance activities. Evaluate the need for these services during the development of the TTC plans. The service needed must involve a Speed and Law Enforcement Officer for speed and traffic enforcement, a Traffic Control Officer for traffic control, or a combination of the two.

FDOT and the Florida Department of Highway Safety and Motor Vehicles (DHSMV) have a contractual agreement for the use of Speed and Law Enforcement Officers (Central Office Statewide Contract) to exclusively enforce the speed limit in specified work zones (see **Contract #BDT99**). Each district may enter into their own contractual agreements with local law enforcement agencies to provide additional resources for the use of a Speed and Law Enforcement Officer (District Contract).

Use Traffic Control Officers for traffic control only as described in **Specification 102**. Acquire the Traffic Control Officer from local law enforcement agencies or the Florida Highway Patrol. Do not use such traffic control law enforcement services for patrolling or speed enforcement.

10.14.1 Use of Speed and Law Enforcement Officers

Conditions to evaluate the use of Speed and Law Enforcement Officer include, but are not limited to:

1. A work zone requiring reduced speeds
2. Work zones where barrier wall is used adjacent to through traffic
3. Night time work zones
4. A work zone in which workers are exposed to nearby high speed traffic

10.14.2 Use of Traffic Control Officer

There are certain construction activities that impede traffic flows such that supplemental traffic control is desirable. Uniformed law enforcement officers are respected by motorists; therefore, utilize Traffic Control Officers as a supplement to traffic control devices to assist the motorists and provide a safer work zone.

By specification, use Traffic Control Officers for the following conditions:

1. Directing traffic/overriding the signal in a signalized intersection.
2. When ***Design Standards, Index No. 619*** is used on freeway facilities (interstates, toll roads, and expressways) at nighttime for work within the travel lane.
3. When ***Design Standards, Index No. 655*** (Traffic Pacing) for overhead work is called for in the Plans or approved by the Engineer.

4. When pulling conductor/cable above an open traffic lane on limited access facilities, when called for in the Plans or approved by the Engineer.
5. When [Design Standards, Index No. 625](#) (Temporary Road Closure 5 Minutes or Less) is used.

10.14.3 Coordination, Documentation and Payment

Coordinate with the district construction office to determine if law enforcement services will be justified. If possible, include the associated law enforcement commander in the coordination.

Once the determination has been made that law enforcement will be used on a project, the designer/project manager and the construction engineer must develop supporting documentation for each TTC phase including the conditions requiring the law enforcement services, the number of personnel, the man-hours, and any other requirements that may be established.

Show the Speed and Law Enforcement Officer pay item in the Summary of Pay Item sheet only. Do not make any other reference to these services in the plans.

Modification for Non-Conventional Projects:
Delete the above paragraph.

Speed and Law Enforcement Officer can be used on non-limited access highways provided that the District Director of Transportation Operations has approved its use.

Pay for Speed and Law Enforcement Officer under pay item 999-102-A - Speed and Law Enforcement Officer (Do Not Bid) (HR).

For Traffic Control Officer, clearly indicate the intended use of the officer(s) during each phase of construction, the need for the service, the number of officers needed, and the required man-hours in the TTC plan. Traffic Control Officers will be paid for under pay item 102-14 - Traffic Control Officer (HR). Complete documentation that complies with the TTC plan must be included in the calculations sub-directory of the project directory.

Modification for Non-Conventional Projects:

Delete the last two sentences of the above paragraph.

The initial coordination between the designer/project manager and construction must take place prior to Phase II. The final determination of man-hours and final documentation must be accomplished at the same time that construction days are set.

Modification for Non-Conventional Projects:

Delete the above paragraph.

10.14.4 Other Uses of Law Enforcement

The contractor may choose to use law enforcement services beyond the details of the TTC plan for situations that assist with mobilization, demobilization, TTC setup, and other instances where he or she prefers the use of law enforcement.

The contractor is responsible for the coordination of these uses and will be included under the Lump Sum Maintenance of Traffic pay item. These contractor required services are not to be included in the Department's contract pay items for law enforcement services.

Modification for Non-Conventional Projects:

Delete the above paragraph.

10.15 Motorist Awareness System (MAS)

The purpose of a Motorist Awareness System (MAS) is to increase the motorist awareness of the presence of active work and provide emphasis on reduced speed limits in the active work area. A MAS is created by using a combination of several different traffic control devices to draw attention to the legal speed and inform the motorist of his vehicle speed. Descriptions of some MAS devices are provided below. The [Design Standards, Index 670](#), provide details on the most effective combination and placement of MAS traffic control devices.

The Department's goal is to achieve the same respect for Work Zones that School Zones currently receive. The key in achieving this respect is to discontinue blanket speed limit reductions in work zones, increase enforcement, and to remove the MAS when the conditions requiring it no longer exist and restore the speed limit within the limits of the project to the posted speed limit. Specifically, MAS components are to be activated when the lane closure is setup and deactivated when the lane closure is taken down. All MAS components must be moved outside of the clear zone or to be shielded by a barrier or crash cushion when not in use.

The MAS must be used if all of the following conditions exist:

1. Multilane facility
2. Posted speed limit is 55 mph or greater
3. Work activity requires a lane closure for more than 5 days (consecutive or not)
4. Workers are present and not protected by barrier

The following is a list of some of the devices that are used as part of a Motorist Awareness System.

10.15.1 Portable Regulatory Signs (PRS)

The purpose of this device is to highlight the regulatory speed for the work zone. A portable regulatory sign is a portable trailer that has the regulatory speed sign mounted with flashing lights on each side of the sign. The lights are used to draw the driver's attention to the regulatory speed. Use PRSs in accordance with [Design Standards, Index 670](#).

10.15.2 Radar Speed Display Unit (RSDU)

The purpose of this device is to display the motorist's work zone speed. A radar speed display unit is a portable trailer that displays the speed of approaching motorists on a LED display panel. The radar mounted on the unit detects the speed. A regulatory sign with the posted speed is mounted above the LED display panel.

The device can be set that only speeds greater than the work zone speed are displayed. Use RSDUs in accordance with [Design Standards](#), **Index 670**.

10.15.3 Speed and Law Enforcement Officer

The use of moving officers on a random basis, in conjunction with the other MAS devices, has proven to be effective. Although the Speed and Law Enforcement Officer is not shown on **Index 670**, the Designer should include the Speed and Law Enforcement Officer (DO NOT BID) pay item when using this Index. Department personnel are responsible to identify when Speed and Law Enforcement Officers are needed based on actual field conditions, document the man-hours used and directly pay the appropriate law enforcement agency. See **Section 10.14** for additional information.

Modification for Non-Conventional Projects:
Delete the second sentence in the above paragraph and add the following: The department may include a Speed and Law Enforcement Officer do not bid pay item.

THIS PAGE LEFT BLANK INTENTIONALLY

Chapter 11

Stormwater Pollution Prevention Plan

11.1	General	11-1
------	---------------	------

THIS PAGE LEFT BLANK INTENTIONALLY

Chapter 11

Stormwater Pollution Prevention Plan

11.1 General

A Stormwater Pollution Prevention Plan (SWPPP) must be developed and implemented for each FDOT construction project that disturbs one or more acres of total land area and discharges to waters of the United States. The State of Florida Department of Environmental Protection Generic Permit for Stormwater Discharges from Large and Small Construction Activities, herein referred to as the DEP Generic Permit, applies to projects where multiple, separate, and distinct construction activities may be taking place at different times and at different schedules under one contract plan. In these situations, if the combined total area of disturbed land is equal to or greater than one acre, the requirements of the DEP Generic Permit will apply.

The site specific SWPPP is a requirement of the DEP Generic Permit. In order to use this permit:

1. The Engineer of Record must prepare a plan that assures compliance with the terms and conditions of the DEP Generic Permit. This includes obtaining a state stormwater quality permit, if appropriate.
2. The Contractor must file a Notice of Intent (NOI) and submit payment of permit fee to the DEP.

Distribution of the NOI, SWPPP and signed certification statements will be in accordance with the requirements of the DEP Generic Permit.

The objectives of the SWPPP are to:

1. Prevent erosion where construction activities are occurring
2. Prevent pollutants from mixing with stormwater
3. Prevent pollutants from being discharged by trapping them on-site, before they can affect the receiving waters

Note: For the purpose of preparing a SWPPP, a pollutant is anything that could cause or contribute to a violation of state water quality standards.

A complete SWPPP consists of several items: SWPPP sheets, other plan sheets and documents referenced in the SWPPP sheets, the contractor's approved **Section 104**

Erosion Control Plan, inspection reports, and documentation of field changes that were made to better address the objectives.

Preparing and implementing a SWPPP involves evaluating the site, selecting and describing control measures to address the objectives, and implementing, installing, inspecting, and maintaining the controls.

Evaluating the site and selecting and describing the controls are done during the design phase and are documented in the SWPPP sheets. The SWPPP sheets must be prepared in consultation with Drainage, Construction and Environmental personnel, as required. The SWPPP sheets must be sealed. Refer to **Volume 2, Chapter 28** for guidelines for preparing the SWPPP sheets.

Implementing, installing, inspecting, and maintaining the controls are the responsibility of the Contractor. The Contractor is also responsible for adjusting the SWPPP Plan for unforeseen construction conditions.

Chapter 12

Right of Way

12.1	General	12-1
12.2	Procedures for Establishing R/W Requirements.....	12-3
12.2.1	Open Cut and Fill Roadway Sections	12-3
12.2.2	Curb and Gutter Roadway Section	12-4
12.2.3	Access Management.....	12-5
12.2.4	Procedures for Decision Making.....	12-7
12.2.5	Transmittal of R/W Requirements	12-8
12.3	Process for Establishing Right of Way Requirements.....	12-9
12.3.1	New or Major Reconstruction Projects.....	12-9
12.3.2	Reconstruction Projects with Anticipated R/W Requirements	12-10
12.3.3	Projects Without an Identified R/W Phase	12-11
Figures		
Figure 12.3.3	R/W Requirements Generalized Process Flow Diagram	12-13

THIS PAGE LEFT BLANK INTENTIONALLY

Chapter 12

Right of Way

Modification for Non-Conventional Projects:

For Design Build projects, the department will endeavor to purchase all required right of way prior to release of the RFP. If additional right of way is proposed through the ATC process, based on the Department's concurrence, the Design-Build firm must provide the funding for purchase of the additional right of way. In either case, the Department must conduct the right of way acquisition process, and the Design-Build firm must not commence construction on any parcel until the Department certifies that right of way has been purchased.

12.1 General

To assist the roadway designer's understanding of right of way (R/W) requirements, which must be addressed during the project development and design phases of projects, the following terms are briefly defined as an introduction.

Right of Way is real property or an interest therein, donated or acquired by purchase or condemnation, to accommodate transportation improvements. Fee simple is the strongest interest available to the Department and is sought for most permanent highway facilities. When improvements are designed which will fall outside of the existing R/W boundaries, additional lands must be identified and acquired. All necessary right of way and easements must be in Department ownership prior to advertisement of the project for letting.

Limited Access R/W is purchased for facilities such as Interstate and Expressways. This limits public access to interchange connection-points designed with entrance and exit ramps and limits access to motorized vehicular traffic. Pedestrians and bicycles are restricted in the interest of traffic capacity and safety.

Controlled Access R/W is acquired for the remaining State Highway System. This allows the general public and landowners along the corridors reasonable access, but in a controlled pattern that will facilitate the movement of through traffic.

Perpetual Easements (perpetual right of use over, under or through the property of another) are used when permanent structures or improvements are to be constructed and maintained on parcels where acquisition of fee title would be impractical, i.e., when acquisition of the fee would cause excessive severance damages due to green area or setback requirements or where underground structures are to be constructed which will not impair the surface use of the land. A sight triangle or drainage facility are examples of features that may require a perpetual easement. Condemnation powers may be utilized to acquire necessary perpetual easements.

Temporary Easements (a temporary right of use over, under or through the property of another) are used when it is necessary to temporarily occupy a parcel for a specific purpose such as construction of improvements requisite of the project, construction of temporary detours, stock piling materials or parking equipment. A Temporary Easement may also be necessary when it is determined that reestablishing access causes a compensable impact to the use of the abutting land or causes a safety issue due to a change in grade. No improvement which requires maintenance by the Department beyond the term of the easement can be constructed on a temporary easement.

License Agreements are used to gain access to adjoining properties for sloping, grading, tying in, harmonizing and reconnecting existing features of the licensor's property with the highway improvements to be constructed. This work is for the benefit of the property owner. The Department does not compensate for license agreements. If the owner refuses to execute the agreement, the Department will not perform the work outside of Department right of way.

Licenses are included here as real property interests for convenience, but they are not real property interests. A license, with respect to real property, is a privilege to go on the premises for a certain purpose but does not vest any title in the licensee.

The most economical means of constructing the project should always be the objective. The designer must design the highway facility within the existing R/W, obtain a license agreement, or request acquisition of R/W to accommodate project elements.

12.2 Procedures for Establishing R/W Requirements

The procedures for addressing R/W requirements require engineering analyses, economic comparisons and professional judgments. Consultation with the District R/W Surveyor and District R/W Manager is required. One excellent method of providing the consultation is the "R/W Partnering" concept with all parties that have a vested interest participating in the decision making process.

Alternate design studies will be required in many locations to determine if additional R/W should be purchased, a retaining wall constructed or modified slopes and barrier system should be considered. A reasonable estimate of R/W costs or damages expected must be obtained from the R/W Office in order to make such a design study. Alternate construction methods may be shown on the plans as preferred and alternate methods.

12.2.1 Open Cut and Fill Roadway Sections

R/W requirements along the project boundaries are dictated by the actual construction limits plus a reasonable maintenance buffer. The roadway cut and fill slopes, drainage ditch slopes and other construction elements are used to define the construction limits, which are generally shown on the roadway cross sections. R/W requirements are determined by reviewing the plotted cross sections after the roadway and drainage design elements have been established and major revisions are highly unlikely.

A joint field review of the proposed R/W is strongly encouraged and should be conducted at this point. The design details and the property information must be reviewed by the designer, personnel from the R/W Office and the R/W Mapping Office. This review should be scheduled during the Phase II design process as defined in this manual and should address such issues as:

1. Will additional R/W be required for project access, maintenance of the facility, or transit facility needs? Check pond sites, high embankment slopes, bridges, outfalls, canals and similar sites.
2. Can acquisitions be avoided or design modified to avoid substantial damages to remainder property or businesses? Examples include designing retaining walls or by adjusting slopes or grades to reduce the difference in elevation between the remainder and the project grade at the R/W line.
3. Can the roadway grades be revised or connections relocated so access to the remainders can be constructed without damaging the use of the remainder, thereby minimizing or avoiding severance and business damages caused by

- altering the access?
4. Can drainage facilities (outfalls, ponds, ditches, etc.) be maintained without additional R/W space? Can uneconomic remainders be used for stormwater treatment?
 5. Has consideration been given to joint use ponds (including golf course ponds) and/or regional treatment facilities?
 6. Check the suitability and cost effectiveness of storm water treatment facilities and the status of permit approval.
 7. What types of legal instruments are likely to be required to secure the appropriate property rights for the project?
 8. Review the status of R/W activities by others in the project area. Avoid multiple acquisitions from the same owner at ramp terminals, intersections and by future FDOT projects.
 9. Check for potentials of hazardous materials, "4F" parcels, utility easements, landlocked remainders and parcels, which could be eliminated.
 10. Check for acquisitions involving existing treatment systems which could be mitigated within the FDOT system.
 11. Discuss the possibility of advance acquisition of any parcel where development is imminent.
 12. Check for incidental work which will fall outside of R/W such as trenching, wall forms, or equipment maneuvering space.
 13. Check for availability of offsite property owned by FDOT which could be used for mitigation sites.
 14. Discuss status of any R/W being claimed by maintenance pursuant to **Section 95.361, F.S.** (Maintenance Statute).

12.2.2 Curb and Gutter Roadway Section

Establishing R/W requirements in urban sections will generally follow very similar procedures as the open roadway section projects. The analysis and decision making is complicated by more property owners, generally higher property values, businesses, and more complex access management problems.

The roadway and drainage design must be developed to a point where all major elements of the project (including transit facilities, signalization poles, lighting poles and overhead sign foundations) are firmly fixed. On projects with sidewalks and driveway connections, the design elements can be accurately established ONLY if proper survey data has been

obtained for the designer's use. Profile elevations along the proposed R/W line and back of sidewalk and half-sections or profiles at each driveway location should be obtained as a minimum standard practice.

The design engineer must perform the design work required to establish the project profile grades and the back of sidewalk grades to minimize the grade differences at the R/W line. Areas of superelevation must be analyzed very carefully. Split profile grades or other design strategies may be required to accommodate the proposed construction of the facility within minimum R/W limits.

The developed drainage and roadway design elements should be plotted on the plan sheets and the cross sections, which will establish the preliminary R/W requirements along the project boundaries as indicated by the construction limits. A good quality control review and a joint review with R/W appraisers and R/W Mapping personnel at this time will assist in determining the final R/W requirements. The same issues listed earlier in these procedures should be addressed.

12.2.3 Access Management

Access to the Department's facilities is an important element of the design and R/W determination procedures. Access Management is discussed in **Chapter 1, Section 1.8** of this volume. The designer must understand and follow the **Access Management Rules (14-96 and 14-97)** and the procedures and directives adopted (**Topic Numbers 625-010-020 and 625-010-021**) to implement the objectives of those rules. Identification of access and median opening location in relation to individual parcels should be completed before appraisal.

The following activities should be accomplished by the Designer:

1. The access classification of the roadway segment and the connection category of the driveways must be determined. The designer must be aware of the nature, type, frequency of trips and number of vehicles utilizing the driveway.
2. The designer must make a determination as to which driveways are in conformance, which are to be maintained, which are to be closed and which are to be modified to bring them into compliance.
3. The designer must obtain sufficient field survey data to establish the highway grades, horizontal alignment and the existing ground elevations in the vicinity of the driveway location. The data necessary to accurately design the driveway connection and determine an acceptable tie-in with the existing surface should be obtained as a minimum.

4. The designer should develop the most economical driveway design which will conform to the standards and the requirements of the access management objectives. Alternate designs and locations may be required to meet the property needs. Generally, the best option can be reached by negotiating with the property owner and/or tenant in a give and take atmosphere; however, Right of Way must take the lead in such negotiations.

Driveway connections must be addressed in consultation with R/W personnel. This fact should not be overlooked on projects such as resurfacing, etc. on which there may not be any other R/W requirements. R/W related decisions to be made about driveway connections, probably on a case-by-case basis, include:

1. License Agreements (LA) are used where restoration of the driveway connection is not necessary to project construction or maintenance of the finished facility. The LA allows the Department entry to the property at no cost in order to harmonize and reestablish the driveway connection. Refusal of the property owner to execute the LA does not unduly affect construction of the project. If refusal would adversely affect the construction of the project, then a Temporary Construction Easement should be used and the engineer should be prepared to testify in court as to necessity.
2. In the situation where a team consisting of the engineer, the R/W Mapper, the District Right of Way Manager (DRWM), and Legal (or their designees) decides that (1) harmonization and restoration of the driveway connection is likely to cause a diminution in the use of the property, and (2) no taking for the benefit of the project is necessary, then the DRWM must decide on the appropriate method of compensating the property owner, whether by a TCE or some other means.
3. The Office of R/W will see that the proper instruments are executed to enter onto the property for purposes of construction and to compensate the owner for damages, if any are due. If other acquisition of that property is proposed, these instruments should include the entry and compensation, if any, for the driveway.
4. If there is no acquisition from a property, yet the property owner feels their property has been negatively affected by a project, the property owner can negotiate or claim damages through the inverse condemnation process.
5. Design should always, in their consultation with R/W personnel, make a determination if a fee taking or permanent easement is in the public interest to protect the facility. If a permanent easement will protect the facility and still give the owner some utility in the easement area, this may reduce the severance and business damages incurred.

12.2.4 Procedures for Decision Making

To assist in the decision process related to R/W requirements and instruments to be used, the following guidelines from the Office of Right of Way may be used during the joint review process. Close coordination with the District Right of Way Office and the Office of General Counsel is required during this decision-making process.

A License Agreement is the default method for driveway harmonization; use of a Temporary Construction Easement must be justified in terms of project integrity, cost or potential impact of the project on the property.

1. License agreements should be used only if the following conditions can be met:
 - a. The improvements or changes contemplated have no compensable impact to the use of the property, and are for the sole benefit of the property owner; and
 - b. None of the improvements are required for the construction, operation and maintenance of the transportation facility and removal of, or change to the improvements will not be detrimental to the facility.
2. Temporary Easements should be used under the following conditions:
 - a. When it is necessary to temporarily occupy a parcel for a specific purpose such as construction of improvements requisite of the project, construction of temporary detours, stockpiling materials or parking equipment;
 - b. When it is determined that reestablishing access creates a compensable impact to the use of the abutting land;
 - c. Where grading, tying-in, harmonizing, and/or connecting an access point is required to maintain the safety and design of the facility;
 - d. The contemplated improvements or uses of the property owner's land are required only during the period of construction of the transportation facility;
 - e. Removal or alteration of the improvements to the property owner's land subsequent to construction would not be detrimental to the facility; and,
 - f. After construction is complete, there will be no need for periodic re-entry onto the property by the Department for maintenance or other purposes.
3. Fee Simple R/W purchase should be used when the following conditions exist:
 - a. The planned improvements to the property owner's land are required as a part of construction of the transportation facility;
 - b. The improvement on that land must remain in place as a part of the facility; and,
 - c. Periodic re-entry to the property is required for maintenance or repair.

Perpetual Easements may be considered as an alternative to fee simple purchase in the R/W process if the owner may continue to enjoy some benefits of the property without impairing the Department's use and the total acquisition costs to the Department are less than the cost of acquiring fee.

12.2.5 Transmittal of R/W Requirements

R/W requirements should be finalized before transmitting them to the R/W Mapping Office for preparation of R/W maps. All R/W requirement transmittals should be in writing and clearly indicate in the memo and on the plans which parcels have been finalized and which parcels are still pending. An effort should be made to transmit final R/W requirements in usable segments. Priority should be given to the major, expensive or complex acquisitions that are going to require more time to acquire and complete the relocation of the occupants. Advanced design effort and final R/W requirement determination may expedite meeting production ready dates. It is desirable to transmit requirements as early as possible in the plans development.

All R/W requirements that are firm (primarily mainline construction limits) should be transmitted by Phase II. All other requirements that generally involve more detailed design completion (i.e., outfalls, pond locations, corner clips, access needs, etc.) must be submitted by the Phase III stage completion of the roadway design plans.

All R/W requirements must be transmitted by the completion of the Phase III roadway design plans.

12.3 Process for Establishing Right of Way Requirements

Establishing right of way requirements is a design process, but requires close coordination with other functions that have input to the project development and design of the project.

The Engineer of Record is responsible and must ensure that representatives from the appropriate functional areas are involved in the determination process. They must also ensure that a review of the final R/W requirements is performed. The "R/W Partnering" concept is an excellent method of ensuring that the proper consultation and input is received.

Generally, the R/W needs-determination will involve Roadway, Bridge and Drainage Design, Permits, Utilities, R/W appraisers, R/W Mapping and Legal functions. On consultant designed projects, the project manager's role as lead coordinator is especially critical.

12.3.1 New or Major Reconstruction Projects

These projects generally have Project Development and Environmental (PD& E) activities and Right of Way activities identified in the Work Program.

The project development process must address R/W requirements and perform sufficient preliminary engineering design to obtain preliminary cost estimates from the R/W Office. This may require that the PD& E consultant or in-house scope of services include work such as:

1. Preliminary roadway grades & geometric design.
2. Conceptual Drainage design and layout.
3. Analysis of major access management issues.
4. R/W Survey, property lines and limited topography.
5. R/W Mapping and property research activities.
6. Preliminary R/W cost estimates work.
7. Analysis of the transit, pedestrian/bicycle R/W needs.

This early identification of potential R/W requirements, approximate costs and work effort to complete R/W activities will greatly improve both cost estimates and schedules of projects. Also, involving R/W mapping and appraisers will assist in developing better

project alternatives.

R/W requirements identified during the project development phase should not be considered firmly set. The R/W Office cannot be requested to begin R/W mapping or appraisal activities based on these requirements, without extraordinary efforts by the designer to support the acquisition process as in advance acquisition.

12.3.2 Reconstruction Projects with Anticipated R/W Requirements

These projects may not have a formal PD& E study, but they were determined during Work Program development to require some R/W acquisition. Most projects will require some environmental re-evaluation effort and all projects should have some preliminary engineering to better define objectives, scope and R/W requirements. The following general process, as it relates to R/W requirements should be established by design:

PHASE I

1. R/W Mapping will provide preliminary maps showing properties and all existing R/W lines for the project. These should be requested by the designer or by the project manager, on consultant projects.
2. The roadway designer will define project horizontal and vertical alignment and relate the existing R/W lines to the project as necessary to set R/W limits.

PHASE II

1. The roadway designer will identify proposed R/W requirements as indicated by the completed design details such as the following:
 - a. Limits of construction slopes for roadway and bridges
 - b. Cross section elements, transit facilities, ditches, curb returns and sidewalks
 - c. Driveway and street connections
2. The drainage designer will identify proposed R/W requirements as indicated by the completed drainage features:
 - a. Retention or Detention Ponds
 - b. Mitigation of environmental issues
 - c. Drainage outfalls, sediment basins, etc.

The designer will review all proposed R/W requirements with the R/W Mapping Office. This should be performed during the Phase II design activities in order to make decisions on how each parcel of proposed R/W will be acquired. These decisions will impact which design approach is taken. The issues to be discussed and decisions to be considered are detailed in **Section 12.2** of these procedures.

3. As R/W requirements are determined, the information is furnished to the R/W Mapping Office by memo documenting clearly which R/W is final and which is pending. The R/W Mapping Office will use only the final requirements transmitted to prepare R/W maps. See **Section 12.2.5**.

PHASE III

1. By the completion of Phase III design, all R/W requirements will be identified and transmitted to the R/W Mapping Office.
2. After transmittal of final R/W requirements to the R/W Mapping Office, design changes that affect R/W must be coordinated with the R/W Mapping Office, in a timely manner.

The R/W shown on the roadway plans must be in exact agreement with the R/W Maps.

It is essential that close coordination be maintained with R/W personnel in order to ensure that design changes affecting R/W are transmitted promptly.

12.3.3 Projects Without an Identified R/W Phase

Many improvements to highway projects are intended to be accomplished within the existing R/W. The widening or widening and resurfacing projects are examples. Such projects must be evaluated very carefully and very early in the roadway design process.

The addition of R/W requirements can have a tremendous impact on the schedule and on the anticipated costs of a highway improvement project.

R/W Mapping should be consulted on all projects to ensure that the proposed construction lies completely within the existing R/W and no Trustees of the Internal Improvement Trust Fund parcels or maintenance surveys are required.

For all projects determined to be completely within existing R/W the project manager or District R/W Surveyor as appropriate, must notify the District R/W Manager, in writing,

that no R/W is required. This notification will serve as the basis for the District R/W Manager's certification that all necessary R/W is available for construction.

If unanticipated R/W requirements are identified during design, the production management staff and the R/W Mapping Office should be notified as soon as the requirements are determined. The production management staff will then give direction as to continuing with the design and acquisition. If acquisition continues, it will follow the previously discussed procedures.

Figure 12.3.3 R/W Requirements Generalized Process Flow Diagram

(Each function must have well defined written procedures for the development, quality control, coordination and regular exchange of product evaluation.)

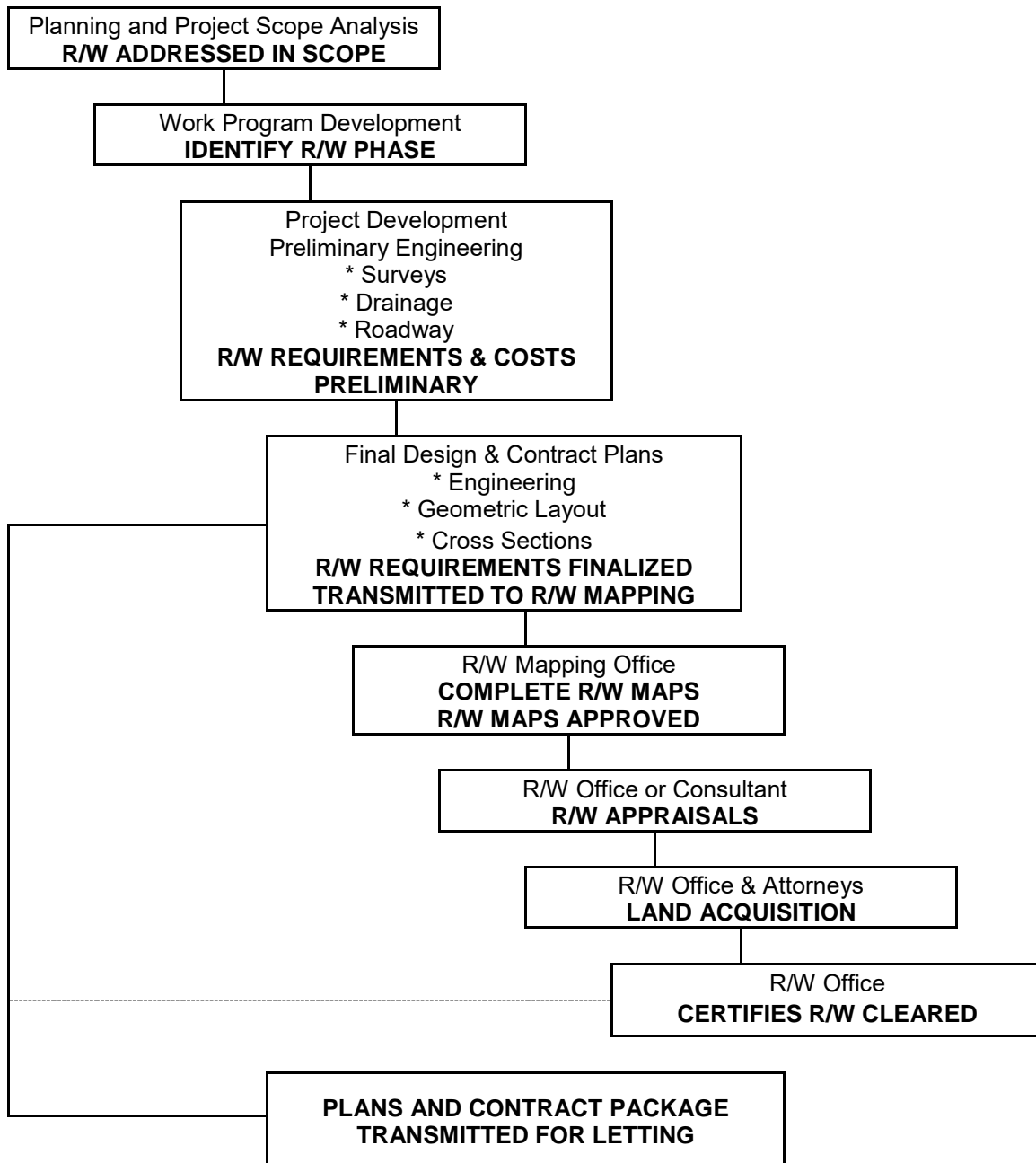

THIS PAGE LEFT BLANK INTENTIONALLY

Chapter 13

Initial Engineering Design Process

13.1	General	13-1
13.2	Initial Engineering Design.....	13-2
13.3	Scope, Objectives, Schedule and Budget	13-3
13.4	Project Design Controls and Standards.....	13-4
13.5	Support Services.....	13-5
13.5.1	Aviation and Spaceports Office Coordination	13-6
13.5.2	Projects Involving Existing Bridges.....	13-8
13.5.2.1	Projects Involving Steel Bridges	13-8
13.5.2.2	Projects Involving Bridges with Asbestos Containing Materials.....	13-8
13.5.2.3	Projects Involving Bridge Demolition	13-9
13.5.3	Projects Involving Bridges Over Navigable Water ..	13-10
13.5.4	Wildlife Connectivity	13-10
13.5.5	Limited Access Projects Affecting Logo Structures.	13-11
13.5.6	Buy America Provisions	13-11
13.5.7	Traffic Monitoring Sites.....	13-12
13.5.8	Fire Suppression Systems.....	13-13
13.6	Preliminary Geometry, Grades, and Cross Sections	13-14
13.7	Distribution of Exempt Public Documents.....	13-16
Tables		
Table 13.5.1	Construction of Airspace Obstructions - Notification.....	13-7
Exhibits		
Exhibit 13-A	Major Activities – Initial Engineering Process	13-ii

Exhibit 13-A Major Activities – Initial Engineering Process

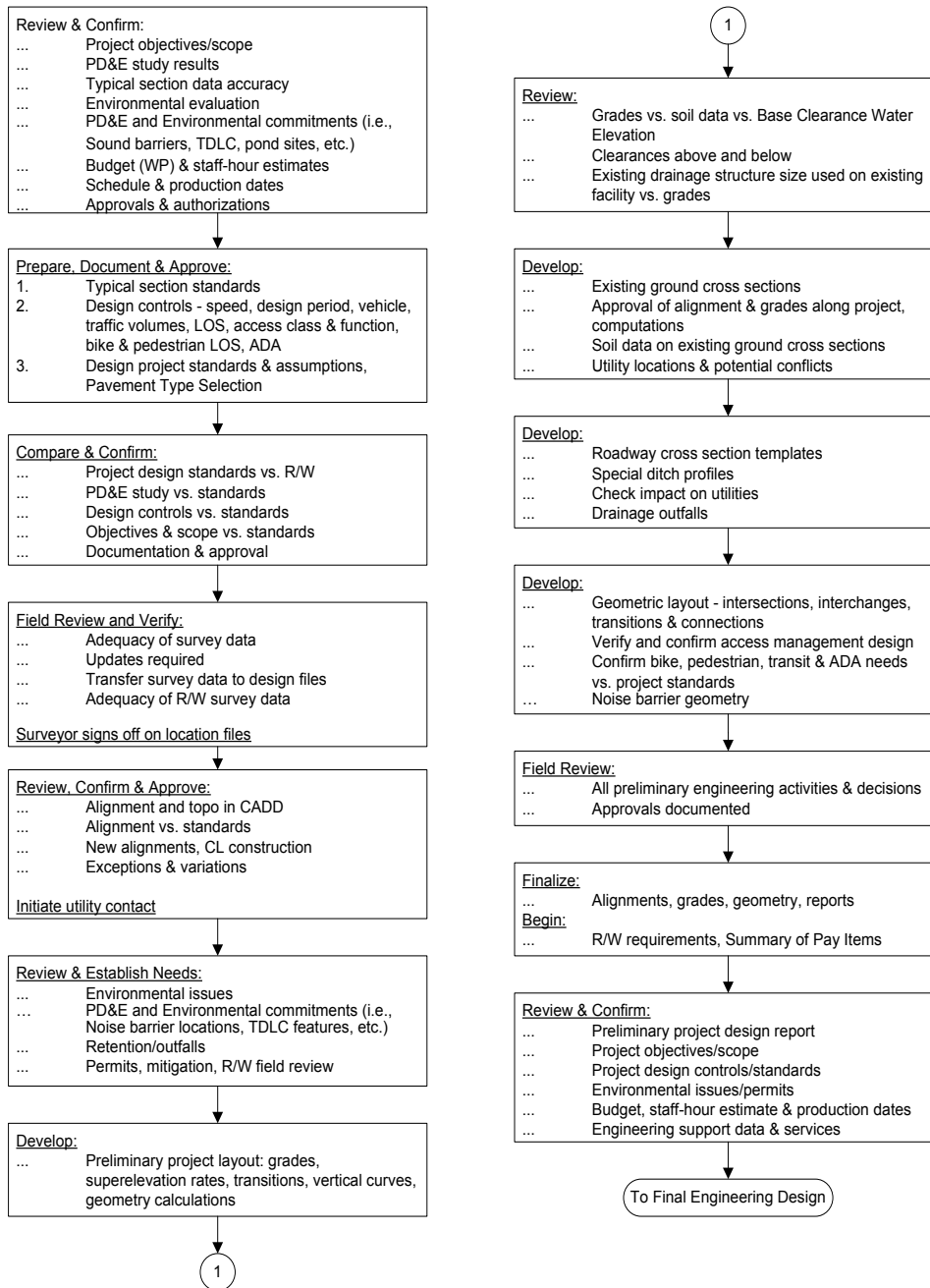

Chapter 13

Initial Engineering Design Process

Modification for Non-Conventional Projects:

Delete *PPM* Chapter 13.

13.1 General

The engineering design process, as discussed in this and following chapters, includes the data gathering, development and contract preparation phase of highway construction projects. It begins with the approval of the Project Location/Design and ends with the construction letting. It also includes the update process when the construction plans and specifications are ready and on hold in the district and require revising to make them contract ready. Throughout this design process, quality control will be exercised by those responsible for the engineering design and plans preparation activities by having a plan-do-check routine for each and every significant task or operation.

The engineering and design activities and the schedules depend on the type of project and the required effort to accomplish the desired objectives. Projects can be designated as three basic types:

1. **New Construction** - A highway or bridge project along a new corridor on new horizontal and vertical alignments.
2. **Add Lanes and Reconstruct** - A highway project along an existing facility to add lanes, widen or replace bridges, improve intersections, and upgrade and improve the capacity and safety of the facility.
3. **Other Projects** - May include Resurfacing, Restoration and Rehabilitation (RRR), Local Agency Program (LAP), or other projects such as a highway and/or enhancement projects - A highway and/or bridge project undertaken to extend the service life of an existing facility and to enhance the safety of the facility. These projects generally do not require a PD&E phase. The scopes are so varied that it is difficult to define them, except project by project. They can vary in magnitude from installing highway lighting for enhanced safety or resurfacing pavement to extend the service life, to minor lane and shoulder widening, bridge rail modification or intersection improvements. These projects may also include transit facilities, bike paths, sidewalks and landscaping projects.

13.2 Initial Engineering Design

It is important to distinguish the initial engineering design activities from planning and the preliminary engineering done during the Project Development and Environmental (PD&E) phase. If a PD&E phase has been completed, some of the activities discussed here may have been performed to varying levels during that phase. The information contained in the preliminary engineering report should be considered as the starting point for the initial engineering phase. In the case where there was not a PD&E phase, the initial engineering design activities must establish the project scope, controls and standards, data gathering requirements, right of way (R/W) needs, and major design elements necessary to determine that the project is viable and R/W can be cleared.

Generally, the initial engineering process **should** accomplish or complete the following activities:

1. Completely and fully define and document the objectives of the project and the scope of activities to accomplish them. This will almost always require an on-site review.
2. Develop and document a realistic staff-hour estimate and production schedule to accomplish the scope of activities identified.
3. Establish and document the design controls, assumptions, project design standards, Design Exceptions, and Design Variations. Significant changes to previously approved PD&E elements may result in a re-evaluation of the environmental document. Discuss with the District Environmental Management Office.
4. Identify all prior PD&E and environmental commitments such as the need to design and locate noise barriers (with insertion loss calculations), special pond site requirements, landscape or aesthetic considerations, transportation design for livable community issues, pedestrian and bicycle commitments, access commitments, wildlife management commitments, wetland issues, transit issues, etc.
5. Identify and document additional engineering, data gathering, and support services.
6. Determine and document the structural design requirements.
7. Determine and document if R/W is required.
8. Establish and document the review procedure and number of submittals, if different from guidelines provided in this manual.
9. Establish preliminary geometry, grades, and cross sections.
10. Identify and implement needed public involvement activities.
11. Develop Pavement Type Selection Report based on FDOT ***Pavement Type Selection Manual (Topic No. 625-010-005)***.

13.3 Scope, Objectives, Schedule and Budget

The project manager and other FDOT managers are responsible for the development, review and approval of the project objectives, scope of work, and schedule in accordance with the ***Project Management Guidelines***. They also must verify that required funds are in the work program.

The project objectives and scope are best confirmed and/or completed by:

1. Reviewing the PD&E study recommendations, conclusions and commitments, if they exist.
2. Performing a field review of the project with the project manager and personnel from other FDOT offices, such as Roadway Design, Traffic Operations, Safety, R/W Engineering, Utilities, Survey, Maintenance and Construction, as appropriate.
3. Requesting a review of the draft scope of services activities by FDOT offices, such as Maintenance, Construction, Design, Traffic Operations, Access Management, Public Transportation, Pedestrian and Bicycle, etc.
4. Developing the scope of services sufficient to advertise for professional services. After the scope of services is completed and approved, the schedule and budget may be confirmed and/or updated by the engineer/project manager and approved by the appropriate district manager.
5. After consultant selection or in-house assignment, the designer or consultant should review and confirm the scope by completing steps one through four above.
6. The scope should anticipate and include the most cost effective methods that may be used in Subsurface Utility Engineering (SUE) for locating subsurface anomalies, structures, and utilities. Its use may affect the design process and should be considered in the scoping process. Selecting which methods to be employed should be accomplished by balancing risk versus benefit. Seldom will the use of only one method provide the most value. For example: Using radar tomography may have an initial higher cost but yield significantly more information much earlier in the design process which can facilitate drainage design, shorten the overall project time, reduce contractor risk, minimize redesign, and identify unknown facilities. Conversely, radar tomography has limited depth and resolution issues in a salt or high mineral environment, but other high technology methods exist and are worthy of consideration. The designer must recognize that SUE is a process that has many old and new technologies at its disposal. Consulting a SUE provider who can demonstrate state of the art knowledge will yield the most benefit.

13.4 Project Design Controls and Standards

Among the activities the Engineer of Record (EOR) will accomplish on a project are the identification of the given design controls and the selection of the appropriate design standards. These will be documented in the project file(s).

The design controls as addressed in this manual and AASHTO include such things as right of way constraints, major utilities, design speed, design vehicle, design period, traffic volume and service level, functional classification of the corridor, the access class, and other factors that control the selection of project standards that will ensure the facility will function safely at the level desired and expected by the motorists.

Establishing the project standards is one of the first requirements of the engineering design process. The decisions, assumptions and calculations for the design are based on these factors. Document project standards in the project file(s).

The preliminary engineering report (PD&E) or concept report may include some of the controls and standards to be used on the project. These values should be reviewed, confirmed as valid and consistent with the overall corridor or system, and documented. Significant changes to approved PD&E elements of design may require a re-evaluation of the environmental document.

The Engineer of Record must coordinate with the District Design Engineer, the District Traffic Operations Engineer, and the responsible PD&E engineer to discuss the anticipated posted speed and determine the appropriate design speed for the project.

If project standards must be used that do not meet recommended values, these must be documented and receive approval/concurrence by the appropriate FDOT and/or FHWA engineer. These are either Design Exceptions or Design Variations as described in **Chapter 23** of this volume and must be maintained in the project file(s).

When all project standards are selected, documented, and agreed upon, the engineer should get the District Design Engineer to concur that the appropriate standards are being used. The Typical Section package will include some of the project standards. Those not included, and all known Design Exception/Design Variation justifications must be documented in the project file(s).

13.5 Support Services

Review information or support services that have been provided to determine the completeness of the information. Conditions may have changed with collected data becoming outdated.

Technical data required for the design of a roadway project can be available from various sources, such as:

1. Surveys - design, topographical, aerial, drainage, right of way location, soil, utilities
2. Traffic Data
3. Pavement Design
4. Environmental Documents (including Noise Study Report and wildlife connectivity recommendations)
5. Original Plans
6. Accident Data
7. Access Management Classification

During the design process, the project will require coordination with different sections or departments. When engineering decisions, information, or other support services are required from FDOT functional areas, it is the project manager's responsibility to coordinate and facilitate the request and expedite a timely response. The functional areas include but are not limited to:

- | | |
|---------------------------------|------------------------------|
| 1. Planning and Programs | 11. FHWA |
| 2. Surveying and Mapping | 12. Value Engineering |
| 3. Traffic Plans | 13. Traffic Operations |
| 4. Geotechnical | 14. Environmental Management |
| 5. Drainage | 15. Access Management |
| 6. Maintenance | 16. Structures |
| 7. Construction | 17. Safety |
| 8. Utilities | 18. Plans Review |
| 9. Estimates and Specifications | 19. Public Transportation |
| 10. Right Of Way | 20. Landscape Architecture |

13.5.1 Aviation and Spaceports Office Coordination

Coordinate with the District Aviation Coordinator when a project is within 5 miles of an airport. If it is determined that an airspace obstruction exists (based on the criteria contained in **Table 2.10.3**), refer to **Table 13.5.1** for applicable FAA notification guidelines. For guidelines on airspace obstruction permitting, refer to **Chapter 333, Florida Statutes, "Airport Zoning"**, and **Chapter 14-60, Florida Administrative Code, "Airport Licensing and Airspace Protection"**.

While the responsibility for filing FAA notifications and permitting applications for FDOT Airspace Obstruction Permits or Variances to the local ordinance rests with the Engineer of Record, the FDOT Aviation and Spaceports Office will provide technical assistance on planned projects to determine impact to the national airspace system in Florida. Please direct your request to the following:

FDOT Aviation and Spaceports Office
Airspace and Land Use Manager
605 Suwannee St., M.S. 46
Tallahassee, FL 32399-0450
Tel: (850) 414-4500
Fax: (850) 414-4508
Internet: <http://www.dot.state.fl.us/Aviation/>

Table 13.5.1 Construction of Airspace Obstructions - Notification

FAA Notification

Federal law, *Title 14 Code of Federal Regulations (CFR), Federal Aviation Regulations (FAR), "Part 77 – Safe, Efficient Use, and Preservation of the Navigable Airspace"*, requires that prior notification must be given to the FAA regarding any construction or alteration of structures that meet specific criteria (See **Table 2.10.3**, this volume).

If FAA notification is required, **FAA Form 7460-1, "Notice of Proposed Construction or Alteration"** can be submitted either electronically through the FAA's Obstruction Evaluation / Airport Airspace Analysis (OE/AAA) Website, or manually to the FAA Southern Regional Office in Atlanta. Submitting electronically is the preferred notification method. This notification must be submitted at least 45 days before the earlier of the following dates:

1. Date proposed construction or alteration is to begin.
2. Date an application for a construction permit is to be filed.

The FAA provides a Notice Criteria Tool via the OE/AAA website that can be used to determine whether notice is required. Refer to the OE/AAA Website (<https://oeaaa.faa.gov/>) for more information.

FAA Emergency Notification

In the case of an emergency involving essential public services, public health, or public safety that requires immediate construction or alteration, the 45-day advance notice requirement does not apply. In such a case, the required notification may be sent by telephone or any expeditious means to the nearest FAA Flight Service Station, and within 5 days thereafter, a completed copy of the **FAA Form 7460-1**, must be submitted to the FAA Southern Regional Office in Atlanta.

13.5.2 Projects Involving Existing Bridges

Special coordination efforts are required of the Design Project Manager on projects that involve demolition, renovation, repair, repainting or replacement of any bridge.

13.5.2.1 Projects Involving Steel Bridges

For all projects that involve the repair, repainting or replacement of a steel bridge, the Design Project Manager must contact the State Corrosion Engineer in the State Materials Office to determine if the bridge contains lead or other hazardous elements. The State Corrosion Engineer will furnish a site specific specification for disposition of the lead based paint waste for that particular project.

The Design Project Manager must provide the site specific specification to the Engineer of Record who is preparing the contract plans and specifications. The Engineer of Record must ensure that the project specifications conform to the site specific specifications and that they prohibit the use of lead based paint. A mandatory pre-bid conference is not required unless special conditions exist and the district determines one is needed.

13.5.2.2 Projects Involving Bridges with Asbestos Containing Materials

There may be asbestos containing materials used in bridges. For projects involving bridges that are to be either partially or fully demolished or renovated, the Project Manager must follow the Department Procedure on ***Asbestos on Bridges / Inspection, Abatement and Notification (Topic No. 625-020-020)*** which requires coordinating as early in the project as possible with the District Asbestos Coordinator for information on asbestos inspections, abatement and for notification requirements. Some bridge elements potentially containing asbestos include (but are not limited to) the following:

1. Tender House Roof Materials (felts, flashings, mastics, etc.)
2. Tender House Floor Materials (tiles, sheet flooring, mastics, etc.)
3. Tender House Wall Materials (drywall muds, joint compounds, etc.)
4. Tender House Window Materials (caulks, gaskets, etc.)
5. Bridge Equipment Materials (gaskets, packings, linings, insulation, etc.)

6. MSE Wall Gaskets
7. Beam/Deck Bearing Pads
8. Asbestos-cement pipes (scuppers, etc.)
9. Bascule Bridge Machinery Brake Pads
10. Trowelled-on or Sprayed-on Decorative Coatings

13.5.2.3 Projects Involving Bridge Demolition

At or before the 30% plans phase, the Department will determine if it has a need for the debris resulting from the demolition of a bridge. If no such need exists, and in response to **Section 1805, SAFETEA-LU Legislation**, the Department is then required to notify local, State and Federal government agencies of the availability of the bridge debris for their beneficial use (use as shore erosion control or stabilization, ecosystem restoration, and marine habitat restoration). For any projects that involve the complete demolition of a bridge, the Design Project Manager is required to notify these agencies of the availability of the resulting debris. The Bridge Development Report (BDR)/30% Structure Plans (see **Chapter 26** of this Volume) will include the approximate volume of debris and the estimated timeframe in which the material will be available.

The Design Project Manager must coordinate with the receiving agency and the District Construction Engineer to develop a Joint Project Agreement. The receiving agency will be responsible for all additional costs associated with the processing, delivery, placement and use of the material. The following items must be determined in order for the Joint Project Agreement to be developed:

1. The volume of raw (unprocessed) debris (a more detailed quantity than original estimate).
2. The estimated timeframe for the debris availability.
3. The location of the receiving agency's staging/storage site to which the raw debris is to be delivered. Any further work involving processing and/or final placement of the material is expected to be the responsibility of the receiving agency and not part of the FDOT's contract for bridge demolition.
4. An estimated cost to transport the debris to that site. This estimate will be amount the receiving agency must pay the FDOT.

Once this information is determined, the contract plans will include the instructions for the delivery of the debris.

If no agency expresses interest in the debris material, then the material will be disposed of in accordance with FDOT Specifications.

Requirements for the original notification to agencies (including a sample Notification Letter) and the resulting Joint Project Agreement are found in the ***Project Management Handbook, Part 2, Chapter 3.***

Section 13.5.2.2 contains additional requirements for projects involving bridge demolition.

13.5.3 Projects Involving Bridges Over Navigable Water

For projects involving bridges over navigable water, the Project Manager must provide the District Structures Maintenance Engineer (DSME) sufficient notification prior to engaging in any action in, on, or around the bridge(s). This includes any field reviews involving persons conducting activities that may be perceived as suspicious (i.e., parking on the bridge, repeated viewing from a boat or other vehicle, carrying cameras and other electronic equipment like a GPS, etc.) This will allow the DSME to notify the U.S. Coast Guard prior to such activities taking place.

13.5.4 Wildlife Connectivity

Wildlife connectivity features include new or modified structures; e.g. bridges, bridges with shelves, specially designed culverts, enlarged culverts or drainage culverts. Exclusionary devices such as fencing, walls or other barriers may be included to funnel wildlife to a crossing. Disciplines that may be involved in this effort include Structures, Roadway, Drainage, Environmental Management, Permitting, Right of Way and Utilities.

Wildlife connectivity needs are usually identified during the PD&E study. However, coordinate with the District Environmental Management Office and District Permit Office early in the design phase for determination of the type, size and other parameters for the wildlife crossing feature. For further guidance on wildlife connectivity refer to the [***FDOT Wildlife Crossing Guidelines***](#), commitments section of the Environmental Document, and any other documentation regarding the wildlife connectivity related to the project.

In the event that wildlife connectivity needs are not identified until after the design process has begun, immediately start the coordination process with the District Environmental Management Office and District Permit Office.

13.5.5 Limited Access Projects Affecting Logo Structures

Determine if the construction activities on Limited Access mainline or ramp projects may impact logo sign structures. Identify and address affected logo structures in the plans. Coordinate with the State Outdoor Advertising and Logo Manager and the District Traffic Operations Office to determine if the logo structures need to be relocated or redesigned. Through this coordination, address the following questions:

1. Will the construction activities require the relocation of any logo structures during construction?
2. Where will the logo structures be reinstalled?
3. Will an upgrade of the sign panel, support or foundation of the affected logo structure be required?

Address the disposition of affected logo structures in the plans. Logo structures requiring relocation will be paid for using pay item 700-2-50 (Multi-post Sign, Relocate). Logo structures requiring replacement will be paid for with the appropriate multi-post sign removal, and installation pay items.

Refer to the Logo Sign Program web page for additional information:

<http://www.dot.state.fl.us/rightofway/LogoSignProgram.shtm>

13.5.6 Buy America Provisions

All manufacturing processes for steel or iron materials, including application of a coating, utilized in all highway construction projects must occur in the United States, in accordance with the Buy America provisions, established in **23 CFR 635.410**. Buy America requirements are covered in **FDOT Standard Specifications, Section 6**. The allowable levels of foreign steel or iron and contractor certification requirements are identified in **Specification 6-5.2**.

While **Specification 6-5.2** applies to contractors, designers also have a responsibility to ensure Buy America provisions are met. When Buy America provisions are not met, the entire project is not eligible for Federal funds. The design engineer of record needs to do sufficient research to determine that any steel or iron called for in the plans is manufactured in the United States. This is necessary when the plans include the following:

1. Non-standard or special grade steel components and shapes.
2. New proprietary products containing steel or iron materials.

3. Sole source products containing steel or iron materials.
4. Special machinery with steel or iron components.
5. Heavy sections of steel sheet pile wall.

It is not necessary to conduct such research for the following:

1. Standard domestic steel beams and shapes of standard grades as shown on the National Steel Bridge Alliance (NSBA) website.
2. Standard concrete reinforcing steel sizes and grades.
3. Standard steel drainage pipe sizes and gages.
4. Items covered in the ***Design Standards*** including:
 - a. Standard mast arm assemblies.
 - b. Standard steel guardrail, posts, and end treatments.
 - c. Standard drainage grates.
 - d. Standard steel fences.
 - e. Standard steel sign supports and structures.

If it is determined that a steel or iron product being proposed is not manufactured in the United States, then the Designer must determine if the estimated costs of such foreign steel or iron is within the thresholds stated in the specification. If the costs exceed such threshold, the Designer must explore alternatives that utilize domestic steel or iron, or seek a waiver from FHWA. Generally it is preferred to select a different engineering solution utilizing domestic products.

Should a waiver become necessary, it must be obtained BEFORE the contract letting to ensure federal funding is not jeopardized. Submit Buy America waiver requests to the Central Office for concurrence by the Directors of Design and Construction and notify the Office of Work Program of the requests. Upon concurrence, requests will then be forwarded to the FHWA Florida Division Office for approval and coordinated with the FHWA headquarters in Washington D.C. for further concurrence. Originals will be returned to the District by the Central Office. These issues must be identified early in the plans preparation process.

13.5.7 Traffic Monitoring Sites

One or more traffic monitoring sites should be considered for addition to each construction project which has a type of work consistent with the construction of such sites. Examples of compatible work types include traffic signals, resurfacing,

reconstruction, and other work that involves either pavement surfaces or electrical systems. Inquiries about monitoring sites should be addressed to the Traffic Data Section Manager of the Transportation Statistics Section, Office of Planning.

13.5.8 Fire Suppression Systems

FDOT owned fire suppression systems are not allowed on bridges, retaining walls or limited access facilities unless they are approved by the Chief Engineer due to special circumstances. Commonly occurring traffic related incidents will not be considered as special circumstances or as justification for the installation of any fire suppression system. If an FDOT fire suppression system is approved, agreements must be executed with a local agency to bear all installation costs, repair costs and maintenance functions.

Any fire suppression system that is not owned by FDOT is defined by Section 337.401, Florida Statutes as a utility and is not to be issued a utility permit unless approved by the Chief Engineer in accordance with Rule 14-46.001, Florida Administrative Code and the Utility Accommodation Manual.

13.6 Preliminary Geometry, Grades, and Cross Sections

To establish geometry, grades, and cross sections, the following activities should be accomplished or near completion:

1. Supporting data such as surveys, traffic and pavement evaluation data.
2. Typical sections and pavement design.
3. Standards, Design Variations and Design Exceptions.
4. PD&E and environmental commitments addressed and if necessary, re-evaluation.
5. Need for R/W phase addressed.
6. Utility initial contact and survey data.
7. Transit initial contact and facility location.

The initial engineering design activities to establish the preliminary project plans are:

1. Set and calculate the horizontal alignment.
2. Set the proposed profile grade lines.
3. Develop preliminary cross sections at selected intervals or control locations.
4. Develop preliminary layout of roadway, intersections, interchanges, transitions, and connections.
5. Field review all proposed preliminary engineering layout and decisions for conflicts, R/W needs, connections, updates and additional needs.

The initial engineering review is used to obtain confirmation and approval of the objectives, scope, standards, decisions, and assumptions to be used as the basis for the engineering and design. The Engineer now has the decisions and direction necessary to perform final engineering. If this is not the case, the necessary initial engineering activities must be accomplished before continuing to the final design process.

The results of the above activities should be that:

1. Structures can now be given the horizontal and vertical alignment and clearance requirements for bridges.
2. R/W Engineering can be furnished with mainline R/W requirements for the project.
3. Plan-profile sheets can be clipped.
4. Traffic plans development can be initiated.

5. Cross sections, grades and alignments, as required, can be provided to the drainage section.
6. Work sheets, as needed, can be provided to the permits section for initial evaluation.
7. Utility/Agency Owners (UAOs) can be provided plans, profiles and cross sections as required to identify/verify and designate their existing utilities as well as indicate proposed installations.
8. The list of pay items can be loaded into Designer Interface by identifying the items of work involved at this stage of design.
9. The need for noise barriers has been confirmed and locations established.

13.7 Distribution of Exempt Public Documents

It is the policy of the Department to protect the State Highway System's infrastructure by defining the responsibilities of disclosure and use of sensitive documents showing the structural elements used in the design and construction of Department structures. **Section 119.071(3)(b), F.S.**, provides that these sensitive documents are exempt from **Chapter 119, F.S., Florida's Public Record Law**. In accordance with **Section 119.07(3)(b), F.S.**, the Department has adopted **Procedure Topic No. 050-020-026, Exempt Documents Request Form**, to define the method and responsibilities for disclosure and use of these sensitive documents.

Structure is defined in **Section 334.03(27), F.S.**, as "a bridge, viaduct, tunnel, causeway, approach, ferry slip, culvert, toll plaza, gate, or other similar facility used in connection with a transportation facility" which would include related pipes and pipe systems. However, for the purpose of the public records law and **Procedure 050-020-026**, the Department has determined that the term "structure" includes "bridges with an opening of more than 20 feet between undercopings of abutments or spring lines of arches or extreme ends of openings for multiple boxes, and those other bridges subject to safety inspection under **Section 335.074, F.S.**" A roadway is not otherwise a structure for the purposes of **Procedure 050-020-026**.

Therefore, plans, blueprints, schematic drawings and diagrams of structures owned by the Department are exempt from the public records provisions of **Chapter 119, F.S.** This exemption includes draft, preliminary and final formats as described in **Procedure 050-020-026** and includes paper, electronic, and other formats. The Department has provided for the limited release of such documents in **Procedure 050-020-026**.

Entities or persons outside the Department requesting or receiving copies of any portion of plans or other documents considered Exempt Documents under **Procedure 050-020-026** must complete a request form (**Form No. 050-020-26**). The form also advises the requestor that the entity or person receiving the documents must maintain their exempt status. This procedure applies to all Department internal or contracted staff who have access to such Exempt Documents in their Department work. Refer to **Procedure 050-020-026** for additional requirements.

Chapter 14

Final Engineering Design Process

14.1	General	14-1
14.2	Final Engineering Design	14-2
14.3	Contract Plans Preparation	14-4
14.4	Standard Specifications and Special Provisions.....	14-5
14.5	Pay Items and Summaries of Quantities	14-5
14.6	Assemble Contract Plans Package	14-5

Exhibits

Exhibit 14-A	Major Activities – Final Engineering Design Process	14-ii
--------------	--	-------

Exhibit 14-A Major Activities – Final Engineering Design Process

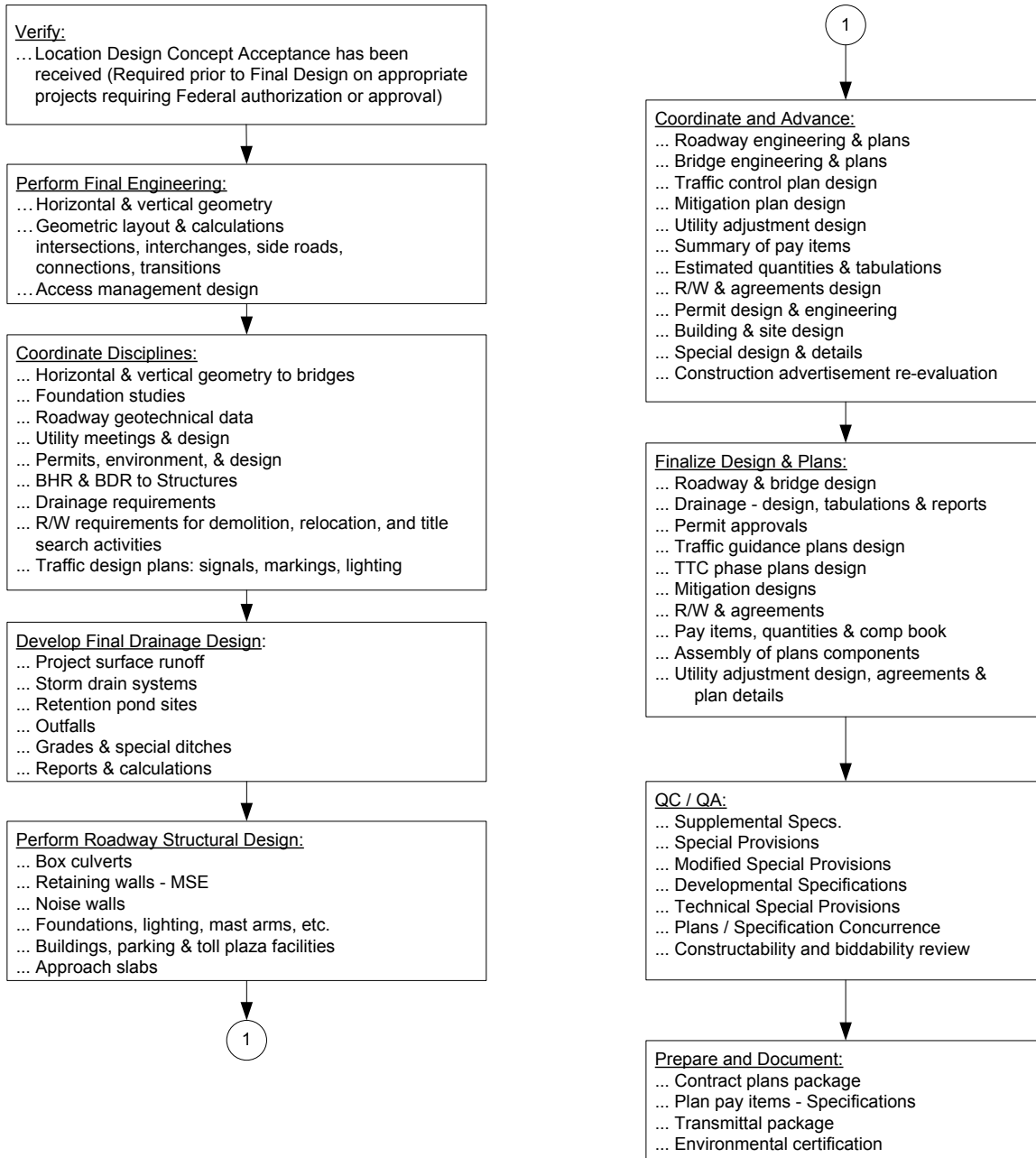

Chapter 14

Final Engineering Design Process

14.1 General

The final engineering design process follows the initial engineering design process and review. The primary objective of the final engineering design phase is to prepare contract plans and specifications that can be used to bid and construct the project with a minimum number of field changes, delays, and cost overruns.

Modification for Non-Conventional Projects:

Delete the above paragraph and replace with the following:

The primary objective of the final engineering design phase is to prepare contract plans and specifications sufficient to construct the project.

On projects requiring Federal authorization where the Design Phase and the PD&E Phase overlap, the Department must receive Location Design Concept Acceptance (LDCA), prior to acceptance of the Phase II submittal (prior to advancing into Final Design). To advance past Phase II coordinate with the Office of Environmental Management (see Part 1 Chapter 4 of the PD&E Manual). The Design Project Manager must coordinate with the PD&E Project Manager, and the District Environmental Management Office to insure that that the Department has received LDCA for the project. The Design Project Manager will need to convey this information to the district federal aid staff in the District Work Program Office. (See the [Project Management Handbook, Part 2, Chapter 3](#) for further information).

Modification for Non-Conventional Projects:

Delete the first and second sentences of the above paragraph and replace with the following:

On projects requiring Federal authorization where the Design Phase and the PD&E Phase overlap, the Department must receive Location Design Concept Acceptance (LDCA), prior to finalizing the RFP.

14.2 Final Engineering Design

The Engineer of Record (EOR) and Design Project Manager must coordinate all activities to ensure that the quality, accuracy, and appropriate decisions go into the performance of each step. The project quality control should include a plan-do-check routine for each set of activities or operations.

The major design activities include, but are not limited to, the following:

1. Pavement design
2. Drainage design
3. Structural (bridge) design
4. Structural (roadway) design
5. Roadway design including access management, earthwork, geometrics, ADA
6. Traffic plans design including signing, marking, signals, lighting
7. Utility adjustment design
8. Permit preparation design including ponds, mitigation
9. Traffic control plans (work zone) design
10. R/W requirements design
11. Building and site design including landscaping, ADA, transit
12. Estimates and Quantities preparation
13. Specifications and special provisions
14. Landscaping design
15. Noise barrier design

Modification for Non-Conventional Projects:

Delete item 12 above.

Project stationing information is to be checked and entered into the Work Program Administration (WPA) system during final engineering design. This information is important for tying construction records, such as material coring, sampling and testing to other databases. The information is entered by stations, which are related to roadway mile post for later information retrieval.

The EOR is responsible for finalizing the project stationing. The District Design Engineer should designate an individual to be responsible for coordinating the input of stationing information into the WPA system.

The begin stations, end stations, and station equations are entered into the WP50 computer screen under FM on the FDOT CL/SUPERSESSSION Main Menu for each WPA location. After logging onto SUPERSESS, the WP50 designees enter on FM (Financial Management System). On the FM Main Menu, press ENTER: 3 for WPA (Work Program Administration). On WPA Main Menu, press ENTER: 25 for WP50 (Station Definition).

Update access to WP50 screen is granted through the Work Program Development Office in Tallahassee. Listed below are the important edit and browse features:

1. Only enter FM Item Segment number on the top line.
2. The RDWYLOC sequence number displays on the top line of the screen and on the first line of the header information. It's entered on the top line to retrieve a particular location.
3. The transaction type "00" is entered on the top line to browse all station equation information for that RDWYLOC. The transaction type "02" is entered on the top line to update all station equation information for that RDWYLOC. The transaction type "99" is entered on the top line to erase all station equation information for that RDWYLOC.
4. Press the F8 key will forward from one RDWYLOC to the next RDWYLOC on the same Item Segment number. Press ENTER key to update or delete data on the screen depending on the transaction type but will not page forward.
5. Press F3 key will take the user to the FM main menu while press F15 key will take the user back to the SUPERSESS main menu.

After entering the station information, it is important to verify the milepost limits in WPA are still accurate. This can be accomplished by reviewing the WP50 computer screen.

If the project length has changed, the District Work Program Office should be advised to correct the mileposts.

14.3 Contract Plans Preparation

The products of the engineering design activities are component sets of contract plans. The major component sets may include:

1. Roadway
2. Signing and Pavement Marking
3. Signalization
4. Intelligent Transportation Systems (ITS)
5. Lighting
6. Landscape
7. Architectural Plans
8. Structures Plans

Each Utility Work by Highway Contractor Agreement may have a separate phase for each Financial Project Identification Number (FPID). The plan set for each agreement is placed in the back of the contract plans set under the associated FPID.

Modification for Non-Conventional Projects:

Delete the sentence above and replace with the following:

All Utility work that will be the Design-Build firm's responsibility to perform will be in the RFP.

These component sets, the specifications package, and the pay items list with calculated quantities are assembled and packaged as the construction contract letting documents.

Modification for Non-Conventional Projects:

Delete the sentence above and replace with the following:

These component sets, the specifications package, and the pay item list are assembled and packaged as the construction contract documents.

14.4 Standard Specifications and Special Provisions

The EOR must develop engineering designs that can be constructed, controlled, measured and paid for under the current [Standard Specifications](#). In the event the work required is not covered by the Standard Specifications or the supplements and special provisions thereto, the EOR must develop Modified Special Provisions or Technical Special Provisions to be made part of the contract for the project. The EOR can obtain Department procedural guidance to assist with the preparation of the specifications package.

14.5 Pay Items and Summaries of Quantities

As the engineering plans are prepared, the quantities are calculated, tabulated, and summarized by Pay Item (of work) as stipulated by the Standard Specifications and the [Basis of Estimates Manual](#). The summary of pay items is updated as quantities are determined and summarized.

Modification for Non-Conventional Projects:

Delete <i>PPM</i> 14.5.

14.6 Assemble Contract Plans Package

The completed plans, specifications package, and District estimate are transmitted to the Central Office for letting or they are assembled and held in the district for district advertisement and letting. **Chapter 20** of this volume provides further guidance on the contents of the transmittal.

Modification for Non-Conventional Projects:

Delete <i>PPM</i> 14.6.

THIS PAGE LEFT BLANK INTENTIONALLY

Chapter 15

Update Engineering Design Process

15.1	General	15-1
15.2	Design Update Review and Decision Process.....	15-1
15.3	Updating Engineering Design and Documents	15-2
15.4	Revised Contract Plans Package	15-2
Exhibits		
Exhibit 15-A	Major Activities - Update Engineering Design Process	15-ii

Exhibit 15-A Major Activities - Update Engineering Design Process

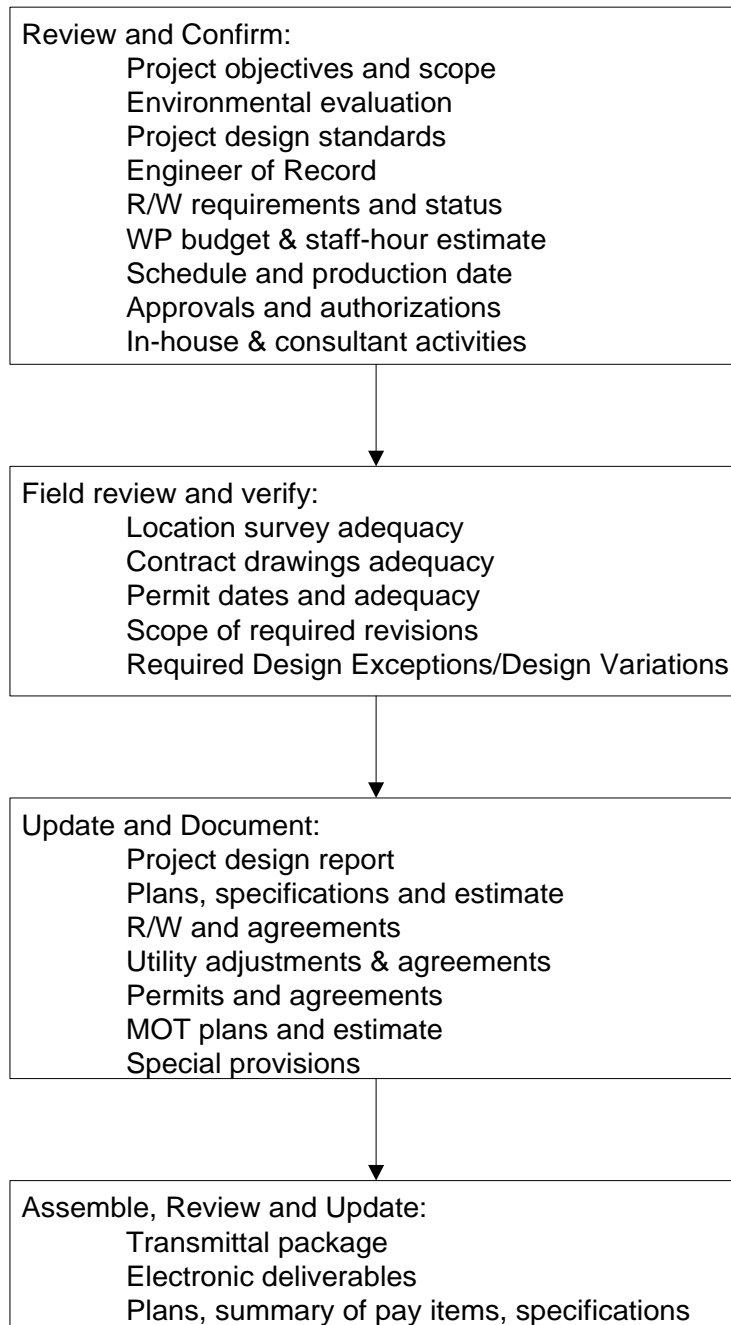

Chapter 15

Update Engineering Design Process

15.1 General

The update engineering design process begins when a final contract plans, specification and estimates (PS&E) package has been on the shelf for any significant period (approximately nine months). The update process depends on the type of project, the adequacy and appropriateness of the original design controls and standards, and the original scope and objectives. The extent of the update process should be determined based on both engineering and management input.

15.2 Design Update Review and Decision Process

An engineering review of the PS&E and proposed contract documents must be made to determine the activities required to update the package and get it ready for letting.

1. The original project objectives, scope and standards must be reviewed and compared with current corridor conditions, as well as growth rate and patterns, to determine if the project design is still valid.
2. Original environmental evaluations and commitments must be weighed against current requirements.
3. Permit date and terms must be weighed against current requirements.
4. R/W certifications and agreements must be reviewed and the status of documents confirmed.
5. Contract plans must be reviewed for current requirements, including standard indexes, specifications, pay items and design criteria.
6. Agreements with outside entities such as Utility/Agency Owners (UAOs), maintaining agencies and local agencies must be reviewed.
7. Design Exceptions and Design Variations must be resubmitted with updated documentation based on current data and conditions.

If the decision is that engineering updates are required, the scope, staff-hour estimate, schedule, cost estimate, and other activities described in **Chapter 13** of this volume should be followed to the extent necessary to define the scope and schedule for the update process.

15.3 Updating Engineering Design and Documents

The actual engineering design activities necessary to update the plans package will vary from project to project. They must be fully described in the professional services contract, if one is to be used. If done in-house, a fully defined scope of work must be developed to determine resources and schedule needed for the update.

All reports, calculations, assumptions, and engineering decisions that support the changes to plans, specifications, or other documents must be signed and sealed by the Engineer updating the engineering plans, specifications and documents. All changes to the plans must be approved by the responsible engineer in charge of the work and receive the concurrence of the District Design Engineer, Structures Design Engineer, or Consultant Project Management Engineer, as appropriate for the type of change. Updated documentation of all approvals and concurrences must be in the project file.

15.4 Revised Contract Plans Package

In addition to the required engineering changes, which may be necessary, the contract transmittal package must be reviewed and updated to current status.

1. All component plans sets are made current and sealed.
2. Specifications and special provisions are made current.
3. The CADD electronic files are revised.
4. The pay item summaries are made current.
5. The contract file is made current.

Chapter 16

Design Submittals

16.1	General	16-1
16.2	Design Documentation Submittals	16-4
16.2.1	Field Survey Data	16-4
16.2.2	Project Traffic	16-5
16.2.3	Typical Section Package.....	16-5
16.2.4	Preliminary Drainage Design.....	16-9
16.2.5	Preliminary Geometry and Grades	16-10
16.2.6	Preliminary Traffic Control Plan	16-10
16.2.7	Pavement Selection and Design.....	16-11
16.2.8	Preliminary Utilities	16-11
16.3	Structures Submittals	16-12
16.3.1	Coordination of Structural Design - (Bridges and Retaining Walls)	16-12
16.3.2	Bridges	16-12
16.3.3	Other Structural Submittals and Reviews	16-13
16.4	Plans Phase Reviews	16-14

Exhibits

Exhibit 16-A	List of Requests and Contacts	16-2
Exhibit 16-B	Typical Section Package.....	16-16

Chapter 16

Design Submittals

16.1 General

The design process will require various submittals to transfer technical information and decisions between the Engineer of Record (EOR), certain Department personnel, and functional areas. The Project Manager is responsible for the adequacy of the submittals or requests and for the coordination of reviews between the Department and the EOR. Each office head including the District Construction and Maintenance Engineers should assume direct responsibility for assigning reviewers and meeting the review schedules. To the extent practical, the contract scope of work should list the information to be furnished by FDOT functional areas and submittals (number and type) required of the EOR. **Exhibit 16-A** is a partial list of functional areas with typical submittals and requests.

During the design process, various items of information may be required from different sections or departments. The following is a list of some of those items and their source:

Exhibit 16-A List of Requests and Contacts
Sheet 1 of 2

A) Planning

Request pavement design (18 Kip ESAL)
Request project traffic
Request turning movements for intersections
Request updates of project traffic (as needed)
Railroad contact (Phase I and III)
Plans transmittal letter data (railroad)
Notification that project is in vicinity of a traffic monitoring site

B) Traffic Plans/Traffic Operations

Request turns and counts for intersection design
Notification that project includes milling
Signing & pavement marking plans (Phase I, II, III)
Traffic signal plans (Phase I, II, III) & signal warrant
Lighting plans (Phase I, II) & justification report
Pedestrian and bicycle project traffic
Safety/crash analysis and recommendations
Operational and capacity review of design plans

C) Geotechnical

Request pavement design soil information
Request roadway soil survey
Soils data
Request foundation investigations
Request dynaflect testing
Phase III review, if unsuitable soils exist.
Soils and foundation recommendations
PH and soils resistivity for culvert material selection
Request pavement composition and milling recommendations
Review if any changes are made in alignment, grade or typical section.
Bridge Geotechnical Report

D) Surveying and Mapping

Request survey

E) Drainage

Request grade and high water review
Conceptual drainage plan & assumptions
Bridge Hydraulics Report
Request drainage design
Request final drainage review
Permit review
SWPPP
Erosion Control Plan

F) Maintenance

Pavement design comments
Phase I Plans review & response
Phase II Plans review & response
Phase III Plans review & response

G) Construction

Pavement design comments
Phase I Plans review & response
Phase II Plans review (constructability) & response
Phase III Plans review (biddability) & response
Submit traffic control plan request
Contract time

H) R/W Surveying and Mapping

Submit title search request
Request existing right of way maps
Transmit right of way requirements
Final right of way check
Plans transmittal letter data

I) Utilities

Preliminary (First) contact (Phase I)
Pre-Design conference and contact (Phase II)
Final contact (Phase III)
Horizontal and vertical verification of utilities
Plans transmittal letter data (utilities)
Number of sets of final prints for utility companies

**Exhibit 16-A List of Requests and Contacts
Sheet 2 of 2**

J) Estimates and Specifications

Preliminary estimate (LRE)
Preliminary estimate (Phase I)
Preliminary estimate (Phase II)
Preliminary estimate (Phase III)
Complete estimate (Phase IV)

K) Right Of Way Department

Project schedule updates as needed
R/W estimates as needed
Pre-Proposal appraisal conference
Field questions from R/W agents as needed
Plans transmittal letter data
Phase I Plans Review (by Appraiser)
Phase II Plans Review (by Appraiser)
Phase III Plans Review (by Appraiser)
Phase IV Plans Review (by Appraiser)

L) FHWA (if not exempt)

Phase I Plans review & response
Phase II Plans review & response
Phase III Plans review & response
Phase IV Plans review & response
Submit for typical section approval
Submit for pavement design approval
Submit Design Exception request letters
R/W review

M) Value Engineering (\$2,000,000+)

Phase I & II reviews

N) Environmental

Hazardous waste determination
SWPPP
Erosion Control Plan
Mitigation Plans

O) Materials

Environmental Classifications
Type of Structural Steel (existing)
Existence of Lead-Based Paint

P) Bridge

Phase I, Bridge Analysis, review & response
Phase II Plans review & response
BDR/30% Plans review and response
60% Plans review & response
90% Plans review & response
100% Plans review & response

Q) Public Transportation/Modal Development

Notification that project contains a transit route
Request transit agency contact(s)
Request facility locations and information
Identify any special transit needs
Phase I Plans review & response
Phase II Plans review & response
Phase III Plans review & response
Number of sets of final prints for transit agencies

Modification for Non-Conventional Projects:

Delete **PPM** 16.1 and replace with the following:

See **Chapter 2** of Volume 2 for a list of submittal requirements.

16.2 Design Documentation Submittals

During the engineering processes there is the need to submit information to specific Department personnel for the purpose of making timely decisions and confirming the project objectives. These submittals will take place as these activities are completed so that issues do not go unresolved before subsequent activities begin. The following are some submittals that should take place during initial engineering. Ideally these engineering type submittals should be done in lieu of traditional phase plans reviews.

16.2.1 Field Survey Data

Evaluate the following typical field survey data for sufficient breadth and accuracy to complete the proposed design. Bring deficiencies to the attention of the Department.

1. Design location survey data including horizontal and vertical control, alignments, reference points, utilities, natural and manmade features, and topography or general shape of the terrain.
2. Digitized aerial survey data, especially for large areas such as drainage maps.
3. Drainage design survey data from site inspection and historical records.
4. Right of Way and related property (land) survey data, including property owners and acreage.
5. Geotechnical studies and foundation and soils report, including physical properties and classifications of soils, together with recommendations related to foundations, pavement and drainage design.
6. Bridge data sheet surveys, channel alignment survey data and bathymetric data.

16.2.2 Project Traffic

In the development of roadway plans, project traffic is primarily used to justify the number of through lanes, geometric improvements to intersections, traffic signal timings, and pavement design. The number of through lanes is usually determined during the project development phase, based on Annual Average Daily Traffic (AADT) and factors included in the typical section. Vehicular traffic data provided in the plans typical section includes AADT for the current year, opening year and the design year. Also included are the design hour factor (K is the Department's Standard "K" factor as provided by the State Transportation Statistics Office), the directional distribution (D is the percent of two way peak hour traffic that occurs in the peak direction), and truck factors (T is the percent that trucks constitute of vehicular traffic) for the peak hour and a 24 hour period. The source and methods used to produce this data must be documented.

Intersection improvements and signal timings require additional information on turning volumes. The [FDOT Project Traffic Forecasting Procedure](#) (Topic No.: 525-030-120) describes the input data required, explains the procedure to forecast turning volumes, and provides examples. A Project Traffic Report will be required. Traffic counts provide input on the number of motor vehicles, bicycles and pedestrians using an intersection. At proposed (non-existing) major intersections, turning volumes are estimated using transportation planning models or other means. Forecasts provide designers the information required to determine the need for turning lanes, turning bay length, signal timings, and pedestrian crossings. Also, the designer establishes right of way requirements based on documented needs to satisfy design year volumes.

In pavement design, the designer requires AADT forecasts for the year a project opens to traffic and for the design year. AADT, together with percent trucks (24 hour period) and other factors used by the Department, provides information on the pavement loadings used in pavement design. The [FDOT Project Traffic Forecasting Procedure](#) provides additional information.

16.2.3 Typical Section Package

All projects that add or alter cross section elements, and all resurfacing projects, require the preparation and concurrence of a typical section package.

The typical section package must be prepared and sealed by the responsible engineer.

The typical section package is the instrument for formal review and concurrence of the proposed project cross sectional elements by the appropriate FDOT District Design Engineer. Review and concurrence of the typical section package by the FHWA Transportation Engineer is required on projects that have FHWA oversight (see **Chapter 24** of this volume for determination of FHWA oversight).

The purpose of the typical section package review and approval process is to:

1. Establish typical transverse geometry
2. Consider safety related issues
3. Ensure compatibility between the bridge typical section and the roadway typical section

The typical section package consists of a Project Controls Sheet and Project Identification/Proposed Typical Section Sheet. The Project Identification/Proposed Typical Section Sheet should not be confused with the Typical Section Plan Sheet, which is part of the Contract Plans Set and is discussed in **Chapter 6** of Volume 2. The Project Controls Sheet contains the project data, which serves as a basis for selecting criteria and establishing project standards for cross-sectional elements. The Project Identification/Proposed Typical Section Sheet contains: data which uniquely identifies the project; a detail of the proposed typical cross section with critical dimensions and cross sectional elements labeled; and signature blocks.

Usually, Project Identification/ Proposed Typical Section Sheets will be prepared for the main roadway and bridges. However, additional Project Identification/Proposed Typical Section Sheets:

1. **Are** required if:
 - a. A change in the number of through lanes occurs.
 - b. Flush shoulders change to curbing or vice versa.
 - c. A crossroad which may affect a structure exists.
 - d. Major work of significant length is being done on an intersecting roadway.
2. **May** be required if a change in design speed occurs within the project limits.

The proposed typical sections for roadway and bridges are to be submitted by the responsible engineer for concurrence by the District Design Engineer. Coordination with the District Structures Design Engineer is also required on all bridge typical sections. Submit the roadway and bridge typical sections to ensure compatibility.

The typical section package for both roadway and bridges will be approved as part of the Project Development & Environmental (PD&E) process. Typical section package preparation, and coordination between the responsible PD&E engineer and the District Design Engineer, must occur during the development of project alternatives prior to preferred alternative selection. The responsible PD&E engineer must prepare, seal and submit the typical section package for concurrence. Typical section package concurrence by the District Design Engineer must be obtained after the preferred alternative is selected. Include a copy of the approved typical section package as part of the PD&E Final Preliminary Engineering Report.

For projects that do not contain a PD&E phase, the typical section package must be prepared, sealed and submitted by the responsible engineer for concurrence by the District Design Engineer. The typical section package should be concurred with prior to the final engineering process.

The Engineer of Record must coordinate with the District Design Engineer, the District Traffic Operations Engineer, and the responsible PD&E engineer to discuss the anticipated posted speed. The selected design speed will be jointly approved by the District Design Engineer and the District Traffic Operations Engineer. This joint approval must be documented on the Typical Section Data Sheet (see **Exhibit 16-B, Sheet 1 of 6**).

Exhibit 16-B contains example typical section package sheets. The following is an outline of the information which is required as part of the typical section package submittal. This information is critical for proper evaluation by the District Design Engineer. Missing information may require a resubmittal of the typical section package.

The following information is required on the project controls sheet:

1. Financial Project ID
2. County (and Section)
3. Project Description
4. Functional Classification
5. Highway System
6. Access Classification
7. Traffic Data (AADT, for Current, Opening and Design Year, Design Speed, Posted Speed; K, D, and T Factors)
8. Potential Design Exceptions and Design Variations related to the typical section elements

9. List Major Structures Requiring Independent Structures Design (including location and description)
10. List Major Utilities within project corridor
11. List other information pertinent to the design of the project

The following information is required on the project identification/proposed typical section sheet:

Project Identification:

1. Financial Project ID
2. State Project No. (if assigned)
3. Federal Aid Project No. (if assigned)
4. Work Program Item (if assigned)
5. Road Designation
6. County Name (and Section)
7. Limits (In Milepost)
8. Project Description

Proposed Roadway Typical Section Drawing:

1. Design Speed
2. Limits (station limits of the typical section shown if available, may include other limits description, i.e., mile posts, street names, etc.)
3. Lanes (dimension width, show cross slope of each lane, label bike and HOV lanes)
4. R/W Line (graphically show, label and dimension from centerline const.)
5. Shoulder (dimension width, show cross slope, paved shoulder is dimensioned and labeled separately)
6. Curb (graphically show curb, label curb type)
7. Median (dimension width, show slopes, graphically show whether median is typically depressed or raised)
8. Centerline Construction and/or Baseline Survey (graphically show and label)
9. Profile Grade Point (label)
10. Slopes (dimension and label)
11. Border Width (dimension and label for new construction)

12. Ditches (show typical front slope and typical back slope, dimension typical ditch width and depth, and label)
13. Natural Ground Line (graphically show and label)
14. Pavement and Roadbed (graphically show)
15. Barriers (graphically show, dimension, and label)
16. Sidewalk or Shared Use Path (graphically show, dimension, and label)

Proposed Structure Typical Section Drawing:

1. Design Speed
2. Bridge Description w/ Crossing Information
3. Lanes (dimension widths, and show cross slope of each lane, label bike or HOV lanes)
4. R/W Line (graphically show, label and dimension from centerline const.)
5. Shoulder (dimension, show cross slope, and label)
6. Gutter (dimension width, and graphically show)
7. Median (dimension width, show slopes, graphically show whether median is typically depressed or raised)
8. Centerline Construction and/or Baseline Survey (graphically show and label)
9. Bridge Deck (graphically show, dimension)
10. Profile Grade Point (label)
11. Barriers (graphically show including railing, dimension width, and label)
12. Sidewalk or Shared Use Path (graphically show, dimension width, and label)

The typical section package sheets are provided in the FDOT Engineering/CADD Systems Software.

16.2.4 Preliminary Drainage Design

On projects where the drainage design is a critical element the following items should require a preliminary submittal:

1. Determination of water elevations affecting the roadway grade. These include base clearance water elevations and design flood elevations.
2. Pond Siting Report
3. Documentation of preliminary drainage coordination with permitting agencies

4. Information that is essential to proper evaluation of drainage design concepts such as seasonal high ground water, soil types, existing cross drain peak design stages, historical pavement failure, flood plain elevation, present water elevations, drainage areas, etc.

16.2.5 Preliminary Geometry and Grades

On projects where connections to the facility make grades a critical element, back of sidewalk profiles, project profile grades, determination of water elevations affecting the roadway grade, and driveway and side street geometry should require a preliminary submittal. The Department may require the designer to present the project geometry and grade to a geometry and grade technical review team to encourage productive dialogue and proper communication regarding these design issues. If a bridge exists within the project limits, the early input of the structural designer as to approach grades and clearance needs should be coordinated to ensure proper bridge design.

16.2.6 Preliminary Traffic Control Plan

On projects where the traffic control plan is a critical element the following items should require a preliminary submittal.

1. Typical sections of each construction phase with information that is essential to proper evaluation of each construction phase such as: location and nature of proper construction drainage; regulatory speed; location of work zone; proposed traffic control devices; number, width and location of maintained traffic; maximum drop-off; maintenance of existing lighting.
2. Documentation addressing possible innovative construction techniques; need for temporary detours, hazardous material excavation, temporary structures, etc.
3. Documentation of coordination with the local community: i.e., city and county transportation engineers, businesses, police, hospitals, civic centers or arena operations, fire department, schools, mass transit, etc.
4. When a temporary bridge is used, the designer must coordinate with the State Bridge Evaluation Engineer in Tallahassee (Office of Maintenance) to ensure that a detour route for overweight vehicles is included in the plans. If no detour route is available, the temporary bridge may have to be designed to support multi-trip overweight vehicles.

16.2.7 Pavement Selection and Design

The pavement selection and design should be completed as early in the process as possible. The *Rigid* and *Flexible Pavement Design Manuals* are available through the Maps and Publications Sales Office.

16.2.8 Preliminary Utilities

On projects where utility coordination is a critical element the following early involvement activities should be required.

1. Before Phase I plans submittal, early involvement can be obtained by coordinating a review of the utility information in the topographic survey. This review may be accomplished by distribution of the topographic survey to all Utility/Agency Owners (UAOs) through the District Utility Office for mark-ups and confirmation of existing facilities.
2. Once the designer has reviewed the early topographic survey mark-ups a meeting should be held with the UAOs, District Utility Office and the designer to discuss errors, omissions, and future plans of the utilities already identified within the corridor. This will allow the designer the ability to prioritize which utilities will ultimately impact the design.

16.3 Structures Submittals

Structures design elements also go through decision-making reviews at various stages of the design as listed below:

16.3.1 Coordination of Structural Design - (Bridges and Retaining Walls)

All requests for structural design should include roadway plan and profile sheets showing horizontal and vertical alignment and cross sections within 500 feet of each end of the bridge or ends of retaining walls. Horizontal curvature that is on or near the end of the bridge or retaining wall must be shown. Nonstandard superelevation transition details or other special profiles must be included if any part or all of the transition is on the bridge or wall. The approved typical section is required.

Provisions for access to property near the end of bridges and adjustments to avoid costly right of way takings should be resolved.

16.3.2 Bridges

Bridge design begins when the Phase I bridge geotechnical report is complete and proceeds on a schedule which allows simultaneous review of the final (90%) bridge plans and the Phase III roadway plans. All structures design work is coordinated through the District Structures Design Engineer or the State Structures Design Office in the Central Office, depending on the category or complexity of the structure. Determine the typical section of the facility crossing, the horizontal and vertical clearance requirements, and the profile grades prior to beginning structures design. For complete details and requirements for structural designs and plans preparation, the reader is referred to **Chapter 26** of this volume and the **Structures Detailing Manual** issued by the State Structures Design Office.

Generally, the completion and review of bridge designs are accomplished in the following phases:

1. BDR/30% Structures Plans
2. 60% Structures Plans
 - a. (Foundation submittal for all Structures and full)
 - b. (Submittal for Category 2 or unusual structures only)
3. 90% Structures Plans
4. 100% Structures Plans

These reviews should be coordinated with the phase reviews of the roadway plans. Submit the latest set of structural plans with the Phase II roadway plans submittal. This joint submittal at Phase II roadway plans review is to ensure that roadway and bridge structures plans are consistent, i.e., widths, superelevation transitions, vertical and horizontal alignment, and work zone traffic control agree. The precise number and type of plans submittals depends on the complexity of the design and/or the sensitivity of the project. Each submittal must include written responses to the comments received on the previous submittal.

Modification for Non-Conventional Projects:

Delete **PPM** 16.3.2 and replace with the following:

16.3.2 Bridges

For bridge submittal requirements see RFP and **Chapter 26**.

16.3.3 Other Structural Submittals and Reviews

In addition to bridge plans, structures plans may include retaining walls, sheet piling, noise barriers, box or three-sided culverts, pedestrian overpasses, temporary bridges, and special structural appurtenances. Special structural appurtenances that include transit related furnishings and amenities would require review by the local transit agency.

For projects where bridges and other structures plans are involved, preliminary and final plan submittals (usually along with bridge plans) should be handled according to the instructions for structures plans submittals covered in **Chapters 26** and **30** of this volume.

For projects where retaining walls are required along with roadway plans only (no bridge in the project), follow the procedure outlined in **Chapter 30** of this Volume. The submittal of detailed control plans should occur as early in the design process as possible.

Where the District Roadway Office cannot carry out the structural review or verify the review as proper by a consultant, such review may be requested from the District Structures Design Office or the State Structures Design Office.

16.4 Plans Phase Reviews

The number of submittals and phase reviews is determined on a project-by-project basis and defined in the scope. Submittals allow functional areas to review the development of the project as contained in the scope.

Formal plans phase review requirements are covered in the District Quality Control Plan. Reviews should include Department personnel that can assist in making timely decisions and confirm that the requirements have been met for their discipline. Ideally, reviews should be driven by the engineering process and should occur when there is a need for input or a decision to complete a critical activity before progressing with the design. Some of these activities are discussed in **Section 16.2**. Reviews are complete when the comments from all the various offices have been resolved and have been documented as required in **Chapter 24** of this Volume.

Constructability and biddability reviews by the District Construction Office will be included at appropriate stages of the phase review process. Procedures for these reviews are provided in the **Construction Project Administration Manual (Topic No. 700-000-000)**.

Minor projects, such as resurfacing, should typically have two plans phase reviews. The two reviews should consist of a decision-making phase review on the scope and intent of the project and a final plans phase review for constructability/biddability. One of these will be an on-site review.

On complex projects plans phase reviews may be required at the Phase I, II and III stages and a final check at Phase IV. Two on-site reviews will be required. Generally, one of the site reviews is held early in the initial engineering phase.

Section 2.3 of Volume 2 outlines, in detail, the sequence for contract plans preparation and assembly required by the several design phase submittals. Also included in the chapter is information required to be presented on various plan sheets included with each submittal.

When the plans are in compliance with all phase review requirements and are considered final, they are to be submitted in accordance with the process described in **Chapter 20** of this Volume.

Modification for Non-Conventional Projects:

Delete *PPM* 16.4 and replace with the following:

16.4 Plans Phase Reviews

Chapter 2 of Volume 2 outlines, in detail, the sequence for contract plans preparation and assembly required by the design phase submittals. The other chapters in Volume 2 describe information required to be presented on the various plan sheets with each submittal.

**Exhibit 16-B Typical Section Package
 Sheet 1 of 6**

PROJECT IDENTIFICATION																													
FINANCIAL PROJECT ID _____ COUNTY (SECTION) _____ PROJECT DESCRIPTION _____																													
PROJECT CONTROLS																													
<p align="center"><u>FUNCTIONAL CLASSIFICATION</u></p> <p align="center"><input type="checkbox"/> RURAL <input type="checkbox"/> URBAN</p> <p><input type="checkbox"/> FREEWAY/EXPWY. <input type="checkbox"/> MAJOR COLL. <input type="checkbox"/> PRINCIPAL ART. <input type="checkbox"/> MINOR COLL. <input type="checkbox"/> MINOR ART. <input type="checkbox"/> LOCAL</p>	<p align="center"><u>HIGHWAY SYSTEM</u></p> <p>Yes No</p> <p><input type="checkbox"/> <input type="checkbox"/> NATIONAL HIGHWAY SYSTEM <input type="checkbox"/> <input type="checkbox"/> STRATEGIC INTERMODAL SYSTEM <input type="checkbox"/> <input type="checkbox"/> STATE HIGHWAY SYSTEM <input type="checkbox"/> <input type="checkbox"/> OFF STATE HIGHWAY SYSTEM</p>																												
<p align="center"><u>ACCESS CLASSIFICATION</u></p> <p><input type="checkbox"/> 1 - FREEWAY <input type="checkbox"/> 2 - RESTRICTIVE w/Service Roads <input type="checkbox"/> 3 - RESTRICTIVE w/660 ft. Connection Spacing <input type="checkbox"/> 4 - NON-RESTRICTIVE w/2640 ft. Signal Spacing <input type="checkbox"/> 5 - RESTRICTIVE w/440 ft. Connection Spacing <input type="checkbox"/> 6 - NON-RESTRICTIVE w/1320 ft. Signal Spacing <input type="checkbox"/> 7 - BOTH MEDIAN TYPES</p>	<p align="center"><u>TRAFFIC</u></p> <table style="width: 100%; border-collapse: collapse;"> <thead> <tr> <th></th> <th style="text-align: center;">YEAR</th> <th style="text-align: center;">AADT</th> </tr> </thead> <tbody> <tr> <td>CURRENT</td> <td style="text-align: center;">_____</td> <td style="text-align: center;">_____</td> </tr> <tr> <td>OPENING</td> <td style="text-align: center;">_____</td> <td style="text-align: center;">_____</td> </tr> <tr> <td>DESIGN</td> <td style="text-align: center;">_____</td> <td style="text-align: center;">_____</td> </tr> </tbody> </table> <p align="right"><u>DISTRIBUTION</u></p> <table style="width: 100%; border-collapse: collapse;"> <tbody> <tr> <td>DESIGN SPEED</td> <td style="text-align: center;">_____</td> <td style="text-align: center;">K</td> <td style="text-align: center;">%</td> </tr> <tr> <td>POSTED SPEED</td> <td style="text-align: center;">_____</td> <td style="text-align: center;">D</td> <td style="text-align: center;">%</td> </tr> <tr> <td></td> <td></td> <td style="text-align: center;">T₂₄</td> <td style="text-align: center;">%</td> </tr> </tbody> </table> <p align="center">DESIGN SPEED APPROVALS</p> <table style="width: 100%; border-collapse: collapse;"> <tbody> <tr> <td style="width: 70%; border-top: 1px solid black; text-align: center;">DISTRICT DESIGN ENGINEER</td> <td style="width: 30%; border-top: 1px solid black; text-align: center;">DATE</td> </tr> <tr> <td style="border-top: 1px solid black; text-align: center;">DISTRICT TRAFFIC OPERATIONS ENGINEER</td> <td style="border-top: 1px solid black; text-align: center;">DATE</td> </tr> </tbody> </table>		YEAR	AADT	CURRENT	_____	_____	OPENING	_____	_____	DESIGN	_____	_____	DESIGN SPEED	_____	K	%	POSTED SPEED	_____	D	%			T ₂₄	%	DISTRICT DESIGN ENGINEER	DATE	DISTRICT TRAFFIC OPERATIONS ENGINEER	DATE
	YEAR	AADT																											
CURRENT	_____	_____																											
OPENING	_____	_____																											
DESIGN	_____	_____																											
DESIGN SPEED	_____	K	%																										
POSTED SPEED	_____	D	%																										
		T ₂₄	%																										
DISTRICT DESIGN ENGINEER	DATE																												
DISTRICT TRAFFIC OPERATIONS ENGINEER	DATE																												
<p align="center"><u>CRITERIA</u></p> <p><input type="checkbox"/> NEW CONSTRUCTION / RECONSTRUCTION <input type="checkbox"/> RRR INTERSTATE / FREEWAY <input type="checkbox"/> RRR NON-INTERSTATE / FREEWAY <input type="checkbox"/> TDLC / NEW CONSTRUCTION / RECONSTRUCTION <input type="checkbox"/> TDLC / RRR <input type="checkbox"/> MANUAL OF UNIFORM MINIMUM STANDARDS (FLORIDA GREENBOOK) (OFF-STATE HIGHWAY SYSTEM ONLY)</p>																													
<p>LIST ANY POTENTIAL EXCEPTIONS AND VARIATIONS RELATED TO TYPICAL SECTION ELEMENTS:</p>																													
<p><i>LIST MAJOR STRUCTURES LOCATION/DESCRIPTION - REQUIRING INDEPENDENT STRUCTURE DESIGN:</i></p>																													
<p><i>LIST MAJOR UTILITIES WITHIN PROJECT CORRIDOR:</i></p>																													
<p><i>LIST OTHER INFORMATION PERTINENT TO DESIGN OF PROJECT:</i></p>																													

Exhibit 16-B, Sheet 2 of 6

PROJECT IDENTIFICATION		
FINANCIAL PROJECT ID <u>000002-1-32-01</u> FEDERAL AID PROJECT NO. <u>FEDERAL FUNDS</u> COUNTY NAME <u>HILLSBOROUGH</u>	SECTION NO. <u>12345</u> ROAD DESIGNATION <u>SR 99</u> LIMITS/MILEPOST <u>(MP 7.381 TO MP 10.535)</u>	
PROJECT DESCRIPTION <u>MULTILANE RECONSTRUCTION OF SR 99 FROM CR 239 (CALHOUN BLVD.) TO I-10</u>		
PROPOSED ROADWAY TYPICAL SECTION		
<p style="text-align: center;">DESIGN SPEED = 45 mph STA. 250+38.00 TO STA. 416+91.12 9TH STREET TO 12TH STREET</p>		
APPROVED BY: (Engineer of Record Printed Name)	FDOT CONCURRENCE Signature Block Printed Name FDOT District Design Engineer	FHWA CONCURRENCE Signature Block Printed Name FHWA Transportation Engineer
Engineer of Record Signature and Date	Signature Block Printed Name Date	Signature Block Printed Name Date

Exhibit 16-B, Sheet 3 of 6

PROJECT IDENTIFICATION		
FINANCIAL PROJECT ID <u>000002-1-32-01</u> FEDERAL AID PROJECT NO. <u>FEDERAL FUNDS</u> COUNTY NAME <u>HILLSBOROUGH</u>	SECTION NO. <u>12345</u> ROAD DESIGNATION <u>SR 99</u> LIMITS/MILEPOST <u>(MP 7.381 TO MP 10.535)</u>	
PROJECT DESCRIPTION <u>MULTILANE RECONSTRUCTION OF SR 99 FROM CR 239 (CALHOUN BLVD.) TO I-10</u>		
PROPOSED STRUCTURE TYPICAL SECTION		
<p style="text-align: center;">DESIGN SPEED = 50 mph</p> <p style="text-align: center;">SR 99 BRIDGE OVER TUCKER CANAL</p>		
APPROVED BY: (Engineer of Record Printed Name)	FHWA CONCURRENCE	Signature Block Printed Name FHWA Transportation Engineer
Engineer of Record Signature and Date	FOOT CONCURRENCE	Signature Block Printed Name FDOT District Design Engineer

Exhibit 16-B, Sheet 4 of 6

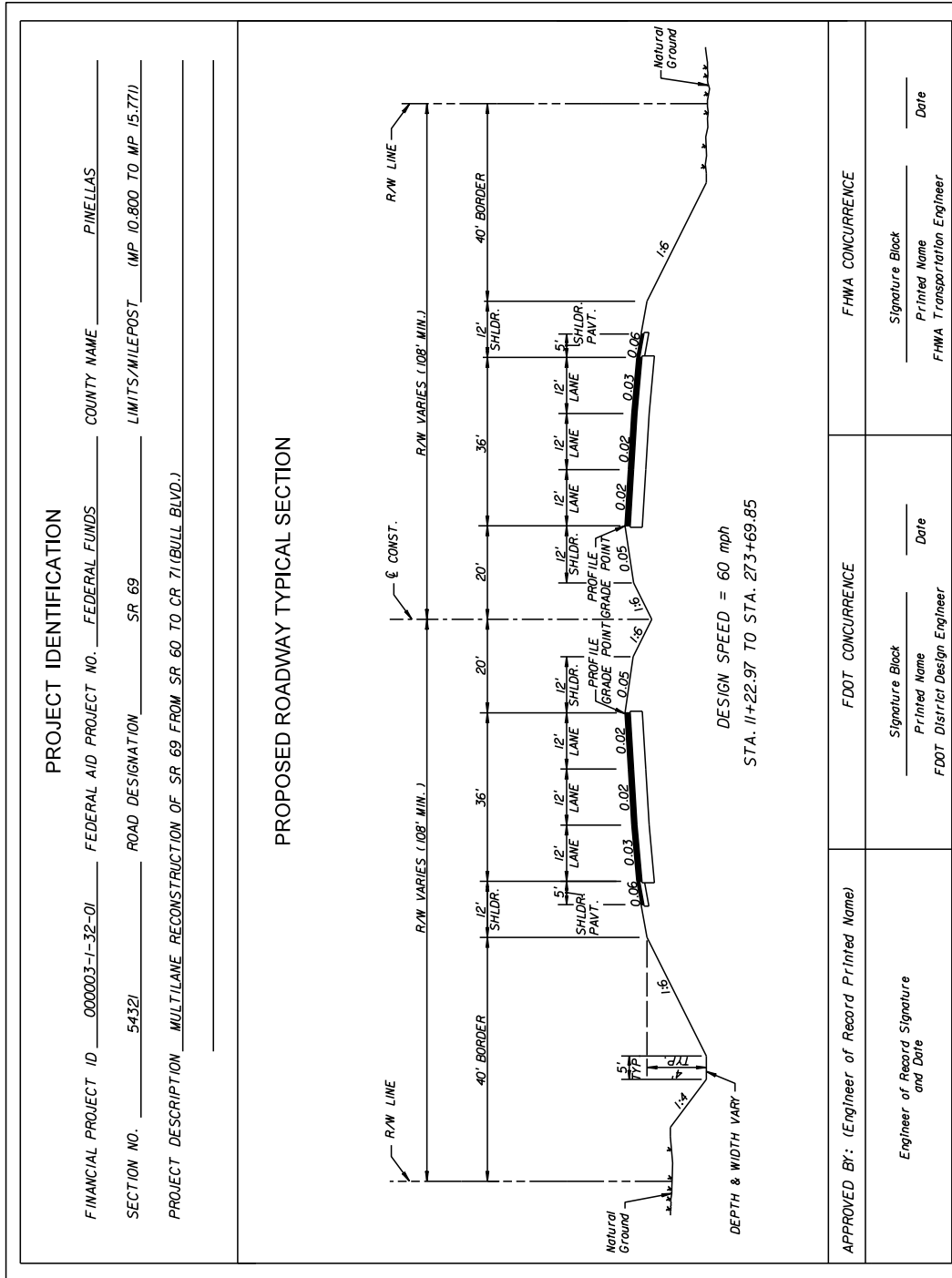

Exhibit 16-B, Sheet 5 of 6

PROJECT IDENTIFICATION	
FINANCIAL PROJECT ID 000003-1-32-01	FEDERAL AID PROJECT NO. _____ COUNTY NAME PINELLAS
SECTION NO. 54321	LIMITS/MILEPOST (MP 10.800 TO MP 15.771)
ROAD DESIGNATION SR 69	
PROJECT DESCRIPTION MULTILANE RECONSTRUCTION OF SR 69 FROM SR 60 TO CR 71 (BULL BLVD.)	
PROPOSED STRUCTURE TYPICAL SECTION	
<p style="text-align: center;">DESIGN SPEED = 60 mph SR 69 BRIDGE OVER WHATCHAMACALLIT RIVER</p>	
APPROVED BY: (Engineer of Record Printed Name)	FHWA CONCURRENCE
Signature Block Printed Name _____ Date _____ FDOT District Design Engineer	Signature Block Printed Name _____ Date _____ FHWA Transportation Engineer

Exhibit 16-B, Sheet 6 of 6

PROJECT IDENTIFICATION		
FINANCIAL PROJECT ID <u>000001-1-32-01</u> FEDERAL AID PROJECT NO. <u>FEDERAL FUNDS</u> COUNTY NAME <u>JACKSON</u>	SECTION NO. <u>99999</u> ROAD DESIGNATION <u>SR 71</u> LIMITS/MILEPOST <u>(MP 1.941 TO MP 5.809)</u>	
PROJECT DESCRIPTION <u>MILLING AND RESURFACING OF SR 71 FROM CR 481 (YONTZ RD.) TO BEAVER CREEK BRIDGE</u>		
<p>PROPOSED ROADWAY TYPICAL SECTION</p> <p style="text-align: center;">DESIGN SPEED = 55 mph STA. 10+53.00 TO STA. 214+76.04 MILE 10 TO CHANCE RD.</p>		
APPROVED BY: (Engineer of Record Printed Name)	FOOT CONCURRENCE	FHWA CONCURRENCE
_____ Engineer of Record Signature and Date	_____ Signature Block Printed Name FOOT District Design Engineer	_____ Signature Block Printed Name FHWA Transportation Engineer
_____ Date	_____ Date	_____ Date

THIS PAGE LEFT BLANK INTENTIONALLY

Chapter 17

Engineering Design Estimate Process

17.1	General	17-1
17.2	Basis of Estimates.....	17-2
17.3	Designer Interface for AASHTOWare Project Preconstruction™ (formerly Trns•port)	17-3
17.4	Estimated Quantities	17-3
17.4.1	Summary of Quantities	17-3
17.4.1.1	Plan Quantity.....	17-3
17.4.1.2	Final Measurement Concept	17-4
17.4.2	Breakdown of Quantities	17-4
17.4.3	Participating and Non-participating Pay Items	17-4
17.4.4	Utility Work by Highway Contractor Agreement Plans	17-5
17.4.5	Pay Item Notes.....	17-5
17.5	Contract Time	17-6
17.6	Alternative Contracting Practices	17-6

THIS PAGE LEFT BLANK INTENTIONALLY

Chapter 17

Engineering Design Estimate Process

17.1 General

The construction cost estimate (Authorization Estimate) is one of the last activities performed during the design phase. Use the following items to develop a construction cost estimate:

1. The contract plans set, including all component sets such as structures, architectural, etc.;
2. The specifications, including the supplemental specifications and technical special provisions;
3. The **Design Standards** eBook referenced on the key sheet of the contract plans;
4. The current **Basis of Estimates Manual**.

Modification for Non-Conventional Projects:

Delete **PPM** 17.1 and replace with the following:

17.1 General

The construction cost estimate (Authorization Estimate) is one of the last activities performed on design projects prior to beginning the procurement process. Use the following items to develop a construction cost estimate:

1. The Concept Plans including a summary of quantities, if available;
2. The Request for Proposal.

17.2 Basis of Estimates

The Specifications establish the method of measurement, basis of payment, and pay items for work specified for road and bridge construction. The ***Basis of Estimates Manual*** contains design aids, notes, the pay item structure, a list of currently open pay items, and computation information to aid the engineer in preparing the cost estimate. The ***Basis of Estimates Manual*** is available on the Program Management Office web page at: <http://www.dot.state.fl.us/programmanagement/> .

Pay items for the various categories of construction work should be identified as those components are completed. For example, pay items for base and pavement work may be identified as the pavement design is completed; signal pay items may be identified as the signal design is completed. The engineer doing the design and specifications should be knowledgeable about what work is to be done and which pay items are needed. The quantity take-off is generally performed at a later date when the plans are final and the tabulations and calculations are completed. The persons doing the quantity take-off should also ensure that all pay items have been identified.

Use the ***Basis of Estimates Manual*** to identify pay items on all types of projects, including resurfacing, widening, safety, bridge, etc. If any work on a project is not covered by existing specifications, then a technical special provision and possibly a new pay item description, unit of measure, and basis of payment may be required. If a desired pay item is not available, contact your Project Manager and/or District Estimates Office for assistance. Additional details for requesting pay items are available in ***Chapter 6*** of the ***Basis of Estimates Manual***.

Modification for Non-Conventional Projects:

Delete ***PPM*** 17.2.

17.3 Designer Interface for AASHTOWare Project Preconstruction™ (formerly Trns•port)

The Designer Interface, available through the Program Management Office webpage via the Webgate login, is used to build categories and to add pay items and quantities to categories. Contact your District Estimates Office for more information.

Modification for Non-Conventional Projects:

Delete *PPM* 17.3 and replace with the following:

17.3 Designer Interface for AASHTOWare Project Preconstruction™ (formerly Trns•port)

The *Basis of Estimates Manual Chapter 11* is used to select the proper design-build pay item.

17.4 Estimated Quantities

17.4.1 Summary of Quantities

All quantities for pay items are tabulated and totaled on Summary of Quantity sheets in the plans. The summary boxes should be organized in pay item sequence for the project. See the *Basis of Estimates Manual* for further details. Place detailed documentation on calculations in the project's Calculations folder and included in the CADD_[FPID].ZIP file with the Final Plans Submittal. See the *FDOT CADD Manual* for details. Summary of Quantity sheets in the plans should be completed in accordance with *Chapter 7 of Volume 2*.

17.4.1.1 Plan Quantity

The Department's current practice is to provide for final payment under the plan quantity concept for a large number of commonly used items. Refer to the *FDOT Specifications* to determine if an item is paid by plan quantity. This concept requires that the estimated quantities be calculated and documented as accurately as possible. Do not include

contingencies in the quantity calculation for plan quantity pay items. The designer is responsible for the final pay quantity for all plan quantity items.

17.4.1.2 Final Measurement Concept

The designer is responsible to estimate a quantity for all final measure items. Because there are many variables associated with these items, the final pay quantity will be determined by measurements performed in the field when the item is being used or constructed.

17.4.2 Breakdown of Quantities

Pay item quantities are loaded into the Designer Interface system by category, to reflect the work shown in each design group. When incidental work from one design group is included in the component plans for another group, the pay items must continue to be loaded in the appropriate category for the work to be completed. When a contract contains more than one Financial Project ID, pay item quantities for each project are loaded separately; the plan summary boxes for each project should clearly distinguish the location for each item of work. Similarly, the plan tabulation sheets must show separate quantities for each project. Only the Summary of Pay Items run from the AASHTOWare Project™ Webgate Reporting menu (formerly Trns•port reports menu) will show the project totals, as well as the combined proposal/contract total. Additional information is available in **Chapter 9** of the ***Basis of Estimates Manual***.

17.4.3 Participating and Non-participating Pay Items

When multiple funding sources are available for a single project (federal, state, and/or local funds), an additional breakdown of pay item quantities may be necessary to identify those pay items or quantities that will “participate” in the available funding. For projects with federal funds, most of the pay items are eligible to “participate” for federal funds. Federal funds are not eligible for use on routine maintenance activities (mowing, litter removal, etc.), but may be used for preventative maintenance (extending the useful life of a highway.) Refer to **Chapter 9** of the ***Basis of Estimates Manual*** for more information on loading pay items with multiple funding sources. Note that with multiple funding sources, the method of presenting this information in the plans must be of sufficient detail for project personnel to readily distinguish between participating and nonparticipating work, including its physical location on the project. Project personnel must be able to properly account for the necessary separation of quantities.

For Lump Sum and/or projects without federal funds, most items will “participate” in the available funding source(s). Unless otherwise directed by the Federal Aid or Work Program Office, all items of work (not including the initial contingency item) will default to participate in the available funding source.

17.4.4 Utility Work by Highway Contractor Agreement Plans

When separate plans for utility construction are to be included in the contract, special attention should be given to establishment of pay items and loading the projects into Designer Interface. Refer to the [Work Program Instructions \(Section 42\)](#) for guidance on the Financial Project ID phase number identification.

For contracts with more than one project, the pay items for Mobilization and Maintenance of Traffic will be shown on each project’s Summary of Pay Items. An exception to this is when the contract contains a Utility Work by Highway Contractor (UWHC) Agreement. The pay items for Mobilization and Maintenance of Traffic will not be shown on the Summary of Pay Items for the UWHC Agreement. The cost of these items will be included in the lead project.

17.4.5 Pay Item Notes

Pay item notes are intended to be used to clarify basis of quantity, work included or method for payment. Pay item notes should be project-specific and kept to a minimum. Do not restate the standard **FDOT Specifications** or **Design Standards** in pay item notes. This will help to place proper emphasis on those notes that are project-specific and avoid discrepancy of documents. Refer to **Chapter 7** of **Volume 2** for details on the usage of pay item notes in the plans.

Modification for Non-Conventional Projects:

Delete **PPM** 17.4.

17.5 Contract Time

Contract duration is the time required for the complete construction of the contract. Pay items measured per day need an accurate estimate of construction duration. Before completion of the design project, the plans package is submitted to the District Construction Office scheduling engineer for establishing the contract duration. Large complex projects should have the desired contract duration established earlier in the design process.

Modification for Non-Conventional Projects:

Delete **PPM** 17.5.

17.6 Alternative Contracting Practices

The Construction Office web page defines various contracting techniques used by the Department (<http://www.dot.state.fl.us/construction/AltContract/AltContract.shtm>). When alternative contracting is called for by the Department, coordinate the PS&E preparation with the FDOT Project Manager.

Modification for Non-Conventional Projects:

Delete the previous paragraph and replace with the following:

The Construction Office web page defines various contracting techniques used by the Department (<http://www.dot.state.fl.us/construction/AltContract/AltContract.shtm>). When design-build contracting method is called for by the Department, coordinate the estimate preparation with the FDOT Project Manager.

Chapter 18

Quality Assurance and Quality Control

18.1	General	18-1
18.2	Quality Assurance	18-2
18.2.1	Authority	18-2
18.2.2	Accountability	18-2
18.2.3	Critical Areas to be Monitored	18-3
18.2.4	Documentation	18-4
18.2.5	Training	18-4
18.3	Quality Control	18-5
18.3.1	Authority	18-5
18.3.2	Accountability	18-6
18.3.3	Critical Areas to be Monitored	18-6
18.3.4	Documentation	18-6
18.3.5	Training	18-6

THIS PAGE LEFT BLANK INTENTIONALLY

Chapter 18

Quality Assurance and Quality Control

18.1 General

Quality Assurance and **Quality Control** are two processes used to ensure the public receives a quality product. Quality Assurance is the responsibility of, and performed by the Central Office. Quality Control is a responsibility of the District Offices, and is performed by the Districts and their Agents (Consultants), as appropriate.

Modification for Non-Conventional Projects:

Delete *PPM* 18.1 and insert the following:

18.1 General

See the RFP for Quality Management Plan (QMP) requirements which describes the Quality Control (QC) procedures to be utilized to verify, independently check, and review all design drawings, specifications, and other contract documents. The QMP must establish a Quality Assurance (QA) program to confirm that the Quality Control procedures are followed. In addition to the QMP all Category 2 Bridge Designs must be verified by an Independent Peer Review. See RFP for requirements.

The Department reserves the right to conduct an audit of the Design Build Firm's QMP process to ensure the submitted plan for the project is being properly executed. Similarly, the Department reserves the right to conduct an audit of the Independent Peer Review to ensure that independent verification of the design and plans is being properly executed. All documentation for QA/QC and independent peer review, including check prints, design calculations, etc., must be kept on file until construction of the project is complete at a minimum.

18.2 Quality Assurance

Quality Assurance is the planned, coordinated and continued activities performed to measure processes against predetermined critical requirements. The objective of Quality Assurance is the continual improvement of the total delivery process to enhance quality, productivity and user satisfaction.

18.2.1 Authority

Section 20.23(4)(a) Florida Statutes (F.S.) requires a **Quality Assurance Process**. It requires the Central Office to establish departmental policies, rules, procedures and standards and to monitor the implementation in order to ensure uniform compliance and quality performance by the District and Central Office units that implement transportation programs. Also, **Section 334.048, F.S.** states the Legislative intent with respect to the Central Office role in the Department's management accountability and monitoring systems, including corrective actions when appropriate.

18.2.2 Accountability

The State Roadway Design monitoring plan identifies the process, critical areas, criteria used to measure compliance, report format, method of monitoring and tracking, and procedure for follow-up of unresolved issues. The results of the Quality Assurance monitoring activities are reported to management in exit interviews and reports. The reports identify areas needing improvement, provide feedback on the effectiveness and appropriateness of established policies, procedures and standards, and recognize areas of outstanding quality. The reports are also used to share improvement ideas between districts, and to maintain consistency in process and practice.

The Central Office must furnish all the planned and systematic actions necessary to provide adequate direction to the Districts so that all design products will be the result of predetermined requirements. This involves the establishment of design policies, procedures, standards and guidelines, training, and the monitoring and review of District compliance with these items.

The Central Office must review each design process and its associated components for assurance that the Districts have adequate control measures in place and are complying with policy, procedures, standards, guidelines and processes. It will also be used for identifying any areas of excellence, noncompliance and need.

18.2.3 Critical Areas to be Monitored

Critical areas to be monitored by the Central Office are based on well-established roadway design policy and practice. These policies, guidelines and accepted practices formulate the criteria used to measure compliance in the areas critical to quality. The minimum frequency of review for a critical area is three years. However, latitude is allowed for the depth and frequency of reviews, based on the individual District's observed performance, review findings or the needs of District management.

The State Roadway Design monitoring plan for Quality Assurance lists the following critical areas to be monitored.

1. Initial Engineering Design Process (See **Chapter 13**, this volume)
 - a. Quality Control Activities,
 - b. Scope Activities,
 - c. Standards Activities,
 - d. Design Support Activities,
 - e. Project Activities.
2. Final Engineering Design Process (See **Chapter 14**, this volume)
 - a. Quality Control Activities,
 - b. Review Initial Engineering Design Activities,
 - c. Engineering Activities,
 - d. Support Activities.
3. Update Engineering Design Process (See **Chapter 15**, this volume)
 - a. Quality Control Activities,
 - b. Scope Activities,
 - c. Standards Activities,
 - d. Engineering Activities,
 - e. Support Activities.

18.2.4 Documentation

The Quality Assurance findings and recommendations will be documented in a report that will be distributed to the District Secretaries and other affected offices. A brief summary of the data will also be entered in the Quality Assurance Reporting (QAR) database. Summaries of significant issues will be prepared quarterly for upper management.

18.2.5 Training

Training and assistance are also a mandated role of the Central Office units and the Quality Assurance program.

1. Development: The Central Office Roadway Design will formulate a training plan based upon District requests or needs as determined by the Quality Assurance reviews.
2. Delivery: The Central Office will manage or conduct training courses for District and Consultant personnel as requested, with schedules and locations sensitive to budgets and production schedules.

18.3 Quality Control

Quality Control is the process performed to ensure conformance with valid requirements. This process includes quality planning, training, providing clear decisions and directions, constant supervision, immediate review of completed activities for accuracy and completeness, and documenting all decisions, assumptions and recommendations.

Each District must have a **District Quality Control Plan for Roadway Design** and the other production units, which addresses broad overall quality initiative. The **District Quality Control Plan** must identify the organization, responsibility, and accountability used to perform and document overall quality control, including the requirement for a Project Quality Control Plan on all projects. All **Project Quality Control Plans** must address any project specific scope of service needs and be approved by the Project Manager or District Design Engineer as appropriate.

In-house and consultant designers and reviewers must recognize quality is the result of several processes. It requires many individuals performing many appropriate activities at the right time during the plans development process. Quality control does not solely consist of a review after a product is completed. Quality requires performing all activities in conformance with valid requirements, no matter how large or small their overall contribution to the design process. Good CADD techniques, attention to details and ensuring the plans are correct and useful to the contractor are also essential to quality.

18.3.1 Authority

Section 334.048, F.S. requires a **Quality Control Process**. It requires that each District must be accountable for ensuring their District's quality of performance and compliance with all laws, rules, policies, and procedures related to the operation of the department.

18.3.2 Accountability

1. The **District** must follow established design policies, procedures, standards and guidelines in the review and preparation of all design products; and review Consultant prepared individual engineering and design for compliance and good engineering practice.
2. The **Consultant** is an agent for the District with the primary responsibility for preparation of contract plans. Consultants must ensure quality and adherence to established design policies, procedures, standards and guidelines in the review and preparation of all design products for compliance and good engineering practice as directed by the District Project Quality Control Plan.

18.3.3 Critical Areas to be Monitored

The District must monitor the Quality Control efforts used by in-house staff and its consultant services units. The District must assure project scopes include an adequate **Project Quality Control Plan**.

18.3.4 Documentation

The Districts must maintain a file containing the current District Quality Control Plan and furnish Central Office Design with a copy to be used as part of the critical areas to be reviewed. Every project file will contain a Project Quality Control Plan at the beginning of the Initial Engineering Design Process.

18.3.5 Training

The District must identify and coordinate training needs of in-house and Consultant services through the appropriate Central Office units.

Chapter 19

Signing and Sealing Documents

19.1	General	19-1
19.2	Signing and Sealing Contract Plans	19-2
19.2.1	Manual Signing and Sealing	19-2
19.2.2	Digital Signing and Sealing.....	19-3
19.2.2.1	Single Digital Signature	19-4
19.2.2.2	Multiple Digital Signatures	19-4
19.3	Signing and Sealing Other Documents.....	19-5
19.4	Signing and Sealing Revisions	19-6
19.4.1	Contract Plans Set	19-6
19.4.2	Specifications	19-6
19.4.3	Other Design Documents	19-6
19.5	Support Documents	19-7

Figures

Figure 19.1	Signature Block	19-4
Figure 19-2	18 KIP Equivalent Single Axle Loads (ESAL)	19-7
Figure 19-3	Project Traffic	19-8

THIS PAGE LEFT BLANK INTENTIONALLY

Chapter 19

Signing and Sealing Documents

19.1 General

The act of signing, dating and sealing transmitted plans, specifications, reports or other documents is collectively referred to as Signing and Sealing.

This chapter provides the Department's requirements for Signing and Sealing plans and documents in conformance with **Florida Statutes** and **Florida Administrative Code (F.A.C.)**. The Laws and Rules referenced in this chapter are primarily those governing Professional Engineers. Other licensed professionals that are required to Sign and Seal plans or documents are to follow the Laws and Rules applicable to their profession.

[Section 334.175, Florida Statutes](#), *Certification of project design plans and surveys:*

“All design plans and surveys prepared by or for the department shall be signed, sealed, and certified by the professional engineer or surveyor or architect or landscape architect in responsible charge of the project work. Such professional engineer, surveyor, architect, or landscape architect must be duly registered in this state.”

It is the licensee's responsibility to comply with the Signing and Sealing requirements applicable to their profession's Laws and Rules. It is the District's responsibility to verify that documents are Signed and Sealed, and transmitted in accordance with this chapter.

19.2 Signing and Sealing Contract Plans

The transmitted contract plans Signed and Sealed by the responsible professional(s) become the Record Set. Every sheet of the Record Set must be signed and sealed, except for the following sheets that may be appended to the contract plans set:

- Existing Bridge Plans,
- ***Developmental Design Standards***, and
- Plans that are prepared by an employee of a Utility or other employees exempted under [**Section 471.003, Florida Statutes**](#), except as follows.
 - Utility plans that modify or detail attachments to a bridge or other structure belonging to the Department must Sign and Seal the sheets affecting such bridge or structure.
 - Plans prepared by nonexempt parties for a Utility must be Signed and Sealed.

Every sheet of the Record Set must include a title block that contains information for the professional engineer that will Sign and Seal the sheet, showing:

1. The name, address, and license number of the engineer, or
2. If practicing through a duly authorized engineering business, the name and license number of the engineer, and the name, address and certificate of authorization number of the engineering business, or
3. If employed by a local, State or Federal agency, the name and license number of the engineer, and the name and address of the agency.

A non-engineering licensed professional that will Sign and Seal the sheet must show similar information in the title block related to their profession.

19.2.1 Manual Signing and Sealing

Digital Delivery is the standard practice for Signing and Sealing, and transmittal of contract documents. Manual Signing and Sealing must be coordinated with the District Plans, Specifications, and Estimates (PS&E) Office. The requirements for manually Signing and Sealing are covered in the Laws and Rules for each licensee's profession.

19.2.2 Digital Signing and Sealing

Digital Delivery is the standard method of electronically transmitting contract documents to the Department. This includes the creation of Portable Document Format (PDF) files of contract plans and specifications, which are Signed and Sealed with a Digital Signature. The [CADD Manual](#) defines the type of digital certificate to be used for Digital Signature.

Place the following note along the right edge of plan sheets that are digitally Signed and Sealed:

“THE OFFICIAL RECORD OF THIS SHEET IS THE ELECTRONIC FILE
DIGITALLY SIGNED AND SEALED UNDER RULE 61G15-23.004, F.A.C.”

The rule number referenced in the note above applies to the engineering professional that is Signing and Sealing the sheet. A non-engineering licensed professional should use the rule number that applies to their profession:

- Surveyors, Rule 5J-17.062, F.A.C.
- Geologists, Rule 61G16-2.005, F.A.C.
- Landscape Architects, Rule 61G10-11.011, F.A.C.
- Architects, Rule 61G1-16.005, F.A.C.

Electronically transmit the Contract Plans as individual Signed and Sealed PDFs of component plans. The list of component plans for Digital Delivery is comprised of the following:

- Roadway Plans
- Signing and Pavement Marking Plans
- Signalization Plans
- Intelligent Transportation System (ITS) Plans
- Lighting Plans
- Landscape Plans
- Architectural Plans
- Structures Plans
- Toll Facilities Plans

Component plans may require insertion of sheets that were prepared early in, or prior to the design process. The following early plan sheets may be contained in a separate Signed and Sealed PDF that is to be included as part of the Contract Plans:

- CTL-# Project Control Sheets
- GR-# Soil Survey and Report of Core Borings
- TR-# Tree Survey Sheets
- UTV-# Verified Utility Locate Sheets

No other plans sheets than those listed above are to be submitted separate from the component plans.

See **Chapter 3** of Volume 2 for instruction on how to show early plan sheets on the Key Sheet.

19.2.2.1 Single Digital Signature

Component plans that will be Signed and Sealed by a single professional (signatory) may place a signature block, as shown in **Figure 19.1**, on the component Key Sheet in lieu of using a Signature Sheet. Listing the sheets contained in the PDF to be Signed and Sealed is not required.

Figure 19.1 Signature Block

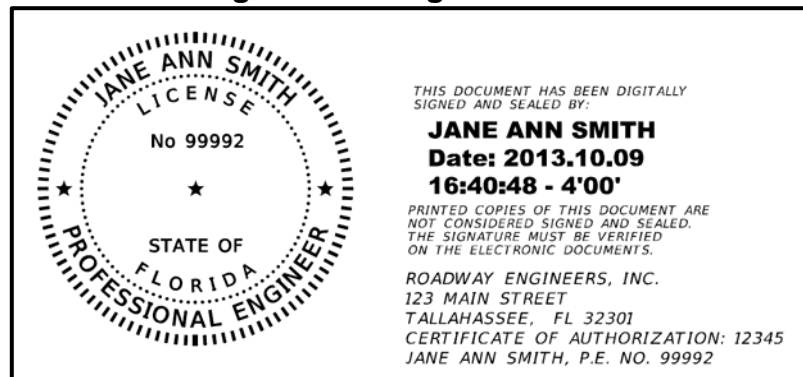

19.2.2.2 Multiple Digital Signatures

A Signature Sheet is required for component plans that will be Signed and Sealed by more than one professional. See **Chapter 3** of Volume 2 for Signature Sheet requirements.

19.3 Signing and Sealing Other Documents

Other documents to be Signed and Sealed include reports, calculations, specifications and criteria packages, used in the development of design plans. Specifications will be Signed and Sealed in accordance with the [Specifications Handbook](#).

For other design documents:

- Bound design documents must include a cover page that is Signed and Sealed. If a document is to be Signed and Sealed by more than one professional, provide an index on the cover page to convey a list of pages that each licensee is responsible for.
- Un-bound design documents require each sheet to be Signed and Sealed.

The following Signed and Sealed documents are to be placed in the district's Project File(s).

1. Specifications Package
2. Pavement Design Package
3. Typical Section Package
4. Drainage Computations
5. Hydraulics Reports
6. Bridge Development Report
7. Traffic Engineering Reports
8. Environmental Reports
9. Geotechnical Reports
10. Value Engineering Record
11. Other Engineering Reports and Recommendations
12. Permit Documentation
13. Design Exceptions and Design Variations

Modification for Non-Conventional Projects:

Delete the items No. 6 and 10 above.

19.4 Signing and Sealing Revisions

Design revisions are modifications to the PS&E Submittal after it has been accepted by Central Office Final Plans. Revisions made after the award of the contract are referred to as post-let revisions. All revisions should be prepared by the same professional that Signed and Sealed the plan sheet contained in the Record Set or the original document.

19.4.1 Contract Plans Set

Prepare design revisions as outlined in **Chapter 20** of this Volume. Sign and Seal the revision package PDF in accordance with **Section 19.2**.

Prepare post-let revisions as outlined in **Chapter 20** of this Volume and **Chapter 5** of the [Construction Project Administration Manual \(CPAM\)](#). Sign and Seal the revision package PDF in accordance with **Section 19.2**.

19.4.2 Specifications

Prepare a Supplemental Specifications Package when it becomes necessary to revise either the Specifications Package or a previous Supplemental Specifications Package. Specifications will be revised in accordance with the [Specifications Handbook](#).

19.4.3 Other Design Documents

Sign and Seal each revised sheet and place immediately behind the cover sheet of the original Signed and Sealed document.

Modification for Non-Conventional Projects:

Delete **PPM** 19.4.

19.5 Support Documents

Engineering decisions are often made on the basis of support documents furnished by non-engineering staff or offices. Two support documents that require certification that they were prepared in accordance with Department procedures are shown in **Figure 19-2** and **Figure 19-3**.

Figure 19-2 18 KIP Equivalent Single Axle Loads (ESAL)

Financial Project ID _____
State Road No. _____
County _____
<p>I have reviewed the 18 KIP Equivalent Single Axle Loads to be used for pavement design on this project. I hereby attest that these have been developed in accordance with the FDOT Project Traffic Forecasting Procedure using historical traffic data and other available information.</p>

Name

Signature

Title

Organizational Unit

Date

Figure 19-3 Project Traffic

Financial Project ID _____
State Road No. _____
County _____
<p>I have reviewed the Project Traffic to be used for design on this project. I hereby attest that it has been developed in accordance with the FDOT <i>Project Traffic Forecasting Procedure</i> using historical traffic data and other available information.</p>

Name

Signature

Title

Organizational Unit

Date

Modification for Non-Conventional Projects:
Delete <i>PPM 19.5</i> and see RFP for requirements.

Chapter 20

Plans Processing and Revisions

20.1	Plans Processing and Revisions Prior to Award.....	20-1
20.1.1	General	20-1
20.1.2	Glossary.....	20-1
20.1.3	Plans Processing	20-4
	20.1.3.1 District Activities	20-4
	20.1.3.2 Submittal to Tallahassee	20-4
	20.1.3.3 Submittal for Letting	20-5
20.1.4	Revisions to the PS&E Submittal.....	20-7
20.1.5	Re-submittal of Withdrawn Projects.....	20-10
20.2	Plans Processing and Revisions after Award	20-26
20.2.1	General	20-26
20.2.2	Revisions after Award	20-26
20.2.3	Final “As-Built” Plans Process	20-29
20.3	Retention of Electronic Documents	20-30

Figures

Figure 20.1.1	Plans Processing For Tallahassee Letting.....	20-6
Figure 20.1.2	District Revisions.....	20-9
Figure 20.3.1	Storage of Electronic Documents	20-31

Exhibits

Exhibit 20-A	Transmittal of Plans, Specifications, and Estimates Package.....	20-11
Exhibit 20-B	Contract File Index	20-12
Exhibit 20-C	Revision Memo	20-15
Exhibit 20-D	Preliminary Engineering Certification.....	20-21
Exhibit 20-E	Sample Local Agency Maintenance Agreement for Work Performed by the Department.....	20-23
Exhibit 20-F	Direction to all Discipline Phase Reviewers on Non-Conventional Project.....	20-32

Chapter 20

Plans Processing and Revisions

20.1 Plans Processing and Revisions Prior to Award

20.1.1 General

This section describes the critical activities required to process the contract plans, specifications and estimate for letting. It identifies the transmittal forms, certifications and other documents prepared by the District and the various offices involved in processing a Plans, Specifications & Estimates (PS&E) submittal package. This chapter also outlines the revision process, and the steps to resubmit a project that has been withdrawn from letting.

Projects must be electronically delivered in Digital Delivery format in accordance with **Chapter 19** and the [CADD Manual](#). The latest information regarding the letting of electronic plans and specifications (including critical dates) will be posted on the [Final Plans Web Page](#) as new information becomes available.

Other specific requirements for processing the electronic delivery can be found in Chapter 5 of the [CADD Manual](#).

20.1.2 Glossary

As Built Plans - The Contract Plans after construction is completed, all revisions including those occurring during construction, have been included and with the title on the key sheet changed to Final Plans.

Bid Set - The digital Contract Plans and Specifications Package, submitted to Contracts Administration for the letting of a project. The files composing the Bid Set are described in the [CADD Manual](#).

Modification for Non-Conventional Projects:

Delete **Bid Set** term from Glossary.

Contract Documents - The term "Contract Documents" includes all of the following which are to be treated as one instrument whether or not set forth at length in the form of contract:

- Advertisement for Proposal, Proposal, Certification as to Publication and Notice of Advertisement for Proposal,
- Appointment of Agent by Non-resident Contractors,
- Non-collusion Affidavit,
- Warranty Concerning Solicitation of the Contract by Others,
- Resolution of Award of Contract,
- Executed Form of Contract,
- Performance Bond and Payment Bond,
- Standard Specifications and Plans (including revisions thereto issued during construction),
- Addenda, or other information mailed or otherwise transmitted to the prospective bidders prior to the receipt of bids, work orders, and supplemental agreements.

Note: As used in **Sections 2** and **3** of the Specifications only, Contract Documents do not include work orders, and supplementary agreements. As used in **Section 2** of the Specifications only, Contract Documents also do not include Resolution of Award of Contract, Executed Form of Contract, and Contract Bond.

Modification for Non-Conventional Projects:

Delete **Contract Documents** term from Glossary and replace with the following:

Contract Documents - The term "Contract Documents" includes: Advertisement, Request for Proposal (RFP), the Design and Construction Criteria Package, the Technical and Price Proposal, Certification as to Publication and Notice of Advertisement for Proposal, Appointment of Agent by Nonresident Contractors, Non-collusion Affidavit, Warranty Concerning Solicitation of the Contract by Others, Resolution of Award of Contract, Executed Form of Contract, Contract Bond, Design Liability Insurance, Specifications, plans (including revisions thereto issued during construction), Addenda, written statements or transcripts or minutes of oral representation by Design-Build Firm made at oral presentations, or other information mailed or otherwise transmitted to the prospective bidders prior to the receipt of bids, work orders and supplemental agreements, all of which are to be treated as one instrument whether or not set forth at length in the form of contract.

Contract Plans - The signed and sealed documents prepared during the design phase and used by construction personnel to build a project.

Local Agency Funding Agreement – An agreement used when Local Agencies provide funds to the Department for a specific project, often that are not on the State Highway System. This funding needs to be documented with an Agreement that should include provisions for additional funding for contingency. These Agreements must be coordinated through the Comptroller's office and is covered by procedure **LOCALLY FUNDED AGREEMENTS (NON-PTO) – FINANCIAL PROVISIONS AND PROCESSING (Topic Number: 350-020-300-n)**.

Maintenance Agreement – An agreement with a Local Agency for the maintenance responsibilities of a federally funded project. This agreement is required for construction projects let by FDOT for work not on the State Highway System and must be obtained prior to the authorization for construction of the project

Plans, Specifications & Estimates (PS&E) Submittal - The Project documents and files prepared in accordance with the **CADD Manual** to include all Bid Set instruction.

Record Set - The transmitted contract plans set, Signed and Sealed by the responsible professional(s).

Revisions - Revisions are modifications to the PS&E Submittal after it has been accepted by Central Office Final Plans section. After authorization to advertise, the Contracts Office processes the revisions as addenda.

Modification for Non-Conventional Projects:

Delete the *Revisions* term from Glossary and replace with the following.

Revisions – Revisions are modifications to the plan sheets and specification package after initial “Released for Construction” stamping.

Specifications Package - The signed and sealed document prepared for inclusion in the Contract documents and which is comprised of Special Provisions, Developmental Specifications, Supplemental Specifications and Appendices.

Strung Project (A.K.A. “Goes With”) - Two or more projects let in the same contract. Any Federal Aid project must be designated the Lead Project. See the [CADD Manual](#) for Bid Set preparation instruction.

20.1.3 Plans Processing

20.1.3.1 District Activities

There are certain plans processing activities that occur at the District level prior to submitting plans to Tallahassee. These activities have schedule implications which will vary by District. Contact the appropriate District for specific requirements.

Modifications to the plans, specifications or quantities after District Estimates Office changes the Project Preconstruction (PrP) Workflow/Phase and before the Plans are sent to Tallahassee are referred to as Plan Changes. Plan Changes include revision, deletion, or addition of data on individual sheets, or adding and deleting entire sheets. Plan Changes are not revisions and are not noted in the Revision Block on the sheets.

20.1.3.2 Submittal to Tallahassee

Prepare and post the PS&E Submittal and the Authorization Estimate to the Central Office server no later than the PS&E submittal due date. Transfer control of the AASHTOWare

Project Preconstruction™ (formerly TRNS•PORT) project files to the Final Plans section of the State Program Management Office when posting the PS&E submittal.

Email the Transmittal of Plans, Specifications and Estimates Package Memo (**Exhibit 20-A**) and the Contract File Index (**Exhibit 20-B**) with attachments, to CO-CPKG with a copy to the FDOT Project Manager.

20.1.3.3 Submittal for Letting

Upon receipt of the PS&E Submittal, the Final Plans section checks the package for completeness and records the date posted. If incomplete, the District Program Management Office is notified to provide a corrected submittal. Once accepted, the PS&E Submittal is posted to the server, for access by Contracts Administration.

Figure 20.1.1 Plans Processing For Tallahassee Letting

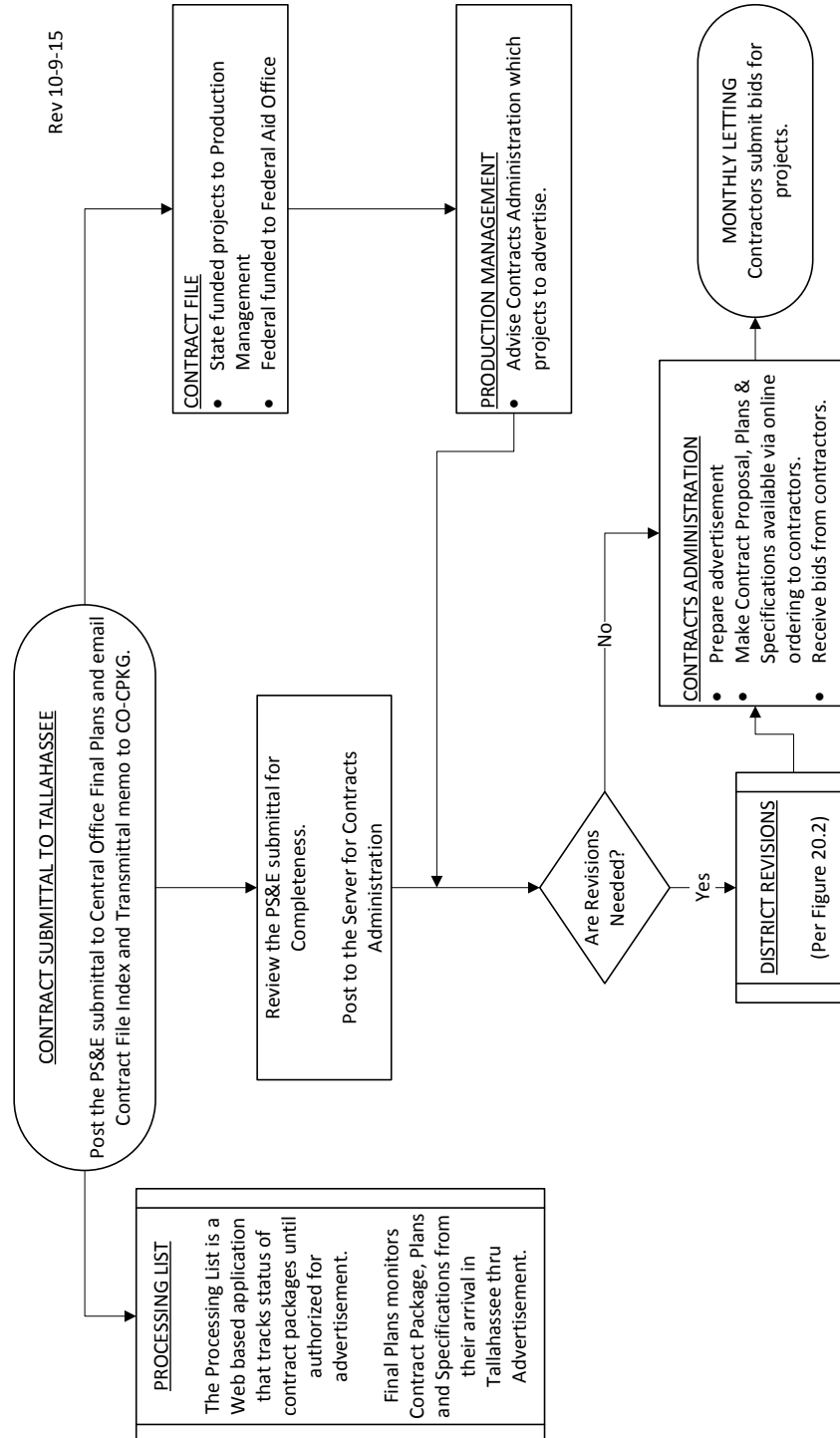

20.1.4 Revisions to the PS&E Submittal

Revisions are modifications to the PS&E Submittal after it has been accepted by Central Office Final Plans. The FDOT Project Manager ensures a revision is completed as follows (see **Figure 20.1.2**):

1. All revisions require a completed Revision Memo (**Exhibit 20-C**). When access to AASHTOWare Project Preconstruction™ (formerly TRNS•PORT) is required, obtain concurrence from the District Director of Transportation Development (or designee) and forward to Central Office Final Plans (CO-FINALPLANS). Concurrence may be in the form of an email that includes a summary of the revision or a signed Revision Memo. Access will then be returned to the District for a period not to exceed 2 business days.
2. If the project requires Federal Aid Oversight, obtain an email concurrence from FHWA prior to making revisions or requesting District access to the AASHTOWare Project Preconstruction™ (formerly TRNS•PORT). Include the name of the FHWA contact and the concurrence date on the Revision Memo. Major changes to plans or specifications on Federal Oversight Projects made during the advertising period will require the FHWA Division Administrator's approval prior to issuing addenda. Major changes increase the project cost (>\$50,000), alter project termini, change the character of the project or modify scope of the work.
3. If information on the Transmittal Memo changes due to Project updates, submit a revised Transmittal Memo whether it is a formal Revision or not.
4. For revisions to plan sheets use a conspicuous unique numbered symbol (e.g., a numbered triangle) beside the revision that corresponds to the Plans Revision Number on the Revision Memo. Begin the revision numbering with "1" and number subsequent revisions to the contract plans set, sequentially. Place the revision date, corresponding numbered symbol for the revision, and a brief description of the revision in the Revision Block on each modified sheet. The same applies to adding sheets: however, the added sheets may be numbered with alpha characters (e.g., 22a, 22b, 22c). If a sheet is being deleted, the sheet numbers for the following sheets remain unchanged. For revisions involving revised, added or deleted pay items, see **Exhibit 20-C**. See **Chapter 3, Volume 2** for instructions on recording a revision on the Key Sheet.
5. The responsible professional Signs and Seals each revised document in accordance with the requirements of **Chapter 19** of this Volume.
6. Prepare the Revision Memo (**Exhibit 20-C**), providing a Revision Number and describing modifications. Record the revision date for each revised sheet, using the date shown in the revision block on the sheet.

7. District Specifications reviews the revision for any effect on the specifications then dates and signs the Revision Memo.
8. Ensure that revisions to the PS&E Submittal are posted to the Central Office server. Email a PDF of the signed Revision Memo to Final Plans, CO-FINALPLANS.
9. The District Secretary's signature is required on the Revision Memo if the revision is submitted within 15 working days of the letting.
10. Approval from the Director of the Office of Design is required if the revision is submitted within five working days of the letting. If approval is not granted, the project will either be let as is, or be withdrawn from letting. Withdrawing or moving the project to a later letting after advertisement requires approval by the District Secretary and the Chief Engineer.
11. Upon email receipt of the signed Revision Memo, Final Plans will check the revisions for completeness.
12. Mandatory Specification Revisions issued from Central Office will be processed by Supplemental Specifications Package. Signatures are not required on the Revision Memo for Mandatory Specification Revisions unless other revisions are included with the package.

Figure 20.1.2 District Revisions

Rev. Nov. 2015

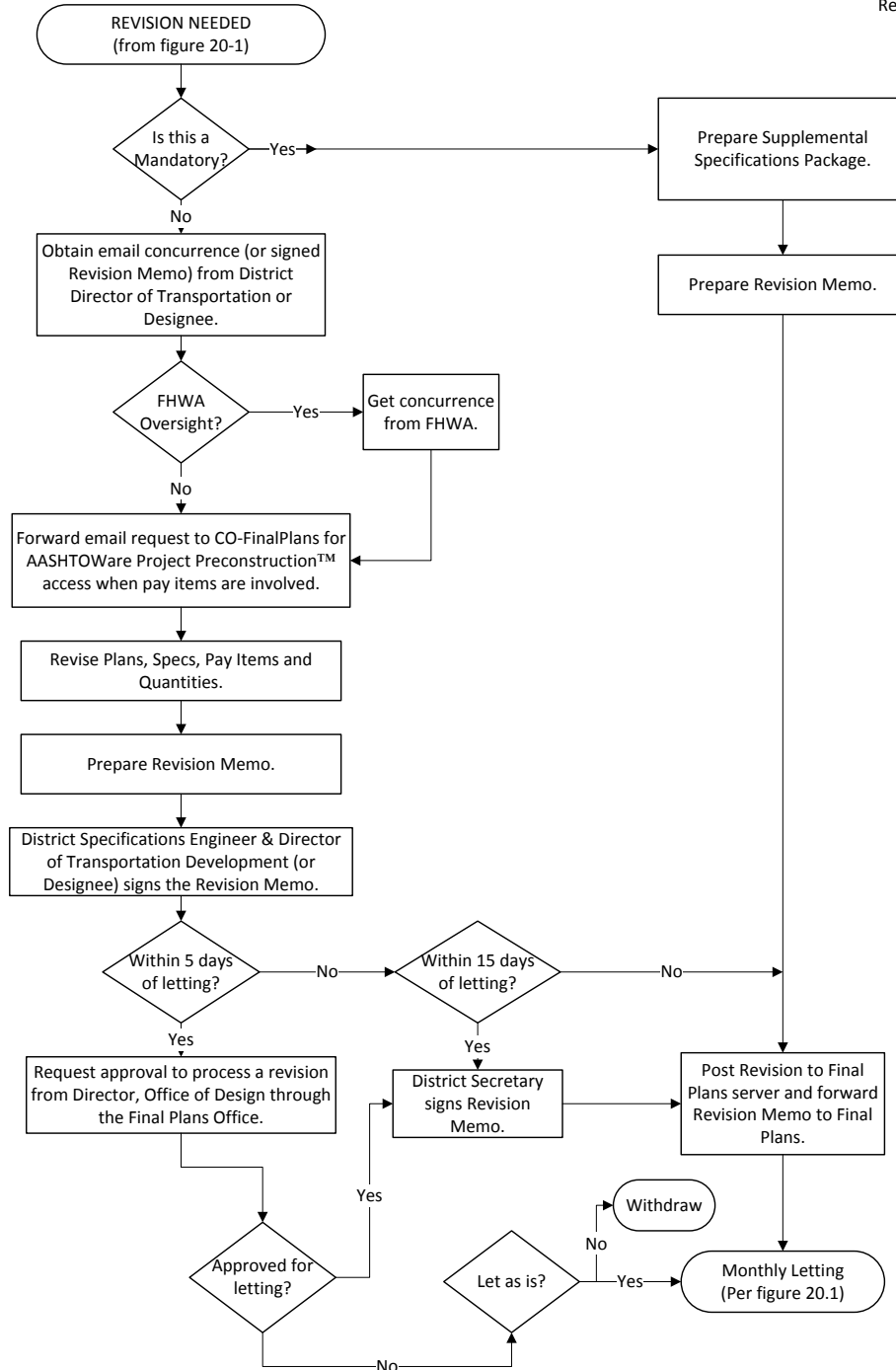

20.1.5 Re-submittal of Withdrawn Projects

When a District withdraws the entire PS&E Submittal for major revisions before the letting, the project will be resubmitted as a new transmittal of the PS&E Submittal with all required components. Include the note "Plans Completely Revised" on the Transmittal Memo next to the Transmittal date. Include note under the "Revisions" Header of the lead Key Sheet, "Plans completely revised (date)". Show new Proposal/Contract ID number on Key Sheet(s).

Project documents in Central Office from the previous submittal will be destroyed or deleted.

A project withdrawn for a period of nine months or longer will be updated according to the process outlined in **Chapter 15**.

Plans rejected from letting by the Awards Committee or withdrawn for minor revisions may not need to follow the above process. District coordination with Central Office Production Management is required to reschedule a letting.

**Exhibit 20-A Transmittal of Plans, Specifications, and Estimates Package
Sheet 1 of 2**

Date: _____ 30 Day AD 60 Day AD
Proposal/Contract ID: _____ Letting Date: _____ Re-Let: No Yes
Financial Project ID(s): _____
County: _____ State Road No.: _____
Federal Funds: No Yes Federal Aid No.: _____
Total Roadway Length: _____ Total Bridge Length: _____
Total Project Length: _____ Total Project Length Verified by: _____
Project Manager Name and Phone Number: _____
E.O.R. Name, Firm and Phone Number: _____
Work Mix No. ____ Work Mix Description: _____

On _____, the District Director of Transportation Development (Production) certified that the Plans, Specifications and Estimates (PS&E) Package is complete, has no known errors or omissions, has been reviewed for constructability and biddability, and is ready to be advertised for construction.

The following items transmitted as noted:

SEALED PLANS SET (_ SHEETS), SPECIFICATIONS PACKAGE (_____ PAGES): The Electronic Bid Set was reviewed by _____ and posted to the server on _____).

ESTIMATES OFFICE INFORMATION:

The Authorization Estimate, will be reviewed by District Estimates and posted to the server by the PS&E submittal due date. At the time of posting, transfer control of the project files to Central Office.

FEDERAL AID OFFICE INFORMATION:

Federal Aid Oversight: No Yes
FHWA: Approved by _____ Date: _____
Print Name of FHWA Engineer

CONTRACTS OFFICE INFORMATION:

Contract Time: _____ Calendar Days
Select One:
 Standard Acquisition Time: 15 Days
 Other Acquisition Time: _____ Days (Approval required if more than 120 Days)
 Flexible Start Time: _____ Days (Approval required if more than 120 Days)
 Special Start Date: _____ (Approval required for SP0080303B and SP0080303C)
Business Development Initiative Project: No Yes
Alternative Contracting: No Yes
(If yes, Type: _____)
Pre-Bid Conference Mandatory? No Yes (Date: _____ Time: _____ A.M./P.M.)
(Contact Person and Phone: _____)
(Location of Conference: _____)

SPECIAL NOTES and REQUIREMENTS (List/Explain): _____

If any items are missing please contact _____
Contact Name and Phone Number

**Exhibit 20-A Transmittal of Plans, Specifications and Estimates Package
Sheet 2 of 2**

REMINDER

1. Check that all components of the Contract Plans are included as listed on the lead key sheet.
2. Check that all sheets are included according to key sheet indices.
3. Check that all sheets have the correct Financial Project ID.
4. Check that all sheets are legible and reproducible.
5. On strung projects, check that all Summary of Pay Item sheets from the Proposal/Contract ID go in the lead project and the Financial Project ID of the strung project is shown on the lead key sheet.
6. Check that bridge pay item sheets show bridge numbers and the quantity breakdowns.
7. E-mail the Transmittal Memo, Contract File Index and attachments to the group "CO-CPKG" and copy the FDOT Project Manager.
8. Verify the accuracy, in the FM system, of the Description, Project Limits, Mileage and Structures. Initial Total Project Length Verification.

Special Notes and Requirements:

- A. Provide the Roadway, Bridge, and Project Lengths in miles, rounded to three decimal places as follows:
 - a. Total Roadway Length = End Project - Begin Project - Exceptions - Bridges (not including bridge culverts) adjusted for Equations
 - b. Total Bridge Length = Sum of all End Bridge – Begin Bridge (not including bridge culverts)
 - c. Total Project Length = Roadway + Bridges
- B. Include the Work Mix Number and Work Mix Description corresponding to the information as shown in the Financial Management System on the WP01 Screen
- C. Anything that affects the advertisement, bidding and award that is not listed above such as:
 - a. Railroad Insurance
 - b. Developmental Specifications
 - c. Alternative Contracting items such as Scope Alternates
 - d. Budgetary Ceilings
 - e. Additional Insured Endorsement parties
 - f. For A+B projects, include the User Cost Per Day \$_____ and Maximum Days _____.

**Exhibit 20-B Contract File Index
Sheet 1 of 2**

CONTRACT FILE INDEX

Financial Project ID _____ Proposal/Contract ID _____

ATTACHMENTS (check if included or list expected date of transmittal to Central Office)

- _____ Calendar Days Recommendation
- _____ Preliminary Engineering Certification*
- _____ Utility Certification
- _____ Status of Environmental Certification (**Form 650-050-13** (Federally-Funded Project) or **650-050-14** (State-Funded Project))
- _____ Permit Transmittal Memo **
- _____ Railroad Clear Letter
- _____ FDOT/FGT Encroachment Agreement
- _____ Certificate for Construction (**Form 575-095-05**)
- _____ Executed copy of MMOA for Projects with Patterned Pavement
- _____ Approval if SP0080701B Computation of Contract Time is used.
- _____ Landscape Exception Approval per Engineering and Operations Bulletin 13-1

-
- No Yes Project exempt from FHWA oversight under agreement dated August 20, 2015*
 - No Yes Right of Way Certification was mailed to State R/W Administrator
 - No Yes N/A Local Funds Agreement sent to Office of Comptroller
 - No Yes N/A Local Funds Sent to Office of Comptroller
 - No Yes N/A Project is Federally Funded off the State Highway System, requiring a Maintenance Agreement.
If yes, a Maintenance Agreement (Number _____) was executed on _____ . A copy is available upon request.

* Include if federally funded.

** Must have District Secretary Approval if Permits are not received by Authorization (*Federally Funded Projects Only*).

Note: If project is federally funded and has a state funded "Goes With", please provide the same documentation as required for a federally funded project.

Name: _____
Print Name of Project Manager/Other Title

Date: _____

Exhibit 20-B Contract File Index, Sheet 2 of 2

REMINDER

PROCESS:

1. Organize attachments in the order listed.
2. Show the number of Maintenance Agreements (Federal funds – off the State Highway System).
3. Show anticipated date of arrival on any item not included in package.
4. The ***Status of Environmental Certification*** must be completed on all federally and state funded projects. For federally funded projects, use the Status of Environmental Certification for Federal Project, Form #650-050-13. For state funded only, non-federal eligible (NFE) projects, use the Status of Environmental Certification for State Funded Project, Form #650-050-14. On federally funded projects that are strung with NFE projects the entire project contract becomes federalized. This means that both the state funded project and the federally funded project must comply with all applicable federal laws, rules and regulations related to the federalized contract. In addition, the federally funded project is to be the lead project.

Regarding federal environmental compliance under NEPA, the project limits of the approved final environmental document will control the scope of compliance with NEPA requirements. NEPA requirements (including staging areas and Contractors' off-site activities) must only be met for that portion of the project included within the "logical termini" as described in the NEPA document associated with the federally funded portion of the federalized contract.

NOTE: The Contract File Index is an integral part of the Transmittal of Plans, Specifications and Estimates Package.

**Exhibit 20-C Revision Memo
Sheet 1 of 6**

DATE: _____ 1 of ____
TO: Final Plans (CO-FINALPLANS)
FROM: _____, Project Manager
COPIES: DDE, DCPME
SUBJECT: **Revision Number** _____ - Letting (mo./yr.) ____
Financial Project ID _____ (Lead number only)
Proposal/Contract ID _____
Federal Funds: No Yes Federal Aid No. _____
County _____ State Road No. _____

Mandatory Only: No Yes (*If Yes, Signatures Not Required.)

Concurred by: _____ Date: _____
Signature of Director of Transportation Development or Designee

I have reviewed for effects on the Specifications Package and a package revision is
is not required. *Approved By: _____ Date: _____
Signature of District Specifications Engineer

If FA Oversight, *Authorized By: _____ Date: _____
Print Name of FHWA Engineer

REVISIONS RECEIVED IN THE FINAL PLANS OFFICE WITHIN 15 WORK DAYS
OF THE LETTING MUST BE APPROVED BY THE DISTRICT SECRETARY.

NO REVISIONS ALLOWED WITHIN 5 WORK DAYS OF THE LETTING
WITHOUT APPROVAL.

*Approved By: _____ Date: _____
Signature of District Secretary

SUPPLEMENTAL SPECIFICATIONS PACKAGE NUMBER _____ (____ Pages).

REISSUED SPECIFICATIONS PACKAGE _____ (____ Pages).

PLANS REVISION NUMBER ____ (____ Sheets)

CONTRACT TIME REVISED: No Yes (If yes, _____ Total Calendar Days)

Exhibit 20-C Revision Memo, Sheet 2 of 6

DATE: _____ of _____

Financial Project ID _____ (Lead number only)

Proposal/Contract ID _____

PLANS REVISION NUMBER _____

<u>Sheet Nos.</u>	<u>Rev. Date</u>	<u>Description</u>
_____	_____	_____
_____	_____	_____
_____	_____	_____

SUPPLEMENTAL SPECIFICATIONS PACKAGE NUMBER _____

<u>Sheet Nos.</u>	<u>Rev. Date</u>	<u>Description</u>
_____	_____	_____
_____	_____	_____
_____	_____	_____

Summary of Quantities

Pay Item	Sheet No.	Add. / Del. / Rev.	Old Quantity	New Quantity

Exhibit 20-C Revision Memo, Sheet 3 of 6
REMINDER

PROCESS:

1. Fill out headings.
2. Mandatory Only revisions must not have other revisions included to remain exempt from signature requirement.
3. On oversight projects, get FHWA concurrence. Print name of FHWA Engineer and date. *(Not required for Mandatory Only Revisions.)*
4. Get concurrence signature from the District Director of Transportation Development or designee. *(Not required for Mandatory Only Revisions.)*
5. Get signature of the District Specifications Engineer. *(Not required for Mandatory Only Revisions.)*
6. Revisions received in the Final Plans Office within 15 work days of the letting must be approved by the District Secretary. *(Not required for Mandatory Only Revisions.)* Notify Final Plans. Revisions within five working days of the letting are not allowed without final approval from the Director of the Office of Design. If the revision is not approved, the project will either be let as is, or be withdrawn from letting. Withdrawing or moving the project to a later letting after advertisement requires approval by the District Secretary and the Chief Engineer.
7. For Supplemental Specification Packages, fill in the Rev. Date, number of pages and a brief description.
8. Enter the sheet number and:
Describe new pay item number, Rev. Date with old quantity and new quantity, deleted pay item number only, or revised quantities; by entering pay item number with old and new quantities.
9. On bridges indicate "each bridge number" with corrected changes.
10. If a revision will impact the utility plans, adjustments or schedules, provide a copy of the revision memo and affected plan sheets to the District Utilities Engineer.
11. Any change to any pay item, requires replacement of the entire Proposal Summary of Pay Items.
12. Email the Revision approval to Final Plans Section (CO-FINALPLANS) to unlock the summary of pay items.
13. Email Revision Memo to Final Plans.

REVISED DOCUMENTS:

1. Revised sealed plans sheets including Summary of Pay Items and Summary of Quantities sheets.
2. Revised District Cost Estimate if federally funded.
3. Revised sealed Supplemental Specifications Package.

COMPUTATIONS:

Show Financial Project ID on revised computation book sheets, and make available to the District Construction Engineer.

Exhibit 20-C Revision Memo, Sheet 4 of 6

EXAMPLE REVISION MEMO

DATE: March 15, 2016 1 of 2
TO: Final Plans (CO-FINALPLANS)
FROM: _____ John Doe, Project Manager
COPIES: DDE, DCPME
SUBJECT: **Revision Number 3** - Letting (mo./yr.) 05/16
Financial Project ID 197707-1-52-01 (Lead number only)
Proposal/Contract ID T1234
Federal Funds: No Yes Federal Aid No. 00A1-234-B
County Leon State Road No. 25
Mandatory Only: No Yes (*If Yes, Signatures Not Required.)

*Concurred by: _____ Date: _____
Signature of Director of Transportation Development or Designee

I have reviewed for effects on the Specifications Package and a package revision **is**
is not required. Approved By: _____ Date: _____
Signature of District Specifications Engineer

If FA Oversight, *Authorized By: _____ Date: _____
Print Name of FHWA Engineer

REVISIONS RECEIVED IN THE FINAL PLANS OFFICE WITHIN 15 WORK DAYS OF THE LETTING MUST BE APPROVED BY THE DISTRICT SECRETARY.

NO REVISIONS ALLOWED WITHIN 5 WORK DAYS OF THE LETTING WITHOUT APPROVAL.

*Approved By: _____ Date: _____
Signature of District Secretary

- SUPPLEMENTAL SPECIFICATIONS PACKAGE NUMBER 1 _____
(3 Pages).
 - REISSUED SPECIFICATIONS PACKAGE _____ (Pages).
 - PLANS REVISION NUMBER 2 (4 Sheets)
- CONTRACT TIME REVISED: No Yes (If yes, _____ Total Calendar Days)

Exhibit 20-C Revision Memo, Sheet 5 of 6

EXAMPLE REVISION MEMO

DATE: March 15, 2016

2 of 2

Financial Project ID 197707-1-52-01 (Lead number only)

Proposal/Contract ID T1235

PLANS REVISION NUMBER 2

<u>Sheet Nos.</u>	<u>Rev. Date</u>	<u>Description</u>
<u>1</u>	<u>3-15-16</u>	<u>Listed Revisions</u>
<u>2</u>	<u>3-15-16</u>	<u>See Summary of Quantities Table below</u>
<u>3</u>	<u>3-15-16</u>	<u>See Summary of Quantities Table below</u>
<u>4</u>	<u>3-15-16</u>	<u>Summary of Pay Items updated</u>

SUPPLEMENTAL SPECIFICATIONS PACKAGE NUMBER 1

<u>Sheet Nos.</u>	<u>Rev. Date</u>	<u>Description</u>
<u> </u>	<u> </u>	<u>Added SP040100</u>
<u> </u>	<u> </u>	<u> </u>
<u> </u>	<u> </u>	<u> </u>
<u> </u>	<u> </u>	<u> </u>

Summary of Quantities

Pay Item	Sheet No.	Add. / Del. / Rev.	Old Quantity	New Quantity
120-1	2	Rev	121,172 CY	128,237 CY
120-6	2	Rev	96,143 CY	95,680 CY
425-1-559	2	Add		1 EA
530-3-3	3	Rev	54.7 TN	57.7 TN
530-3-4	3	Rev	86.7 TN	32.0 TN

Exhibit 20-C Revision Memo, Sheet 6 of 6
EXAMPLE SUMMARY OF PAY ITEMS SHEET

NOTICE: THE OFFICIAL RECORD OF THIS SHEET IS THE ELECTRONIC FILE SIGNED AND SEALED UNDER RULE 61G15-23.003, F.A.C.

FLORIDA DEPARTMENT OF TRANSPORTATION PROJECT SUMMARY OF PAY ITEMS LEAD PROJECT : 000000-00-00 PROJECT(S) : 000000000000		COUNTY : LEON		COUNTY SECTION : 55020000	
0200 SUMMARY OF ROADWAY					
SEC ALT	ITEM NUMBER	ITEM DESCRIPTION	UNIT	QUANTITY	TOTAL
	0101-1	MOBILIZATION	LS	1.000	1.000
	0102-1	MAINTENANCE OF TRAFFIC	(LS)	1.000	1.000
	0102-3	COMMERCIAL MATERIAL FOR DRIVEWAY MAINTENANCE	CY	250.000	250.000
	0102-60-	WORK ZONE SIGN	EA	2030.000	2030.000
	0102-74-1	TEMPORARY BARRICADE - TYPES 1, 11, 01, VP, DROW, OR LCD	EA	5065.000	5065.000
	0102-74-2	BARRICADE - TEMPORARY - TYPE 111 - 6"	EA	435.000	435.000
	0102-77-	HIGH INTENSITY FLASHING LIGHTS, TEMP. TYPE B	EA	870.000	870.000
	0104-10-3	SEDIMENT BARRIER	LF	1232.000	1232.000
	0104-11-	FLASHING TORLIDITY BARRIER	LF	436.000	436.000
	0104-15-	SOIL TRAPPING PREVENTION DEVICE	EA	1.000	1.000
	0104-18-	INLET PROTECTION SYSTEM	EA	4.000	4.000
	0107-2-	NOVING	AC	20.640	20.640
	0110-1-	CLEANING & GRUBBING	(LS)	1.000	1.000
	0110-4-	REMOVAL OF EXISTING CONCRETE PAVEMENT	SY	15819.700	15819.700
	0120-1-	REGULAR ENCUMBRANCE	CY	3258.000	3258.000
	0120-2-2	BORROW EXCAVATION, TRUCK MEASURE	CY	1251.000	1251.000
	0160-4-	TYPE B STABILIZATION	SY	142863.200	142863.200
	0162-1-11	PREPARED SOIL LAYER, FINISH SOIL LAYER, 6"	SY	5181.000	5181.000
	0285-701-	OPTIONAL BASE, BASE GROUP 01	SY	3139.300	3139.300
	0285-709-	OPTIONAL BASE, BASE GROUP 09	SY	122132.000	122132.000
	0327-70-1	MILLING EXIST ASPH PAVT 1 1/2" AVG DEPTH	SY	4480.100	4480.100
	0334-1-23	SUPERPAVE ASPH CONC, TRAFFIC C, PG06-22, PH4	TW	17055.850	17055.850
	0337-7-42	ASPHALT CONCRETE FRICTION COURSE, TRAFFIC C, FC-9.5, RG 74-22, PH4	TW	6453.340	6453.340
	0339-1-	MISCELLANEOUS ASPHALT PAVEMENT	TW	3.120	3.120
	0430-200-23	FLARED END SECTION, CONCRETE, 15"	EA	1.000	1.000
	0440-1-30	UNDERDRAIN, TYPE V	LF	2534.800	2534.800
	0440-73-2	UNDERDRAIN OUTLET PIPE, 6"	LF	102.800	102.800
	0515-1-2	PIPE HANDRAIL - ALUMINUM	LF	2358.100	2358.100
	0520-1-7	CONCRETE CURB & GUTTER, TYPE E	LF	25584.300	25584.300
	0520-1-10	CONCRETE CURB & GUTTER, TYPE F	LF	36195.800	36195.800
	0520-5-11	TRAFFIC SEPARATOR CONCRETE-TYPE 1, 4" WIDE	LF	117.500	117.500
	0520-5-16	TRAFFIC SEPARATOR CONCRETE-TYPE 1, 8.5" WIDE	LF	1670.300	1670.300
	0521-72-5	SHOULDER CONCRETE BARRIER WALL, RIGID-CURB & GUTTER	LF	342.900	342.900
	0522-1-	CONCRETE SIDEWALK AND DRIVEWAYS, 4" THICK	SY	20354.800	20354.800
	0522-2-	CONC SIDEWALK AND DRIVEWAYS, 6" THICK	SY	2046.700	2046.700
	0524-1-4	CONCRETE DITCH PAVEMENT, NON REINFORCED, 6"	SY	106.800	106.800
	0526-1-1	GUARDRAIL - ROADWAY	LF	100.000	100.000
	0526-73-	GUARDRAIL REMOVAL	LF	1052.900	1052.900
	0536-85-22	GUARDRAIL END ANCHORAGE ASSEMBLY, FLARED	EA	1.000	1.000
	0530-10-220	FENCING, TYPE B, 5.1 6", STANDARD	LF	591.500	591.500
	0530-60-212	FENCE GATE, TYPE B, SINGLE, 6.1 12.0' OPENING	EA	4.000	4.000
	0570-1-1	PERFORMANCE TURF	SY	210.700	210.700
	0570-1-2	PERFORMANCE TURF, 500	SY	145666.500	145666.500
0300 SUMMARY OF SIGNING					
SEC ALT	ITEM NUMBER	ITEM DESCRIPTION	UNIT	QUANTITY	TOTAL
	0706-3-	RETRO-REFLECTIVE PAVEMENT MARKINGS	EA	1527.000	1527.000
	0710-11-111	PAINTED PAVEMENT MARKINGS - STANDARD, WHITE, SOLID, 6"	MM	7.784	7.784
	0710-11-123	PAINTED PAVEMENT MARKINGS - STANDARD, WHITE, SOLID, 12"	LF	2723.000	2723.000
	0710-11-124	PAINTED PAVEMENT MARKINGS - STANDARD, WHITE, SOLID, 18"	LF	108.000	108.000
	0710-11-125	PAINTED PAVEMENT MARKINGS - STANDARD, WHITE, SOLID, 24"	LF	636.000	636.000
	0710-11-131	10-30 OR 3-9 SKIP	GH	6.541	6.541
	0710-11-160	PAINTED PAVEMENT MARKINGS - STANDARD, WHITE, MESSAGE	EA	80.000	80.000
	0710-11-170	PAINTED PAVEMENT MARKINGS - STANDARD, WHITE, ARROWS	EA	90.000	90.000
	0710-11-211	PAINTED PAVEMENT MARKINGS - STANDARD, YELLOW, SOLID, 6"	MM	7.335	7.335
	0710-11-224	PAINTED PAVEMENT MARKINGS - STANDARD, YELLOW, SOLID, 18"	LF	336.000	336.000
	0710-11-290	PAINTED PAVEMENT MARKINGS - STANDARD, YELLOW, ISLAND INBSE	SP	491.900	491.900

DATE	DESCRIPTION	REVISIONS	STATE OF FLORIDA DEPARTMENT OF TRANSPORTATION	SHEET NO. 2
09/14/13	REVISED AND ADDED PAY ITEMS		SUMMARY OF PAY ITEMS	
10/15/13	SELECTED PAY ITEM 104-1			
11/11/13	ADDED PAY ITEMS			
ROAD NO.	COUNTY	FINANCIAL PROJECT ID	SR 10	LEON
		000000-0-00-00		

**Exhibit 20-D Preliminary Engineering Certification
Sheet 1 of 2**

MEMORANDUM

DATE: _____

TO: _____, Federal Aid Programs Manager

FROM: _____, Design Project Manager

COPIES: _____

SUBJECT: **PRELIMINARY ENGINEERING CERTIFICATION** (Federal Aid Projects Only)

Financial Project ID _____

Proposal/Contract ID _____

Federal Aid No. _____

County _____

Project Description _____

Preliminary Engineering (design) was funded with:

_____ State Funds under,
Financial Project ID _____

_____ Federal Funds authorized under,
Federal Aid No. _____
Financial Project ID _____

The following projects, designed with the same Preliminary Engineering funds, will be strung to (awarded with) the subject project:

Federal Aid No. _____, Financial Project ID _____,
Federal Aid No. _____, Financial Project ID _____.

The Preliminary Engineering for the subject project is _____ open/ _____ closed. If open,
_____ it will be closed after PS&E authorization, or

_____ it is a district wide project. Task order number _____ for this project is closed. The
financial number will be open for other projects.

_____ it will remain open for additional charges, as follows: _____

The FDOT Project Manager may be contacted at (phone): _____

**Exhibit 20-D Preliminary Engineering Certification
Sheet 2 of 2**

REMINDER

Under “Preliminary Engineering (design) was funded with:”

The Financial Project ID should always have a 3X phase in it. 3X is for
Preliminary Engineering (design). Example: 415211-1-32 01
or 415211-1-31 01

Preliminary Engineering Certification is required if Federal Funds are used for either
Design or Construction phases.

**Exhibit 20-E Sample Local Agency Maintenance Agreement
for Work Performed by the Department
Sheet 1 of 3**

Financial Project ID: _____

Federal Aid No. _____

Local Agency: _____

Project Description: _____

Bridge No.: _____

MAINTENANCE AGREEMENT

THIS AGREEMENT, made and entered into on this _____ day of _____, 20____, by and between the STATE OF FLORIDA DEPARTMENT OF TRANSPORTATION (hereinafter called "DEPARTMENT"), and _____, Florida (hereinafter called "LOCAL AGENCY");

WITNESSETH:

WHEREAS, the DEPARTMENT is preparing to undertake a project within the LOCAL AGENCY and LOCAL AGENCY identified and known to the parties by Financial Project I.D. _____ which will be of benefit to the LOCAL AGENCY; and

WHEREAS, approval of federal aid necessary to the project requires agreement by the LOCAL AGENCY to maintain the project;

NOW, THEREFORE, in consideration of the premises, the parties hereby agree as follows:

1. The DEPARTMENT will undertake the project and obtain approval of the Federal Highway Administration for federal participation.
2. Upon completion and acceptance, the LOCAL AGENCY will assume responsibility for maintenance of the project and will conduct such maintenance in accordance with approved state standards.
3. To the extent permitted by law, LOCAL AGENCY must indemnify, defend, and hold harmless the DEPARTMENT and all of its officers, agents, and employees from any claim, loss, damage, cost, charge, or expense arising out of any act, error, omission or negligent act by LOCAL AGENCY, its agents, or employees, during the performance of the Agreement, except that neither LOCAL AGENCY, its agents, or its employees will be liable under this paragraph for any claim, loss, damage, cost, charge, or expense arising out of any act, error, omission, or negligent act by the DEPARTMENT or any of its officers, agents, or employees during the performance of the Agreement. Nothing herein must waive the rights of sovereign immunity of either party.

**Exhibit 20-E Sample Local Agency Maintenance Agreement
For Work Performed by the Department
Sheet 2 of 3**

4. In the event there are cost overruns, supplemental agreements (specifically incurred in the areas located off the State Highway System), and or liquidated damages not eligible to be paid for by federal funds due to the Federal Highway Administration determining that said costs are non-participating costs, the LOCAL AGENCY must be responsible for one-hundred percent (100%) of the funds required to make up the shortfall not paid by federal funds. The Project is off of the "State Highway System," therefore, in accordance with **Section 339.08(1), Florida Statutes**, State funding cannot be used for payments of non-participating costs on this Project. (Examples of non-participating items could be fishing piers; premium costs due to design or CEI errors or omissions; material or equipment called in for the plans but not used in the construction, as referenced in the Federal Aid Policy Guide 23, **CFR Section 635.120**).
 - a. Should such shortfalls occur, due to a determination that said costs are non-participating, the (LOCAL AGENCY) agrees to provide, without delay, a deposit within fourteen (14) calendar days of notification from the Department, to ensure that cash on deposit with the Department is sufficient to fully fund the shortfall. The Department must notify the (LOCAL AGENCY) as soon as it becomes apparent there is a shortfall; however, failure of the Department to so notify the (LOCAL AGENCY) must not relieve the (LOCAL AGENCY) its obligation to pay for its full participation of non-participating costs during the Project and on final accounting, as provided herein below. If the (LOCAL AGENCY) cannot provide the deposit within fourteen (14) days, a letter must be submitted to and approved by the Department's project manager indicating when the deposit will be made. The (LOCAL AGENCY) understands the request and approval of the additional time could delay the project, and additional non-participating costs may be incurred due to the delay of the project.
5. The DEPARTMENT intends to have its final and complete accounting of all costs incurred in connection with the work performed hereunder within three hundred sixty days (360) of final payment to the Contractor. The Department considers the Project complete when the final payment has been made to the Contractor, not when the construction work is complete. All non-participating Project cost records and accounts must be subject to audit by a representative of the (LOCAL AGENCY) for a period of three (3) years after final close out of the Project. The (LOCAL AGENCY) will be notified of the final non-participating cost of the project. Both parties agree that in the event the final accounting of total non-

participating costs pursuant to the terms of this Agreement is less than the total deposits to date, a refund of the excess will be made by the Department to the (LOCAL AGENCY). If the final accounting is not performed within three hundred and sixty (360) days, the (LOCAL AGENCY) is not relieved from its obligation to pay.

6. In the event the final accounting of total non-participating costs are greater than the total deposits to date, the (LOCAL AGENCY) will pay the additional amount within forty (40) calendar days from the date of the invoice from the Department. The (LOCAL AGENCY) agrees to pay interest at a rate as established pursuant to Section 55.03, Florida Statutes, on any invoice not paid within forty (40) calendar days until the invoice is paid.
7. Any payment of funds under this Agreement provision will be made directly to the Department for deposit.

IN WITNESS WHEREOF, the parties hereto have set their hands and seals on the day and year first above written.

HOLMES LOCAL AGENCY,
LOCAL AGENCY OFFICIAL

STATE OF FLORIDA
DEPARTMENT OF TRANSPORTATION

By: _____
Title: _____

By: _____
District Secretary

(Type Name)

ATTEST:

ATTEST:

Clerk (Seal)

Executive Secretary (Seal)

LEGAL APPROVAL:

LEGAL APPROVAL:

LOCAL AGENCY Attorney

Senior Attorney

(Type Name)

20.2 Plans Processing and Revisions after Award

20.2.1 General

This section outlines the process for incorporating revisions after award (A.K.A. “Post-Let Revisions”), and outlines the steps for review by the Department.

Modification for Non-Conventional Projects:

Delete **PPM** 20.2.1 and replace with the following:

20.2.1 General

This section outlines the process for submitting component plan phase submittals as well as the review component plan phase submittals by the Department’s discipline reviewers. It also outlines “Released for Construction” stamping process prior to beginning work as well as the plans process for incorporating design revisions initiated by the Design Build Firm after initial “Released for Construction” stamping.

20.2.2 Revisions after Award

It is the responsibility of the FDOT Project Manager to coordinate a review of design revision submittals performed by the appropriate District and Central Office discipline phase reviewers.

Modification for Non-Conventional Projects:

Delete the title of **PPM** 20.2.2 and the first sentence and replace with the following:

20.2.2 Plans Processing After Award and Revisions after Initial “Released for Construction” Stamping

20.2.2.1 Component Submittal Reviews

It is the responsibility of the FDOT Project Manager to coordinate a review of all Component Plans submittals with the appropriate District and Central Office discipline phase reviewers.

Plans must meet the minimum contents of a particular phase submittal prior to submission for review per the requirements of the RFP and **Chapter 26** of this Volume as well as **Chapter 2** of Volume 2. Include a key sheet as the first sheet in the set of all component plans. Clearly indicate the phase being submitted, the component being submitted, the date of the submittal and the other project specific key sheet information on the key sheet per **Chapter 3** of Volume 2. Component submittals must be accompanied by sufficient information for adjoining components or areas of work to allow for proper evaluation of the component under review.

Unless otherwise indicated in the RFP, submittals for Category 1 and 2 bridges are limited to the following component submittals: foundation, substructure, and superstructure. Bridge component submittals must be accompanied by all supplemental information required for a complete review. Submittals for individual component elements (i.e. Pier 2, Abutment 1, Span 4, etc.) and incomplete submittals will not be accepted.

Include the following in Category 1 and 2 bridge components:

- Plan sheets, and the key sheet for the component under review developed to the specified level of detail (i.e. 90% plans, Final plans, etc.),
- A set of the most current plan sheets for all bridge elements other than the component elements under review. Mark these sheets "For Information Only" on the index sheet. Develop all plan sheets beyond a 30% level of completion.
- Design documentation including a complete set of calculations, geotechnical reports, pertinent correspondence, etc. in support of the 90% and final component submittals.
- Include independent peer review documentation with component submittals for Category 2 bridges.

20.2.2.2 Direction to all Discipline Phase Reviewers

Separate component plan review comments into comments that do and comments that do not refer to direct violations of the contract in accordance with **Exhibit 20-F**.

20.2.2.3 “Released for Construction” Stamping

Deliver final signed and sealed plans to the FDOT Project Manager or his designee prior to construction of any component. The Engineer of Record must seal final plans in accordance with the requirements of **Chapter 19**, of this Volume. The FDOT Project Manager or his designee will send a copy of final signed and sealed plans to the appropriate discipline reviewers to ensure that all comments have been adequately addressed and the final plans reflect the approved responses to comments. Discipline reviewers must respond in writing to the FDOT Project Manager or his designee and give recommendations for stamping once all comments have been satisfactorily resolved. The FDOT Project Manager or his designee will initial, date and stamp each sheet of each submittal as “Released for Construction” after receiving recommendations from discipline reviewers.

20.2.2.4 Revisions after Initial “Released for Construction” Stamping

It is the responsibility of the FDOT Project Manager or his designee to coordinate a review of all design revision submittals which occur after initial “Released for Construction” stamping with the appropriate District and Central Office discipline phase reviewers.

When revisions are required, comply with the following:

1. The responsible professional must Sign and Seal each revised document in accordance with the requirements of **Chapter 19** of this Volume.
2. Modify or delete data on individual sheets by striking through or crossing out. Do not delete data by erasing. Add new data adjacent to crossed out data. If a sheet does not have sufficient space for the revision, add new sheets as required.
3. “Cloud” any revisions after award in a conspicuous manner. If an entire sheet is being deleted, circle and strike through the entire drawing area and retain the deleted sheet in the plans package as a revised sheet.
4. Place a conspicuous unique numbered symbol (e.g. a numbered triangle) beside the revision. Begin the revision numbering with “1” and number subsequent revisions sequentially. For sheets which have been revised pre-award, begin the numbering where the pre-award numbering left off. For large complex projects, when requested by the Department, number revisions by addendum issuance in order to more easily differentiate changes for work order/supplemental agreement processing. In this case, a shape other than a triangle may be utilized.

Modification for Non-Conventional Projects:

Delete Item 4 above and replace with the following:

4. Place a conspicuous unique numbered symbol (e.g. a numbered triangle) beside the revision. Begin the revision numbering with “1” and number subsequent revisions sequentially.

5. Place the revision date, initials of the responsible person, corresponding numbered symbol for the revision and a brief description of the revision in the Revision Block.

Signed and Sealed revised plan sheets will be delivered to the FDOT Project Manager prior to construction of any component. The FDOT Project Manager will send a copy of Signed and Sealed revised plan sheets to the appropriate discipline reviewers for review and comment. Discipline reviewers must respond in writing to the FDOT Project Manager and give recommendations for acceptance for incorporation into the contract documents. The FDOT Project Manager must issue the revised plan sheets as part of the contract documents after receiving recommendations from the discipline reviewers.

Modification for Non-Conventional Projects:

Delete the last two sentences and replace with the following:

Discipline reviewers must respond in writing to the FDOT Project Manager and give recommendations for stamping once all comments have been satisfactorily resolved. The FDOT Project Manager will initial, date and stamp each revised sheet as “Released for Construction” after receiving recommendations from the discipline reviewers.

20.2.3 Final “As-Built” Plans Process

See the [Construction Project Administration Manual \(CPAM\)](#) for preparing the Final “As-Built” contract documents during construction.

20.3 Retention of Electronic Documents

The documents and files created throughout the life of a project must be retained in electronic format. There are several different storage systems used for retaining these records. See **Figure 20.3.1**. As-built Documents that are to be scanned for electronic storage should meet both requirements of the [CPAM 5.12](#) and the [Information Technology Resource User's Manual \(FDOT Procedure No. 325-000-002\)](#).

Figure 20.3.1 Storage of Electronic Documents

Electronic Data Management System (EDMS)					
Legal Records for Department of State Requirements - Image files (PDF Version 1.7 or TIF) only. For information on Specific Document Types stored in each Group contact the Responsible Office					
TIMS	PEDDS DATA BASE	DESIGN EDMS	CONTRACT EDMS	CONSTRUCTION EDMS	STRUCTURES MANAGEMENT EDMS
File management system for In-house CADD file check in/out. Allows for multiple users to work on same files. Working files only. Can be used during Construction Phase to prepare As-Built Plans.	Electronic Vault for Storage of electronically signed, or digital delivery files For Storage of: -Project CD -Plans and Specs CD -Revisions CD -Cat II Bridge As-Built Files Files stored in the PEDDS Database cannot be written.	<u>Design Records</u> <u>Groups</u> Architectural Community Involvement Drainage Environmental Permits Estimates FDOT Publications Geotechnical/Materials Landscaping Lighting Product Evaluation Project Management Rdwy Design Documentation Does not include Plans Roadway Resource Library Specifications Structures Structures Resource Library Tolls Facilities Traffic Design Utility Agreements NOTE: Contract Plans are not stored in the Design EDMS.	<u>Contract Records</u> <u>Groups</u> Construction Contracts: - Amendments - Bid Blank - Certificate Of Insurance - Contract - Federal Aid Contract - Provisions - Permits - Pertinent Pages - Proposal - Special Provisions - Specifications - Supplemental - Specifications - Utility Work Schedule - Wage Rate Supporting Construction Contract Documents: - Award Letter - Correspondence - Daily Diaries - Execution Letter - Final Estimates Package Work Progress NOTE: Contract Plans are not stored in the Contracts EDMS.	<u>Construction Records</u> <u>Groups</u> Claims Compliance Contract Changes Includes Design Errors and Omissions, Field SA/Work Orders, and SA/Change Orders Contract Documents As-Built Plans Daily Diary Estimates Final Estimates General Correspondence Job Correspondence Material Sampling and Reporting Pre-Letting Includes Design Correspondence Quality Assurance/Quality Control Service Contracts Shop Drawing Transmittals Structure Sublet Work Time Correspondence Unpaid Bills Utility	<u>Maintenance Records</u> <u>Groups</u> Bridge Plans and Specifications Bridge Record Bridge Shop Drawings Correspondence Geotechnical High Mast Record Sign Record Structural Calculations - As-Bid Plans - As-Built Plans - Repair As-Bid Plans - Repair As-Built Plans - Widening As-Bid Plans - Widening As-Built Plans

Modification for Non-Conventional Projects:

**Exhibit 20-F Direction to all Discipline Phase Reviewers on
Non-Conventional Project**

Separate component plan review comments into categories which consist of comments that **do** and comments that **do not** refer to direct violations of the Contract as follows:

- **Comments that do refer to direct violations of the Contract require a written response by the Design-Build Firm or Concessionaire.** Where possible, the reviewer is expected to include the specific contract reference or requirement that is being violated. Examples may include, but are not limited to:
 - an **AASHTO** provision that is being violated;
 - a Governing Regulation, e.g. **Plans Preparation Manual (PPM)**, **Structures Design Guidelines (SDG)**, requirement that is being violated;
 - a Technical Proposal commitment that is not being met;
 - a Request For Proposal (RFP) requirement that is being omitted or violated;
 - omission in the plans or calculations;
 - inconsistencies between the plans and calculations;
 - obvious errors in math or basic engineering principles;
 - an environmental commitment or permit commitment that is not being met.

*Example Comment: The vertical curve length does not meet the minimum requirements of **Table 2.8.5** in Volume 1. A written response is required.*

In this example, a requirement from the **PPM** is being violated. The plans must be corrected to address this situation and a written response from the Design-Build Firm or Concessionaire is required.

Example Comment: Calculations are consistent with two phased post-tensioning of the pier cap, but the plans indicate post-tensioning in a single phase. Update plans to be consistent with the calculations so that cap will not be overstressed in the unloaded condition. A written response is required.

In this example, the intent of the comment is to alert the Design-Build Firm or Concessionaire of an inconsistency between the calculations and the plans that would result in the pier cap being overstressed. The plans must be corrected to address this situation and a written response from the design-Build Firm is required.

- **Comments that do not refer to direct violations of the Contract do not require a written response by the Design-Build Firm or Concessionaire.** At the end of each comment state that the comment is for information only and a written response is not required.

Example Comment: The plans as submitted depict a land pier located very close to the shoreline of a major body of water and steel sheet piling is not shown along the water face of the footing. Ensure that the footing can be constructed in the dry per the requirements of the Specifications. This comment is for information only. A written response is not required.

In this example, the intent of the comment is to ensure that the footing concrete is placed in the dry per the Specifications. No matter what action the Design-Build Firm or Concessionaire takes in response to the comment, the Specification requirements still have to be met; the reviewer is putting the Design-Build Firm or Concessionaire on notice.

The discipline phase reviewer may group the comments with a note indicating which comments require a response and which ones do not in lieu of specifying whether a response is required or not for each individual comment.

*Commentary: Discipline phase reviewers should primarily review Design-Build and Public-Private-Partnership project plan submittals for compliance with contract requirements. However, the directive outlined in **Exhibit 20-F** acknowledges that non-contractual comments submitted “for information only” can also provide valuable feedback to the Design-Build Firm or Concessionaire. The purpose of the directive is to allow a formal process for submitting both types of comments on Non-Conventional Projects.*

THIS PAGE LEFT BLANK INTENTIONALLY

Chapter 21

Transportation Design for Livable Communities

21.1	General	21-1
21.2	Planning	21-1
21.3	Application	21-2
21.4	Techniques	21-2
21.5	Design Criteria	21-3
21.5.1	Design Speed	21-3
21.5.2	Number of Lanes	21-3
21.5.3	Lane Widths	21-3
21.5.4	Horizontal Alignment	21-4
21.5.5	Medians	21-4
21.5.6	Lateral Offset	21-4
21.5.7	Intersections	21-4
21.5.8	Lighting	21-4
21.5.9	Traffic Control	21-5
21.5.10	Landscaping	21-5
21.5.11	Parking	21-6
21.5.12	Alternative Roadway Paving Treatments	21-6
21.5.13	Conversion to/from One-Way Street Pairs	21-6
21.6	Pedestrian and Bicycle Considerations	21-7
21.6.1	Sidewalks	21-7
21.6.2	Crosswalks	21-7
21.6.3	Curb Extensions (Bulb-Outs)	21-7
21.6.4	Personal Security and Safety Amenities	21-8
21.6.5	Bicycle Facilities	21-8
21.7	Transit-Systems and Amenities	21-8

Tables

Table 21.1 Lane Widths21-3

Figures

Figure 21.1 Curb Extension21-7

Exhibits

Exhibit 21-A Corridor Techniques21-9
Exhibit 21-B Techniques To Reduce Speed Or Traffic Volume...21-10
Exhibit 21-C Techniques To Encourage Multimodal Travel21-11
Exhibit 21-D Network Techniques21-12

Chapter 21

Transportation Design for Livable Communities

Modification for Non-Conventional Projects:

Delete **PPM** Chapter 21 and see RFP for requirements.

21.1 General

It is the policy of the Department to consider Transportation Design for Livable Communities (TDLC) features on the State Highway System when such features are desired, appropriate and feasible. This involves providing a balance between mobility and livability. TDLC features should be based on consideration of the following principles:

1. Safety of pedestrians, bicyclists, motorists and public transit users.
2. Balancing community values and mobility needs.
3. Efficient use of energy resources.
4. Protection of the natural and manmade environment.
5. Coordinated land use and transportation planning.
6. Local and state economic development goals.
7. Complementing and enhancing existing Department standards, systems and processes.

21.2 Planning

TDLC features are to be considered when they are desired, appropriate and feasible. Incorporating TDLC features are contingent upon involvement of the local stakeholders in the planning and project development processes. Therefore, it is essential that all stakeholders are included from the initial planning phase of the project through design, construction and maintenance.

During the initial planning and scoping phases it is important to identify and assess the desires and willingness of the community or stakeholder to accept all of the ramifications of TDLC, including funding allocations and maintenance agreements of the TDLC features included in a project.

21.3 Application

A team approach is recommended to evaluate TDLC projects or features. Depending on the complexity and/or potential for controversial proposed TDLC features and the district resources available, the team may include representation from Planning, Traffic Operations, Environmental Management, Roadway Design, Right of Way, Public Transportation, Maintenance, Safety, and the Pedestrian/Bicycle and Community Impact Assessment Coordinators. This team should also include the respective Metropolitan Planning Organization(s), local governments/agencies, transit agencies, citizen groups and any others affected by the proposed projects or features.

TDLC projects require documentation of the desired project features determined to be appropriate and feasible for implementation and the respective responsibilities of all involved stakeholders. Documentation may be stand-alone or placed in the design documentation.

TDLC features can be incorporated into new construction, reconstruction, and resurfacing, restoration and rehabilitation (RRR) projects using existing design standards and criteria found in **Chapters 2, 8** and **25** of this Volume. When documentation identifies TDLC features for a project or segments of a project, the criteria provided in this chapter may be used with the approval of the District Design Engineer.

21.4 Techniques

Selected TDLC techniques applied by type of highway system are shown in **Exhibits 21-A, B, C** and **D** at the end of this chapter. These techniques are intended as guidance for balancing the need for mobility and the desire for livable communities, and not as standards, policies or procedures of the Department.

21.5 Design Criteria

The criteria in this chapter meets or exceeds **AASHTO** minimums. All TDLC projects are subject to the requirements for Design Exceptions and Design Variations found in **Chapter 23** of this Volume.

21.5.1 Design Speed

Recommended design speeds are found in **Section 1.9** of this Volume.

21.5.2 Number of Lanes

In developed urban areas, reducing the number of lanes may provide space for pedestrians, bicycles, parking, landscaping etc. This technique may be appropriate depending on volume and character of traffic, availability of right of way, function of the street, existing or planned level of pedestrian, bicycling and transit activity, intensity of adjacent land use, and availability of alternate routes.

The decision to reduce the number of lanes on a project must be supported by an appropriate traffic capacity study. If transit vehicles and school busses are currently operating in the area of the project, appropriate local agencies should be consulted.

21.5.3 Lane Widths

Minimum lane widths for TDLC projects or segments are shown in **Table 21.1**.

Table 21.1 Lane Widths

Lane Types	Width (feet)
Through Lanes	11 ¹
Turn Lanes	11 ¹
Parking Lanes (parallel)	8 ²
Bicycle Lanes	4 ³

1. May be reduced to 10 feet in highly restricted areas with design speeds \leq 35 mph. having little or no truck traffic.
2. May be reduced to 7 feet (measured from face of curb) in residential areas.
3. 7 feet adjacent to on-street parking.

21.5.4 Horizontal Alignment

A curvilinear alignment can be used to control vehicle speed by introducing a bend or curve on a tangent roadway. Design should meet criteria in **Chapter 2** of this Volume.

21.5.5 Medians

Requirements for medians are provided in **Section 2.2** of this Volume. Where continuous raised medians are not provided, such as on 5-lane sections, refuge areas should be provided at appropriate locations. These locations are typically near high pedestrian generators such as schools, park entrances, transit stops and parking lots. Refuge Islands must provide a large enough area for several pedestrians at once while at the same time be of sufficient size and spacing as to not create a hazard. For wheelchair accessibility, it is preferable to provide at-grade cuts rather than ramps.

For landscaping in medians see **Section 21.5.10**.

21.5.6 Lateral Offset

Lateral offset requirements for TDLC projects are provided in **Chapter 4** of this Volume.

21.5.7 Intersections

Intersection designs must adequately meet the needs of motorists, transit riders, bicyclists and pedestrians. Large return radii increases the crossing distance for pedestrians while small return radii decreases a vehicle's ability to negotiate the turn. Return radii must balance the needs of the pedestrian and the design vehicle. See **Figure 21.1**.

21.5.8 Lighting

Lighting requirements are discussed in **Chapters 2** and **7** of this Volume.

21.5.9 Traffic Control

Where traffic volumes are high enough to require traffic signals, they should be placed to allow good progression of traffic from signal to signal. Optimal spacing of signals depends on vehicle operating speeds and signal cycle lengths. At speeds of 35 mph and standard cycle lengths, signals must be at least a fourth of a mile apart. Such spacing is consistent with FDOT's requirements for state highways, and with its recommended minimums for local arterials and collectors.

Where traffic volumes are not high enough to warrant traffic signals, 4-way stop signs and roundabouts should be considered. Four-way stops are considered to have a traffic calming effect and cause minimal delays under light traffic conditions. Roundabouts allow traffic from different directions to share space in the intersection, while signals require traffic to take turns.

Where traffic volumes are high enough to warrant traffic signals but does not require them, roundabouts should also be considered. If Roundabouts are being considered in a TDLC project, refer to ***NCHRP Report 672, Roundabouts: An Informational Guide***, adopted by FHWA.

21.5.10 Landscaping

Landscaping on a TDLC project can be provided when a local agency or organization agrees to assume the maintenance of the landscaped area in accordance with all Department requirements. See ***Chapter 9*** of this Volume and the ***Florida Highway Landscape Guide*** for landscape requirements.

Landscaping must not interfere with the visibility of "permitted" outdoor advertising in accordance with ***Rule 14-40*** of the ***Florida Administrative Code***. Landscaping must provide required sight distances in accordance with the ***Design Standards, Index 546***. Landscaping must also comply with the lateral offset requirements found in ***Chapter 4*** of this Volume.

Community Aesthetic Features placed in the right of way to represent the community are discussed in ***Section 9.3*** of this Volume.

21.5.11 Parking

When parking is incorporated on a TDLC project, several parking configurations may be considered (parallel, front-in angled and back-in angled). The design of parking facilities should be coordinated with local transit agencies and consistent with state and local laws (including **Section 316.195, Florida Statutes**). For parking lane widths see **Table 21.1**.

21.5.12 Alternative Roadway Paving Treatments

Alternative paving treatments such as patterned pavement may be used to accent the roadway in accordance with the **Standard Specifications**. Architectural pavers, however, will not be used on the traveled way of the State Highway System. See **Section 2.1.6.1** for additional requirements.

21.5.13 Conversion to/from One-Way Street Pairs

Converting one-way pairs to two-way streets or two-way streets to one-way pairs may be appropriate on TDLC projects. These techniques require a great deal of consideration, planning and public involvement. Some considerations include: safety of pedestrians, bicyclists and motorists, traffic capacity, on-street parking, signal progression along the corridor and transit facilities.

21.6 Pedestrian and Bicycle Considerations

21.6.1 Sidewalks

For criteria refer to *Chapter 2, Section 2.1.4* and *Chapter 8* of this Volume.

21.6.2 Crosswalks

Marked crosswalks should be provided at signalized intersections. Marked crosswalks should also be provided at midblock crossing locations that are controlled by traffic signals and pedestrian signals, and school crossing locations that are controlled by guards during school crossing periods. The use of uncontrolled crosswalks should be carefully considered. Refer to *Section 8.3.3* of this Volume for further guidance on designing crosswalks.

21.6.3 Curb Extensions (Bulb-Outs)

Curb extensions, sometimes called bulb-outs, may be used at intersections, or at mid-block locations where there is a crosswalk, provided there is adequate width for existing traffic movements. Curb extensions shorten the crossing distance, and provide additional space at intersections allowing pedestrians to see and be seen before entering a crosswalk. The design of curb extensions must take into consideration the needs of transit vehicles, drainage and bicyclists. See *Figure 21.1*.

Figure 21.1 Curb Extension

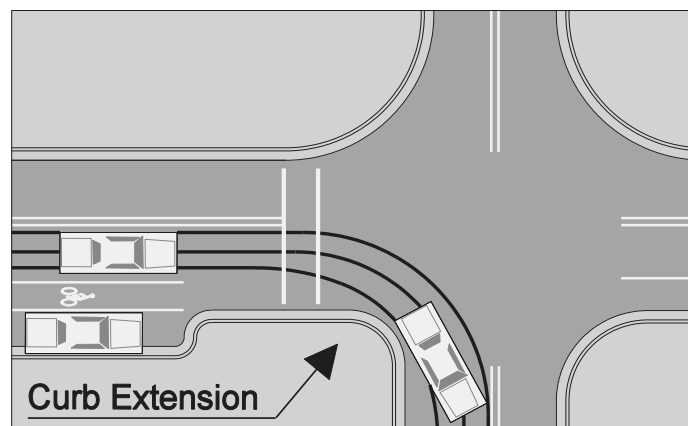

21.6.4 Personal Security and Safety Amenities

Personal security and safety is promoted by maximizing visibility in and along parking areas, building entrances, transit stops, sidewalks and roadways. This can be provided by the following techniques:

1. Providing lighting.
2. Lowering vegetation heights.
3. Removing hiding places.

Examples for designing safer communities can be found in The National Crime Prevention Council's publication: ***Crime Prevention Through Environmental Design***.

21.6.5 Bicycle Facilities

Refer to **Chapter 8** of this Volume for design of bicycle facilities.

21.7 Transit-Systems and Amenities

Transit accommodations should be developed in cooperation with the local jurisdictions and transit agencies. Refer to **Chapter 8** of this Volume and [Accessing Transit, Design Handbook for Florida Bus Passenger Facilities, Version 2, 2008](#) for additional information on the design of transit facilities.

Exhibit 21-A Corridor Techniques

TECHNIQUE	SIS		SHS URBAN	SHS RURAL	NON-SHS
	LIMITED ACCESS	CONTROLLED ACCESS			
Improved location, oversized or redundant directional signs	A	A	M	M	M
Use of route markings/ signing for historical and cultural resources	M	A	A	A	A
Increased use of variable message signing	A	A	M	M	M
Landscaping	M	M	M	M	M
Sidewalks or wider sidewalks	NA	M	A	M	M
Street furniture	NA	M	M	M	M
Bicycle lanes	NA	M	M	M	M
Shared Use Paths	NA	M	M	M	M
Conversion to/from one-way street pairs	NA	M	M	NA	M
Alternative paving materials	NA	NA	M	NA	M
Pedestrian signals, midblock crossings, median refuge areas	NA	M	A	M	M
Parking modifications or restoration	NA	NA	M	M	M
Safety and personal security amenities	M	M	M	M	M
Street mall	NA	NA	NA	NA	M

- A "Appropriate"--Techniques which should be included on all TDLC projects unless there are compelling reasons not to do so.
- M "May be Appropriate"--Techniques which should be employed, but must be evaluated relative to context of the particular project.
- NA "Not Appropriate"--Techniques which need not be considered for TDLC projects.

Exhibit 21-B Techniques To Reduce Speed Or Traffic Volume

TECHNIQUE	SIS		SHS URBAN	SHS RURAL	NON-SHS
	LIMITED ACCESS	CONTROLLED ACCESS			
Lower speed limits	NA	NA	NA	NA	N
Increase use of stop or multi-way stop signs	NA	NA	NA	NA	N
Speed humps/tables	NA	NA	NA	NA	M
On-street parking to serve as buffer between travel lanes and pedestrian areas	NA	NA	M	M	M
Curb bulb-outs at ends of blocks	NA	NA	M	M	M
Traffic “chokers” oriented to slowing traffic	NA	NA	NA	NA	M
“Compact” intersections	NA	A	A	A	A
Traffic roundabouts to facilitate intersection movement	NA	M	M	M	M
Curvilinear alignment (with redesign, chicanes, winding paths, etc.)	NA	NA	M	NA	M
Street closing or route relocation	NA	NA	M	NA	M

- A “Appropriate” --Techniques which should be included on all TDLC projects unless there are compelling reasons not to do so.
- M “May be Appropriate”--Techniques which should be employed, but must be evaluated relative to context of the particular project.
- NA “Not Appropriate”--Techniques which need not be considered for TDLC projects.

Exhibit 21-C Techniques to Encourage Multimodal Travel

TECHNIQUE	SIS		SHS URBAN	SHS RURAL	NON-SHS
	LIMITED ACCESS	CONTROLLED ACCESS			
Sidewalks	NA	M	A	M	M
Pedestrian friendly intersection design	NA	M	A	M	M
Midblock pedestrian crossings	NA	M	M	M	M
Illuminated pedestrian crossings	NA	M	M	M	M
Bicycle lanes/paved shoulders	NA	M	A	A	M
Independent Shared Use Path	NA	M	M	M	M
Bicycle friendly design and parking	NA	M	A	A	A
Transit system amenities	NA	M	A	M	M
Transit user amenities	NA	M	A	M	M
Exclusive transit lanes	M	M	M	M	M
Linking modal facilities	A	A	A	A	A
Lower speed limits	NA	NA	NA	NA	NA
Removal of street parking	NA	NA	M	M	M

- A “Appropriate”--Techniques which should be included on all TDLC projects unless there are compelling reasons not to do so.
- M “May be Appropriate” --Techniques which should be employed, but must be evaluated relative to context of the particular project.
- NA “Not Appropriate” --Techniques which need not be considered for TDLC projects.

Exhibit 21-D Network Techniques

TECHNIQUE	SIS		SHS URBAN	SHS RURAL	NON- SHS
	LIMITED ACCESS	CONTROLLED ACCESS			
Design the street network with multiple connections and relatively direct routes	NA	NA	A	M	M
Space through-streets no more than a half mile apart.	NA	NA	A	M	M
Use traffic calming measures	NA	M	M	M	M
Limit local speed to 20 mph	NA	NA	NA	NA	M
Limit lanes	M	M	M	M	M
Align streets to give buildings energy-efficient orientations	NA	NA	M	NA	M
Avoid using traffic signals wherever possible. Space them for good traffic progression	NA	M	M	M	M
Incorporate pedestrian and bicyclist design features	NA	A	A	A	A
Incorporate transit-oriented design	M	A	A	A	A
Design attractive greenway corridors	A	A	A	A	A
Design attractive storm water facilities	A	A	A	A	A

- A “Appropriate”--Techniques which should be included on all TDLC projects unless there are compelling reasons not to do so.
- M “May be Appropriate”--Techniques which should be employed, but must be evaluated relative to context of the particular project.
- NA “Not Appropriate”--Techniques which need not be considered for TDLC projects.

Chapter 22

Lump Sum Project Guidelines

22.1	General	22-1
22.2	Project Selection	22-2
22.3	Plans Preparation.....	22-4
22.4	Preliminary Estimate	22-5
22.5	Specifications	22-6
22.6	Contracts Administration	22-7
22.7	Construction Contract Administration	22-7
22.8	Materials Sampling and Testing	22-8
Exhibits		
Exhibit 22-A	Items of Work	22-9

THIS PAGE LEFT BLANK INTENTIONALLY

Chapter 22

Lump Sum Project Guidelines

Modification for Non-Conventional Projects:

Delete *PPM* Chapter 22.

22.1 General

The purpose of Lump Sum projects is to reduce the costs of contract administration associated with quantity, verification and measurement. This contracting technique requires the Contractor to submit a lump sum price to complete a project as opposed to bidding on individual pay items. The Contractor will be provided a set of bid documents (plans, specifications, etc.) and will develop a Lump Sum bid for all work specified in the contract drawings.

The decision to use the Lump Sum Contracting Technique on a project should be made by the District Design Engineer in consultation with the District Construction Engineer. Lump Sum Projects should be identified during the scope development process, rather than during or after the design process. Conversion of partially complete plans and completed “plans on the shelf” that were originally developed as conventional bid item type projects to the Lump Sum Technique may require significant rework and is generally not recommended.

The contingency pay item is recommended on a Lump Sum project. This tool is used to compensate the Contractor for any additional work requested, which is not covered in the contract documents. District Construction should be consulted for the contingency amount.

22.2 Project Selection

Lump Sum contracting should be used on simple projects. “Simple” is defined by the work activity, not by the project cost. “Simple” projects are:

1. Projects with a well-defined scope for all parties (Design and Construction)
2. Projects with low risk of unforeseen conditions (i.e., projects that do not involve such things as significant underground utilities, earthwork variations, underground drainage pipes, bricks under pavement in urban areas, etc.)
3. Projects with low possibility for change during all phases of work – Design and Construction (i.e., limited possibilities for added driveways, median modifications due to developments, changes due to political involvement, etc.)

Examples of projects that may be good Lump Sum contracting candidates:

1. Bridge painting
2. Bridge projects
3. Fencing
4. Guardrail
5. Intersection improvements (with known utilities)
6. Landscaping
7. Lighting
8. Mill/Resurface (including Interstate) without complex overbuild requirements
9. Minor road widening
10. Sidewalks
11. Signing
12. Signalization

Examples of projects that may not be good Lump Sum contracting candidates are listed below. Use of Lump Sum contracting on these type projects requires written approval by the State Roadway Design Engineer:

1. Urban construction/reconstruction
2. Rehabilitation of movable bridges
3. Projects with subsoil earthwork
4. Concrete pavement rehabilitation projects
5. Major bridge rehabilitation/repair projects where there are many unknown quantities
6. JPA Projects with local agency funds

22.3 Plans Preparation

Plan content should conform to the requirements of **Volume 2**, subject to the guidance provided herein. Designers should detail plans, either by detailed drawings or plan notes, to clearly describe the work to be performed by the contractor. Special care should be used to insure pay item notes and other notes and requirements such as “as directed by the Engineer” are deleted or replaced with specific direction and details that can be properly bid on by the Contractor. Following are some of the desired elements in a set of Lump Sum plans:

1. A pay item note placed on the Summary of Pay Items sheet stating, “999-2 Lump Sum Contract: All other Pay item numbers shown in the Contract Plans are provided only for the purpose of describing the work to be performed. Pay item descriptions are found in the Department’s **Basis of Estimates Manual.**” This note only needs to be placed the one time on this sheet. It should not be repeated on any other sheets within the Contract Plans.
2. Typical Sections.
3. Milling, resurfacing and overbuild details to show any cross slope corrections, including existing pavement cross slope information.
4. Document quantities for all work to be performed on the project by location in the summary boxes for Roadway and Structures disciplines or on a tabulation of quantities sheet for all other disciplines. Note: Summary boxes and tabulation sheets should not have totals. The standard summary boxes contained in the FDOT CADD software should be used.
5. Plan sheets to accurately depict existing conditions and detail all work to be performed by contractor. (i.e., show all limits of milling and resurfacing, pipe installations, limits of sod when different from typical section, all concrete work, guardrail removal/installation, etc.).
6. Details of work not covered by typical section or the **Design Standards** (i.e., curb and gutter installation, traffic separator limits, special curb ramps, modifications to storm inlets, etc.).
7. Cross sections when shoulder break is moved. When cross sections are provided, earthwork columns should not be used.
8. Anticipated pile tip/drilled shaft elevations on bridge projects. Note: This is the predicted elevation to achieve axial capacity and satisfy all other design requirements and is usually deeper than the minimum tip elevation shown for piles.

For projects that include new asphalt surfaces, a note should be placed in the Signing and Pavement Marking Plans that states, “All pavement markings must be paint unless otherwise noted in the plans.”

22.4 Preliminary Estimate

If there is only one project in the contract, code in the pay item for Lump Sum (Alternative Bidding) (999-2) and the Initial Contingency Amount (Do Not Bid) Pay item (999-25). If there is more than one project in a single contract (strung projects), code both pay items on each project.

Provide data to the District Estimates Office to be used in the estimate process. The data necessary for preparing the preliminary estimate may differ with project type and complexity. Preliminary estimates for Lump Sum projects may be determined in a number of ways: data from the designer, historic data, long-range estimate (LRE), and by reviewing data from similar, current projects. The intent of Lump Sum Contracting is not to shift the responsibilities or work involved in estimating quantities from the designer to the District Estimates Office. The cooperative effort of the designer in providing data in an electronic spreadsheet or other means acceptable to the District Estimates Office will be helpful in improving the Lump Sum Preliminary Estimate Process. Contact the appropriate District for specific requirements.

22.5 Specifications

The Design Project Manager will provide an “Items of Work” checklist to the District Specifications Office. The Specifications Office will include the work items identified on the checklist in the “Intent and Scope” in the Specifications Package. The checklist must include, as a minimum, the major work items shown in the sample included with these guidelines.

Lump Sum Projects require Special Provisions that modify the first nine articles of the Standard Specifications. These Special Provisions are in the Specifications Workbook and must be included as part of the Specifications package.

Article 9-2 of the Special Provisions for Lump Sum Projects must be completed with predetermined unit prices for asphalt materials, concrete, and base when applicable. These unit prices will serve as a basis for calculating pay reductions for deficiencies accepted by the Engineer. In the case of asphalt overbuild, the predetermined unit price for the material used for overbuild will serve as a basis for pay adjustments for thicknesses that differ from the thickness shown in the plans. All predetermined unit prices should be based on an analysis of similar type projects let in the District and/or the District wide average of projects let within the six months prior to the letting date of the project.

For projects including bridges, Article 9-2 of the Special Provisions for Lump Sum Projects must be completed with predetermined unit prices for piling and/or drilled shafts as applicable. These unit prices will serve as a basis for pay adjustments for the actual quantities installed as additions or deletions from the individual element lengths shown in the plans. All predetermined unit prices should be based on an analysis of similar type projects let in the District and/or the District wide average of projects let within the six months prior to the letting date of the project.

22.6 Contracts Administration

Contracts Administration will include the information provided in the Specifications Package “Intent and Scope” in the job advertisement. This information can be used by the contractors/subcontractors to determine what type of work is contained in the project, in lieu of a list of pay items.

22.7 Construction Contract Administration

Monthly payments will be made based on a payout schedule mutually agreed upon by the Department and the Contractor. The payout schedule will include only major tasks similar to what has been used on design-build projects.

Lump Sum contracts are not fixed price. Changed conditions, extra work and unforeseen work must be negotiated and resolved with the Contractor utilizing Supplemental Agreements and/or Work Orders on Contingency Supplemental Agreements.

Construction inspection personnel should not be required to document quantities except for asphalt and other items subject to pay adjustments (items with predetermined unit prices). Measurement and completion of “Final” quantity for summary boxes on plan sheets is not required. Focus should be on inspection and achieving a quality final product. For example, the project engineer will not be concerned with how many square yards of sod it takes or the number of miles of final striping. The project engineer will be charged with ensuring that the sod, striping, embankment, pipe, etc., meets the lines and grades of the plans and specifications.

22.8 Materials Sampling and Testing

The Laboratory Information Management System (LIMS), relies on the pay items identified in AASHTOWare Project Preconstruction™ (formerly TRNS*PORT), which are populated via the Designer Interface, to generate a Job Guide Schedule based on the **Sampling, Testing and Reporting Guide (STRG)**. On Lump Sum projects, since there is no detailed pay item list to identify the various types of work, LIMS will output a generic Job Guide Schedule. Some materials will not actually be used depending on the project scope. Personnel should use the Job Guide Schedule entries applicable to their project and input sample data and field test results into LIMS system in accordance with standard procedures. Materials not included on the Job Guide Schedule will be accepted in accordance with **Section 6 of the FDOT Specifications** and/or other pertinent contract documents.

**Exhibit 22-A Items of Work
(Sheet 1 of 2)**

DATE: _____

TO: _____, District Specifications

FROM: _____, Project Manager

COPIES TO:

SUBJECT: ITEMS OF WORK

Financial Project ID: _____ (GOES WITH _____)

County (Section): _____

* Project Description: _____

The plans package for the above referenced project includes the following items of work to be performed:

_____	Milling & Resurfacing	_____	Highway Signing
_____	Base Work	_____	Guardrail
_____	Shoulder Treatment	_____	Landscaping
_____	Drainage Improvements	_____	Box or Three-sided Culverts
_____	Curb & Gutter	_____	Bridges
_____	Traffic Signals	_____	MSE Walls
_____	Lighting	_____	Sidewalks/Shared Use Path
_____	Other (Please Specify) _____		

Please include the county, project description and all items of work that apply in the *Intent and Scope* so they may be added to the advertisement description.

* The project description should only include the road number and the limits or location of the project.

Exhibit 22-A Items of Work, Sheet 2 of 2
Example

DATE: June 4, 2010

TO: _____, District Specifications

FROM: _____, Project Manager

COPIES TO:

SUBJECT: ITEMS OF WORK

Financial Project ID: 123456-1-52-01 (GOES WITH _____)

County (Section): St. Johns (78010)

Project Description: SR 5/US 1 in St. Johns County from SR 312 to 1.250 miles North of SR 16

The plans package for the above referenced project includes the following items of work to be performed:

<u> X </u>	Milling & Resurfacing	<u> X </u>	Highway Signing
<u> X </u>	Base Work	_____	Guardrail
_____	Shoulder Treatment	_____	Landscaping
<u> X </u>	Drainage Improvements	_____	Box or Three-sided Culverts
<u> X </u>	Curb & Gutter	_____	Bridges
<u> X </u>	Traffic Signals	_____	MSE Walls
_____	Lighting	_____	Sidewalks/Shared Use Path
_____	Other (Please Specify) _____		

Chapter 23

Design Exceptions and Design Variations

23.1	General	23-1
23.2	Identification	23-2
23.3	Justification for Approval	23-4
23.4	Documentation for Approval	23-5
23.5	AASHTO Controlling Elements	23-7
23.5.1	Design Speed	23-8
23.5.1.1	AASHTO Criteria	23-8
23.5.1.2	Documentation	23-8
23.5.1.3	Mitigation	23-9
23.5.2	Lane Width	23-10
23.5.2.1	AASHTO Criteria	23-10
23.5.2.2	Documentation	23-10
23.5.2.3	Mitigation	23-10
23.5.3	Shoulder Width	23-12
23.5.3.1	AASHTO Criteria	23-12
23.5.3.2	Documentation	23-14
23.5.3.3	Mitigation	23-14
23.5.4	Horizontal Curve Radius	23-15
23.5.4.1	AASHTO Criteria	23-15
23.5.4.2	Documentation	23-15
23.5.4.3	Mitigation	23-15
23.5.5	Superelevation Rate	23-17
23.5.5.1	AASHTO Criteria	23-17
23.5.5.2	Documentation	23-17
23.5.5.3	Mitigation	23-17

23.5.6	Stopping Sight Distance.....	23-19
	23.5.6.1 AASHTO Criteria.....	23-19
	23.5.6.2 Documentation.....	23-20
	23.5.6.3 Mitigation.....	23-20
23.5.7	Maximum Grade.....	23-21
	23.5.7.1 AASHTO Criteria.....	23-21
	23.5.7.2 Documentation.....	23-21
	23.5.7.3 Mitigation.....	23-21
23.5.8	Cross Slope.....	23-23
	23.5.8.1 AASHTO Criteria.....	23-23
	23.5.8.2 Documentation.....	23-23
	23.5.8.3 Mitigation.....	23-23
23.5.9	Vertical Clearance.....	23-25
	23.5.9.1 AASHTO Criteria.....	23-25
	23.5.9.2 Documentation.....	23-25
	23.5.9.3 Mitigation.....	23-26
23.5.10	Design Loading Structural Capacity.....	23-27
	23.5.10.1 AASHTO Criteria.....	23-27
	23.5.10.2 Documentation.....	23-27
	23.5.10.3 Mitigation.....	23-27
23.6	Crash Analysis.....	23-28
	23.6.1 Historical Crash Method (HCM).....	23-28
	23.6.2 Roadside Safety Analysis Program (RSAP).....	23-30
	23.6.3 Highway Safety Manual.....	23-30
23.7	Design Approval Request.....	23-33
	23.7.1 Submittal Package.....	23-33
	23.7.2 Design Exception Approval.....	23-33
	23.7.3 Design Variation Approval.....	23-34
	23.7.4 Signature Requirements.....	23-35

Tables

Table 23.5.1	AASHTO Design Speed (Minimum)	23-8
Table 23.5.2	AASHTO Lane Width (Minimum).....	23-10
Table 23.5.3	AASHTO Shoulder Widths (Minimum).....	23-12
Table 23.5.4	AASHTO Bridge Widths (Minimum).....	23-13
Table 23.5.5	AASHTO Horizontal Alignment.....	23-15
Table 23.5.6	AASHTO Superelevation (Maximum)	23-17
Table 23.5.7	AASHTO Stopping Sight Distance (Minimum)	23-19
Table 23.5.8	AASHTO Vertical Alignment.....	23-19
Table 23.5.9	AASHTO Minimum Passing Sight Distance.....	23-20
Table 23.5.10	AASHTO Grades (Maximum).....	23-21
Table 23.5.11	AASHTO Cross Slope	23-23
Table 23.5.12	AASHTO Vertical Clearance (Minimum).....	23-25
Table 23.5.13	AASHTO Structural Capacity (Minimum Loadings)	23-27
Table 23.6.1	FDOT Average Crash Costs by Facility Type	23-29
Table 23.6.2	FDOT KABCO Crash Costs	23-29
Table 23.6.3	HSM Calibration Factors for Florida (2012-2016) ...	23-31
Table 23.6.4	HSM Crash Distribution for Florida (2012-2016).....	23-32
Table 23.7.1	Central Office Approvals	23-37
 Exhibits		
Exhibit 23-A	Submittal/Approval Letter	23-39

THIS PAGE LEFT BLANK INTENTIONALLY

Chapter 23

Design Exceptions and Design Variations

23.1 General

The Department's roadway design criteria and standards are contained in this Volume and are usually within the desirable ranges established by AASHTO. The values given in this Volume have been accepted by FHWA and govern the design process. When it becomes necessary to deviate from the Department's criteria, early documentation and approval are required. There are two approval processes used by designers: Design Exceptions and Design Variations. This chapter does not address the Utility Exception Procedure Topic No. 710-020-002 used by Utility Agencies/Owners to relieve their obligation to comply with a design requirement.

When the Department's criteria are not met, a Design Exception or Design Variation is required. This requirement applies to all entities affecting planning, design, construction and maintenance.

For projects using safety funds and developed to improve specific safety problems, only the elements identified under the scope of work for the safety improvement project are subject to these approval processes. Existing non-compliant features, within the limits of a safety improvement project do not require approval to remain, as long as the project does not create a non-compliant condition. The Safety Study must identify all applicable Variations and Exceptions required based on the proposed scope. For these projects, all applicable Design Variations and Design Exceptions must be approved prior to the beginning of the design phase.

For drainage projects, only elements identified in the scope of services for the drainage project are subject to these approval processes. The existing features, within the limits of the drainage project that do not meet design criteria, do not require approval to remain (if the project does not create a nonconforming condition).

Pavement Only Resurfacing, Ride Rehabilitation and Skid Hazard Projects do not require Design Exceptions or Design Variations other than for ADA curb ramp requirements. If compliance with ADA curb ramp requirements is determined to be technically infeasible, documentation as a Design Variation is required. Pavement Only Resurfacing Projects can only be programmed on routes that meet the requirements identified in **Chapter 28** of the [Work Program Instructions](#).

For Landscape Only projects, intersection sight distance Design Variations may be processed by the Responsible Landscape Architect of Record. For design projects with landscaping, intersection sight distance Design Variations must be processed by a Professional Engineer. In cases where intersection sight distance falls below stopping sight distance, a Design Exception for stopping sight distance must be processed by the respective professional according to the above guidelines.

23.2 Identification

To allow time to research alternatives and begin the analysis and documentation activities, it is important that proper approval processes be identified as early as possible in the Planning and Design phases. This is preferably done during the PD&E process for major projects and the scope development process for minor projects. It is required that approval be obtained no later than the initial engineering phase.

Design Exceptions are required when proposed design elements are below both the Department's governing criteria and AASHTO's new construction criteria for the Controlling Design Elements.

The 10 Controlling Design Elements for high speed (Design Speed \geq 50 mph) roadways are:

- Design Speed
- Lane Width
- Shoulder Width
- Horizontal Curve Radius
- Superelevation Rate
- Stopping Sight Distance
- Maximum Grade
- Cross Slope
- Vertical Clearance
- Design Loading Structural Capacity

The 2 Controlling Design Elements for low speed (Design Speed < 50 mph) roadways are:

- Design Speed
- Design Loading Structural Capacity

Section 23.5 provides AASHTO's minimum requirements for the above elements.

Design Variations are required when proposed design elements are below the Department's criteria and where a Design Exception is not required.

Modification for Non-Conventional Projects:

See RFP for additional requirements.

23.3 Justification for Approval

Sufficient detail and explanation must be given in order to justify approval to those reviewing the request. The 10 Controlling Design Elements are considered safety related and the strongest case possible must be made to lower these requirements. At some point, this justification may be used to defend design decisions made by the Department and the designer. All deviations from Department criteria and standards must be uniquely identified, located, and justified; no blanket approvals are given.

A strong case can be made if it can be shown that:

- The required criteria are not applicable to the site specific conditions.
- The project can be as safe by not following the criteria.
- The environmental or community needs prohibit meeting criteria.

Most often a case is made by showing the required criteria are impractical and the proposed design wisely balances all design impacts. The impacts required for documentation are:

- Safety and Operational performance
- Level of Service
- Right of Way impacts
- Community impacts
- Environmental impacts
- Costs
- Usability by all modes of transportation
- Long term and cumulative effects on adjacent sections of roadway

A case should not be made based solely on the basis that:

- The Department can save money.
- The Department can save time.
- The proposed design is similar to other designs.

23.4 Documentation for Approval

Supporting documentation that is generated during the approval process is to accompany each submittal.

Design Exceptions and Design Variations needing Central Office approval should include the following documentation:

1. Submittal/Approval Letter (**Form 23-A**)
2. Project Description: general project information, location map, existing roadway characteristics, project limits (mileposts), county section number, work mix, objectives, and obstacles. Include any associated or future limitations that exist as a result of public or legal commitments.
3. Project Schedule and Lifespan: Include the letting date and other important production dates associated with the project. Provide a discussion of whether the Design Exception is a temporary or permanent condition. Include any future work planned or programmed to address the condition.
4. Exception/Variation Description:
 - a) Specific design criteria that will not be met (AASHTO, Department value, or standard). Detailed explanation of why the criteria or standard cannot be complied with or is not applicable. Description of any proposed value for the project or location and why it is appropriate.
 - b) A plan view, plan sheet, or aerial photo of the Design Exception location, showing right of way lines, and property lines of adjacent property. A photo of the area of the deficiency.
 - c) Typical section or cross-section of the Design Exception location.
 - d) The milepost and station location of the Design Exception.
5. Alternative Designs Considered: meeting Department criteria, meeting AASHTO criteria, partial correction, and the no-build (existing) condition.
6. Impacts of the Exception/Variation to:
 - a) Safety Performance:

- Description of the anticipated impact on safety, long and short term effects. Description of any anticipated cumulative effects.
 - Summary of the most recent 5-year crash history including any pertinent crash reports.
 - For non-existing or proposed conditions, a comparison of the predicted or expected crash frequency should be included along with a discussion of the 5-year crash history.
- b) Operational Performance:
- Description of the anticipated impact on operations, long and short term effects. Description of any anticipated cumulative effects.
 - Traffic information: Amount and character of traffic using the facility.
 - Compatibility of the design with adjacent sections of roadway.
 - Effects on capacity (proposed criteria vs. AASHTO) using an acceptable capacity analysis procedure and calculate reduction for design year, level of service.
- c) Right-of-way
- d) Community
- e) Environment
- f) Usability by all modes of transportation
7. Costs: Description of the anticipated costs associated with the Design Exception or Variation.
8. Mitigation Measures: Description and explanation of any practical mitigation measures or alternatives that were considered and any selected treatments implemented on the project.
9. Summary and Conclusions

23.5 AASHTO Controlling Elements

AASHTO criteria, required documentation, and mitigation strategies for the controlling elements is provided in the following sections. Detailed discussions on criteria and mitigation are provided in the AASHTO Greenbook: ***A Policy on Geometric Design of Highways and Streets, 2011***, and the FHWA Guide: ***Mitigation Strategies for Design Exceptions, July 2007***. The AASHTO criteria provided are in no way intended to replace Department design criteria.

The criteria used for determining Design Exceptions on Interstate projects must be based on AASHTO's ***A Policy on Design Standards Interstate System 2005***.

23.5.1 Design Speed

23.5.1.1 AASHTO Criteria

Table 23.5.1 AASHTO Design Speed (Minimum)

Type Facility	Other Factors	Design Speed (mph)	AASHTO
Freeways	Urban	50	pg. 8-1, 8-2
	Rural	70	
Urban Arterials	Major	30	pg. 2-58
	Other	30	
Rural Arterials	Rolling terrain	50	pg. 7-2
	Level terrain	60	
Urban Collectors	Major or Minor	30	pg. 6-11
Rural Collectors	Level	ADT < 400	pg. 6-2, Table 6-1
		ADT 400 - 2000	
		ADT > 2000	
	Rolling	ADT < 400	
		ADT 400 - 2000	
		ADT > 2000	
Ramps	Highway Design Speeds (mph)	30	pg. 10-89, Table 10-1
		35	
		40	
		45	
		50	
		55	
		60	
		65	
		70	
		70	
Loop Ramps	Minimum	25	pg. 10-89
Connections	Direct	40	pg. 10-90
	Semi-Direct	30	

23.5.1.2 Documentation

Provide the length of section with reduced design speed compared to the overall length of the project. Include any existing or proposed measures used within the transitions to adjacent roadway sections having higher or lower design (or operating) speeds.

23.5.1.3 Mitigation

A potential mitigation strategy for design speed is:

1. Cross-sectional elements to manage speed to reduce operating speeds to the design speed.

23.5.2 Lane Width

23.5.2.1 AASHTO Criteria

Table 23.5.2 AASHTO Lane Width (Minimum)

Type Facility	Lane Width (feet)	AASHTO
Freeways (including Auxiliary)	12	pg. 8-2, 10-76, DSIS pg.3 ⁽¹⁾
Rural Arterials	11	pg. 7-5, Table 7-3
Urban Arterials	10	pg. 7-29
Urban Collectors	10	pg. 6-13
Rural Collectors	10	pg. 6-6, Table 6-5
Low Speed	10	pg. 4-7
Residential	9	pg. 4-8
Auxiliary (Non-Freeway)	10	pp. 4-8, 6-13
Continuous TWLTL	10	pg. 4-8

1. DSIS = AASHTO's *A Policy on Design Standards Interstate System* (January 2005).

23.5.2.2 Documentation

Provide locations of alternative routes that meet criteria and a proposal for handling drainage. Include a typical section or plan of the proposed signing and pavement markings associated with the lane width exception.

23.5.2.3 Mitigation

Potential mitigation strategies for lane width are:

1. Select optimal combination of lane and shoulder widths based on site characteristics to optimize safety and operations by distributing available cross-sectional width
2. Signing to provide advanced warning of lane width reduction;
3. To improve the ability to stay within the lane:
 - a) Wide, recessed, or raised pavement markings

- b) Delineators
 - c) Lighting
 - d) Centerline and edge line rumble striping, (See **Section 7.6.1.2**)
 - e) Shoulder rumble strips
4. To improve the ability to recover if the driver leaves the lane:
- a) Paved or partially-paved shoulders
 - b) Safety edge treatment
5. To reduce crash severity if the driver leaves the roadway (See **Chapter 4**):
- a) Remove or relocate fixed objects
 - b) Traversable slopes
 - c) Breakaway safety hardware
 - d) Shield fixed objects and steep slopes

23.5.3 Shoulder Width

23.5.3.1 AASHTO Criteria

Table 23.5.3 AASHTO Shoulder Widths (Minimum)

Type Facility	Other Factors	Median (feet)	Right (feet)	AASHTO
Freeways	4 lanes	4 paved	10 paved	pg. 8-3
	≥ 6 lanes	10 paved	10 paved	pg. 8-3
Rural Arterial	ADT > 2000		8	pg. 7-5, Table 7-3
	ADT 400-2000		6	
	ADT < 400		4	
	4 lane Divided	4 paved	8	pg. 7-13
	6+ lane Divided	8	8	pg. 7-14
Urban Arterial	Low Type (Gravel, Other)		2	pg. 4-10
	High Type (Asphalt, Conc.)		10	pg. 4-10
	Heavily Traveled/High Speed/High Trucks		10	pg. 4-10
Rural & Urban Collectors	ADT > 2000		8	pg. 6-6, Table 6-5
	ADT 1500-2000		6	
	ADT 400-1500		5	
	ADT < 400		2	

Table 23.5.4 AASHTO Bridge Widths (Minimum)

Type Facility	Other Factors	Bridge Widths	AASHTO
Freeways	New Bridges	Approach Roadway Width	pg. 8-4
Rural Arterials	New Bridges (Short)	Approach Roadway Width	pg. 7-6
	New Bridges (Long) (> 200 ft.)	Traveled Way + 4 ft. each side	pg. 7-6
	Existing bridges	Traveled Way + 2 ft. each side	pg. 7-6
Urban Arterials	New and Existing Bridges (Short)	Curb to curb width of street	pg. 7-38
	New and Existing Bridges (Long) without shoulders or parking on arterial	Curb to curb width of street	pg. 7-38
	New and Existing Bridges (Long) with shoulders or parking on arterial	Traveled Way + 4 ft. each side	pg. 7-38

Type Facility	Other Factors	Bridge Widths		AASHTO
		New or Reconstruction	To Remain	
Rural and Urban Collectors	ADT Under 400	Traveled Way + 2 ft. each side ⁽¹⁾	22 ft. ⁽²⁾	pg. 6-7, 8 Table 6-6, Table 6-7
	ADT 400-1500	Traveled Way + 3 ft. each side ⁽¹⁾	22 ft. ⁽²⁾	
	ADT 1500-2000	Traveled Way + 4 ft. each side ^{(1),(3)}	24 ft. ⁽²⁾	
	ADT > 2000	Approach Roadway Width ^{(1),(3)}	28 ft. ⁽²⁾	

1. If the approach roadway has paved shoulders, then the surfaced width must be carried across the bridge.
2. Bridges longer than 100 ft. are to be analyzed individually.
3. For bridges > 100 ft. in length, the minimum bridge width of traveled way plus 3 ft. on each side is acceptable.

23.5.3.2 Documentation

Provide a proposal to address stalled vehicles, enforcement activities, emergency operations, and drainage in the documentation for the exception.

23.5.3.3 Mitigation

Potential mitigation strategies for shoulder width are:

1. Select optimal combination of lane and shoulder width based on site characteristics to optimize safety and operations by distributing available cross-sectional width
2. Signing to provide advanced warning of lane width reduction
3. To improve the ability to stay within the lane:
 - a) Wide, recessed or raised pavement markings
 - b) Delineators
 - c) Lighting
 - d) Centerline and edge line rumble striping (See **Section 7.6.1.2**)
 - e) Shoulder rumble strips
4. To improve the ability to recover if the driver leaves the lane:
 - a) Paved or partially-paved shoulders
 - b) Safety edge treatment
5. To reduce crash severity if driver leaves the roadway (See **Chapter 4**):
 - a) Remove or relocate fixed objects
 - b) Traversable slopes
 - c) Breakaway safety hardware
 - d) Shield fixed objects and steep slopes

23.5.4 Horizontal Curve Radius

23.5.4.1 AASHTO Criteria

Table 23.5.5 AASHTO Horizontal Alignment

Minimum Radius (feet) with Superelevation (page 3-32, Table 3-7)

Type Facility	Super-elevation e-max	Minimum Curve Radius (feet) for Design Speed (mph)											
		15	20	25	30	35	40	45	50	55	60	65	70
Rural Highways and High Speed Urban Streets	0.04	42	86	154	250	371	533	711	926	1190	1500	---	---
	0.06	39	81	144	231	340	485	643	833	1060	1330	1660	2040
	0.08	38	76	134	214	314	444	587	758	960	1200	1480	1810
	0.10	36	72	126	200	292	410	540	694	877	1090	1340	1630
	0.12	34	68	119	188	272	381	500	641	807	1000	1220	1480

Minimum Radius (feet) for Section with Normal Cross Slope (2001 AASHTO, page 168, Exh. 3-26)

Type Facility	Minimum Curve Radius (feet) for Design Speed (mph)											
	15	20	25	30	35	40	45	50	55	60	65	70
Freeways, Arterials, and Collectors	960	1700	2460	3350	4390	5570	6880	8350	9960	11720	13180	14730

Minimum Radius (feet) for Intersection Curves (2001 AASHTO, page 201, Exh. 3-43)

Design Speed (MPH)	10	15	20	25	30	35	40	45
Minimum Radius (feet)	25	50	90	150	230	310	430	540
Assumed Minimum Superelevation Rate	0.02	0.02	0.02	0.04	0.06	0.08	0.09	0.10

23.5.4.2 Documentation

No additional documentation beyond what is covered in **Section 23.4** is required.

23.5.4.3 Mitigation

Potential mitigation strategies for horizontal curve radius are:

1. To provide advanced warning:

- a) Signing
- b) Pavement marking messages
- c) Dynamic curve warning systems
2. To provide delineation:
 - a) Chevrons
 - b) Post-mounted delineators
 - c) Reflectors on barrier
3. To improve the ability to stay within the lane:
 - a) Widen the roadway
 - b) Skid-resistant pavement
 - c) Enhanced pavement markings
 - d) Lighting;
 - e) Centerline and edge line rumble striping (See **Section 7.6.1.2**)
 - f) Shoulder rumble strips
4. To improve the ability to recover if driver leaves the lane:
 - a) Paved or partially paved shoulders
 - b) Safety edge
5. To reduce the crash severity if driver leaves the roadway(See **Chapter 4**):
 - a) Remove or relocate fixed objects
 - b) Traversable slopes
 - c) Breakaway safety hardware
 - d) Shield fixed objects and steep slopes

23.5.5 Superelevation Rate

23.5.5.1 AASHTO Criteria

Table 23.5.6 AASHTO Superelevation (Maximum)

Type Facility	Superelevation Rate	AASHTO
Highways (Rural)	12%	pg. 3-30
Urban	6%	pg. 3-31
Urban: Low Speed w/severe constraints	None	pg. 3-31
Ramps and Turning Roadways at Intersections	10%	pg. 9-114

Note: Maximum Superelevation is pro-rated value (based upon radius) from rate tables cited above.

23.5.5.2 Documentation

Provide side friction factors for each curve at the PC, Midpoint, and PT of the curve, and at the location of maximum provided superelevation. For multi-lane facilities, provide values for each lane. Use the following equation:

$$f = \frac{V^2 - 15Re}{V^2e + 15R} \quad \text{where} \quad \begin{array}{l} f = \text{Side Friction Factor} \\ V = \text{Design Speed (mph)} \\ R = \text{Radius (feet)} \\ e = \text{Superelevation (ft/ft) at the station evaluated} \end{array}$$

23.5.5.3 Mitigation

Potential mitigation strategies for superelevation rate exceptions are:

1. To provide advanced warning:
 - a) Signing
 - b) Pavement marking messages
 - c) Dynamic curve warning systems
2. To provide delineation:
 - a) Chevrons
 - b) Post-mounted delineators
 - c) Reflectors on barrier

3. To improve the ability to stay within the lane:
 - a) Widen the roadway
 - b) Skid-resistant pavement
 - c) Enhanced pavement markings
 - d) Lighting
 - e) Centerline and edge line rumble striping (See **Section 7.6.1.2**)
 - f) Shoulder rumble strips
4. To improve the ability to recover if driver leaves the lane:
 - a) Paved or partially paved shoulders
 - b) Safety edge
5. To reduce the crash severity if driver leaves the roadway: (See **Chapter 4**)
 - a) Remove or relocate fixed objects
 - b) Traversable slopes
 - c) Breakaway safety hardware
 - d) Shield fixed objects and steep slopes

23.5.6 Stopping Sight Distance

23.5.6.1 AASHTO Criteria

Table 23.5.7 AASHTO Stopping Sight Distance (Minimum)

(AASHTO page 3-4, Table 3-1)

Design Speed (mph)	Stopping Sight Distance (feet) Computed for Design
15	80
20	115
25	155
30	200
35	250
40	305
45	360
50	425
55	495
60	570
65	645
70	730

Table 23.5.8 AASHTO Vertical Alignment

(AASHTO Table 3-34, Table 3-36, and Table 6-3, and based on a 2' object height)

Design Speed (mph)	Minimum K Value ⁽¹⁾ for Vertical Curves	
	Crest	Sag
15	3	10
20	7	17
25	12	26
30	19	37
35	29	49
40	44	64
45	61	79
50	84	96
55	114	115
60	151	136
65	193	157
70	247	181

1. Rate of vertical curvature, K, is the length of curve per percent algebraic difference of the intersecting grades. ($K = L/A$)

Table 23.5.9 AASHTO Minimum Passing Sight Distance

(AASHTO page 3-9, Table 3-4)

Design Speed (mph)	20	25	30	35	40	45	50	55	60	65	70
Passing Sight Distance (feet)	400	450	500	550	600	700	800	900	1000	1100	1200

23.5.6.2 Documentation

Provide profiles in the area of vertical alignment related Design Exception or Design Variations for stopping sight distance. Provide plan views with sight triangles for horizontal stopping sight distance evaluations.

23.5.6.3 Mitigation

Potential mitigation strategies for stopping sight distance are:

1. To mitigate sight distance restrictions
 - a) Signing and speed advisory plaques (crest vertical curves)
 - b) Lighting
 - c) Adjust placement of lane within the roadway cross section (horizontal)
2. Cross-sectional elements to manage speed
3. To improve the ability to avoid crashes:
 - a) Cross-sectional elements
 - b) Wider clear recovery area
4. To improve driver awareness on approach to intersections:
 - a) Advance warning signs
 - b) Dynamic warning signs
 - c) Larger or additional STOP/YIELD signs
 - d) Intersection lighting

23.5.7 Maximum Grade

23.5.7.1 AASHTO Criteria

Table 23.5.10 AASHTO Grades (Maximum)

Type Facility	Type Terrain	Grades (%) For Design Speed (mph)									AASHTO
		30	35	40	45	50	55	60	65	70	
Freeway ⁽¹⁾	Level	---	---	---	---	4	4	3	3	3	pg. 8-4, Table 8-1
	Rolling	---	---	---	---	5	5	4	4	4	
Rural Arterial	Level	---	---	5	5	4	4	3	3	3	pg. 7-4, Table 7-2
	Rolling	---	---	6	6	5	5	4	4	4	
Urban Arterial:	Level	8	7	7	6	6	5	5	---	---	pg. 7-29, Table 7-4
	Rolling	9	8	8	7	7	6	6	---	---	
Rural Collector ⁽²⁾	Level	7	7	7	7	6	6	5	---	---	pg. 6-3, Table 6-2
	Rolling	9	9	8	8	7	7	6	---	---	
Urban Collector ⁽²⁾	Level	9	9	9	8	7	7	6	---	---	pg. 6-12, Table 6-8
	Rolling	11	10	10	9	8	8	7	---	---	

1. Grades one percent steeper than the values shown may be used for extreme cases in urban areas where development precludes the use of flatter grades and for one-way downgrades.
2. Short lengths of grade in rural and urban areas, such as grades less than 500 ft. in length, one-way downgrades, and grades on low-volume rural and urban collectors may be up to 2 percent steeper than the grades shown above.

23.5.7.2 Documentation

No additional documentation beyond what is in **Section 23.4** is required.

23.5.7.3 Mitigation

Potential mitigation strategies for maximum grade are:

1. Signing to provide advanced warning
2. To improve ability to stay within the lane:
 - a) Enhanced pavement markings
 - b) Delineators

- c) Centerline and edge line rumble striping (See **Section 7.6.1.2**)
- d) Shoulder rumble strips
- 3. To improve ability to recover if driver leaves the roadway (See **Chapter 4**):
 - a) Paved or partially-paved shoulders
 - b) Safety edge
 - c) Remove or relocate fixed objects
 - d) Traversable slopes
 - e) Breakaway safety hardware
 - f) Shield fixed objects

23.5.8 Cross Slope

23.5.8.1 AASHTO Criteria

Table 23.5.11 AASHTO Cross Slope

Type Facility	Other Factors	Minimum	Maximum	AASHTO
Freeways	---	0.015	0.025 ⁽¹⁾	pg. 8-2
Arterials	Rural	0.015	0.02	pg. 7-4
	Urban	0.015	0.03	pg. 7-29
Divided Highways	---	0.015	0.02 ⁽¹⁾	pg. 7-13
Collectors	Rural	0.015	0.02	pg. 6-3
	Urban	0.015	0.03	pg. 6-13
Shoulders	Paved	0.02	0.06	pg. 4-11
	Gravel	0.04	0.06	pg. 4-11
	Turf	0.06	0.08	pg. 4-11

1. Values given are for up to two lanes in one direction. Additional outside lanes may have cross slopes of 0.03.

23.5.8.2 Documentation

Provide a proposal for handling drainage and details on how the cross slope impacts intersections.

23.5.8.3 Mitigation

Potential mitigation strategies for deficient cross slope are:

1. Signing to provide warning of slick pavement
2. To improve surface friction:
 - a) Pavement grooving (PCC Pavement)
 - b) Open-graded friction courses (HMA pavement)
3. To improve drainage:
 - a) Transverse pavement grooving (PCC Pavement)

- b) Open-graded friction courses (HMA pavement)
 - c) Pavement edge drains
4. Modified shoulder cross slope to mitigate cross-slope break on the high side of superelevated curves.

23.5.9 Vertical Clearance

23.5.9.1 AASHTO Criteria

Table 23.5.12 AASHTO Vertical Clearance (Minimum)

Type Facility	Vertical Clearance (feet) ⁽²⁾	AASHTO
Freeways	16 ^{(1),(4)}	pg. 8-4, 10-21
Arterials (New Structures): Rural	16 ⁽¹⁾	pg. 7-6, 10-21
Urban	16 ⁽¹⁾	pg. 7-38, 10-21
Arterials (Existing Structures): Rural	14	pg. 7-7, 10-21
Urban	14	pg. 7-38, 10-21
Other Highways	14	pg. 5-8, 8-4
Sign Trusses	17	pg. 7-7,38, 8-4
Pedestrian Overpass	17	pg. 7-7,38, 8-4
Tunnels: Freeways	16	pg. 4-53
Other Highways	14	pg. 4-53
Railroads	23 ⁽³⁾	pg. 10-22

1. 14 feet allowed in highly developed urban areas if alternate route has 16 feet.
2. An allowance of 6 inches should be added to vertical clearance to accommodate future resurfacing.
3. See **Section 6.3.5** of this Volume and the latest version of **American Railway Engineering and Maintenance-of-Way Association (AREMA)** guidelines, or the design office of the high speed rail line of interest for specific high speed guidelines and specifications. Over Electrified Railroad, the minimum vertical clearance is 24 feet 3 inches. (See **Topic No. 000-725-003: South Florida Rail Corridor Clearance.**)
4. Design Exceptions to the 16-ft vertical clearance standard on rural Interstate routes or on a single Interstate route through urban areas must be coordinated with Surface Deployment and Distribution Command Transportation Engineering Agency (SDDCTEA) as described in **Section 23.5.9.2**.

23.5.9.2 Documentation

Provide locations of alternative routes that meet criteria.

For Interstate Projects, the District is responsible for completing an **Interstate Vertical Clearance Exception Coordination** form, (<http://www.fhwa.dot.gov/design/090415.cfm>)

for Design Exceptions to vertical clearance requirements above interstate facilities (mainlines and ramps). The District will submit the form to the Surface Deployment and Distribution Command Transportation Engineering Agency (SDDCTEA) via e-mail for approval, copying the FHWA Florida Division. Allow for 10 working days after SDDCTEA receipt for action before requesting notification of disposition (via email or fax). A copy of the approval must be provided with the Design Exception. A request for coordination must take place before the District Design Engineer can recommend the Design Exception.

A written evaluation and recommendation by the State Office of Maintenance is required and should be attached to all Vertical Clearance Variations and Exceptions.

23.5.9.3 Mitigation

Potential mitigation strategies for vertical clearance are:

1. Signing to provide advance warning;
2. To prevent impacts with low structures:
 - a) Alternate routes
 - b) Large vehicle restrictions.
3. Bridge Jacking may be a consideration to address bridges with minor deficiencies.

23.5.10 Design Loading Structural Capacity

23.5.10.1 AASHTO Criteria

Table 23.5.13 AASHTO Structural Capacity (Minimum Loadings)

Type Facility	AASHTO
Freeways, Arterials, and Collectors	See <i>AASHTO LRFD</i> for minimum loadings.

23.5.10.2 Documentation

Load rating calculations for the affected structure.

Verification of safe load-carrying capacity (load rating) for State unrestricted legal loads or routine permit loads.

Verification of Federal legal loads for bridges and tunnels on the Interstate.

A written evaluation and recommendation by the Office of Maintenance.

23.5.10.3 Mitigation

Potential mitigation strategies for design loading structural capacity are determined on a case by case basis.

23.6 Crash Analysis

For areas with crash histories or when a benefit to cost analysis is required, provide a time value analysis between the benefit to society (quantified in dollars) and the costs to society (quantified in dollars) over the life of the Design Exception. The benefit to society is quantified by the savings associated with the projected reduction in crashes. The cost to society is a summary of the construction, operation, maintenance, and other costs anticipated over the life of the project. The Discount (interest) rate to be utilized in benefit/cost analysis is 4%.

Both Historical (HCM) and Predictive (RSAP and HSM) methods are acceptable for performance of a benefit/cost analysis.

In accordance with the Department's *Highway Safety Manual Implementation Policy (Topic No. 000-500-001)*, "the transportation analyst is encouraged to use the Highway Safety Manual (HSM) methods, where applicable, to measure safety benefits from proposed improvements."

23.6.1 Historical Crash Method (HCM)

This method can be used for sites with a crash history. It is the ratio (benefit/cost) of the estimated annual reduction in crash costs to the estimated annual increase in combined construction and maintenance costs. The annualized conversion will show whether the projected expenditure of funds for the crash benefit will exceed the direct cost for the improvement.

The HCM uses the *Highway Safety Improvement Program Guideline (HSIPG)* cost per crash by facility type in **Table 23.6.1** to estimate benefit to society, while the cost to society is estimated by the expected cost of right of way, construction, and maintenance.

Table 23.6.1 FDOT Average Crash Costs by Facility Type

FACILITY TYPE	DIVIDED			UNDIVIDED		
	URBAN	SUBURBAN	RURAL	URBAN	SUBURBAN	RURAL
2-3 Lanes	\$109,686	\$187,990	\$342,662	\$125,974	\$245,281	\$526,887
4-5 Lanes	\$119,072	\$216,234	\$464,901	\$107,908	\$161,173	\$115,320
6+ Lanes	\$117,867	\$153,957	\$313,317	\$62,606	n/a	n/a
Interstate	\$153,963	n/a	\$341,754	n/a	n/a	n/a
Turnpike	\$147,939	n/a	\$254,951	n/a	n/a	n/a

Average Cost/Crash: **\$155,695**

The above values were derived from 2010 through 2014 traffic crash and injury severity data for crashes on state roads in Florida using the formulation described in **FHWA Technical Advisory "Motor Vehicle Accident Costs", T 7570.2, dated October 31, 1994** and from a memorandum from USDOT, **Revised Departmental Guidance: Treatment of the Value of Preventing Fatalities and Injuries in Preparing Economic Analyses, dated February 5, 2008** updating the value of life saved to \$5.8 million, updated from \$5.8 million to \$6 million on March 18, 2009, to \$6.2 million on July 29, 2011, and to \$9.1 million on February 28, 2013.

<http://www.dot.gov/sites/dot.dev/files/docs/VSL%20Guidance%202013.pdf>

When utilizing predictive methods or crash severity distributions for analysis, the following crash severity level costs should be used:

Table 23.6.2 FDOT KABCO Crash Costs

Crash Severity	Comprehensive Crash Cost
Fatal (K)	\$10,230,000
Severe Injury (A)	\$580,320
Moderate Injury (B)	\$157,170
Minor Injury (C)	\$97,650
Property Damage Only (O)	\$7,600

Source: Florida Department of Transportation Crash Analysis Reporting (C.A.R.) System, analysis years 2010 through 2014.

23.6.2 Roadside Safety Analysis Program (RSAP)

This method complements the AASHTO Roadside Design Guide, dated June 2011. When hazards cannot be removed or relocated, designers need to determine if a safety device, such as a guardrail or a crash cushion, is warranted to protect motorists from the roadside obstacle. This method can be used to perform a benefit/cost analysis comparing a potential safety treatment with the existing or baseline conditions (i.e., the do-nothing option) or alternative safety treatments. Based on the input of information available to the user (e.g. offsets, traffic, slopes, crash history, traffic accident severity levels), the program will offer results which can be used in comparing design alternatives.

23.6.3 Highway Safety Manual

The AASHTO Highway Safety Manual (HSM) provides analytical tools and techniques for quantifying the potential effects on crashes as a result of decisions made in planning, design, operations and maintenance. The new techniques and knowledge in the HSM reflect the evolution in safety analysis from descriptive (historical) methods to quantitative, predictive analyses. In the HSM, crash frequency is the fundamental basis for safety analysis and is used to reduce crashes and severities through the selection of alternative treatments.

The HSM includes Safety Performance Functions (SPFs) for many roadway segment and intersection applications. SPFs are equations used to estimate or predict the expected average crash frequency per year at a location as a function of traffic volume and roadway characteristics. Adjust SPFs to local conditions by applying calibration factors shown in **Table 23.6.3**. The use of Highway Safety Manual (HSM) Safety Performance Functions (SPF) and Crash Modification Factors (CMF), with an Empirical Bayes (EB) adjustment, provides research based solutions for use in Benefit/Cost comparisons. Crash distributions presented in **Table 23.6.4** and KABCO costs as specified in **Table 23.6.2** should be used in determining benefits from an HSM analysis.

Table 23.6.3 HSM Calibration Factors for Florida (2012-2016)

FDOT Segment Calibration Factors		
Segment Type	Abbreviation	Calibration Factor (C_x)
Rural 2-lane, 2-way Undivided	R2U	1.00
Rural 4-lane Divided	R4D	0.68
Urban 2-lane Undivided	U2U	1.02
Urban 3-lane with a Center Two-Way Left Turn Lane	U32LT	1.04
Urban 4-lane Undivided	U4U	0.73
Urban 4-lane Divided	U4D	1.63
Urban 3-lane with a Center Two-Way Left Turn Lane	U52LT	0.70
FDOT Intersection Calibration Factors		
Rural 2-lane 3-Leg Stop-Controlled Intersection	RTL3ST	1.27
Rural 2-lane 4-Leg Stop-Controlled Intersection	RTL4ST	0.74
Rural 2-lane 4-Leg Signalized Intersection	RTL4SG	0.92
Rural Multilane 3-Leg Stop-Controlled Intersection	RML3ST	2.20
Rural Multilane 4-Leg Stop-Controlled Intersection	RML4ST	1.64
Rural Multilane 4-Leg Signalized Intersection	RML4SG	0.45
Urban 3-Leg Stop-Controlled Intersection	USA3ST	1.14
Urban 4-Leg Stop-Controlled Intersection	USA4ST	1.87
Urban 3-Leg Signalized Intersection w/o Ped. CMFs	USA3SG w/o Ped.	2.58
Urban 3-Leg Signalized Intersection w/ Ped. CMFs	USA3SG w/ Ped.	2.50
Urban 4-Leg Signalized Intersection	USA4SG	2.27

Table 23.6.4 HSM Crash Distribution for Florida (2012-2016)

Facility Type		Rural Roadways			Urban & Suburban Arterials					Freeways			All Roadways & Ramps
		2-lane Undivided (R2U)	4-lane Undivided (R4U)	4-lane Divided (R4D)	2-lane Undivided (U2U)	3-lane TWLTL (U32LT)	4-lane Undivided (U4U)	4-lane Divided (U4D)	5-lane TWLTL (U52LT)	Rural	Urban	Ramps	
Fatal	K	0.032	0.029	0.030	0.009	N/A	0.005	0.008	N/A	0.019	0.006	0.004	0.008
Incapacitating Injury	A	0.116	0.111	0.112	0.062	N/A	0.037	0.055	N/A	0.081	0.043	0.039	0.049
Non-incapacitating Injury	B	0.196	0.182	0.206	0.166	N/A	0.126	0.158	N/A	0.165	0.131	0.124	0.141
Possible (or minor) Injury	C	0.196	0.219	0.197	0.223	N/A	0.209	0.239	N/A	0.177	0.216	0.223	0.224
Property Damage Only	O	0.461	0.460	0.453	0.540	N/A	0.623	0.540	N/A	0.558	0.604	0.610	0.577

Tools and spreadsheets for use with these analytical methods have been developed and are available on the following websites:

<http://www.dot.state.fl.us/safety/11A-SafetyEngineering/TransSafEng/HighwaySafetyManual.shtm>

<http://www.dot.state.fl.us/rddesign/QA/Tools.shtm>

23.7 Design Approval Request

23.7.1 Submittal Package

The submittal package is to include the following:

1. Cover letter: The cover letter is the ***Plans Preparation Manual Volume 1, Exhibit 23-A, Submittal / Approval Letter*** for Design Exceptions and Variations.
2. Signed and Sealed Report: The signed and sealed documents including all required documentation and justification. Multiple design elements and signed and sealed reports may be included in one submittal package.
3. Appendices (as needed): Include any support documentation to facilitate an understanding of the report. Supplemental documents do not alter the sealed analysis or design.

Sign and seal the report in accordance with ***Chapter 19*** of this Volume. A Submittal/Approval Letter (***Exhibit 23-A***) is to be attached to the Sealed Report and submitted to the District or Turnpike Design Engineer. The District or Turnpike Design Engineer then approves or denies the request and notifies the Responsible Engineer. When further approvals are required, the District or Turnpike Design Engineer will forward the Submittal/Approval Letter and Sealed Report to the State Roadway Design Office.

23.7.2 Design Exception Approval

The request will be reviewed by the State Roadway Design Engineer and may be forwarded for approval to the Chief Engineer, the State Structures Design Engineer, the Planning Office, and FHWA, as appropriate.

Each request will be reviewed on a case by case basis and approved on its merits. When approval is obtained, the State Roadway Design Office will email the disposition to the District or Turnpike Design Engineer along with the signed Submittal/Approval Letter. The State Roadway Design Office will keep an electronic copy filed under the assigned reference number.

When a request is denied, the State Roadway Design Office will notify the District or Turnpike Design Engineer of the disposition. Denied requests can be resubmitted when all deficiencies, noted in the denial notification, have been addressed. This may require

only a new Submittal/Approval Letter if the Sealed Report does not need to be amended. However, if the Sealed Report requires revision, a new Sealed Report and attached Submittal/Approval Letter must be submitted.

23.7.3 Design Variation Approval

Design Variations only require District approval unless identified as requiring Central Office approval in **Section 23.7.4** (see **Table 23.7.1**). Design Variations requiring Central Office approval from the Chief Engineer, State Roadway Design Engineer, and the State Structures Design Engineer (see **Section 23.7.4**) follow the processes in **Sections 23.7**. Design Variations approved solely in the District may be submitted as a formal Design Variation or as a signed and sealed Design Memorandum for approval by the District or Turnpike Enterprise Design Engineer.

A formal Design Variation is required for any design criteria impacting clear zones, sight distance, or Americans with Disabilities Act (ADA) compliance. In these cases the Responsible Engineer or Professional attaches a Submittal Approval Letter (**Form 23-A**) to the sealed report and submits the package to the District or Turnpike Design Engineer. The District or Turnpike Design Engineer then approves or denies the request and notifies the Responsible Engineer or Professional accordingly.

At a minimum, Design Variations are to include:

1. Design criteria versus proposed criteria.
2. Reason the design criteria are not appropriate.
3. Justification for the proposed criteria.
4. Review and evaluation of the most recent certified 5 years of crash history for Central Office approved Design Variations and formal District Design Variations.
5. Background information which documents or justifies the request.

For Lateral Offset Design Variations, provide a tabulation of stations (or mileposts) and lateral offsets for aboveground fixed objects.

23.7.4 Signature Requirements

Obtain all required approvals as described in this section. Approvals from multiple individuals may be required for certain issues. The Director of Design must resolve any approval authority issues if conflicting objectives arise. Approval signatures are required by the following Department and FHWA personnel as specified:

Chief Engineer:

- Design Exceptions for Design Speed on SIS facilities, following review by the State Transportation Planner.
- Design Variations for Design Speed on SIS facilities, following review by the State Transportation Planner.

FHWA Division Administrator:

- Design Exceptions on Projects of Division Interest (PODIs) with FHWA oversight.

District (or Turnpike) Design Engineer:

- Design Exceptions
- Design Variations

State Roadway Design Engineer:

- Design Exceptions for elements other than Design Loading Structural Capacity.
- Design Variations involving the use of fencing around stormwater management facilities.
- Authority for approval of Design Exceptions and Design Variations on Florida Turnpike facilities has been delegated to the Turnpike Design Engineer by the State Roadway Design Engineer.

State Structures Design Engineer:

- Design Exceptions for Shoulder Width, Design Loading Structural Capacity of bridges and Vertical Clearance impacting Category 1 and 2 bridge structures.
- Design Variations for Shoulder Width, Design Loading Structural Capacity of bridges and Vertical Clearance impacting Category 2 structures.
- Design Variations for Design Loading Structural Capacity due to deficient load

ratings impacting both Category 1 and 2 bridge structures.

- Design Variations for Traffic Railing impacting Category 1 and 2 bridge structures.
- Design Exceptions or Variations involving lateral offsets or vertical clearances for railroads not meeting the requirements of **Rule 14-57 F.A.C.** or the clearance criteria for the South Florida Rail Corridor (**Topic No. 000-725-003 - South Florida Rail Corridor Clearance Policy for 25 KV service**).
- Authority for approval of Design Exceptions and Design Variations for Shoulder Width and Vertical Clearance on Florida Turnpike facilities has been delegated to the Turnpike Design Engineer by the State Structures Design Engineer.

District (or Turnpike) Structures Design Engineer:

- Design Exceptions for Shoulder Width, Design Loading Structural Capacity of all structural items and Vertical Clearance impacting Category 1 and 2 bridge structures.
- Design Variations for Shoulder Width, Design Loading Structural Capacity of all structural items and Vertical Clearance impacting Category 1 bridge structures.

Table 23.7.1 Central Office Approvals

Design Element	State Roadway Design Engineer	State Structures Design Engineer	State Transportation Planner	Chief Engineer
	Approval	Approval	Review	Approval
Design Speed Exception	X			
Design Speed Exception- SIS	X		X	X
Design Speed Variation-SIS			X	X
Lane Width Exception	X			
Shoulder Width Exception	X	X		
Shoulder Width Variation (Category 2 Structures)		X		
Design Loading Structural Capacity Exception		X		
Design Loading Structural Capacity Variation				
-Category 2 Structures		X		
-Deficient Load Ratings (Category 1 and 2 Structures)		X		
-Traffic Railing (Category 1 and 2 Structures)		X		
Vertical Clearance Exception	X			
-16' for rural Interstate routes or single urban Interstate route	X			
-All Category 1 and 2 Structures	X	X		
- RR-South Fla Rail Corridor		X		
Vertical Clearance Variation (Category 2 Structures)		X		
Maximum Grade Exception	X			
Cross Slope Exception	X			
Superelevation Rate Exception	X			

*FHWA Approval is required on all Design Exceptions for FHWA Projects of Division Interest (PODIs).

Design Element	State Roadway Design Engineer	State Structures Design Engineer	State Transportation Planner	Chief Engineer
	Approval	Approval	Review	Approval
Horizontal Curve Radius Exception	X			
Stopping Sight Distance Exception	X			
Lateral Offset Variation				
-RR-South Fla Rail Corridor		X		
-Category 1 and 2 Structures	X	X		
Lateral Offset Variation (Category 2 Structure)		X		
Design Variation: Crossovers on Limited Access Facilities	X			
Design Variation: Patterned Pavement Technical Special Provisions	X			
Design Variation: Use of fencing around stormwater management facilities	X			
Roundabout Designs-All	X			
Colored Bike Lane Assessments (The first 3 years after installation)	X			
Design Variation: Community Aesthetic Features Non-Interstate	X			
Design Variation: Community Aesthetic Features Interstate (FHWA)	X			
Lump Sum Contracts (Non-Typical)	X			

*FHWA Approval is required on Design Exceptions for FHWA Projects of Division Interest (PODIs).

Exhibit 23-A Submittal/Approval Letter

To: _____
District or Turnpike Design Engineer

Date: _____

Financial Project ID: _____ New Const. () RRR ()

Federal Aid Number: _____

Project Name: _____

State Road Number: _____ Co./Sec./Sub. _____

Begin Project MP: _____ End Project MP: _____

Full Federal Oversight: Yes () No ()

Request for: Design Exception (), Design Variation ()

Community Aesthetic Feature: Conceptual (), Final ()

Re-submittal: Yes () No () Original Ref# _____ - ____ - _____

Requested for the following element(s):

- () Design Speed () Lane Width () Shoulder Width () Cross Slope
() Design Loading Structural Capacity () Vertical Clearance () Maximum Grade () Stopping Sight Distance
() Superelevation () Horizontal Curve Radius () Other _____

1. Include a brief statement here describing the project and the Design Exception, Design Variation or Community Aesthetic Feature requested.
2. Attach the Signed and Sealed Report including applicable documentation as per Section 23.4.

Recommended by:

_____ Date _____

Responsible Professional Engineer or Landscape Architect (Landscape-Only Projects)

Approvals:

_____ Date _____
District or Turnpike Design Engineer

_____ Date _____
District Structures Design Engineer

_____ Date _____
State Roadway Design Engineer

_____ Date _____
State Structures Design Engineer

_____ Date _____
Chief Engineer

_____ Date _____
FHWA Division Administrator

THIS PAGE LEFT BLANK INTENTIONALLY

Chapter 24

Federal Aid Project Certification

24.1	General	24-1
24.2	Selection of FHWA Oversight Projects	24-2
24.3	FDOT Responsibilities.....	24-4
24.4	Certification Documentation and Reviews	24-7
24.5	Certification Statement	24-8
Exhibits		
Exhibit 24-A	Approval and Concurrence Process	24-9
Exhibit 24-B	Design Plans Phase Review	24-11
Exhibit 24-C	Special Provisions	24-13

THIS PAGE LEFT BLANK INTENTIONALLY

Chapter 24

Federal Aid Project Certification

24.1 General

The Florida Department of Transportation has a formal agreement with the Federal Highway Administration setting forth the respective roles, responsibilities, and accountability of FDOT and FHWA in the administration and oversight of Federal Aid highway funds. See **Florida Federal-Aid Partnership Agreement, Topic No. 700-000-005** and **Title 23 United States Code (U.S.C.) 106**. Under this agreement FHWA grants to FDOT general oversight responsibilities and approvals for design, plans, specifications, estimates, contract awards, contract administration and project inspections on Federal Aid highway projects except for selected projects as discussed in **Section 24.2** where FHWA retains full oversight. For those projects that FDOT has oversight responsibility, FDOT will follow all applicable FHWA policies, regulations, **Title 23 U.S.C.**, and **non-Title 23 U.S.C.** requirements as if FHWA were involved. Notwithstanding this, FHWA may become involved with any Federal-aid project and retains overall responsibility for all aspects of Federal-aid programs. As such, FHWA has full access to and the legal authority to review any aspect or record of any Federal-aid project at any time. In accordance with **49 CFR Part 18**, records will be retained for a minimum of three years or until litigation, claims or audit findings initiated before the three-year period have been resolved.

Modification for Non-Conventional Projects:

Delete the second sentence of the above paragraph and replace with the following:

See **Florida Federal-Aid Partnership Agreement, Topic No. 700-000-005, Title 23 United States Code (U.S.C.) 106** and **Title 23 Code of Federal Regulations 636**.

24.2 Selection of FHWA Oversight Projects

In accordance with the Partnership Agreement, annually in July, FHWA and FDOT will negotiate which new projects will be selected for “full oversight” by FHWA. FHWA Transportation Engineer will coordinate the project selection with their assigned FDOT District Office. Ideally, the projects will be selected from projects listed in the Statewide Transportation Improvement Program (STIP) to be approved by FHWA the following October 1st, and will include projects selected from all four years of the STIP. The projects selected should be on the Federal-aid system to primarily include the Interstate and National Highway System (NHS) routes, but non-NHS projects can be selected. The projects should be selected considering the factors below:

1. All major projects as defined by FHWA’s major project criteria (cost ≥ \$500 million)
2. Controversial and Congressional interest Projects
3. Demonstration (demo) and pilot projects
4. Interstate projects:
 - a. With Design Exceptions to the 13 controlling criteria
 - b. For new or modified access points
 - c. For major reconstruction and widening
5. Projects utilizing innovative contracting methods, such as design build
6. Special Experimental Projects (SEP):
 - a. Projects requiring SEP-14 approval for alternative contracting methods
 - b. Projects requiring SEP-15 approval for public-private partnerships
7. Projects with an EIS
8. Unusually complex or controversial projects
9. Major unique and/or unusual structures
10. A priority focus for projects on the NHS
11. A desire to have a mix in project size and scope

All federally funded projects must comply with applicable ***non-Title 23 U.S.C.*** requirements which include, but are not limited to:

1. ***National Environmental Policy Act (NEPA) of 1969*** pursuant to ***40 C.F.R. Parts 1500 - 1508, 23 C.F.R. Section 771*** and ***Section 6002 of SAFETEA-LU***
2. ***Section 4 (f) of the DOT Act of 1966***

3. **Clean Air Act Amendments of 1990**
4. **Civil Rights Act of 1964**
5. Civil Rights approvals
6. Disadvantaged Business Enterprise Program (DBE)
7. **Uniform Relocation Assistance and Real Properties Acquisition Policies Act of 1970**
8. Hardship acquisition and protecting buying
9. **Americans with Disabilities Act/Section 504 Rehabilitation Act of 1973**
10. Davis-Bacon wage rates
11. Waiver for Buy America requirements
12. SEP-14/SEP15 contracting methods
13. Executive Orders
14. FHWA Guidance and technical advisories
15. Addition/modification of access points to the Interstate (Interchange, locked gate access points, median crossovers for construction)
16. Project by project obligation of federal funds
17. Modifications to Federal-aid project agreements
18. Final Vouchers

24.3 FDOT Responsibilities

The final design documents, reports and plans for projects not selected for FHWA oversight will be developed in accordance with all applicable Department manuals, guidelines and procedures, and in compliance with all applicable Federal Statutes, Regulations, Executive Orders, and FHWA Directives and Standards. The Department is responsible for assuring that all appropriate criteria has been adhered to, and for documenting its findings in lieu of FHWA reviews. Several of the major areas and the method to be used by the Department to document the acceptability of various final design activities in place of an FHWA review and approval are:

1. Typical Section Package

The typical section package should be prepared as described in **Chapter 16, Sections 16.2.3** and **16.3.2** of this volume. Concurrence by the District Design Engineer documents the acceptability of the package. Concurrence from the District Structures Design Engineer may also be required on unusual bridge typical sections.

2. Pavement Design Package

The pavement design is developed and approved by the responsible professional engineer in accordance with Department pavement design procedures. Concurrence from the District Design Engineer is required to document the acceptability of the package in lieu of FHWA review and concurrence.

3. Bridge Hydraulics Report

The hydraulics report is developed and approved by the responsible professional engineer in accordance with appropriate design standards. Concurrence from the District Drainage Engineer is required to document the acceptability of the package in lieu of FHWA review and concurrence.

4. Bridge Development Report

The bridge development report is developed and approved by the responsible professional engineer in accordance with appropriate design standards. Concurrence from the District Design, Structures Design, or Project Management Engineer is required to document the acceptability of the report in lieu of FHWA review and concurrence.

Modification for Non-Conventional Projects:

Delete item 4.

5. Design Plans Phase Reviews

Plan reviews should be conducted as described in **Chapter 16** of this volume. Concurrence in the resolution of phase review comments from the District Design, Structures Design, or Project Management Engineer is required to document the acceptability of the reviews in lieu of FHWA review and concurrence. (See **Exhibit 24-B**.)

Modification for Non-Conventional Projects:

Delete the above paragraph and replace with the following:

Plan reviews will be conducted as described in **PPM** Volume 2, **Chapter 2**.

6. Design Exceptions

Design Exceptions on projects not under full FHWA oversight require approval and concurrence as described in **Chapter 23** of this volume.

7. Special Provisions

Special provisions, which include project specific and technical special provisions, will be developed and approved by the responsible professional engineer. Concurrence from the District Specifications Engineer is required to document the acceptability of the special provisions in lieu of FHWA review and concurrence. (See **Exhibit 24-C**.)

8. Plans, Specifications and Estimate

The Plans, Specifications, and Estimates (PS&E) Package and contract file will be transmitted to Tallahassee as described in **Chapter 20** of this volume. The District Director of Transportation Development (Production) will certify that the design and PS&E Package has been prepared according to the appropriate certification procedures. The date of this certification will be noted on the Transmittal of PS&E Package. The Transmittal will also identify the individuals that reviewed the Plans Package, Specification Package, and Authorization Estimate, and the dates of their respective reviews. The Department's official estimate will be approved by the District Estimates Engineer.

Modification for Non-Conventional Projects:

Delete Item 8.

9. Authorization to Advertise

The PS&E Package must be approved by the Specifications and Estimates Office prior to requesting FHWA authorization for construction to advertise. The Contract

File Package (consisting of the documents listed on the Contract File Index completed by the district), FHWA Summary Sheet, Cost Estimate, Right of Way Certification, Utility Certification, Environmental Certification and Railroad Certification Agreement (if applicable), along with confirmation of the PS&E approval will be reviewed by the appropriate district and central offices and by the Federal Aid Management Office prior to submittal of the federal authorization request.

Modification for Non-Conventional Projects:

Delete Item 9 and replace with the following:

9. Use of Federal Funds on Design Build Projects

Design build projects must be authorized **before** the release of the ***Final Request for Proposal*** and ***Design Criteria Package*** to the Design-Build Firms. For Delegated or Exempt projects, the District Design-Build firm approves the package. The Design-Build authorization request should be processed immediately upon notice of receipt of package approval. Upon receipt of the approved FHWA authorization, District Federal Aid Coordinators should notify the District Design-Build firm so that the RFPs and Design Criteria packages can be distributed. See **Chapter 7.1** of the [Design Build Procurement and Administration](#) procedure.

10. Revisions

Revisions to the PS&E will be processed as described in **Chapter 20** of this volume. Concurrence from the District Design, Structures Design, or Project Management Engineer is required to document the acceptability of the revision in lieu of FHWA review and concurrence.

Modification for Non-Conventional Projects:

Delete Item 10.

In special cases where programs or projects are developed in the Central Office, an appropriate Central Office Manager will provide any necessary concurrences in lieu of a District Manager. **Exhibit 24-A** outlines the approval and concurrence process.

Modification for Non-Conventional Projects:

Delete the above paragraph.

24.4 Certification Documentation and Reviews

FHWA will perform periodic reviews of projects developed under the Partnership Agreement and may have access to review project phases and records at any time. To support the exemption program, adequate documentation throughout the design phase is critical. All approvals and concurrences outlined in the previous section must be sufficiently documented. A complete, well-organized design project file should be able to support a compliance review. All correspondence and documents must include the Federal Aid project number. The Quality Assurance procedures described in **Chapter 18** of this volume will be used by the Central Office to monitor district compliance with the certification requirements.

Modification for Non-Conventional Projects:

Delete the last sentence in the above paragraph.

24.5 Certification Statement

A Federal Aid project certification statement by the District Director of Transportation Development (Production) for each project is no longer required. However, Districts are responsible for insuring that all Federal Aid requirements are met as described in this chapter.

Exhibit 24-A Approval and Concurrence Process

<p align="center">TYPICAL SECTION PACKAGE</p> <p>Approved: 6 Concurrence: 3 or 4 (PPM Vol. 1, Section 16.2.3)</p>	<p align="center">PAVEMENT DESIGN PACKAGE</p> <p>Approved: 6 Concurrence: 3 (Pavement Design Manual)</p>		
<p align="center">BRIDGE DEVELOPMENT REPORT</p> <p>Approved: 6 Concurrence: 3 4 5 or 7 (PPM Vol. 1, Chap. 26)</p>	<p align="center">APPROVAL OF PHASE REVIEW PLANS (Roadway and Structures)</p> <p>Approved: 6 Concurrence: 3 4 5 7 or District Roadway Design Engineer (PPM Vol. 1, Chap. 16)</p>		
<p align="center">ACCIDENT/SAFETY REVIEW</p> <p>Approved: District Safety Engineer</p>	<p align="center">SPECIAL PROVISIONS</p> <p>Approved: 6 Concurrence: 9</p>		
<p align="center">DESIGN CRITERIA</p> <p>DESIGN EXCEPTIONS Requested: 3 or 6 Concurrence: 8, and 7 when needed. Approved: FHWA or 11 (PPM Vol. 1, Chap. 23)</p>	<p align="center">BRIDGE HYDRAULICS REPORT</p> <p>Approved: 6 Concurrence: District Drainage Engineer (Drainage Manual, Chap. 4)</p>		
<p align="center">PLANS, SPECIFICATIONS AND ESTIMATE</p> <p>PLANS PACKAGE Approved: 2</p> <p>SPECIFICATIONS PACKAGE Approved: 9</p> <p>FHWA AUTHORIZATION ESTIMATE Approved: 10 (PPM Vol. 1, Section 20.3)</p>	<p align="center">REVISIONS TO PS&E</p> <p>Approved: 6 Concurrence: 3 4 or 5 (PPM Vol. 1, Section 20.4)</p>		
	<p align="center">ASSEMBLY OF PS&E & CERTIFICATION OF OTHER REPORTS AS REQUIRED</p> <p>Responsibility: FA Manager</p>		
<table border="0"> <tr> <td style="vertical-align: top;"> <ol style="list-style-type: none"> 1 District Secretary 2 District Director of Transportation Development (Production) 3 District Design Engineer 4 District Structures Design Engineer 5 District Project Management Engineer 6 Responsible Professional Engineer 7 State Structures Design Engineer 8 State Roadway Design Engineer 9 District Specifications Engineer 10 District Estimates Engineer 11 State Director of Design (for exempt projects) </td> <td style="vertical-align: top; padding-left: 20px;"> <p>NOTE: In special cases where programs or projects are developed in the Central Office, an appropriate Central Office Manager will provide concurrence in lieu of the District Manager.</p> </td> </tr> </table>		<ol style="list-style-type: none"> 1 District Secretary 2 District Director of Transportation Development (Production) 3 District Design Engineer 4 District Structures Design Engineer 5 District Project Management Engineer 6 Responsible Professional Engineer 7 State Structures Design Engineer 8 State Roadway Design Engineer 9 District Specifications Engineer 10 District Estimates Engineer 11 State Director of Design (for exempt projects) 	<p>NOTE: In special cases where programs or projects are developed in the Central Office, an appropriate Central Office Manager will provide concurrence in lieu of the District Manager.</p>
<ol style="list-style-type: none"> 1 District Secretary 2 District Director of Transportation Development (Production) 3 District Design Engineer 4 District Structures Design Engineer 5 District Project Management Engineer 6 Responsible Professional Engineer 7 State Structures Design Engineer 8 State Roadway Design Engineer 9 District Specifications Engineer 10 District Estimates Engineer 11 State Director of Design (for exempt projects) 	<p>NOTE: In special cases where programs or projects are developed in the Central Office, an appropriate Central Office Manager will provide concurrence in lieu of the District Manager.</p>		

Modification for Non-Conventional Projects:	
Delete Exhibit 24-A and replace with the following:	
Exhibit 24-A Approval and Concurrence Process	
TYPICAL SECTION PACKAGE	PAVEMENT DESIGN PACKAGE
Approved: 6 Concurrence: 3 or 4 <i>(PPM Vol. 1, Section 16.2.3)</i>	Approved: 6 Concurrence: 3 <i>(Pavement Design Manual)</i>
APPROVAL OF PHASE REVIEW PLANS (Roadway and Structures)	BRIDGE HYDRAULICS REPORT
Approved: 6 Concurrence: 3 4 5 7 or District Roadway Design Engineer <i>(PPM Vol. 2, Chap. 2)</i>	Approved: 6 Concurrence: District Drainage Engineer <i>(Drainage Manual, Chap. 4)</i>
ACCIDENT/SAFETY REVIEW	SPECIAL PROVISIONS
Approved: District Safety Engineer	Approved: 6 Concurrence: 9
DESIGN CRITERIA	PLANS, SPECIFICATIONS AND ESTIMATE
DESIGN EXCEPTIONS Requested: 3 or 6 Concurrence: 8, and 7 when needed. Approved: FHWA or 11 <i>(PPM Vol. 1, Chap. 23)</i>	PLANS PACKAGE Approved: 2 SPECIFICATIONS PACKAGE Approved: 9 FHWA AUTHORIZATION ESTIMATE Approved: 10 <i>(PPM Vol. 1, Section 20.3)</i>
<ol style="list-style-type: none"> 1 District Secretary 2 District Director of Transportation Development (Production) 3 District Design Engineer 4 District Structures Design Engineer 5 District Project Management Engineer 6 Responsible Professional Engineer 7 State Structures Design Engineer 8 State Roadway Design Engineer 9 District Specifications Engineer 10 District Estimates Engineer 11 State Director of Design (for exempt projects) 	<p>NOTE: In special cases where programs or projects are developed in the Central Office, an appropriate Central Office Manager will provide concurrence in lieu of the District Manager.</p>

Exhibit 24-B Design Plans Phase Review

DATE:

TO: (See Below)*

FROM:

COPIES:

SUBJECT: Response to _____ Phase Review

REF: Financial Project ID
FA Project Number
County

In content of letter include a statement confirming that all review comments have been responded to or satisfactorily resolved.

Include appropriate copies of review comments, responses and other pertinent data.

APPROVED:

CONCURRENCE:

Responsible Professional Eng.
(Name of Consultant Firm)

* District Design Engineer
* District Structures Design Engineer
* District Project Management Engineer

* As appropriate

Modification for Non-Conventional Projects:

Delete **Exhibit 24-B** and replace with the following:

Exhibit 24-B Design Plans Component Review

DATE:

TO: (See Below)*

FROM:

COPIES:

SUBJECT: Response to _____ Component Review

REF: Financial Project ID
FA Project Number
County

In content of letter include a statement confirming that all review comments have been responded to or satisfactorily resolved.

Include appropriate copies of review comments, responses and other pertinent data.

APPROVED:

CONCURRENCE:

Responsible Professional Eng.
(Name of Consultant Firm)

* District Design Engineer
* District Structures Design Engineer
* District Project Management Engineer

* As appropriate

Exhibit 24-C Special Provisions

DATE:

TO: District Design, Structures Design or
Project Management Engineer

FROM:

COPIES: State Specifications Engineer

SUBJECT: Special Provisions

REF: Financial Project ID
FA Project Number
County

Include detailed information concerning special provisions required.

Appropriate section(s) of FDOT Standard Specifications should be referenced.

Questions concerning format and content should be directed to the Specifications Office of FDOT

APPROVED:

CONCURRENCE:

Responsible Professional Eng.
(Name of Consultant Firm)

* District Design Engineer
* District Structures Design Engineer
* District Project Management Engineer

* As appropriate

THIS PAGE LEFT BLANK INTENTIONALLY

Chapter 25

Florida's Design Criteria for Resurfacing, Restoration and Rehabilitation (RRR) of Streets and Highways

25.1	Introduction	25-1
25.1.1	General	25-1
25.1.2	Application	25-1
25.2	Planning and Programming RRR Projects	25-3
25.2.1	Projects Requiring Right of Way	25-3
25.2.2	Projects With Bridges Within Project Limits	25-3
25.2.3	Project Features Requiring Design Exceptions and Design Variations.....	25-4
25.2.4	Ride Rehabilitation Projects	25-4
25.2.5	Railroad-Highway Grade Crossing Near or Within Project Limits	25-4
25.3	RRR Project Design Process	25-5
25.3.1	Review of Project Purpose	25-5
25.3.1.1	Principal Reason(s) for the RRR Project ..	25-5
25.3.1.2	General Nature of Proposed Improvements (Type of Work)	25-6
25.3.1.3	Review Project Budget and Priority	25-7
25.3.2	Assessment of Conditions	25-7
25.3.2.1	Office Reviews	25-8
25.3.2.2	Field Reviews	25-9
25.3.3	Project Scopes	25-10
25.3.4	Minimum Survey Guidelines for RRR Projects	25-11
25.3.4.1	Types of Work for RRR Projects.....	25-11
25.3.4.2	Definition of Levels of Survey Effort.....	25-12

25.3.5	Review Project Plans	25-13
25.3.6	Document the Design Process	25-13
25.4	RRR Design Criteria.....	25-14
25.4.1	Design Period.....	25-14
25.4.2	Project Traffic Volume	25-14
25.4.3	Pavement Design	25-15
25.4.4	Design Speed.....	25-15
25.4.5	Lane and Shoulder Widths	25-17
25.4.6	Roadway Cross Slopes	25-19
25.4.7	Superelevation	25-21
25.4.8	Shoulder Treatment.....	25-21
25.4.9	Roadside Slopes	25-22
25.4.10	Vertical Alignment	25-22
	25.4.10.1 Vertical Curvature.....	25-23
	25.4.10.2 Grades	25-25
25.4.11	Horizontal Alignment	25-25
	25.4.11.1 Horizontal Curves	25-26
25.4.12	Stopping Sight Distance	25-27
25.4.13	Vertical Clearance	25-28
25.4.14	Lateral Offset.....	25-28
25.4.15	Use of Curb on RRR Projects.....	25-28
25.4.16	Border	25-28
25.4.17	Intersections.....	25-29
25.4.18	Drainage	25-30
25.4.19	Pedestrian, Bicyclist and Transit Needs	25-31
	25.4.19.1 Pedestrian Needs	25-31
	25.4.19.2 Bicyclist Needs	25-32
	25.4.19.3 Transit Needs	25-33
25.4.20	At-grade Railroad Crossings	25-33

25.4.21	Aesthetics and Landscaping	25-33
25.4.22	Highway Lighting	25-34
25.4.23	Highway Traffic Control Devices	25-34
25.4.24	Bridges	25-35
	25.4.24.1 Bridge Loading	25-36
	25.4.24.2 Bridge Width	25-36
	25.4.24.3 Bridge Railing	25-36
	25.4.24.4 Vertical Clearance	25-36
	25.4.24.5 Considerations	25-37
	25.4.24.6 Pier Protection	25-37
25.4.25	Roadside Safety Hardware	25-37
25.4.26	Ancillary Structures (Sign, Signal, Lighting and ITS)	25-37
	25.4.26.1 Analytical Evaluation Without Proposed Additional Loading	25-39
	25.4.26.2 Analytical Evaluation With Proposed Additional Loading or Relocated Structures	25-39
25.4.27	Median Policy for Multilane Facilities	25-40
25.5	Design Exceptions and Design Variations	25-40

Tables

Table 25.4.4.1	RRR Design Speed vs. Posted Speed	25-16
Table 25.4.5.1	Lane and Shoulder Widths - Rural Multilane	25-17
Table 25.4.5.2	Lane and Shoulder Widths Two-Lane Rural and Urban, Without Curb and Gutter	25-17
Table 25.4.5.3	Lane Widths Urban Multilane or Two-Lane With Curb and Gutter	25-18
Table 25.4.5.4	Lane and Shoulder Widths Urban Multilane Without Curb and Gutter	25-18
Table 25.4.6	Roadway Cross Slopes	25-20
Table 25.4.7	Freeway Cross Slopes	25-20
Table 25.4.10.1	K Values for Vertical Curvature	25-24
Table 25.4.11.1	Safe Criteria for State Highway System With Maximum Superelevation	25-27
Table 25.4.12	Stopping Sight Distance	25-27
Table 25.4.24. 1	Clear Width Criteria for Bridges	25-36

Chapter 25

Florida's Design Criteria for Resurfacing, Restoration and Rehabilitation (RRR) of Streets and Highways

Modification for Non-Conventional Projects:

See the RFP for requirements.

25.1 Introduction

25.1.1 General

Resurfacing, restoration and rehabilitation (RRR) work is defined as work undertaken to extend the service life of an existing highway and enhance highway safety. This includes the placement of additional surface materials and other work necessary to return an existing roadway to a condition of structural and functional adequacy. Many of the RRR Standards used by the Department are derived from the ***National Academy of Sciences "Special Report 214"***. This publication contains many of the methods necessary to make the safety and cost effective evaluations required by this chapter.

RRR projects must be designed and constructed in a manner that will comply with the accessibility standards and requirements set forth in the ***Americans with Disabilities Act of 1990 (ADA)***.

25.1.2 Application

The criteria included in this chapter are for all RRR projects except for Interstate highways, freeways, and Limited Access Strategic Intermodal System (SIS) Corridors and Connectors, and are not intended to apply to new construction or major modifications of existing facilities.

The RRR design criteria applicable for Interstate Highways and Freeways are new construction criteria, with the following exceptions:

1. The standards used for horizontal alignment, vertical alignment, and widths of median, traveled way and shoulders may be the AASHTO interstate standards that were in effect at the time of original construction or inclusion into the interstate system.
2. Mainline bridges may remain in place if they have minimum cross sections consisting of 12 ft. lanes, 10 ft. shoulder on the right and 3 ft. shoulder on the left. For mainline bridges (over 200 ft.), the offset to the face of parapet or bridge railing on both the left and right is 3 ft. (minimum) measured from the edge of the nearest traveled lane. Bridge railing must meet or be upgraded in accordance with the requirements of **Chapter 4** of this Volume.
3. Roadside Safety Hardware must meet the requirements of **Chapter 4** of this Volume.
4. Pier protection and design must comply with the requirements provided in **Structures Design Guidelines, Section 2.6**. Additional information is available in **Chapter 4** of this Volume.
5. The existing roadway and shoulder cross slope may be retained when it meets the criteria in Section 25.4.6.

Existing median crossovers on Interstate highways and freeways must be evaluated for conformance to the criteria in **Section 2.14.4, Crossovers on Limited Access Facilities**. Crossovers that do not meet those criteria must be removed as a part of the project unless approved by the State Roadway Design Engineer and FHWA (FHWA approval on Interstate only).

Projects on controlled access SIS Corridor and Connector facilities should be designed using new construction criteria. RRR criteria may be applied on a project to the extent permitted by the Action Plan for that corridor, consistent with the schedule for phased improvements to bring the facility up to new construction criteria. For controlled SIS Corridors and Connectors with no Action Plan, RRR criteria may be applied if minimum design speed criteria shown in **Section 25.4.4** are met or a Design Exception for design speed is approved.

The RRR criteria may be used for establishing the minimum requirements for intersection improvement projects with the understanding that when right of way is adequate, new construction criteria will be used to the maximum extent feasible.

This chapter does not apply to projects programmed as Pavement Only Resurfacing projects other than meeting ADA curb ramp requirements. If compliance with ADA curb ramp requirements is determined to be technically infeasible, documentation as a Design Variation is required. Refer to **Part III, Chapter 28, Resurfacing**, of the [Work Program Instructions](#) for these projects.

25.2 Planning and Programming RRR Projects

RRR projects must balance a number of competing objectives, the principal ones being the preservation of highways, improved service levels and enhancement of safety. The success in meeting these objectives depends on the quality of individual project designs and project programming decisions.

The majority of RRR projects are identified and programmed as a result of deficient pavement condition. These projects are funded under the Department's Pavement Resurfacing program. Districts are provided specific lane mile targets that must be met annually. Program funds are allocated to each District based on a fixed amount per lane mile to be resurfaced. The amount allocated includes funds necessary to resurface/rehabilitate the pavement plus a limited amount which can be used for other improvements and upgrades. Improvements and upgrades which cost more than the allocated amount result in reduced funds for such improvements on other roadways being resurfaced and/or must come from other Department funding programs. For additional information on the Department's Pavement Resurfacing program requirements and restrictions, see the Department's [Work Program Instructions](#).

25.2.1 Projects Requiring Right of Way

RRR projects do not typically involve Right of Way acquisition. However, in all cases, facilities programmed for RRR projects should be given a review of the existing right of way, roadway, transit stops, access management, drainage design elements and other improvements to identify locations that require additional right of way. For such locations, the design should be expedited to determine actual right of way requirements. The designer must coordinate the requirements with the Right of Way Office so that necessary areas will be cleared before the project is ready for letting.

25.2.2 Projects With Bridges Within Project Limits

Bridges must be reviewed in sufficient detail to clearly establish the cost effective and appropriate changes to be included in the project design effort. Pavement resurfacing funds can only be used for minor bridge improvements such as rail retrofits and ADA improvements. Bridges that require major improvement or replacement must be programmed with the appropriate bridge program funds.

25.2.3 Project Features Requiring Design Exceptions and Design Variations

Projects may have features below criteria values which have not been programmed or which are determined not to be appropriate to accomplish under the design project. These usually require Design Exception or Design Variation approval, as appropriate. See **Sections 25.3.6** and **25.5**.

25.2.4 Ride Rehabilitation Projects

Projects that are deficient only due to Ride Rating (<5.5) as rated by the Pavement Condition Survey, and have a posted speed limit less than 50 mph, can be programmed as Ride Rehabilitation Projects.

If the pavement is in good structural condition, the scope of the work can be limited to meeting ADA requirements and doing what is necessary and practical to improve the smoothness of the pavement to meet standards. This can often just be adjustments to manholes and valves or the correcting of utility cut patches through short milling and paver-laid friction course.

These projects meeting the specific criteria above do not have to comply with **Sections 25.3.6** and **25.5**. They can be funded with Resurfacing Funds and will receive lane mile target resurfacing credit.

25.2.5 Railroad-Highway Grade Crossing Near or Within Project Limits

Federal-aid projects must be reviewed to determine if a railroad-highway grade crossing is in or near the limits of the project. If such railroad-highway grade crossing exists, the project must be upgraded in accordance with **Section 6.2.3** of this Volume.

See **Section 25.4.20** for additional railroad-highway grade crossing criteria.

25.3 RRR Project Design Process

Significant improvements in overall safety can be brought about by a systematic safety conscious design process. The design process is a team effort that requires the expertise of persons familiar with design, safety, maintenance, traffic operations and others. To assure that safety issues are fully addressed on RRR projects, in addition to the usual design process, the following are also required:

1. A review of the purpose for which the RRR project was programmed.
2. An assessment of current safety conditions.
3. A final scope of work with recommendations for specific safety improvements.
4. Documentation of the safety design decisions.
5. Reviews of the design for safety issues.
6. Identify and implement needed public involvement activities.

25.3.1 Review of Project Purpose

A RRR project is generated by specific needs or conditions. The designer must become familiar with these needs or conditions at the very beginning of involvement with the project in order to assure that the final scope of work and final design actually accomplish the original purpose of the project. This may involve research of background data or other information that provides the reason, the proposed improvements, estimated project cost and project priority.

25.3.1.1 Principal Reason(s) for the RRR Project

As indicated in **Section 25.2**, the majority of RRR projects are identified and programmed as a result of deficient pavement condition. The following list indicates some, but not all, of the principal reasons that can generate a RRR project:

1. To preserve or extend the life of the existing pavement.
2. Improve capacity (without adding continuous through lanes).
3. Improve operating characteristics.
4. Site specific crash reduction.
5. Section wide crash reduction.
6. General safety modifications.

25.3.1.2 General Nature of Proposed Improvements (Type of Work)

Department policy requires that the following items be included in each RRR project unless written authorization to deviate from this policy is obtained at a Director level position in the District:

1. Safety improvements needed to address crash problems.
2. Pavement Resurfacing/Rehabilitation.
3. Modifications necessary to Comply with the American's with Disability Act (ADA).
4. Paved Shoulders.
5. Improvements to roadside barriers and guardrail necessary to meet minimum standards. Design Exceptions require Central Office approval.
6. Improvements to bridge rails necessary to meet minimum standards. Design Variations require Central Office approval.
7. Traffic Signal Mast Arms within the mast arm policy area (see **Section 7.4.11** of this Volume) where existing strain poles require replacement/relocation.

In addition to the above, a project may include one or more of the following types of work as a general improvement. The list is not all-inclusive.

1. Widen roadway and bridge lanes.*
2. Widen or add roadway and bridge shoulders.*
3. Provide clear zone.
4. Upgrade pavement markings.
5. Add, update or remove traffic signals.
6. Correct skid hazards.
7. Replace bridges rated "insufficient".*
8. Upgrade to current Access Management requirements.
9. Provide non-vehicular transportation needs.
10. Add or extend auxiliary lanes to a roadway.
11. Add turn lanes at an intersection or on a roadway.
12. Realign an intersection or roadway.

13. Replacement of bridges which cannot be widened economically.*
14. Upgrade at-grade railroad crossings.
15. Intersection improvements.
16. Removal of parking lanes.
17. Add or upgrade transit stops.
18. Driveway modifications.
19. Other safety improvements.

*Major bridge improvements and replacements must be programmed using the appropriate bridge program funds.

While the general nature and type of improvements that can be made is extensive, due to the limited availability of funds, the cost of improvements other than those needed for safety and to meet minimum criteria must be carefully considered before including these improvements in the project.

25.3.1.3 Review Project Budget and Priority

The design and construction of a RRR project must be accomplished with expediency and at reasonable cost. Nevertheless, the project design must address all issues of safety, plus preservation of investment, and service to the user. Conditions that are discovered but cannot be resolved within the programmed budget and schedule must be addressed and the decisions documented.

25.3.2 Assessment of Conditions

Before beginning actual design of the project, the designer must assess current conditions on the project. This assessment must include both physical conditions and operating conditions plus a safety assessment. Perform office reviews and field reviews as part of the assessment.

25.3.2.1 Office Reviews

Conduct office reviews to assimilate and analyze data that may be pertinent to the improvements that can be made on the project.

1. Assess Physical Conditions

This assessment should include:

- a. Geometrics.
- b. Radius, length, and superelevation of curves.
- c. Typical shoulder treatments.
- d. Cross drain and structure locations.
- e. Location and design of intersections, etc.
- f. Existing cross slope and superelevation data.

A review of old plans, as built drawings, Straight Line Diagrams, and other historical records will determine many of the existing conditions.

2. Assess Operating Conditions

This assessment should include:

- a. A summary of legal posted speeds on the project.
- b. Drainage and Maintenance section's verbal or written concerns of past, present and/or anticipated future problems.
- c. Conditions attributable to current control of access.

3. Assess Safety

A review of historical crash and travel statistics must be performed by a qualified safety specialist. This assessment, with written recommendations, should include:

- a. Identification of significant crash locations, with:
 - 1) possible causes
 - 2) suggested corrective measures
- b. Review of correspondence files for letters of public concern.

The designer must review the safety assessment, evaluate the cost effectiveness of suggested corrective measures and include these measures in the project when appropriate.

25.3.2.2 Field Reviews

A field review must be performed by a multi discipline team. This review should assess physical, operational and safety conditions.

1. Assess Geometric and Physical Conditions
 - a. Verify office review findings.
 - b. Check roadway features such as:
 - 1) alignment
 - 2) cross slope
 - 3) Superelevation
 - 4) lane width
 - 5) existing traffic control markings and signs
 - 6) side slopes
 - 7) clear zones
 - 8) shoulder type and width
 - 9) intersection elements
 - 10) sight distances
 - 11) drainage (including erosion problems)
 - 12) pavement condition
 - 13) highway appurtenances
 - 14) transit stops
 - 15) other features
2. Assess Operating Conditions.
 - a. Verification of posted regulatory speeds.
 - b. Verification of posted advisory speeds.
 - c. Verification of reported problems.
 - d. Observation of operating conditions.
 - e. Evaluation of access features.
3. Assess Safety Conditions.
 - a. Observation of known crash locations.
 - b. Indications of unsafe operations, such as run-off-the-road indications or previous repairs.

25.3.3 Project Scopes

Utilizing the office and field review findings, prepare a final scope of work by incorporating, where appropriate, other work including engineering and surveying services not identified in the original scope. Improvements other than resurfacing, restoration or rehabilitation to be considered are listed below. The list is not all-inclusive.

1. Remove, relocate or make crashworthy roadside obstacles.
2. Remove unwarranted guardrail.
3. Upgrade or replace nonstandard guardrail.
4. Upgrade or replace nonstandard crash cushions.
5. Replace or retrofit obsolete bridge rails.
6. Improve side slopes; slope flattening/stabilizing.
7. Correct shoulder drop-off.
8. Pave shoulders.
9. Improve pavement cross slope and superelevation.
10. Provide side drain safety modifications.
11. Increase sight distance at intersections.
12. Improve pavement markings.
13. Improve pavement drainage.
14. Provide or upgrade sidewalks, transit stops and bikeways.
14. Upgrade railroad crossings (see **USC Title 23, Chapter 1, Section 109e** and **CFR 646.214(b)**).
15. Provide or upgrade signalization.
16. Provide or upgrade lighting.
17. Upgrade signing and other traffic control devices.
18. Provide or upgrade curb cuts, ramps and other disability access features.
19. Reconstruct or close driveways to comply with Access Management standards.

25.3.4 Minimum Survey Guidelines for RRR Projects

25.3.4.1 Types of Work for RRR Projects

1. Mill and resurface only, EOP to EOP, no other improvements [Level 1].
2. Resurface with trench widening (Roadway only) [Level 1 if lump sum excavation].
3. Resurface adding turn lanes (spot improvements) [Level 2].
4. Resurface adding shoulder pavement [Level 2].
5. Combination of numbers 2-4 [Level 2].
6. Resurface with access management improvements [Level 2].
7. Resurface with cross slope and/or superelevation correction [Level 2].
8. Add shoulder pavement only [Level 2 or 3].
9. (E) Extend drainage structures [Level 3].
10. (E) Guardrail, end treatments, etc. (safety) [Level 2].
11. (E) Side drain closure; mitered ends [Level 3].
12. Intersection improvements [Minor = Level 2; Major = Level 3].
13. (E) Correct horizontal and/or vertical alignment [Level 3].
14. (E) ADA compliance [Level 2].
15. Approaches to structures [Level 4].
16. RRR with Right of Way acquisition [Level 3].

(E) = Element of an item

(See also **Section 25.3.1.2**)

25.3.4.2 Definition of Levels of Survey Effort

1. LEVEL 1

Review by District Surveyor to check for Public Land Corners. Check sections for cross slope at 1000 feet in tangents. For curves, check 50 feet before PC, at PC, 50 and 100 feet after PC and at middle of curve or 300 foot intervals. (Reverse at PT). May use assumed datum if approved by the District Location Surveyor and the Project Manager/Designer. The cross sections will have a common bench mark elevation throughout the curve. In other words, do not assume an elevation at the centerline of the highway for each cross section. A minimum of two (2) bench marks should be set off of the highway near the Right of Way (R/W) Line and may be on assumed elevations or NAVD 88 datum. If the surveyor elects to use temporary assumed bench marks, they must last throughout the life of construction and **cannot** be set in trees, power poles or concrete monuments. Establish begin and end points of project and reference.

2. LEVEL 2

Minor spot improvements such as turn lane at existing crossover, turn lane on 2-lane, etc. No additional Right of Way required. Where Right of Way is adequate, establish horizontal and vertical control in the improvement area. May use assumed vertical datum if approved by the District Location Surveyor and the Project Manager/Designer. The cross sections will have a common bench mark elevation throughout the curve. In other words, do not assume an elevation at the centerline of the highway for each cross section. A minimum of two (2) bench marks should be set off of the highway near the Right of Way Line and may be based on assumed elevations or NAVD 88 datum. If the surveyor elects to use temporary assumed bench marks, they must last throughout the life of construction and **cannot** be set in trees, power poles or concrete monuments. If Right of Way is constrained, re-establish existing R/W line. Level 1 required throughout other portions of project. Cross section level to be determined by Project Manager/Designer with input from the District Location Surveyor and Resident Engineer. TOPO with supplemental cross sections and/or elevations in area(s) of deficient criteria and/or proposed improvement(s). Reference control points outside R/W. Subsurface utility locates if required.

3. LEVEL 3

Continuous improvements through length of project such as widening and/or paved shoulder; or major spot improvements (structure replacement; major intersection improvement). May require Right of Way purchase. Horizontal

Control baseline, centerline or network. Vertical Control on NAVD 88. TOPO with supplemental elevations (limits to be determined). Digital Terrain Model (DTM) at specified locations. Right of Way Control Survey and Maps (if Right of Way purchased). Subsurface utility locates.

4. **LEVEL 4**

Full Digital Terrain Model (DTM) and TOPO for entire project.

25.3.5 Review Project Plans

RRR design plans are reviewed by other disciplines including a safety specialist. These reviews are detailed in **Chapter 16** of this volume.

25.3.6 Document the Design Process

The designer must include in the design file all documentation that substantiates the design process and decisions made, including the following information:

1. A short paragraph which states the overall project purpose. Factors such as principal reason for the project, anticipated project cost, principal work type, general right of way needs or provisions, and any special project priorities are appropriately addressed here.
2. Documents that detail the existing conditions on the project. Findings of office reviews, field reviews and surveys are assembled here, to document existing geometric and roadside features, operating conditions, traffic volumes, posted speeds, existing pavement markings, signing, safety, etc. A brief overall summary of findings is recommended.
3. Document the selected standards based on project intent and conditions. When RRR criteria cannot be met, a Design Exception/Design Variation is required.
4. A summary of safety issues that have been identified for the project and the recommended solution of those issues.
5. Reviews of the project design for safety improvements, documenting what was finally accomplished or ruled out of the project subsequent to the scope of work having been completed.
6. Those items in the original scope of work for the project which cannot be reasonably accomplished and must be deleted or delayed.

25.4 RRR Design Criteria

Design values and decisions for roadway features should reflect the anticipated service life of the project. The designer has the responsibility to choose the specific design value to be used, taking into consideration its cost-effectiveness, which can range from the minimum RRR Criteria presented herein, to new construction criteria. Design values in the following sub-sections apply to RRR projects only. When specific values are not provided, the standards used in the original construction or subsequent enhancements may be retained except when an upgrade is identified in the project scope.

Designers are encouraged to make a deliberate selection of design values by explicitly addressing issues of safety cost-effectiveness, overall highway consistency in geometric design, design of adjoining segments and expected trends in traffic growth and truck use before specifying design values. The design values indicated in this chapter usually reflect a cost-effective basis for evaluating existing roadway characteristics to determine which features require upgrading.

The design values presented herein are the minimum to be used for a RRR project on the State Highway System without obtaining a Design Exception or Design Variation. See **Section 25.5** of this Volume. Existing project features which were constructed to meet minimum metric design criteria, but are mathematically slightly less than equivalent minimum English design criteria, do not require Design Exceptions or Design Variations to remain.

25.4.1 Design Period

Improvements should be evaluated using a design period which is consistent with the design period selected for the pavement rehabilitation. The design period (service life) for RRR projects should be from 8 - 20 years for projects without milling and 12 - 20 years for projects with milling. See the ***Flexible Pavement Design Manual, Topic No. 625-010-002*** for specific design periods. For skid hazard projects, where other improvements are not made, the design year is the expected year of construction.

25.4.2 Project Traffic Volume

The design year for traffic volume is the same design year as the year established for service life. Traffic data to be used for design:

AADT and DHV for mainline (current, post construction and design year),

1. K, D and T factors,
2. Peak turning movements at signalized and problem intersections and major traffic generators,
3. Movements for future traffic generators that are scheduled during the service life should be considered.

25.4.3 Pavement Design

The pavement design procedures are found in the *Flexible Pavement Design Manual (Topic No. 625-010-002)*, the *Rigid Pavement Design Manual (Topic No. 625-010-006)*, and the *Pavement Type Selection Manual (Topic No. 625-010-005)*.

Alternative paving treatments such as patterned pavement may be used to accent the roadway in accordance with the *Standard Specifications*. Architectural pavers, however, must not be used on the traveled way of the State Highway System. See *Section 2.1.6.1* of this Volume for additional requirements.

25.4.4 Design Speed

Most highway features are based on design speed. Design speed is a principal design control that regulates the selection of many of the project standards and criteria used to design a roadway project. Selection of the design speed must be logical for the type, location and operational conditions of the highway, and the design speed used should be consistent with comparable adjacent projects. Design speed must not be dictated by an isolated geometric feature.

Design speed should not be less than the legal posted speed. The design speed used in the original design of the highway should be used for RRR projects. However, there may be situations where the existing posted speed on the highway is different than that used in the original design of the highway. The decision to modify the posted speed limit after the construction of the original project was completed would have been made under the authority of the District Traffic Operations Engineer (DTOE). In this case, the selected design speed must be jointly approved by the District Design Engineer and the DTOE. This is to be documented on the Typical Section Package as described in *Section 16.2.3* of this Volume. New project features and the correction of features having a significant crash history must be designed using a design speed equal to or greater than the posted speed and process Design Exceptions or Design Variations for those new design elements that do not meet the criteria for the higher speed. See *Table 25.4.4.1* for further guidance.

Table 25.4.4.1 RRR Design Speed vs. Posted Speed

Condition	Establishing the Proposed Project Design Speed (DS_p)
CASE 1	Use the design speed used in the original design of the highway. $DS_p = DS_o$
CASE 2	Use the design speed used in the original design of the highway unless a reduced design speed (not less than posted speed) is approved by the DDE and the DTOE. $DS_p = DS_o$
CASE 3	Use the design speed used in the original design of the highway unless there is a significant crash history associated with a specific highway feature. If so, then the design speed used in correcting the feature must be equal to or greater than the posted speed. The posted speed must also be used as the design speed for any other new highway features (not replacements). Special attention should be given to curb and gutter sections. $DS_p = DS_o$ and $DS_p = PS$ (for design of features that are new or have a significant crash history)

CASE 1: The existing posted speed falls **within** an acceptable range of the original design speed. (i.e., $PS \leq DS_o \leq (PS + 10 \text{ mph})$ Example: $DS_o = 65\text{mph}$ and $PS = 55\text{mph}$).

CASE 2: The existing posted speed falls **below** an acceptable range of the original design speed. In a case like this, the posted speed was reduced, and the operational conditions have changed. (i.e., $DS_o > (PS + 10 \text{ mph})$ Example: $DS_o = 65\text{mph}$ and $PS = 35\text{mph}$).

CASE 3: The existing posted speed falls **above** an acceptable range of the original design speed. In a case like this, the posted speed was increased, and the operational conditions have changed. (i.e., $PS > DS_o$ Example: $DS_o = 50\text{mph}$ and $PS = 60\text{mph}$).

LEGEND

DS_o = Design speed used in the original project

DS_p = Proposed design speed for project

PS = Existing (or proposed if different) posted speed

Regardless of the original design speed or posted speed, the following are the minimum design speeds:

1. Rural Facilities: 55 mph
2. Urban Facilities: 30 mph
3. Urban Facilities on SIS: 50 mph*

* For curb and gutter facilities where existing posted speed is 45 mph or less, a design speed of 45 mph may be used.

Note: Values for design speeds less than these minimums have been provided in the tables in this chapter in the event that lower design speeds can be justified. If reconstruction is indicated, the criteria used for design should be selected from **Chapter 2** of this volume.

25.4.5 Lane and Shoulder Widths

The minimum lane and shoulder widths allowed are provided in **Tables 25.4.5.1, 25.4.5.2, 25.4.5.3, and 25.4.5.4**. The minimum widths shown in these tables are to allow existing lanes and shoulders to remain, not to be reduced to these widths unless the purpose is to provide a bicycle lane or increase the width of the outside lane for cyclists. See **Section 25.4.19** for further information.

On resurfacing projects, when the original construction was in metric units, hard convert typical section dimensions where existing conditions permit. Exception: Use direct mathematical (soft) conversion for existing pavement widths in curbed sections, existing right of way widths, and existing median widths.

For interchange ramps, where accommodation of future resurfacing is a factor, consideration should be given to increasing the minimum combined width (traveled way + outside paved shoulder) to 24 ft. where practical.

Table 25.4.5.1 Lane and Shoulder Widths - Rural Multilane

Design Year AADT	Design Speed (mph)	Minimum Lane Width (ft.)	Minimum Shoulder Width (ft.)
ALL	ALL	12 ₁	6

1. 11 ft. for divided roadways with a Design Speed of 45 mph or less and in or within one mile of an urban area.

**Table 25.4.5.2 Lane and Shoulder Widths
 Two-Lane Rural and Urban, Without Curb and Gutter**

Design Year AADT	Design Speed (mph)	Minimum Lane Width (ft.)	Minimum Shoulder Width (ft.)
1 – 750	ALL	10 ₁	6
751 – 2000	< 50	11 ₂	6
	≥ 50	12 ₂	6
> 2000	ALL	12 ₂	6

1. For rural and urban projects without curb and gutter (regardless of traffic volume), when widening is required, a minimum lane width of 11 ft. is required.
2. May be reduced by 1 ft. if trucks ≤ 10% of design year traffic.

**Table 25.4.5.3 Lane Widths
 Urban Multilane or Two-Lane With Curb and Gutter**

Design Year AADT	Design Speed (mph)	Minimum Thru Lane (ft.)	Minimum Turn Lane (ft.)	Minimum Parking Lane (ft.)
ALL	ALL	10 ₁	9 ₂	7 ₃

1. 11 ft. where either of the following conditions exist:
 - a. Trucks are >10% of Design Year Traffic.
 - b. Design Speed is 40 mph or greater.
2. 10 ft. for 2 Way Left Turn Lanes.
3. A minimum width of 7 ft. measured from face of curb may be left in place. Otherwise provide 8 ft. minimum, measured from face of curb.

**Table 25.4.5.4 Lane and Shoulder Widths
 Urban Multilane Without Curb and Gutter**

Design Year AADT	Design Speed (mph)	Minimum Thru Lane (ft.)	Minimum Turn Lane (ft.)	Minimum Shoulder Width (ft.)
ALL	ALL	10 ₁	9 ₂	6

1. 11 ft. where either of the following conditions exist:
 - a. Trucks are >10% of Design Year Traffic.
 - b. Design Speed is 40 mph or greater
2. 10 ft. for 2-Way Left Turn Lanes.

25.4.6 Roadway Cross Slopes

Review the existing pavement and shoulder cross slopes for compliance with criteria. Field verify existing pavement and shoulder cross slopes by one of the following:

1. Full Digital Terrain Model for the roadway width – evaluate cross slope on tangent sections at 100' intervals.
2. Vehicle Mounted Scanner – prior to design, using the results of the scan, determine roadway limits where cross slope is potentially out of tolerance and request Digital Terrain Model of the roadway width for these limits. Evaluate cross slope on tangent sections at 100' intervals.

If cross slopes are out of tolerance, additional cross sections may be required by the designer to develop cross slope correction details and estimate material quantities. Whenever practical, pavement and shoulder cross slopes must be constructed to new construction criteria. When meeting new construction cross slope criteria is not practical, documentation in the design file is required and the normal non-superelevated cross slope used must be consistent with the values in **Table 25.4.6** or **Table 25.4.7**. If existing conditions are within the allowable ranges, the term “Match Existing” must be used when the existing cross slope is to remain. Superelevation requirements are covered in **Section 25.4.7** of this volume.

When cross slope correction is necessary, the designer must work closely with the Pavement Design Engineer and the District Bituminous Engineer to determine the appropriate method of correction and ensure constructability. Existing cross slopes for the limits where cross slope correction is required must be tabulated in the plans at 100' intervals. Include special milling and layering details showing the method of correction in the plans (see examples in **Chapter 6** of Volume 2). Cross sections depicting cross slope correction must not be shown in the plans. Base cross slope correction material quantities on the method of correction shown in milling and resurfacing details.

Table 25.4.6 Roadway Cross Slopes

Facility or Feature	Standard	Allowable Range
Two-Lane Roads	0.02	0.015-0.030
Multilane Roads	0.02	0.015-0.040
Shoulders	0.06	Adjacent Lane Cross Slope- 0.080
Parking Lanes	0.05	0.015-0.050

The multilane standard cross slope value shown is applicable for up to two lanes in one direction. See Section 2.1.5 for additional guidance.

Existing multilane curb and gutter sections may have outside lanes with a maximum cross slope of 0.05.

Existing curb and gutter sections originally constructed with a parabolic crown section may be resurfaced using a series of tangents with a cross slope range from 0.015 to 0.05.

The maximum algebraic difference between adjacent through lanes must not exceed 0.06.

When existing shoulders are to remain, the algebraic difference between the shoulder slope and adjoining roadway pavement slope must be ≤ 0.07 .

Parking spaces and access aisles dedicated to serving persons with disabilities must have cross slopes no steeper than 0.02 (1:50) in any direction.

Table 25.4.7 Freeway Cross Slopes

Facility or Feature	Standard	Allowable Range
Travel Lanes	0.02*	0.015-0.025
Travel Lanes	0.03*	0.025-0.035

* Applies to lanes as designated in Figure 2.1.1.

The algebraic difference in cross slope between adjacent travel lanes must not exceed 0.04. The maximum algebraic difference in cross slope between a through lane and an auxiliary lane at a turning roadway terminal must meet Table 2.1.4.

Paved shoulder cross slopes do not need to be corrected if they meet the values in Table 25.4.6 and the algebraic difference in cross slope between the shoulder and adjacent travel lane is 0.07 or less.

25.4.7 Superelevation

Roadway and shoulder superelevation should be provided in accordance with the **Design Standards, Index 510** for rural curves and **Index 511** for urban curves, consistent with **Section 25.4.11.1, Number 2, Superelevation**. When the existing superelevation does not meet the Design Standard requirements, conduct a safety study to determine if superelevation may be linked as the primary contributing factor to crashes in the curve. If superelevation can be linked to more than one crash in a five year period, superelevation correction is required.

For high speed facilities, including Interstate and toll facilities, superelevation correction is required except when both of the following conditions are met:

- Superelevation cannot be linked as a contributing factor to crashes in the curve.
- The existing superelevation rate (for the design speed and radius of the curve in question) is within the range of values for $e_{\max} = 6\%$ and $e_{\max} = 12\%$, provided in AASHTO's figures for Minimum Radii for Design Superelevation Rates, Design Speeds.

When superelevation correction is required, detail how the transition from normal cross slope to superelevation is to be achieved. Since this type of work will often involve variable depth milling and/or asphalt layers, special care in estimating quantities for milling, overbuild, and structural courses will be necessary. Show cross sections depicting superelevation correction in the plans for the following locations:

1. At the PC and at the PT.
2. Fifty feet before and after the PC and PT.
3. At 300' intervals within the curve.

25.4.8 Shoulder Treatment

On projects with rural type (without curb) construction, shoulder treatment, erosion control, turf and sod must be provided consistent with the criteria for new construction. Paved shoulders must be provided in accordance with new construction criteria with the following exceptions:

1. The widening of existing 4 ft. paved shoulders is optional.
2. When a bicycle lane is provided between the through lane and the right turn lane in accordance with **Section 25.4.19**, a paved shoulder should be provided for the

right turn lane, but is optional. When a paved shoulder is provided for the right turn lane, it should be 5 feet wide (2 feet minimum) to address off-tracking vehicles and to provide drainage benefits.

For RRR projects using *Index 105* of the *Design Standards*, the shoulder treatment option must be identified in the plans. Treatment I can only be used if the shoulder is established with good soil and turf, and there is no significant shoulder erosion. If a project meets the overlay thickness requirements for Treatment I, but there is significant shoulder erosion, Treatment II must be used in the plans.

For new construction paved shoulder criteria, refer to *Chapter 2* of this Volume. Shoulder cross slope is addressed in *Section 25.4.6*.

25.4.9 Roadside Slopes

For roadside slope criteria see *Chapter 4* of this Volume.

25.4.10 Vertical Alignment

Vertical alignment must be reviewed together with the horizontal alignment to assure that the necessary balance of standards is realized and that the combination is both safe and pleasing.

The alignment should be reviewed to see if the following principles are satisfied by the existing vertical alignment:

1. The stopping sight distance provided meets or exceeds the values in *Table 25.4.12*.
2. Grades do not significantly affect truck operations.
3. There are no hidden dips which could obscure traffic or hazards.
4. Steep grades and sharp vertical curves do not exist at or near an intersection.
5. Sufficient grades and, when necessary, special gutter grades exist to adequately drain urban projects.
6. Adequate sight distance exists for traffic signals (e.g., beyond overpasses, etc.).

When any of the above conditions do not exist, the designer should evaluate for hazardous conditions and determine if corrective measures are warranted.

25.4.10.1 Vertical Curvature

Use the K Values provided in **Table 25.4.10.1** to check the sufficiency of crest vertical curves. When crash data indicates that an evaluation is required, consider the following:

1. The nature of potential hazards hidden by a hill crest.
2. The location of the hazard in relation to the portion of the highway where sight distance falls below new construction criteria.
3. Effectiveness of other options such as relocating or correcting the hazard.
4. Providing warning signs.

Sag vertical curves do not typically pose stopping sight distance problems. However, if an existing sag vertical curve has a crash history related to the stopping sight distance, it must be evaluated. If the evaluated sag vertical curve does not meet the minimum K value in **Chapter 2, Table 2.8.6**, a Design Exception or Design Variation is required for the curve to remain. Sag vertical curves that are to be reconstructed must meet the criteria in **Table 2.8.6**. Sag vertical curves that fall below the minimum K value in **Chapter 2, Table 2.8.6** and do not have a crash history do not require a Design Exception or Design Variation to remain.

Table 25.4.10.1 K Values for Vertical Curvature

DESIGN SPEED (mph)	K Values for Crest Curves	
	Interstate	All Other Facilities
15	----	3
20	----	7
25	----	12
30	----	19
35	----	29
40	----	44
45	----	61
50	----	84
55	151	114
60	193	151
65	247	193
70	312	247
<p>Length, $L = KA$</p> <p>Where: K = Rate of vertical curvature L = Length of vertical curve, (feet) A = Algebraic difference in grades, (percent)</p>		
<p>K values are based on an eye height of 3.5 feet and an object height of 2.0 feet.</p>		

25.4.10.2 Grades

Grades which satisfied the standards in effect at the time of construction may be used provided the result is consistent with the design principles in **Section 25.4.10**. Grades which are not consistent with these design principles must be evaluated.

25.4.11 Horizontal Alignment

Vertical and horizontal alignment must be reviewed together to assure that the necessary balance of standards is realized and the combination is both safe and pleasing.

The designer should review the alignment to identify that the existing alignment adheres to the following guidelines:

1. Consistent with no sudden changes from easy to sharp curvature.
2. Sufficient tangent length between reverse curves.
3. Superelevation transitions provided.
4. Maximum curvature is not used:
 - a. On high fills or elevated structures.
 - b. At or near crest in grade.
 - c. At or near low points in grade.
 - d. At the end of long tangents.
 - e. At or near intersections or points of access or egress.
 - f. At or near decision points.

At all locations where the existing alignment does not adhere to these conditions, the designer should evaluate for hazardous conditions and determine if corrective measures are warranted.

25.4.11.1 Horizontal Curves

Horizontal curves must be reviewed for horizontal curvature and superelevation. Review existing curves against the values in **Table 25.4.11.1**. Every practical attempt must be made to upgrade curves which are below State Highway System (SHS) minimum values for new construction. The review should also include an on-site review for evidence of near crashes or operational problems.

1. Horizontal Curvature

Condition #1 - Horizontal curves that meet or exceed the SHS minimum radius values are satisfactory unless there is a significant crash history (3 or more crashes within the most recent 5-year) or other evidence of safety or operational problems. If problems are identified, include corrective measures in the project.

Condition #2 - Curves which are below the SHS minimum radius values but meet or exceed the RRR minimum radius values must be reviewed for specific safety problems at the curve. If the review indicated significant operational or safety problems exist, the curve must be reconstructed. If problems are identified but reconstruction is not warranted, include corrective measures in the project.

Condition #3 - Those curves which do not meet the RRR minimum radius values must be reconstructed or a Design Exception must be obtained. Reconstructed curves must meet the criteria for new construction contained in **Chapter 2** of this Volume. Sufficient time and budget must be programmed into the RRR project to obtain any right of way necessary for reconstruction of the curve.

2. Superelevation

Rural Curves - Existing rural curves not having the indicated superelevation rate on the **Design Standards, Index 510** should be corrected to that rate. Provide other measures appropriate to correct or improve identified safety or operational problems.

Urban Curves - Existing urban (C&G) curves not having the indicated superelevation rate on the **Design Standards, Index 511** should be corrected to that rate by reconstruction of the curve or, if practical, curb adjustment to accommodate overbuild. Provide other measures appropriate to correct or improve identified safety or operational problems.

3. PIs Without Curves

Where alignments have PIs without curves that exceed the new construction values in **Table 2.8.1** of this Volume, consideration should be given to reconstructing the roadway with suitable curvature.

**Table 25.4.11.1 Safe Criteria for State Highway System
 With Maximum Superelevation**

DESIGN SPEED (mph)	e _{max.} = 0.10				e _{max.} = 0.05			
	SHS		RRR		SHS		RRR	
	D _{max}	R _{min.} (ft.)	D _{max}	R _{min.} (ft.)	D _{max}	R _{min.} (ft.)	D _{max}	R _{min.} (ft.)
30	24° 45'	231	30° 30'	188	20° 00'	286	25° 45'	223
35	17° 45'	323	20° 45'	276	14° 15'	402	17° 15'	332
40	13° 15'	432	14° 45'	388	10° 45'	533	12° 15'	468
45	10° 15'	559	11° 00'	521	8° 15'	694	9° 00'	637
50	8° 15'	694	8° 30'	674	6° 30'	881	6° 45'	849
55	6° 30'	881	6° 45'	849	N/A		N/A	
60	5° 15'	1091	5° 30'	1042	N/A		N/A	
65	4° 15'	1348	4° 30'	1273	N/A		N/A	
70	3° 30'	1637	3° 45'	1528	N/A		N/A	

25.4.12 Stopping Sight Distance

Stopping sight distance requirements are provided in **Table 25.4.12**.

Table 25.4.12 Stopping Sight Distance

DESIGN SPEED (mph)	STOPPING SIGHT DISTANCE (ft.)
15	80
20	115
25	155
30	200
35	250
40	305
45	360
50	425
55	495
60	570
65	645
70	730

25.4.13 Vertical Clearance

In addition to the requirements of **Section 2.10**, the following provisions apply:

Bridge Underpass Clearance - Maintain a minimum vertical clearance of 14 feet 6 inches through milling and resurfacing. In accordance with the **Traffic Engineering Manual, Section 2.6**, provide signing and warning features whenever bridge vertical clearance is less than 14 feet 6 inches.

Bridge Low Member Clearance – Contact the District Structures Design Engineer for further guidance if any sway bracing members over the bridge deck have a clearance of less than 14 feet.

25.4.14 Lateral Offset

For lateral offset criteria see **Chapter 4** of this Volume.

25.4.15 Use of Curb on RRR Projects

See **Section 4.2.7** of this Volume, for information regarding curbs and their placement. Additionally, refer to **Section 2.16** of this Volume, concerning High Speed Urban and Suburban roadways.

25.4.16 Border

The minimum border width must be the greatest of the following:

1. The border width used in the original project.
2. The border width required to satisfy ADA accessibility standards.
3. 8 feet.

When right of way is being acquired for other reasons, the minimum border width must be that used for new construction projects; however, the minimum length of wider border width must be a segment of sufficient length to provide reasonable continuity.

25.4.17 Intersections

Evaluate intersections to determine those that need a traffic engineering study. The following items should be considered:

1. Traffic Signal Mast Arms or single point attachment span wires within the mast arm policy area (see **Section 7.4.11** of this Volume) where existing strain poles require replacement/relocation.
2. Addition of right and left turning lanes.
3. Realignment of intersection.
4. Adequate turning radii for left and right turning lanes.
5. Use of channelization to reduce excessive areas of conflict at large intersections.
6. Placement of crosswalks as related to sidewalks and stop bars.
7. Locations of pedestrian, bicycle, and transit facilities.
8. Locations of utilities, signal poles, controller cabinets, lighting poles and drainage structures as related to sidewalks and curb ramps.
9. Warrants for traffic control systems.
10. Addition of signal backplates where it would not require structural modifications to mast arms or span wire systems.
11. Addition of auxiliary heads where it would not require structural modifications to mast arms or span wire systems.
12. Installation of buried conduit for future traffic control systems.
13. Lighting for intersection illumination.
14. Adequate sight distance.
15. ADA needs.

Include corrective measures in projects having T-intersections with significant crash histories (3 or more crashes of a specific type within the most recent 5-years) or other evidence of safety or operational problems.

When there are proposed changes in intersection control, a roundabout alternative must be considered. See **Section 2.13.1** in this Volume for additional information.

Intersection improvements other than those necessary to address a safety need or to meet minimum design criteria must be carefully considered before inclusion in the project (see **Section 25.2**). The additional cost associated with improvements

requested by local governments that exceed FDOT criteria (e.g., installation of mast arm signal supports in areas beyond the mast arm policy area) should be paid for by the local government making the request.

25.4.18 Drainage

The designer or drainage specialist must evaluate the hydraulic, *safety*, and physical adequacies of the existing drainage system. This requires examination of the existing drainage in the field and by consulting with maintenance personnel and records. If there are apparent problems with the existing drainage system, additional evaluation is required to determine the extent and most cost effective improvements necessary to upgrade the system. The ***FDOT Drainage Manual (Topic No. 625-040-002)*** contains design criteria and methods which provide guidance in formulating suitable drainage features, either through modification or replacement.

For roadside safety requirements of drainage features, refer to ***Chapter 4*** of this Volume.

Prior to selecting any plan of highway improvement, the designer should consult with drainage and environmental permitting specialists since almost all roadway modifications reduce storage and infiltration and increase discharge rates and volumes. Stormwater retention and detention for quality, rate and volume may be required. Theoretical evaluation of proposed changes to existing and new drainage features necessary to correct operational deficiencies should be referred to a drainage specialist. The drainage specialist will provide the necessary drainage design, flood data information, drainage related information for the Stormwater Pollution Prevention Plan (SWPPP) and any stormwater permit computations.

If siltation is noted by the designer during field review they are to coordinate with Maintenance and indicate the severity of the siltation. If Maintenance is unable to perform desilting prior to construction consider adding desiltation of existing pipes to project.

Due to funding limitations, improvements other than those needed for safety and minimum criteria must be carefully considered before inclusion in the project (see ***Section 25.2***).

25.4.19 Pedestrian, Bicyclist and Transit Needs

Whenever a RRR project is undertaken, pedestrian and bicyclist needs must be addressed, and transit needs should be considered. Recommendations by the District Pedestrian/Bicycle Coordinator and the District Modal Development Office must be obtained; local government and transit agency contact in developing these recommendations is essential. This should be part of the project scoping and programming effort.

25.4.19.1 Pedestrian Needs

1. Sidewalks and Shared use Paths

On RRR projects, new or reconstructed sidewalks and shared use paths must meet the criteria provided in **Chapter 8** of this Volume.

For existing sidewalks and shared use paths, detectable warnings and curb ramps must be brought into compliance with ADA requirements. This includes installing new detectable warnings for both flush shoulder and curbed roadway connections and signalized driveways where none exist or do not meet current requirements. Provide new curb ramps on curbed roadways where none exist; replace existing substandard curb ramps. Existing ramps not meeting detectable warning requirements which otherwise comply with ADA, must be retrofitted with detectable warnings. (See **Design Standards, Indexes 304 & 310.**) **NOTE:** If ADA complaints have been received concerning sidewalks or driveway turnouts within the project limits, the Project design must include upgrades to nonconforming elements of these facilities to meet the criteria in **Design Standards, Indexes 304, 310, and 515.**

Pull boxes, manholes, and other types of existing surface features in the location of a proposed curb ramp or detectable warning should be relocated when feasible. When relocation is not feasible, the feature must be adjusted to the new ramp to meet the ADA requirements for surfaces (including the provision of a non-slip top surface, and adjustment to be flush with and at the same slope as the curb ramp).

When compliance with ADA curb ramp requirements is determined to be technically infeasible documentation as a Design Variation is required. This may occur where existing right of way is inadequate and where conflicts occur with existing features that cannot be feasibly relocated or adjusted, e.g., drainage inlets, signal poles, pull boxes, etc..

Other than meeting detectable warning and curb ramp requirements, existing sidewalks and flared driveway turnouts are not required to be upgraded for the sole purpose of meeting ADA requirements, unless included in the project scope by the District. Design all new sidewalk and driveway construction or reconstruction on RRR projects in accordance with ADA requirements.

2. Medians

Evaluate medians to determine if modifications such as pedestrian refuge sections are necessary. 5-lane and 7-lane sections are restricted or eliminated under current policy, usually by the introduction of a raised or restrictive median, which enhances the opportunity to accommodate pedestrian needs. Traffic separators with a width sufficient to provide refuge should be used at intersections where possible. When adequate pedestrian refuge cannot be provided at the intersection, midblock islands should be provided.

Design details for disability access features including sidewalk, curb ramps and driveway turnouts are found in the **Design Standards**. Additional standards for ADA are found in the regulations and design guidelines issued by the Secretary of the U.S. Department of Transportation.

25.4.19.2 Bicyclist Needs

1. Buffered Bicycle Lanes, Bicycle Lanes, Paved Shoulders, Wide Outside Lanes and Shared Lanes

The available roadway width should be distributed to provide for bicycle facilities. Bicycle facilities must meet the criteria provided in **Chapter 8** of this Volume. The type of bicycle facility considered for implementation must be in the following order: buffered bicycle lanes, bicycle lanes, wide outside lanes, and shared lanes. Travel lane widths on urban multilane roadways and two-lane curb and gutter roadways must not be reduced to less than 11 feet for design speeds ≥ 40 mph, and to no less than 10 feet for design speeds ≤ 35 mph. See **Section 25.4.5** for additional information on lane widths. Coordinate with the District Public Transportation (Modal Development) Office and local transit agency when considering the reduction of lane widths on roadways where public transit routes are present. Existing bicycle facilities not in accordance with **Chapter 8** of this Volume, require a Design Variation to remain.

2. Right Turn Lanes

Bicycle lanes at right turn lanes must meet the criteria provided in **Section 8.4.2** of this Volume.

3. Drainage Inlets, Grates, Utility Covers

Evaluate existing drainage inlets, grates and utility covers to determine whether they present an obstruction to bicyclists, and should be relocated out of the cyclist's path of travel. Drainage inlets, grates and utility covers to remain should be adjusted to be flush with the adjacent pavement surface, utilize a grate recommended for bicycle travel, and be marked as an obstruction. See the **MUTCD** and **Design Standards** for further information. Existing inlets, grates or covers which present gaps sufficient to trap the wheel of a bicycle should be referred to the Maintenance Office for remediation until the project is constructed.

25.4.19.3 Transit Needs

A 5-foot wide (minimum) sidewalk that connects a transit stop or facility with an existing sidewalk or shared use path must be included to comply with ADA accessibility standards.

25.4.20 At-grade Railroad Crossings

When highway improvements are undertaken that include at-grade railroad crossings, the physical and operational characteristics must be reviewed and upgraded to meet minimum standards. Recommendations must be made by the District Railroad Coordinator for incorporation into the project.

See **Design Standards, Index 560** for minimum vertical alignment criteria.

See **Chapter 6** of this Volume and the **Design Standards** for additional information.

25.4.21 Aesthetics and Landscaping

Landscaping, including median and intersection treatment, must be consistent with the criteria in this manual and the **Design Standards, Index 546**. Landscape improvements are normally done in response to local government requests and may involve intergovernmental agreements to cover the cost of installation as well as maintenance.

Due to funding limitations, improvements other than those needed for safety and minimum criteria must be carefully considered before inclusion in the project (see **Section 25.2**).

See **Chapter 9** of this Volume for additional information and requirements on landscaping.

25.4.22 Highway Lighting

Lighting may be installed at specific locations to improve safety. For example:

1. Reducing the effects of ambient light conditions.
2. Busy or high crash intersections.
3. Transit stops.
4. Channelized intersections.
5. Car pool parking lots.
6. Pedestrian and bicycle crossings.
7. Ramp terminals.

Any lighting, existing or proposed, must be reviewed by the District Lighting Engineer to determine specific needs. Lighting must meet new lighting criteria, found in **Chapter 7** of this Volume.

25.4.23 Highway Traffic Control Devices

Update traffic control devices such as signals, signing, and pavement markings as required to comply with the **Manual on Uniform Traffic Control Devices**, the **Manual on Uniform Traffic Studies**, the Department's **Design Standards** (excluding the structures of such traffic control devices per **Section 25.4.26** of this Volume), and the ADA design guidelines issued by the Secretary of the U.S. Department of Transportation. The District Traffic Operations Engineer (or staff) must determine any new or additional devices required.

25.4.24 Bridges

On each project, a determination must be made as to whether an existing bridge should remain as is, be rehabilitated or be replaced. This determination should be made as early as practical due to the potential impact to the work program. Pavement resurfacing funds can only be used for minor bridge improvements such as rail retrofits and ADA improvements. Bridges that require major improvement or replacement must be programmed with the appropriate bridge program funds.

The determination of bridge improvement needs must be supported by an engineering analysis/report and be based on an assessment of the bridge's structural and functional adequacy. The engineering report must include the project description, an operational impact evaluation, safety impacts, and a benefit/cost analysis. The safety impacts must include a detailed review of crash history, severity, contributing factors, etc. If the engineering analysis determines it is not feasible to bring the bridge in full compliance with minimum criteria, a Design Exception or Design Variation addressing the feature(s) not meeting criteria must be processed in accordance with **Chapter 23** of this volume. The engineering analysis/report should be used to support the Design Exception or Design Variation.

If a bridge is found to be functionally obsolete but structurally sound, complete replacement is usually not warranted. For these type structures a full range of possible improvements must be considered, including improvements that enhance safety but do not necessarily bring the bridge into full compliance with minimum criteria. Improvements such as upgrading of connecting guardrail systems, approach roadway or shoulder widening, "Narrow Bridge Ahead" signing, or other appropriate feature modifications should be considered as appropriate. Widening of the structure itself, or rail retrofit, are also options that should be addressed. The designer should always review the Department's work program to see if a structure is scheduled for replacement in the near future, before determining short term improvements.

If the structure is on the Strategic Intermodal System (SIS), the designer should also consider any improvements based on future alignment and possible lane additions required for an SIS corridor. For example: if a bridge is to be replaced, the corridor is on the SIS, and the project will be multi-laned in the future, the new bridge should be aligned to fit future typical sections.

25.4.24.1 Bridge Loading

See **Section 26.17** of this Volume for load rating requirements.

25.4.24.2 Bridge Width

Bridges must meet or exceed the following clear width criteria. If lane widening is planned as part of the RRR project, the minimum useable bridge width must be determined using the width of approach lanes after widening.

Table 25.4.24. 1 Clear Width Criteria for Bridges

Design Year ADT		Minimum Usable Bridge Width (ft.)
UNDIVIDED	0 - 750	Total width of approach lanes + 4
	751 +	Total width of approach lanes + 8
DIVIDED	ALL	Total width of approach lanes + 5.5 (median separator) * Total width of approach lanes + 6.5 (median barrier wall)**
ONE WAY BRIDGES	ALL	Total width of approach lanes + 6.5 (2.5 Lt. and 4.0 Rt.)

* 1.5 ft. median and 4 ft. outside shoulder

** 2.5 ft. median and 4 ft. outside shoulder

If widening is required, it must be in accordance with the **Structures Design Guidelines** and meet the geometric requirements for new construction.

25.4.24.3 Bridge Railing

For RRR requirements of bridge traffic railings, refer to **Chapter 4** of this Volume.

25.4.24.4 Vertical Clearance

For vertical clearance requirements for bridges, refer to **Section 25.4.13**.

25.4.24.5 Considerations

When evaluating bridge replacement or widening, the following should be considered:

1. Cost of replacing the existing bridge with a wider bridge designed to new bridge criteria.
2. Cost of widening the existing bridge (if widening is practical), including life cycle costs of maintaining a widened bridge.
3. The number of crashes that would be eliminated by replacement or widening.
4. The hydraulic sufficiency and the risk of failure due to scour and/or ship impact as well as the consequences of failure.

25.4.24.6 Pier Protection

To assess the need for pier protection, refer to **Chapter 4** of this Volume.

25.4.25 Roadside Safety Hardware

For RRR requirements of Roadside Safety Hardware, refer to **Chapter 4** of this Volume.

25.4.26 Ancillary Structures (Sign, Signal, Lighting and ITS)

For the purposes of this section, existing sign, signal, lighting and ITS support structures (ancillary structures) on a project are classified into one of the following categories:

1. Existing Ancillary Structures Without Proposed Additional Loading: existing support structures left in place or existing support structures modified with equivalent (or smaller) components.
2. Existing Ancillary Structures With Proposed Additional Loading or Relocated Ancillary Structures: existing support structures modified with additional components, existing support structures modified with larger components, existing support structures whose proposed attachments produce loads on any component greater than the design loading and/or existing support structures relocated to another location.

Additionally, evaluations of ancillary structures are categorized as follows:

1. Condition Evaluation:

A physical and functional assessment based on inspection data that includes damage, deterioration, or other potential defects that may cause a reduction in service life or design capacity.

2. Analytical Evaluation:

A structural capacity analysis ranging from the review of structural plans, design calculations and shop drawings (if available) to a detailed structural analysis. Contact the District Structures Design Office (DSDO) for guidance on the extent of analysis required and for guidance on analyzing existing ancillary structures without plans, shop drawings, foundation depths, or design calculations.

Submit an Ancillary Structures Report to the District Structures Maintenance Engineer (DSME) and the District Structures Design Office (DSDO) containing the following information:

1. Listing of all ancillary structures within the project including the proposed disposition (remain in place, relocated, replaced, etc.)
2. Condition Evaluation for all ancillary structures within the project
3. Analytical Evaluation of all ancillary structures within the project that are proposed with additional loading and/or relocated
4. If required by the DSME, Analytical Evaluation of 50 year design life ancillary structures (overhead sign structures, high mast light poles, traffic mast arms and steel strain poles) that are proposed to remain in place without proposed additional loading.

Obtain written concurrence from the DSME on the EOR's recommendations in the Ancillary Structures Report.

25.4.26.1 Analytical Evaluation Without Proposed Additional Loading

If a detailed Analytical Evaluation is required, evaluate the as-built capacity (no allowances for future loads) in accordance with the **Structures Manual, Volume 3, Section 18.2**. Report the Demand/Capacity (D/C) ratios and Combined Stress Ratios (CSRs). If all D/C ratios and CSRs are less than one, the structure meets FDOT structural requirements. If any D/C ratios or CSRs are greater than one, strengthening or replacement is required unless a Design Variation is approved.

Ancillary structures without proposed additional loading typically do not require analysis for fatigue (welds) or foundations; however, welding details and foundations should be checked in the Analytical Evaluation in situations where there is evidence of distress, instability, or the Structures EOR or DSME has reason to believe the capacity is in doubt.

25.4.26.2 Analytical Evaluation With Proposed Additional Loading or Relocated Structures

Provide a detailed Analytical Evaluation of the proposed structure with structure criteria in accordance with the **Structures Manual Volume 3, Section 18.3**. Report the D/C ratios and CSRs. If any D/C ratios or CSRs are greater than one, strengthening or replacement is required unless a Design Variation or Design Exception is approved as described below.

An approved Design Variation is required if the proposed structure fails to meet the structure requirements in the **Structures Manual Volume 3, Section 18.3** but does meet the criteria in **Structures Manual Volume 3, Section 18.2**. An approved Design Exception is required if the proposed structure fails to meet the requirements in the **Structures Manual Volume 3, Sections 18.2 and 18.3**.

25.4.27 Median Policy for Multilane Facilities

It is recommended to provide raised or restrictive medians as discussed in **Section 2.2.2** of this Volume.

25.5 Design Exceptions and Design Variations

Every effort should be made to adhere to the desirable criteria stated herein. However, under unusual conditions, it may be necessary and appropriate to use values that are less than the minimum values shown. If lesser values are proposed for use, these must be identified and the necessary approval and concurrence obtained at the earliest possible time, but not later than Phase II, so that the denial of any such request will not alter the project letting date. Refer to **Chapter 23** of this Volume for the necessary procedure.

Chapter 26

Bridge Project Development

26.1	General	26-1
26.2	Organization.....	26-2
26.3	Definitions	26-2
26.3.1	Category 1 Structures	26-2
26.3.2	Category 2 Structures	26-2
26.4	Abbreviations and Acronyms Used in Structures Design.....	26-4
26.5	Responsibility	26-6
26.6	FHWA Oversight	26-7
26.7	Bridge Project Development.....	26-7
26.8	Bridge Analysis	26-9
26.8.1	General	26-9
26.8.2	Contents.....	26-9
26.9	Bridge Development Report (BDR)/30% Structures Plans	26-10
26.9.1	General	26-10
26.9.2	Contents.....	26-11
26.9.3	Format.....	26-14
26.9.4	Aesthetics	26-15
26.9.5	Construction and Maintenance Considerations	26-17
26.9.6	Historical Significance Considerations.....	26-17
26.9.7	Bridge Security.....	26-18
26.9.8	Alternative Designs	26-19
26.9.9	Conclusions and Recommendations	26-19

26.9.10	30% Structures Plans.....	26-20
26.10	Bridge Development Report (BDR) Submittal Checklist.....	26-22
26.11	Final Plans and Specifications Preparation	26-24
26.11.1	General	26-24
26.11.2	60% Substructure Submittal / 60% Structures Plans	26-24
26.11.3	90% Structures Plans.....	26-26
26.11.4	100% Structures Plans and Specifications	26-26
26.12	Independent Peer Review of Category 2 Bridges	26-27
26.13	Plans Assembly.....	26-29
26.14	Plans Submittal	26-29
26.14.1	Schedule	26-29
26.14.2	Submittal Schedule	26-29
26.14.3	Summary of Phase Submittals	26-29
26.15	Review for Constructability and Maintainability.....	26-32
26.15.1	Purpose.....	26-32
26.15.2	Responsibility	26-32
26.16	Review for Biddability	26-33
26.16.1	Purpose.....	26-33
26.16.2	Responsibility	26-33
26.17	Bridge Load Rating	26-34
26.18	Review of Non-FDOT Funded Projects (New Construction).....	26-35

Exhibits

Exhibit 26-A	Bridge Development Report (BDR) Submittal Checklist.....	26-36
Exhibit 26-B	Independent Peer Review Certification Letter (90% Submittal).....	26-37
Exhibit 26-C	Independent Peer Review Certification Letter (100% Submittal).....	26-38
Exhibit 26-D	Summary of Phase Submittals	26-39
Exhibit 26-E	Summary of Phase Submittals - Movable Bridges	26-41
Exhibit 26-DD	Summary of Design/Build Technical Proposal and Component Plan Submittals	26-46
Exhibit 26-EE	Summary of Design/Build Technical Proposal and Component Plan Submittals – Movable Bridges	26-49
Exhibit 26-F	Precast Alternate Development.....	26-55

THIS PAGE LEFT BLANK INTENTIONALLY

Chapter 26

Bridge Project Development

26.1 General

All structural designs for new construction for the Florida Department of Transportation (FDOT) are developed under the direction of the Structures Design Office (SDO) and/or the District Structures Design Offices (DSDO).

Modification for Non-Conventional Projects:

Delete the above paragraph.

All designs are to be developed in accordance with the **Structures Manual (Topic No. 625-020-018)** (which includes the **Structures Design Guidelines**, the **Structures Detailing Manual**), this Manual, the **Design Standards (Topic No. 625-010-003)**, and the **AASHTO-LRFD Bridge Design Specifications** as referenced in the Structures Manual, applicable FHWA Directives, and other criteria as specified by the Department.

Designs for repair or rehabilitation of bridges are generally developed under the direction of the District Structures Maintenance Engineer (DSME) and may not include all the submittal types discussed in this chapter.

Modification for Non-Conventional Projects:

Delete the above paragraph.

Structures for other agencies or authorities such as the Jacksonville Transportation Authority, various Expressway Authorities, etc. may be designed to meet the Department's criteria or additional criteria as specified by the authority.

For projects involving bridges over navigable water, notify the District Structures Maintenance Engineer (DSME) a minimum of 90 days prior to engaging in any action in, on, or around the bridge. Refer to **Section 13.5.3** of this Volume for further information.

26.2 Organization

The Structures Design Office (SDO) is a subdivision of the Office of Design under the direction of the Chief Engineer and the Assistant Secretary for Engineering and Operations. The SDO is under the direction of the State Structures Design Engineer (SSDE). Each District, including the Turnpike, has a staff of structural design engineers that comprise the District Structures Design Office (DSDO), and which is under the direction of the District Structures Design Engineer (DSDE).

26.3 Definitions

All structures are grouped into the following two categories based upon design difficulty, structural complexity, type of construction materials used and history of use in Florida.

26.3.1 Category 1 Structures

The following structure types are classified as Category 1 Structures:

1. Box or three-sided culverts
2. Bridges with simple or continuous span reinforced concrete slab superstructures
3. Bridges with prestressed concrete slab superstructures
4. Bridges with simple span non-posttensioned concrete beam or concrete girder superstructures with cast in place decks
5. Widening for the structure types listed above
6. Steel truss pedestrian bridges utilizing proprietary designs
7. Retaining walls
8. Roadway signing, signalization and lighting supports
9. Overhead sign structures and toll gantries
10. Noise walls and perimeter walls

26.3.2 Category 2 Structures

All structure types not listed above are classified as Category 2 Structures unless exempted by the SDO. In addition to, or in lieu of, the criteria listed above, a structure is classified as a Category 2 Structure when any of the following are present:

1. Bridge substructures containing post-tensioned components, straddle piers and/or integral caps
2. Bridges designed for vessel collision
3. Bridges with non-redundant foundations
4. Any component designed using Fiber Reinforced Polymer (FRP) composite materials
5. Braided underpass structures where the beams or flat slab superstructure element is not oriented parallel to traffic of the overlying roadway and a portion of the superstructure and substructure extends beyond the limits of the overlying traffic barriers
6. Design concepts, components, elements, details or construction techniques not normally used by Florida DOT including but not limited to:
 - a. New bridge types
 - b. New materials used to construct bridge components
 - c. New bridge construction methods
 - d. Non-standard or unusual bridge component-to-component configurations and connection details
 - e. Department issued Developmental Design Standards or modified versions of Developmental Design Standards
 - f. Items not covered by the Department's Standard Construction Specifications
 - g. All atypical precast structural elements (The following are not considered to be atypical: Segmental Box Girder Superstructure Components, Spliced I and U-Girders, AASHTO Beams, and precast elements included in the **Design Standards**.)

Commentary: The Department supports the use of accelerated project construction techniques including the expanded use of precast/prefabricated bridge elements and systems as a way to reduce costs, construction time, and user impacts. However, the use of precast/prefabricated bridge elements can create long term durability and quality issues depending on the details utilized. Therefore, the designs and details for these elements must be approved by the Department prior to use.

Modification for Non-Conventional Projects:

Items listed in Numbers 4 thru 6 above are not allowed unless they are specifically permitted in the RFP or unless they are submitted and approved during the Alternative Technical Concept (ATC) process.

26.4 Abbreviations and Acronyms Used in Structures Design

Terminology used in the area of Structures Design for the Florida Department of Transportation often is written or spoken in the form of abbreviations and/or acronyms. Following is a list of acronyms frequently encountered in this manual and in other references used in structures design and include those commonly used for offices, organizations, materials, systems, features, equipment, conditions, and expertise:

AASHTO	<i>American Association of State Highway and Transportation Officials</i>
ACI	<i>American Concrete Institute</i>
ACIA	<i>Assigned Commercial Inspection Agency</i>
ADA	<i>Americans with Disabilities Act</i>
AISC	<i>American Institute of Steel Construction</i>
ANSI	<i>American National Standards Institute</i>
APL	<i>Approved Products List</i>
AREMA	<i>American Railway Engineering and Maintenance Association</i>
ASTM	<i>American Society for Testing and Materials</i>
AWS	<i>American Welding Society</i>
BBS	<i>Bulletin Board System</i>
BDR	<i>Bridge Development Report</i>
BHR	<i>Bridge Hydraulics Report</i>
BHRS	<i>Bridge Hydraulics Recommendation Sheet</i>
CADD	<i>Computer Aided Design and Drafting</i>
CEI	<i>Construction Engineering and Inspection</i>
C.I.P. (C-I-P)	<i>Cast-in-Place (Concrete)</i>
CSIP	<i>Cost Savings Initiative Proposal</i>
CPAM	<i>Construction Project Administration Manual</i>
CVN	<i>Charpy V-Notch (Impact Testing)</i>
DSDE	<i>District Structures Design Engineer</i>
DSDO	<i>District Structures Design Office</i>
DSME	<i>District Structures Maintenance Engineer</i>
OEM	<i>Office of Environmental Management</i>
EOR	<i>Engineer of Record</i>
FDOT	<i>Florida Department of Transportation</i>
FHWA	<i>Federal Highway Administration</i>
LRS	<i>Low-relaxation Strands</i>
LRFD	<i>Load and Resistance Factor Design</i>
MHW	<i>Mean High Water</i>
MSE	<i>Mechanically Stabilized Earth (Walls)</i>
MUTCD	<i>Manual on Uniform Traffic Control Devices</i>

<i>NBR</i>	<i>Nominal Bearing Resistance</i>
<i>NHS</i>	<i>National Highway System</i>
<i>NHW</i>	<i>Normal High Water</i>
<i>NOAA</i>	<i>National Oceanic and Atmospheric Administration</i>
<i>OIS</i>	<i>Office of Information Systems</i>
<i>OSHA</i>	<i>Occupational Safety and Health Administration</i>
<i>PDA</i>	<i>Pile Driving Analyzer</i>
<i>PD&E</i>	<i>Project Development and Environment</i>
<i>PPD</i>	<i>Plans Production Date</i>
<i>PPM</i>	<i>Plans Preparation Manual</i>
<i>RDR</i>	<i>Required Driving Resistance</i>
<i>SDO</i>	<i>Structures Design Office</i>
<i>SIP (S-I-P)</i>	<i>Stay-in-Place (Forms)</i>
<i>SRS</i>	<i>Stress-relieved Strands</i>
<i>SSDE</i>	<i>State Structures Design Engineer</i>
<i>TAG</i>	<i>Technical Advisory Group (SDO and DSDEs)</i>
<i>TFE (PTFE)</i>	<i>Polytetrafluoroethylene (Teflon)</i>
<i>TRB</i>	<i>Transportation Research Board</i>
<i>TTCP</i>	<i>Temporary Traffic Control Plans</i>
<i>UBC</i>	<i>Ultimate Bearing Capacity</i>
<i>UV</i>	<i>Ultraviolet</i>

Modification for Non-Conventional Projects:

Expand ***PPM*** 26.4 with the following abbreviation.

<i>RFP</i>	<i>Request For Proposal</i>
-------------------	------------------------------------

26.5 Responsibility

The District Structures Design Office has total project development and review responsibility for projects involving Category 1 Structures. The Structures Design Office has total project development and review responsibility for projects involving Category 2 Structures. This responsibility for Category 2 Structures extends to widening and rehabilitation projects and repairs of bridge components that qualify the structure as a Category 2 Structure. For large projects with multiple bridges, review responsibilities will be coordinated between the District Structures Design Office and the Structures Design Office based on the category of the individual bridge, work load demands and project make-up. Where the majority of the structures on a large multi-bridge project are Category 2, the Structures Design Office will have total project development and review responsibility for the entire project; where the majority of the structures are Category 1, the Structures Design Office will have project development and review responsibility for the Category 2 bridges only, and the District Structures Design Office will have project development and review responsibility for the Category 1 bridges.

The District Project Manager must coordinate with the District Structures Design Engineer who will review and concur with the bridge aspect of all projects during the PD&E process in accordance with **Part 2, Chapter 3** of the **PD&E Manual**.

The District Structures Design Engineer or the State Structures Design Engineer, as appropriate, must concur/approve all bridge related work after location design approval is granted.

To assure a uniform approach to a project, the engineer must coordinate with the appropriate Structures Design Office to discuss structures related phase review comments and get concurrence on how to proceed.

Modification for Non-Conventional Projects:

Delete **PPM 26.5** and replace with the following:

26.5 Responsibility

Submit RFP's on those projects where it is anticipated that Category 2 bridges will be designed and constructed to the State Structures Design Engineer for review and approval. Submit RFP's on those projects where it is anticipated that Category 1 bridges will be designed and constructed to the District Structures Design Engineer for review and approval.

The District Structures Design Office has total component structure plan review responsibility for projects involving Category 1 Structures. The Structures Design Office has total component structure plan review responsibility for projects involving Category 2 Structures. This responsibility for Category 2 Structures extends to widening and rehabilitation projects and repairs of bridge components that qualify the structure as a Category 2 Structure. The District Structures Design Engineer or the State Structures Design Engineer, as appropriate, determine when structure component plans should be "Released for Construction."

The District Project Manager must coordinate with the District Structures Design Engineer who will review and concur with the bridge aspect of all projects during the PD&E process in accordance with **Part 2, Chapter 3** of the **PD&E Manual**.

26.6 FHWA Oversight

See **Chapter 24** of this Volume for FHWA requirements.

26.7 Bridge Project Development

The following sections will define, clarify and list the information necessary to produce an acceptable and reproducible set of contract documents (special provisions, bridge contract drawings, etc.) ready for advertisement and construction.

Bridge project development normally includes five phases of development. The first phase of development, bridge analysis, occurs during the Project Development and Environment (PD&E) process. After location design approval is granted, the second phase, Bridge Development Report/30%Structures Plans, is initiated. After approval of

the BDR, the final phases of work will begin. The third phase is the 60% Structures Plans that consists of the substructure foundation submittal for all projects and 60% Structures Plans for most Category 2 Structures. The fourth phase includes the 90% Structures Plans and specifications. The fifth phase includes the 100% Structures Plans and specifications. For efficiency, one engineering firm (one design team) should be responsible for the BDR and the final plans and specifications.

For Category 2 bridges and some Category 1 bridges, step negotiations are suggested. Step negotiations are desirable because the final bridge type cannot be determined until the BDR is complete. Utilizing this scenario, the first step of the negotiations would include the BDR/30% Structures Plans. After submittal of the BDR/30% Structures Plans, negotiations for final three phases of work (60% Structures Plans, 90% Structures Plans and 100% Structures Plans) would begin. Negotiations should not be finalized until the BDR/30% Structures Plans are approved by the DSDO or the SDO as appropriate.

Modification for Non-Conventional Projects:

Delete **PPM** 26.7 and replace with the following:

26.7 Bridge Project Development

Bridge project development normally includes four phases of development. The first phase of development, bridge analysis, occurs during the Project Development and Environment (PD&E) process. The second phase includes the development of the bridge related project constraints based on project specific requirements and development of the bridge concept plans for inclusion into the RFP. A series of pre-scoping questions has been compiled and are available on the Office of Construction website to aid in the development of project specific constraints. Depending on the complexity of the project and at the discretion of the Department, this second phase may include a Bridge Feasibility Assessment for the purpose of developing the structures concept plans. The third phase involves the project procurement process. See [Procurement and Administration Procedure \(Topic No. 625-020-010\)](#) for specific requirements. The fourth phase includes component structure plan reviews in accordance with the requirements of the RFP.

26.8 Bridge Analysis

26.8.1 General

The Bridge Analysis is performed during the PD&E phase by qualified bridge engineers. The District Structures Design Engineer must concur with the findings of the bridge analysis, which is part of the preliminary engineering report. The function of the bridge analysis is to determine the general attributes for the recommended bridge. The specific attributes of the bridge will be defined in the BDR.

For bridges over water, a location Hydraulics Report will be prepared in conjunction with the bridge analysis. General site geotechnical knowledge is also required (usually from existing bridge plans) or, in some cases, it may be desirable to obtain borings.

26.8.2 Contents

The bridge analysis provides conceptual guidance for the bridge design consultant. Conceptual guidance on how the bridge should fit into the uniqueness of the site should be provided. Bridge design and structure type should be left to the design team in the later phases of work. Include the following in the bridge analysis:

1. Environmental and site considerations, including the need for wildlife connectivity (see **Section 13.5.4** of this Volume).
2. Vertical and horizontal clearances (existing and proposed).
3. Disposition of existing structure. (Final disposition of demolished bridge debris will depend on whether or not a local, State or Federal agency has agreed to receive the debris. See **Section 13.5.2.3** of this Volume).
4. Vertical and horizontal geometry.
5. Typical section.
6. Conceptual ship/barge impact data (sample of recreational and commercial traffic).
7. Identification of historical significance of bridge and surrounding structures.
8. Aesthetic level for bridge and bridge approaches.
9. Location Hydraulics Report.
10. Bridge deck drainage considerations.
11. Stream bottom profile.
12. Conceptual geotechnical data.
13. For sites with movable bridge options, a life cycle cost comparison will be prepared and compared to a fixed bridge.
14. Phase Construction Impacts.
15. Construction time.

26.9 Bridge Development Report (BDR)/30% Structures Plans

26.9.1 General

The BDR is intended to establish all the basic parameters that will affect the work done in the Design and Plans Preparation phase. Initiate the BDR after Location Design Concept Acceptance (LDCA) (For those sites not requiring LDCA, a Type 1 Categorical Exclusion will be required before initiation of the BDR). Once approved, the BDR will define the continuing work by the Engineer of Record (EOR). It is mandatory that the EOR obtain and coordinate the information and requirements of the offices and engineering disciplines whose input is essential to the preparation of an effective BDR. Changes to the parameters after the BDR is approved could result in schedule delays and supplemental agreements; therefore, it is critical that District Offices, FHWA (if involved), the Structures Design Office and other involved agencies recognize the purpose and importance of the BDR. The BDR phase of work will contain sufficient detail for the justification of the proposed bridge type. For most projects, the 30% Structures Plans will be included as an appendix to the BDR. The BDR is developed from information outlined on the Bridge Development Report Submittal Checklist shown in **Exhibit 26-A**, located at the end of this chapter. This information is often provided by others; however, the EOR is responsible for ensuring that all of the information is adequate and appropriate. If the data is not sufficient, the EOR must obtain the required information before the BDR can be completed and submitted.

When alternate designs are considered, consistency between the alternates is essential in ensuring equitable competition and optimum cost-effectiveness. This consistency includes uniformity of design criteria, material requirements and development of unit costs.

The BDR should contain only supportable and defensible statements. Subjective opinions or unsubstantiated statements are not acceptable. All arguments are to be clearly and logically defensible with calculations, sketches or other technical data.

The quantity of work necessary to prepare the BDR depends upon the project's complexity; however, the usual work effort for bridge types normally encountered is:

1. **Minor Bridge Widening:** The BDR will be a minor work effort; however, viable structural possibilities and economical options should be thoroughly investigated to determine if replacement of the bridge would be more appropriate than its widening. This is particularly true at sites where the existing bridge condition is marginal, where there has been a record of serious flooding or scouring, when

the widening is part of a route improvement with a high potential for attracting traffic, if the existing bridge has a history of structural problems (including vessel collision), or if the inventory rating is less than required by AASHTO and cannot be improved. Load rating considerations that are to be included in the BDR recommendations are provided in **Section 7.1.1** of the **Structures Design Guidelines**.

2. Minor Grade Separations or Small Water Crossings: The BDR will be a thorough document that adequately addresses all viable structure types; however, the BDR will not usually be an extensive document since the viable types of superstructure and substructure are generally limited. The report is to consider scour, vessel collision, and wildlife connectivity.
3. Major Bridges (including Movable) and Major Interchanges: The BDR will be an extensive and comprehensive document that thoroughly considers all viable structure types and considers all design parameters (such as scour, vessel collision and wildlife connectivity).

26.9.2 Contents

The major items to be considered in the BDR are:

1. General: The bridge length, height and pier locations are subject to vertical and horizontal design clearance requirements such as those for clear zone, navigation, wildlife connectivity, and hydrology. After these considerations are met, span lengths are governed by economics and aesthetic considerations. Superstructure depths (grade separation structures in particular) are to be kept to the minimum that is consistent with good engineering practice. Recommended span/depth ratios for steel superstructures are shown in AASHTO.

The length of the bridge will be affected by:

- a. Opening required by the Bridge Hydraulic Report.
 - b. Environmental Considerations, including wildlife connectivity (see **Section 13.5.4** of this Volume).
 - c. Railroad clearances and cross sections.
 - d. Width of waterway and/or width of cross section of roadway being spanned including the use of retaining walls, or fender systems.
2. Statical System: Address the economic and engineering advantages of both simple span and continuous spans.
 3. Superstructure: Some superstructure types that could be considered are prestressed concrete girders, inverted-tee sections, reinforced or prestressed concrete slabs, steel rolled sections or plate girders, steel or concrete box girders, and post tensioned slabs, bulb-tees or boxes.

4. Substructures: Some substructure types that could be considered are pile bents and multi-column or hammerhead piers. Variations of column shapes may be appropriate for aesthetic or economical requirements.
5. Foundations: Some foundation types that could be considered are steel and concrete piles, drilled shafts, geosynthetic reinforced soil (GRS) abutments and spread footings. Assess GRS abutments to determine feasibility for all new bridges.
6. Vessel Collision: Vessel collision forces will often have a major effect on the structural configuration and overall economics. See vessel collision requirements in the **Structures Design Guidelines**.
7. Scour: The 100 year and 500 year predicted scour elevations will often have a major effect on the foundation design. See the foundations and geotechnical requirements in the **Structures Design Guidelines**.
8. Temporary Traffic Control: Show how traffic will be maintained during construction for each of the bridge alternates considered. Assess the impacts of the traffic carried on the structures as well as under the structures being constructed. Consider all major overhead work items such as bridge demolition and girder placement. Show stability towers locations, phased construction sequences, girder splice locations, etc., for each alternate being considered. Compare traffic user impacts for each of the alternates.
(See **Section 10.4** of this Volume for additional requirements)
9. Precast Bridge Options: Investigate the use of either partial or full precast bridge alternate(s) with the specific purpose of accelerating bridge construction and reducing user impacts. As part of this investigation:
 - A. Conduct a feasibility assessment responding to questions similar to those listed in **Exhibit 26-F**.
 - B. Based on responses to the feasibility questions, explain whether a precast alternate should be considered an advantage on the project or what site constraints, economic impacts, or other factors (e.g., haul distance from precast yard, project variability, etc.) precluded or limited its application. If precasting is determined not to be applicable for the project, provide a statement in the BDR indicating so and the reasons why. This statement fulfills the requirements of this section.
 - C. Only if precasting is found to be viable, evaluate preliminary precast alternates and associated MOT schemes against conventional methods using the assessment matrix and referenced links given in **Exhibit 26-F**. Provide enough detail in the preliminary evaluation in order to estimate total direct and indirect costs. Indirect costs, typically referred to as road user costs, include fuel use and man-hour losses resulting from detours, anticipated traffic flow reduction, and reduced speed limits. Determine indirect costs using the

Department's software at the following link:

<http://infonet.dot.state.fl.us/tlconstruction/SchedulingEng/AddSoftwareScheduling.htm>

At this stage, a meeting with the District Structures Design Engineer is recommended to discuss the preliminary evaluation and cost estimates before finalizing the alternates for inclusion in the BDR.

- D. See **Chapter 25** of the **Structures Detailing Manual** for design considerations as it relates to Prefabricated Bridge Elements and Systems (PBES).
- E. Report the estimated total direct costs and estimated total indirect costs, as well as the sum of both, for *each* alternate as three separate dollar amounts in a summary table in the same section as the completed assessment matrix (see "Alternate Cost Summary" table in **Exhibit 26-F**).

The Structures Design office has developed several training videos for the purpose of educating designers on factors for consideration related to use of Prefabricated Bridge Elements and Systems (PBES) for Accelerated Bridge Construction (ABC). The main emphasis of the training videos is to demonstrate the sort of factors and project constraints that influence whether bridge components should be used. Also discussed are overall prefabricated ABC strategies and implications, including examples showing how labor, material, and equipment costs are considered.

These training videos have been posted on a website along with notification of upcoming developments and helpful links to related external websites. The Department's Structures Design Office website for Every Day Counts can be viewed at: <http://www.dot.state.fl.us/structures/edc>

Commentary: Providing both the direct and indirect costs of the project in the BDR enables Department management to make informed decisions to maximize construction dollars while at the same time minimizing construction time and economic impacts to Florida's traveling public.

Also, demonstrate in the BDR text that consideration was given to identify and employ other innovative techniques aimed at reducing costs, shortening project delivery time, enhancing safety during construction, and protecting the environment.

- 10. Quantity estimates: For minor bridges rough quantities (such as reinforcing steel based on weight per volume of concrete) may be sufficient. For major and complex bridges the degree of accuracy may require more exact calculations keeping in mind that the intent is to establish relative and equitable costs between alternates and not necessarily to require the accuracy of the Final Estimate. For major and complex structures it may be necessary to develop unit costs from an analysis of fabrication, storage, delivery and erection costs of the different components. Provide calculated debris volume quantities for projects involving the demolition of bridges.

11. Unit costs: Data available from the FDOT or contractors and suppliers should be used to arrive at unit costs. Record the sources of all price data for later reference. Base cost should be obtained from the ***BDR Estimating Section*** of the ***Structures Manual***.
12. Develop cost curves: For each alternative establish the most economical span arrangement, i.e., minimum combined superstructure and substructure cost.
13. Retaining Wall Study: If retaining walls are present, include a retaining wall study in the BDR. This study will conform to the work as specified in ***Chapter 30*** of this Volume and the ***Structures Manual***.
14. Movable Bridges: Include information in the BDR on the type of equipment for the machinery and electrical drive systems, together with a general description of the control system to be utilized. Include a written description and preliminary layouts of system components.
15. Bicycle and Pedestrian Facilities: Describe in the BDR the facilities to be provided and the means to be used to comply with ADA requirements and ***Chapter 8*** of this Volume.

For rehabilitation project plans, include the BDR stage in the plans and written descriptions of those system components to be modified from the existing configuration, along with plans of the existing configuration. Submittal of information described in the previous paragraph is not required unless the electrical and mechanical configuration is modified from the existing configuration.

26.9.3 Format

The report is to use standard, letter-size pages with any larger sheets or drawings folded to fit the report size. The report is to be neatly written and the contents presented in a logical sequence with narrative, as required, to explain the section contents. Provide an Executive Summary to compare the relative features and costs of the alternates considered and recommend alternate(s) to be carried forward into the Final Structures Plans Preparation phase.

The BDR is to be as self-contained as possible by including all arguments that establish, justify, support, or prove the conclusions. It is acceptable to make reference to other documents that will be included in the final submittal package; however, include any documentation that will help emphasize a point, support a statement, or clarify a conclusion. Such documentation may include drawings, clear and concise views, or other such illustrated information.

Address construction time requirements in the BDR and the effect that components, systems, site constraints and conditions, or other site characteristics or criteria have upon the construction time, whether additive or deductive.

For most projects, the 30% Plans must be an appendix to the BDR.

26.9.4 Aesthetics

1. General: Integrate three basic elements in any bridge design: efficiency, economy and elegance. Regardless of size and location, the quality of the structure, its aesthetic attributes and the resulting impact on its surroundings is to be carefully considered. Achieving the desired results involves:
 - a. Full integration of the three basic elements listed previously.
 - b. The EOR's willingness to accept the challenge and opportunity presented. A successful bridge design will then be elegant or aesthetically pleasing in and of itself and will be compatible with the site by proper attention to form, shapes and proportions. Attention to details is of primary importance in achieving a continuity of line and form. Use the rule of "form following function."

Consider the totality of the structure as well as its individual components and the environment of its surroundings. A disregard for continuity or lack of attention to detail can negate the best intent. Formulas cannot be established; however, the ACI's ***Aesthetic Considerations for Concrete Bridges*** and the TRB's ***Bridge Aesthetics Around the World*** as well as authors such as David P. Billington can guide the designer. A book developed by the Maryland Department of Transportation entitled ***Aesthetic Bridges*** provides excellent guidance. In bridge aesthetics the designer is dealing with the basic structure itself; not with enhancement, additions or other superficial touches. The EOR is expected to be well read on the subject of bridge aesthetics and committed to fulfilling both the structural and aesthetic needs of the site.

The challenge differs for major and minor structures. Indeed, the challenge may be greater the smaller the project. Major structures, because of their longer spans, taller piers, or curving geometry often offer inherent opportunities not available for minor bridges.

Some basic guidelines where aesthetics may play a more important role are:

- a. Bridges highly visible to large numbers of users (maritime and/or motorists).
- b. Bridges located in or adjacent to parks, recreational areas, or other major public gathering points.
- c. Pedestrian bridges.

- d. Bridges in urban areas in or adjacent to commercial and/or residential areas.
- e. Multi-bridge projects, such as interchanges, or corridors should attain conformity of theme and unifying appearance. Avoid abrupt changes in structural features.

Considering these guidelines, the District will determine the level of aesthetic effort warranted on a project early in its development. When significant aesthetic expense is proposed, such as is the case with Level Three (Level of Aesthetics), Federally funded projects require legitimate written justification.

2. Levels of Aesthetics:

Normally the District will establish one of the following three general levels of aesthetic consideration and effort at each structure's site:

- a. **Level One:** Consists of cosmetic improvements to conventional Department bridge types, such as the use of color pigments in the concrete, texturing the surfaces, modifications to fascia walls, beams, and surfaces, or more pleasing shapes for columns and/or caps.
- b. **Level Two:** The emphasis is on full integration of efficiency, economy and elegance in all bridge components and the structure as a whole. Consideration should be given to structural systems that are inherently more pleasing, such as hammerhead or "T" shaped piers, oval or polygonal shaped columns, integral caps, piers in lieu of bents, smooth transitions at superstructure depth change locations, box-type superstructures, concealed drain pipes, conduits and utilities, etc.
- c. **Level Three:** The emphasis in this level applies more to the overall aesthetics when passing through or under an interchange or at other sites such as historic or highly urbanized areas where landscaping or unique neighborhood features are to be considered. The bridge itself must comply with Level Two requirements. This level of work may require, at the District's option, a sub-consultant (architect to consider adjacent building styles, and landscape themes) with the necessary expertise and credentials to perform the desired work.

These aesthetic levels are not exclusive. For example, where the EOR believes a specific landscape feature might significantly enhance bridge site elegance, even on a Level 1 design, the recommendation should be offered for the Department's consideration. For aesthetic Levels 2 and 3, public input into this issue may be appropriate. The EOR may recommend particular public involvement to the Department for consideration or the district might specify such efforts at specific times during the BDR and/or final plan development phase of the project.

Include a summary of aesthetic considerations for the structure and the site in the BDR. The summary consists of sketches, drawings, etc. of recommended treatment as well as the options considered in the aesthetic study but not recommended as appropriate. Also include an estimate of cost to implement the recommended aesthetic treatment in the summary.

The default condition for new steel bridges is uncoated weathering steel where site conditions permit (See **SDG 1.3.2**). Use an Inorganic Zinc Coating System where site conditions preclude uncoated weathering steel and may be used elsewhere with approval of the Chief Engineer. Use of a High Performance Coating System to any extent for Steel bridges requires written approval from the Chief Engineer.

26.9.5 Construction and Maintenance Considerations

Evaluate all viable structure concepts for constructability. Consider items such as member sizes, handling, fabricating, and transporting members as well as maintenance of traffic, construction staging, equipment access, equipment requirements, etc.. Perform a special evaluation to insure against potential problems that may occur in obtaining permits and equipment to transport long and/or heavy members from point of manufacture to the project site. Contact the Department's Road Use Permits Office for questions concerning the feasibility of transporting long and/or heavy structural components. Also, take into account considerations for future maintenance inspection in the structure's design. Include those considerations described in **Section 26.15** and the requirements of the **Structures Manual**. All special construction and maintenance requirements should be identified and appropriately considered in any concepts recommended for design. A design is properly inspectable when it permits safe inspector access to all portions of the structure using equipment available to District Structures Maintenance personnel.

26.9.6 Historical Significance Considerations

When an older bridge is considered for rehabilitation or replacement, the Environmental Management Office will evaluate the historical significance of the structure. A structure may be historically significant due to some of the following characteristics:

1. The structure may be an historic example in the development of engineering.
2. The crossing may be historically significant.
3. The bridge may be associated with an historical property or area.
4. The bridge might be associated with significant events or circumstances.

5. National Register of Historic Places or on a state or local historical register. If it is determined that the structure is historically significant, then the project should be developed to preserve the historic character of the structure.

26.9.7 Bridge Security

Perform a refined evaluation of all new Category 2 bridges identified in a PD&E study as critical, landmark or signature bridges to determine if anti-terrorist countermeasures are to be included as part of the design. Contact the State Structures Design Office and the State Maintenance Office for guidance and assistance. Minimize the bridge vulnerability through alternative designs developed in the BDR. Design countermeasures to minimize the effectiveness of explosives. Minimize vulnerability to shape charges and vehicle bombs. Maximize the use of structural redundancy and continuity to limit structural damage.

Countermeasures designed into the bridge alternatives must meet one or more of the following objectives:

1. Protect structure from blast effects;
2. Maximizing explosive standoff distance;
3. Denial of access;
4. Minimizing time-on-target;
5. Selective protection of the structural integrity of key members;
6. Structural redundancy.

Use one or more of the following countermeasure strategies in the design:

1. Deter attacks by the possibility of exposure, capture or failure of the attacker due to visible countermeasures;
2. Detect potential attacks before they occur and provide the appropriate response force;
3. Defend the bridge by delaying and distancing the attacker from the bridge and protecting the bridge from the effects of weapons, fire and vehicle and vessel impacts;
4. Design the bridge to minimize the potential effects of Weapons of Mass Destruction (WMDs) and conventional explosives, fire and vehicle and vessel impacts.

Structural members that are fracture critical and/or are cable stays, cable stay pylons, hollow boxes, single columns, twin wall columns and thin wall columns require design modification to reduce the potential impact of explosions. Access into cable stay pylons, box superstructures and movable bridge machinery require heavy doors with

secure lock systems. Bridges with essential communication utilities and or gas lines require the design to minimize risk to the utility.

26.9.8 Alternative Designs

The use of alternative designs for some larger or complex projects may result in more competitive bids and lower costs. Accordingly, the EOR is to evaluate benefits from alternatives for the particular structure being developed and provide a recommendation for or against preparing alternative designs. Support the alternative designs recommended by the evaluations included in the BDR. As a guide, consider the following in evaluating justification for alternative designs:

1. Alternative designs are to be considered for all structures that cost more than \$25 Million and a difference in alternate material (steel versus concrete) construction costs that are within twice the cost of producing the alternate plans. For example, alternative designs would be warranted if the additional preliminary engineering cost for final plans preparation is \$1.5 million per alternate and the difference between the construction cost estimates utilizing FDOT estimating practices in the BDR was less than \$3 million.
2. For bridges that cost less than \$25 million consider alternative designs when project issues reflect possible advantages (i.e., TTCP, A+B) from competitive bids.
3. For bridges estimated to cost more than \$10 million consider evaluation of alternative designs whenever a unique design concept is proposed until such time that a bid history is established for the unique design.
4. Projects containing multiple bridges with a reasonable mixture of concrete and steel designs do not require alternate designs.

Steel box structures and steel plate girders should be evaluated including the differences in corrosion potential. Box Girders are preferred over plate girders when located in extremely aggressive environments.

26.9.9 Conclusions and Recommendations

With due consideration for all applicable data, the engineer is required to recommend the final bridge design system for the site. Thorough justification for the selection will be presented which examines each element of data, and the total estimated construction cost of the recommended design must be indicated in the BDR. For most projects, support the recommended design by thirty percent plans (preliminary) as an appendix to the BDR.

The following sections will define, clarify and list the information necessary to produce an acceptable and reproducible set of contract documents (special provisions, bridge contract drawings, etc.) ready for advertisement and construction. The production of a bridge project commences with the Bridge Development Report (BDR) and ends with complete Contract Documents.

26.9.10 30% Structures Plans

The 30% Structures Plans should be submitted with the Bridge Development Report for most structures. The consultant's scope of services should clearly state at what point are the 30% plans to be submitted. If the 30% Structures Plans are submitted separately, the BDR is required to contain enough information and drawings to depict the information needed to properly determine the type, size and location of the bridge. Include the Phase 1 Geotechnical Report and the Hydraulic Report with the submittal containing the BDR.

The 30% Structures Plans should show, as a minimum, the following information:

1. General Notes Sheet: As many general notes as possible should be included on this sheet at this stage. Add subsequent notes, when necessary, as the design progresses (for example of General Notes, see **Chapter 5** of the **Structures Detailing Manual**).
2. Plan and Elevation Sheet: provide contents as required by the **Structures Detailing Manual**.
3. Substructures: For end bents, piers or intermediate bents, show substructure elements and sizes including all deviations from the typical dimensions, foundation type including element spacing and the arrangement of piles or drilled shafts.
4. Superstructure: Include cross section showing lanes, shoulders, railings, slab thickness, beam type and spacing and web depth for steel girders. If applicable, show geometric changes in shapes of various components. Also show construction phases and maintenance of traffic data, outline of the existing structure and portions to be removed, and utilities (existing and proposed as available).
5. Retaining Walls: Submit preliminary control drawings when proprietary or standard cast-in-place walls are proposed. Include control drawings for all critical temporary walls.
6. Bridge Hydraulics Recommendation Sheet.
7. Report of core borings.
8. Proposed construction sequence and methods, indicate construction easements and methods of construction access.

9. Preliminary aesthetic details.
10. Preliminary post-tensioning layouts.
11. Preliminary foundation layouts and installation table.
12. Sidewalks: If provided, show preliminary accessible elements.
13. Any other special details required by the Engineer or details which are not normally used on Department projects.

In addition to these requirements, the following items will be included for moveable bridges: preliminary electrical and mechanical equipment layouts in plan and elevation, submarine cable routing, and single line electrical diagrams including service voltage. Rough size all equipment and submit the supporting calculations.

Include requests for Design Exceptions and Design Variations for structural design criteria in the 30% Structures Plans Submittal. Design Exceptions and Design Variations are required to be approved in accordance with **Chapter 23** of this Volume with concurrence of the DSDO or SDO as appropriate.

Modification for Non-Conventional Projects:

Delete **PPM** 26.9 and replace with the following.

26.9 Bridge Feasibility Assessment/Structures Concept Plans

At the discretion of the Department, a Bridge Feasibility Assessment may be necessary during the RFP development phase for the purpose of developing the structures concept plans. When required, the assessment must target specific critical bridge components to ensure that the preliminary information presented in the concept plans can meet all of the project constraints depicted in the RFP.

For aesthetic and wildlife connectivity requirements, see RFP.

26.10 Bridge Development Report (BDR) Submittal Checklist

The Bridge Development Report (BDR) Submittal Checklist (*Exhibit 26-A*) contains a list of the key supporting elements that are required for the preparation, submittal and review of a BDR. Include this Checklist with the BDR when submitted for review and consists of the following items:

1. Typical Sections for Roadway and Bridge:
The approved typical sections for both the bridge and roadway are required.
2. Roadway Plans:
Preliminary roadway plans covering the bridge vicinity are required.
3. Maintenance of Traffic Requirements:
Show the number of required lanes and the lane widths of all affected roadways in the Maintenance of Traffic Plan.
4. Geotechnical Report:
Prepare the Bridge Geotechnical Report (Phase I) in accordance with **Chapter 3** of the **Structures Design Guidelines** and the Department's **Soils and Foundation Handbook**. Document a thorough investigation of all viable foundation types for the bridge and retaining walls. Concurrence of the District Geotechnical Engineer is required for Category 1 Structures and of both the State and District Geotechnical Engineers for Category 2 Structures.
5. Bridge Corrosion Environment Report:
Prepare a Bridge Corrosion Report to determine the environmental classifications for the structure in accordance with the **Structures Design Guidelines** and receive approval from the District Materials Office.
6. Existing Bridge Plans:
A set of prints of the existing (preferably as-built) bridge plans should be included for replacement structures and widenings. This is of particular importance for widenings and phase construction. These plans are not usually necessary for completely separate alignments or new interchanges unless the existing structures either will be used for new construction activities or will infringe upon the Contractor's allowed work zone.
7. Existing Bridge Inspection Report:
A copy of the latest existing Bridge Inspection Report and Structures Inventory and Appraisal Form is required for all widenings and rehabilitations and may be required for new structures. Identify the existing paint system(s) on all significant metal elements of existing structures. Clearly delineate the presence of lead-based paint and/or asbestos.

8. Bridge Hydraulics Report and Bridge Hydraulics Recommendation Sheet:
Prepare the Bridge Hydraulics Report (BHR) in accordance with the ***FDOT Drainage Manual***. Include the Bridge Hydraulic Recommendations Sheet (BHRS) and address the required hydraulic opening, clearances, scour and deck drainage requirements. In addition to design water elevations normally shown, include the Mean High Water (MHW) elevation for tidal crossings and Normal High Water (NHW) for non-tidal crossings in the BHRS. Concurrence of the BHR by the District Drainage Engineer with the District Structures Design Engineer for Category 1 Structures and State Structures Design Engineer for Category 2 Structures is required.
9. Wildlife Connectivity:
Describe the decision to include or exclude wildlife connectivity features into the design. The discussion for excluding a wildlife connectivity feature should summarize coordination with the Environmental Management or Permit office (or may be an attached summary memo from one of these offices). The discussion for including wildlife connectivity should refer to the [***FDOT Wildlife Crossing Guidelines***](#), commitments made during PD&E and any other documentation regarding the wildlife connectivity related to the bridge (or may be an attached summary memo from the Environmental Management or Permit office).
10. Utility Requirements:
Identify proposed utility attachments to the structure as well as all existing and proposed utilities in the vicinity of the structure. Follow the requirements of the Department's [***Utility Accommodation Manual \(Topic No. 710-020-001\)***](#) regarding attachments to the structure.
11. Railroad Requirements:
Identify existing and future railroad requirements. This will include all clearances and crash wall or other construction parameters. Include copies of correspondence with the Railroad Agency.
12. Retaining Wall and Bulkhead Requirement:
Identify permanent and temporary retaining wall requirements, and show the proposed type of wall. Also identify the type, location and extent of temporary walls to accommodate phased construction and/or maintenance of traffic.

For water crossings where erosion and/or wave action is anticipated, identify the type, location and extent of bulkhead production. Include the proposed tie-back and anchor system in the submittal.
13. Lighting Requirements:
Identify proposed lighting on or under the structure.

14. ADA Access Requirements:
Identify ADA access requirements that affect the structure.

Modification for Non-Conventional Projects:

Delete *PPM* 26.10.

26.11 Final Plans and Specifications Preparation

26.11.1 General

Within this phase of work, for both Category 1 and 2 Structures, there are three phases of work; viz., 60% Substructure submittal or 60% Structure Plans, 90% Structure Plans and 100% Structures Plans and Specifications. For projects where preapproved proprietary wall systems cannot be used and fully designed proprietary wall plans are required, submit approved control drawings to the appropriate proprietary wall companies as soon as possible and no later than the 60% substructure submittal. Send a copy of this submission to the DSDO or SDO as appropriate. At any time during the project development, the reviewer may require submittal of design calculations.

After each of the phases, except the 100% Structures Plans Phase, review comments from the FDOT are sent to the EOR by letter and/or a marked-up set of prints. The EOR is required to address each of the comments in writing and resolve each comment prior to the next submittal. The FDOT 100% Structures Plans review comments are to be handled in the same manner; except that unresolved comments may be handled by telephone, in some instances, if confirmed in writing. Also, for any phase, include items and drawings from a preceding phase. Reflect the comments resolved from the previous phase as well as the accumulated design and drafting effort required of the current phase in the drawings.

26.11.2 60% Substructure Submittal / 60% Structures Plans

This submittal phase is divided into two distinct parts; viz., the 60% Substructure Submittal (required for all projects) and the 60% Structures Plans for Category 2 Structures and some Category 1 Structures.

1. 60% Substructure Submittal:

This submittal is required for every project and should be made a part of the 60% Structures Plans phase when that phase is part of the project. The submission is

only a partial plans set. The purpose of this submittal is to communicate essential project information to the Geotechnical and Hydraulic Engineers so that all remaining calculations can be performed using actual structural shapes, loads, and dimensions. Plan sheets required for this submittal include: Plan & Elevation, Bridge Hydraulics Recommendation Sheet, Boring Logs, Foundation layout, Substructure Plans, and draft technical specifications.

60% Substructure Submittal Contents:

- a. Foundation Layouts
- b. Foundation Installation Notes
- c. Pile/Drilled Shaft Installation Table
- d. Footing Concrete Outlines (All Variations)
- e. Pier Concrete Outline (All Variations)
- f. Wall Plans - Control Drawings
- g. Pile Details
- h. Lateral Stability Analysis Completed
- i. Phase II Geotechnical Report
- j. Draft Technical Specifications
- k. Reinforcement of Footing and Column
- l. Post-Tensioning Details
- m. Plan and Elevation Sheet
- n. Bridge Hydraulics Recommendation Sheet
- o. Boring Logs

2. 60% Structures Plans:

When a 60% Structures Plans submittal is required, all comments from earlier reviews will have been resolved. At this phase, the design should be 90% complete and the plans, 60% complete. In addition to the documents required for the 60% Substructure Submittal, the 60% Structures include the following details as applicable in the plans: final concrete outlines of all individual components, major reinforcing steel, final post-tensioning layouts, steel box/I-girder details, segmental concrete box details, bearing details, seismic details, details of congested areas, details of unique features, accessible pedestrian facilities details, and other details as required. For moveable bridges the following additional information is required: electrical calculations (for generator size, service voltage drop, short circuit, service size, automatic transfer switch, etc.), single line diagram showing equipment sizes and utilities, conduit and wire sizes, panelboard schedules, and light fixture schedules.

26.11.3 90% Structures Plans

Upon approval of the BDR/30% Structures Plans or 60% Structures Plans, as applicable, 90% Structures Plans begin. At this stage of plans development, the EOR will have resolved the 30% and/or 60% Structures Plans review comments and developed the plans for completion. The design and plan production is required to be 100% complete. This submittal will include prints of the completed plans, Summary of Pay Items (complete with quantities), design calculations, Final Phase II Geotechnical Report, Addendums to Hydraulic Report and, if appropriate, Technical Special Provisions. No sheet or detail should be missing at this stage.

26.11.4 100% Structures Plans and Specifications

After resolution of the 90% Structures Plan comments, the EOR will make all authorized changes necessary to complete the plans and Technical Special Provisions. The EOR will provide a list of all changes made to the Plans or Specifications that were not directly related to the 90% Structures Plans review comments. The intent is to help minimize the Department's review time and to help the Department's review office to focus on only those new items or details proposed by the EOR. This will, in turn, help to expedite the project's authorization.

The 100% Structures Plans submittal is divided into two distinct phases. First, prints of the original drawings and technical special provisions are submitted 30 days prior to the District's Plans Production Date (PPD). Secondly, once notified by the FDOT, the original drawings and all other documents are submitted to the District.

Within the 30-day period allotted, the EOR will receive notification either of additional changes/corrections to be made or to submit the Final Plans as they are. If at any time during the 30-day period the EOR finds additional changes/corrections that should be made, the Structures Design Office responsible for plans approval (either the District Structures Design Engineer (DSDE) or the Structures Design Office (SDO) as appropriate) is required to be notified for discussion and resolution.

Once all changes/corrections are made, or if no changes/corrections are necessary, the EOR will submit all work to the District prior to or on the PPD. Submittal of this stage of the work will include the original drawings, one record set of prints with each sheet sealed in accordance with **Chapter 19** of this Volume, quantities book assembled as specified in the Department's **Basis of Estimates Manual**, sealed Technical Special Provisions (if required), and sealed Summary of Pay Items with estimated bridge quantities. If included in the Scope of Services, original documents in electronic format may also be required to be delivered as part of the Electronic Project Submittal.

Modification for Non-Conventional Projects:

Delete **PPM** 26.11. See the RFP for plans submittal requirements.

26.12 Independent Peer Review of Category 2 Bridges

Independent Peer Reviews are used to validate the design of Category 2 structures or portions of such. Consideration of when such reviews should be required include but are not limited to the introduction of new complex details or structure types, work being performed that is outside the normal structure type designed by the selected consultant, when the structure contains complex details within standard bridge types (i.e. integral piers, straddle piers, skewed superstructures), etc.

All Cost Savings Initiatives involving a Category 2 Structure require an independent peer review of the Category 2 portions. The Peer Review is required to be performed by a single independent engineering firm other than the engineer responsible for the initial work that is designated by the contractor to conduct the review. The designated independent peer review firm will have no involvement with the project other than conducting the peer review and is required to be pre-qualified in accordance with **Rule 14-75 of the Florida Administrative Code**. For bridges consisting of both Category 1 and Category 2 bridge spans only the Category 2 spans and corresponding substructure components require a peer review. Where the superstructure is Category 1, but the substructure component is Category 2, only the substructure component has to be peer reviewed. For water crossings with vessel impact, the spans or superstructure units with spans over water require a peer review.

Modification for Non-Conventional Projects:

Delete the above paragraph and replace with the following:

For all Category 2 bridges, an independent peer review is required. The Peer Review will be performed by a single independent engineering firm other than the engineer responsible for the initial work and will be designated by the Contractor or Concessionaire (P3 projects) to conduct the review. The designated independent peer review firm will have no other involvement with the project other than conducting the peer review and is required to be pre-qualified in accordance with **Rule 14-75 of the Florida Administrative Code**. For bridges consisting of both Category 1 and Category 2 bridge spans only the Category 2 spans and corresponding substructure components require a peer review. Where the superstructure is Category 1, but the substructure component is Category 2, only the substructure component has to be peer reviewed. For water crossings with vessel impact, the spans or superstructure units with spans over water require a peer review.

The peer review is intended to be a comprehensive, thorough independent verification of the original work. An independent peer review is not simply a check of the EOR's plans and calculations; it is an independent verification of the design using different programs and independent processes than what was used by the EOR. All independent peer reviews include but are not limited to the independent confirmation of the following when applicable:

1. Compatibility of bridge geometry with roadway geometrics including typical sections, horizontal alignment, and vertical alignment. Minimum lateral offsets and vertical clearance requirements.
 2. Compatibility of construction phasing with Traffic Control Plans.
 3. Conflicts with underground and overhead utilities.
 4. Compliance with AASHTO, Department and FHWA design requirements.
 5. Conformity to Department Design Standards.
 6. Structural Analysis Methodology, design assumptions, and independent confirmation of design results.*
 7. Design results/recommendations (independent verification of the design).*
 8. Completeness and accuracy of bridge plans.
 9. Technical Special Provisions, and Modified Special Provisions where necessary.
 10. Constructability assessment limited to looking at fatal flaws in design approach.
- * When Category 2 superstructure elements are designed with software using refined analyses (e.g. Grid, Finite Element Method, etc.), the peer review consultant is required to verify the design results by a different program/method.

In addition to the requirements of **Sections 26.11.3** and **26.11.4**, include the following documents with plan submittals for Category 2 bridges requiring an independent peer review:

1. 90% Plan Submittals
 - a. A tabulated list of all review comments from the independent review engineer and responses from the originator of the design.
 - b. A standard peer review certification letter following the format presented in **Exhibit 26-B** signed by the independent review engineer. All outstanding/unresolved comments and issues presented in this letter are required to be resolved and implemented prior to the 100% plan submittal.

2. 100% Plan Submittals
 - a. A certification letter following the format presented in **Exhibit 26-C** signed and sealed by the independent review engineer stating that all review comments have been adequately addressed and that the design is in compliance with all Department and FHWA requirements.

26.13 Plans Assembly

Consult the **Structures Detailing Manual** for plans assembly, materials, content of plans, and other drafting information.

26.14 Plans Submittal

26.14.1 Schedule

The District Project Manager is responsible for establishing the schedule of submittals with input from the EOR and either the District Structures Design Engineer for Category 1 or Structures Design Office for Category 2 projects.

26.14.2 Submittal Schedule

1. BDR/30% Structures Plans
2. 60% Substructure Submittal/60% Structures Plans
3. 90% Structures Plans
4. 100% Structures Plans

Modification for Non-Conventional Projects:

Delete **PPM** 26.14.1 and 26.14.2. See the RFP for requirements.

26.14.3 Summary of Phase Submittals

Submittals made at various stages of project development are required to conform to a uniform standard of completeness for each phase. Use **Exhibit 26-D** to prepare deliverables for each stage of project development for fixed bridges. Use **Exhibits 26-D** and **26-E** to prepare deliverables for each stage of project development for moveable bridges.

Exhibits 26-D and **26-E** give a listing of specific structure plan sheets to be submitted at Bridge Development Report, 30%, 60%, 90% and 100% Plans stage. For specific sheet content requirements, see [Structures Detailing Manual Examples for Design-Bid-Build Projects](#). For sheets not covered by specific example, see general description below for required level of completion.

1. **Preliminary (P):** Basic shapes, geometry and layout of specified members are shown. Rebar, elevations, quantities, etc. are not required for Preliminary submittals. For example, the outline drawing of an end bent with complete dimensions including stationing, beam and pedestal layout but without pile layout dimensions or rebar.
2. **Substantially Complete (S):** Shapes, geometry and layout have been finalized. Design is 90% complete with most rebar, plate sizes, bolt patterns, concrete strengths finalized and incorporated into the plans. For example, an end bent drawing with rebar, complete dimensions, pile and beam layout but without elevations or quantities.
3. **Complete but Subject to Change (C):** The design, drawings and details are complete for the specified component. Only reviewer-initiated changes should be expected at this level. For example, an end bent drawing would be complete, including all rebar callouts, elevations, dimensions and quantities.
4. **Final (F):** All drawings and designs are complete. No changes are expected at this level. Plans are ready to be signed and sealed by the EOR.

Modification for Non-Conventional Projects:

Delete **PPM 26.14.3** and replace with the following.

26.14.3 Design-Build Technical Proposal and Component Plan Submittals

Component Plan Submittals are required to conform to a uniform standard of completeness for each submittal. Use **Exhibit 26-DD** to prepare deliverables for each component submittals for fixed bridges. Use **Exhibits 26-DD** and **26-EE** to prepare deliverables for component submittals for moveable bridges. Unless otherwise shown in the RFP, Technical Proposals are required to include the requirements of **Exhibits 26-DD** and **26-EE**.

Submit component submittals per **Exhibits 26-DD** and **26-EE** (E.g., foundation, substructure and superstructure) for each bridge. Partial submittals of individual elements within a bridge (e.g., End Bent 1, Pier 3, I-girder details, etc.) are not permitted.

Exhibits 26-DD and **26-EE** give a listing of specific structure plan sheets to be submitted at Technical Proposal, 90% and Final Plans stage. For specific sheet content requirements, see [Structures Detailing Manual Examples for Non-Conventional Projects](#). For sheets not covered by specific example, see general description below for required level of completion.

1. **Preliminary (P):** Basic shapes, geometry and layout of specified members are shown. Rebar, elevations, etc. are not required for Preliminary submittals. For example, the outline drawing of an end bent with complete dimensions including stationing, beam and pedestal layout but without pile layout dimensions or rebar.
2. **Substantially Complete (S):** Shapes, geometry and layout have been finalized. Design is 90% complete with most rebar, plate sizes, bolt patterns, concrete strengths finalized and incorporated into the plans. For example, an end bent drawing with rebar, complete dimensions, pile and beam layout but without elevations.
3. **Complete but Subject to Change (C):** The design, drawings and details are complete for the specified component. Only reviewer-initiated changes should be expected at this level. For example, an end bent drawing would be complete, including all rebar callouts, elevations, and dimensions.
4. **Final (F):** All drawings and designs are complete. No changes are expected at this level. Plans are ready to be signed and sealed by the EOR.

26.15 Review for Constructability and Maintainability

26.15.1 Purpose

The purpose of this review is to provide reasonable and practical use of fabrication and construction techniques and equipment without overloading and/or overstressing components, provide for proper material handling and transportation, provide safe maintenance of traffic and provide an appropriate construction sequence. Additionally, provide features which will retard bridge deterioration, permit reasonable access to all parts of the bridge for inspection and performance evaluation and provide features to facilitate replacement of damaged and/or deteriorated bridge components.

26.15.2 Responsibility

For Category 1 and 2 Structures, it will be the responsibility of the project manager, or his/her designee, to coordinate a review of both the 30% and 90% Structures Plans submittals by the appropriate District Construction and Maintenance personnel for constructability and maintainability. For Category 1 Structures, technical issues will be resolved to the satisfaction of the appropriate DSDE. For Category 2 Structures, technical issues will be resolved to the satisfaction of the SDO.

The Construction and Maintenance Offices should be given adequate time to perform these reviews. All comments from these reviews will be addressed prior to the next submittal and its subsequent review.

Modification for Non-Conventional Projects:

Delete **PPM** 26.15 and see the RFP for requirements.

26.16 Review for Biddability

26.16.1 Purpose

To prevent construction problems, the District Construction Office will review the plans to make certain the plans are clearly understandable, contain all pertinent notes and have sufficient and correct pay items. During the biddability review, the Construction Office will check for the interface with the roadway segment of the project, utility agreements and environmental permits.

26.16.2 Responsibility

For Category 1 and 2 Structures, it will be the responsibility of the project manager to coordinate a review of the 90% Structures Plan submittal. This review should occur at the same time as the Phase III Plans submittal for the roadway segments of the project.

Additionally, for Category 2 Structures, it will be the responsibility of the Structures Design Office to coordinate a review of the 90% Structures Plans submittal.

The Construction Offices should be given adequate time to perform these reviews. All comments from these reviews are required to be addressed prior to the 100% Structures Plans Stage submittal.

Modification for Non-Conventional Projects:

Delete **PPM** 26.16.

26.17 Bridge Load Rating

Perform load rating analysis of new or existing bridges in accordance with the **AASHTO “Manual for Bridge Evaluation”** as amended by the **FDOT “Structures Manual”, Volume 1** and the **FDOT “Bridge Load Rating Manual (Topic 850-010-035)**.

For new bridges the Engineer of Record is required to load rate the bridge(s) and submit the calculations with the 90% plan submittal.

Prior to developing the scope-of-work for bridge widening and/or rehabilitation projects, the FDOT or their consultant will determine the suitability of the bridge project using the load rating. If the existing load rating is inaccurate or was performed using older methods (e.g. load factor), perform a new load rating using the procedures outlined in the **“FDOT Structures Manual”, Volume 1 - Structures Design Guidelines, Chapter 7**. Submit load rating calculations for the entire structure (existing and new) with the 90% plan submittal for the project.

Modification for Non-Conventional Projects:

Delete **PPM 26.17** and see the RFP for requirements.

26.18 Review of Non-FDOT Funded Projects (New Construction)

FDOT review will be required whenever a privately funded structure crosses over Department owned right of way or when such work otherwise affects such a route; i.e., lane closures, access, R/W changes, etc. FHWA review will be required whenever a privately funded structure crosses over an interstate route, or when such work otherwise affects such a route; i.e., lane closures, access, R/W changes, etc. The extent of FDOT and FHWA review is that:

1. Plans will meet all current clearance requirements (vertical and horizontal).
2. Review and approve the maintenance of traffic scheme for construction.
3. Securely fasten all attachments to the structure over the highway must be.
4. Design will be sealed by a licensed professional engineer.
5. Design will be in accordance with a nationally recognized code such as AASHTO, ACI, AISC, etc.
6. Plans will meet all District permit requirements and procedures.
7. Submit to FHWA for approval only projects over or affecting a NHS facility.
8. FDOT review for these structures will be performed by the District Structures Design Office for Category 1 and State Structures Design Office for Category 2 Structures.

Exhibit 26-A Bridge Development Report (BDR) Submittal Checklist

Project Name _____

Financial Project ID _____

FA No. _____ FHWA Oversight (yes no) NHS (yes no)

Date _____ FDOT Project Manager _____

ITEMS	STATUS ^(b)
1. Typical Sections for Roadway and Bridge ^(a)	P NA C
2. Roadway Plans in Vicinity of Bridge ^(a)	P NA C
3. Maintenance of Traffic Requirements ^(a)	P NA C
4. Geotechnical Report ^(c)	P NA C
5. Bridge Corrosion Environmental Report ^(c)	P NA C
6. Existing Bridge Plans	P NA C
7. Existing Bridge Inspection Report.....	P NA C
8. Bridge Hydraulics Report ^(c)	P NA C
9. Wildlife Connectivity.....	P NA C
10. Utility Requirements.....	P NA C
11. Railroad Requirements	P NA C
12. Retaining Wall and Bulkhead Requirements.....	P NA C
13. Lighting Requirements.....	P NA C
14. ADA Access Requirements.....	P NA C
15. Other.....	P NA C

- (a) Requires approval by District before BDR submittal.
- (b) Circle appropriate status:
 P - Provided NA - Not Applicable C - Comments attached
- (c) See approval requirements for these documents elsewhere in this chapter.

Exhibit 26-B Independent Peer Review Certification Letter (90% Submittal)

Insert Date

Florida Department of Transportation
District ____
[Insert Street Address]

Attn: *[Insert Project Manager/Construction Project Engineer]*

Reference: Independent Peer Review Category 2 Structures
Financial Project ID: *[Insert FPID]*
Federal Aid Number: *[Insert Federal Aid Number]*
Contract Number: *[Insert CN]*

Submittal: 90% Bridge *[Insert Component/CSIP]* Plans
Submittal *[Insert Submittal No.]*
Bridge Number(s): *[Insert Bridge No.(s)]*

Dear *[Insert Project Manager/Construction Project Engineer]*,

Pursuant to the requirements of the Contract Documents, *[Insert the name of the Independent Peer Review Firm]* hereby certifies that an independent peer review of the above-referenced submittal has been conducted in accordance with Chapter 26 of the Plans Preparation Manual and all other governing regulations. Component plans that were included in the peer review are as follows:

[Insert a list of all component plans that underwent an Independent Peer Review]

Outstanding / Unresolved Comments and Issues:

[Provide a statement of outstanding/unresolved comments for the above-referenced review, and actions being taken to resolve issues.]

Certification Statement:

I certify that the component plans listed in this letter have been verified by independent review and are in compliance with all requirements presented in the Contract Documents. Independent Peer Review comments and comment resolutions have been included in this submittal under separate cover.

Please do not hesitate to contact me if you have any questions.

Name of Independent Peer Review Firm *[Insert Firm Name]*

Name of Independent Peer Reviewer *[Insert Reviewer Name]*

Title *[Insert Reviewer Title]*

Signature _____

Florida Professional Engineer Lic. No. *[Insert License Number]*

Exhibit 26-C Independent Peer Review Certification Letter (100% Submittal)

Insert Date

Florida Department of Transportation
District _____
[Insert Street Address]

Attn: *[Insert Project Manager/Construction Project Engineer]*

Reference: Independent Peer Review Category 2 Structures
Financial Project ID: *[Insert FPID]*
Federal Aid Number: *[Insert Federal Aid Number]*
Contract Number: *[Insert CN]*

Submittal: 100% Bridge *[Insert Component/CSIP]* Plans
Submittal *[Insert Submittal No.]*
Bridge Number(s): *[Insert Bridge No.(s)]*

Dear *[Insert Project Manager/Construction Project Engineer]*,

Pursuant to the requirements of the Contract Documents, *[Insert the name of the Independent Peer Review Firm]* hereby certifies that an independent peer review of the above-referenced submittal has been conducted in accordance with Chapter 26 of the Plans Preparation Manual and all other governing regulations. Component plans that were included in the peer review are as follows:

[Insert a list of all component plans that underwent an Independent Peer Review]

Certification Statement:

I certify that the component plans listed in this letter have been verified by independent review, that all review comments have been adequately resolved, and that the plans are in compliance with all Department and FHWA requirements presented in the Contract Documents.

Please do not hesitate to contact me if you have any questions.

Name of Independent Peer Review Firm *[Insert Firm Name]*

Name of Independent Peer Reviewer *[Insert Reviewer Name]*

Title *[Insert Reviewer Title]*

Florida Professional Engineer Lic. No. *[Insert License Number]*

*[Insert Signature,
Date and Seal
here.]*

Exhibit 26-D Summary of Phase Submittals

Provide the sheets listed as applicable based on structure type.

ITEM	BDR	30%	60% Substr. Submittal	60% Structures Plans*	90%	100%
Cover Sheet		P	S	S	C	F
Key Sheet		P	S	S	C	F
Sheet Index		P	S	S	C	F
General Notes		P	S	S	C	F
Summary of Pay Items					C	F
Surface Finish Details			S	S	C	F
Riprap Details			S	S	C	F
Slope Protection Details			S	S	C	F
Plan and Elevation	S	S	C	C	C	F
Typical Section	S	S	C	C	C	F
Hydraulics Recommendation	P	P	S	S	C	F
Construction Sequence	S	S		C	C	F
Borings		C	C	C	C	F
Foundation Layout		S	S	S	C	F
Pile/Shaft Data Table			S	S	C	F
End Bent		P	S	S	C	F
End Bent Details			S	S	C	F
Wing Wall Details			S	S	C	F
Pier	P	P	S	S	C	F
Pier Details		P	S	S	C	F
Footing		P	S	S	C	F
Intermediate Bent	P	P	S	S	C	F
Intermediate Bent Details			S	S	C	F
Drilled Shaft Details		P	S	S	C	F
Finish Grade Elevations				C	C	F
Camber//Build-up/Deflection Diagrams				C	C	F
Framing Plan		P		S	C	F
Superstructure Plan				S	C	F
Superstructure Details				S	C	F
Erection Sequence	P	P	S	S	C	F
P/S Beam Data Tables				S	C	F
Cross Frames/Diaphragm Details				S	C	F
Steel Girder Details		P		S	C	F
P/T Systems		P		S	C	F
Bearing Details				S	C	F
Expansion Joint Details				S	C	F
Approach Slab Details				S	C	F
Reinforcing Bar List					C	F
Conduit and Inspection Lighting Details				P	C	F
Vermin Guard				S	C	F
Wall Control Drawings		S	S	S	C	F
Wall Details		P	S	S	C	F
Temporary Critical Wall Drawings	P	P	S	S	C	F
Wall Data Tables			S	S	C	F
Temp. Bridge Plan and Elevation			P	P	C	F
Temp. Bridge Foundation Layout			P	P	C	F

Exhibit 26-D Summary of Phase Submittals (continued)

Provide the sheets listed as applicable based on structure type.

ITEM	BDR	30%	60% Substr. Submittal	60% Structures Plans*	90%	100%
Segment Joint Coordinates/Deck Elev.				S	C	F
Segment Layout		P		S	C	F
Typical Segment Dimensions	P	P		C	C	F
Typical Segment Reinforcing				S	C	F
Pier Segment Dimensions	P	P		C	C	F
Pier Segment Reinforcing **				S	C	F
Abutment Segment Dimensions	P	P		C	C	F
Abutment Segment Reinforcing **				S	C	F
Expansion Joint Segment Dimensions		P		S	C	F
Expansion Joint Segment Reinforcing **				S	C	F
Deviation Segment Dimensions		P		C	C	F
Deviation Segment Reinforcing **				S	C	F
Post Tensioning Layout		P		C	C	F
P/T Details	P	P		S	C	F
Transverse P/T Details		P		C	C	F
Bulkhead Details		P		S	C	F
Drainage Layout		P		S	C	F
Drainage Details		P		S	C	F
Load Rating Summary Sheet					C	F
Developmental Design Standards		C	C	C	F	F
Existing Bridge Plans		F ††	F ††	F ††	F	F

Status Key:

P – Preliminary

S – Substantially Complete

C – Complete but subject to change

F – Final

* – 60% Structures Plan submittals are required for all Category 2 and some Category 1 bridges. See **Section 26.11.2** for additional information

** – May require integrated drawings

† – Where required for project

†† – Widening and projects with phased construction

Exhibit 26-E Summary of Phase Submittals - Movable Bridges

For approach span requirements, see **Exhibit 26-D**.

Provide the sheets listed as applicable based on machinery and electrical components utilized.

ITEM	BDR	30%	60% Structures Plans*	90%	100%
Bascule Pier Notes		P	S	C	F
Bascule Pier Quantities			S	C	F
Bascule Span Elevation	P	S	S	C	F
Leaf Clearance Diagrams		P	S	C	F
Bridge Railing Clearance Diagrams		P	S	C	F
Bascule Pier North Elevation View	P	S	S	C	F
Bascule Pier South Elevation View	P	S	S	C	F
Bascule Pier East Elevation View	P	S	S	C	F
Bascule Pier West Elevation View	P	S	S	C	F
Bascule Pier Deck Plan	P	S	S	C	F
Bascule Pier Deck Elevations	P	S	S	C	F
Bascule Pier Trunnion Level Plan	P	S	S	C	F
Bascule Pier Machinery Level Plan	P	S	S	C	F
Bascule Pier Pit Plan	P	S	S	C	F
Bascule Pier Footing Plan	P	S	S	C	F
Bascule Pier Longitudinal Sections	P	S	S	C	F
Bascule Pier Transverse Sections	P	S	S	C	F
Bascule Pier Railing Details			P	C	F
Bascule Pier Stair Details			P	C	F
Bascule Pier Trunnion Access Platform Details	‡	‡	S	C	F
Bascule Pier Finger Joints			P	C	F
Bascule Pier Deck Level Reinforcing			P	C	F
Bascule Pier Trunnion Level Reinforcing			P	C	F
Bascule Pier Machinery Level Reinforcing			P	C	F
Bascule Pier Pit Reinforcing			P	C	F
Bascule Pier Footing Reinforcing			P	C	F
Bascule Pier North Elevation Reinforcing			P	C	F
Bascule Pier South Elevation Reinforcing			P	C	F
Bascule Pier East Elevation Reinforcing			P	C	F
Bascule Pier West Elevation Reinforcing			P	C	F

Exhibit 26-E Summary of Phase Submittals - Movable Bridges (Continued)

For approach span requirements, see *Exhibit 26-D*.

Provide the sheets listed as applicable based on machinery and electrical components utilized.

ITEM	BDR	30%	60% Structures Plans*	90%	100%
Bascule Pier Longitudinal Section Reinforcing			P	C	F
Bascule Pier Transverse Section Reinforcing			P	C	F
Bascule Pier Reinforcing Bar List			P	C	F
Control House General Notes			P	C	F
Control house Reflected Ceiling Plan			P	C	F
Control House Access Bridge Dimensions	‡	‡	S	C	F
Control House Access Bridge Reinforcing	‡	‡	S	C	F
Control House Access Bridge Bar List	‡	‡	S	C	F
Control Tower Floor Plans	P	S	S	C	F
Control Tower Sections	P	S	S	C	F
Control Tower Reinforcing Plans			P	C	F
Control Tower Reinforcing Elevations			P	C	F
Control Tower Section Reinforcing			P	C	F
Control Tower Bar List			P	C	F
Control Tower Schedules			P	C	F
Control Tower Elevations	P	S	S	C	F
Control Tower Building Sections			P	C	F
Control Tower Details			P	C	F
Control Tower Stair Plans			P	C	F
Control Tower Stair Sections			P	C	F
Control Tower Roof			P	C	F
Control Tower Door and Window Types and Details			P	C	F
Control Tower Architectural Details			P	C	F
Control Tower HVAC Notes			P	C	F
Control Tower HVAC and Plumbing Floor Plans			P	C	F
Control Tower HVAC and Plumbing Elevations			P	C	F
Bascule Leaf Notes			S	C	F
Bascule Leaf Framing Plan and Longitudinal Section	P	S	S	C	F
Bascule Leaf Transverse Sections at Floorbeams	P	S	S	C	F
Bascule Leaf Transverse Sections at Trunnion	P	S	S	C	F

Exhibit 26-E Summary of Phase Submittals - Movable Bridges (Continued)

For approach span requirements, see **Exhibit 26-D**.

Provide the sheets listed as applicable based on machinery and electrical components utilized.

ITEM	BDR	30%	60% Structures Plans*	90%	100%
Bascule Leaf Transverse Sections at Counterweight Girders	P	S	S	C	F
Main Girder Elevation	P	S	S	C	F
Main Girder Details			P	C	F
Main Girder Web Geometry and Camber Details			P	C	F
Main Girder Force Diagrams			P	C	F
Main Girder Reaction Influence Lines			P	C	F
Main Girder Moment Influence Lines			P	C	F
Floorbeam Details			P	C	F
Counterweight Girder Details			P	C	F
Stringer Details			P	C	F
Lateral Bracing Details			P	C	F
Counterweight Bracing Plan and Details			P	C	F
Counterweight Bracing Sections and Details			P	C	F
Counterweight Plan			P	C	F
Counterweight Longitudinal Sections			P	C	F
Counterweight Transverse Sections			P	C	F
Counterweight Details and Reinforcing Bar List			P	C	F
Bridge Deck Panel Layout			P	C	F
Bridge Deck Panel Sections			P	C	F
Bridge Deck Panel Details			P	C	F
Armored Joint Details			P	C	F
Span Lock Housing Details			P	C	F
Bascule Leaf Jacking Details and Notes			P	C	F
Mechanical General Notes		P	S	C	F
Mechanical Equipment Schedules		P	S	C	F
Drive Machinery Layout		P	S	C	F
Machinery Support Details			S	C	F
Trunnion Assembly Details		P	S	C	F
Open Gearing Details		P	S	C	F

Exhibit 26-E Summary of Phase Submittals - Movable Bridges (Continued)

For approach span requirements, see **Exhibit 26-D**.

Provide the sheets listed as applicable based on machinery and electrical components utilized.

ITEM	BDR	30%	60% Structures Plans*	90%	100%
Rack/Rack Frames and Rack Pinion Details		P	S	C	F
Mechanical Bearing Details		P	S	C	F
Drive Hydraulic Cylinders Details		P	S	C	F
Hydraulic System Layout/Piping Details		P	S	C	F
Hydraulic Cylinder Support Assemblies		P	S	C	F
Hydraulic System Details		P	S	C	F
Live Load Shoe Details		P	S	C	F
Centering Device Details			S	C	F
Span Lock Assembly Details		P	S	C	F
Control Tower – Control Console and Operator’s Visualization Geometry Analysis Including CCTV Locations		P	S	C	F
Electrical General Notes		P	S	C	F
Electrical Site Plan		P	S	C	F
Conduit Riser Diagram		P	S	C	F
Single Line Diagram		P	S	C	F
Electrical Symbol Legend		P	S	C	F
Lighting and Equipment Plan (Including Control Tower Lighting, Fire Detection and Lighting Panel Schedules)		P	S	C	F
Lightning Protection, Bonding, and Grounding Plan		P	S	C	F
Navigation Lighting Plan		P	S	C	F
Communication Equipment Plan		P	S	C	F
Control Panel Details		P	S	C	F
Control Console Details		P	S	C	F
Block Diagram of Operating Sequence		P	S	C	F
Control System Architecture Diagram		P	S	C	F
Schematic Diagrams of all Control Systems and Interlocks		P	S	C	F
Control System I/O Points		P	S	C	F
Ladder Logic for PLC			P	C	F
Submarine Cable/Submarine Cable Termination Cabinet Details		P	S	C	F

Exhibit 26-E Summary of Phase Submittals - Movable Bridges (Continued)

For approach span requirements, see **Exhibit 26-D**.

Provide the sheets listed as applicable based on machinery and electrical components utilized.

ITEM	BDR	30%	60% Structures Plans*	90%	100%
Fire and Security Panel Schematic Diagram		P	C	C	F
CCTV Plan and Elevation		P	C	C	F
Limit Switch Development		P	C	C	F
Conduit and Cable Schedule		P	C	C	F
Electrical Equipment Layout - Including but not limited to Generators, Motors, Control Console, Control Panels, and Motor Control Center.		P	C	C	F
CCTV Layout			P	S	F

Status Key:

P – Preliminary

S – Substantially Complete

C – Complete but subject to change

F – Final

* – 60% Structures Plan submittals are required for all movable bridges. See **Section 26.11.2** for additional information

‡ – Where required for project

Exhibit 26-DD Summary of Design/Build Technical Proposal and Component Plan Submittals

Provide the sheets listed as applicable based structure type.

Foundation Submittal

ITEM	Technical Proposal	90%	Final
Cover Sheet		C	F
Key Sheet		C	F
Sheet Index		C	F
General Notes	S	C	F
Surface Finish Details		C	F
Riprap Details		C	F
Slope Protection Details		C	F
Plan and Elevation	P	C	F
Typical Section	P	C	F
Hydraulics Recommendation	P	C	F
Construction Sequence	P	C	F
Borings		C	F
Foundation Layout	P	C	F
Pile/Shaft Data Table		C	F
Drilled Shaft Details		C	F
Temp. Bridge Foundation Layout	P	C	F
Existing Bridge Plans		F##	F
Foundation Related Temporary Critical Wall Drawings	P	C	F

Include in all submittals additional details and backup information necessary to substantiate the loading on the foundations. Include a copy of the Geotechnical Report in all submittals.

– Widening and projects with phased construction

90% and Final submittals for category 2 bridges require an Independent Peer Review.

Substructure Submittal

ITEM	Technical Proposal	90%	Final
End Bent	P	C	F
End Bent Details		C	F
Wing Wall Details		C	F
Pier	P	C	F
Pier Details		C	F
Footing	P	C	F
Intermediate Bent	P	C	F
Intermediate Bent Details		C	F
Reinforcing Bar List		C	F

90% and Final submittals for category 2 bridges require an Independent Peer Review.

Exhibit 26-DD Summary of Design/Build Technical Proposal and Component Plan Submittals (cont.)

Provide the sheets listed as applicable based on structure type.

Superstructure Submittal

ITEM	Technical Proposal	90%	Final
Finish Grade Elevations		C	F
Camber/Build-up/Deflection Diagrams		C	F
Framing Plan		C	F
Superstructure Plan		C	F
Superstructure Details		C	F
Erection Sequence	P‡	C	F
P/S Beam Data Tables		C	F
Cross Frames/Diaphragm Details		C	F
Steel Girder Details	P	C	F
P/T Systems	P	C	F
Bearing Details		C	F
Expansion Joint Details		C	F
Approach Slab Details		C	F
Reinforcing Bar List		C	F
Conduit and Inspection Lighting Details		C	F
Vermin Guard		C	F
Wall Control Drawings	P	C	F
Wall Details		C	F
Non-Foundation Related Temporary Critical Wall Drawings	P	C	F
Wall Data Tables		C	F
Temp. Bridge Plan and Elevation	P	C	F
Segment Joint Coordinates/Deck Elev.		C	F
Segment Layout	P	C	F
Typical Segment Dimensions	P	C	F
Typical Segment Reinforcing		C	F
Pier Segment Dimensions	P	C	F
Pier Segment Reinforcing **		C	F
Abutment Segment Dimensions	P	C	F
Abutment Segment Reinforcing **		C	F
Expansion Joint Segment Dimensions	P	C	F
Expansion Joint Segment Reinforcing **		C	F
Deviation Segment Dimensions	P	C	F
Deviation Segment Reinforcing **		C	F
Post Tensioning Layout	P	C	F

Exhibit 26-DD Summary of Design/Build Technical Proposal and Component Plan Submittals (cont.)

Provide the sheets listed as applicable based on structure type.

Superstructure Submittal (cont.)

ITEM	Technical Proposal	90%	Final
P/T Details	P	C	F
Transverse P/T Details		C	F
Bulkhead Details		C	F
Drainage Layout		C	F
Drainage Details		C	F
Load Rating Summary Sheet		C	F
Developmental Design Standards		F	F
Existing Bridge Plans		F‡	F
90% and Final submittals for category 2 bridges require an Independent Peer Review.			

Status Key:

P – Preliminary

S – Substantially Complete

C – Complete but subject to change

F – Final

****** – May require integrated drawings

‡ – For geometrically constrained sites, show temporary stability towers in the vicinity of the underlying roadways consistent with the Traffic Control Plans. Also show temporary stability towers within navigable waterways.

‡‡ – Widening and projects with phased construction

Exhibit 26-EE Summary of Design/Build Technical Proposal and Component Plan Submittals – Movable Bridges

For approach span and foundation submittal requirements see **Exhibit 26-DD**.
 Provide the sheets listed as applicable based on machinery and electrical components utilized.

Substructure Submittal

ITEM	Technical Proposal	90%	Final
Bascule Pier Notes		C	F
Bascule Span Elevation	P	C	F
Leaf Clearance Diagrams		C	F
Bridge Railing Clearance Diagrams		C	F
Bascule Pier North Elevation View	P	C	F
Bascule Pier South Elevation View	P	C	F
Bascule Pier East Elevation View	P	C	F
Bascule Pier West Elevation View	P	C	F
Bascule Pier Deck Plan	P	C	F
Bascule Pier Deck Elevations	P	C	F
Bascule Pier Trunnion Level Plan	P	C	F
Bascule Pier Machinery Level Plan	P	C	F
Bascule Pier Pit Plan	P	C	F
Bascule Pier Footing Plan	P	C	F
Bascule Pier Longitudinal Sections	P	C	F
Bascule Pier Transverse Sections	P	C	F
Bascule Pier Railing Details		C	F
Bascule Pier Stair Details		C	F
Bascule Pier Trunnion Access Platform Details	‡	C	F
Bascule Pier Finger Joints		C	F
Bascule Pier Deck Level Reinforcing		C	F
Bascule Pier Trunnion Level Reinforcing		C	F
Bascule Pier Machinery Level Reinforcing		C	F
Bascule Pier Pit Reinforcing		C	F
Bascule Pier Footing Reinforcing		C	F
Bascule Pier North Elevation Reinforcing		C	F
Bascule Pier South Elevation Reinforcing		C	F

Exhibit 26-EE Summary of Design/Build Technical Proposal and Component Plan Submittals – Movable Bridges (cont.)

For approach span and foundation submittal requirements see **Exhibit 26-DD**.
Provide the sheets listed as applicable based on machinery and electrical components utilized.

Substructure Submittal (cont.)

ITEM	Technical Proposal	90%	Final
Bascule Pier East Elevation Reinforcing		C	F
Bascule Pier West Elevation Reinforcing		C	F
Bascule Pier Longitudinal Section Reinforcing		C	F
Bascule Pier Transverse Section Reinforcing		C	F
Bascule Pier Reinforcing Bar List		C	F
90% and Final submittals for category 2 bridges require an Independent Peer Review.			

Exhibit 26-EE Summary of Design/Build Technical Proposal and Component Plan Submittals – Movable Bridges (cont.)

For approach span and foundation submittal requirements see **Exhibit 26-DD**.
 Provide the sheets listed as applicable based on machinery and electrical components utilized.

Superstructure Submittal

ITEM	Technical Proposal	90%	Final
Control House General Notes		C	F
Control house Reflected Ceiling Plan		C	F
Control House Access Bridge Dimensions	‡	C	F
Control House Access Bridge Reinforcing		C	F
Control House Access Bridge Bar List		C	F
Control Tower Floor Plans	P	C	F
Control Tower Sections	P	C	F
Control Tower Reinforcing Plans		C	F
Control Tower Reinforcing Elevations		C	F
Control Tower Section Reinforcing		C	F
Control Tower Bar List		C	F
Control Tower Schedules		C	F
Control Tower Elevations	P	C	F
Control Tower Building Sections		C	F
Control Tower Details		C	F
Control Tower Stair Plans		C	F
Control Tower Stair Sections		C	F
Control Tower Roof		C	F
Control Tower Door and Window Types and Details		C	F
Control Tower Architectural Details		C	F
Control Tower HVAC Notes		C	F
Control Tower HVAC and Plumbing Floor Plans		C	F
Control Tower HVAC and Plumbing Elevations		C	F
Bascule Leaf Notes		C	F
Bascule Leaf Framing Plan and Longitudinal Section	P	C	F

Exhibit 26-EE Summary of Design/Build Technical Proposal and Component Plan Submittals – Movable Bridges (cont.)

For approach span and foundation submittal requirements see **Exhibit 26-DD**.
 Provide the sheets listed as applicable based on machinery and electrical components utilized.

Superstructure Submittal (cont.)

ITEM	Technical Proposal	90%	Final
Bascule Leaf Transverse Sections at Floorbeams	P	C	F
Bascule Leaf Transverse Sections at Trunnion	P	C	F
Bascule Leaf Transverse Sections at Counterweight Girders	P	C	F
Main Girder Elevation	P	C	F
Main Girder Details		C	F
Main Girder Web Geometry and Camber Details		C	F
Main Girder Force Diagrams		C	F
Main Girder Reaction Influence Lines		C	F
Main Girder Moment Influence Lines		C	F
Floorbeam Details		C	F
Counterweight Girder Details		C	F
Stringer Details		C	F
Lateral Bracing Details		C	F
Counterweight Bracing Plan and Details		C	F
Counterweight Bracing Sections and Details		C	F
Counterweight Plan		C	F
Counterweight Longitudinal Sections		C	F
Counterweight Transverse Sections		C	F
Counterweight Details and Reinforcing Bar List		C	F
Bridge Deck Panel Layout		C	F
Bridge Deck Panel Sections		C	F
Bridge Deck Panel Details		C	F
Armored Joint Details		C	F
Span Lock Housing Details		C	F
Bascule Leaf Jacking Details and Notes		C	F
Mechanical General Notes	P	C	F
Mechanical Equipment Schedules	P	C	F
Drive Machinery Layout	P	C	F
Machinery Support Details		C	F

Exhibit 26-EE Summary of Design/Build Technical Proposal and Component Plan Submittals – Movable Bridges (cont.)

For approach span and foundation submittal requirements see **Exhibit 26-DD**.
 Provide the sheets listed as applicable based on machinery and electrical components utilized.

Superstructure Submittal (cont.)

ITEM	Technical Proposal	90%	Final
Trunnion Assembly Details	P	C	F
Open Gearing Details	P	C	F
Rack/Rack Frames and Rack Pinion Details	P	C	F
Mechanical Bearing Details	P	C	F
Drive Hydraulic Cylinders Details	P	C	F
Hydraulic System Layout/Piping Details	P	C	F
Hydraulic Cylinder Support Assemblies	P	C	F
Hydraulic System Details	P	C	F
Live Load Shoe Details	P	C	F
Centering Device Details		C	F
Span Lock Assembly Details	P	C	F
Control Tower – Control Console and Operator's Visualization Geometry Analysis Including CCTV Locations	P	C	F
Electrical General Notes	P	C	F
Electrical Site Plan	P	C	F
Conduit Riser Diagram	P	C	F
Single Line Diagram	P	C	F
Electrical Symbol Legend	P	C	F
Lighting and Equipment Plan (Including Control Tower Lighting, Fire Detection and Lighting Panel Schedules)	P	C	F
Lightning Protection, Bonding, and Grounding Plan	P	C	F
Navigation Lighting Plan	P	C	F
Communication Equipment Plan	P	C	F
Control Panel Details	P	C	F
Control Console Details	P	C	F
Block Diagram of Operating Sequence	P	C	F
Control System Architecture Diagram	P	C	F
Schematic Diagrams of all Control Systems and Interlocks	P	C	F

Exhibit 26-EE Summary of Design/Build Technical Proposal and Component Plan Submittals – Movable Bridges (cont.)

For approach span and foundation submittal requirements see **Exhibit 26-DD**.
 Provide the sheets listed as applicable based on machinery and electrical components utilized.

Superstructure Submittal (cont.)

ITEM	Technical Proposal	90%	Final
Control System I/O Points	P	C	F
Ladder Logic for PLC		C	F
Submarine Cable/Submarine Cable Termination Cabinet Details	P	C	F
Fire and Security Panel Schematic Diagram	P	C	F
CCTV Plan and Elevation	P	C	F
Limit Switch Development	P	C	F
Conduit and Cable Schedule	P	C	F
Electrical Equipment Layout - Including but not limited to Generators, Motors, Control Console, Control Panels, and Motor Control Center.	P	C	F
CCTV Layout		S	F

Status Key:

P – Preliminary

S – Substantially Complete

C – Complete but subject to change

F – Final

‡ – Where required for project.

Exhibit 26-F Precast Alternate Development

Precast Feasibility Assessment Questions:

Several negative responses to the following questions more than likely indicate precasting is not feasible for the project. In this case, provide a statement in the BDR stating that precasting is not feasible and indicate the reasons why in order to satisfy the requirements of **PPM Volume 1, Section 26.9.2 #9**.

- Will precasting reduce traffic impacts? Factors may include: average traffic volumes being affected, detour lengths and durations, lane reductions and duration.
- Is this structure likely to be on the critical path for construction of the project or is this structure on a hurricane evacuation route which requires accelerated delivery?
- Is the size of the project large enough to benefit from economy of scale, assembly line construction processes, and is it large enough to capitalize on a construction learning curve?
- Is precasting practical given the project aesthetics when component lifting weights are considered?
- Is precasting practical given project variability? Factors may include: formwork reuse, multiple construction methods and steps, and variable equipment requirements.
- Does the project site have space within FDOT R/W to use as a near-site casting yard and can precast elements be hauled from likely near-site casting yard locations to the site?
- Can precast elements be hauled from likely off-site prestressed yard locations to the site?
- Are the lifting weights practical given the assumed equipment, construction access, and construction methods?
- Can connection details be developed with the following characteristics –
 - durable?
 - easily inspected during construction?
 - accommodates shaft/pile placement tolerances?
 - accommodates fit up?
 - accommodates differential camber (full-depth deck panels)?

Exhibit 26-F Precast Alternate Development (Continued)

Assessment Matrix:

The following is a tool useful in documenting the decision making process for evaluation of precast construction versus conventional cast-in-place construction for a particular project. Also shown is a sample Alternate Cost Summary Table indicating how to summarize the component cost estimates and their sum.

SAMPLE ASSESSMENT MATRIX
- example values in italics -

Selection Factor	Factor Weight (%)	PRECAST		CONVENTIONAL	
		Score (0 to 5)	Weighted Score*	Score (0 to 5)	Weighted Score*
Total Direct Costs	<i>40</i>	<i>4</i>	<i>160</i>	<i>5</i>	<i>200</i>
Total Indirect Costs	<i>10</i>	<i>5</i>	<i>50</i>	<i>4</i>	<i>40</i>
Factor 3 - <i>Constructability</i>	<i>25</i>	<i>3</i>	<i>75</i>	<i>4</i>	<i>100</i>
Factor 4 – <i>Traffic Impacts</i>	<i>0</i>				
Factor 5 - <i>Construction Duration</i>	<i>0</i>				
Factor 6 - <i>Durability</i>	<i>0</i>				
Factor 7 – <i>Environmental Impacts</i>	<i>10</i>	<i>5</i>	<i>50</i>	<i>2</i>	<i>20</i>
Factor 8– <i>Aesthetics</i>	<i>15</i>	<i>5</i>	<i>75</i>	<i>3</i>	<i>45</i>
Factor 9 – <i>Other</i>	<i>0</i>				
Factor 10 – <i>Other</i>	<i>0</i>				
TOTAL (Σ Factor Weights = 100%)	<i>100</i>		<i>410</i>		<i>405</i>
TOTAL (Excluding Indirect Cost Factor)**	<i>90</i>		<i>360</i>		<i>365</i>

*Weighted Score = Factor Weight x Score **See following explanation, Instructions “6.”

Assessment Matrix Instructions:

- List Selection Factors** to be used to evaluate the applicability of alternates to meet the goals of the project. Factors are project specific and always include Total Direct Costs and Total Indirect Costs (road user costs) and may include some of the following: Constructability, Traffic Impacts (e.g., Maintenance of Traffic, Detours, Traffic Delays, etc.), Construction Duration, Durability, Environmental Impacts, and Aesthetics. Include other Factors as required to capture any unique project characteristics that are not otherwise addressed. Note that as many or as few criteria may be used in the assessment matrix as deemed appropriate by the designer; though, a sufficient number of Selection Factors (i.e., criteria) are required to provide a thorough evaluation of the alternates being considered to meet the objectives of the project. When choosing selection factors and applying factor weights avoid double counting benefits. For instance, indirect costs and traffic impacts may be related selection factors.

Exhibit 26-F Precast Alternate Development (Continued)

Costs of precast versus conventional may be affected by:

- Savings associated with labor rates and insurance costs for reduced time working from a barge on a large water project.
 - Savings associated with structural efficiencies resulting from precasting (e.g., composite dead loads in the case of shored deck casting).
 - Savings associated with simultaneous substructure and superstructure component construction.
 - Savings associated with increased productivity rates of precasting.
2. **Construct** a two-dimensional table allowing one row for each Selection Factor and two columns for each alternate, one for Score and one for Weighted Score.
 3. **Factor Weights** to distinguish the level of importance of each criterion relative to the other criteria in achieving the project objectives. Weighting the various factors will usually require Department/District input. Distribute the Factor Weights such that their sum is equal to 100%.
 4. **Score** the relative difference between alternates. Range of scores can vary for a given project (e.g., 0 to 5 or 0 to 10). Scoring may be accomplished by a committee and then the average score for each Selection Factor entered into the matrix.
 5. **Calculate** the Weighted Score by multiplying the Factor Weight by Score for each alternate.
 6. **Total** the Weighted Score columns: (1) Provide the absolute total of each column, which includes the Indirect Costs Score and, (2) Provide the column total *excluding* the contribution from the "Total Indirect Costs." It is useful for management to compare the impacts, both relative and in hard dollar amounts, of indirect costs on bridge construction projects when making their decisions. *The column with the largest total weighted score theoretically indicates the alternate which most closely meets the project objectives as implicated by the matrix construct.*

Exhibit 26-F Precast Alternate Development (Continued)

SAMPLE ALTERNATE COST SUMMARY

Alternate	Direct Costs* (\$)	Indirect Costs**							Sum: Direct + Σ Indirect (\$)
		Lane Closures		Detour Time		Facility Closure		Σ Indirect (\$)	
		Days (#)	\$\$/Day	Days (#)	\$\$/Day	Days (#)	\$\$/Day		
Precast 1									
Precast 2									
Conventional 1									
Conventional 2									

* In calculation of Direct Costs, give specific consideration to factors that will:

- increase the cost of the bridge, as necessary to accommodate:
 - self-propelled modular transporters (SPMTs)
 - large capacity cranes
 - special erection equipment
 - casting yard setup
- decrease the cost of the bridge, as necessary to accommodate:
 - reduced labor rates (e.g., work from barges)
 - reduced maintenance of traffic (MOT) work restrictions
 - reduced worker compensation insurance rates (e.g., work from barges)
 - increased production rates due to assembly line processes.
 - increased production rates due to multiple crews working simultaneously

** Use engineering judgment and knowledge of construction processes to estimate the number of days required for each lane closure, detour, or facility closure for each alternate. Coordinate this estimate with the preliminary construction schedule and MOT scheme.

Exhibit 26-F Precast Alternate Development (Continued)

Referenced Links:

- Connection Details for Prefabricated Bridge Elements and Systems
<http://www.fhwa.dot.gov/bridge/prefab/if09010/>
- Manual on Use of Self-Propelled Modular Transporters to Remove and Replace Bridges
<http://www.fhwa.dot.gov/bridge/pubs/07022/>
- Framework for Decision-Making
<http://www.fhwa.dot.gov/bridge/prefab/framework.cfm>
- Prefabricated Bridge Elements and Systems Cost Study: Accelerated Bridge Construction Success Stories
<http://www.fhwa.dot.gov/bridge/prefab/successstories/091104/index.cfm>
- FDOT RUC (Road User Cost) software (*only available through infonet*)
<http://infonet.dot.state.fl.us/tlconstruction/SchedulingEng/AddSoftwareScheduling.htm>

THIS PAGE LEFT BLANK INTENTIONALLY

Chapter 27

Hydraulic Data and Agency Permits

27.1	Bridge Hydraulic Report (BHR)	27-1
27.2	Bridge Hydraulic Recommendation Sheet (BHRS).....	27-1
27.3	Agency Permits	27-1
27.4	Scour Considerations	27-2
27.4.1	Development of Scour Design Criteria	27-2
27.4.2	Scour Design of Bridge Foundations	27-4
27.4.3	Submittal Requirements for Scour Design.....	27-5
27.5	Debris Accumulation	27-6
27.6	Widenings	27-6
27.7	Scour Elevations	27-6
Exhibits		
Exhibit 27-A	Structural Plans Development	27-7

THIS PAGE LEFT BLANK INTENTIONALLY

Chapter 27

Hydraulic Data and Agency Permits

27.1 Bridge Hydraulic Report (BHR)

A Bridge Hydraulic Report (BHR) package consisting of the BHR and, as applicable, the Bridge Hydraulics Recommendation Sheet, bridge hydraulic calculations, and scour calculations must be prepared as specified in **Chapter 4** of the FDOT *Drainage Manual*, **Topic No. 625-040-002**. Process the BHR package as specified later in this chapter.

27.2 Bridge Hydraulic Recommendation Sheet (BHRS)

A Bridge Hydraulic Recommendation Sheet (BHRS) for new structures and widenings must be prepared as specified in **Chapter 4** of the FDOT *Drainage Manual*. Process the BHRS package as specified later in this chapter.

27.3 Agency Permits

Most projects will require several permits from Federal, State and local agencies. For examples of the types of permits that may be required, please see the **Project Development and Environmental Manual**, Chapter 12.

Modification for Non-Conventional Projects:

Add the following to the above paragraph:

The Design-Build firm is responsible for acquisition of all applicable permits, unless otherwise indicated in the project RFP.

27.4 Scour Considerations

Develop scour estimates using a multi-disciplinary approach involving the Hydraulics Engineer, the Geotechnical Engineer, and the Structures Design Engineer. Design bridges and bridge culverts to withstand the design flood without damage and should withstand the 500-year flood (super flood) without failure. Refer to the **Structures Design Guidelines** for specific foundation design steps and the **Drainage Manual** for policy on scour computations.

27.4.1 Development of Scour Design Criteria

The extent and the mitigating steps needed to resolve scour problems should be resolved early in the design process. The Bridge Development Report (BDR), or 30% structures plans submittal when a BDR is not required, is a means of addressing and resolving all major design issues early in the total design process and should also define the need for scour considerations, establish the scour parameters, and arrive at possible solutions. The necessary steps are as follows:

Modification for Non-Conventional Projects:

Delete the second sentence of the above paragraph and replace with the following:

Submit the scour calculations as part of the 90% foundation component plan submittal.

1. The Drainage Design Engineer evaluates stream stability and scour potential based on all available data, assumed soil conditions, structure positioning, and foundation designs. The Drainage Design Engineer's assumptions (hydraulic, geotechnical, and structural) and design parameters should be discussed with both the Geotechnical and Structures Design Engineers. When evaluating stream stability and scour potential, the recommendations developed from FHWA's **Hydraulic Engineering Circular (HEC)** should be followed as well as the design requirements provided in **Chapter 4** of the FDOT **Drainage Manual**. This work should take place early in the PD&E study where changes in the alignment could affect the severity of general scour.
2. Given the scour potential and based on known subsoil conditions and where knowledge of the local variability of the subsoil is available, the Geotechnical Engineer will then consider the possible alignments. It may be necessary to conduct exploratory work if variability of subsoil conditions are suspected but not sufficiently defined. The results of exploratory investigations should be discussed

- with both the Hydraulics and Structures Design Engineer, and any previous scour assumption verified and/or modified.
3. The Structures Design Engineer should provide approximate span ranges, pier configurations, and pier locations necessary for the different alternates. In addition, possible foundation types and approximate size should be developed such that the Drainage Design Engineer can estimate local scour potentials. Conditions to be considered are:
 - a. The extent and severity of scour along the alignment must be developed. For example, for bridges over a wide body of water, general scour could vary in extent and severity. It may be reasonable, therefore, to consider fewer foundations in the most severe areas (i.e., span the problem), or take appropriate steps to assure the structural integrity of the foundation in those locations.
 - b. The pile driving resistance, which must be overcome at the time of construction, may be greater than the ultimate pile capacity at a later date due to subsequent scour activity.
 - c. Likewise, design drilled shaft capacity must account for the possibility that ultimate capacity will be reduced as a result of future scour activity.
 4. The Drainage, Geotechnical and Structures Design Engineers must develop the scour potential and rate each location and furnish the results to the District Environmental Management Office (DEMO) Engineer for consideration in establishing the recommended alignment(s).
 5. The preferred alignment is established by others.
 6. The Structures Design Engineer develops more detailed calculations showing possible span arrangements and types and sizes of foundations.
 7. The three engineers review the proposed configuration to assure that scour has been properly addressed. (The Drainage Design Engineer reviews both the general and local scour potential and recommends continuation or changes).
 8. The Structures Design Engineer finalizes his configuration and proceeds with an even more detailed analysis of the foundation including the anticipated pile tip elevations. All three Engineers must review and concur. The final results are then incorporated into the BDR or 30% Plans Stage as applicable.

The eight (8) steps described above are shown as a flow diagram in **Exhibit 27-A. Modification for Non-Conventional Projects:**

Delete the sentence above.

Delete the third sentence of item 8, above and replace with the following:

Submit the final results as part of the 90% foundation component plan submittal.

27.4.2 Scour Design of Bridge Foundations

This is a multi-discipline effort involving Geotechnical, Structures, and Hydraulics/Coastal Engineers. The process described below will often require several iterations. The foundation design must satisfactorily address the various scour conditions, and furnish sufficient information for the Contractor to provide adequate equipment and construction procedures. These three engineering disciplines have specific responsibilities in considering scour as a step in the foundation design process.

1. The Structures Engineer determines the preliminary design configuration of a bridge structure utilizing all available geotechnical and hydraulic data and performs lateral stability evaluations for the applicable loadings described in the **Structures Design Guidelines**, Substructure Limit States, (do not impose arbitrary deflection limits except on movable bridges). A preliminary lateral stability analysis generally will occur during the BDR phase of the project, and a final evaluation will occur subsequent to the selection of the final configurations. The Structures Engineer must apply sound engineering judgment in comparing results obtained from scour computations with available hydrological, hydraulic, and geotechnical data to achieve a reasonable and prudent design.

Modification for Non-Conventional Projects:

Delete the second sentence of item 1, above and replace with the following:

A preliminary lateral stability analysis will occur during the preparation of the Technical Proposal of the project, and a final evaluation will occur subsequent to the selection of the final configurations.

2. The Hydraulics Engineer, utilizing good engineering judgment as required by policy from the FDOT **Drainage Manual**, provides the predicted scour elevation through a 100-year flood event (100-Year Scour), a 500-year flood event

(500-Year Scour), and for "Long-Term Scour". "Long Term Scour" is defined and described in Chapter 4 of the FDOT *Drainage Manual*.

3. The Geotechnical Engineer provides the nominal axial (compression and tension) capacity curves, mechanical properties of the soil and foundation recommendations based on construction methods, pile availability, similar nearby projects, site access, etc.

27.4.3 Submittal Requirements for Scour Design

During the 30% and 90% structures plans stage reviews, the EOR must coordinate the reviews of the design of both the Drainage and Geotechnical Engineers to assure compliance with the results of the scour calculations. The EOR must consult with the District Structures Maintenance Engineer for scour inspection reports on existing bridges.

Modification for Non-Conventional Projects:

Delete the first sentence of the above paragraph and replace with the following:

During the 90% foundation component plans submittal, the EOR must coordinate the reviews of the design of both the Drainage and Geotechnical Engineers to assure compliance with the results of the scour calculations.

27.5 Debris Accumulation

Debris accumulation on the upstream side of substructure units can significantly affect the flow of water and cause significant scour. Evaluate the type of vegetation upstream from the bridge and consider the probability of debris accumulation in establishing types and locations of substructure units. Special consideration must be given to mitigating debris accumulation on substructure units.

Debris clearance criteria are specified in **Section 2.10.1** of this volume.

27.6 Widening

The design for scour described above must be included in the widening of an existing bridge structure classified as a major widening as defined in the FDOT **Structures Design Guidelines**.

The requirement to include scour potential in the design of the widening of an existing structure classified as a minor widening will be considered by the Department on an individual basis.

Modification for Non-Conventional Projects:

Delete the above paragraph and see RFP for requirements.

Scour design procedures are specified in the FDOT **Drainage Manual, Chapter 4**.

27.7 Scour Elevations

The 100-year and 500-year scour elevations are required for the design of all bridges over watercourses. In addition, the Long-Term Scour Elevation must be established for bridge structures required to meet the extreme event vessel collision load. For more information on these scour elevations see the FDOT **Drainage Manual**.

Exhibit 27-A Structural Plans Development Sheet 1 of 2

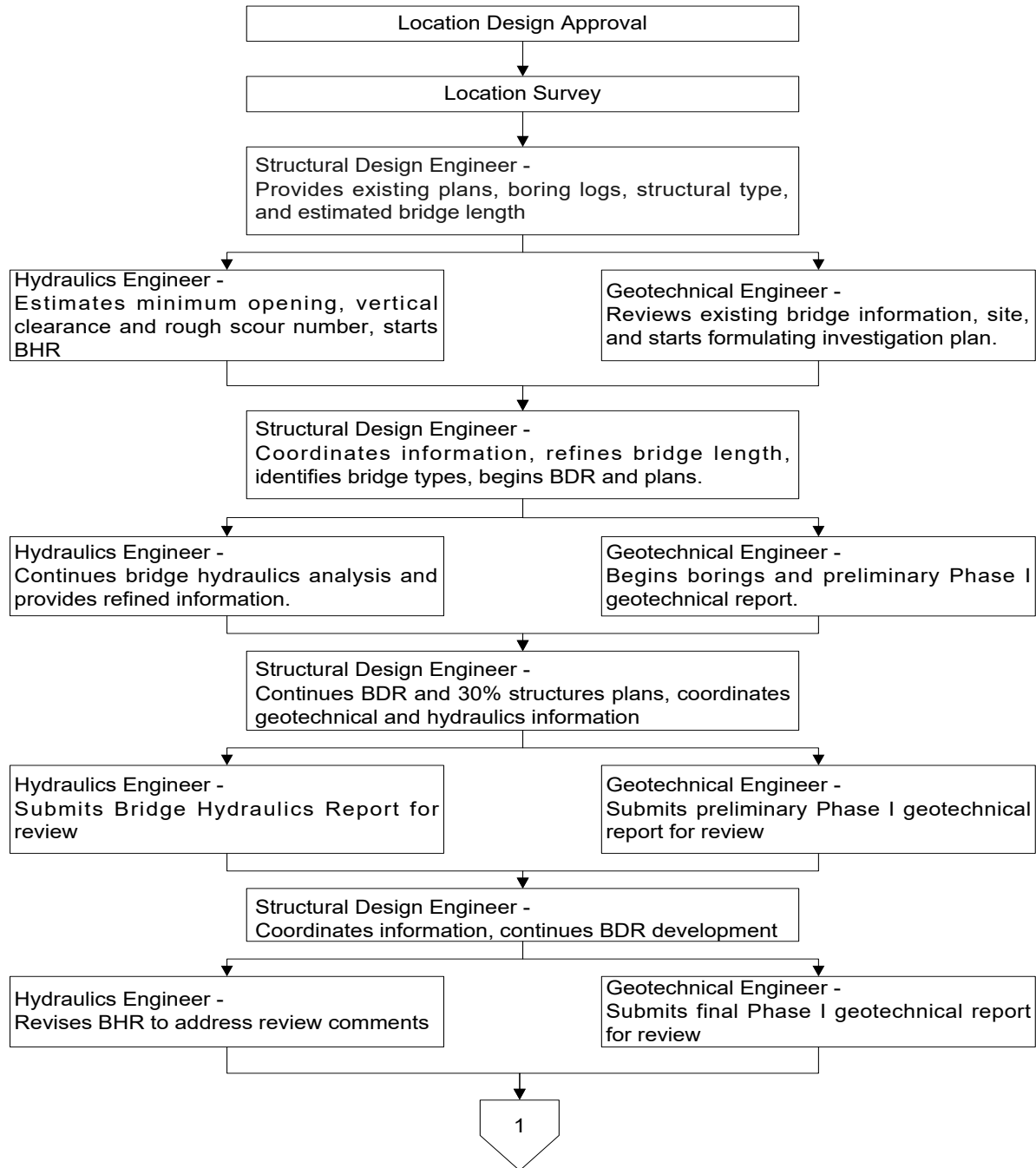
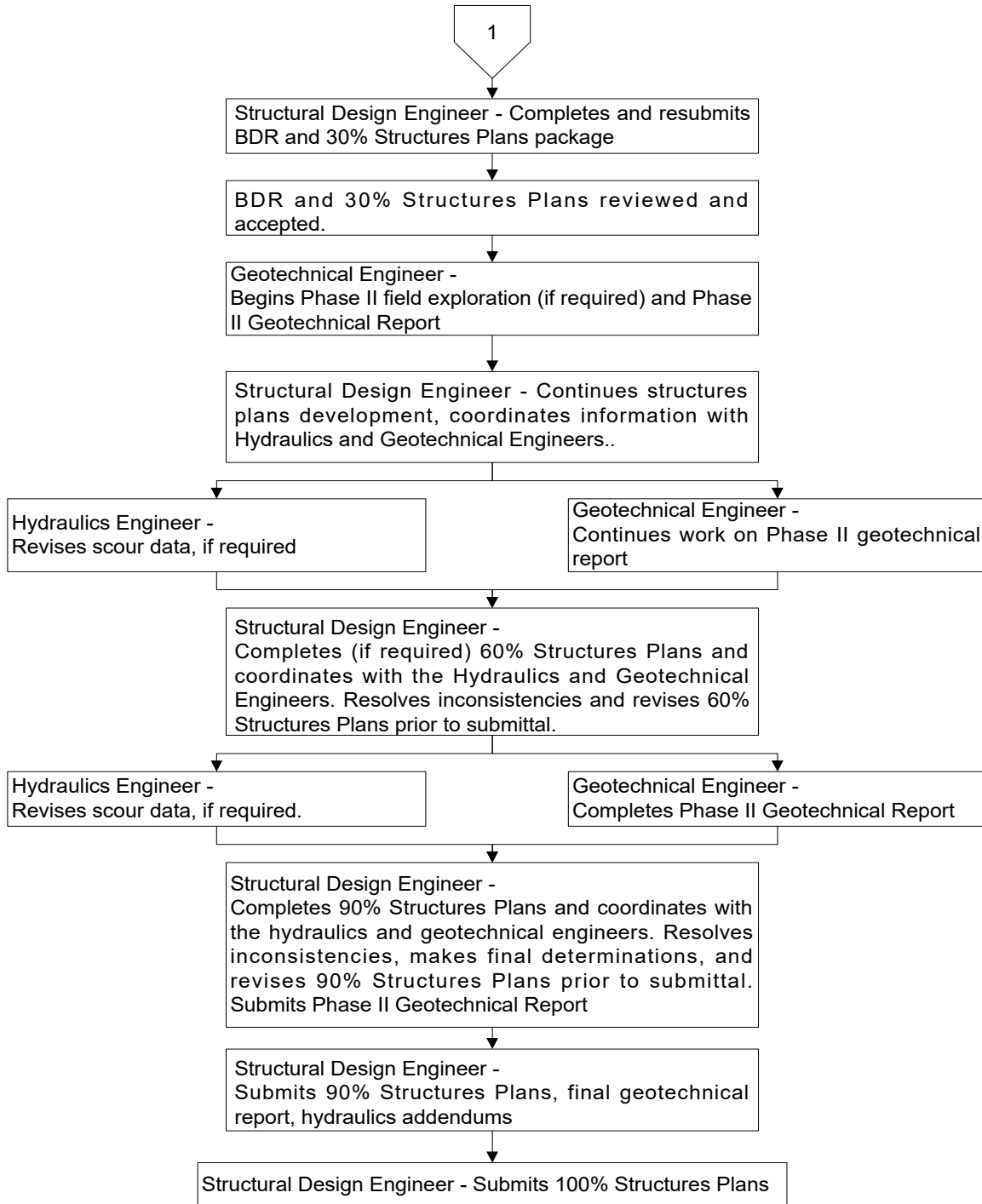

Exhibit 27-A Structural Plans Development

Sheet 2 of 2



Chapter 28

Shop and Erection Drawings

28.1	Introduction	28-1
28.2	Drawing Submittals Required	28-3
28.3	Contractor Information Required	28-4
28.4	Submittals Requiring a Specialty Engineer.....	28-6
28.5	Scheduling of Submittals.....	28-7
28.6	Transmittal of Submittals.....	28-9
28.6.1	General Submittal Requirements.....	28-9
28.6.2	Requirements for Department EOR.....	28-10
28.6.3	Requirements for Consultant EOR (Full Services)..	28-10
28.6.3.1	Review by Engineer of Record only.....	28-10
28.6.3.2	Review by Engineer of Record and the Department.....	28-11
28.6.4	Requirements for Consultant EOR (Design Services Only).....	28-11
28.6.5	Requirements for Architectural or Building Structures.....	28-12
28.6.6	Requirements for Roadway Submittal Items.....	28-12
28.6.7	Requirements for Overhead Sign Structures and Nonstandard Miscellaneous Structures	28-12
28.6.8	Miscellaneous Requirements and Assistance	28-12
28.7	Disposition of Submittals	28-13
28.7.1	Minor Modifications	28-16
28.7.2	Major Modifications	28-17

28.8	Segmental Bridges - Shop Drawing Checklist	28-18
28.9	Distribution of Submittals.....	28-19
28.10	Review of Prequalified Joint Welding Procedures	28-21
28.11	Submittal Activity Record (Logbook)	28-22
28.12	Archiving Record Shop Drawings.....	28-23

Tables

Table 28.1	FDOT Changes to Minor Modifications.....	28-16
Table 28.2	FDOT Changes to Major Modifications.....	28-17
Table 28.3	Shop Drawing Distribution Schedule	28-19

Exhibits

Exhibit 28-A	Shop Drawing Flow Diagram for Reviews with Consultant EORs without FDOT Review	28-24
Exhibit 28-B	Shop Drawing Flow Diagram for Performed by Consultant EOR with FDOT Review	28-25
Exhibit 28-C	Shop Drawing Flow Diagram for Reviews Performed by FDOT Only.....	28-26
Exhibit 28-D	Record Shop Drawing Transmittal.....	28-27
Exhibit 28-E	Shop Drawing Flow Diagram for Design-Build Projects	28-28

Chapter 28

Shop and Erection Drawings

28.1 Introduction

Shop Drawings include all drawings, diagrams, illustrations, schedules, catalog data, material certifications, fabrication procedures, storage and/or transportation procedures, test results, design calculations, etc., required by the Contract Plans and Specifications and submitted by the Contractor to define some portion of the project work. While the Contract Plans and Specifications (including Supplemental and Special Provisions) define the overall nature of the project with many specific requirements, Shop Drawings provide a method for the Contractor to propose, under specification guides and for the Department to approve or reject a particular material, product or system of accomplishing the work. Each Contractor knows best what materials and equipment can be provided more expeditiously and economically and, if an item proposed meets the contract requirements, the submission of Shop Drawings is the accepted method of approving an element of the structure while allowing flexibility in the Contractor's choice of materials and construction techniques.

It is mandatory, however, that Shop Drawings not be used to modify the construction contract time, the contract amount, the design intent nor in any way reduce the maintainability, structural integrity or load-carrying capacity of the structure or its components. Such modifications can only be administered by revised plan sheets or specifications.

Erection Drawings include all drawings, diagrams, design calculations, procedure manuals and other data required to depict in detail the proposed assembly and methods of installation of components into the project work. The work of construction is the expertise of the Contractor, who should be allowed some latitude in the use of construction means, methods, techniques, sequences and procedures as are compatible with and will result in the project being completed in accordance with the requirements of the Contract Plans and Specifications. Shop Drawings for items such as steel girders, non-standard precast/prestressed beams, miscellaneous steel, etc., usually include plan views and/or elevation views denoting the correct placement of a component in the structure. Additional Erection Drawings are required for major structures for items such as special precasting, handling and erection equipment, or the erection of concrete segmental bridges. The Engineer of Record must ensure that the Contract Plans and Special Provisions for the project clearly define all requirements for submittal of Erection Drawings.

The following are definitions used herein:

1. **Engineer:** As defined in *FDOT Standard Specifications for Road and Bridge Construction, Section 1*.
2. **Engineer of Record:** As defined in the *FDOT Standard Specifications for Road and Bridge Construction, Section 1*.
3. **Specialty Engineer:** As defined in the *FDOT Standard Specifications for Road and Bridge Construction, Section 1*.
4. **Consultant:** The Professional Engineer or Engineering Firm, or the Architect or Architectural Firm, licensed in the State of Florida and under contract to the Department to perform professional services. The consultant may be the Engineer or Architect of Record or may provide services through and be subcontracted to the Engineer or Architect of Record.
5. **Architect of Record:** The Architect or Architectural Firm registered in the State of Florida that performs services for the Department in connection with the design and construction of buildings.

Modification for Non-Conventional Projects:

Delete **Architect of Record** definition and replace with the following:

5. **Architect of Record:** As defined in the *Design-Build Division I Specifications, Section 1*.

6. **"Ballooning":** The Contractor's use of minimum 1/16 inch wide lines to "balloon" or "cloud" (encircle) notes or details on drawings, design calculations, etc., in order to explicitly and prominently call out any deviations from the Contract Plans or Specifications. The Engineer of Record may also use "ballooning" to make note of any limitations to their submittal review and disposition of shop and erection drawings.
7. **Record Shop Drawings:** The Department's official record copy of all Shop drawings, Erection Drawings, calculations, manuals, correspondence/ transmittal files and submittal activity record (logbook).
8. **FDOT Shop Drawing Review Office:** The office or other Department entity responsible for performing the Department's review, record keeping, disposition and distribution of Shop and Erection Drawings to other disciplines within the district for review as well as distribution back to the project personnel. This office is normally the District Structures Design Office.

9. **Final Review Office:** FDOT Shop Drawing Review Office or the Engineer of Record performing the final review and making final distribution of shop drawings which have been reviewed.

Modification for Non-Conventional Projects:

Expand with the following:

10. **Design-Build Firm:** As defined in the *Design-Build Division I Specifications, Section 1*.

28.2 Drawing Submittals Required

Generally, Shop Drawings are required for items which require fabrication at a location other than the project job site.

The Department requires shop drawings only for items of work not fully detailed in the plans which require additional drawings and coordination prior to constructing the item and temporary works affecting public safety. These items include, but are not limited to, bridge components not fully detailed in the plans; retaining walls systems; precast box culverts; non-standard lighting, signalization, and signing structures; building structures; non-standard drainage structures; attenuators; and temporary works affecting public safety.

Unless otherwise noted in the Special Provisions for the project, Shop Drawings are not required for reinforcing steel for cast-in-place concrete which is completely detailed and listed on the Contract Plans or on the Department's *Design Standard* Index Drawings. Components such as traffic signal equipment, steel or aluminum light poles, concrete strain poles and high mast lighting may not require submittal of Shop Drawings due to having prior certification by the Department. The Contractor may contact the Engineer (CEI) or the FDOT Shop Drawing Review Office for clarification of any item.

Material certifications, welding procedures, paint procedures and concrete mix designs are typically submitted by the Contractor to the Engineer (CEI) who forwards the certifications to the State Materials Engineer in Gainesville. These items do not need to be submitted to the FDOT Shop Drawing Review Office for review and approval. For non-standard items, the Engineer (CEI) will typically request approval by the EOR regarding applicability. Material certification for items on the Approved Product List (APL) is typically submitted by the Contractor to the Engineer (CEI).

Items fully detailed in the ***Design Standards DO NOT*** need a shop drawing submittal unless it is specifically required by a particular Standard Index.

Drawing submittals for any item must follow industry standards in regard to the quantity and quality of information contained. The information shown on approved shop drawings must be complete enough to allow for fabrication of the item without referencing any other document. The Department expects submittals to meet or exceed the quality level of previously approved submittals of a similar nature.

During component fabrication and construction phases of the project, the Contractor may elect to submit to the Engineer, for consideration or approval, repair procedures or disposition requests due to errors or omissions in the work. The information required and the procedure to be followed by the Contractor in initiating such requests must be in accordance with the FDOT ***Specifications*** or as determined by the Engineer (CEI).

28.3 Contractor Information Required

All Shop Drawings and Erection Drawings must contain the following minimum information: the complete Financial Project Identification, drawing number, drawing title, a title block showing the name of the fabricator or producer and the Contractor for which the work is being done, the initials of the person(s) responsible for the drawing, and the date.

The drawing must also contain, adjacent to the title block, information which describes the location of the item(s) within the project. This information may consist of the Contract Drawing number, the station at which the item is positioned (as may be the case for sign structures or handrails), or the Site at which it is to be installed. Other documents such as trade literature, catalogue information, calculations and manuals must be bound and submitted with a Table of Contents Cover.

Before submission of each drawing, the Contractor must determine and verify all quantities, dimensions, specified performance criteria, installation requirements, materials, catalog numbers and similar data with respect thereto, and must review and coordinate each drawing with other Shop Drawings and with the requirements of the Contract Plans and Specifications. The Contractor must stamp and initial each sheet indicating on the stamp that the shop drawing review and approval is for conformance with the design concept of the project and for conformance with the information given in the Contract Plans and Specifications (including Supplemental Specifications and Special Provisions).

Modification for Non-Conventional Projects:

Delete the above paragraph and replace with the following:

The Design-Build Firm is responsible for the preparation and approval of all shop drawings and calculations. Once the shop drawings have been reviewed and approved by both the Contractor and Engineer of Record (EOR), submit Shop Drawings and calculations to the Engineer for review and approval by the Department. Before submission, the Contractor and EOR must determine and verify all quantities, dimensions, specified performance criteria, installation requirements, materials, catalog numbers and similar data with respect thereto, and must review and coordinate each drawing with other Shop Drawings and with the requirements of the Contract Plans and Specifications. The Contractor must stamp

and initial each sheet indicating that the shop drawing review and approval is for conformance with the design concept of the project and for conformance with the information given in the Contract Plans and Specifications (including Supplemental Specifications and Special Provisions).

Only shop drawings stamped "APPROVED" or "APPROVED AS NOTED" will be forwarded to the Engineer for review by the Department. Shop drawings submitted without the stamps of the Contractor and the Engineer of Record (EOR) will be returned for re-submittal. When the Department requires a resubmittal, the drawings must be modified by the Contractor, resubmitted to the EOR for approval, and then resubmitted to the Engineer for review by the Department. In the case where the EOR generates the shop drawings for the project, another engineer within the EOR's firm, not involved in the production of the shop drawing, must review and stamp the drawings per the requirements stated herein.

The Contractor's approval signifies that the submittal meets the requirements of the Contract Plans and Specifications and conforms to field dimensions or other potential deviations from the established project documents. Drawing submittals received without stamping by the Contractor will be returned for resubmittal.

At the time of each submission, the Contractor must give specific written notice (as in the transmittal letter) of each variation the Shop/Erection Drawings may have from the requirements of the Contract Plans and Specifications. In addition, the drawings must contain a specific notation which explicitly and prominently calls out any deviation. Approval of Shop/Erection Drawings will not constitute nor be considered grounds for

approval of a variation in which the project requirements are affected unless specifically indicated in the Department's shop drawing transmittal letter.

28.4 Submittals Requiring a Specialty Engineer

The Specialty Engineer is required to provide a signed and sealed submittal if a Shop/Erection Drawing submittal reflects any minor changes in the design and/or details of the Contract Plans. The Contract Plans and Specifications (including Supplemental and Special Provisions) must contain instructions regarding requirements of a Specialty Engineer for items such as concrete segmental bridge work, loads imposed on an existing structure, or certain construction procedures and/or equipment.

Modification for Non-Conventional Projects:

Expand the above paragraph with the following:

In the case where the Engineer of Record generates shop drawings for the project, the Engineer of Record must seal one (1) print of each drawing affected as well as the cover sheet of one (1) copy of any design calculations required.

Submittals which introduce engineering input to the project, such as defining the configuration or structural capacity of prefabricated components or assemblies not contained in the Contract Plans, require the services of a Specialty Engineer.

Modification for Non-Conventional Projects:

Expand the above paragraph with the following:

The Engineer of Record may perform as Specialty Engineer.

Drawings prepared solely as a guide for component fabrication/ installation and requiring no engineering input, such as reinforcing steel drawings and catalog information on standard products, do not require the use of a Specialty Engineer.

When required, the Specialty Engineer must provide a signed and sealed submittal. Computer printouts are an acceptable substitute for manual computations provided they are accompanied by sufficient documentation of design assumptions and identified input

and output information to permit their proper evaluation. Such information must be signed and sealed by the Specialty Engineer.

When a submittal requires a Specialty Engineer, the sealed prints and calculations will ultimately be retained by the Department, as the official, record Shop Drawing. See also Transmittal of Submittals hereinafter.

28.5 Scheduling of Submittals

The Contractor is required to submit a Shop Drawing schedule to the Engineer (CEI) within 60 days of the start of construction operations, and prior to the submission of any shop drawings. Adherence to the Shop Drawing schedule is intended to allow for the planning of resources and to reduce the possibility of a large number of submittals being forwarded for review concurrently.

The Contractor is required to schedule submissions such that a minimum of 45 calendar days is allowed for review by the Department for routine work of which the first 30 calendar days are allotted to prime review by the Engineer of Record. Allowance must be made for potential resubmittals, and the Contractor normally is advised by the Department to consider a 75 to 90 calendar days total lead-time for submittals prior to the need for fabrication or construction work. When voluminous shop drawings are submitted at one time such that the combined EOR and FDOT Shop Drawing Review Office 45-day review time will likely not be met, notify the Engineer (CEI).

Modification for Non-Conventional Projects:

Delete the above paragraph and replace with the following:

Once the shop drawings and calculations have been reviewed and approved by both the Contractor and Engineer of Record, the Design-Build Firm is generally required to schedule submissions such that the review period given in the RFP is accommodated. Allowance must be made for potential resubmittals and the Contractor normally is advised by the Department to consider a 75 to 90 calendar days total lead-time for submittals prior to the need for fabrication or construction work. When voluminous shop drawings are submitted at one time such that the FDOT Shop Drawing Review Office review period described in the RFP will likely not be met, notify the Engineer (CEI).

Shop drawings cannot be submitted, processed, reviewed, or approved until the component plan set for the particular item is stamped "Released for Construction".

The Contractor must make submittals for approval with such promptness as to cause no delay in his fabrication and construction schedules. Only in emergency cases should special consideration be requested.

If a submittal requires resubmission, an approximate additional 30 calendar days should be scheduled by the Contractor for approval of the resubmittal of which the first 15 calendar days are allotted to prime review by the Engineer of Record.

Modification for Non-Conventional Projects:

Delete the above paragraph and replace with the following:

If a submittal requires resubmission, an approximate additional 15 calendar days should be scheduled by the Contractor for approval of the resubmittal by the Department.

28.6 Transmittal of Submittals

Submittal of Shop/Erection Drawings must be made to the designated parties, as applicable, only by the Contractor for the project. In that the Department's legal contracts and documents are with the Contractor, submittals will not be accepted directly from a subcontractor or fabricator. Situations may occur when a subcontractor or fabricator is allowed to make an advance submittal for review; however, the actual submittal to be stamped and approved must follow from the Contractor with the Contractor's stamp. Subcontractors and fabricators are encouraged to contact the appropriate FDOT Shop Drawing Review Office for guidance or advice at any time.

Exhibits 28-A thru **28-C** show the flow of submittals during the review process. All transmittals of submittals between parties must be accomplished by OVERNIGHT DELIVERY or by HAND DELIVERY.

Modification for Non-Conventional Projects:

Delete the above paragraph and replace with the following:

Exhibit 28-E shows the flow of submittals during the review process. All transmittals of submittals between parties must be accomplished by OVERNIGHT DELIVERY or by HAND DELIVERY.

The Special Provisions for the project may denote the amount of drawings, etc. to be submitted and the procedure to be followed. Furthermore, the office to which the Contractor must transmit his submittal and the procedure to be followed may also be defined during the preconstruction conference for the project. In the absence of such instructions, the following generally applies:

28.6.1 General Submittal Requirements

On projects where the Engineer of Record is a Consultant to the Department, and unless otherwise directed at the project's preconstruction conference, the Contractor must submit two (2) sets of xerographic reproduces directly to the Engineer of Record. On projects where the Department is the Engineer of Record, the Contractor must submit two (2) sets of xerographic reproduces and four (4) complete sets of design calculations including computer printouts directly to the FDOT Shop Drawing Review Office, or as directed in the preconstruction meeting. All drawings must be on sheets not larger than

11" x 17". The Contractor's letter of transmittal must accompany the drawings and a copy must be sent to the Engineer (CEI). On those projects where the Engineer of Record is a Consultant to the Department, and the Department will be reviewing the shop drawings, a second copy of the Contractor's letter must also be sent to the FDOT Shop Drawing Review Office.

Modification for Non-Conventional Projects:

Delete the above paragraph and replace with the following:

28.6.1 General Submittal Requirements

Once the shop drawings and calculations have been reviewed and approved by both the Contractor and Engineer of Record, the Contractor must submit two (2) sets of xerographic reproducibles and four (4) complete sets of design calculations including computer printouts to the Engineer (CEI), or as directed in the preconstruction meeting. All drawings must be on sheets not larger than 11" x 17". The Contractor's letter of transmittal must accompany the drawings.

28.6.2 Requirements for Department EOR

On projects where the Engineer of Record is Department in-house staff, submittals must be transmitted to the FDOT Shop Drawing Review Office or as directed at the project's preconstruction conference. The FDOT Shop Drawing Review Office is the principal contact group and "clearing house" for all construction submittals and information desired by the Contractor regarding structural, mechanical or electrical items.

28.6.3 Requirements for Consultant EOR (Full Services)

28.6.3.1 Review by Engineer of Record only

On projects where the Engineer of Record is a Consultant to the Department and has been retained by the Department to review construction items without follow-up review by the Department, the Consultant will assume the responsibility of the owner's agent. The reviewing consultant is encouraged to communicate with fabricators, contractors,

specialty engineers and the FDOT Shop Drawing Review Office to clarify concerns before returning the submittal to the Contractor. The reviewing consultant must also contact the Department's Structures Office if unsure of the Department's position on certain issues during the review. Where possible, mark all necessary requirements on the shop drawing sheet and stamp "APPROVED AS NOTED" instead of requiring a resubmittal. Submittals (unless otherwise noted below) must be transmitted by the Contractor directly to the Consultant. Upon receipt of the submittal, the Consultant must perform the review, note any comments directly on the sheets, make the appropriate numbers of copies, indicate his disposition by stamping the sheets as described hereinafter, retain one set of prints for his files and, finally, make distribution as described hereinafter. The original prints and calculations form the official, record Shop Drawing submittal and must be retained by the Engineer of Record and forwarded to the Department at the end of the project.

28.6.3.2 Review by Engineer of Record and the Department

On projects where the Engineer of Record is a Consultant to the Department and has been retained by the Department to review construction items, submittals (unless otherwise noted below) must be transmitted by the Contractor directly to the Consultant. Upon receipt of the submittal, the Consultant must perform the review, note any comments directly on the sheets, indicate his disposition by stamping the sheets as described hereinafter, retain one set of prints for his files and, finally, transmit the original sheets to the FDOT Shop Drawing Review Office for review and distribution. When submittals require a Specialty Engineer, the original prints and calculations from the official, record Shop Drawing submittal and must be retained by the Department. Upon completion of his review, the Consultant must transfer his comments to the sealed sheets, indicate his disposition and transmit them to the Department as described above.

28.6.4 Requirements for Consultant EOR (Design Services Only)

On projects where the Engineer of Record is a Consultant to the Department but has not been retained by the Department to review construction items, submittals (unless otherwise noted below) must be transmitted by the Contractor directly to the FDOT Shop Drawing Review Office or as directed at the project's preconstruction conference.

28.6.5 Requirements for Architectural or Building Structures

Submittals related to Architectural or Building Structures, such as Rest Areas, Picnic Pavilions, Offices and Warehouses, must be made according to the requirements of the Architectural Services Group, Production Support Office, Florida Department of Transportation, 605 Suwannee Street, MS 40, Tallahassee, FL 32399-0450, Phone (850) 414-4378.

28.6.6 Requirements for Roadway Submittal Items

Distribute all submittals related to roadway plans such as attenuators, non-standard drainage structures, etc. (except bridge items such as poles and bracket arms, or as noted below) in accordance with the ***Construction Project Administration Manual (Topic No. 700-000-000)*** for the component involved or as otherwise directed at the project's preconstruction conference. Submittals related to bridge items must be transmitted to the Department as previously described in this section.

28.6.7 Requirements for Overhead Sign Structures and Nonstandard Miscellaneous Structures

Transmit submittals concerning overhead sign structures and non-standard miscellaneous structures in accordance with the General Requirements above.

28.6.8 Miscellaneous Requirements and Assistance

For items not specified above or for which questions may arise as to submittal requirements, the Contractor should be advised to contact the appropriate FDOT Shop Drawing Review Office. For submittals of any type, the Contractor must always have transmitted a copy of the letter of transmittal to the Engineer (CEI).

28.7 Disposition of Submittals

The approval or disapproval of submittals by the Reviewer must be indicated by one of the following designations: "APPROVED" (no further action required), "APPROVED AS NOTED" (make corrections noted - no further submittal required), "RESUBMIT" (make corrections noted and resubmit for approval), or "NOT APPROVED" (rejected - do not resubmit the concept or component as submitted).

Modification for Non-Conventional Projects:

Delete the above paragraph and replace with the following:

The approval or disapproval of submittals by the Engineer of Record must be indicated by one of the following designations: "APPROVED" (no further action required), "APPROVED AS NOTED" (make corrections noted - no further submittal required), "RESUBMIT" (make corrections noted and resubmit for approval), or "NOT APPROVED" (rejected - do not resubmit the concept or component as submitted). Only shop drawings that have been "APPROVED", or "APPROVED AS NOTED" must be submitted to the Department for review.

The Department must stamp the drawings "RELEASE FOR CONSTRUCTION", "RELEASE FOR CONSTRUCTION AS NOTED", OR "RESUBMIT". Where possible, mark all necessary requirements on the shop drawing sheet and stamp "RELEASE FOR CONSTRUCTION AS NOTED" instead of requiring a resubmittal.

Indicate the disposition designation on each and every drawing sheet, or on the cover sheet of calculations, by the use of a red ink stamp. The stamp size must not exceed 3" high by 3" wide, but 1 ½" high by 3" wide stamp is preferred. Stamps must identify the approving groups, such as the Engineer of Record - Consultant, the Department's assigned commercial inspection agency and/or Department personnel, and the date. All notations or corrections made on the approval prints must be consistently marked on all drawings.

All Consultants reviewing submittals must red ink stamp and initial each item as noted above with the firm's appropriate stamp. Consultants must declare any limitations to the extent of their review and approval by the terminology of their standard stamp and/or by additional written and "ballooned" notes on the submittal items. When the Engineer of Record is a Consultant, and when a Sub-consultant is retained to assist in the submittal

review, the Engineer of Record must signify disposition of the submittal as noted above with the EOR's firm's appropriate stamp prior to distribution or prior to transmitting it by overnight delivery to the Department. In this event it is the Engineer of Record's prerogative to also require a disposition stamp by the Sub-consultant.

When a submittal contains deviations from the Contract Plans and Specifications, the Consultant and the Department must determine as to whether or not a Supplemental Agreement or Cost Savings Initiative Proposal (CSIP) is required. If either procedure is required to be initiated, the submittal will not be reviewed until a decision is finalized.

When the Engineer of Record receives a submittal that is not in accordance with the requirements of this chapter, the Contractor will be advised to resubmit immediately with the corrections or additions necessary.

Review and approval by the Engineer of Record (Consultant and/or Department) must be for conformance with the design concept of the project and for compliance with the information given in the Contract Plans and Specifications (including Supplemental and Special Provisions). The review and approval must not extend to means, methods, techniques, sequences or procedures of construction (except where a specific means, method, technique, sequence or procedure of construction is indicated in or required by the Contract Plans and Specifications) or programs incident thereto. The review and approval of a separate item as such will not indicate approval of the assembly in which the item functions.

Disposition of Shop Drawing submittals by the Engineer of Record for construction and erection equipment including beams and winches, launch gantry, erection trusses, forms, falsework, midspan and/or longitudinal closures, lifting devices, temporary bearing fixity devices, cranes, form travelers, segment carrying equipment and stability devices must be either "NOT APPROVED" if deemed to be unacceptable or, if acceptable, must be "APPROVED AS NOTED" with the following note included on the submittal drawings:

"Drawings are acceptable for coordination with, relationship to, and effects upon the permanent bridge; but have not been reviewed for self-adequacy. Adequacy and intended function remain the sole responsibility of the Contractor."

Unless otherwise specifically designated in a Consultant's Scope of Services or required by the Department, the Engineer of Record is not responsible for accepting or reviewing calculations or drawings pertaining to construction formwork. These documents should normally be submitted to the Engineer (CEI) or, in the event they are erroneously transmitted to the Engineer of Record, should be immediately rerouted to the Engineer (CEI).

On projects when the Engineer of Record is a Consultant to the Department and the Department will also be reviewing shop drawings the Department will perform a second, confirmation review of the submittal upon receipt of the Consultant's transmittal of reviewed drawings are stamped for disposition as noted above. The primary purposes of the Department's review include: conformance with FDOT policy, standards, etc.; uniformity of disposition with similar submittals; accuracy and completeness of the Consultant's review; and attention to specific details, areas of work, etc. that have experienced recurring problems during fabrication and/or construction.

When the Specialty Engineer is required by the Contract Plans and specifications to perform a portion of the design of the project, the Engineer of Record must confirm that:

1. The Specialty Engineer is qualified to design and prepare the submittal.
2. The specified number of submittals are furnished.
3. A minimum of one (1) set of Shop Drawings and the cover sheet of one (1) set of calculations are correctly sealed by the Specialty Engineer.
4. The Specialty Engineer understands the intent of the design and utilizes the correct specified criteria.
5. The configuration set forth in the submittal is consistent with that of the Contract Documents.
6. The Specialty Engineer's methods, assumptions and approach to the design are in keeping with accepted engineering practices.
7. The Specialty Engineer's design does not contain any gross inadequacies that would jeopardize or threaten public safety.

A detailed review of design calculations is not required, and a detailed review of dimensions (other than at interface areas with other work) is not required.

When a submittal has been returned as "RESUBMIT", the Contractor must make corrections as required and return the required number of corrected copies for review. All revisions to a drawing, etc., must be noted with a symbol consisting of the revision number within a triangle located next to revised area. The Contractor must direct specific attention in writing to revisions other than the corrections called for by the Department on previous submittals.

Exhibits 28-A thru **28-C** show the submittal and distributional flow of a shop drawing transmittal. When the Department concurs with the Consultant's review and disposition of the submittal, the Department will stamp and distribute the submittal including a record copy for the Consultant. Should the Department's review and/or disposition of the submittal differ from that of the Consultant, the final disposition of the submittal will be resolved in accordance with the following procedures:

Modification for Non-Conventional Projects:

Delete the above paragraph and replace with the following:

Exhibit 28-E shows the submittal and distributional flow of a shop drawing transmittal. When the Department concurs with the Design-Build Firm's Engineer of Record review and disposition of the submittal, the Department will stamp and distribute the submittal. Should the Department's review and/or disposition of the submittal differ from that of the Design-Build Firm's Engineer of Record, the final disposition of the submittal will be resolved in accordance with the following procedures:

28.7.1 Minor Modifications

The submittal will be processed when notations not involving design decisions are added, modified or deleted and when the disposition of the submittal remains unchanged or changed only in accordance with the following **Table 28.1**:

Table 28.1 FDOT Changes to Minor Modifications

From	To
Approved	Approved as Noted
Approved as Noted	Approved
Resubmit	Not Approved
Not Approved	Resubmit

In this event, the Department will notify the Consultant of the modifications, document the notification in the project's shop drawing file, process and distribute the submittal and furnish the Consultant with a record copy.

Modification for Non-Conventional Projects:

Delete **PPM 28.7.1** and replace with the following:

28.7.1 Minor Modifications

The submittal will be processed when notations not involving design decisions are added, modified or deleted and when the disposition of the submittal remains unchanged or changed only in accordance with the following **Table 28.1**:

Table 28.1 FDOT Changes to Minor Modifications

From	To
Approved	Released for Construction as Noted
Approved as Noted	Released for Construction

In this event, the Department will notify the Design-Build Firm of the modifications, document the notification in the project's shop drawing file, process and furnish the Design-Build Firm with a record copy.

28.7.2 Major Modifications

The submittal will be returned to the Consultant for re-review when notations involving significant design decisions must be added, deleted or modified, when the submittal's review is deemed by the Department to be incomplete or require significantly more work or when the disposition of the submittal requires one of the following **Table 28.2**:

Table 28.2 FDOT Changes to Major Modifications

From	To
Approved or Approved as Noted	Not Approved or Resubmit
Not Approved or Resubmit	Approved or Approved as Noted

As above, the Department will notify the Consultant and document the notification. The submittal will be returned to the Consultant for re-review and return to the Department.

Modification for Non-Conventional Projects:

Delete **PPM** 28.7.2 and replace with the following:

28.7.2 Major Modifications

The submittal will be returned to the Design-Build Firm for re-review when notations involving significant design decisions must be added, deleted or modified, when the submittal's review is deemed by the Department to be incomplete or require significantly more work or when the disposition of the submittal requires one of the following **Table 28.2**:

Table 28.2 FDOT Changes to Major Modifications

From	To
Approved or Approved as Noted	Resubmit

As above, the Department will notify the Design-Build Firm and document the notification. The submittal will be returned to the Design-Build Firm for re-review and return to the Department.

28.8 Segmental Bridges - Shop Drawing Checklist

See the **FDOT Specifications** and the **Structures Manual** for Shop Drawing Checklist information.

28.9 Distribution of Submittals

Exhibits 28-A thru **28-C** show the submittal and distributional flow of shop drawings for reviews performed by Consultant EORs without FDOT review, reviews performed by Consultant EOR with FDOT review, and reviews performed by FDOT only. In the case of reviews performed by Consultant EORs and FDOT, the Consultant must retain one (1) set of materials for his files and transmit the prints (or other sets of calculations or multiple sets of prints) to the FDOT Shop Drawing Review Office. Digitally signed and sealed Shop Drawings may be submitted electronically.

Distribution by overnight delivery is made in accordance with the following **Table 28.3**:

Table 28.3 Shop Drawing Distribution Schedule

DISTRIBUTION	FDOT - EOR	Reviews Performed by Consultant EOR with FDOT Review,	Consultant – EOR Without Department Review
FDOT Shop Drawing Review Office File	1 Set Original Prints + 1 Set Calcs	1 Set Original Prints + 1 Set Calcs	1 Set Prints + 1 Set Calcs
Engineer of Record	N/A	1 Set Prints + 1 Set Calcs	1 Set Original Prints + 1 Set Prints + 1 Set Calcs
Engineer (CEI)	2 Sets Prints	2 Sets Prints	2 Sets Prints
Contractor	3 Sets Prints + 1 Set Calcs	3 Sets Prints + 1 Set Calcs	3 Sets Prints + 1 Set Calcs

When precast/prestressed concrete components are involved, the Department's District Prestress Engineer is furnished two (2) sets and the State Materials Office (Gainesville) is furnished one (1) set of prints. When structural steel components are involved, the Department's Assigned Commercial Inspection Agency (ACIA) is furnished two (2) sets.

The Contractor is responsible for transmitting a copy of the returned submittal to the appropriate subcontractor or fabricator.

When approval of a submittal is denied ("RESUBMIT" or "NOT APPROVED"), distribution of the submittal must be made to the FDOT Shop Drawing Review Office's File, when the Department is reviewing shop drawings, and the Contractor only, with a copy of the transmittal letter to the Engineer (CEI).

Modification for Non-Conventional Projects:

Delete **PPM** 28.9 and replace with the following.

28.9 Distribution of Submittals

Exhibit 28-E shows the submittal and shop drawing flow diagram for design-build projects. The Contractor must retain at least one (1) set of materials for file retention and transmit the prints (or other sets of calculations or multiple sets of prints) to the FDOT Shop Drawing Review Office with a copy of the transmittal to the Engineer (CEI). Digitally signed and sealed Shop Drawings may be submitted electronically.

Distribution by overnight delivery is made in accordance with the following **Table 28.3**:

Table 28.3 Shop Drawing Distribution Schedule

DISTRIBUTION	Documents
FDOT Shop Drawing Review Office File	1 Set Original Prints + 1 Set Calcs
Engineer of Record	1 Set Original Prints + 1 Set Calcs
Engineer (CEI)	2 Sets Prints + 1 Set Calcs
Contractor	3 Sets Prints + 1 Set Calcs

When precast/prestressed concrete components are involved, the Department's District Prestress Engineer is furnished two (2) sets and the State Materials Office (Gainesville) is furnished one (1) set of prints. When structural steel components are involved, the Department's Assigned Commercial Inspection Agency (ACIA) is furnished two (2) sets. When mechanical/electrical components of movable bridges are involved, the Mechanical/Electrical Section of the State Structures Design Office (SSDO) is furnished one (1) set of prints and one (1) set of calculations.

The Contractor is responsible for transmitting a copy of the returned submittal to the appropriate subcontractor, specialty engineer, ENGINEER OF RECORD or fabricator.

28.10 Review of Prequalified Joint Welding Procedures

In accordance with **Section 11.2** of the *Materials Manual*, the approval of all joint welding procedures specification (WPS) will be the responsibility of the Department's Verification Inspection Consultant, which is the Department's Assigned Commercial Inspection Agency (ACIA). The State Materials Office maintains the list of the approved WPS which may be used on all future projects by the fabricator who developed them, until their expiration. A list of the welding procedures to be used on any individual project will be forwarded to the Engineer of Record (EOR) prior to the start of fabrication. The EOR may elect to review these documents, but it is the responsibility of the Verification Inspection Consultant to assure the proper welding procedure is used at the correct location. Shop drawings depicting plate sizes, types of welds, weld designations, weld sizes, grades of materials, etc. will continue to be reviewed by the EOR.

The fabricators of the following products are only required to include their approved Welding Procedure Specification as part of their quality control plan:

1. Overhead cantilevered sign supports with cantilevered arms less than or equal to 41 feet,
2. Overhead span sign supports,
3. Aluminum light poles,
4. High mast light poles,
5. Expansion joints,
6. Open grid decking,
7. Bearings,
8. Monotube Assemblies,
9. Mast arm assemblies,
10. Drainage items,
11. Stay-in-place forms,
12. Casing pipes,
13. Steel strain poles,
14. Pedestrian/Bicycle Railings
15. Any other items that are not designated as items requiring commercial inspections.

28.11 Submittal Activity Record (Logbook)

The Final Review Office is responsible for maintaining a Submittal Activity Record (Logbook) on each project reviewed by the office. Update the logbook each day that any Shop Drawing submittal activity occurs.

Enter the following minimum data in the logbook for each submittal:

Financial Project ID and State Project Number (if assigned).

Submittal Number.

Description of Submittal.

Number of Sheets in the Submittal.

Number of Pages of Calculations, in Reports, in Manuals, etc.

Date Transmitted by Contractor to the Engineer of Record.

Date Transmitted by Engineer of Record (when EOR is not the final reviewer) to the Final Review Office.

Date Distributed by the Final Review Office to the Contractor.

Disposition as either "A" (Approved), "AN" (Approved as Noted), "R" (Resubmit) or "NA" (Not Approved).

The Logbook is an historical record of the activity devoted to an individual submittal as well as that for the project as a whole. It can serve as a verification of review time, to respond to inquiries of a particular submittal's status and as a record of manpower effort to aid in estimating and allocating future workload.

28.12 Archiving Record Shop Drawings

Upon completion and acceptance of a construction project by the Department (usually by receipt of a written Notice of Acceptance), the Final Review Office, within thirty (30) days, will transmit the Record Shop Drawings to the appropriate offices, as dictated by district practice in the District in which the project is located. The Record Shop Drawings may include some or all of the following documents:

1. Shop Drawings
2. Erection Drawings
3. Calculations
4. Manuals
5. Project Files of Shop Drawing transmittal letters, etc.
6. Submittal Activity Record (Logbook printout)

The Final Review Office must complete the Record Shop Drawing Transmittal (see **Exhibit 28-D**), in triplicate, retaining one (1) copy and transmitting two (2) copies, along with the Record Shop Drawings described above, to the appropriate office. The Record Shop Drawing Transmittal describes all the Record Shop Drawing documents being transmitted.

The Submittal Activity Record (logbook) is intended to serve as the listing of all Shop and Erection Drawings transmitted. Other transmitted material such as project files, samples, etc. should be listed individually on the Transmittal shown in **Exhibit 28-D**.

Upon receipt of the Record Shop Drawings, the offices receiving the transmittal will verify the documents, material, etc. transmitted, sign and date both copies of the Record Shop Drawing Transmittal, retain one (1) copy for his files and return the second signed copy to the Final Review Office.

The Final Review Office will maintain a file of Record Shop Drawing Transmittals (**Exhibit 28-D**) for future reference and use. Once the signed copy of the Record Shop Drawing Transmittal is received, the Final Review Office's initially retained Record Shop Drawing Transmittal may be discarded.

It should be noted that for Shop Drawing submittals requiring a Specialty Engineer, the Record Shop Drawing submittal normally will consist of sealed prints.

Exhibit 28-A Shop Drawing Flow Diagram for Reviews with Consultant EORs without FDOT Review

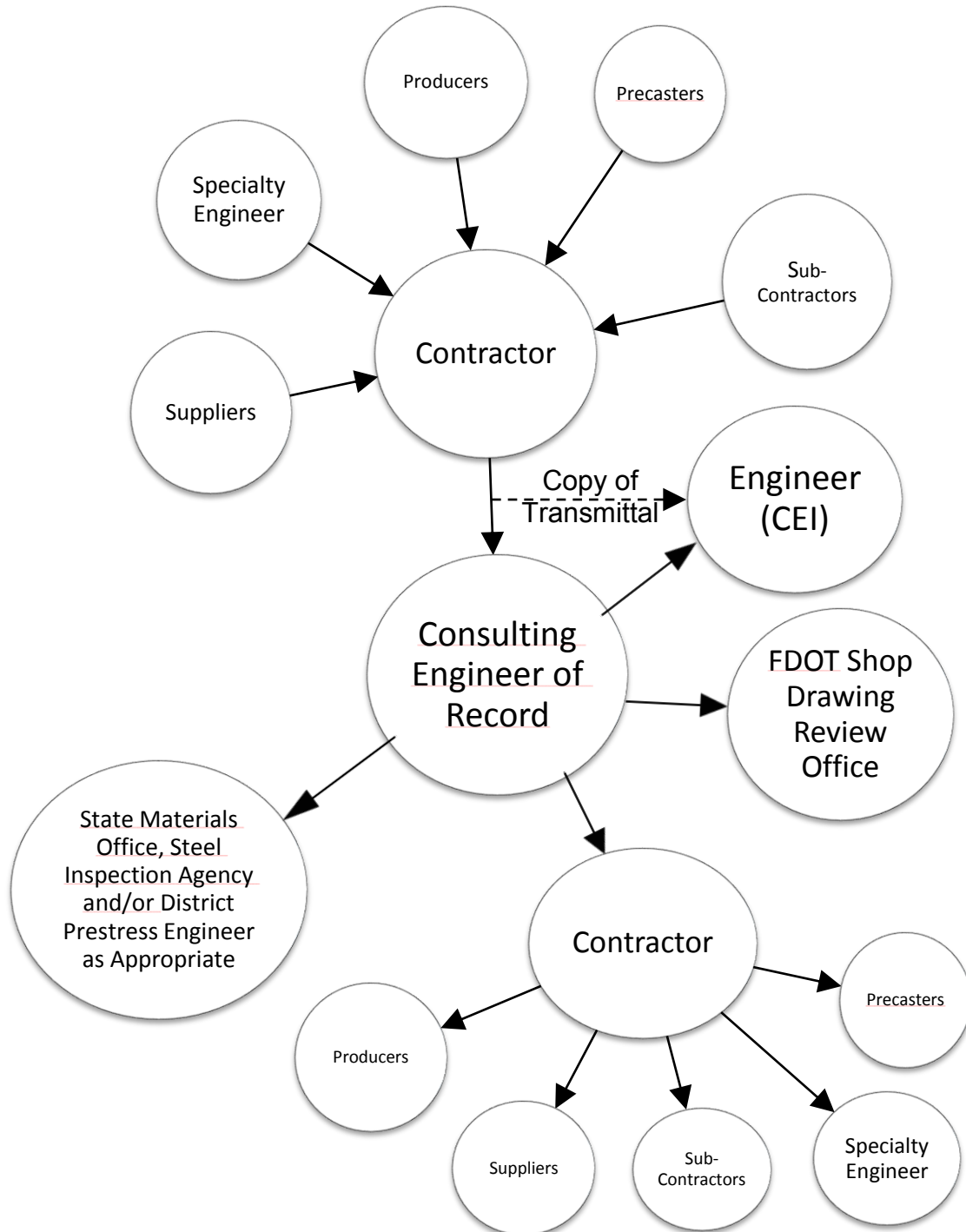

Exhibit 28-B Shop Drawing Flow Diagram for Performed by Consultant EOR with FDOT Review

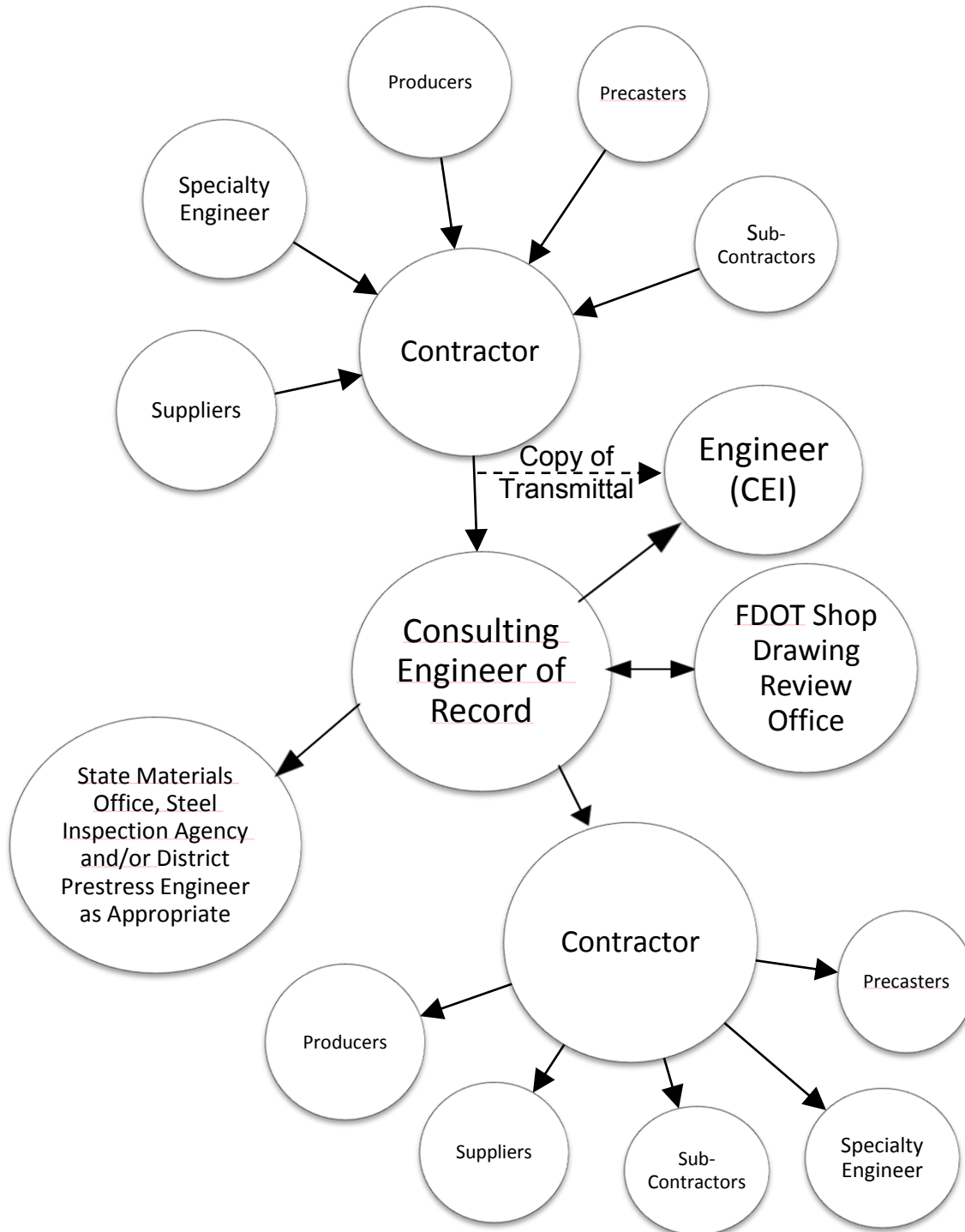

Exhibit 28-C Shop Drawing Flow Diagram for Reviews Performed by FDOT Only

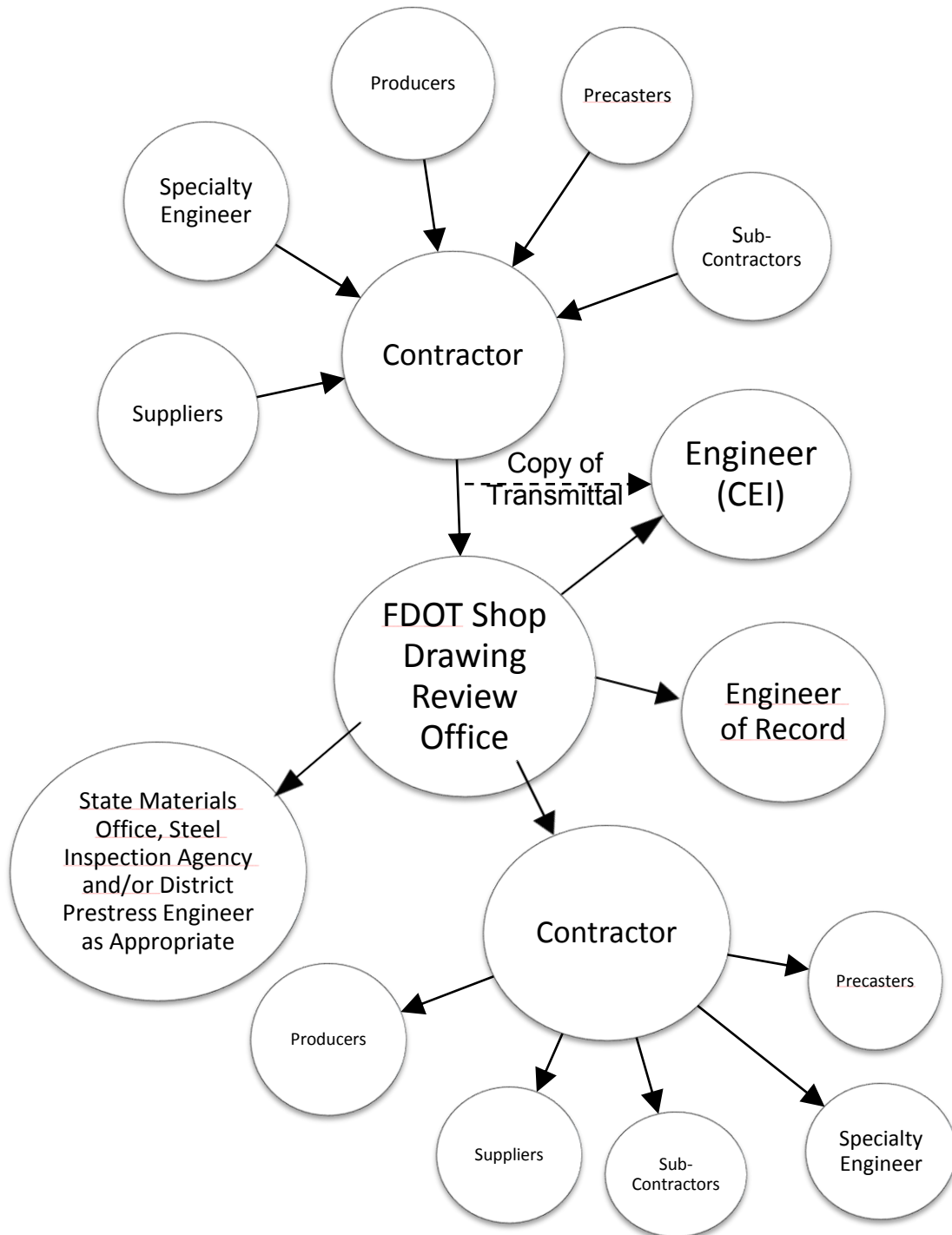

Exhibit 28-D Record Shop Drawing Transmittal

(Letterhead of Final Review Office)

RECORD SHOP DRAWING TRANSMITTAL

Date _____

TO: (Destination Office)

FROM: _____

(Final Review Office)

PROJECT NAME _____

FINANCIAL PROJECT ID _____

FEDERAL AID PROJECT NO. _____

CONTRACT ID NUMBER _____

COUNTY (SECTION) _____

STATE ROAD NUMBER _____

BRIDGE NUMBER _____

CONTRACTOR _____

ENGINEER OF RECORD _____

We are transmitting herewith the following Record Shop Drawings for archiving:

1. Shop and Erection Drawing Submittals per attached Logbook.
2. Submittal Activities Record (Logbook)
3. _____
4. _____
5. _____
6. _____

For the Final Review Office: _____
(Signature) (Date)

For the Receiving Office: _____
(Signature) (Date)

Exhibit 28-E Shop Drawing Flow Diagram for Design-Build Projects

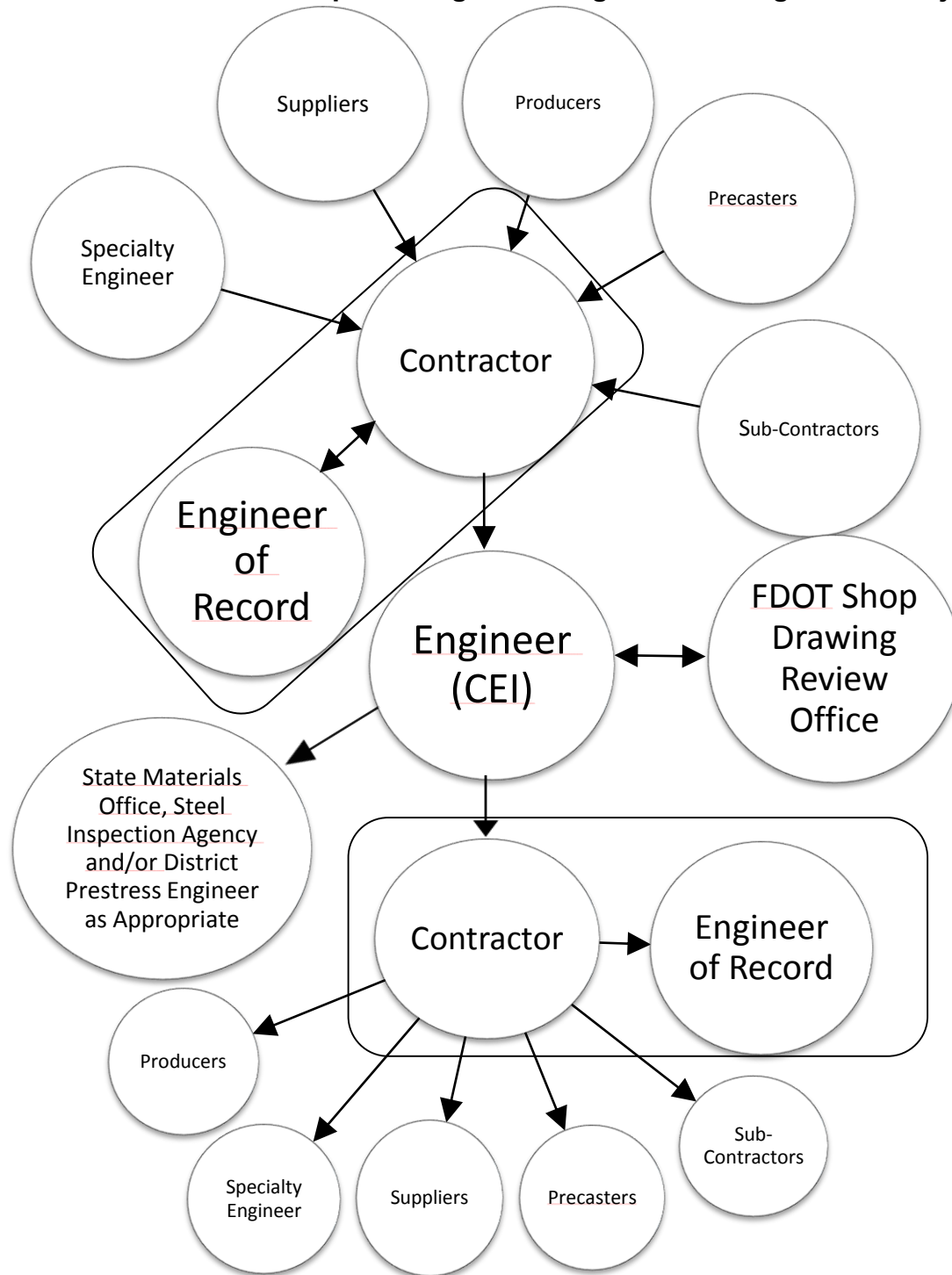

Chapter 29

Structural Supports for Signs, Luminaires, and Traffic Signals

29.1	General	29-1
29.2	Sign Support Structures	29-2
29.3	Lighting Support Structures	29-3
29.4	Traffic Signal Support Structures.....	29-3
29.5	ITS Support Structures.....	29-4
29.6	Foundations	29-4

THIS PAGE LEFT BLANK INTENTIONALLY

Chapter 29

Structural Supports for Signs, Luminaires, and Traffic Signals

29.1 General

Design sign, signal, lighting, and ITS support structures in accordance with the **AASHTO LRFD Specifications for Structural Supports for Highway Signs, Luminaires, and Traffic Signals**, as modified by the **FDOT Structures Manual, Volume 3**. Include structural details in the Plans for all sign, signal and lighting structures. Use the [Design Standards](#) for sign, signal and lighting support structures unless site conditions or other considerations require a custom design.

When a custom support structure is to be included in the plans, the EOR is responsible for the structural design, the foundation design, and the review of Shop Drawings. Details for supports attached to bridge structures must be coordinated with the bridge structural engineer and included in the plans. See **Structures Design Guidelines**, Section 1.9 for details and restrictions related to making attachments to bridges.

The following sign and signal structure limits apply:

1. [Design Standards, Index 11320](#), Span Sign Structure span length: 220 feet
2. **Index 11310**, Cantilever Sign Structure span length: 50 feet
3. **Indexes 11310 and 11320**, Cantilever and Span Sign Structure Truss Depth: 9.5 feet
4. **Indexes 17743 and 17745**, Standard Mast Arm Assemblies span length: 78 feet
5. **Index 17723** or **Index 17725**, Steel or Concrete Strain Pole with Signal Cable span length: 250 feet

These limits are based on past practice, inspection requirements, and practical experience. See the **Instructions** for the applicable [Design Standards](#) for additional information on sign and signal structures.

29.2 Sign Support Structures

Use the applicable [Design Standards](#) for the following sign support structures:

- **Index 11860** Single Column Ground Signs,
- **Index 11861** Single Column Cantilevered Ground Mounted Signs,
- **Index 11870** Single Post Bridge Mounted Sign Supports,
- **Index 11871** Single Post Median Barrier Mounted Sign Supports,
- **Index 11200** Multi-column Ground Signs,
- **Index 11310** Cantilever Overhead Sign Structures,
- **Index 11320** Span Overhead Sign Structures

Refer to the corresponding **FDOT Instructions for Design Standards (IDS)** for design information.

Where the distance between the curb and the sidewalk restricts the use of [Design Standards](#), **Indexes 11200** and **11861** may be used.

The EOR is responsible for the following:

- Design of multi-column ground signs and overhead sign structures (including bridge mounted signs),
- Design of the supports and foundations, as well as all details necessary to fabricate and erect the sign structures.
- Review of shop drawings in accordance with **Chapter 28**.

FDOT assigns identification numbers to overhead sign structures. See the **Structures Detailing Manual, Chapter 2**, for instructions.

If a custom sign support structure is required, include a brief written justification with the 30% plans submittal.

Modification for Non-Conventional Projects:

Delete the sentence above and replace with the following:

If a custom design is required, include a brief written justification with the 90% component plans submittal.

29.3 Lighting Support Structures

Use the applicable [Design Standards](#) for the following lighting support structures:

- **Index 17502** High Mast Light Poles,
- **Index 17515** Conventional Aluminum Light Poles.

Refer to the corresponding FDOT **IDS** for design information.

29.4 Traffic Signal Support Structures

Use the applicable [Design Standards](#) for the following traffic signal support structures:

- **Index 17723** Steel Strain Poles,
- **Index 17725** Concrete Strain Poles,
- **Index 17743** Standard Mast Arm Assemblies,
- **Index 17745** Mast Arm Assemblies.

Refer to the corresponding FDOT **IDS** for design information.

See **Chapter 7** of this Volume for determining which locations require mast arms.

Design all structures assuming traffic signal assemblies have backplates in accordance with **Section 7.4**

Span wire systems have two strain pole options, rectangular prestressed concrete and round steel. Round steel poles are typically used on longer spans where prestressed concrete poles have exceeded their capacity.

For attaching Free-Swinging, Internally-Illuminated Street Sign Assemblies, see [Design Standards](#), **Index 17748**.

See [Design Standards](#), **Indexes 17743** and **17745**, and their **Instructions (IDS)**.

29.5 ITS Support Structures

Use the applicable [Design Standards](#) for the following ITS support structures:

- **Index 18111** Steel CCTV Poles,
- **Index 18113** Concrete CCTV Poles,
- **Indexes 11310** and **11320** Cantilever and Span Sign Supports to support Dynamic Message Signs (DMS). For additional DMS details, see [Design Standards](#), **Index 18300** Dynamic Message Sign Walk-In.

Refer to the corresponding FDOT **IDS** for design information.

Refer to the **Structures Manual, Volume 3** for Dynamic Message Sign Structure design requirements.

29.6 Foundations

Unique site circumstances may require the foundation variables to be modified from the foundations shown in the [Design Standards](#). If custom designs are required, the Geotechnical Engineer must provide the soil information to be used by the Structures Design Engineer during the design phase of the project.

The foundation design and drawings where special foundations are required are the responsibility of the Structures Engineer of Record (EOR). The Geotechnical Engineer must provide the EOR the following soils information (this information may be derived from the borings of other nearby structures or from roadway borings):

1. Soil Type
2. Effective Unit Weight of the Soil
3. Seasonal High Water Table Elevation
4. Effective Friction Angle of the Soil (if applicable)
5. Cohesion Value (if applicable)
6. Coefficient of Horizontal Subgrade Reaction
7. Factored Bearing Resistance (if applicable)

Include the above soils information in the plans. Additionally, Soil Boring Data Sheets must be included in the plans, except for strain poles. This will provide the Contractor with the conditions for which the foundations were designed as compared to actual on-site conditions and establish criteria for any future analysis of the foundations.

Chapter 30

Retaining Walls

30.1	Purpose.....	30-1
30.2	General	30-1
30.3	Retaining Wall Plans Submittal Procedures	30-2
30.3.1	Non-Proprietary Retaining Walls	30-3
30.3.2	Proprietary Wall Systems Where Full Design Details Are Not Required In Contract Plans.....	30-4
30.3.3	Proprietary Wall Systems Where Full Design Details Are Required In Contract Plans	30-5
30.3.4	Critical Temporary Walls	30-6

THIS PAGE LEFT BLANK INTENTIONALLY

Chapter 30

Retaining Walls

30.1 Purpose

This chapter describes the procedure to be used in the development of retaining wall plans. This chapter should be used in conjunction with the [Structures Design Guidelines \(SDG\)](#), [Structures Detailing Manual \(SDM\)](#) and the applicable [Instructions for Design Standards \(IDS\)](#).

30.2 General

See [Chapter 4](#) of this Volume for guidance on roadside barrier requirements and [SDG, Chapter 6](#) for retaining wall mounted traffic railing requirements. See [Chapter 8](#) of this Volume for pedestrian and bicycle rail requirements. See [SDG, Section 1.4.5](#) for the policy on retaining wall surface finishes.

Precast walls other than Mechanically Stabilized Earth (MSE) walls should be considered as an alternate when sufficient room for soil reinforcement is not available.

[Design Standards, Index 6000 Series](#) contains general notes and common details for retaining walls. See the applicable [IDS](#) for information on the use of these standards.

Using the site-specific geotechnical information, the structures Engineer of Record (EOR), in cooperation with the Geotechnical Engineer, will determine the appropriate wall type and its requirements. See the [SDG, Section 3.12](#) for the Permanent Retaining Wall Selection Process.

The following sections refer to the structures plans submittal procedure. For projects where there are no bridges, the roadway EOR must adjust the procedure as required for the roadway project.

30.3 Retaining Wall Plans Submittal Procedures

On projects with retaining wall types not listed on the APL (C-I-P wall systems, permanent concrete and steel sheet pile walls, soldier pile walls, non-proprietary precast wall systems, complex wall systems, or project specific designs), the complete wall design and details are included in the plans by the EOR.

On projects with proprietary retaining wall systems listed on the APL, the EOR provides the Wall Control Drawings and the appropriate wall systems Data Tables in the plans. The EOR selects which FDOT Wall Type (see the **SDG, Section 3.12**) is appropriate for the project and places this information in the notes associated with the Data Tables. The Contractor then selects the APL listed retaining wall system to build based on the allowable wall types shown in the notes associated with the Data Tables and on the **Design Standards**. Proprietary retaining walls require shop drawings in accordance with **Chapter 28**.

Proprietary retaining wall design plans are not required in the contract plans for normal uncomplicated wall projects (see **Section 30.3.2**). If the proprietary walls are Two-phased, experimental, exceed 40 ft. in height, are subject to unusual geometric or topographic features, if spatial limitations require project specific details, or, by the geotechnical report, will be subjected to excessive settlement, or environmental conditions, they are required to have fully detailed design plans in the contract set (see **Section 30.3.3**).

Prior to construction on projects utilizing proprietary wall systems, the contractor will submit, for approval by the engineer, shop drawings that are based on an APL listed wall system that is shown in the plans. Site-specific details for the wall construction will be included in these shop drawings.

The success of these methods for producing wall plans is highly dependent on complete, accurate and informative Control Plans. The importance of the Geotechnical Engineer's role in this scheme cannot be emphasized enough and is detailed in the **FDOT Soils and Foundation Handbook, Chapters 3, 8 and 9**.

The Geotechnical Engineer's wall type recommendation must be presented in a report together with the results of field and laboratory testing and the reasoning for the recommendation. For Proprietary Walls, also include the following: external stability analyses, minimum soil reinforcement length vs. wall height for external stability,

recommended soil reinforcement type limitations if any (e.g. synthetic vs. steel), maximum bearing pressure for each wall height and soil reinforcement length for each different wall height (2 ft. increments).

The normal failure modes to be investigated are shown in **SDG, Chapter 3**.

Procedures for developing retaining wall plans follow.

30.3.1 Non-Proprietary Retaining Walls

1. Bridge Development Report (BDR) / 30% Plans

The BDR must discuss and justify the use/non-use of non-proprietary retaining walls. If the use of these retaining walls is applicable to the site and economically justified, it may be the only design required or it may be an alternate to a proprietary design. Include Wall Control Drawings (as specified in the **SDM, Chapter 19**), cross sections, details and general notes in the 30% Plans submittal. Denote the location of drainage inlets, utilities, sign structures, lights and barrier joints in the plans. See the **SDM, Chapter 19** for more information.

2. 30% Plans:

The 30% Plans must be submitted for approval and development of the plans continued towards the 90% Plans submittal.

3. 90% Plans:

The 90% Plans submittal must be further developed to include, in addition to the information required for the 30% Plans, information listed in the **SDM, Chapter 19**.

Modification for Non-Conventional Projects:

Delete **PPM** 30.3.1 and replace with the following:

30.3.1 Non-Proprietary Retaining Walls

See **SDG, Section 3.12** for wall selection requirements. Include Wall Control Drawings (as specified in the **SDM, Chapter 19**), cross sections, complete wall details and general notes in the Component Plans submittal. Denote the location of drainage inlets, utilities, sign structures, lights and barrier joints in the plans. See the **SDM, Chapter 19** for more information.

30.3.2 Proprietary Wall Systems Where Full Design Details Are Not Required In Contract Plans

Preapproved Vendor Drawings for proprietary wall systems are listed on the APL and are categorized in accordance with the applicable FDOT Wall Type(s). Utilize these drawings with the applicable standard(s) and Data Tables. Do not include the Vendor Drawings in the plans.

Use the following procedure in preparing plans for wall projects.

1. BDR/30% Plans

Discuss and justify the use of proprietary retaining walls and FDOT Wall Types (see **SDG, Section 3.12**) in the BDR. Provide documentation of all the site-specific geotechnical information and wall system considerations in the Retaining Wall Justification portion of the BDR. Include the Retaining Wall System Data Tables and Preliminary Wall Control Drawings with the information shown in **SDM, Chapter 19** for the Plan and Elevation Sheets.

2. 90% Plans

Include the completed Control Plans and Data Tables in the 90% Plans submittal.

Modification for Non-Conventional Projects:

Delete **PPM** 30.3.2 and replace with the following:

30.3.2 Proprietary Wall Systems Where Full Design Details Are Not Required In Contract Plans

Preapproved Vendor Drawings for proprietary wall systems are listed on the APL and are categorized in accordance with the applicable FDOT Wall Type(s). Utilize these drawings with the applicable standard(s) and Data Tables. Do not include the Vendor Drawings in the plans.

Using site-specific geotechnical information, the EOR, in cooperation with the geotechnical engineer, will determine all wall system requirements. See **SDG, Section 3.12** to determine appropriate FDOT Wall Type. Include Wall Control Drawings and Data Tables in the Component Plans submittal, as specified in the **SDM, Chapter 19**. Denote the location of drainage inlets, utilities, sign structures, lights and barrier joints in the plans. See the **SDM, Chapter 19** for more information.

30.3.3 Proprietary Wall Systems Where Full Design Details Are Required In Contract Plans

The following procedure for plans preparation should be followed if the walls are required to be fully detailed in the contract plans.

1. BDR/30% Plans

The BDR must discuss and justify the use of proprietary retaining walls. Include Wall Control Drawings in the 30% Plans. It will not be necessary for these Plans to contain pay items; however, they must include, but not be limited to, the information listed in the ***SDM, Chapter 19***.

2. Control Plans/Invitation Package

The Control Plans must be reviewed by the Department and, upon approval, sent to all the appropriate wall companies. Provide a set of control plans, roadway plans and foundation report to the wall companies no later than by the 60% Plans submittal. A copy of the transmittals to the wall companies must be sent to the DSDO or SDO as appropriate. The proprietary companies must acknowledge receipt of the invitation package. If they choose to participate they must provide design plans for the retaining walls and submit the plans for review as prescribed in the invitation letter.

3. 90% Plans

Upon receipt of the proprietary design plans, the designer must review the design and incorporate the wall plans into the contract set. The plans from the wall companies, control plans and wall company standard drawings must constitute the 90% Plans.

Modification for Non-Conventional Projects:

Delete ***PPM*** 30.3.3 and replace with the following:

30.3.3 Proprietary Wall Systems Where Full Design Details Are Required In Contract Plans

Using site-specific geotechnical information, the EOR, in cooperation with the geotechnical engineer, will determine wall system requirements. See ***SDG, Section 3.12*** to determine appropriate FDOT Wall Type. The Design-Build EOR must coordinate with one of the Preapproved Vendors to prepare fully detailed

project specific proprietary drawings for inclusion into the Component Plans. Include Wall Control Drawings and Data Tables (in accordance with **SDM, Chapter 19**) in the Component Plans submittal. Denote the location of drainage inlets, utilities, sign structures, lights and barrier joints in the plans. See the **SDM, Chapter 19** for more information.

30.3.4 Critical Temporary Walls

A critical temporary wall is a temporary wall that is necessary to maintain the safety of the traveling public, or structural integrity of nearby structures or utilities during construction. Traffic lanes located either above or below a grade separation and within the limits shown in **SDM** Chapter 19, will require the design of a critical temporary wall.

On bridge projects, discuss the use of, and selected type of, critical temporary walls in the BDR.

Modification for Non-Conventional Projects:

Delete the above sentence.

Typically, critical temporary walls are either proprietary MSE walls or steel sheet pile walls. Concrete sheet piles, soldier pile walls and precast or cast-in-place concrete walls may also be used as critical temporary walls.

Critical temporary proprietary MSE walls must comply with **Design Standards, Index 6030** (and the applicable **IDS**) and require generic design details in the contract plans. The plans format must be in accordance with **Sections 30.3.2** and **30.3.3**. Include control drawings and the completed Temporary Retaining Wall System Data Tables. Submit the final design details in the shop drawings.

If critical temporary steel sheet pile walls are used, complete the associated Data Table and include it in the plans. See the **Structures Detailing Manual** for more information including critical temporary wall definitions.

If other types of critical temporary walls are used, prepare the necessary details and include them in the plans.

Chapter 31

Geosynthetic Design

31.1	General	31-1
31.2	Contract Plans Content	31-1
31.3	Shop Drawings / Redesigns	31-2
31.4	Geosynthetic Reinforcement Design Methodology	31-3
31.4.1	Design Considerations	31-3
31.4.2	Requirements	31-4
31.4.3	Design Guidelines	31-5
Exhibits		
Exhibit 31-A	Geosynthetic Reinforced Soil Slopes	31-7
Exhibit 31-B	Geosynthetic Reinforced Foundations Over Soft Soils	31-8

THIS PAGE LEFT BLANK INTENTIONALLY

Chapter 31

Geosynthetic Design

31.1 General

The purpose of this chapter is to give the designer an understanding of the requirements for geosynthetic reinforced soil slopes and geosynthetic reinforced foundations over soft soils.

Reinforced soil slopes should be utilized only when unreinforced slopes are not appropriate and retaining walls are not economical or are undesirable. **Chapter 4, Roadside Safety** of this volume contains design criteria for the use of roadside slopes.

Reinforced foundations over soft soils should be utilized when the existing soils are too weak to support the anticipated loading, and when excavation, replacement, or other ground modification method is not an economical solution.

The Engineer of Record should request guidance on alternate foundation designs from the District Geotechnical Engineer where organic material or other soft soil deposit removal is impractical.

Modification for Non-Conventional Projects:

Delete the above paragraph and see RFP for requirements.
--

Refer to the [Soils and Foundations Handbook](#) for additional information.

Approved products for these designs are included in the Approved Products List ([APL](#)).

31.2 Contract Plans Content

Provide the geosynthetic application type and any specific requirements to ensure the geosynthetic selected from the [APL](#) will be suitable. (Refer to **Specification 985** to

determine which test values will be available for selecting the products for each application from the [APL](#).)

Control drawings are required which depict the geometrics (plan and elevation view) of the area being reinforced. These designs are generic and are not based upon any one specific product or supplier; the product brand names are not shown on the plans. Design reinforced slopes using the maximum reinforcement spacing allowed. For soft soils, design the reinforcement and provide the minimum total strength required.

The plans must depict the required reinforcement strength based on the maximum allowed vertical spacing of these materials, the extent and the number of layers of geosynthetic reinforcement, vertical spacing of geosynthetic reinforcement, orientation of geosynthetic, facing details, details at special structures or obstructions, typical construction sequence, and top and bottom elevations of the geosynthetic reinforcement layers. Surface treatments and any other required design parameters or limitations must also be shown in the plans.

31.3 Shop Drawings / Redesigns

The contractor can choose to construct the reinforced soil structures either by: (1) using geosynthetic materials approved for the intended application in the [APL](#) meeting or exceeding the strength required in the plans and placed at or less than the spacing(s) shown on the Plans, or (2) submitting an alternate design which optimizes the use of a specific material and revises the material spacing within the limits contained in the design methodology in **Section 31.4**. Backfill specific soil properties are seldom available at the design phase of a project. Therefore, the contractor must identify and determine the properties of the fill material in accordance with FM 1 T-236 prior to submitting an alternate design. Using backfill specific material properties allows for optimization of the design resulting in a corresponding cost benefit to the Department. All designs must meet the design methodology requirements contained in **Section 31.4**.

Modification for Non-Conventional Projects:

Delete the first sentence of the above paragraph and replace with the following:

Construct the reinforced soil structures using geosynthetic materials approved for the intended application in the [APL](#) meeting or exceeding the strength required in the plans and placed at or less than the spacing(s) shown on the Plans.

The shop drawing reviewer must be familiar with the requirements, design and detailing of these systems. The review must consist of but not limited to the following items:

1. Verify horizontal and vertical geometry with the contract plans.
2. The soil reinforcement must be approved for the intended application in the [APL](#).
3. The soil reinforcement design values do not exceed the values in the [APL](#).
4. Verify that the material strengths and number of layers of the product selected meets or exceeds the design shown in the contract plans.
5. Soil properties for the fill material chosen by the contractor must meet or exceed those used in the design shown in the Contract Plans.
6. If a redesign is proposed, verify the design meets the requirements of **Section 31.4** and the Contract Plans, and the soil properties for the fill material chosen by the contractor meets or exceeds those used in the redesign.

See **Specification Section 145** for requirements associated with Contractor initiated redesigns.

31.4 Geosynthetic Reinforcement Design Methodology

This design methodology applies only for geosynthetic reinforced soil slopes and geosynthetic reinforced foundations over soft soils. Geosynthetic is a generic term for all synthetic materials used in Geotechnical engineering applications and includes geotextiles and geogrids.

31.4.1 Design Considerations

Only those geosynthetic products approved for usage on reinforced soil slopes in the [APL](#) are eligible for use on FDOT projects. Design the geosynthetic reinforced systems using comprehensive stability analyses methods that address both internal and external stability considerations by a professional engineer licensed in Florida who specialized in Geotechnical engineering. The following design guidelines and requirements should be used for the analyses and design.

31.4.2 Requirements

1. **Performance:** The design resistance factors must cover all uncertainties in the assumptions for the design limit state. The resistance factors must not exceed the following:
 - a. 0.65 against pullout failure.
 - b. 0.65 against sliding of the reinforced mass.
 - c. 0.75 against external, deep-seated failure.
 - d. 0.65 against external, deep-seated failure when supporting a structure.
 - e. 0.75 against compound failure, i.e., failure through the reinforcement.
 - f. 0.75 against internal failure.
 - g. 0.75 against local bearing failure (lateral squeeze).
2. **Nominal Tension Resistance of Reinforcement :** The maximum long term reinforcement tensile resistance of the geosynthetic must be:

$$T_a = \frac{T_{ult}}{RF_c RF_d CRF}$$

Where:

T_a = The nominal long term reinforcement tensile resistance.

T_{ult} = The ultimate strength of a geosynthetic in accordance with **ASTM D 6637** for the reinforcement oriented normal to the slope.

RF_c = Reduction factor for installation damage during construction for the appropriate fill material (sand or limerock).

RF_d = Reduction factor for durability (due to Chemical or Biological degradation).

CRF = Creep reduction factor. (T_{ult}/T_{creep})

T_{creep} = Serviceability state reinforcement tensile load based on minimum 10,000 hour creep tests.

These reinforcement specific parameters can be found in the [APL](#).

For applications involving reinforcing slopes with geosynthetic, the design life is not less than 75 years.

3. **Soil Reinforcement Interaction:** Friction reduction factors are presented as Soil-Geosynthetic Friction values in the [APL](#) for each approved geosynthetic product.

31.4.3 Design Guidelines

These design guidelines are excerpted from the FHWA Publications (a) **FHWA GEC 011 (FHWA-NHI-10-024 & FHWA-NHI-10-025), "Design and Construction of Mechanically Stabilized Earth Walls and Reinforced Soil Slopes-Volumes 1 & 2"**, and (b) **No. FHWA HI-95-038, "Geosynthetic Design and Construction Guidelines"**. Designers should refer to these publications for details.

1. **Reinforced Slope** - see reference (a) **FHWA GEC 011**.
 - Step 1. Establish the geometry and loading - see **Exhibit 31-A**.
 - Step 2. Determine the engineering properties of the in situ soils.
 - Step 3. Determine the properties of the reinforced fill and the retained fill.
Use the following default values for fill soil within the reinforced volume when the fill material source is not known:
For sand fill: $\phi = 30^\circ$, $\gamma = 105$ pcf, $c = 0$;
For crushed limerock fill: $\phi = 34^\circ$, $\gamma = 115$ pcf, $c = 0$.
 - Step 4. Evaluate design parameters for the reinforcement.
 - Step 5. Check unreinforced slope stability.
 - Step 6. Design reinforcement to provide a stable slope.
 - Step 7. Check external stability and service limit state deformations.
 - Step 8. Evaluate requirements for subsurface and surface water runoff control.
2. **Reinforced Foundation over Soft Soils** - see reference (b) **FHWA HI-95-038**.
 - Step 1. Define embankment dimensions and loading conditions - see **Exhibit 31-B**.
 - Step 2. Establish the soil profile and determine the engineering properties of the foundation soil.
 - Step 3. Obtain engineering properties of embankment fill materials.
 - Step 4. Establish appropriate resistance factors and operational settlement criteria for the embankment.

The resistance factors must not exceed the following:

- a. 0.65 against bearing failure of subsoil
- b. 0.65 against pullout failure in select soil
- c. 0.50 against pullout failure in plastic soil
- d. 0.65 against lateral spreading (sliding) of the embankment
- e. 0.75 against external, deep-seated failure at the end of construction
- f. 0.65 against external, deep-seated failure at the end of construction, when supporting a structure.
- g. 0.65 against tensile failure of the reinforcement

Settlement criteria: depends upon project requirements

Step 5. Check bearing capacity, global stability (both short and long term), and lateral spreading stability.

Step 6. The geosynthetic reinforcement should be designed for strain compatibility with the weak in situ soil.

Based on the type of weak in-situ soil, the maximum design strain in the geosynthetic ($\epsilon_{\text{geosynthetic}}$) is as follows:

Cohesionless soil:	$\epsilon_{\text{geosynthetic}} = 5\%^*$
Cohesive soils:	$\epsilon_{\text{geosynthetic}} = 5\%^*$
Peat:	$\epsilon_{\text{geosynthetic}} = 10\%^*$

* For all cases, limit $\epsilon_{\text{geosynthetic}}$ to the strain at failure minus 2.5%

Step 7. Establish geosynthetic strength requirements in the geosynthetic's longitudinal direction.

Step 8. Establish geosynthetic properties.

Step 9. Estimate magnitude and rate of embankment settlement.

Step 10. Establish construction sequence and procedures.

Include all stages of construction. Base the analysis of each stage on the estimated strength of the subsoils at the end of the previous construction stage.

Step 11. Establish construction observation requirements.

Use instrumentation such as settlement plates, piezometers, and/or inclinometers to monitor the performance of the construction. Establish the monitoring criteria, such as the maximum rate of piezometric and/or settlement change that must occur before the next stage of construction can proceed.

Exhibit 31-A Geosynthetic Reinforced Soil Slopes

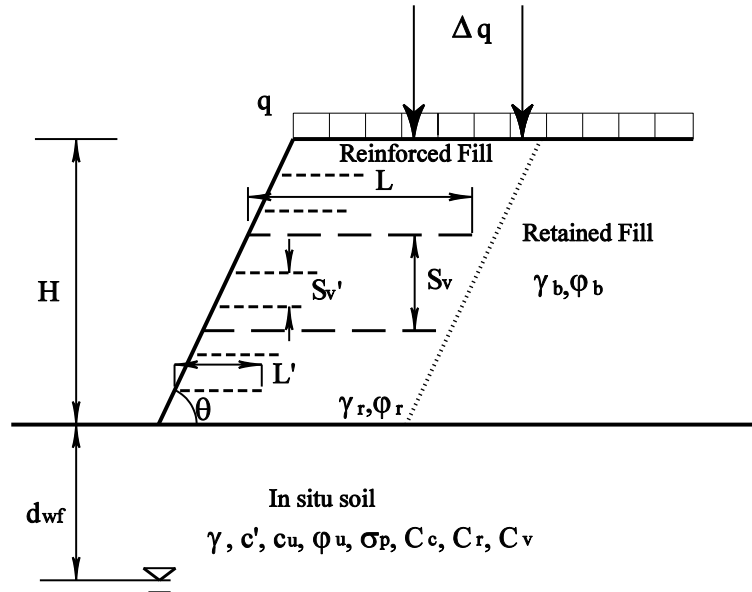

- Notations:**
- H = slope height
 - θ = slope angle
 - L = length of primary reinforcement
 - L' = length of secondary reinforcement, 4' minimum
 - S_v = vertical spacing between primary reinforcements, 4' maximum
 - S_v' = vertical spacing between secondary reinforcements, 1' maximum
 - q = surcharge load
 - Δq = temporary live load
 - d_{wf} = depth to groundwater table in foundation
 - $\gamma_r, \gamma_b, \& \gamma$ = unit weights of soils in reinforced, retained and foundation, respectively
 - $\phi_r, \phi_b, \& \phi$ = friction angles of soils in reinforced, retained and foundation, respectively
 - c', c_u = cohesion strength parameters of foundation soil

Exhibit 31-B Geosynthetic Reinforced Foundations Over Soft Soils

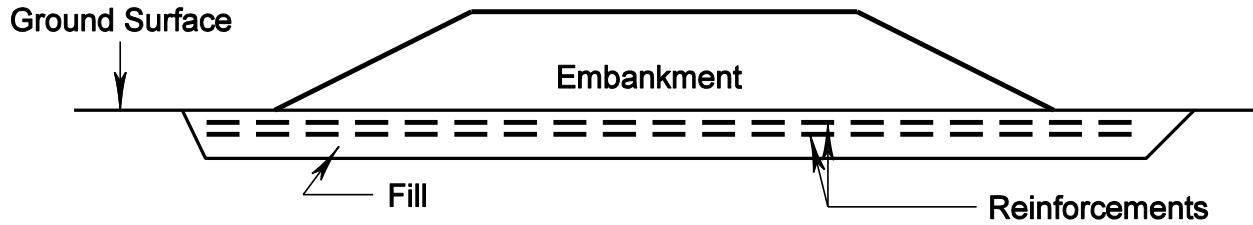

1. The spacing between any two reinforcements must be 6 to 12 inches.
2. Extend the reinforcement layer(s) below the embankment to 3 feet beyond the toe of slope or the development length required to resist pullout, whichever is longer.
3. Additional layers of reinforcement may be added below or within the embankment.

Chapter 32

Noise Walls and Perimeter Walls

32.1	General Requirements	32-1
32.1.1	Noise Walls	32-1
32.1.2	Perimeter Walls	32-3
32.2	Noise Study Report Addendum	32-6
32.3	Noise Abatement Criteria	32-7
32.4	Public Involvement	32-11
32.4.1	Noise Walls	32-11
32.4.2	Perimeter Walls	32-12
32.5	Final Noise Abatement Commitments	32-14
32.6	Contract Plans Preparation	32-15
32.6.1	Preparation of Control Drawings	32-15
32.6.2	Geotechnical Investigation	32-15
32.6.3	Use of Design Standards	32-15
32.6.4	Project Requirements	32-16
Tables		
Table 32.1	Noise Abatement Criteria	32-10

THIS PAGE LEFT BLANK INTENTIONALLY

Chapter 32

Noise Walls and Perimeter Walls

32.1 General Requirements

32.1.1 Noise Walls

Chapter 23 of the **Code of Federal Regulations Part 772 (23 CFR 772)** entitled **“Procedures for Abatement of Highway Traffic Noise and Construction Noise”** contains the federal regulations for the assessment of traffic noise impacts and abatement on federal aid projects. **Chapter 335.17** of the **Florida Statutes** requires the use of **23 CFR 772** for traffic noise impact assessment on highway projects, regardless of funding. The policy for abatement of traffic noise on Department projects and the requirements for assessing the noise impacts and abatement commitments are detailed in FDOT’s Noise Policy (Part 2, Chapter 17 of the [Project Development and Environment Manual \(PD&E Manual\) \(Topic No. 650-000-001\)](#)). The initial evaluation of noise impacts is made during the Project Development and Environment (PD&E) phase of a project. Preliminary commitments to provide reasonable and feasible noise abatement measures on a project are included in the Noise Study Report (NSR) and summarized in the environmental document. Review the environmental documents and any subsequent re-evaluations to identify all preliminary noise abatement commitments.

Preliminary noise abatement commitments made during the PD&E phase are subject to change due to refinements during final design. Designers must consider final roadway grades and horizontal alignments, land use changes, as well as ground elevation at noise wall locations. Noise abatement identified as reasonable and feasible during the PD&E phase needs to be reassessed against the final roadway features. The typical PD&E phase assumptions are appropriate for reasonableness and feasibility decisions but the final design must utilize location specific data that reflects proposed vertical and horizontal locations of the travel lanes and noise walls. The noise specialist must provide the top of noise wall elevation for both minimum and desirable insertion reductions as described below. The designer must coordinate with the noise specialist in the District Environmental Management Office to ensure proper analysis and public involvement occurs during final design.

Modification for Non-Conventional Projects:

Delete the above paragraph and replace with the following:

See the RFP for noise wall requirements. If an Alternative Technical Concept is proposed that changes the horizontal or vertical alignments depicted in the Concept Plans, any associated required changes to the noise wall locations must also be addressed. Any modifications/additions to noise wall location and height requirements depicted in the RFP must be assessed by the Department based on the information provided by the design-build firm and are subject to Department approval. Reassessment of the noise study must be performed by the Department as necessary. The Design-Build Firm must coordinate with the noise specialist in the District Environmental Management Office to ensure proper public involvement occurs during final design.

If no noise abatement is identified in the environmental document or any subsequent environmental re-evaluations, no further effort is required during final design. However, it may still be necessary to evaluate construction noise and vibration impacts and develop any Special Provisions to be included in the plans.

Modification for Non-Conventional Projects:

Delete the above paragraph and replace with the following:

If noise walls are not specified in the RFP, no further effort is required during final design. However, it may still be necessary to evaluate construction noise and vibration impacts and develop any Special Provisions to be included in the plans.

Upon review of the environmental documents the designer and the noise specialist should identify the noise receptors considered during the noise impact assessment performed in PD&E. Noise receptors resulting from development completed after the approval date of the environmental documents should not be considered as the Department is not responsible for providing noise abatement at these sites. A detailed design reassessment of the preliminary noise abatement commitments should be conducted for the following:

1. Locations of preliminary noise abatement commitments
2. Receptor sites where roadway geometric refinements are likely to change noise impacts

An addendum to the NSR (NSRA) prepared by the District Environmental Management Office during Final Design will document the final noise abatement commitments.

Modification for Non-Conventional Projects:

Delete the above two paragraphs and replace with the following:

Any NSR Addendum prepared during a Design-Build project must be prepared by the Department.

See RFP for requirements.

See **Structures Design Guidelines, Section 1.4.5** for the policy on noise wall surface finishes.

32.1.2 Perimeter Walls

The purpose of a perimeter wall is to provide a separation between a highway and adjacent land users to maintain the quality of life that existed prior to the construction of a highway project and are not assumed to provide any measurable noise reduction benefits. Benefits of perimeter walls may include, but not be limited to, minimizing visual impacts, providing a visual screen when existing vegetation is removed, providing separation to adjacent land owners, maintaining access control restrictions, and others. These recommendations are not intended to mandate the use of perimeter walls in any instance and are to be considered only as a guide to aid in engineering decisions made on the project. Perimeter walls are not to be considered for retrofitting existing conditions where highway improvements are not proposed, for mitigation of environmental impacts or for buildings that received a building permit after approval of the Categorical Exclusion, the Finding of No Significant Impact (FONSI), the Record of Decision, State Environmental Impact Report (SEIR) of Non-major State Action (date of public knowledge) for a project, unless an exception is granted by the Assistant Secretary of Engineering and Operations, on a case by case basis. Perimeter walls may be considered around FDOT facilities such as rest areas, weigh stations, etc., to provide a positive separator between the facilities and the adjacent land uses.

The initial assessment for the use of a perimeter wall would typically be performed during the Project Development and Environment (PD&E) process and only when such a wall is requested by a local municipality or a substantial group of affected residents/property owners. The final decision for the use of a perimeter wall would be

made during the Design Phase when the final conditions and cost are available for consideration.

Document the results of the perimeter wall analysis in a Perimeter Wall Justification Report. This is a standalone report and is not part of any environmental document. Final decisions made during the Design Phase will be added to the report by addendum.

The following steps provide a general overview of the process to consider requests for perimeter walls:

1. Considerations for a Perimeter Wall Assessment

Perimeter walls will be considered in areas requested by a local municipality or group of directly affected residents/property owners and where a perimeter wall is deemed to offer benefit to the adjacent land use. Perimeter walls will only be considered on the project types listed below and will not be considered for resurfacing, operational, highway safety, maintenance, emergency, or enhancement projects. The following are projects where perimeter walls may be considered and only when the distance from the edge of the travel lane to the closest portion of the adjacent structure is equal to or less than 150 feet:

- The capacity of an existing highway is expanded by adding lanes to the outside;
- Horizontal and/or vertical alignment of an existing highway is significantly altered as defined in the *PD&E Manual*;
- A highway on new location;
- Existing extensive vegetation or other visual barriers are removed.

2. Factors Considered for a Perimeter Wall Recommendation

If any of the above criteria are met, the Department will evaluate the following factors to determine if a perimeter wall would be considered for the project:

- Functional Classification (Access Controlled Urban Arterials, freeways)
- Adjacent land uses (highly residential, schools, recreation areas)
- View of traffic from the adjacent land use. If the traffic on a road is not visible from the adjacent land use, a perimeter wall will not be considered

The following feasibility factors should be considered: constructability, safety, cost, access, drainage and utility conflicts. Perimeter walls may also be considered

when FDOT is granted an easement to facilitate the construction of the wall. Perimeter walls will not be considered if additional Right of Way must be acquired to incorporate the wall into a project. Perimeter walls will not be recommended across the frontage of properties with closely spaced driveways that will require multiple openings on the wall. See **Structures Design Guidelines, Section 3.18** for additional limitations on where perimeter walls may be located.

The cost of providing the perimeter wall must not exceed \$25,000 for each adjacent land owner. Include the cost of relocating existing utilities in this cost. Only lands immediately adjacent to the R/W will be considered for perimeter walls.

To assure consistent application of these guidelines, partial or complete funding from third party sources will not be accepted and no custom designs are allowed.

3. Local Municipality Concurrence

If a perimeter wall is proposed, the Department will approach the local government during the design phase of the project to seek concurrence on the incorporation of the perimeter wall into the project. The local government will be responsible for obtaining support from the majority (simple majority) of the adjacent residents/property owners prior to construction of a perimeter wall. FDOT will work closely with the local municipality to determine final wall locations, color, texture, etc. For walls located on non-FDOT owned lands, the local government or land owner assumes the responsibility for all maintenance, including structural repairs. The local government or land owner will provide formal concurrence with the recommendation (resolution or letter) and a Maintenance Agreement for the perimeter wall, if applicable.

Modification for Non-Conventional Projects:

Delete **Section 32.1.2** and replace with the following:

See the RFP for perimeter wall requirements. If an Alternative Technical Concept is proposed that changes the horizontal or vertical alignments depicted in the Concept Plans, any associated required changes to the perimeter wall locations must also be addressed. Any modifications/additions to perimeter wall location requirements depicted in the RFP must be assessed by the Department based on the information provided by the Design-Build Firm and are subject to Department approval. The Design-Build Firm must coordinate with the District Environmental Management Office to ensure proper public involvement occurs during final design.

32.2 Noise Study Report Addendum

The primary effort related to the reassessment of preliminary noise abatement commitments during design is the preparation of an addendum to the NSR. The reassessment must be based on the final roadway geometry and the proposed noise abatement design, including noise wall type, location, dimensions and estimated costs. For consistency, the Final Design reassessment should be conducted using the latest version of the FHWA's Traffic Noise Model (TNM).

Noise abatement measures are considered when noise levels at a receptor(s) approach or exceed the noise abatement criteria or substantially exceed existing noise levels. The noise abatement criteria is listed in **Table 32.1**. Approaching the criteria means within 1 dB(A) of the noise abatement criteria. A predicted increase of 15 dB(A) or more is considered substantial. Noise abatement is considered for Activity Categories A, B, C, D and E only. Preliminary noise abatement commitments are documented in the original NSR.

An NSR Addendum is not required for perimeter walls.

Modification for Non-Conventional Projects:

Insert the following sentences at the beginning of **Section 32.2**:

The NSR Addendum must be prepared by the Department.

See RFP for requirements.

32.3 Noise Abatement Criteria

The insertion loss is the level of noise reduction as a result of abatement. The desirable insertion loss is 10 dB(A) or more; however, the minimum insertion loss should be 5 dB(A) or more for at least two (2) impacted residential receptors to be considered for abatement to be considered reasonable. Additionally, at least one (1) benefited receptor at each noise wall location must meet the noise reduction design goal of 7 dB(A) or more to be considered reasonable. If a noise wall can meet the desired insertion loss for a cost of \$42,000 or less per benefited receptor site, the wall is considered cost reasonable. The statewide average unit cost (per square foot) and the upper limit of the cost per benefited receptor to be used in determining cost reasonableness is established by the Environmental Management Office. As of the printing of this update the statewide average unit cost of noise walls to be used in the calculation of the cost/benefited receptor is \$30.00/ft². The *PD&E Manual* should be referenced for the latest unit cost update. Additional costs such as required additional right of way, special drainage features, special bridge support and special foundations associated with the installation of a noise wall should be added to the unit cost if appropriate. If these special features increase the cost per benefited receptor above \$42,000, the decision whether or not to provide a wall must be made in consultation with the District Environmental Management Office and FHWA (if appropriate). Any decision to eliminate a noise wall from consideration based on the additional cost of special features will require clear demonstration that the need for such special features are associated only with the noise wall and cannot be mitigated by other considerations.

If a minimum of 5 dB(A) insertion loss cannot be achieved at a receptor, that receptor is not benefited; therefore, it cannot be considered in the cost effective calculation to determine the reasonableness of that noise wall. The noise specialist should thoroughly investigate the scenarios required to meet the desirable insertion loss of 10 dB(A) at \$42,000 or less per benefited receptor particularly where design changes or the consideration of special features require cost or abatement level reanalysis.

Under normal conditions noise walls must not exceed the following heights:

1. For ground mounted noise walls use a maximum height of 22 feet. Non-crash tested noise walls within the clear zone require shielding.
2. For noise walls on bridge and retaining wall structures use a maximum height of 8 feet unless a taller noise wall is specifically approved in writing by the State Structures Design Engineer.

Modification for Non-Conventional Projects:

Delete condition #2 above and replace with the following:

2. For noise walls on bridge and retaining wall structures use a maximum height of 8 feet unless otherwise specified in the RFP.

3. For ground mounted Traffic Railing/Noise Wall combinations use a maximum height of 14 feet.

Use of noise wall heights greater than these require a Design Variation and project specific designs. Justification for a variation should include, as a minimum, a description of site conditions requiring the increased height and a comparison to the standard height of both insertion loss and cost per benefited receptor.

The noise specialist should provide analytical results to the Department project manager evaluating noise wall heights necessary to achieve minimum, desired and optimum insertion loss. The optimum noise wall height is the most cost effective in consideration of noise reduction benefits per unit cost of the noise wall. An evaluation matrix is suited to this type of comparative analysis. The evaluation matrix should consider an appropriate range of noise wall configurations (height, length and roadway offset) that provide the desirable insertion loss (10 dB(A)) per impacted receptor and the minimum insertion loss (5 dB(A)) per impacted receptor and the noise reduction design goal of 7 dB(A). The number of benefited receptors should be identified and the cost per benefited receptor calculated for each configuration evaluated. If a noise wall configuration can provide the desirable insertion loss (10 dB(A)) at a reasonable cost (less than \$42,000 per benefited receptor), then it should be provided. If this is not achievable, the noise specialist should select a noise wall configuration that optimizes insertion loss per impacted receptor and cost per benefited receptor. The noise specialist should always provide a recommendation with the evaluation. The noise specialist should also coordinate with the District Structures Design Office to ensure that the noise wall design meets appropriate structural design standards and that construction is feasible and achievable.

The height of the noise wall is measured from the ground elevation to the top of the noise wall. Tall noise walls are seldom necessary at the top of roadway embankments or berms since the elevation of the embankment contributes to the effective height of the noise wall. In addition, changes in the vertical grade of the top of the noise wall should be gradual and abrupt changes in wall heights should be avoided. Often natural ground elevations at the base of the noise wall fluctuate, even in flat terrain. Therefore, the

designer, in conjunction with the noise specialist, should provide plan details that make clear to the contractor the final top of wall elevations, post spacing and foundation step locations. See the ***Instructions for Design Standards*** for ***Design Standards, Index 5200 Series*** for additional requirements.

When an otherwise continuous noise wall is broken resulting in a horizontal separation between the wall sections, it is often necessary to overlap the wall sections to reduce insertion loss degradation. Applications of this occur when the mainline noise wall is located at the right of way line, but must be moved to the shoulder break at a bridge location. This may also occur at interchanges when transitioning from the mainline to a ramp. The overlap distance of noise walls is generally equal to four times the separation; however, an analysis by the noise specialist is necessary to determine the optimum overlap. The need or effectiveness of a noise wall in the infield area of an interchange should be reviewed as well during final design. The attenuation of ramp traffic may provide adequate insertion loss when considering the intersecting roadway's noise contribution. Maintenance access, clear zone and line of sight must be considered when selecting noise wall termini details.

Other noise abatement techniques that may be considered to supplement or replace noise walls are:

1. Traffic management measures (e.g., traffic control devices and signing for prohibition of certain type vehicles, time use restrictions for certain type vehicles, modified speed limits, and exclusive lane designations);
2. Alteration of horizontal and vertical alignments;
3. Acquisition of property rights for construction of noise walls by donation, purchase or condemnation;
4. Acquisition of the balance of a noise-sensitive property from which there is a taking, if acquisition is less expensive than other methods;
5. Acquisition of real property to create a buffer zone; and
6. Noise insulation of Activity D land uses.

Table 32.1 Noise Abatement Criteria

NOISE ABATEMENT CRITERIA [Hourly A-Weighted Sound Level-decibels (dB(A))]				
Activity Category	Activity Leq(h) ¹		Evaluation location	Description of activity category
	FHWA	FDOT		
A	57	56	Exterior	Lands on which serenity and quiet are of extraordinary significance and serve an important public need and where the preservation of those qualities is essential if the area is to continue to serve its intended purpose.
B ²	67	66	Exterior	Residential
C ²	67	66	Exterior	Active sports areas, amphitheaters, auditoriums, campgrounds, cemeteries, day care centers, hospitals, libraries, medical facilities, parks, picnic areas, places of worship, playgrounds, public meeting rooms, public or nonprofit institutional structures, radio studios, recording studios, recreational areas, Section 4(f) sites, schools, television studios, trails, and trail crossings.
D	52	51	Interior	Auditoriums, day care centers, hospitals, libraries, medical facilities, places of worship, public meeting rooms, public or nonprofit institutional structures, radio studios, recording studios, schools, and television studios.
E ²	72	71	Exterior	Hotels, motels, offices, restaurants/bars, and other developed lands, properties or activities not included in A-D or F.
F	–	–	–	Agriculture, airports, bus yards, emergency services, industrial, logging, maintenance facilities, manufacturing, mining, rail yards, retail facilities, shipyards, utilities (water resources, water treatment, electrical), and warehousing.
G	–	–	–	Undeveloped lands that are not permitted.

(Based on Table 1 of 23 CFR Part 772)

¹ The Leq(h) Activity Criteria values are for impact determination only, and are not design standards for noise abatement measures.

² Includes undeveloped lands permitted for this activity category.

Note: FDOT defines that a substantial noise increase occurs when the existing noise level is predicted to be exceeded by 15 decibels or more as a result of the transportation improvement project. When this occurs, the requirement for abatement consideration will be followed.

32.4 Public Involvement

32.4.1 Noise Walls

The identification and design of noise abatement measures during the project design phase will require additional public involvement efforts and will be especially important in the establishment of noise wall design features such as wall texture. Public coordination is often necessary to finalize wall locations, heights and aesthetic features, especially if there are substantial changes to prior commitments. These changes may be the result of any of the considerations noted in **Section 17-4** of the **PD&E Manual**. Coordination with the District Public Involvement or Community Liaison Coordinator in obtaining additional input during the final design of the noise wall is required.

When a noise wall is warranted, a written survey must be conducted to establish whether a numerical majority of the benefited receptors are in favor of the construction of the noise wall. If they are not in favor, the Department may choose not to build it. If agreement cannot be reached by a neighborhood on the use of noise walls, the decision to provide them or not will rest solely with the Department. This survey will usually be conducted during the design phase although it is possible that a survey could be conducted during the PD&E phase. Survey issues should be coordinated with the District Environmental Management Office.

Noise walls located on arterial roadways can potentially impact access. The ability to construct an effective noise wall(s) can depend on an individual property owner's willingness to sign a right of way indenture allowing access to be cut off or modified. For these type projects it is general practice to obtain a written statement from each affected property owner demonstrating support for the noise wall. If an adjacent property owner(s) declines to sign the indenture the noise specialist must re-evaluate the effectiveness of noise abatement on the project segment considering alternate noise wall layouts. If insertion loss criteria cannot be met, the noise specialist must document in the NSR Addendum that the noise wall is not feasible.

F.S. 479.25 "Erection of noise-attenuation barrier blocking view of sign; procedures; application", provides procedures and requirements for allowing permitted, conforming, lawfully erected outdoor advertising signs to be increased in height if visibility is blocked due to construction of noise walls (or "noise attenuation barriers" as referred to in the statute). In addition, the statute provides procedures that address various coordination requirements (such as notification requirements, survey requirements, public hearing requirements, and approval requirements) for the involved parties (which include the Department, the local government or local jurisdiction, and

the benefited receptors (or “impacted property owners” as referred to in the statute)). Please refer to **Part 1, Chapter 11 Public Involvement**, of the **PD&E Manual** for additional details about meeting notification requirements.

32.4.2 Perimeter Walls

Public involvement for perimeter walls may follow a similar approach as is used for Noise Walls, except that the Noise Study Report and NSR Addendum are not required, and noise abatement and attenuation criteria are not applicable.

The identification and design of perimeter walls during the project design phase will require additional coordination with the local government, may require public involvement efforts and will be especially important in the establishment of perimeter wall project requirements such as wall texture. Public coordination is often necessary to finalize wall locations and aesthetic features, especially if there are substantial changes to conditions or previously requested needs. Coordination with the local government and the District Public Involvement or Community Liaison Coordinator in obtaining additional input during the final design of the perimeter wall is required.

When a perimeter wall is proposed, the Design Project Manager will approach the local government during the design phase of the project to seek concurrence on the incorporation of the perimeter wall into the project. The local government will be responsible for obtaining support from the majority (simple majority) of the adjacent residents/property owners prior to construction of a perimeter wall. If they are not in favor, the Department may choose not to build it. FDOT will work closely with the local municipality to determine final wall locations, color, texture, etc. For walls located on non-FDOT owned lands, the local government or land owner assumes the responsibility for all maintenance, including structural repairs. The local government or land owner will provide formal concurrence with the recommendation (resolution or letter) and a Maintenance Agreement for the perimeter wall, if applicable.

For perimeter walls, decisions related to the identification and design of a perimeter wall (identified in the Perimeter Wall Justification Report (PWJR)) will be amended by the design Project Manager in a PWJR Addendum during the design phase. The addendum should document the final decision on whether or not to use a perimeter wall at the requested location(s). The addendum should also document perimeter wall project requirements, commitments or agreements made during the design phase related to a requested perimeter wall, as well as any changes in site or project conditions that may have occurred since the PWJR.

Perimeter walls located on arterial roadways can potentially impact access. The ability to construct perimeter wall(s) can depend on an individual property owner's willingness to sign a right of way indenture allowing access to be cut off or modified. For these type projects it is general practice to obtain a written statement from each affected property owner demonstrating support for the perimeter wall. If an adjacent property owner(s) declines to sign the indenture the Department must coordinate with the local government to re-evaluate the feasibility of the perimeter wall, and the Design Project Manager must document in the PWJR Addendum if the perimeter wall is not feasible.

F.S. 479.25 "Erection of noise-attenuation barrier blocking view of sign; procedures; application", provides procedures and requirements for allowing permitted, conforming, lawfully erected outdoor advertising signs to be increased in height if visibility is blocked due to construction of noise walls (or "noise attenuation barriers" as referred to in the statute). Even though ***F.S. 479.25*** is specific to "noise attenuation barriers", if visibility of a permitted, conforming, lawfully erected outdoor advertising sign is blocked due to the construction of a perimeter wall, then the statute will apply (although the noise abatement and attenuation criteria are not applicable). Please refer to ***Part 1, Chapter 11 Public Involvement***, of the ***PD&E Manual*** for additional details about meeting notification requirements.

32.5 Final Noise Abatement Commitments

During the final design phase, the noise abatement locations, noise wall types, lengths and heights will be determined. The final noise abatement commitments must be documented in the environmental re-evaluation and the NSR Addendum prior to construction advertisement. The required data collection, analysis and documentation detailed in **Part 2, Chapter 17** of the **Project Development and Environment Manual** will be documented in the NSR Addendum. It should also contain a description of the methodology for selecting final noise wall dimensions including any evaluation matrix(s) used.

Modification for Non-Conventional Projects:

Replace the first two sentences of the above paragraph with the following:

Any modifications to noise abatement locations, noise wall types, lengths and heights must be documented in the environmental reevaluation and the NSR Addendum prepared by the Department prior to beginning noise wall construction.

A copy of the NSR Addendum, a summary of proposed noise wall and a summary of the public involvement regarding noise abatement that took place during the design effort will be provided to the District Environmental Management Office. The environmental management staff will ensure that the final noise abatement commitments are reflected in the reevaluation of the environmental document and will obtain concurrence from FHWA, if appropriate.

32.6 Contract Plans Preparation

32.6.1 Preparation of Control Drawings

The initial set of drawings to be prepared by the EOR is referred to as Control Drawings. By preparation of these drawings, the EOR must provide all control parameters such as alignments, limits, notes, etc., and must provide all the information which is common to all wall types. See the appropriate **Design Standards** and the associated **Instructions for Design Standards (IDS)** for more information.

32.6.2 Geotechnical Investigation

Once the noise wall location, alignments, height and minimum thickness are determined, or the perimeter wall location and alignments are determined, the soil exploration should be undertaken. The geotechnical engineer should follow the Department's **Soils and Foundations Handbook** for exploration.

32.6.3 Use of Design Standards

Designers must specify the Department's **Design Standards** for Noise Walls and Perimeter Walls. Use **Design Standards, Index 5200** for ground mounted post and panel type Precast Noise Walls or **Design Standards, Indexes 5210** thru **5215** for Traffic Railing/Noise Wall combinations. Use **Design Standards, Index 5250** for Perimeter Walls. See the appropriate **Design Standards** and **IDS** for more information and limitations of each Index. See **LRFD Section 15** and **Structures Design Guidelines, Sections 3.16** and **3.18** for the Noise Wall and Perimeter Wall design criteria.

Modification for Non-Conventional Projects:

Delete **PPM** 32.6.3 and replace with the following:

32.6.3 Use of Design Standards

Unless otherwise required in the RFP, utilize the Department's **Design Standards** for Noise Walls and Perimeter Walls. Use **Design Standards, Index 5200** for ground mounted post and panel type Precast Noise Walls or **Design Standards,**

Indexes 5210 thru **5215** for Traffic Railing/Noise Wall combinations. Use **Design Standards, Index 5250** for Perimeter Walls. See the appropriate **Design Standards** and **IDS** for more information. See **LRFD Section 15** and **Structures Design Guidelines, Sections 3.16** and **3.18** for the Noise Wall and Perimeter Wall design criteria.

32.6.4 Project Requirements

The designer must establish the project requirements for noise walls based on the analysis and feasible commitments made during the PD&E phase or during the design phase public involvement. Project requirements for noise walls may include color, textures, graphics, use of anti-graffiti coatings, flush vs. recessed panels, etc.

The designer must establish the project requirements for perimeter walls based on the initial assessment made during the PD&E phase or based on any commitments made during the design phase public involvement. Project requirements for perimeter walls are limited to post cap type, texture, color and the use of anti-graffiti coatings.

The project requirements must be listed in the Data Tables. See the appropriate **IDS** for more information on Data Tables.

Modification for Non-Conventional Projects:

Delete **PPM** 32.6.4 and see RFP for requirements.

Chapter 33

Reinforced Concrete Box and Three-Sided Culverts

33.1	General	33-1
33.2	Structure Type Selection	33-3
33.2.1	Precast Concrete Culverts	33-4
33.2.2	Concrete Box Culverts	33-5
33.2.3	Three-Sided Concrete Culverts	33-5
33.2.4	Precast Arch and Arch-Topped Units	33-6
33.2.5	Precast Frame Units	33-6
33.3	Foundation Design	33-8
33.3.1	Rock Foundations	33-8
33.3.2	Earth or Granular Soil Foundations	33-9
33.3.3	Three-sided Culvert Foundation Design	33-10
33.4	Wingwalls	33-11
33.5	Headwalls/Edge Beams	33-12
33.6	Cutoff Walls	33-13
33.7	Aprons	33-13
33.8	Subbase Drainage	33-14
33.9	Joint Waterproofing	33-14
33.10	Traffic Railings	33-15
33.11	Design Requirements for Concrete Culverts	33-16
33.12	Design Details	33-16

33.13 Computer Design and Analysis Programs 33-18

33.14 Design and Shop Drawing Approvals 33-18

Tables

Table 33.1 Bar Identification Schedule 33-17

Chapter 33

Reinforced Concrete Box and Three-Sided Culverts

33.1 General

This chapter presents the minimum requirements for selection and designing reinforced concrete culverts. The Department recognizes two types of reinforced concrete culverts other than reinforced concrete pipe. These are concrete box culverts (four-sided) and three-sided concrete culverts. Both of these culvert types are classified as Category 1 structures in accordance with **Chapter 26**. It is not possible to provide prescriptive requirements for all conditions so guidance provided in this chapter is for typical designs. Each location will usually have some unique character (floods, scour, surroundings, salt water, historic character, etc.). Unique environments need to be thoroughly evaluated and all environmental requirements satisfied.

Structures with a span greater than or equal to 20 feet are technically not culverts, however, for simplicity all structures in this chapter are referred to as culverts.

The procedure for the hydraulic analysis of culverts differs based on whether the culvert is located at a riverine or tidal crossing. Refer to **Chapter 4** of the *Drainage Manual* for the appropriate hydraulic analysis and documentation requirements.

Definitions of terms used in this chapter include the following:

Bridge-size culverts are defined as any structure, whether of single-span or multiple-span construction, with an interior width greater than or equal to 20 feet when measured horizontally along the centerline of the roadway from face-to-face (inside) of the extreme abutments or sidewalls.

Culverts are defined as any structure, whether of single-span or multiple-span construction, with an interior width less than 20 feet when measured horizontally along the centerline of the roadway from face-to-face (inside) of the extreme abutments or sidewalls.

Concrete box culverts (four-sided) typically have rectangular cross sections. An arch or arch-topped culvert is considered a box culvert if the “sidewalls” are built monolithic

with the bottom (invert) slab. Two-piece (four-sided) box culverts are permitted with a simply supported top slab, which is keyed into a monolithic three-sided bottom section. Concrete box culverts are typically used where the streambed is earth or granular soil and rock is not close enough to the streambed to directly support the structure.

Three-sided concrete culverts may be rectangular in shape or a frame with varying wall and/or slab thickness or an arched or arch-topped structure. These structures have separate foundations with spread footings supported by earth, rock or piles. The largest culverts are typically not boxes; rather they are frames or arches. Use of three-sided concrete culverts where rock is not at or near the streambed requires pile support for the footings or some other form of positive scour protection. Three-sided concrete culverts on spread footings may be used for railroads, wildlife crossings, bicycle/pedestrian/equestrian/golf cart paths, and other uses that do not convey water or have scour vulnerability.

Clear span is the perpendicular distance between the inside face of the sidewalls. The maximum clear span recommended for a concrete box culvert is 24 feet.

Design span for non-skewed culverts is the perpendicular distance between the centerline of the sidewalls. For culvert units with skewed ends, the design span of end sections is the distance between the centerlines of the sidewalls measured parallel to the skewed end.

33.2 Structure Type Selection

The designer must determine the most appropriate type of short-span structure. The basic choices are a corrugated metal structure, concrete box culvert, concrete frame or arch, and a short-span bridge. While the site conditions are the primary deciding factor for structure selection, aesthetics, constructability and economics are also very important.

Proper selection of the feasible structure alternatives is based on site and project-specific parameters, including but not limited to:

1. Vertical and horizontal clearance requirements.
2. Available "beam" (top slab) depth.
3. Maintenance and protection of traffic requirements (e.g., phase construction).
4. Construction constraints (e.g., water diversion requirements).
5. Foundation requirements.
6. Environmental concerns (e.g., natural streambed).
7. Desired aesthetic treatments (e.g., arch appearance).
8. Geometric limitations (e.g., skew angle, R.O.W. restrictions, utilities, etc.).

Concrete culverts are usually more expensive in initial cost than corrugated metal structures. However, concrete culverts are the preferred alternative when considering suitability to the site and life-cycle cost estimates. The advantages of concrete culverts are superior durability for most environmental conditions, greater resistance to corrosion and damage due to debris, greater hydraulic efficiency, and typically longer service life (i.e., potentially lower life-cycle costs).

At sites with limited headroom, concrete culverts are generally the least expensive option. Smaller corrugated metal structures typically require a minimum height of soil cover of 2 feet and for some structures the soil cover increases to 4 feet or more depending on size and shape. Concrete culverts, frames, and arches can have the least amount of cover by placing a minimum of 3 inches of asphalt pavement directly on the top slab. Corrugated metal structures will also typically require taller structures than concrete box culverts, to provide adequate waterway area below design high water due to their arched shapes. If a corrugated metal structure is a viable option, an engineering evaluation and cost analysis should be performed in consultation with the District Drainage Engineer.

Single-cell and multi-cell concrete box culverts with barrel spans less than 15 feet, are often the most cost effective structural solution where debris collection and aesthetics are not a major concern. Three-sided culverts may be appropriate for single spans exceeding 20 feet where scour is not a concern.

Before a final determination is made to use a large concrete culvert, the use of a short-span bridge should be investigated. Possible advantages of a bridge may be minimized work in the stream, speed of erection, minimized interference with the existing structure foundation, and easier phased construction. For procedural steps on planning short-span bridges, see **Chapter 26**.

33.2.1 Precast Concrete Culverts

Precasting permits efficient mass production of concrete units. The advantages often offset the cost of handling and transporting the units to the site. Precast units are often limited to certain sizes and skews due to forms, transportation and handling concerns. Skewed units typically need more reinforcement and thicker slabs and/or sidewalls. The use of skewed units will increase the cost of the culvert due to increased fabrication costs.

Skewed end units are sometimes required to satisfy right of way constraints and/or phased construction requirements for skewed alignments. In the event they are necessary, skewed precast culvert units must be designed for the skewed-end design span. Precast manufacturers should be contacted for information on maximum skews available.

Precast culverts may occasionally need to be placed on moderate or steep grades. No maximum slope is recommended for box culverts because of the need to match the slope of the streambed. Three-sided box culverts and the frames and arches should be limited to a maximum slope of 2%. If matching a steeper slope is necessary, the ends of the precast units must be beveled to create vertical joints and the footings may be stepped and/or the length of the sidewall varied. Precast manufacturers should be contacted for the maximum grade that can be fabricated if the designer is proposing a grade larger than 2%.

When two or more single-cell, precast concrete culverts are placed side-by-side, provide a 2 to 4 inch gap between the walls of adjacent cells. Fill this gap with Class I (non-structural) concrete, non-excavatable flowable fill or non-shrink grout.

All manufacturers must have approved precast drainage product facilities in accordance with **Section 6.3** of the **Materials Manual**.

33.2.2 Concrete Box Culverts

When a concrete box culvert is selected as the appropriate structure for the site, a cast-in-place culvert must be designed and detailed in the contract plans. A precast concrete box culvert alternative is permitted during construction unless specifically excluded in the contract plans. Speed of erection, maintenance of traffic, stream diversion problems, and site constraints can be minimized when utilizing precast culverts.

33.2.3 Three-Sided Concrete Culverts

There are various types of proprietary, precast concrete frames, arch topped units, and arches available. These units are typically used when larger culverts (spans ≥ 20 feet) are required. They can only be considered when scour protection is adequately provided and/or aesthetics are a consideration. They may be placed on spread footings with an invert slab, footings on rock, or pile-supported footings. The advantages of the precast concrete arches and frames are the same as for the precast concrete box culverts, except that longer spans (up to 48 feet) are possible.

When a three-sided concrete culvert is selected as the appropriate structure for the site a precast culvert should be the preferred option. A cast-in-place reinforced concrete foundation and the channel lining must be designed and detailed in the contract plans. The final design of the precast three-sided culvert structure and any necessary foundation modifications must be completed by the Contractor's Engineer of Record (usually the manufacturer).

Sizes of precast units that are common to more than one manufacturer should be selected. Dimensions of the sidewalls and top slab, reinforcement size and spacing should not be shown on the plans, unless necessary. If sidewall or top slab dimensions are dictated by site conditions, show only the affected dimensions and indicate if they are minimums, maximums, or specifically required dimensions. The assumed top slab dimension used to determine fill limits should be shown in the contract plans.

Include a note in the contract plans requiring the Contractor to provide all design details not included in the contract plans. This method should result in the most economical culvert design.

33.2.4 Precast Arch and Arch-Topped Units

Consider the following when selecting a precast arch or arch-topped culvert:

1. Aesthetics concerns may make the use of arch-shaped units desirable. The use of arch-shaped facade panels is not recommended, especially for hydraulic openings due to snagging of debris.
2. The amount of skew that can be fabricated varies. Some manufacturers prefer to produce only 0° skew units. The maximum skew at which a precast unit should be fabricated is 45° . The culvert orientation to the centerline of the highway may be at a skew greater than 45° .
3. An arch unit is preferable for a grade separation for highway vehicles or railroads, when a dry conveyance environment is necessary. The arch shape eliminates any ponding problems above the culvert without special fabrication or field adjustments that would be required for flat-topped culverts.
4. Arch units are preferred in cases where fills above the precast units exceed 20 feet.
5. Precast arch-topped units are currently available in spans up to 48 feet.
6. Arched units have been used as liners for old masonry or concrete arches in other States. After the construction of a pedestal wall at the base, the units are slid into place. The void between the existing arch and the liner is filled with grout installed through fittings cast into the liner units.
7. Large arch units may be shipped in two pieces and assembled on site. Three-piece units are not permitted.

33.2.5 Precast Frame Units

Consider the following when selecting a precast frame (rectangular) culvert:

1. Many of precast frame-type units can be fabricated with skew angles up to 45° . This characteristic is useful when phased construction is proposed. When used for phased construction with shallow highway pavements, no temporary shoring is needed at the phase construction joint to support the fill or pavement.
2. Frame units provide a simpler traffic railing/headwall connection than arch-topped units.
3. Frame units provide a hydraulic opening greater than arches of equivalent clear span when flowing full.

4. Precast frame units can be fabricated by some manufacturers with any increment of span length up to 40 feet, although typical span length increments are 2 feet.
5. Maximum rise of the units is normally limited to 10 feet due to shipping and handling considerations. If a larger rise is necessary, the designer should investigate the need for a pedestal wall.

33.3 Foundation Design

All structures discussed in this chapter, regardless of span and height of fill, are considered buried structures in regard to foundation design. Thus, there is no requirement for seismic analysis. This may change in the future as more research is completed.

For culverts with spans greater than or equal to 20 feet, foundation recommendations are provided to the designer in the Bridge Geotechnical Report (Phase I) and included in the Bridge Development Report BDR). Foundation design parameters for culverts with spans less than 20 feet are provided by the District Geotechnical Engineer or the Department's Geotechnical Engineering consultant. Foundation recommendations and design parameters must include factored bearing resistance, predicted total and differential settlements, and any required excavation and replacement to ensure proper behavior of the foundation.

The District Geotechnical Engineer or the District Structures Design Office should be consulted to determine the proper foundation treatment.

Modification for Non-Conventional Projects:

Delete *PPM* 33.3 and replace with the following:

33.3 Foundation Design

All structures discussed in this chapter, regardless of span and height of fill, are considered buried structures in regard to foundation design. Thus, there is no requirement for seismic analysis. The EOR will coordinate the foundation recommendations with the geotechnical engineer for the project. Foundation design parameters must be shown in the contract plan set and will include factored bearing resistance, predicted total and differential settlements, and any required excavation and replacement to ensure proper behavior of the foundation.

33.3.1 Rock Foundations

In the unusual case where sound rock is at or near the surface of a streambed, an invert slab is not required and a three-sided culvert would generally be the appropriate structure selected. Concrete footings are either keyed or doweled into rock based on consultation with an Engineering Geologist and the District Geotechnical Engineer.

If the elevation of the rock surface varies by 2 feet or less, the wall height should be constant and the footing height varied. If the variation in rock surface elevation exceeds 2 feet, the height of the culvert wall may be varied at a construction joint or at a precast segment joint. In some cases, it may be necessary to use walls of unequal heights in the same segment, but this should generally be avoided.

33.3.2 Earth or Granular Soil Foundations

In most cases a concrete culvert will not be founded on rock, so a box culvert (four-sided) with an integral invert slab should be the preferred foundation treatment. However, in areas of compact soil and low stream velocities, three-sided concrete culverts may be used if they have positive scour protection such as piles or channel lining with concrete-filled mattresses, gabions or riprap rubble, and spread footings founded below the calculated scour depth. Three-sided concrete culverts located in stream beds, with spans equal to or exceeding 20 feet, must have pile supported footings when the structure is not founded on sound rock.

To avoid differential settlement, concrete box culverts should never be founded partially on rock and partially on earth. If rock is encountered in a limited area, it should be removed to a minimum depth of 12 inches below the bottom of the bottom slab and backfilled with either select granular material or crushed stone. Concrete culverts are rigid frames and do not perform well when subjected to significant differential settlement due to a redistribution of moments. All concrete box culverts should have a designed undercut and backfill. Consult the District Geotechnical Engineer to determine the depth of the undercut and type of backfill material required to prevent excessive differential settlement. Any required undercut and backfill must be shown on the plans.

Modification for Non-Conventional Projects:

Delete the above paragraph and replace with the following:

The EOR will coordinate the depth of undercut and type of backfill with the geotechnical engineer for the project and include the details in the contract plans.

A concrete box culvert can be considered if settlement is expected and the foundation material is fairly uniform. However, the culvert should be designed to accommodate additional dead load due to subsequent wearing surface(s) which may be needed to accommodate the settlement of the box. Precast culverts require mechanical connections between units when significant differential settlement is anticipated. **Design Standards, Index 291** provides criteria for cast-in-place link slab to satisfy this requirement when joint openings are

expected to exceed 1/8 inch. The District Geotechnical Engineer or the Department's Geotechnical Engineering consultant should provide the anticipated differential settlement, which should be included in the contract plans.

If the foundation material is extremely poor and it is desirable to limit settlement, the problem should be referred to the District Geotechnical Engineer to determine the best course of action. A typical remedy might be removal of unsuitable or unstable material and replacement with suitable material. All required remedies must be shown on the plans.

33.3.3 Three-sided Culvert Foundation Design

When a three-sided structure is selected for a site, a cast-in-place footing design must be included in the contract plans. There are several types of culverts that may meet the project specifications. The designer must decide which specific type of unit would best fit that particular application and use those vertical and horizontal reactions for design of the foundations. The designer may contact known fabricators for design reactions. If no specific type of unit is determined as most appropriate, a conservative estimate of the design reactions for all types should be used and the reactions included in the contract plans.

Modification for Non-Conventional Projects:

Delete *PPM* 33.3.3 and replace with the following:

33.3.3 Three-sided Culvert Foundation Design

When a three-sided structure is selected for a site, the specific culvert details including the cast-in-place footing design must be included in the contract plans.

33.4 Wingwalls

A wingwall is a retaining wall placed adjacent to a culvert to retain fill and to a lesser extent direct water. Wingwalls are preferably cast-in-place, but precast wingwalls may be considered on a project by project basis. Wingwalls are generally designed as cantilevered retaining walls however precast counterfort and binwalls may also be considered. Cast-in-place wingwall designs are provided by the Department's standard box culvert computer program.

Wingwall alignment is highly dependent on site conditions and should be evaluated on a case-by-case basis. The angle(s) of the wall(s) on the upstream end should direct the water into the culvert. It is also desirable to have the top of the wall elevation above the design high water elevation to prevent overtopping of the wall.

When precast wingwalls are permitted the designer should be aware of potential conflicts with R/W limits and utilities. The footprint of the footing and excavation, especially for bin type walls, can be extensive. Notes should be placed on the plans alerting the Contractor to these requirements when they exist. Due to skew and/or grade differences between the cast-in-place or precast culvert units and precast wingwalls it is necessary to provide a cast-in-place closure pour between the culvert end unit and precast wingwalls. A closure pour is not required if cast-in-place wingwalls are used.

When precast wingwalls are permitted, the cost is included in the cost of the culvert barrel. No separate item is required but the estimated concrete and reinforcing steel quantities for a cast-in-place design should be included in the contract plans.

Modification for Non-Conventional Projects:

Delete *PPM* 33.4 and replace with the following:

33.4 Wingwalls

Precast wingwalls will only be permitted when specifically allowed in the RFP. The specific culvert details must be included in the contract plans.

33.5 Headwalls/Edge Beams

Headwalls are normally used on all culverts. In deep fills a headwall helps retain the embankment. In shallow fills the headwall may retain the subbase and/or highway pavement and provide the anchorage area for the railing system.

Headwalls should be cast-in-place and attached to precast culvert end segments in accordance with ***Design Standards, Index 291***. Headwalls one foot or less in height with no railing attachment for single barrel precast culverts may be precast. If a curb must be placed on a culvert without a sidewalk, the headwall must be cast-in-place to allow for the tie-in of the curb's anchor bar, unless the curb is also cast at the precast facility.

The typical maximum height of headwalls is 3 feet. Greater heights are attainable but are only used in special cases. Headwall heights greater than 2 feet above the top slab require an independent transverse analysis, which is not provided by the FDOT box culvert program.

Concrete culverts with skewed ends may require additional stiffening of the top and bottom slabs by what is most commonly called an "edge beam". An edge beam is similar to a headwall or cutoff wall. The headwall may be used to anchor metal traffic railing posts and traffic railings or retain earth fill, as well as stiffening the top slab of culverts that lose their rigid frame action as a result of having a skewed end.

When additional strength is required in the concrete edge beam, use the following criteria:

1. If there is a 1-on-2 slope to the edge beam, it will be more economical to increase the depth of the edge beam in order to meet the required design.
2. When the edge beam is at shoulder elevation (anchoring guard rail and traffic railing), the edge beam height should be maintained and the width of the edge beam should be increased.

33.6 Cutoff Walls

A cutoff wall is required in all culverts with invert slabs to prevent water from undermining the culvert. The cutoff wall should be a minimum 24 inches below the bottom of the invert slab or to the top of sound rock if the rock is closer. For culverts founded on highly permeable soils or with significant hydraulic gradients, the designer should investigate the need for deeper cutoff walls. The cutoff wall may also act to stiffen the bottom slab for skewed box culverts.

Cutoff walls must always be specified at each end of the barrel. When a concrete apron is provided, show an additional cutoff wall at the end of the apron. For three-sided culverts, where the apron is made continuous with the barrel invert slab, the cutoff wall is only required at the end of the apron. The wingwall footings should have toe walls extending close to the bottom of the cutoff wall to prevent scour around the edges of the cutoff wall.

When a precast culvert is specified, the cutoff wall must cast-in-place and the cost should be included in the cost of the culvert barrel. No separate item is required but the estimated concrete and reinforcing steel quantities should be included in the contract plans.

33.7 Aprons

Box culverts can significantly increase the stream flow velocity because the concrete has a roughness coefficient significantly lower (i.e., smoother) than the streambed and banks. To dissipate this increase in energy and to prevent scour, a riprap rubble or other type of revetment apron may be required at the ends of some culverts. The District Drainage Engineer should be consulted to determine the appropriate apron requirements.

Modification for Non-Conventional Projects:

Delete the last sentence in above paragraph and see RFP for requirements.

When a precast culvert is specified with a concrete apron, the apron must be cast-in-place and the cost should be included in the cost of the culvert barrel. No separate item is required but the estimated concrete and reinforcing steel quantities should be included in the contract plans.

Modification for Non-Conventional Projects:

Delete the above paragraph and replace with the following:

When a precast culvert is specified with a concrete apron, the apron must be cast-in-place.

33.8 Subbase Drainage

In some situations where there is low fill (< 12 inches below the base course) **Design Standards, Index 289** requires additional friable base or coarse aggregate material above the top and along the sides of the culvert to eliminate maintenance problems.

33.9 Joint Waterproofing

Culverts will occasionally be used to allow the passage of things other than water, including but not limited to pedestrians, bicycles, trains, golf carts, wildlife, or farm animals. In cases where it is desirable to have a dry environment, a waterproof joint wrap should be used to cover the joints between precast culvert units or to cover the construction joints in cast-in-place culverts.

Even though a joint sealer is always placed between individual precast concrete culvert units and the units are pulled tightly together, water may seep through the joint. The minimum requirement for waterproofing these joints is to provide an external sealing band in accordance with **ASTM C 877**, centered on the joints, covering the top slab, and then extending down the sidewalls to the footing. The purpose of the waterproofing membrane is to restrict seepage of water or migration of backfill material through the joints in the culverts and it is not intended to protect the concrete.

The external sealing band is mandatory for precast three-sided culverts under **Section 407** of the **Specifications for Road and Bridge Construction** but will need to be included as a note in the contract plans when required for box culverts.

33.10 Traffic Railings

For information regarding roadside barriers refer to **Chapter 4** of this Volume. Any roadside barriers placed at a Box or Three-Sided Culvert should be either W-Beam Guardrail or Bridge Traffic Railing. Barriers placed in conjunction with Box or Three-Sided Culverts must either meet **NCHRP 350** TL-3 criteria for semi-rigid barriers or a rigid traffic railing designed to meet **AASHTO LRFD** TL-4 criteria. See **Chapter 6** of the **Structures Design Guidelines** for more information.

W-Beam Guardrail is the preferred barrier option, provided the grading, post embedment and Length of Need requirements included in **Design Standards, Index 400** can be met. A minimum of 4 feet of fill must be provided over the culvert for adequate post embedment and performance. If there is less than 4 feet of fill over the culvert, utilize one of the following options:

1. Culverts with total outside widths ≤ 5 feet: use W-Beam Guardrail with a post layout that straddles the outside of the culvert using standard post spacing of 6'-3".
2. Culverts with total outside width between 5 feet and 20 feet: use shortened W-Beam guardrail posts (i.e. *Encased Post for Shallow Mount*). See **Design Standards, Index 400**.
3. Culverts with total outside width > 20 feet: use a project specific designed metal traffic railing similar to the Thrie-Beam Retrofit barriers (i.e. thrie-beam railing attached directly to the culvert headwall), see the **Design Standards, Index 470 Series**. Designers should note that the locations of the first and last posts are critical. Headwalls must be a minimum of 18 inches wide and the base plate must be located so that it is located at least 12 inches away from any construction joint or free end of the concrete headwall. Placement of base plates and bolts in the top slab should be avoided because they are difficult to repair/maintain, the necessary anchor embedment lengths are problematic to obtain, and they are potentially damaging to the top of the culvert barrel.

Concrete rigid barrier/traffic railing is generally not recommended due to the short length of culverts, unless continued along the roadway for other reasons. However, for some conditions a concrete barrier may be the most practical design option.

33.11 Design Requirements for Concrete Culverts

Refer to the **Chapter 3** of the **Structures Design Guidelines** for design and analysis requirements.

33.12 Design Details

When a box concrete culvert is proposed for a site, the designer is required to provide a complete cast-in-place design for the contract plans. Standard details for concrete box culverts are provided in the **Design Standards, Index 289**. The contractor is usually permitted to substitute precast concrete box culverts for cast-in-place box culverts in accordance with **Section 410** of the **Specifications for Road and Bridge Construction**. The contractor may select a standard precast box culvert design in accordance with **Design Standards, Index 292** or provide a custom design. Design and fabrication details for precast box culverts, including calculations for custom designs, must also comply with the requirements of **Design Standards, Index 291** and be submitted to the Engineer of Record for approval.

When a three-sided concrete culvert is proposed for a site, the designer is required to provide either a complete cast-in-place design or a conceptual precast barrel design with a complete foundation and wingwall design, for the contract plans. The contractor is permitted to substitute precast three-sided culverts for cast-in-place three-sided culverts in accordance with **Section 407** of the **Specifications for Road and Bridge Construction**. Design and fabrication details for precast three-sided culverts, including calculations, must be submitted to the Engineer of Record for approval. Do not place wildlife shelves in hydraulic structures.

The bar designations in **Table 33.1** should be used for box culvert reinforcement:

Table 33.1 Bar Identification Schedule

BAR IDENTIFICATION SCHEDULE		
C.I.P (LRFD) Index 289	Precast (LRFD) Index 292	Description / Bar Location
105	As1	Top Corner Bars
106	As1	Bottom Corner Bars
102	As2	Top Slab, inside face transverse bars
103	As3	Bottom Slab, inside face transverse bars
101	As1/As7	Top Slab, outside face transverse bars
104	As1/As8	Bottom Slab, outside face transverse bars
108	As4	Exterior wall, inside face vertical bars
105/106	As1	Exterior wall, outside face vertical bars
107	-	Interior wall, vertical bars both faces
110/111	As6/As9	Top Slab longitudinal bars (temperature reinf.)
109/112	As9	Bottom Slab longitudinal bars (temperature reinf.)
113/114		Exterior wall longitudinal bars (temperature reinf.)
115/ 116...		Interior wall longitudinal bars (temperature reinf.)
111	As5	Top Slab inside face longitudinal bars (design distribution reinforcement)

Additional reinforcing bars and designations must be added as required. No standardized bar designations are provided for three-sided culverts.

Modification for Non-Conventional Projects:

Delete *PPM* 33.12 and replace with the following:

33.12 Design Details

Provide complete details for the proposed concrete culvert in the contract plans.

33.13 Computer Design and Analysis Programs

For LRFD designs the Department's **LRFD Box Culvert Program** (Mathcad) is available from the Structures Design Office website. This program analyzes monolithic single or multi-barrel box culverts with prismatic members and integral bottom slabs only. The program requires input by the designer for all member thicknesses, material properties and reinforcing area utilizing a trial and error design methodology.

Other computer programs are available for design of reinforced concrete culverts such as BOXCAR and CANDE. Generally these other computer programs should only be used for preliminary designs or independent quality assurance checks. Designers should consult with the State Structures Design Office before using one of these other programs in lieu of the FDOT box culvert program.

33.14 Design and Shop Drawing Approvals

The Engineer of Record for the contract plans has design and shop drawing approval authority for precast concrete box and three-sided culverts. All calculations and shop drawings require a quality assurance review for general compliance of contract requirements and for suitability of the design for the given design conditions.

Standard precast concrete box culvert designs are available in **Design Standards, Index 292** for a limited number of box culvert sizes. Modification of FDOT standard box culverts or design of special size box or three-sided culverts is delegated to Contractor's Engineer of Record in accordance with the **Section 407** and **Section 410** of the **Specifications for Road and Bridge Construction**. The Contractor is responsible for providing all design computations and details for these units.

Modification for Non-Conventional Projects:

Delete **PPM 33.14** and replace with the following:

33.14 Design and Shop Drawing Approvals

The Engineer of Record for the contract plans has shop drawing approval authority for precast concrete box and three-sided culverts.

Chapter 34

Monitor Existing Structures

34.1	General	34-1
34.2	Inspection and Settlement Monitoring	34-1
34.2.1	Miscellaneous Structures	34-1
34.2.2	Structures other than Miscellaneous Structures	34-2
34.2.3	Roadway Compaction Operations	34-2
34.3	Vibration Monitoring	34-3
34.4	Groundwater Monitoring.....	34-3

THIS PAGE LEFT BLANK INTENTIONALLY

Chapter 34

Monitor Existing Structures

Modification for Non-Conventional Projects:

Delete *PPM* Chapter 34 and see RFP for requirements.

34.1 General

Monitor Existing Structures includes settlement, vibration, and groundwater monitoring of existing structures during construction as described in **Section 108** of the **FDOT Specifications**. In general, structures requiring consideration for monitoring include buildings, bridges, and retaining walls which are adjacent to construction activities. When there is a concern regarding vibration, structures to be monitored may also include historic features and buildings in which sensitive business operations are conducted (e.g. eye surgery, medical treatments, rehabilitation operations, recording and broadcasting operations, places of worship, antique shops, or museums).

When appropriate, include a note on the General Notes Sheet that:

- Restricts hours of construction operations.
- Restricts the type of construction equipment to be used.

Pay item 108-1 is to be used when there is a potential for major damage occurring to an existing structure of concern which would require repairs. Pay item 108-2 is typically to be used when there is a potential for making the existing internal use of a structure of concern infeasible during construction operations and will typically be for non-residential properties.

34.2 Inspection and Settlement Monitoring

34.2.1 Miscellaneous Structures

In general, activities that may cause harm to existing structures include the construction of foundations for mast arm signal poles, strain poles, cantilever signs, overhead truss signs, high mast light poles and ITS.

Based on visual field observations, the EOR will identify existing structures of concern that are recommended to be monitored during these activities. The Department will make the final determination of the existing structures to be monitored. If a determination is made to monitor a structure, include pay item 108-1 in the Summary of Monitor Existing Structures summary box and list the structure as illustrated in **PPM Volume 2 Exhibit SQ-1**.

34.2.2 Structures other than Miscellaneous Structures

In general, activities that may cause harm to existing structures include the construction of retaining walls, noise walls, sheet pile walls, deep excavations and foundations for bridges and other structures.

- a. If any existing structure of concern is within the distances specified in **Article 108-2** of the **FDOT Specifications**, include pay item 108-1 in the Summary of Monitor Existing Structures summary box. Use a distance of 250 feet as the limit for pile driving. Do not list or identify these structures in the Contract Plans.
- b. Based on visual field observations, the EOR will identify existing structures of concern located beyond the distances specified in **Article 108-2** that are recommended to be monitored during these activities. The Department will make the final determination of the existing structures to be monitored. If a determination is made to monitor a structure, include pay item 108-1 in the Summary of Monitor Existing Structures summary box and list the structure as illustrated in **PPM Volume 2 Exhibit SQ-1**.

34.2.3 Roadway Compaction Operations

In general, activities that may cause harm to existing structures include embankment and asphalt vibratory compaction.

- a. If an existing structure is within the distances specified in **Article 108-2** of the **FDOT Specifications**, include pay item 108-1 in the Summary of Monitor Existing Structures summary box. Do not list or identify these structures in the Contract Plans.
- b. Based on visual field observations, the EOR will identify existing structures of concern located beyond the distances specified in **Article 108-2** that are recommended to be monitored during these activities. The Department will make the final determination of the existing structures to be monitored. If a determination is made to monitor a

structure, include pay item 108-1 in the Summary of Monitor Existing Structures summary box and list the structure as illustrated in ***PPM Volume 2 Exhibit SQ-1***.

34.3 Vibration Monitoring

In general, activities that may cause harm to existing structures include pile driving, sheet pile and casing installation, and embankment and asphalt vibratory compaction.

Based on visual field observations, the EOR will identify existing structures of concern that are recommended to be monitored during these activities. The Department will make the final determination of the existing structures to be monitored. If a determination is made to monitor a structure, include pay item 108-2 in the Summary of Monitor Existing Structures summary box and list the structure as illustrated in ***PPM Volume 2 Exhibit SQ-1***.

34.4 Groundwater Monitoring

Based on visual field observations, the EOR will identify existing structures of concern that are recommended to be monitored during anticipated dewatering operations. The Department will make the final determination of the existing structures to be monitored. If a determination is made to monitor a structure, include pay item 108-3 in the Summary of Monitor Existing Structures summary box and list the structure as illustrated in ***PPM Volume 2 Exhibit SQ-1***.

THIS PAGE LEFT BLANK INTENTIONALLY