

Chapter 2

Design Geometrics and Criteria

2.0	General	2-1
2.0.1	Railroad-Highway Grade Crossing Near or Within Project Limits	2-3
2.1	Lanes	2-8
2.1.1	Through or Travel Lanes.....	2-8
2.1.2	Other Lane Widths	2-10
2.1.3	Ramp Traveled Way Widths	2-11
2.1.4	Pedestrian, Bicycle and Public Transit Facilities	2-11
2.1.4.1	Pedestrian Facilities.....	2-11
2.1.4.2	Bicycle Facilities.....	2-12
2.1.4.3	Public Transit Facilities	2-12
2.1.5	Cross Slopes.....	2-13
2.1.6	Roadway Pavement.....	2-16
2.1.6.1	Alternative Roadway Paving Treatments.....	2-16
2.1.6.2	Maintenance Memorandum of Agreement Requirements for Patterned Pavement	2-18
2.1.7	Transitions of Pavement Widths	2-20
2.1.8	Number of Lanes on the State Highway System	2-20
2.2	Medians.....	2-21
2.2.1	Median Width for Roadways	2-21
2.2.2	Multilane Facility Median Policy	2-22
2.2.3	Median Treatments on Bridges	2-22
2.3	Shoulders	2-23
2.3.1	Limits of Friction Course on Paved Shoulders	2-31

2.3.2	Shoulder Warning Devices (Rumble Strips).....	2-31
2.3.3	Use of Curb on High Speed Roadways	2-32
2.4	Roadside Slopes	2-33
2.5	Borders.....	2-35
2.5.1	Limited Access Facilities	2-38
2.6	Grades	2-39
2.7	Sight Distance	2-42
2.8	Curves.....	2-44
2.8.1	Horizontal Curves.....	2-44
2.8.1.1	Supplemental Alignment Control (Mainline)	2-44
2.8.1.2	Supplemental Alignment Control (Intersections)	2-49
2.8.1.3	Roadway Transitions	2-49
2.8.2	Vertical Curves.....	2-50
2.9	Superelevation	2-52
2.10	Vertical Clearance	2-58
2.10.1	Vertical Clearance Over Water	2-66
2.10.2	Horizontal Waterway Clearance.....	2-67
2.10.3	Regulatory Agency Requirements	2-67
2.10.4	Airspace Obstructions	2-68
2.11	Horizontal Clearance.....	2-70
2.12	Bridge Railings and Separators.....	2-79
2.13	Intersections	2-92
2.13.1	Roundabouts.....	2-92

2.13.2	Queue Length for Unsignalized Intersections	2-92
2.13.3	Offset Left Turn Lanes	2-93
2.14	Interchanges and Median Openings/Crossovers	2-95
2.14.1	Limited Access Right of Way Limits at Interchanges	2-95
2.14.2	Median Openings at Interchanges	2-96
2.14.3	Ramp Widths.....	2-96
2.14.4	Crossovers on Limited Access Facilities	2-98
2.15	Lighting Criteria	2-104
2.16	High-Speed Urban and Suburban Arterial Highways	2-104
2.16.1	Design Speed	2-106
2.16.2	Curbs	2-106
2.16.3	Pedestrian and Bicycle Facilities.....	2-106
2.16.4	Medians	2-106
2.16.5	Shoulders	2-107
2.16.6	Friction Course.....	2-107
2.16.7	Border Width	2-107
2.16.8	Grades	2-107
2.16.9	Horizontal Curves.....	2-108
2.16.10	Superelevation	2-108
2.16.11	Horizontal Clearance.....	2-109

Tables

Table 2.1.1	Lane Widths	2-8
Table 2.1.2	Lane Widths - Special	2-10
Table 2.1.3	Ramp Widths.....	2-11
Table 2.1.4	Maximum Algebraic Difference in Cross Slope at Turning Roadway Terminals	2-15

Table 2.2.1	Median Widths	2-21
Table 2.3.1	Shoulder Widths and Cross Slopes - Freeways.....	2-24
Table 2.3.2	Shoulder Widths and Cross Slopes - Arterials Divided	2-25
Table 2.3.3	Shoulder Widths and Cross Slopes - Arterials Undivided	2-26
Table 2.3.4	Shoulder Widths and Cross Slopes - Collectors Divided and Undivided	2-27
Table 2.4.1	Roadside Slopes	2-34
Table 2.5.1	Highways with Flush Shoulders	2-36
Table 2.5.2	Highways with Curb or Curb and Gutter in Urban Areas	2-37
Table 2.5.3	Limited Access Facilities	2-38
Table 2.6.1	Maximum Grades.....	2-40
Table 2.6.2	Maximum Change in Grade Without Vertical Curves ...	2-40
Table 2.6.3	Criteria for Grade Datum.....	2-41
Table 2.6.4	Grade Criteria for Curb and Gutter Sections.....	2-41
Table 2.7.1	Minimum Stopping Sight Distance	2-42
Table 2.7.2	Minimum Passing Sight Distance.....	2-43
Table 2.8.1a	Maximum Deflections without Horizontal Curves.....	2-46
Table 2.8.1b	Maximum Deflection for Through Lanes through Intersections.....	2-46
Table 2.8.2a	Length of Horizontal Curves.....	2-47
Table 2.8.2b	Arc Length (in feet) of Compound Curves with One-Half/Double Radii - Turning Roadways	2-47
Table 2.8.3	Maximum Curvature of Horizontal Curve (Using Limiting Values of "e" and "f")	2-48
Table 2.8.4	Maximum Horizontal Curvature Using Normal Cross Slopes (-0.02)	2-48

Table 2.8.5	Minimum Lengths of Crest Vertical Curves Based on Stopping Sight Distance.....	2-50
Table 2.8.6	Minimum Lengths of Sag Vertical Curves Based on Stopping Sight Distance and Headlight Sight Distance	2-51
Table 2.9.1	Superelevation Rates for Rural Highways, Urban Freeways and High Speed Urban Highways ($e_{max} = 0.10$)	2-53
Table 2.9.2	Superelevation Rates for Urban Highways and High Speed Urban Streets ($e_{max} = 0.05$)	2-55
Table 2.9.3	Superelevation Transition Slope Rates for Rural Highways, Urban Freeways and High Speed Urban Highways.....	2-57
Table 2.9.4	Superelevation Transition Slope Rates for Urban Highways and High Speed Urban Streets.....	2-57
Table 2.10.1	Minimum Vertical Clearances for New Bridges	2-65
Table 2.10.2	Minimum Vertical Clearances for New Sign and Signal Structures.....	2-65
Table 2.10.3	FAA Notification Requirements	2-69
Table 2.11.1	Horizontal Clearance for Traffic Control Signs	2-71
Table 2.11.2	Horizontal Clearance for Light Poles.....	2-71
Table 2.11.3	Horizontal Clearance for Aboveground Fixed Utilities (AFUs)	2-72
Table 2.11.4	Horizontal Clearance to Traffic Infraction Detectors, Signal Poles and Controller Cabinets for Signals	2-73
Table 2.11.5	Horizontal Clearance to Trees	2-73
Table 2.11.6	Horizontal Clearance to Bridge Piers and Abutments ...	2-74
Table 2.11.7	Horizontal Clearance to Railroad Grade Crossing Traffic Control Devices.....	2-75
Table 2.11.8	Horizontal Clearance to Canal and Drop-off Hazards...	2-75

Table 2.11.9	Horizontal Clearance to Other Roadside Obstacles	2-75
Table 2.11.10	Horizontal Clearance for ITS Poles and Related Items	2-76
Table 2.11.11	Recoverable Terrain.....	2-77
Table 2.14.1	Ramp Widths - Turning Roadways	2-97

Figures

Figure 2.0.1	Partial Bridge Sections *	2-4
Figure 2.0.2	Bridge Section *	2-5
Figure 2.0.3	Partial Bridge Sections *	2-6
Figure 2.0.4	Bridge Section *	2-7
Figure 2.1.1	Standard Pavement Cross Slopes.....	2-14
Figure 2.3.1.A	Shoulder Superelevation.....	2-28
Figure 2.3.1.B	Special Shoulder Superelevation	2-29
Figure 2.3.2	Typical Paving Under Bridge.....	2-30
Figure 2.9.1	Superelevation Rate For Rural Highways, Urban Freeways and High Speed Urban Highways ($e_{max} = 0.10$)	2-54
Figure 2.9.2	Superelevation Rates for Urban Highways and High Speed Urban Streets ($e_{max} = 0.05$)	2-56
Figure 2.10.1	Clearances – Rural and Urban Interstates (Freeways), Arterials and Collectors, with Projected 20-Year ADT of 1500 or Greater	2-59
Figure 2.10.2	Clearances – Rural Arterials and Collectors with Projected 20-Year ADT of Less than 1500	2-60
Figure 2.10.3	Clearances – Urban Arterials and Collectors (Without Curb and Gutter) with Projected 20-Year ADT of Less than 1500.....	2-61

Figure 2.10.4.A	Clearances – Urban Arterials and Collectors (Curb and Gutter) ≤ 45 mph– Elevation of Bridge.....	2-62
Figure 2.10.4.B	Clearances – Urban Arterials and Collectors (Curb and Gutter) ≤ 45 mph– Section through Bridge.....	2-63
Figure 2.10.5	Clearances – Urban Arterials and Collectors (Curb and Gutter) with Traffic Barrier	2-64
Figure 2.11.1	Horizontal Clearance to Guardrail.....	2-78
Figure 2.12.1	Bridge Traffic Railings – "F" Shapes.....	2-80
Figure 2.12.2	Bridge Traffic Railings – Vertical Shapes	2-81
Figure 2.12.3	Bridge Traffic Railings – Other Shapes.....	2-82
Figure 2.12.4	Bridge Traffic Railings – Noise Barrier Combination.....	2-83
Figure 2.12.5	Bridge Railing and Separators – Median Traffic Railing and Separators	2-84
Figure 2.12.6	Bridge Fencing for Traffic Railings.....	2-85
Figure 2.12.7	Bridge Railing – Pedestrian / Bicycle Railing	2-86
Figure 2.12.8	Bridge Railing – Pedestrian / Bicycle Railing	2-87
Figure 2.12.9	Bridge Railing – Pedestrian / Bicycle Railing	2-88
Figure 2.12.10	Bridge Railing – Pedestrian / Bicycle Retrofit Railing....	2-89
Figure 2.12.11	Bridge Fencing for Pedestrian Railing.....	2-90
Figure 2.12.12	Enclosed Bridge Fencing for Pedestrian Railing.....	2-91
Figure 2.13.1	Typical Opposing Left Turns (22' Median with Negative 10' Offset)	2-93
Figure 2.13.2	Typical Opposing Left Turns (22' Median with Negative 1' Offset)	2-94
Figure 2.13.3	Left Turn Offset Guidelines	2-94
Figure 2.14.1	Crossovers on Limited Access Facilities – 6 or More Lanes.....	2-101
Figure 2.14.2	Crossovers on Limited Access Facilities – 4 Lanes....	2-102

Figure 2.14.3	Median Barrier Opening for Crossovers on Limited Access Facilities.....	2-103
Figure 2.16.1	Four-Lane High-Speed Urban and Suburban Section.....	2-105
Figure 2.16.2	Six-Lane High-Speed Urban and Suburban Section.....	2-105
Figure 2.16.3	Superelevation Rates for High-Speed Urban and Suburban Sections.....	2-108

Chapter 2

Design Geometrics and Criteria

2.0 General

The implementation of design criteria is outlined in the following text.

1. **Design Criteria:** The design criteria presented in this manual are intended as the principal source of criteria for the design of new construction or major reconstruction projects on the Florida State Highway System.

These criteria are presented by subject for major design elements as fixed values or a range of acceptable values as defined by qualifiers.

Where design criteria appear in the **Design Standards**, they will be consistent with the criteria in this manual. In addition, some criteria will remain in the other chapters of this manual. When conflicts are discovered, they should be brought to the attention of the State Roadway Design Engineer or State Structures Design Engineer, as applicable, for resolution.

Modification for Non-Conventional Projects:

Delete the last sentence of the above paragraph and replace with the following:
Where conflicts exist, the EOR shall select the criteria proven to result in better safety performance.

On reconstruction projects, existing project features which were constructed to meet minimum metric design criteria, but are mathematically slightly less than equivalent minimum English design criteria, do not require Design Exceptions or Design Variations to remain.

Design criteria for Resurfacing, Restoration, and Rehabilitation (RRR) are presented in **Chapter 25** of this volume and are applicable only on programmed RRR projects.

Modification for Non-Conventional Projects:

Delete the sentence above and see RFP for requirements.

Facilities on the Strategic Intermodal System (SIS) are subject to special standards and criteria for number of lanes, design speed, access, level of service and other requirements.

SIS and Emerging SIS Highway Intermodal Connectors on the State Highway System (SHS) shall be designed in accordance with the SIS criteria contained in this manual. SIS and Emerging SIS Highway Intermodal Connectors on the local system (non-SHS) should also be designed in accordance with the SIS criteria contained in this manual, but the District may allow the use of the **Manual of Uniform Minimum Standards for Design, Construction and Maintenance for Streets and Highways** (commonly known as the "[Florida Greenbook](#)"), **Topic No. 625-000-015** depending on project specifics, with approval by the District Design Engineer.

Modification for Non-Conventional Projects:

Delete the last sentence of the above paragraph and see RFP for requirements.

Design Criteria for roads that are not part of the State Highway System should be obtained from the **Florida Greenbook**.

Modification for Non-Conventional Projects:

Delete the last sentence.

2. **Design Controls:** Design controls are characteristics and conditions that influence or regulate the selection of the criteria for project standards. It is the designer's responsibility to recognize and apply those controls applicable to the project.
3. **Design Standards:** The specific values selected from the design criteria become the design standards for a design project. These standards will be identified and documented by the designer.
4. **Project Parameters:** The properties or specific conditions with limits which require modification of design standards within these limits. The designer is responsible for establishing and documenting any project parameters and their limits, as part of the justification for deviations from project standards.

Modification for Non-Conventional Projects:

Delete the last sentence of the above paragraph.

Many design standard considerations are related directly to the design speed, including vertical and horizontal geometry and required sight distances. The minimum design values are very closely related to traffic safety and cannot be compromised without an approved Design Exception or Design Variation. See **Chapter 23** of this volume.

Public facilities constructed or funded by FDOT (parking garages, weigh stations, operation centers, park & ride facilities, etc.) shall comply with the criteria in this manual, **FDOT Design Standards**, and other applicable Department manuals. Roads not on the State Highway System which are impacted by the construction of these public facilities should also be designed in accordance with Department criteria and standards, but the District may allow the use of the **Florida Greenbook** depending on project specifics.

Modification for Non-Conventional Projects:

Delete the last sentence of the above paragraph.

Roadway and bridge typical sections developed for projects must reflect the values and properties outlined in Items 1 - 4 of this section. These typical sections shall include the location and limits of such features as lanes, medians, shoulders, curbs, sidewalks, barriers, railings, etc.. **Section 16.2.3** of this volume gives the requirements for approval and concurrence of typical section packages.

Coordination is of primary importance on projects that contain both roadway and bridge typical sections. The Roadway and Structures Offices must address the compatibility of the typical section features mentioned above, and provide for an integrated design and review process for the project.

Example roadway typical sections are included in the exhibits in **Volume 2, Chapter 6**. Partial bridge sections, **Figures 2.0.1 - 2.0.4**, provide criteria regarding lanes, medians, and shoulders for various facilities. Subsequent sections of this chapter contain specific information and criteria regarding these and other typical section elements, as well as geometric features of both roadways and bridges.

2.0.1 Railroad-Highway Grade Crossing Near or Within Project Limits

Federal-aid projects must be reviewed to determine if a railroad-highway grade crossing is in or near the limits of the project. If such railroad-highway grade crossing exists, the project must be upgraded in accordance with **Section 6.2.3**.

Figure 2.0.1 Partial Bridge Sections *

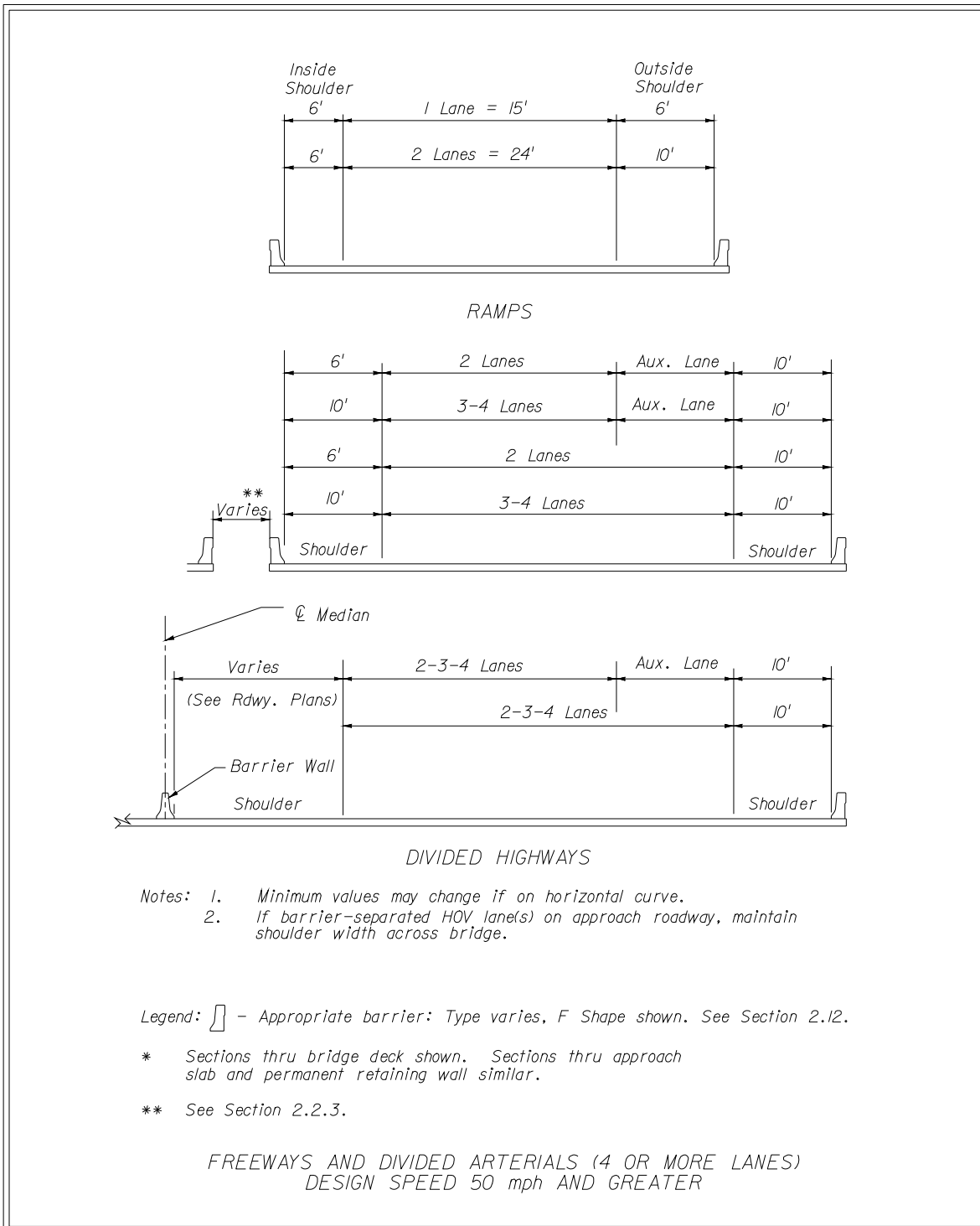

Figure 2.0.2 Bridge Section *

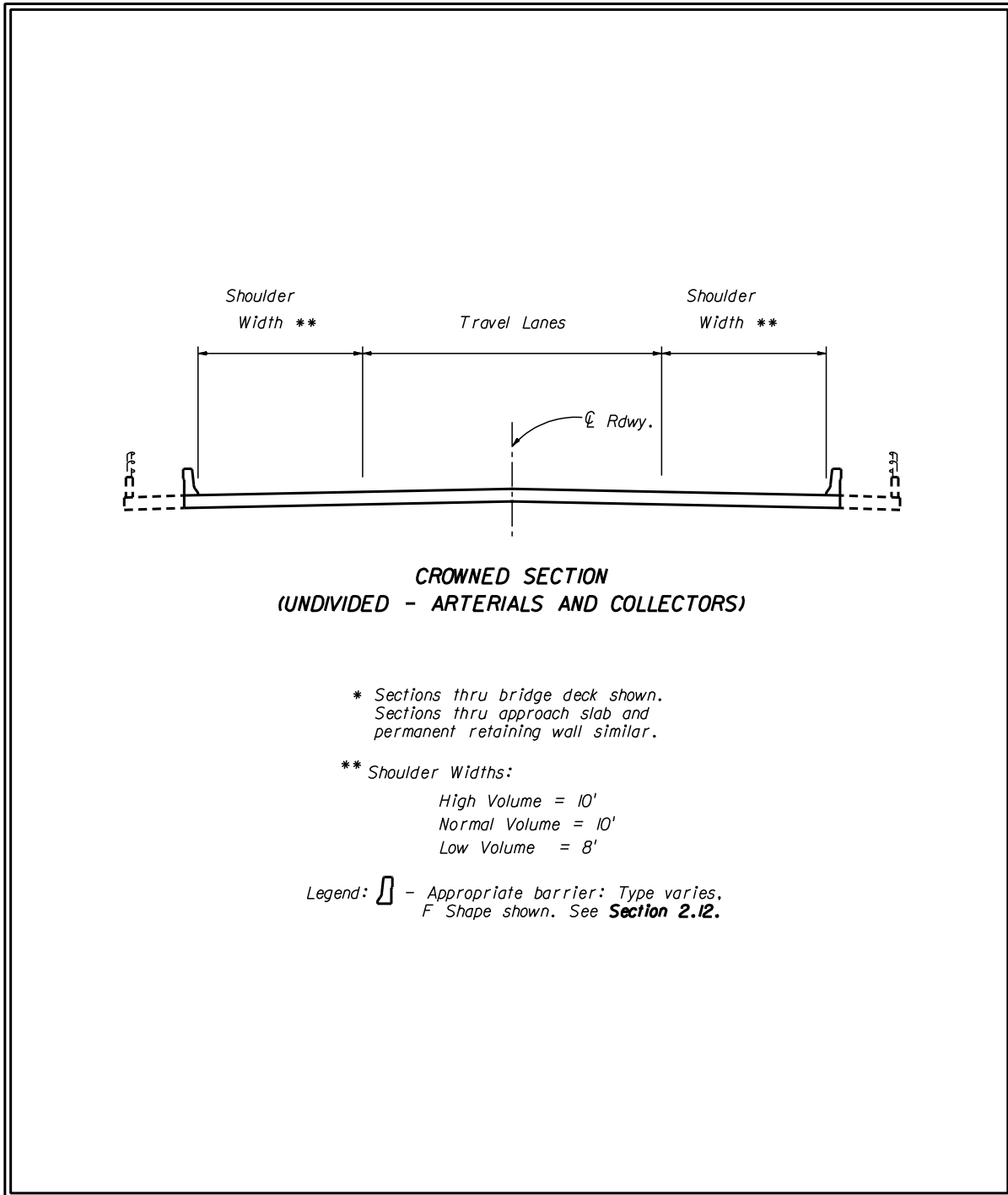

Figure 2.0.3 Partial Bridge Sections *

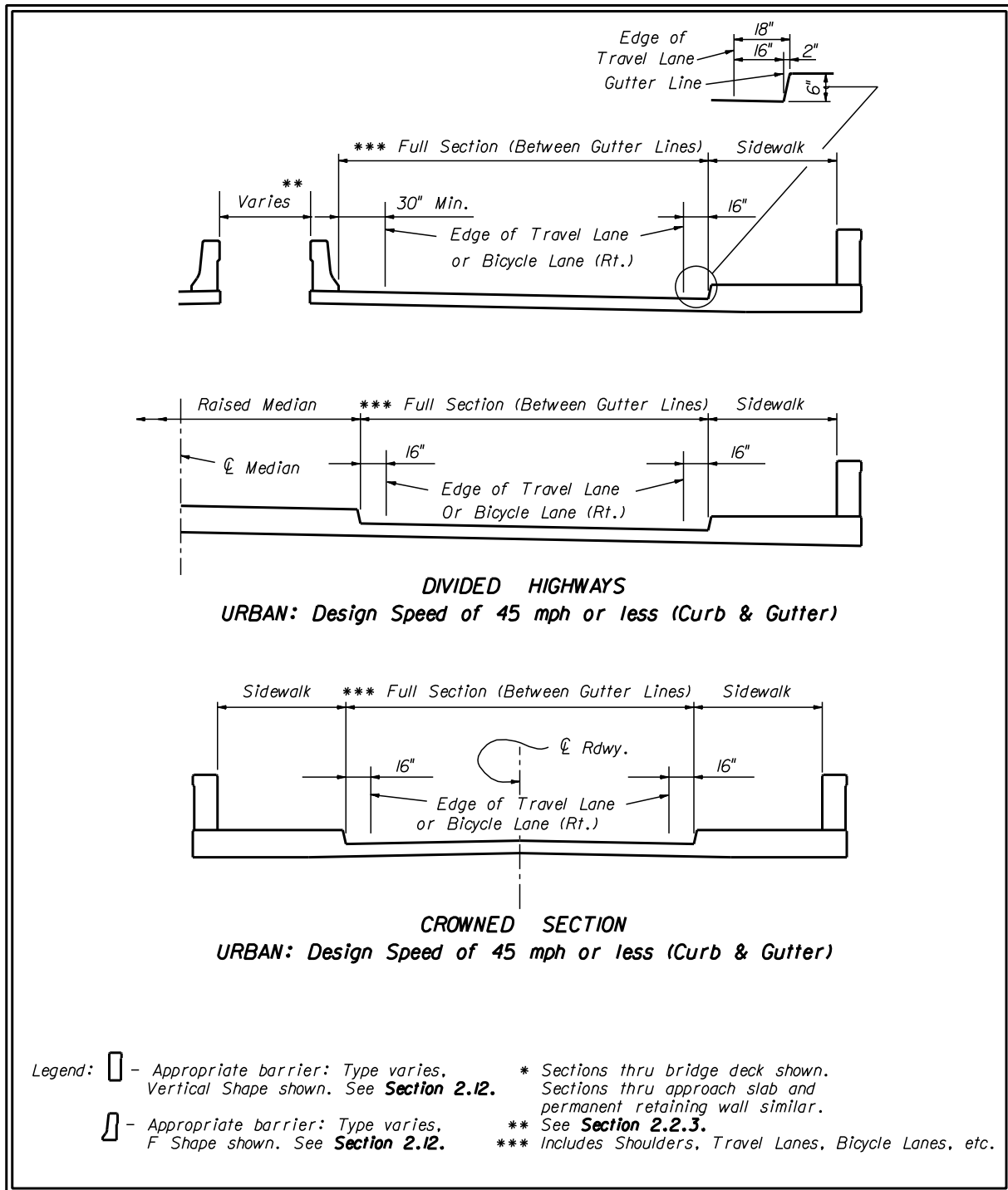
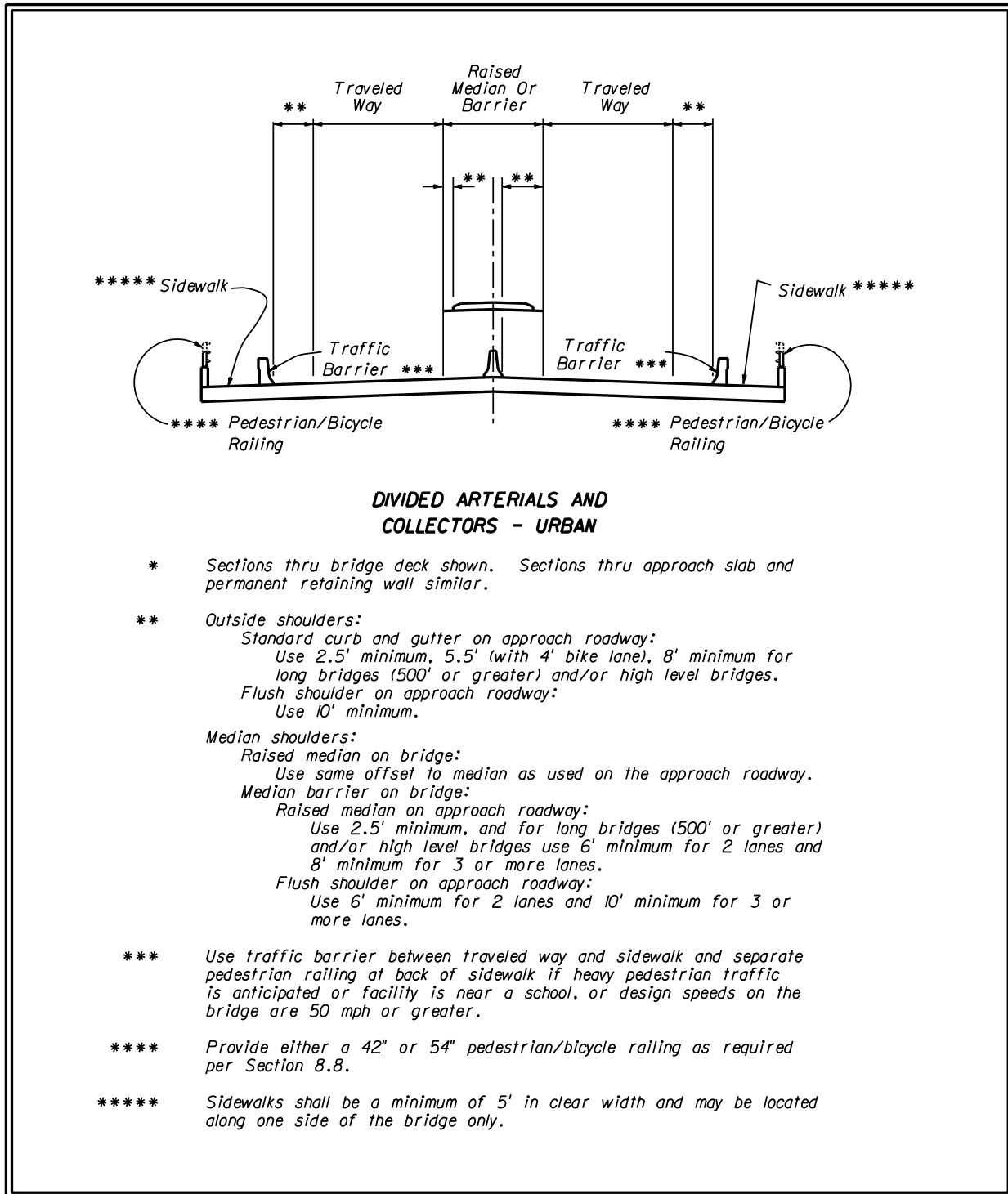

Figure 2.0.4 Bridge Section *



2.1 Lanes

Florida Department of Transportation (FDOT) criteria for lane widths and pavement slopes are given by highway type and area, through lanes, auxiliary lanes and other special lanes.

2.1.1 Through or Travel Lanes

Standard practice is to provide lane widths as wide as practical, up to 12 feet. See **Table 2.1.1**.

Table 2.1.1 Lane Widths

LANE WIDTHS (FEET)						
FACILITY		THROUGH OR TRAVEL	AUXILIARY			
TYPE	AREA		SPEED CHANGE	TURNING (LT/RT/MED)	PASSING	CLIMBING
FREEWAY	Rural	12	12	----	----	12
	Urban	12	12	----	----	12
ARTERIAL	Rural	12	12	12	12	12
	Urban	12 ₁	12 ₁	12 _{1,4}	12 ₁	12
COLLECTOR	Rural	12 ₆	11 ₂	11 _{2,4}	11 _{2,5}	12
	Urban	11 ₃	11 ₃	11 _{3,4}	11 ₃	12

1. 11 ft. permitted on non-SIS roads if one of these conditions exist:
 - a. R/W and existing conditions are stringent controls
 - b. Facility operates on interrupted flow conditions
 - c. Design speed 40 mph or less
 - d. Intersection capacity not adversely affected
 - e. Truck volume 10% or less
2. 12 ft. lanes for all 2-lane rural.
3. 12 ft. lanes in industrial areas when R/W is available.
4. With severe R/W controls, 10 ft. turning lanes may be used where design speeds are 40 mph or less and the intersection is controlled by traffic signals. Median turn lanes shall not exceed 15 ft.
5. 12 ft. when truck volume more than 10%.
6. 11 ft. for low volume AADT.

Modification for Non-Conventional Projects:						
Delete PPM Table 2.1.1 and replace with the following:						
LANE WIDTHS (FEET)						
FACILITY		THROUGH OR TRAVEL	AUXILIARY			
TYPE	AREA		SPEED CHANGE	TURNING (LT/RT/MED)	PASSING	CLIMBING
FREEWAY	Rural	12	12	----	----	12
	Urban	12	12	----	----	12
ARTERIAL	Rural	12	12	12	12	12
	Urban	12	12	12	12	12
COLLECTOR	Rural	12	11	11	11	12
	Urban	12	11	11	11	12

2.1.2 Other Lane Widths

Collector-distributor lanes and auxiliary lanes for speed change, turning, storage for turning, weaving and other purposes supplementary to through-traffic movement should be of the same width as the through lanes. See **Table 2.1.2**.

Table 2.1.2 Lane Widths - Special

LANE WIDTHS (FEET)					
FACILITY		SPECIAL			
TYPE	AREA	HOV ₁	BICYCLE	OFF SYSTEM DETOUR	URBAN MULTI- PURPOSE ₄
FREEWAY	Rural	12	----	11 ₃	----
	Urban	12	----	11 ₃	----
ARTERIAL	Rural	12	5	11	----
	Urban	12	4 ₂	11	8 ₅
COLLECTOR	Rural	----	5	11	----
	Urban	----	4 ₂	11	8 ₅

1. Separated or concurrent flow.
2. A minimum width of 5 feet shall be provided when the bicycle lane is adjacent to on-street parking, a right-turn lane, guardrail or other barrier. See **Section 8.4** of this volume.
3. For Freeway detours, at least one 12 ft. lane must be provided in each direction.
4. Urban multi-purpose lanes are usually used as refuge lanes but may be used for loading zones, bus stops, emergency access and other purposes. Parking that adversely impacts capacity or safety is to be eliminated whenever practical. Standard parking width is measured from face of curb, with a minimum width of 8 ft..
5. 10 ft. to 12 ft. lanes for commercial and transit vehicles.

Modification for Non-Conventional Projects:

Delete the second sentence in footnote 4 and delete footnote 5 in **PPM** Table 2.1.2 above and see RFP for requirements.

2.1.3 Ramp Traveled Way Widths

Ramp widths for tangent and large radii (500 ft. or greater) sections are given in **Table 2.1.3**. Ramp widths in other areas such as terminals are controlled by the curvature and the vehicle type selected as the design control and are given in **Table 2.14.1, Ramp Widths**. Typical details for ramp terminals are provided in the **Design Standards**.

Table 2.1.3 Ramp Widths

RAMP WIDTHS (RAMP PROPER) FOR TANGENT AND LARGE RADII (≥ 500 ft.) SECTIONS	
ONE LANE RAMPS	15 ft.
TWO LANE RAMPS	24 ft.

For ramp widths at turning roadways see **Table 2.14.1**.

2.1.4 Pedestrian, Bicycle and Public Transit Facilities

2.1.4.1 Pedestrian Facilities

Sidewalks and pedestrian crossings shall be considered on all projects. Although the standard sidewalk width is 5 feet, it may be desirable to create wider sidewalks in business districts, near schools, transit stops, or where there are other significant pedestrian attractors. The District Pedestrian/Bicycle Coordinator shall be consulted during planning and design to establish appropriate pedestrian elements on a project-by-project basis. **Chapter 8** of this volume contains additional criteria for the accommodation of pedestrians.

Modification for Non-Conventional Projects:

Delete the above paragraph and replace with:

The standard sidewalk width is 5 feet. **Chapter 8** of this volume contains additional criteria for the accommodation of pedestrians.

2.1.4.2 Bicycle Facilities

Bicycle facilities shall be provided as required by **Chapter 8** of this volume. Bicycle lanes on the approaches to bridges should be continued across the structure. The District Pedestrian/Bicycle Coordinator shall be consulted during planning and design to establish appropriate bicycle facility elements on a project-by-project basis. **Chapter 8** of this volume contains additional criteria for the accommodation of bicyclists.

Modification for Non-Conventional Projects:

Delete third sentence in above paragraph and see RFP for requirements.

2.1.4.3 Public Transit Facilities

Coordinate with the District Modal Development Office and local transit agency for the need for public transit facilities. **Chapter 8** of this volume contains additional guidelines for street side bus stop facilities, location and design.

Modification for Non-Conventional Projects:

Delete first sentence in above paragraph and see RFP for requirements.

2.1.5 Cross Slopes

For roadways, the maximum number of travel lanes with cross slope in one direction is three lanes. This maximum may be increased to four lanes for curb and gutter roadways with four travel lanes in the same direction. See **Figure 2.1.1** for standard pavement cross slopes. The algebraic difference in cross slope between adjacent through lanes shall not exceed 0.04. The maximum algebraic difference in cross slope between a through lane and an auxiliary lane at a turning roadway terminal is given in **Table 2.1.4. Chapter 4 on Roadside Safety** and **Chapter 8 on Pedestrian, Bicycle and Public Transit Facilities** (this volume) contain additional procedures and guidelines on slope design.

Cross slopes on bridges shall be on a uniform, straight-line rate, typically 0.02, in each traffic direction, with no break in slope. The straight-line slope shall be applied uniformly over all travel lanes and required shoulders in each direction of travel. Bridges with one-way traffic shall have one, uniform cross slope, while bridges with two-way traffic may be designed with a crowned bridge deck section.

This cross slope criteria applies to all bridge decks whether of cast-in-place concrete, precast concrete, or open steel decking.

Transitions shall be used to adjust for differences in cross slope between the approach roadway section and the required straight-line slope for bridge decks. Whenever possible the transition should be accomplished on the roadway section, outside the limits of the bridge and approach slabs. This will require detailing of the transition(s) in the roadway plans. Coordination between the Roadway, Drainage and Structures designers in the development of transitions is required to ensure compatibility and harmonizing at bridge approaches.

Figure 2.1.1 Standard Pavement Cross Slopes

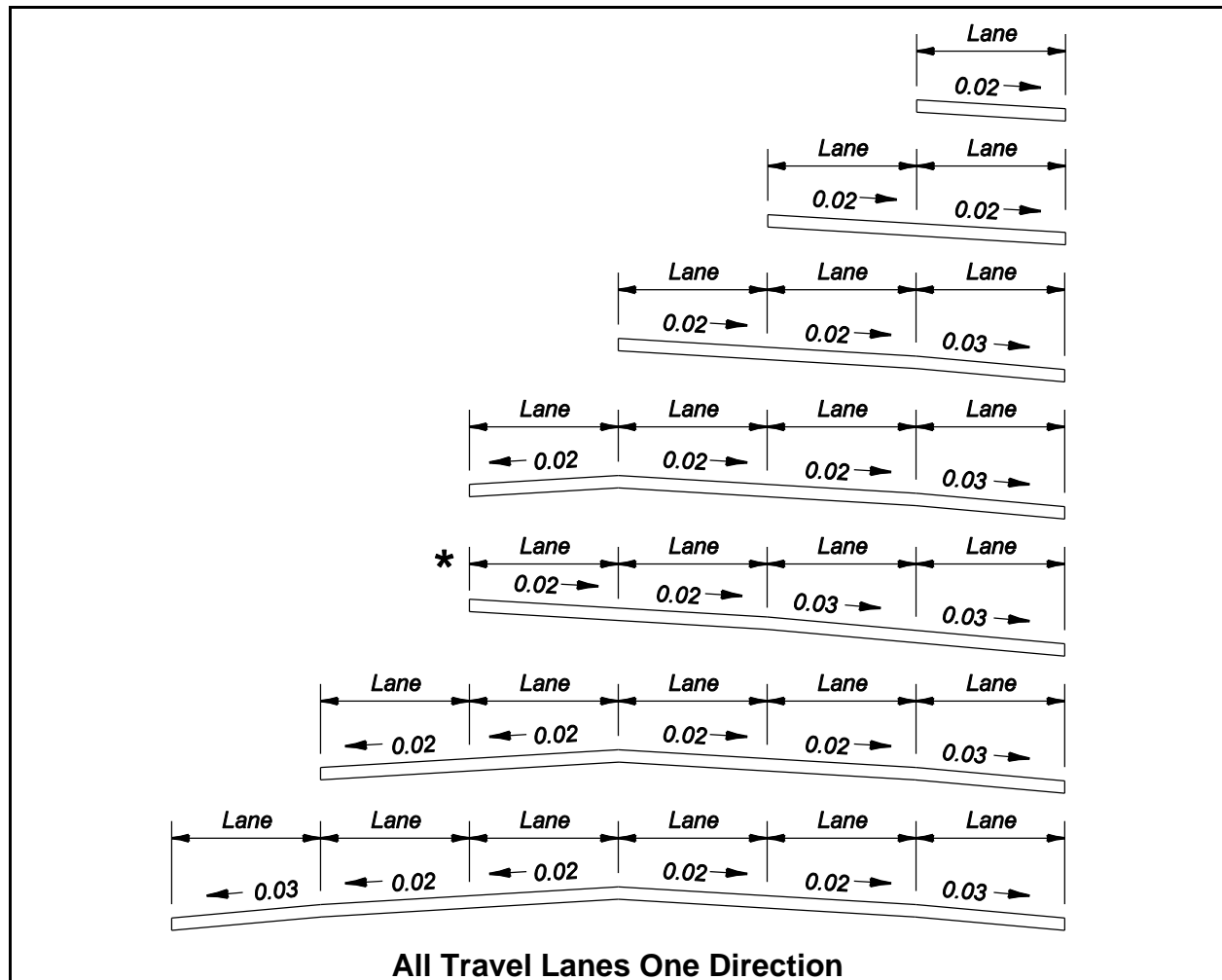

These sections show only the standard slopes for adjoining travel lanes; they do not prescribe needed lanes, lane usage or typical section requirements other than lane slope. These slopes are not applicable to parabolic crowns.

Maximum pavement cross slopes on tangent sections are:

- 0.04 for design speeds of 45 mph or less.
- 0.03 for design speeds greater than 45 mph.

The change in cross slope between adjacent through lanes shall not exceed 0.04.

Slopes on multi-purpose lanes may be 0.03 to 0.05. Portions of multi-purpose lanes that are reserved for parking and access isles for the physically disabled shall have cross slopes not exceeding 1:50 (0.02) in all directions.

*NOTE: Four travel lanes may be sloped in one direction for curb and gutter sections only.

Table 2.1.4 Maximum Algebraic Difference in Cross Slope at Turning Roadway Terminals

Design Speed of Exit or Entrance Curve (mph)	Maximum Algebraic Difference in Cross Slope at Crossover Line (%)
Less than 35	6.0
35 and over	5.0

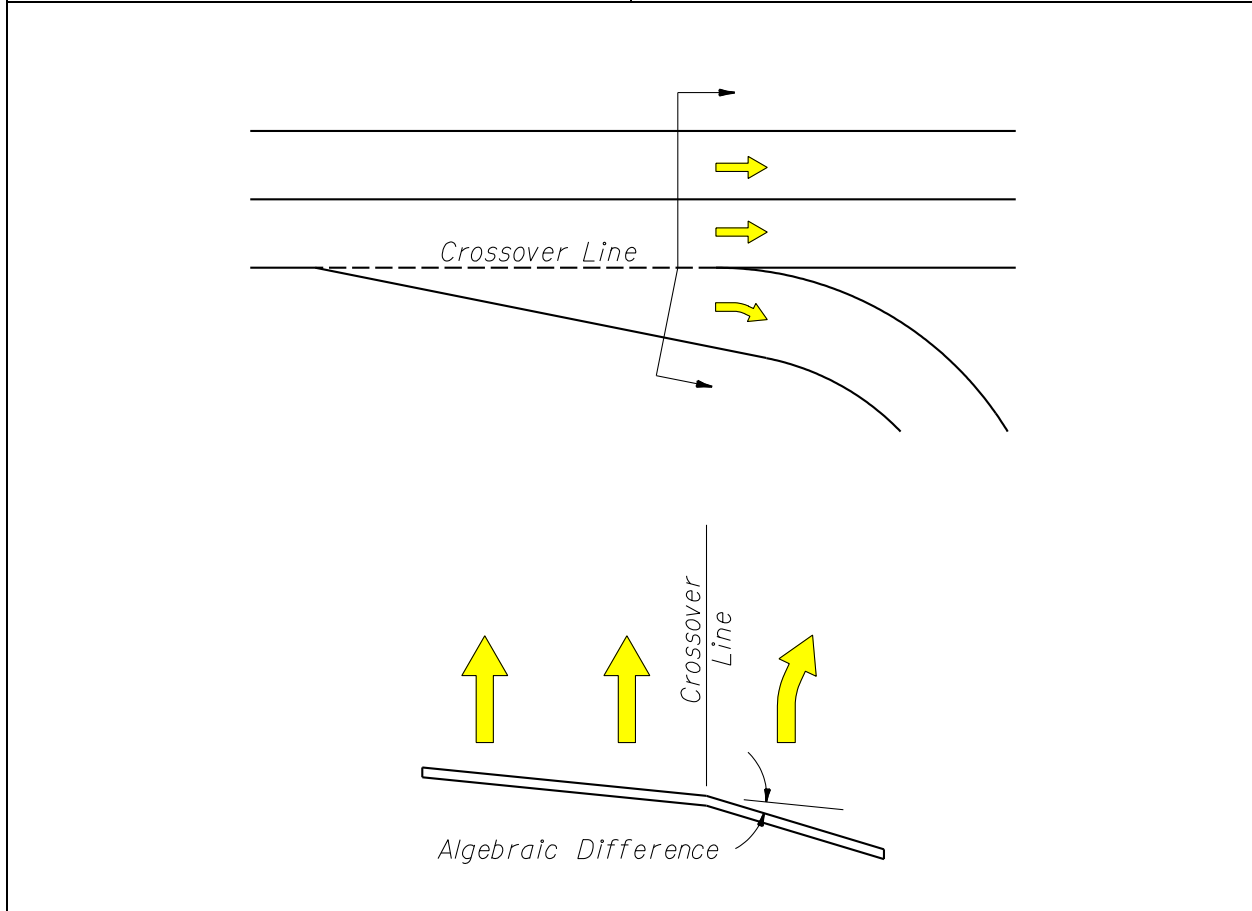

2.1.6 Roadway Pavement

The type of pavement usually is determined by analysis of the volume and composition of traffic, the soil conditions, the availability of materials, the initial cost and the estimated cost of maintenance.

Criteria and procedures for selecting the type of pavement and the structural design of the various surfacing courses are discussed in the Department's pavement design manuals.

2.1.6.1 Alternative Roadway Paving Treatments

Alternative paving treatments, such as patterned pavement and architectural pavers meeting FDOT Specifications, may be used for enhancing aesthetics and appearance when requested by a local community, and when the conditions and restrictions provided in this section are met. Patterned pavement treatments are covered under **Section 523** of the **FDOT Specifications** and are surface markings applied either as an overlay to the pavement surface or imprinted in the pavement surface. Architectural pavers are covered under **Section 526** of the **FDOT Specifications** and consist of brick pavers or concrete pavers placed on specially prepared bedding material.

These alternative pavement treatments are purely aesthetic treatments and are not considered to be traffic control devices. Use of either of these treatments is highly restricted as stated below. Even when all conditions and restrictions are met, any decision to use these treatments should consider that there may be potential adverse impacts to the traveling public as well as potential long term maintenance problems. Architectural pavers have been found to create significant ride-ability problems even on low speed roadways. Therefore, architectural pavers are prohibited within the traveled way on the State Highway System. Properly installed patterned pavement treatments do not significantly affect ride-ability; however, their use is also restricted since they are not likely to sustain their friction and wear characteristics for the full life of typical roadway pavement.

These paving treatments involve additional construction and maintenance costs not associated with typical roadway pavement. Therefore, appropriate agreements with the local maintaining agency shall be obtained. The local maintaining agency shall provide the additional funding for construction and assume responsibility for regular inspection and maintenance of the pavement treatment. In cases where existing alternative pavement is being removed as part of a Department project, replacement of such pavement shall adhere to the requirements in this section regardless of the circumstances of the original installation and maintenance. Maintenance agreements for installations within the traveled way on the State Highway System shall include the provisions outlined in **Section 2.1.6.2** for the duration of the installation.

The following restrictions apply:

Architectural Pavers:

1. Shall not be used on the traveled way of the State Highway System.
2. May be used on local side streets (with a design speed of 35 mph or less), non-traffic medians and islands, curb extensions, sidewalks, borders, and other areas not subject to vehicle traffic.
3. ADA requirements shall be met in areas subject to pedestrian traffic. See ***PROWAG R301.5 and R301.7*** and ***ADAAG 302 and 303*** for surface requirements.

Patterned Pavement:

1. Use on the traveled way of the State Highway System is restricted to areas within marked pedestrian crosswalks where the design speed is 45 mph or less; however, patterned pavement shall not be used on pedestrian crosswalks across limited access roadway ramps. Use on pedestrian crosswalks with heavy truck traffic turning movements ($\geq 10\%$ trucks) should be avoided.
2. The pavement to which the treatment is applied shall be of the same pavement type as, and continuous with, the adjoining pavement. For example, replacing flexible pavement with rigid patterned pavement within the limits of a crosswalk where the abutting pavement is to remain flexible pavement will likely result in pavement joint problems and adverse impacts to rideability. This type treatment is therefore not permitted. Replacing flexible pavement with rigid pavement for an entire intersection including crosswalks may be permitted with a Technical Special Provision submitted to the State Roadway Design Engineer for approval.
3. The initial treatment cannot be applied to any State Highway whose asphalt pavement surface is older than 5 years.
4. May be used in areas not subject to vehicle traffic such as median islands, curb extensions, sidewalks, and landscaping borders.
5. ADA requirements shall be met in areas subject to pedestrian traffic. See ***PROWAG R301.5 and R301.7*** and ***ADAAG 302 and 303*** for surface requirements.

When architectural pavers are used, the plans shall identify the location, type, pattern, shape and color. In addition, project specific details and requirements for edge restraints, bedding material thickness, and base and sub-base materials and thicknesses, as appropriate, must be developed and included in the plans, which shall be signed and sealed by a licensed Florida Professional Engineer.

When patterned pavement treatments are used, the plans shall identify the location, patterned type (brick, stone, etc.), and surface color. Because local agencies must fund and maintain these treatments, product brands, colors and patterns may be specified in the plans as long as the brand is listed on the QPL at the time of use.

Design Variations to any of the requirements in this Section shall be approved by the District Design Engineer.

2.1.6.2 Maintenance Memorandum of Agreement Requirements for Patterned Pavement

Prior to the installation of patterned pavement crosswalks in intersections on the State Highway System, a Maintenance Memorandum of Agreement shall be entered into with the local government agency requesting this aesthetic enhancement to the project. This agreement shall be filed with the District Maintenance Office. This Agreement shall require the local government agency to acknowledge that the installation and maintenance of patterned pavement is the total responsibility of the local agency, including contracting for friction testing with a qualified firm.

“Maintenance” of all patterned pavement crosswalks in these Agreements shall be defined, as a minimum, to include its frictional characteristics and integrity as follows:

1. Within 60 days of project acceptance by the Department, all lanes of each patterned crosswalk shall be evaluated for surface friction. The friction test shall be conducted using either a locked wheel tester in accordance with **FM 5-592 (Florida Test Method for Friction Measuring Protocol for Patterned Pavements)** or a Dynamic Friction Tester in accordance with **ASTM E1911**. **FM 5-592** can be accessed at the following link:

<http://materials.dot.state.fl.us/smo/administration/resources/library/publications/fs/tm/Methods/fm5-592.pdf>

The initial friction resistance shall be at least 35 obtained at 40 mph with a ribbed tire test (FN40R) or equivalent. Failure to achieve this minimum resistance shall require all deficient crosswalk areas to be removed to their full extent (lane-by-lane) and replaced with the same product installed initially. If the Department determines that more than 50% of the lanes in the intersection require replacement, the entire intersection installation may be reconstructed with a different product on the Qualified Products List (QPL) or replaced with conventional pavement.

2. Approximately one year after project acceptance and every two years thereafter and for the life of the adjacent pavement, only the outside traffic lane areas of

each patterned crosswalk shall be tested for friction resistance in accordance with **ASTM E274** or **ASTM E1911**. Friction resistance shall, at a minimum, have a FN40R value of 35 (or equivalent).

3. The results of all friction tests shall be sent to the District's Warranty Coordinator with a cover letter either certifying that the crosswalks comply with the minimum friction criteria, or stating what remedial action will be taken to restore the friction.
4. Failure to achieve the minimum resistance shall require all lanes of the crosswalk to be friction tested to determine the extent of the deficiency. All deficient areas shall be removed to their full extent (lane-by-lane) and replaced with the same product installed initially. If the Department determines that more than 50% of the lanes in the intersection require replacement, the entire intersection installation may be reconstructed with a different product on the QPL or replaced with conventional pavement.
5. When remedial action is required in accordance with the above requirements, the local agency shall complete all necessary repairs at its own expense within 90 days of the date when the deficiency was identified. No more than two full depth patterned pavement repairs shall be made to an area without first resurfacing the underlying pavement to 1" minimum depth.
6. The Department will not be responsible for replacing the treatment following any construction activities in the vicinity of the treatment.
7. Should the local agency fail to satisfactorily perform any required remedial work in accordance with this agreement, the Department reserves the right to replace the patterned pavement with conventional pavement (matching the adjacent pavement) and bill the local agency for this cost.

2.1.7 Transitions of Pavement Widths

When new pavement widths are not substantially greater than the joining pavement, grade differentials are slight and future widening is expected, striped transitions may be considered. An alternative approach is an abrupt change in width, with appropriate pavement markings, reflectors and rumble strips. The *Design Standards* contain additional criteria and details.

2.1.8 Number of Lanes on the State Highway System

For the number of lanes to be provided on the State Highway System, see **Section 335.02(3)** of the *Florida Statutes*.

Nothing in **s. 335.02(3), F.S.**, precludes a number of lanes in excess of ten lanes. However, before the Department may determine the number of lanes should be more than that, the availability of right of way and the capacity to accommodate other modes of transportation within existing rights of way must be considered.

Exceptions to **s. 335.02(3), F.S.** will be addressed on a case-by-case basis, with final approval resting with the Secretary of Transportation.

2.2 Medians

2.2.1 Median Width for Roadways

Median widths for roadways are given in **Table 2.2.1**.

Table 2.2.1 Median Widths

MEDIAN WIDTHS (FEET)	
TYPE FACILITY	WIDTH
FREEWAYS	
Interstate, Without Barrier	64 ¹
Other Freeways, Without Barrier	---
Design Speed ≥ 60 mph	60
Design Speed < 60 mph	40
All, With Barrier, All Design Speeds	26 ²
ARTERIAL AND COLLECTORS	
Design Speed > 45 mph	40
Design Speed ≤ 45 mph	22 ³
Paved And Painted For Left Turns	12 ⁴
<p>Median width is the distance between the inside (median) edge of the travel lane of each roadway.</p> <ol style="list-style-type: none"> 1. 88 ft. when future lanes planned. 2. Based on 2 ft. median barrier and 12 ft. shoulder. 3. On reconstruction projects where existing curb locations are fixed due to severe right of way constraints, the minimum width may be reduced to 19.5 ft. for design speeds = 45 mph, and to 15.5 ft. for design speeds ≤ 40 mph. 4. Restricted to 5-lane sections with design speeds ≤ 40 mph. On reconstruction projects where existing curb locations are fixed due to severe right of way constraints, the minimum width may be reduced to 10 ft. These flush medians are to include sections of raised or restrictive median for pedestrian refuge and to conform to Section 2.2.2 of this volume and the Access Management Rules. 	

2.2.2 Multilane Facility Median Policy

All multilane SIS facilities shall be designed with a raised or restrictive median. All other multilane facilities shall be designed with a raised or restrictive median except four-lane sections with design speeds of 40 mph or less. Facilities having design speeds of 40 mph or less are to include sections of raised or restrictive median for enhancing vehicular and pedestrian safety, improving traffic efficiency, and attainment of the standards of the Access Management Classification of that highway system.

2.2.3 Median Treatments on Bridges

For divided highways, the District will determine the desired distance between structures. **Figures 2.0.1** and **2.0.3** in this chapter, indicate that a full deck is recommended if the open space between the bridges is 20 ft. or less and required when less than 10 ft. For structures with less than 20 ft. of clearance, consult with District Structures Design and Facilities Maintenance before making a final decision.

Each District Office, in deciding on a single structure deck or twin bridges, must take into account the inspection and maintenance capabilities of its personnel and equipment. If the total width for a single structure exceeds the capacity of district maintenance equipment (approximately 60 ft. reach), twin structures may be specified and the open distance between structures determined by the practical capability of the maintenance and inspection equipment. This is particularly important for girder superstructures because those areas that cannot be reached by topside equipment might require catwalks, ladders or other access features. Such features will add to the cost of superstructures and must be accounted for in the initial selection of alternates.

2.3 Shoulders

Roadway shoulder width, cross slope and superelevation criteria are provided in the criteria tables and figures. Paved outside shoulders, 5 ft. in width, are required on all new construction, reconstruction and lane addition projects for all highways except freeways, which generally require a 10 ft. paved outside shoulder.

Specific widths have also been adopted for interstate, expressway, single and double lane ramps and collector-distributor road shoulders. Total shoulder widths, paved shoulder widths, and widths of paved shoulder separations between through pavement edge and the near edge of any shoulder gutter are given for both right (outside) and left (inside) edges of the roadway. See **Tables 2.3.1 – 2.3.4** and **Figures 2.3.1 – 2.3.2**.

The **Design Standards, Index 104**, provides additional details for paved shoulders.

Figures 2.0.1 and **2.0.2** include criteria for shoulder widths on various bridge sections. Where these widths differ from those required for roadways or ramps, decisions about the final values chosen for the project must be coordinated between the Roadway and Structures Design Offices.

Generally, the outside shoulder width for bridges should be the same width as the approach roadway shoulder up to a maximum of 10 feet. On roadway alignments having 12 ft. shoulders with continuous barrier walls and closely spaced bridges, a 12 ft. bridge shoulder width may be considered. The decision to use 12 ft. bridge shoulder widths should be coordinated with the District Design Engineer.

Modification for Non-Conventional Projects:

Delete last sentence in above paragraph and see RFP for bridge shoulder width requirements.

For shoulder cross slope criteria on bridges see **Section 2.1.5** of this chapter.

It is recommended to pave the median section and a 10 foot outside shoulder under overpass bridges. In addition, miscellaneous asphalt should be placed from the paved shoulder to the slope pavement. This pavement will provide additional safety, enhance drainage, reduce maintenance and improve appearance. See **Figure 2.3.2**.

For paved shoulders at railroad crossings see the **Design Standards, Index 560**.

Table 2.3.1 Shoulder Widths and Cross Slopes - Freeways

HIGHWAY TYPE		WIDTH (FEET)								CROSS SLOPES		
		WITHOUT SHOULDER GUTTER				WITH SHOULDER GUTTER						
		FULL WIDTH		PAVED WIDTH		FULL WIDTH		PAVED WIDTH		NORMAL ₁		
		Outside	Median or Left	Outside	Median or Left	Outside	Median or Left	Outside	Median or Left	Outside ₆	Median or Left	
FREWAYS (Lanes One Way)	4-Lane or More	12	12	10	10	15.5	15.5	8	8	0.06	0.06	
	3-Lane	12	12	10	10	15.5	15.5	8	8		0.05	
	2-Lane	12	8	10	4	15.5	13.5	8	6			
	HOV Lane	N/A ₄	14	N/A ₄	10	N/A ₄	N/A ₄	N/A ₄	N/A ₄	N/A ₄	N/A ₄	0.05 ₂
	1-lane Barrier-Separated HOV Lane ₅	6	4 ₅	6	4 ₅	N/A ₄	N/A ₄	N/A ₄	N/A ₄	Same as Lane	Same as Lane ₅	
	2-lane Barrier-Separated HOV Lane ₅	10	6 ₅	10	6 ₅	N/A ₄	N/A ₄	N/A ₄	N/A ₄	Same as Lane	Same as Lane ₅	
	1-Lane Ramp	6	6	4	2	11.5	11.5	4 ₃	4	0.06	0.05	
	2-Lane Ramp Non-Interstate	10	8	8	4	15.5	13.5	8	6			
	2-Lane Ramp Interstate	12	8	10	4	15.5	13.5	8	6			
	C-D Road 1-Lane	6	6	4	2	11.5	11.5	4	4			
	C-D Road 2-Lane	12	8	10	4	15.5	13.5	8	6			
	C-D Road 3-Lane	12	12	10	10	15.5	15.5	8	8			
	C-D Road > 3-Lane	12	12	10	10	15.5	15.5	8	8			
	Auxiliary Lane Climbing & Weaving	12	N/A ₄	10	N/A ₄	15.5	N/A ₄	8	N/A ₄			N/A ₄
	Auxiliary Lane Mainline Terminal:											
1-Lane Ramp	12	N/A ₄	10	N/A ₄	15.5	N/A ₄	8	N/A ₄	N/A ₄			
2-Lane Ramp	12	N/A ₄	10	N/A ₄	15.5	N/A ₄	8	N/A ₄	N/A ₄			
Frontage Road	See COLLECTORS Table 2.3.4 . For local roads and streets see the FDOT Manual of Uniform Minimum Standards for Design, Construction and Maintenance for Streets and Highways .											

- Shoulders shall extend 4 ft. beyond the back of shoulder gutter and at a 0.06 cross slope back toward the gutter.
- 0.06 when 4 lanes or more combined.
- Shoulder pavement less than 6 ft. in width that adjoins shoulder gutter shall be the same type, depth and cross slope as the ramp pavement.
- This does not mean that a shoulder is unnecessary; rather, shoulder is not typically present at this location (i.e., it is not required when adjacent to the through lane).
- If median side of HOV lane is not barrier-separated, use median shoulder requirements for a standard HOV lane. Refer to AASHTO's **Guide for High-Occupancy Vehicle Facilities** for additional information.
- For projects constructed with concrete pavement, the first one or two feet (as determined by outside slab width) of the designated shoulder width shall have the same cross slope (and superelevation) as the outside lane.

Table 2.3.2 Shoulder Widths and Cross Slopes - Arterials Divided

HIGHWAY TYPE		WIDTH (FEET)								CROSS SLOPES	
		WITHOUT SHOULDER GUTTER				WITH SHOULDER GUTTER					
		FULL WIDTH		PAVED WIDTH		FULL WIDTH		PAVED WIDTH		NORMAL ₁	
		Outside	Median or Left	Outside ₂	Median or Left	Outside	Median or Left	Outside	Median or Left	Outside ₆	Median or Left
ARTERIALS	4-Lane	12	12	5	4	15.5	15.5	8	8	0.06	0.06
		10	10	5	4	15.5	15.5	8	8		
		8	8	5	4	15.5	13.5	6	6		
	3-Lane	12	12	5	0 ₄	15.5	15.5	8	8		
		10	10	5	0 ₄	15.5	15.5	8	8		
		8	8	5	0 ₄	13.5	13.5	6	6		
	2-Lane	12	8	5	0 ₄	15.5	13.5	8	6		
		10	8	5	0 ₄	15.5	13.5	8	6		
	8	6	5	0 ₄	13.5	11.5	6	4			
	1-Lane Ramp	6	6	5	2	11.5	11.5	4 ₃	4		
2-Lane Ramp	10	6	5	2	15.5	13.5	8	6			
C-D Road 1-Lane	6	6	5	2	11.5	11.5	4	4			
C-D Road 2-Lane	8	6	5	0	13.5	11.5	6	4			
Auxiliary Lane Climbing & Weaving	Same As Travel Lanes	N/A ₅	Same As Travel Lanes	N/A ₅	Same As Travel Lanes	N/A ₅	Same As Travel Lanes	N/A ₅	N/A ₅		
Auxiliary Lane Mainline Terminal:											
1-Lane Ramp	8	N/A ₅	5	N/A ₅	11.5	N/A ₅	4	N/A ₅	N/A ₅		
2-Lane Ramp	12	N/A ₅	10	N/A ₅	15.5	N/A ₅	8	N/A ₅	N/A ₅		
Auxiliary Lane At-Grade Intersection	Same As Travel Lanes	Same As Travel Lanes	5	0	11.5	N/A ₅	4	N/A ₅	0.05 - 0.06		
Frontage Road	See Collectors Table 2.3.4 . For local roads and streets see the FDOT Manual of Uniform Minimum Standards for Design, Construction and Maintenance for Streets and Highways .										

- Shoulders shall extend 4 ft. beyond the back of shoulder gutter and have a 0.06 cross slope back toward the gutter.
- Shoulder shall be paved full width through rail-highway at-grade crossings, extending a minimum distance of 50 ft. on each side of the crossing measured from the outside rail. For additional information see the **Design Standards, Index No. 560 and 1782**.
- Shoulder pavement less than 6 ft. in width and adjoining shoulder gutter shall be the same type, depth and cross slope as the ramp pavement.
- Paved 2 ft. wide where turf is difficult to establish. Paved 4 ft. wide (a) in sag vertical curves, 100 ft. minimum either side of the low point, and (b) on the low side of superelevated traffic lanes extending through the curves and approximately 300 ft. beyond the PC and PT.
LEGEND X.....High Volume Highways
FOR X.....Normal Volume Highways
VALUES X.....Low Volume Highways
- This does not mean that a shoulder is unnecessary; rather, shoulder is not typically present at this location (i.e., it is not required when adjacent to through lane).
- For projects constructed with concrete pavement, the first one or two feet (as determined by outside slab width) of the designated shoulder width shall have the same cross slope (and superelevation) as the outside lane.

Table 2.3.3 Shoulder Widths and Cross Slopes - Arterials Undivided

HIGHWAY TYPE		WIDTHS (FEET)				CROSS SLOPES
		WITHOUT SHOULDER GUTTER		WITH SHOULDER GUTTER		NORMAL ^{1,4}
		FULL WIDTH	PAVED WIDTH ₂	FULL WIDTH	PAVED WIDTH	
ARTERIALS Undivided (lanes Two-Way)	Multilane ₃	12	5	15.5	8	0.06
		10	5	15.5	8	
		8	5	13.5	6	
	2-Lane	12	5	15.5	8	
10		5	15.5	8		
		8	5	13.5	6	
	Auxiliary Lane At-Grade Intersections	Same As Travel Lanes	5	11.5	4	
	Frontage Road	See COLLECTORS Table 2.3.4. For local roads and streets see the FDOT Manual of Uniform Minimum Standards for Design, Construction and Maintenance for Streets and Highways.				

- Shoulders shall extend 4 ft. beyond the back of shoulder gutter and have a 0.06 cross slope back toward the gutter.
- Shoulder shall be paved full width through rail-highway at-grade crossings, extending a minimum distance of 50 ft. on each side of the crossing measured from the outside rail. For additional information see the **Design Standards, Index No. 560 and 17882.**
- All multilane facilities shall conform with **Section 2.2.2** of this Volume.

LEGEND X.....High Volume Highways
FOR X.....Normal Volume Highways
VALUES X.....Low Volume Highways
- For projects constructed with concrete pavement, the first one or two feet (as determined by outside slab width) of the designated shoulder width shall have the same cross slope (and superelevation) as the outside lane.

Table 2.3.4 Shoulder Widths and Cross Slopes - Collectors Divided and Undivided

HIGHWAY TYPE		WIDTHS (FEET)								CROSS SLOPES	
		WITHOUT SHOULDER GUTTER				WITH SHOULDER GUTTER				NORMAL ₁	
		FULL WIDTH		PAVED WIDTH		FULL WIDTH		PAVED WIDTH			
		Outside	Median Or Left	Outside ₂	Median Or Left	Outside	Median Or Left	Outside	Median Or Left	Outside ₆	Median Or Left
C O L L E C T O R S Divided (Lanes One-Way)	3-Lane	12	12	5	0 ₃	15.5	15.5	8	8	0.06	0.05
		10	10	5	0 ₃	15.5	15.5	8	8		
	8	8	5	0 ₃	13.5	15.5	6	6			
	2-lane	12	8	5	0 ₃	15.5	13.5	8	6		
		10	8	5	0 ₃	15.5	13.5	8	6		
		8	6	5	0 ₃	13.5	11.5	6	4		
	Auxiliary Lane At-Grade Intersection	Same As Travel Lanes	Same As Travel Lanes	5	4	11.5	N/A ₅	4	N/A ₅		
C O L L E C T O R S Undivided (Lanes Two-Way)	Multilane ₄	12		5		15.5		8		0.06	
		10		5		15.5		8			
		8		5		13.5		6			
	2-Lane	12		5		15.5		8			
		10		5		15.5		8			
		8		5		13.5		6			
	Auxiliary Lane At-Grade Intersection	Same As Travel Lanes	Same As Travel Lanes			11.5		4			

1. Shoulders shall extend 4 ft. beyond the back of shoulder gutter and have a 0.06 cross slope back toward the gutter.
2. Shoulder shall be paved full width though rail-highway at-grade crossings, extending a minimum distance of 50 ft. on each side of the crossing measured from the outside rail. For additional information see **Design Standards, Index Nos. 560 and 17882.**
3. The median shoulder may be paved 2 ft. wide in areas of the State where establishing and maintaining turf is difficult; however, shoulders shall be paved 4 ft. wide (a) in sag vertical curves, 100 ft. minimum either side of the low point, and (b) on the low side of superelevated traffic lanes, extending through the curve and approximately 300 ft. beyond the PC and PT.
4. All multilane facilities shall conform with **Section 2.2.2** of this volume.
LEGEND X High Volume Highways
FOR X Normal Volume Highways
VALUES X Low Volume Highways
5. This does not mean that a shoulder is unnecessary; rather, shoulder is not typically present at this location (i.e., it is not required when adjacent to through lane).
6. For projects constructed with concrete pavement, the first one or two feet (as determined by outside slab width) of the designated shoulder width shall have the same cross slope (and superelevation) as the outside lane.

Figure 2.3.1.A Shoulder Superelevation

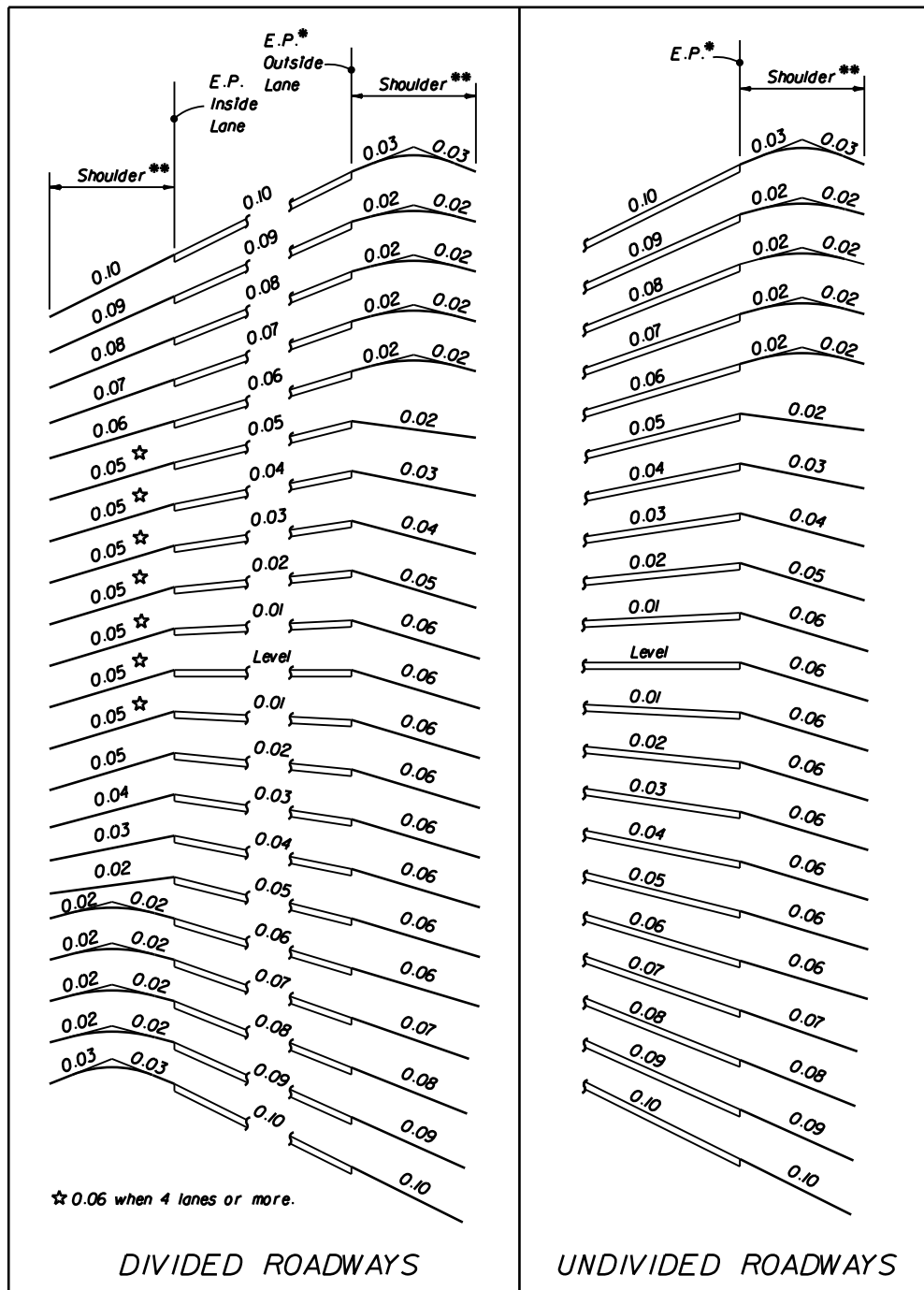

- * For projects constructed with concrete pavement, the shoulder shall be superelevated about the outside edge of the outside slab.
- ** For shoulders with paved widths 5 feet or less (all Highway Types) see Special Shoulder superlevation details (**Figure 2.3.1.B**).

Figure 2.3.1.B Special Shoulder Superelevation

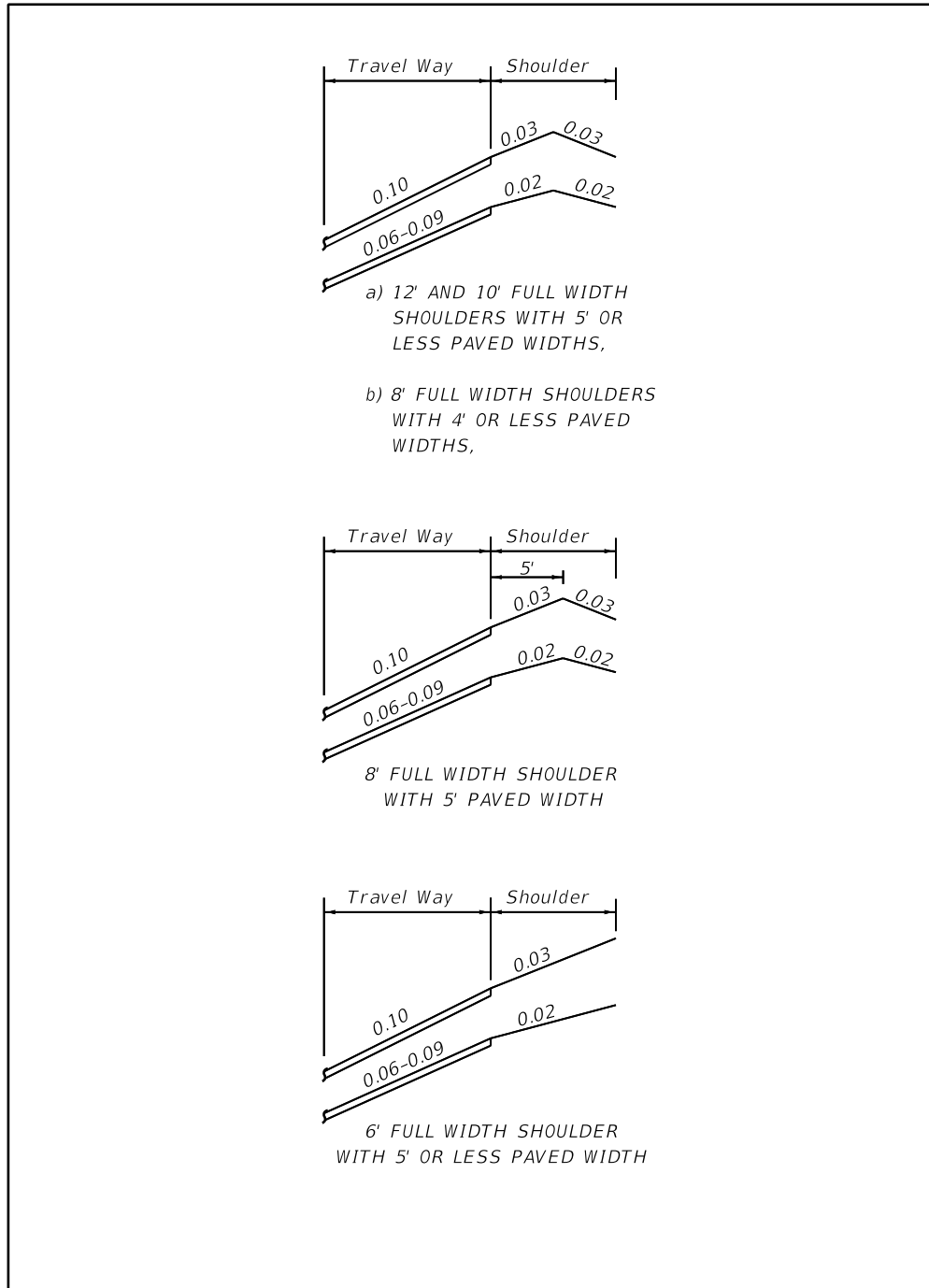
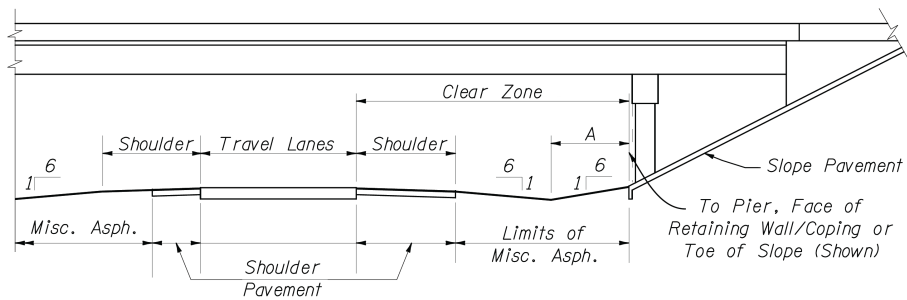
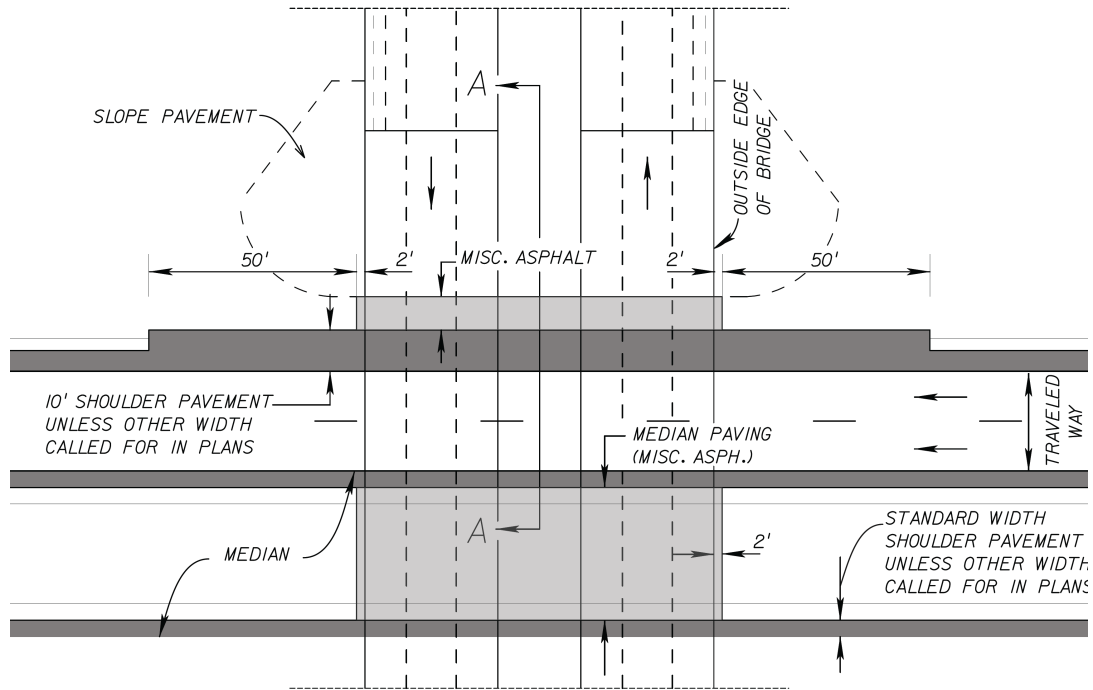

Figure 2.3.2 Typical Paving Under Bridge



SECTION A-A

FACILITY	A
FREEWAYS RURAL AND URBAN INTERSTATES (FREEWAYS), ARTERIALS, AND COLLECTORS, WITH PROJECTED 20-YEAR ADT OF 1500 OR GREATER	12'
RURAL ARTERIALS AND COLLECTORS WITH PROJECTED 20-YEAR ADT OF LESS THAN 1500.	8'
URBAN ARTERIALS AND COLLECTORS FLUSH SHOULDER ROADWAYS WITH PROJECTED 20-YEAR ADT OF LESS THAN 1500	6'

2.3.1 Limits of Friction Course on Paved Shoulders

Friction courses on limited access facilities shall be extended 8 inches onto both the median and outside paved shoulders of roadways.

Friction courses shall be extended the full width of the paved shoulder on non-limited access highways to accommodate bicyclist usage.

2.3.2 Shoulder Warning Devices (Rumble Strips)

The safety of freeways and other limited access facilities on the State highway system is to be enhanced by the installation of shoulder warning devices in the form of rumble strips. Projects on limited access facilities shall include the construction of ground-in rumble strips. Several types of applications have been tested. The ground-in strips provide the desired warning to the driver and consistency in application has been possible using this construction process.

These ground-in strips are installed using two patterns. The skip array is the standard array. These are used on both inside and outside shoulders on divided highway sections. The continuous array shall be constructed in advance of bridge ends for a distance of 1000 ft. or back to the gore recovery area for mainline interchange bridges. Other areas may be specified in plans.

Methods and types of application other than described above and in the ***Design Standards, Index 518***, shall not be used unless concurred in by the State Roadway Design Engineer. Approval will be considered only with sufficient documented justification for deviation from the standard.

The ***Design Standards, Index 518***, has been prepared to provide all needed details. This index also gives standards for raised rumble strips for use at structures where the bridge shoulder width is less than the width of the useable shoulder on the approach roadway. Notes for locations of raised rumble strip applications are also included on the index.

2.3.3 Use of Curb on High Speed Roadways

Curbs shall not be used on high speed roadways (Design Speed \geq 50 mph) except as follows:

1. FDOT Suburban Section
2. FDOT High Speed Urban Section
3. Median Openings
4. Transit Stops

Curbs used on high speed roadways shall be FDOT Type E with the face of the curb placed no closer to the edge of the traveled way than the required full width shoulder for a flush shoulder roadway. For the Suburban and High Speed Urban Section, special offset widths to curb have been established. See **Section 2.16** for requirements for High-Speed Urban and Suburban Arterial Highways. For directional median openings, see **Index 527**. For transit stops, the curb face shall be no closer to the edge of the traveled way than the required full width shoulder for a flush shoulder roadway.

2.4 Roadside Slopes

Criteria and details for roadside slopes are included in **Table 2.4.1**. For slopes steeper than 1:3, consider the associated long term erosion control and maintenance costs. Coordinate the use of these slopes with the Drainage, Maintenance and Landscape Architect's Offices. For sod or turf slopes steeper than 1:3 and higher than 20 feet, include a 10 foot wide flat area at the top and base of the slope with clear access for maintenance equipment and personnel. For sod or turf slopes steeper than 1:3 and higher than 35 feet, include a 10 foot wide maintenance berm not more than every 35 feet from the top of the slope. Slopes steeper than 1:2 require coordination with the District Geotechnical Office.

Modification for Non-Conventional Projects:

Delete the second, third and last sentences in above paragraph and see RFP for requirements.

A 10 foot flat area shall be included from the face of an adjacent retaining wall allowing clear access for maintenance vehicles and personnel. (See **SDG 3.12.**)

Clear zone (CZ) criteria are included in **Section 2.11** and **Chapter 4** of this volume.

Table 2.4.1 Roadside Slopes

TYPE OF FACILITY	RURAL & URBAN FREEWAYS, RURAL ARTERIALS AND COLLECTORS, WITH PROJECTED 20 YEAR AADT OF 1500 OR GREATER		RURAL ARTERIALS AND COLLECTORS WITH PROJECTED 20 YR. AADT LESS THAN 1500 AND RURAL LOCALS, URBAN ARTERIALS AND COLLECTORS WITHOUT CURB & GUTTER		URBAN ARTERIALS AND COLLECTORS WITH CURB & GUTTER	
	DESIGN SPEED 45 mph OR GREATER		ALL SPEEDS		DESIGN SPEED 45 mph OR LESS	
	Height of Fill (feet) *	Rate	Height of Fill (feet) *	Rate	Height of Fill (feet) *	Rate
Front Slope	0.0 - 5 5 - 10 10 - 20 >20	1:6 1:6 to edge of CZ then 1:4 1:6 to edge of CZ then 1:3 1:2 (with guardrail)	0.0 - 5 5 - 20	1:6 Where R/W is insufficient, 1:6 to edge of CZ then 1:3 1:6 to edge of CZ then 1:3. Where, R/W is insufficient, 1:6 to edge of CZ then 1:2.	All	1:2 or to suit property owner, not flatter than 1:6. R/W cost must be considered for high fill sections in urban areas
Back Slope	All	1:4 or 1:3 with a standard width trapezoidal ditch and 1:6 front slope	All	1:4 when R/W permits or 1:3	All	1:2 or to suit property owner. Not flatter than 1:6.
Transverse Slopes	All	1:10 or flatter (freeways) 1:4 (others)	All	1:4	All	1:4

* Height of Fill is the vertical distance from the edge of the outside travel lane to the toe of front slope.

2.5 Borders

Border widths for new construction or major reconstruction where R/W acquisition is required are as follows:

On highways with flush shoulders, the border is measured from the shoulder point to the right of way line. This border width accommodates (1) roadside design components such as signing, drainage features, guardrail, fencing and clear zone, (2) the construction and maintenance of the facility and (3) permitted public utilities. See **Table 2.5.1**.

On highways with curb or curb and gutter where clear zone is being provided, border width is to be based on flush shoulder requirements, but is measured from the lip of the gutter (or face of curb when there is not a gutter) to the right of way line. This border width accommodates (1) roadside design components such as signing, drainage features, guardrail, fencing and clear zone, (2) the construction and maintenance of the facility and (3) permitted public utilities. See **Table 2.5.1**.

On highways with curb or curb and gutter in urban areas, the border is measured from the lip of the gutter (or face of curb when there is not a gutter) to the right of way line. This border provides space for a buffer between vehicles and pedestrians, sidewalks with ADA provisions, traffic control devices, fire hydrants, storm drainage features, bus and transit features, permitted public utilities and space for aesthetic features such as sod and other landscape items. See **Table 2.5.2**.

On limited access facilities, the border width criteria are provided in **Section 2.5.1**.

Projects involving bridges will require coordination to match the features of the roadway with those of the bridge.

Modification for Non-Conventional Projects:

Delete sentence above and see RFP for requirements on projects involving bridges.

On existing streets and highways where R/W cannot be acquired or where the decision has been made to simply maintain and preserve the facility, the border area must be reserved for the functional and safety needs of the facility. The absolute minimum border under these conditions is 8 feet.

Table 2.5.1 Highways with Flush Shoulders

BORDER	
TYPE FACILITY	WIDTH (FEET)
ARTERIALS COLLECTORS Design Speed > 45 mph	40
ARTERIALS COLLECTORS Design Speed ≤ 45 mph	33

Table 2.5.2 Highways with Curb or Curb and Gutter in Urban Areas

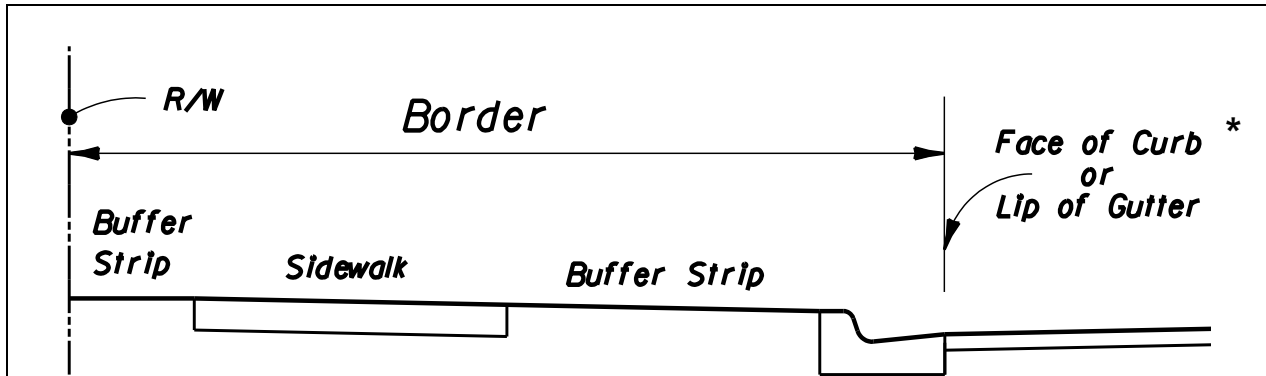

* **Border width measured from lip of gutter (shown) or from face of curb when there is not a gutter.**

BORDER		
TYPE FACILITY	MINIMUM WIDTH (FEET)	
	TRAVEL LANES AT CURB OR CURB AND GUTTER	BICYCLE LANES OR OTHER AUXILIARY LANES AT CURB OR CURB AND GUTTER
ARTERIALS COLLECTORS Design Speed = 45 mph	14	12
ARTERIALS COLLECTORS Design Speed ≤ 40 mph	12	10
URBAN COLLECTOR STREETS Design Speed ≤ 30 mph	10	8

2.5.1 Limited Access Facilities

On limited access facilities, the border is measured from the edge of the outside traffic lane to the right of way line. This width may be reduced in the area of a crossroad terminal, as long as the design meets the requirements for clear zone, horizontal clearance, drainage, maintenance access, etc.

Limited access facilities shall be contained by fencing, or in special cases, walls or barriers. These treatments shall be continuous and appropriate for each location. Treatment height and type may vary under special conditions. The treatment is typically placed at or near the limited access right of way line, but location may be adjusted based on site-specific conditions (i.e., ponds, trees, bridges, etc.). Placement information and additional data is included in the *Design Standards, Indexes 800, 801, and 802*.

Modification for Non-Conventional Projects:

Delete third sentence in above paragraph and see RFP for requirements.

Table 2.5.3 Limited Access Facilities

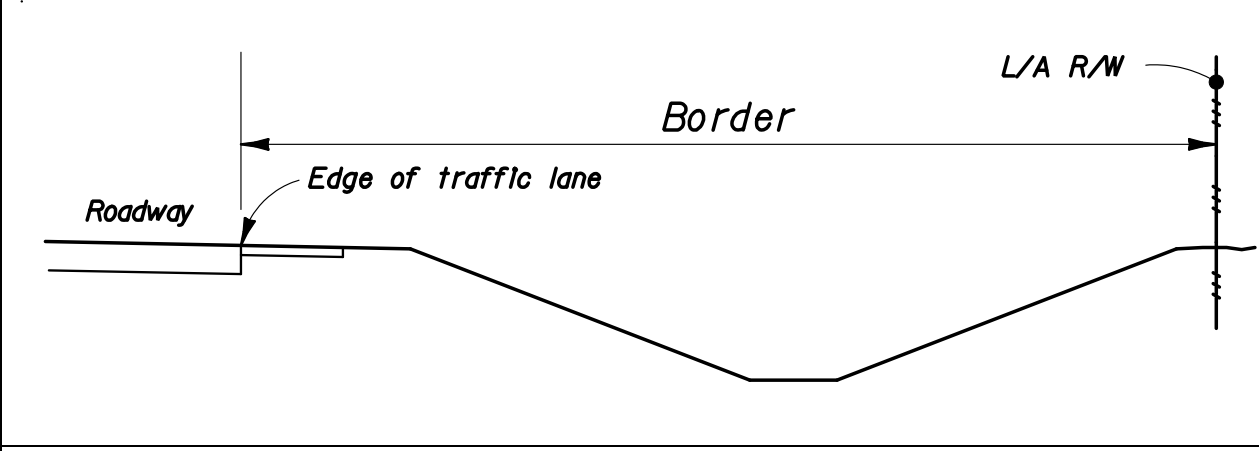

The diagram illustrates the cross-section of a limited access facility. On the left, a 'Roadway' is shown with a vertical line indicating the 'Edge of traffic lane'. A horizontal double-headed arrow labeled 'Border' extends from this edge to a vertical line on the right labeled 'L/A R/W'. Below the roadway, a trapezoidal shape represents the embankment or ditch. Below the diagram is a table with the following structure:

BORDER	
TYPE FACILITY	WIDTH (FEET)
FREEWAYS (INCLUDING INTERCHANGE RAMPS)	94

2.6 Grades

The profile grade line defines the vertical alignment for roadway and bridge construction. As with other design elements, the characteristics of vertical alignment are influenced greatly by basic controls related to design speed, traffic volumes, functional classification, drainage and terrain conditions. Within these basic controls, several general criteria must be considered. See **Tables 2.6.1 – 2.6.4**.

Minimum clearances for structures over railroads are given in **Table 2.10.1**. Additional information, including at-grade crossings, is given in **Chapter 6** of this volume.

The Department's minimum for clearance over all highways is given in the criteria tables and figures. Exceptions to this policy shall be permitted only when justified by extenuating circumstances and approved as a Design Variation or Design Exception.

The clearance required for the roadway base course above the Base Clearance Water Elevation is given in the criteria tables and figures. The relationship between the pavement elevation and the Design Flood Elevation is discussed in **Section 4.4 (3)** of the **FDOT Drainage Manual (Topic No. 625-040-002)**. Turnpike facilities are generally used for Hurricane Evacuation. Turnpike mainline travel lanes shall be above the 100 year flood plain elevation established by FEMA or other pertinent studies.

Grades for structures over water shall be designed to provide the minimum vertical clearance as stipulated in **Section 2.10** of this chapter.

The **Design Standards** lists minimum covers and maximum fill heights for all types of culverts. For utility clearances, refer to the **Utility Accommodation Manual**.

Table 2.6.1 Maximum Grades

MAXIMUM GRADES IN PERCENT													
TYPE OF HIGHWAY	AREA	DESIGN SPEED (mph)											
		FLAT TERRAIN						ROLLING TERRAIN					
		30	40	45	50	60	70	30	40	45	50	60	70
FREEWAYS ¹	Rural	----	----	4	4	3	3	----	----	----	5	4	4
	Urban	----	----	4	4	3	3	----	----	----	5	4	4
ARTERIALS ³	Rural	----	5	5	4	3	3	----	6	6	5	4	4
	Urban	8	7	6	6	5	----	9	8	7	7	6	----
COLLECTORS ³	Rural	7	7	7	6	5	4	9	8	8	7	6	5
	Urban	9	9	8	7	6	5	11	10	9	8	7	6
	Industrial ₂	4	4	4	3	3	----	5	5	5	4	4	----
FRONTAGE ROADS	Require same criteria as Collectors.												
RAMPS	DESIGN SPEED (mph)		< 20		25 to 30		35 to 40		45 to 50				
	GRADES (%)		8		7		6		5				
One-way descending grades on Ramps may be 2% greater, in special cases.													
1. Interstate designed to 70 mph will be restricted to 3% maximum grade. 2. Areas with significant (10% or more) heavy truck traffic. 3. On 2-lane highways critical length of upgrades shall not be exceeded. Critical lengths are those which reduce the speeds of 200 lb/hp trucks by more than 10 mph.													

Table 2.6.2 Maximum Change in Grade Without Vertical Curves

DESIGN SPEED (mph)	20	30	40	45	50	60	65	70
MAXIMUM CHANGE IN GRADE IN PERCENT	1.20	1.00	0.80	0.70	0.60	0.40	0.30	0.20

Table 2.6.3 Criteria for Grade Datum

CLEARANCE FOR THE ROADWAY BASE COURSE ABOVE THE BASE CLEARANCE WATER ELEVATION	
TYPE FACILITY	REQUIRED CLEARANCE
Freeways and Rural Multilane Mainline	3 ft.
Ramps (proper)	2 ft. ¹
Low Point on Ramps at Cross Roads	1 ft. ¹
Rural Two-lane with Design Year ADT Greater than 1500 VPD	2 ft. ¹
All Other Facilities Including Urban	1 ft. ¹

1. This clearance requires a reduction in the design resilient modulus (see the *Flexible Pavement Design Manual*). Notify the Pavement Design Engineer that the clearance is less than 3 feet.

Table 2.6.4 Grade Criteria for Curb and Gutter Sections

GRADES ON CURB AND GUTTER SECTIONS	
Minimum Distance Required between VPI's	250 ft.
Minimum Grade (%)	0.3 %

(See **Table 2.6.1** for Maximum Grades)

2.7 Sight Distance

Minimum stopping and passing sight distances are given in **Tables 2.7.1 – 2.7.2**.

Table 2.7.1 Minimum Stopping Sight Distance

MINIMUM STOPPING SIGHT DISTANCE (FEET) (For application of stopping sight distance, use an eye height of 3.5 feet and an object height of 0.5 feet above the road surface)															
DESIGN SPEED (mph)	GRADES OF 2% OR LESS														
	Interstate							All Other Facilities							
15	----							80							
20	----							115							
25	----							155							
30	----							200							
35	----							250							
40	----							305							
45	----							360							
50	----							425							
55	570							495							
60	645							570							
65	730							645							
70	820							730							
ADJUSTMENT IN DISTANCE FOR GRADES GREATER THAN 2%															
DESIGN SPEED (mph)	INCREASE IN LENGTH FOR DOWNGRADE (ft.)								DECREASE IN LENGTH FOR UPGRADE (ft.)						
	Grades								Grades						
	3%	4%	5%	6%	7%	8%	9%		3%	4%	5%	6%	7%	8%	9%
15	0	0	1	2	3	4	5		5	5	6	6	7	7	7
20	1	2	3	5	6	8	10		6	7	8	8	10	10	11
25	3	5	7	10	12	15	18		8	9	11	12	13	14	16
30	5	8	11	15	18	22	27		10	12	14	16	18	20	21
35	7	11	16	21	26	31	37		13	16	19	21	24	26	28
40	10	15	21	28	34	41	49		16	20	24	27	30	33	36
45	18	25	32	40	48	57	67		16	21	25	29	33	37	40
50	21	29	39	49	59	70	82		20	26	32	37	42	46	50
55	25	35	46	58	70	84	98		26	33	39	45	52	57	62
60	28	40	53	68	82	99	116		32	40	48	55	62	69	75
65	37	51	67	83	101	120	140		33	43	52	61	69	77	84
70	41	58	76	95	115	137	161		40	52	62	72	82	91	99

Table 2.7.2 Minimum Passing Sight Distance

MINIMUM PASSING SIGHT DISTANCE (FEET) (For application of passing sight distance, use an eye height of 3.5 feet and an object height of 3.5 feet above the road surface)											
DESIGN SPEED (mph)	20	25	30	35	40	45	50	55	60	65	70
2-Lane, 2-Way Facilities	710	900	1090	1280	1470	1625	1835	1985	2135	2285	2480

2.8 Curves

2.8.1 Horizontal Curves

Design speed is the principal factor controlling horizontal alignment. Several geometric standards related to design speed are very specific. Other criteria cannot be defined as specifically and require that judgments be made by designers in consideration of local conditions.

2.8.1.1 Supplemental Alignment Control (Mainline)

On projects which include roadways and bridges, coordination between the Roadway and Structures Design Offices may be necessary for those horizontal alignment issues affecting the location or geometry of the structure(s).

Avoid placing horizontal curves, PI's and superelevation transitions within the limits of a structure or approach slabs wherever practical. Because of the impact on the structure framing, spiral curves or alignments that result in skews greater than 45 degrees should be avoided. When skews greater than 45 degrees and/or spirals are necessary, specific justification including alternate framing concepts that relieve the severe skew effect shall be submitted to the District Design Engineer for concurrence.

Modification for Non-Conventional Projects:

Delete the last sentence in above paragraph.
--

Placement of stationing equations within the limits of a structure should be avoided on contract plans. Such equations unnecessarily increase the probability of error in both the design and construction phase.

Further guidelines have been established by the Department for lengths of horizontal curves, maximum deflections without curves, redirection of through lanes at intersections and minimum transition lengths between reverse curves. The criteria given are intended for use in establishing minimum lengths for both rural and urban conditions. See **Tables 2.8.1 – 2.8.4**.

For small deflection angles (5° or less), curves shall be at least 500 ft. long and the minimum increased 100 ft. for each 1° decrease in the central angle (900 ft. for a 1° central angle).

For design, the aesthetic control given above should be considered where practical, but may be compromised where other considerations warrant such action. Discernment of alignment changes in an urban setting is normally minimal due to the masking effects of development, traffic signs, various items of interest and similar distracting stimuli.

For information on the maximum deflection without a curve, see **Table 2.8.1**.

When compound curves are necessary on open highways, the ratio of the flatter radius to the sharper radius shall not exceed 1.5:1. For turning roadways and intersections a ratio of 2:1 (where the flatter radius precedes the sharper radius in the direction of travel) is acceptable.

The length of compound curves for turning roadways when followed by a curve of one-half radius or preceded by a curve of double radius should be as shown in **Table 2.8.2b**.

Table 2.8.1a Maximum Deflections without Horizontal Curves

MAXIMUM DEFLECTION WITHOUT CURVE (DMS)			
TYPE FACILITY		V ≥ 45 mph	V ≤ 40 mph
Freeways		0° 45' 00"	N/A
Arterials and Collectors	Without Curb & Gutter	0° 45' 00"	2° 00' 00"
	With Curb & Gutter	1° 00' 00"	2° 00' 00"
Where V=Design Speed (mph)			

Table 2.8.1b Maximum Deflection for Through Lanes through Intersections

Design speed (mph)	20	25	30	35	40	45
Maximum Deflection	16° 00'	11° 00'	8° 00'	6° 00'	5° 00'	3° 00'

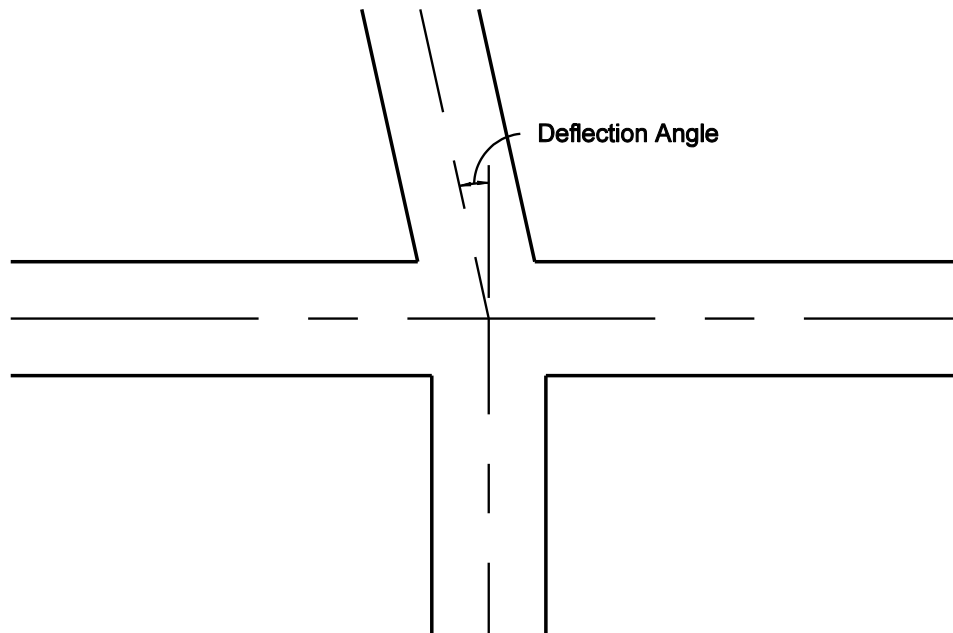

Table 2.8.2a Length of Horizontal Curves

LENGTH OF CURVE (FEET)	
Freeways	$30V^1$
Arterials	$15V^2$
Collectors	$15V^2$
Where V = Design Speed (mph)	
1. When $30V$ cannot be attained, the greatest attainable length shall be used, but not less than $15V$. 2. When $15V$ cannot be attained, the greatest attainable length shall be used, but not less than 400ft.	
Curve length shall provide full superelevation within the curve of not less than 200 ft. (Rural) or 100 ft. (Urban)	

Table 2.8.2b Arc Length (in feet) of Compound Curves with One-Half/Double Radii - Turning Roadways

Radius (ft.)	100	150	200	250	300	400	≥ 500
Minimum Length	40	50	65	85	100	120	150
Desirable Length	65	70	100	120	150	180	200

**Table 2.8.3 Maximum Curvature of Horizontal Curve
 (Using Limiting Values of "e" and "f")**

MAXIMUM CURVATURE (Degrees)			
Design Speed (mph)	RURAL ENVIRONMENT (e max=0.10)	URBAN ENVIRONMENT (e max=0.05)	
		Without Curb And Gutter	With Curb And Gutter
30	24° 45'	20° 00'	20° 00'
35	17° 45'	14° 15'	14° 15'
40	13° 15'	10° 45'	10° 45'
45	10° 15'	8° 15'	8° 15'
50	8° 15'	6° 30'	6° 30'
55	6° 30'	5° 00'	---
60	5° 15'	---	---
65	4° 15'	---	---
70	3° 30'	---	---
Interstate: 3° 00' (Maximum Curvature) (e max=0.10)			

**Table 2.8.4 Maximum Horizontal Curvature
 Using Normal Cross Slopes (-0.02)**

MAXIMUM CURVATURE (Degrees)		
Design Speed (mph)	Curvature (e max = 0.10)	Curvature (e max = 0.05)
30	1° 30'	7° 00'
35	1° 30'	5° 00'
40	1° 00'	3° 45'
45	0° 30'	2° 45'
50	0° 30'	2° 00'
55	0° 30'	---
60	0° 15'	---
65	0° 15'	---
70	0° 15'	---

2.8.1.2 Supplemental Alignment Control (Intersections)

For redirection or offset deflection of through lanes through intersections, see the values given in **Table 2.8.1b**. Curves are not required for these angular breaks.

2.8.1.3 Roadway Transitions

Transition details have been developed and included in the **Design Standards**. Transitions on curved alignment will require special design details in the contract plans.

2.8.2 Vertical Curves

Minimum lengths for crest and sag vertical curves are provided in **Tables 2.8.5 – 2.8.6**. K values for crest vertical curves are based on an eye height of 3.5' and an object height of 6".

**Table 2.8.5 Minimum Lengths of Crest Vertical Curves
 Based on Stopping Sight Distance**

K VALUES FOR CREST CURVES		
Design Speed (mph)	Interstate	All Other Facilities
15	----	5
20	----	10
25	----	19
30	----	31
35	----	47
40	----	70
45	----	98
50	----	136
55	245	185
60	313	245
65	401	313
70	506	401
Length, L = KA Where: L = Minimum Length (feet) K = Constant A = Algebraic Difference In Grades (percent)		
K values for crest vertical curves are based on an eye height of 3.5' and an object height of 6".		
Interstates:	Lengths of crest vertical curves on Interstate mainlines are not to be less than 1000 ft. for open highways and 1800 ft. within interchanges.	
Service Interchanges:	K values for ramp crest vertical curves at interstate terminals are not to be less than the Interstate K values. K values for other ramp crest vertical curves are not to be less than the K values for All Other Facilities.	
System Interchanges:	K values for all crest vertical curves on systems interchanges are not to be less than the K values of the higher system.	
Arterials and Collectors:	The minimum lengths of crest vertical curves for highways with design speeds of 50 mph or greater are as follows:	
Design Speed (mph)	50	55
Minimum Length (ft.)	300	350
	400	450
	500	500
Low Speed Facilities:	The lengths of crest vertical curves are not to be less than 3 times the design speed (mph) expressed in feet.	

**Table 2.8.6 Minimum Lengths of Sag Vertical Curves
 Based on Stopping Sight Distance and Headlight Sight Distance**

K VALUES FOR SAG CURVES						
Design Speed (mph)	Interstate	All Other Facilities				
15	----	10				
20	----	17				
25	----	26				
30	----	37				
35	----	49				
40	----	64				
45	----	79				
50	----	96				
55	136	115				
60	157	136				
65	181	157				
70	206	181				
<p>Length, $L = KA$ Where: L = Minimum Length (feet) K = Constant A = Algebraic Difference In Grades (percent)</p>						
Interstates:	Lengths of sag vertical curves on Interstate mainlines are not to be less than 800 ft.					
Service Interchanges:	K values for ramp sag vertical curves at interstate terminals are not to be less than the interstate K values. K values for other ramp sag vertical curves are not to be less than the K values for All Other Facilities.					
System Interchanges:	K values for all sag vertical curves on systems interchanges are not to be less than the K values of the higher system.					
Arterials and Collectors:	The minimum lengths of sag vertical curves for highways with design speeds of 50 mph or greater are as follows:					
	Design Speed (mph)	50	55	60	65	70
	Minimum Length (ft.)	200	250	300	350	400
Low Speed Facilities:	The lengths of sag vertical curves are not to be less than 3 times the design speed (mph) expressed in feet.					

2.9 Superelevation

Superelevation rates of 0.10 maximum (rural) and 0.05 maximum (urban) are used by the Department on the State Highway System. Charts for these rates are in the criteria tables and figures. Additional data is contained in the ***Design Standards, Indexes 510 and 511***.

The standard superelevation transition places 80% of the transition on the tangent and 20% on the curve. In transition sections where the cross slope is less than 1.5 %, a minimum longitudinal grade of 0.5% shall be maintained, unless the outside edge of pavement maintains a minimum grade of 0.2% (0.5% for curb and gutter).

When superelevation is required for curves in opposite directions on a common tangent, a suitable distance is required between the curves. This suitable tangent length should be determined as follows:

1. 80% of the transition for each curve should be located on the tangent.
2. The suitable tangent length is the sum of the two 80% distances, or greater.
3. Where alignment constraints dictate a less than desirable tangent length between curves, an adjustment of the 80/20 superelevation transition treatment is allowed (where up to 50% of the transition may be placed on the curve).

Table 2.9.1 Superelevation Rates for Rural Highways, Urban Freeways and High Speed Urban Highways ($e_{max} = 0.10$)

TABULATED VALUES										
Degree of Curve <i>D</i>	Radius <i>R</i> (ft.)	DESIGN SPEED (mph)								
		30	35	40	45	50	55	60	65	70
0° 15'	22,918	NC	NC	NC	NC	NC	NC	NC	NC	NC
0° 30'	11,459	NC	NC	NC	NC	NC	NC	RC	RC	RC
0° 45'	7,639	NC	NC	NC	NC	RC	RC	0.023	0.025	0.028
1° 00'	5,730	NC	NC	NC	RC	0.021	0.025	0.030	0.033	0.037
1° 15'	4,584	NC	NC	RC	0.022	0.026	0.031	0.036	0.041	0.046
1° 30'	3,820	NC	RC	0.021	0.026	0.031	0.037	0.043	0.048	0.054
	* <i>R</i> _{NC}									
2° 00'	2,865	RC	0.022	0.028	0.034	0.040	0.048	0.055	0.062	0.070
	* <i>R</i> _{RC}									
2° 30'	2,292	0.021	0.028	0.034	0.041	0.049	0.058	0.067	0.075	0.085
3° 00'	1,910	0.025	0.032	0.040	0.049	0.057	0.067	0.077	0.087	0.096
3° 30'	1,637	0.029	0.037	0.046	0.055	0.065	0.075	0.086	0.095	0.100
4° 00'	1,432	0.033	0.042	0.051	0.061	0.072	0.083	0.093	0.099	Dmax = 3° 30'
5° 00'	1,146	0.040	0.050	0.061	0.072	0.083	0.094	0.098	Dmax = 4° 15'	
6° 00'	955	0.046	0.058	0.070	0.082	0.092	0.099	Dmax = 5° 15'		
7° 00'	819	0.053	0.065	0.078	0.089	0.098	Dmax = 6° 30'			
8° 00'	716	0.058	0.071	0.084	0.095	0.100				
9° 00'	637	0.063	0.077	0.089	0.098		Dmax = 8° 15'			
10° 00'	573	0.068	0.082	0.094	0.100					
11° 00'	521	0.072	0.086	0.097		Dmax = 10° 15'				
12° 00'	477	0.076	0.090	0.099						
13° 00'	441	0.080	0.093	0.100						
14° 00'	409	0.083	0.096		Dmax = 13° 15'					
15° 00'	382	0.086	0.098							
16° 00'	358	0.089	0.099							
18° 00'	318	0.093		Dmax = 17° 45'						
20° 00'	286	0.097								
22° 00'	260	0.099								
24° 00'	239	0.100								
		Dmax = 24° 45'								
* NC/RC and RC/e Break Points (Radius in feet)										
Break Points	DESIGN SPEED (mph)									
	30	35	40	45	50	55	60	65	70	
<i>R</i> _{NC}	3349	4384	5560	6878	8337	9949	11709	13164	14714	
<i>R</i> _{RC}	2471	3238	4110	5087	6171	7372	8686	9783	10955	
$e = NC$ if $R \geq R_{NC}$ $e = RC$ if $R < R_{NC}$ and $R \geq R_{RC}$										

NC = Normal Crown (-0.02) RC = Reverse Crown (+0.02)
*R*_{NC} = Minimum Radius for NC *R*_{RC} = Minimum Radius for RC

Rates for intermediate *D*'s and *R*'s are to be interpolated

Figure 2.9.1 Superlevation Rate For Rural Highways, Urban Freeways and High Speed Urban Highways ($e_{max} = 0.10$)

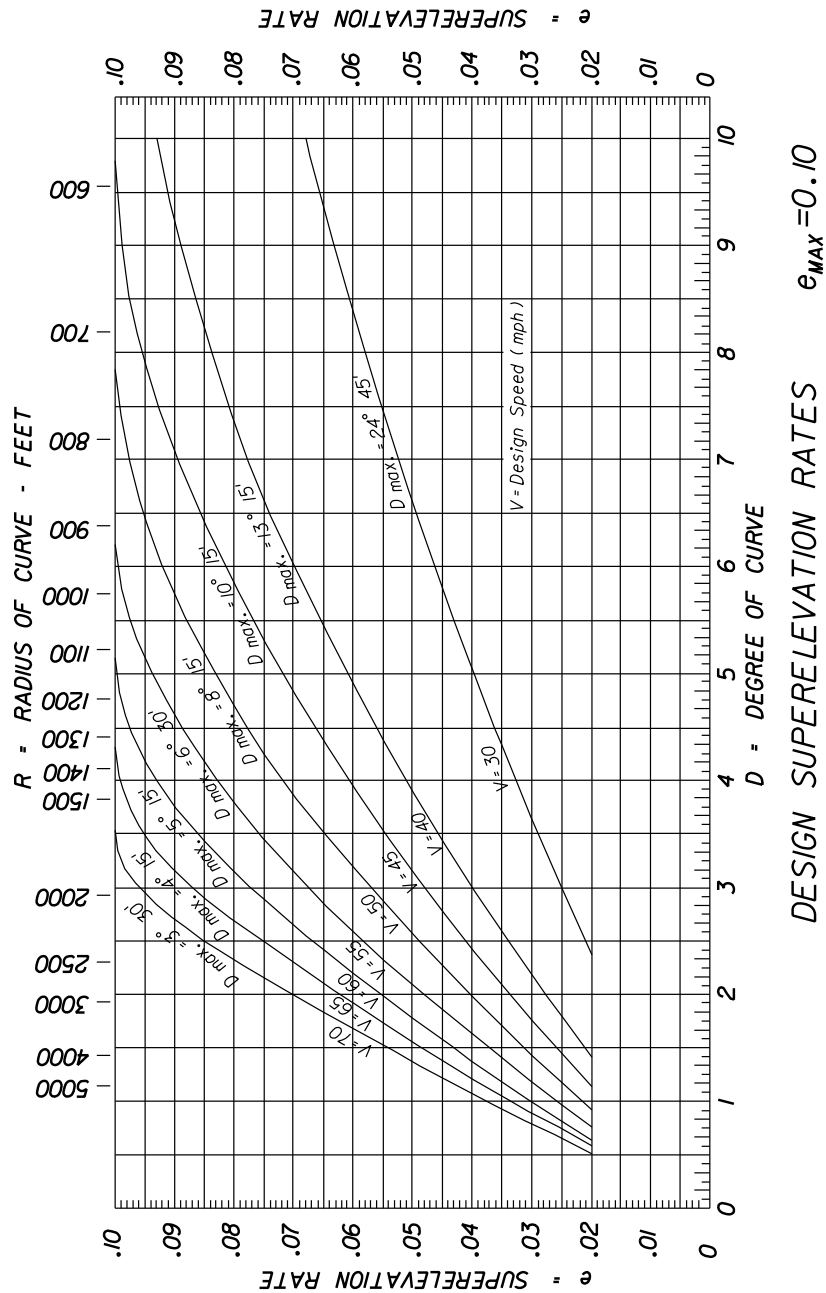

**Table 2.9.2 Superelevation Rates for Urban Highways
 and High Speed Urban Streets ($e_{max} = 0.05$)**

TABULATED VALUES						
Degree of Curve <i>D</i>	Radius <i>R</i> (ft.)	DESIGN SPEED (mph)				
		30	35	40	45	50
2° 00'	2,865	NC	NC	NC	NC	NC
2° 15'	2,546					RC
2° 45'	2,083				NC	
3° 00'	1,910				RC	
3° 45'	1,528			NC		
4° 00'	1,432			RC		
4° 45'	1,206					RC
5° 00'	1,146		NC			0.023
5° 15'	1,091		RC			0.027
5° 30'	1,042					0.030
5° 45'	996					0.035
6° 00'	955				RC	0.040
6° 15'	917				0.022	0.045
6° 30'	881				0.024	0.050
6° 45'	849				0.027	Dmax = 6° 30'
7° 00'	819	NC			0.030	
7° 15'	790	RC			0.033	
7° 30'	764				0.037	
7° 45'	739				0.041	
8° 00'	716			RC	0.045	
8° 15'	694			0.022	0.050	
8° 30'	674			0.025	Dmax = 8° 15'	
8° 45'	655			0.027		
9° 00'	637			0.030		
9° 30'	603			0.034		
10° 00'	573			0.040		
10° 30'	546		RC	0.047		
11° 00'	521		0.023	Dmax = 10° 45'		
11° 30'	498		0.026			
12° 00'	477		0.030			
13° 00'	441		0.036			
14° 00'	409	RC	0.045			
15° 00'	382	0.023	Dmax = 14° 15'			
16° 00'	358	0.027				
17° 00'	337	0.032				
18° 00'	318	0.038				
19° 00'	302	0.043				
20° 00'	286	0.050				
		Dmax = 20° 00'				

NC = Normal Crown (-0.02)

RC = Reverse Crown (+0.02)

Figure 2.9.2 Superelevation Rates for Urban Highways and High Speed Urban Streets ($e_{max} = 0.05$)

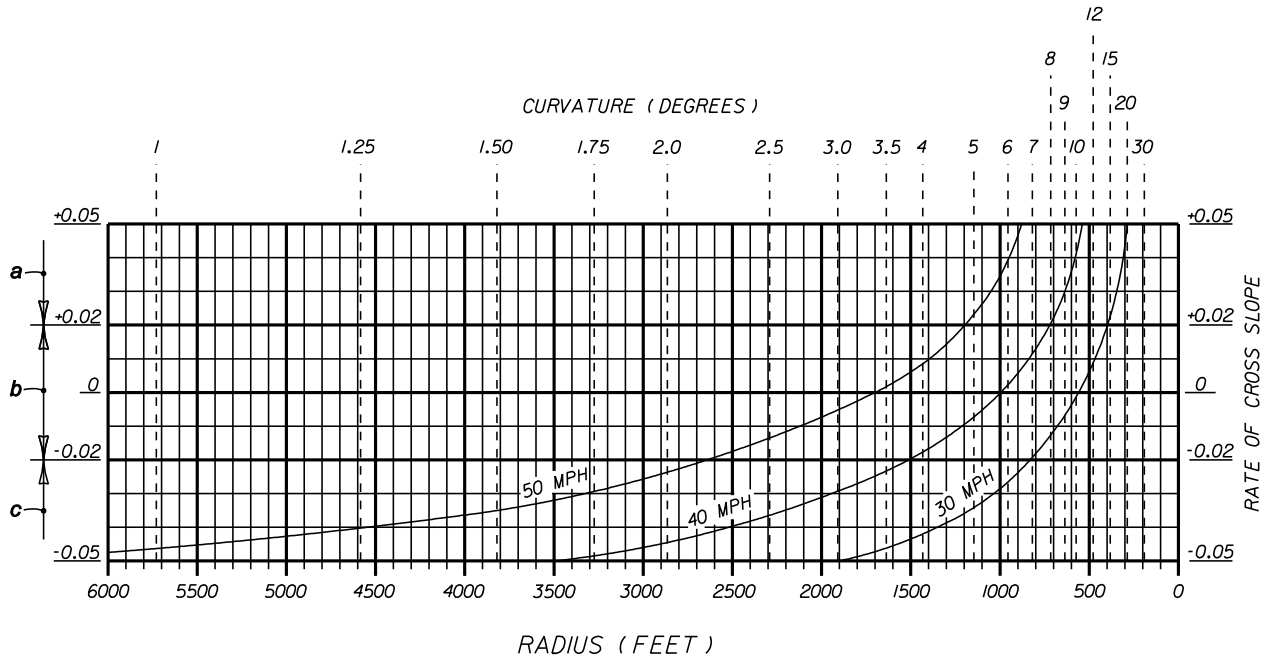

- a. When the speed curves and the degree of curve lines intersect above this line, the pavement is to be superelevated (positive slope) at the rates indicated at the lines intersecting points.
- b. When the speed curves and the degree of curve lines intersect between these limits, the pavement is to be superelevated at the rate of 0.02 (positive slope).
- c. When the speed curves and the degree of curve lines intersect below this line, the pavement is to have normal crown (typically 0.02 and 0.03 downward slopes).

Table 2.9.3 Superelevation Transition Slope Rates for Rural Highways, Urban Freeways and High Speed Urban Highways

SLOPE RATES FOR STRAIGHT LINE SUPERELEVATION TRANSITIONS				
SECTION	Design Speed (mph)			
	35-40	45-50	55-60	65-70
SLOPE RATES				
2 Lane & 4 Lane	1:175	1:200	1:225	1:250
6 Lane	---	1:160	1:180	1:200
8 Lane	---	1:150	1:170	1:190

The length of superelevation transition is to be determined by the relative slope rate between the travel way edge of pavement and the profile grade, except that the minimum length of transition shall be 100 feet.

For additional information on transitions, see the *Design Standards, Index 510*.

Table 2.9.4 Superelevation Transition Slope Rates for Urban Highways and High Speed Urban Streets

SLOPE RATES FOR STRAIGHT LINE SUPERELEVATION TRANSITIONS	
30 mph	1:100
40 mph	1:125
45-50 mph ¹	1:150

1. A slope rate of 1:125 may be used for 45 mph under restricted conditions.

The length of superelevation transition is to be determined by the relative slope rate between the travel way edge of pavement and the profile grade, except that the minimum length of transition shall be 50 ft. for design speeds under 40 mph and 75 ft. for design speeds of 40 mph or greater. For additional information on transitions, see the *Design Standards, Index 511*.

2.10 Vertical Clearance

Minimum vertical clearances, with the exception of structures over water (see **Section 2.10.1**), are contained in the criteria tables and figures. On rural Interstate routes or single Interstate routes through urban areas, approved Design Exceptions are required for bridge vertical clearances less than 16 feet and must be coordinated with Surface Deployment and Distribution Command Transportation Engineering Agency (SDDCTEA) as described in **Section 23.3**. For bridges, sign structures and signal structures, minimum vertical clearance is the least distance measured between the bridge superstructure, signs, signals, luminaires or support members and the traffic lane or shoulder directly below.

For any construction affecting existing bridge clearances (e.g., bridge widenings or resurfacing) vertical clearances less than 16'-0" shall be maintained or increased. If reducing the design vertical bridge clearance to a value between 16'-0" and 16'-2", the design vertical clearance dimension in the plans shall be stated as a minimum with a note requiring the contractor to submit a certified survey confirming the as-built least vertical clearance is greater than the design vertical clearance.

For any construction affecting existing signs, vertical clearances less than 17'-0" shall be maintained or increased. For any construction affecting existing Dynamic Message Sign (DMS) structure clearances, all vertical clearances shall be maintained or increased.

For any construction affecting existing traffic signals, vertical clearances between 15'-0" and 17'-0" shall be maintained or increased. Vertical clearances less than 17'-0" will require a Design Variation. Existing signal vertical clearances below 15'-0" shall be "warranted for replacement". No Design Variations will be approved allowing signal vertical clearances less than 15'-0".

Figure 2.10.1 Clearances – Rural and Urban Interstates (Freeways), Arterials and Collectors, with Projected 20-Year ADT of 1500 or Greater

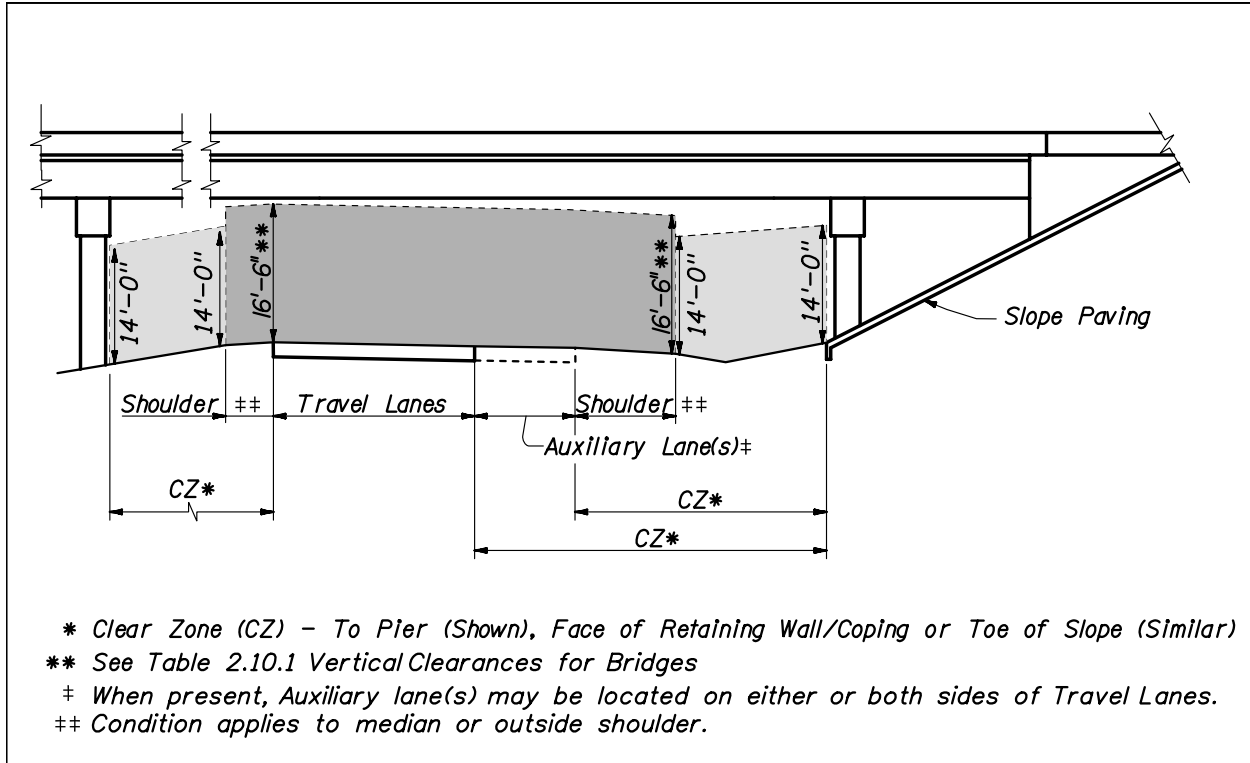
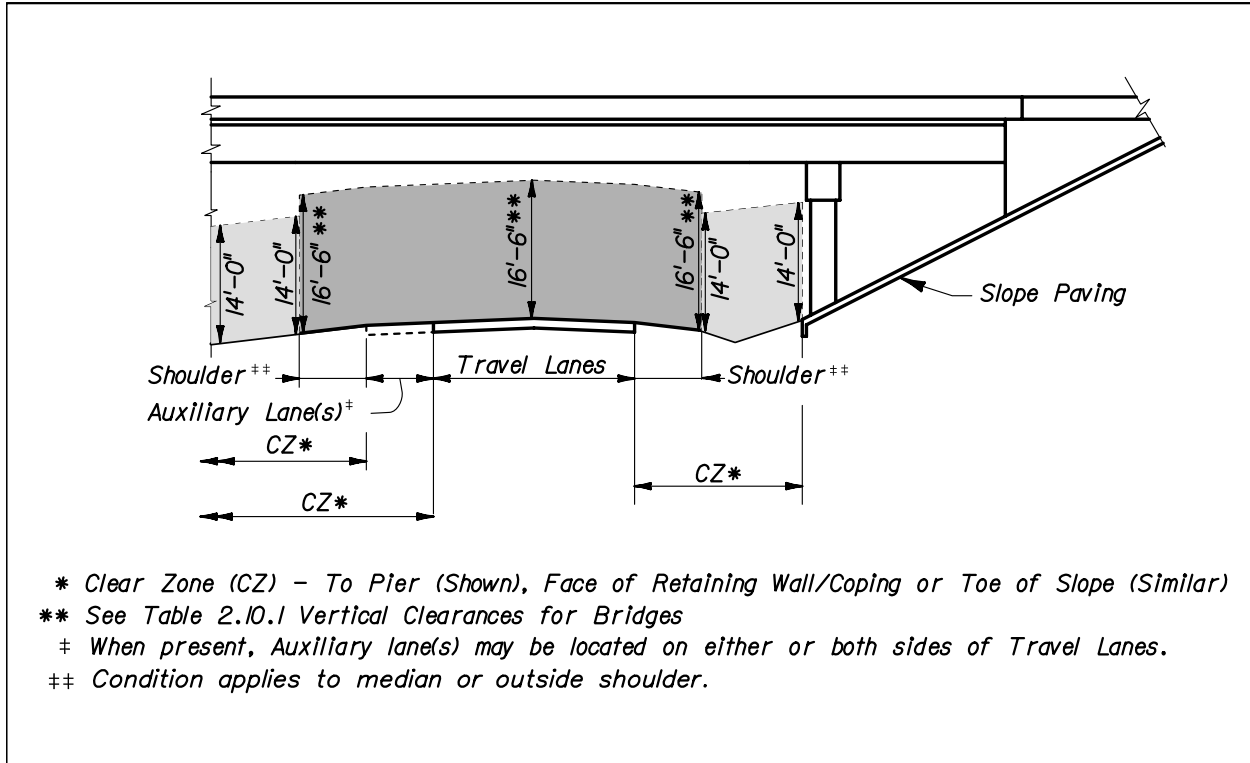
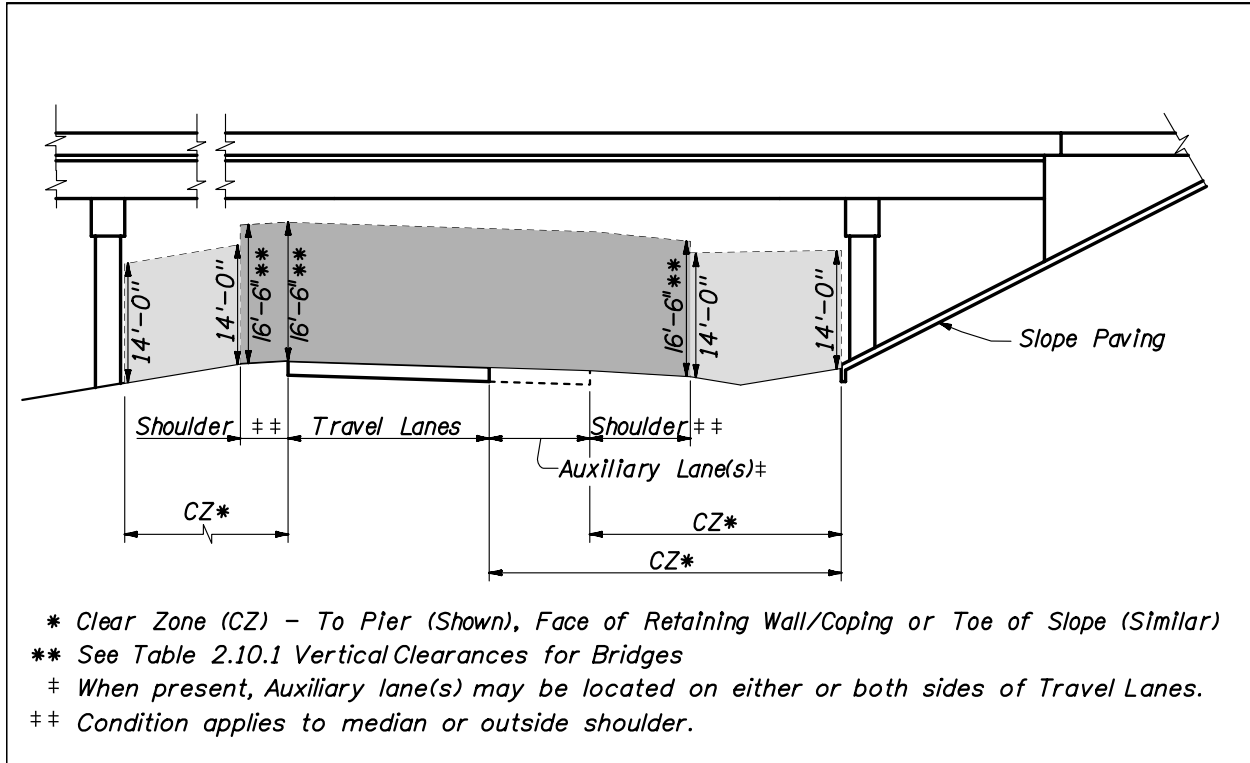

Figure 2.10.2 Clearances – Rural Arterials and Collectors with Projected 20-Year ADT of Less than 1500



**Figure 2.10.3 Clearances – Urban Arterials and Collectors
(Without Curb and Gutter) with Projected 20-Year ADT of Less than 1500**



**Figure 2.10.4.A Clearances – Urban Arterials and Collectors
 (Curb and Gutter) ≤ 45 mph – Elevation of Bridge**

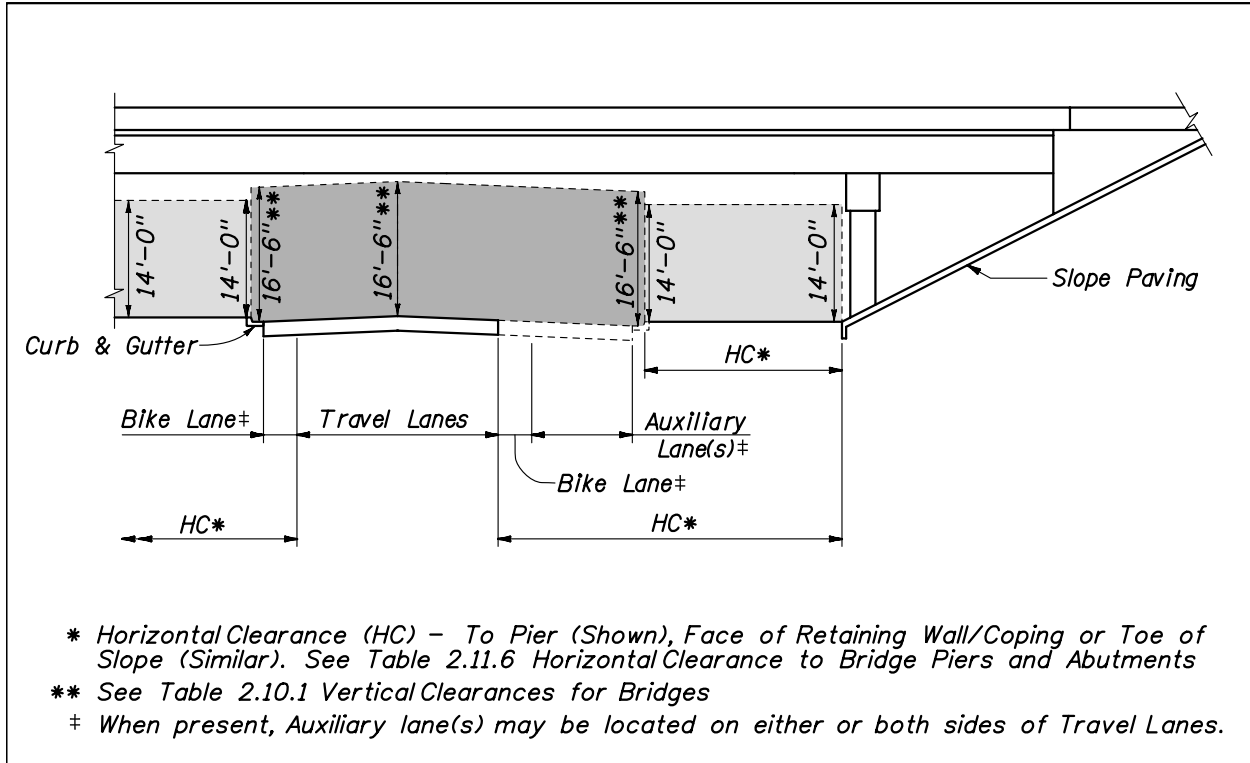

Figure 2.10.4.B Clearances – Urban Arterials and Collectors (Curb and Gutter) ≤ 45 mph – Section through Bridge

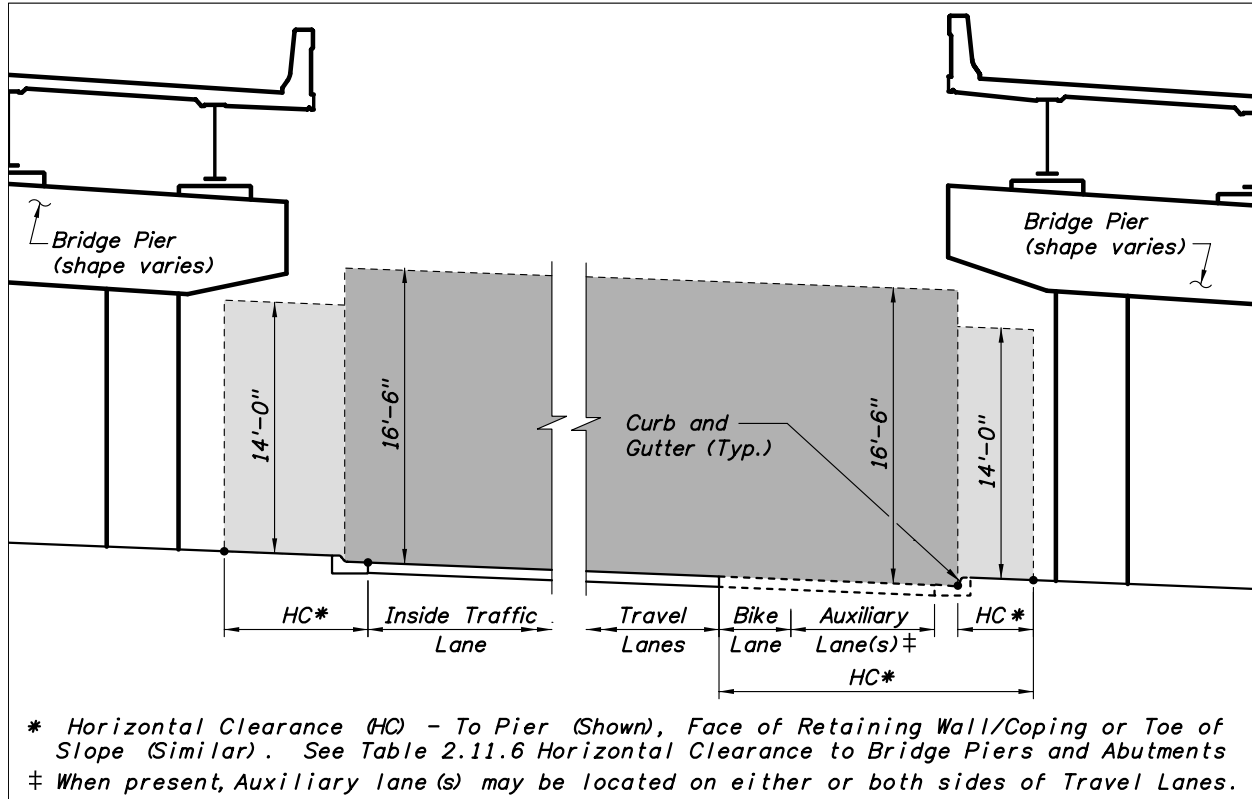

Figure 2.10.5 Clearances – Urban Arterials and Collectors (Curb and Gutter) with Traffic Barrier

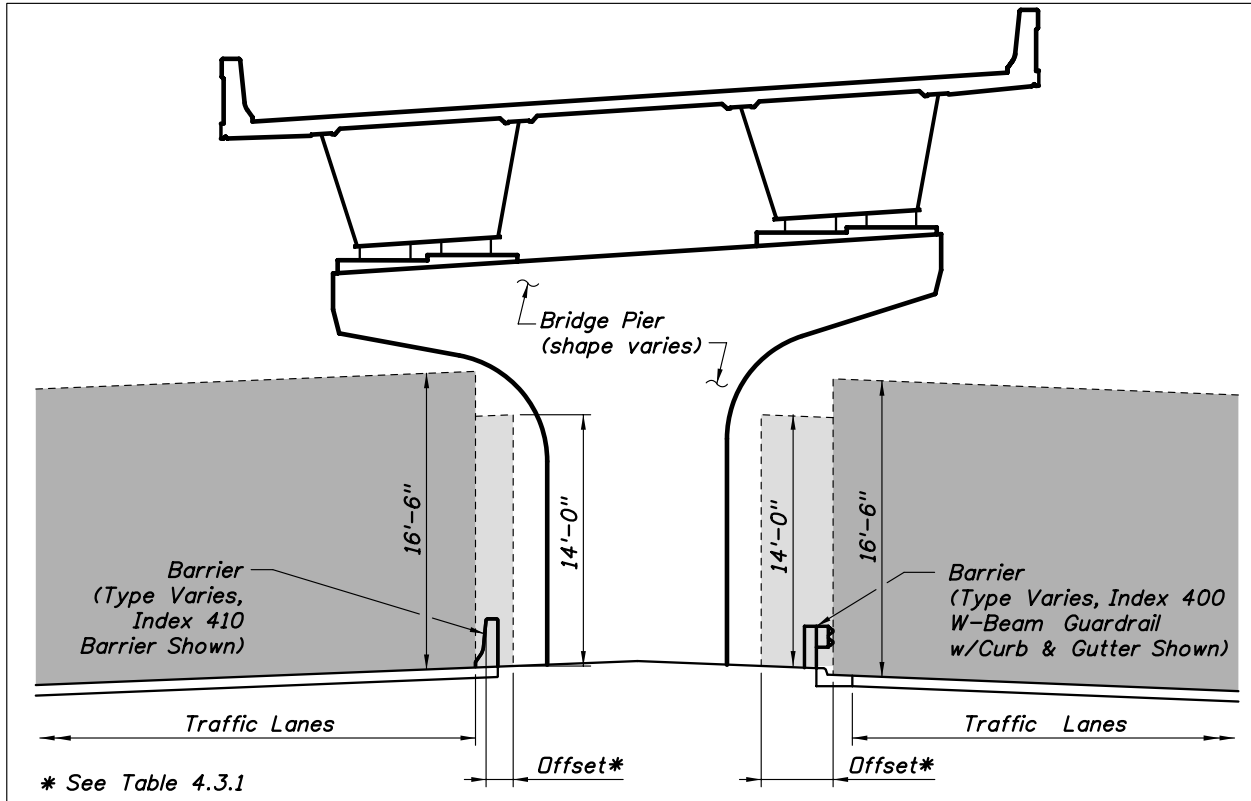

Table 2.10.1 Minimum Vertical Clearances for New Bridges

FACILITY TYPE (Freeways, Arterials, Collectors & Others) ₁	CLEARANCE
Roadway or Railroad Over Roadway	16'-6"
Roadway Over Railroad	23'-6" ₂
Pedestrian Over Roadway	17'-6"
Pedestrian Over Railroad	23'-6" ₂

1. For Clearance Over Waterways, see **Section 2.10.1** of this volume.
2. Over High Speed Rail Systems, see **Section 6.3.5** of this volume and the latest version of **American Railway Engineering and Maintenance-of-Way Association (AREMA)** guidelines, or the design office of the high speed rail line of interest for specific guidelines and specifications. Over Electrified Railroad, the minimum vertical clearance shall be 24 feet 3 inches. (See **Topic No. 000-725-003: South Florida Rail Corridor Clearance.**) Also see **Section 6.3.5** of this volume.

Table 2.10.2 Minimum Vertical Clearances for New Sign and Signal Structures

TYPE OF STRUCTURE	CLEARANCE
Overhead Sign Structures	17'-6"
Overhead Dynamic Message Sign Structures	19'-6"
Signals on Span Wires, Mast Arms, or Other Structures	17'-6"

2.10.1 Vertical Clearance Over Water

The minimum vertical clearance over water shall conform to the following criteria:

1. Environment:

For concrete superstructures classified as moderately aggressive or extremely aggressive due to chloride content, the minimum vertical clearance is 12 ft. above Mean High Water (MHW).

For steel superstructures, the minimum vertical clearance shall be obtained from the District Bridge Maintenance Engineer, but shall not be less than those specified above for the concrete superstructures.

Modification for Non-Conventional Projects:

Delete the above paragraph and replace with the following:

For steel superstructures, the minimum vertical clearance shall not be less than those specified above for the concrete superstructures or as specified in the RFP.

2. Drainage:

The minimum vertical clearance between the design flood stage and the low member of bridges shall be a minimum of two feet. This clearance is necessary to allow the majority of debris to pass without causing damage to the structure. This standard does not apply to culverts and bridge-culverts.

3. Navigation:

The minimum vertical clearance for navigational purposes shall be:

- A. 6 feet above the Mean High Water for tidewater bays and streams
- B. 6 feet above the Normal High Water for freshwater rivers, streams, non-regulated/controlled canals, and lakes
- C. 6 feet above the control elevation for regulated/controlled lakes and canals

Minimal vertical at the navigable channel clearance is measured from the low point of the structural member of the bridge. Navigation lights shall not be considered in the vertical clearance.

Coastal bridges:

The vertical clearance of the superstructure shall be a minimum of 1 ft. above the 100-year design wave crest elevation including the storm surge elevation and

wind setup. For bridge designs where this criterion cannot practically be met, refer to the ***FDOT Drainage Manual, Section 4.9.5***.

Information on the Normal High Water, control water elevation, or Mean High Water can be obtained from the appropriate Drainage Design Engineer.

Widening of existing structures which do not meet the minimum vertical clearance criteria stated above (either before or after the widening) may be justified hydraulically and/or economically. However, the encroachment of vertical clearance criteria may be limited and must be approved by the agency having jurisdiction over the navigable waterway.

2.10.2 Horizontal Waterway Clearance

The following minimum horizontal clearances shall be provided:

1. For crossings subject to boat traffic a minimum horizontal clearance of 10 feet shall be provided.
2. Where no boat traffic is anticipated, horizontal clearance shall be provided consistent with debris conveyance needs and structure economy.

Horizontal clearance is defined as the unobstructed clear distance between piers, fender systems, culvert walls, etc. projected by the bridge normal to the flow.

2.10.3 Regulatory Agency Requirements

Vertical and horizontal clearances will also be subject to the requirements of the Coast Guard, Corps of Engineers, Water Management District, and any other regulatory agency having appropriate statutory jurisdiction or authority. Such regulatory agency requirements may exceed Department requirements.

2.10.4 Airspace Obstructions

Federal, state, and local regulations exist to protect the national airspace system that must be considered when planning and implementing construction that may adversely impact military or public-use aviation facilities (airport, seaport, or heliport), navigational aids, and instrument approach flight procedures in Florida.

FAA Notification:

Federal law, **Title 14 Code of Federal Regulations (CFR), Federal Aviation Regulations (FAR), Part 77, “Objects Affecting Navigable Airspace”**, requires that prior notification must be given to the Federal Aviation Administration (FAA) regarding any construction or alteration (permanent or temporary) of structures that meet the specific criteria given in **Table 2.10.3**.

For further guidance on airspace obstructions (notification and permitting) refer to **Section 13.5.1, FDOT Aviation and Spaceports Office Coordination**, this volume.

Modification for Non-Conventional Projects:

See RFP for design build coordination of air space requirements.

Table 2.10.3 FAA Notification Requirements

FAA Notification Requirements for Construction or Alteration of Structures *	
1.	Any structure more than 200 feet above ground level (AGL) at its site.
2.	Any structure that is near an aviation facility and that penetrates an imaginary obstacle surface extending outward and upward at one of the following criteria: <ul style="list-style-type: none"> a. A slope of 100 to 1 (1 foot upward for each 100 feet outward) for a horizontal distance of 20,000 feet from the nearest point of the nearest military or public-use airport runway that is more than 3,200 feet in length (excludes heliports). b. A slope of 50 to 1 (1 foot upward for each 50 feet outward) for a horizontal distance of 10,000 feet from the nearest point of the nearest military or public-use airport runway no more than 3,200 feet in length (excludes heliports). c. A slope of 25 to 1 (1 foot upward for each 25 feet outward) for a horizontal distance of 5,000 feet from the nearest point of the nearest military or public-use heliport landing and takeoff area.
3.	Any highway, railroad, or other traverse way for mobile objects, of a height which, if adjusted upward by the amount shown below, would exceed a standard of paragraph 1 or 2 above: <ul style="list-style-type: none"> a. An adjusted height of 17 feet for an Interstate Highway that is part of the National System of Military and Interstate Highways where over-crossings are designed for a minimum of 17 feet vertical distance. b. An adjusted height of 15 feet for any other public roadway. c. An adjusted height of 10 feet or the height of the highest mobile object that would normally traverse the road, whichever is greater, for a private road. d. An adjusted height of 23 feet for a railroad. e. An adjusted height equal to the height of the highest mobile object that would normally traverse it, for a waterway or traverse way not previously mentioned.
4.	Any structure located directly on a public-use aviation facility property, including any facility that is currently existing, planned, proposed, or under construction.
5.	Any structure that is located in an instrument approach area and available information indicates it might exceed federal obstruction standards, if specifically requested by the FAA.
<p>* Note: Structures may include: Highways, roads, railroads, waterways, traverseways (parking or rest areas), bridges, overpasses, high-mast light poles, utility poles, antenna towers, buildings, signs or billboards, fences, or gates, plus temporary-use construction materials or equipment, including dirt piles and cranes, as well as natural growth, vegetation, and landscaping, depending on location in proximity to an aviation facility, navigational aid, or instrument procedure ground track.</p>	

2.11 Horizontal Clearance

Horizontal clearance is the lateral distance from a specified point on the roadway such as the edge of travel lane or face of curb, to a roadside feature or object. Horizontal clearance applies to all highways. Horizontal clearance requirements vary depending on design speed, whether rural or urban with curb, traffic volumes, lane type, and the object or feature.

Rural highways with flush shoulders and highways with curb or curb and gutter where right of way is not restricted have roadsides of sufficient widths to provide clear zones; therefore, horizontal clearance requirements for certain features and objects are based on maintaining a clear zone wide enough to provide the recoverable terrain in **Table 2.11.11**. The procedure for determining required clear zone widths is described in **Chapter 4** of this volume.

In urban areas, horizontal clearance based on clear zone requirements for rural highways should be provided wherever practical. However, urban areas are typically characterized with lower speed (Design Speed \leq 45 mph) , more dense abutting development, closer spaced intersections and accesses to property, higher traffic volumes, more bicyclists and pedestrians, and restricted right of way. In these areas, curb with closed drainage systems are often used to minimize the amount of right of way needed. Highways with curb or curb and gutter in urban areas where right of way is restricted do not have roadsides of sufficient widths to provide clear zones; therefore, while there are specific horizontal clearance requirements for these highways, they are based on clearances for normal operation and not based on maintaining a clear roadside for errant vehicles. It should be noted that curb has no redirection capabilities except at speeds less than the lowest design speeds used on the State Highway System. Therefore curb should not be considered effective in shielding a hazard. Curb is not to be used to reduce horizontal clearance requirements.

Crashworthy objects shall meet or exceed the offset listed in **Tables 2.11.1** through **2.11.10** and objects that are not crashworthy are to be as close to the right of way line as practical and no closer than the requirements listed in **Tables 2.11.1** through **2.11.10**.

For horizontal clearances where roadways overpass railroads refer to **Chapter 6** of this volume.

Table 2.11.1 Horizontal Clearance for Traffic Control Signs

PLACEMENT	Placement shall be in accordance with the <i>Design Standards</i> . Placement within sidewalks shall be such that an unobstructed sidewalk width of 4 feet or more (not including the width of curb) is provided.
SUPPORTS	Supports, except overhead sign supports, shall be breakaway. When practicable, sign supports should be located behind barriers that are justified for other reasons. Overhead sign supports shall be located outside the clear zone unless shielded.

Table 2.11.2 Horizontal Clearance for Light Poles

CONVENTIONAL LIGHTING	<p>Shall not be located in the median except in conjunction with barriers that are justified for other reasons.</p> <p>Supports shall be breakaway, except for median barrier mounted or shielded light poles.</p> <p>Urban Curb or Curb and Gutter (Design Speed \leq 45 mph): Shall be located no closer than 4 feet from face of curb. Placement within sidewalks shall be such that an unobstructed sidewalk width of 4 feet or more (not including the width of curb) is provided.</p> <p>All other facilities: Shall be located no closer than 20 feet from the travel lane or 14 feet from an auxiliary lane (may be clear zone width when clear zone is less than 20 feet).</p>
HIGHMAST LIGHTING	Shall be located outside the clear zone unless shielded.

Table 2.11.3 Horizontal Clearance for Aboveground Fixed Utilities (AFUs)

<p>Aboveground fixed utilities are objects owned by a public or private utility agency that are more than four (4) inches above the grade and are not accepted by FDOT as crashworthy (such as strain poles, down guys, telephone load pedestals, temporary supports, etc.).</p>	
<p>NEW ABOVEGROUND FIXED UTILITIES (AFUs)</p> <p>Other than mid-span poles</p>	<p>For urban roadways with curb or curb and gutter with design speeds less than or equal to 45 mph, new AFUs shall not be placed closer than 4 feet from the face of curb and as close to the R/W as practical.</p> <p>For all other roadways the AFUs are to be outside the Clear Zones established using Table 2.11.11 Recoverable Terrain and as close to the R/W line as practical.</p>
<p>NEW ABOVEGROUND FIXED UTILITIES (AFUs)</p> <p>Mid-span poles</p>	<p>Mid-span poles are new poles being installed as part of and within the alignment of an existing pole line. When the existing alignment crosses an intersecting roadway, the mid-span pole is to be placed as follows:</p> <p>For intersecting roadways that are urban with curb or curb and gutter with design speeds less than or equal to 45 mph, mid-span poles shall not be placed closer than 4 feet from the face of curb.</p> <p>For all other intersecting roadways mid-span poles are to be outside the Clear Zones established for new poles appropriate for the intersecting roadway.</p>
<p>EXISTING ABOVEGROUND FIXED UTILITIES (AFUs)</p>	<p>For urban roadways with curb or curb and gutter with design speeds less than or equal to 45 mph, existing AFUs closer than 4 feet from the face of curb shall be relocated as close to the R/W line as practical.</p> <p>For all other roadways, existing AFUs within the Clear Zones established using Table 2.11.11 Recoverable Terrain shall be relocated as close to the R/W line as practical.</p>

Table 2.11.4 Horizontal Clearance to Traffic Infraction Detectors, Signal Poles and Controller Cabinets for Signals

<p>SIGNAL POLES AND CONTROLLER CABINETS</p>	<p>Shall not be located in medians</p> <p>Shall be located outside the clear zone except as follows:</p> <p style="padding-left: 40px;">Urban Curb or Curb and Gutter (Design Speed ≤ 45 mph): Shall be located no closer than 4 feet from face of outside curbs and outside the sidewalk. However, when necessary, signal poles may be located within sidewalks such that an unobstructed sidewalk width of 4 feet or more (not including the width of curb) is provided.</p>
<p>TRAFFIC INFRACTION DETECTORS</p>	<p>For Traffic Infraction Detector placement and installation specifications, refer to the State Traffic Engineering and Operations Office web page:</p> <p style="text-align: center;">http://www.dot.state.fl.us/trafficoperations/</p>

Table 2.11.5 Horizontal Clearance to Trees

<p>Trees, where the diameter is or is expected to be greater than 4 inches (measured 6 inches above the ground), shall be located outside the clear zone except as follows:</p> <p style="padding-left: 40px;">Urban Curb or Curb and Gutter where Design Speed ≤ 45 mph and where right of way is restricted, shall be located no closer than:</p> <ul style="list-style-type: none"> • 4 feet from face of outside curbs, • 6 feet from edge of inside traffic lane.
--

Table 2.11.6 Horizontal Clearance to Bridge Piers and Abutments

Bridge Piers and Abutments shall be located outside the clear zone (see also **Figures 2.10.1** thru **2.10.3**) except as follows:

Urban Curb or Curb and Gutter (Design Speed \leq 45 mph), shall be located no closer than:

- 16 feet from the edge of the travel lane; or
- 4 feet from face of outside curbs or
- 6 feet from the edge of inside traffic lane:

whichever provides the greater setback. See also **Figures 2.10.4.A** thru **2.10.4.B**.

Rural and Urban with Roadside Barriers:

The minimum barrier offset as shown in **Table 4.3.1** measured from the face of the barrier.
See also **Figure 2.10.5**.

- Notes:
1. Pier protection and design shall comply with the requirements provided in **Structures Design Guidelines, Section 2.6**.
 2. Locate piers outside of clearance envelopes as shown. Additional clearance may be required for sidewalks, shared use paths, intersection sight distance and future widening of the lower roadway.
 3. Evaluate the potential for widening of a lower roadway at a given location based on adjacent geometric constraints, (e.g. other bridge piers, MSE walls, significant water features, etc.).

**Table 2.11.7 Horizontal Clearance to Railroad Grade Crossing
Traffic Control Devices**

Shall be located in accordance with the *Design Standards*.

Table 2.11.8 Horizontal Clearance to Canal and Drop-off Hazards

See *Chapter 4* of this Volume for horizontal clearance criteria for canal and drop-off hazards.

Table 2.11.9 Horizontal Clearance to Other Roadside Obstacles

Shall be located outside the clear zone except as follows:

Urban Curb or Curb and Gutter (Design Speed \leq 45 mph):
Shall be located no closer than 4 feet from face of curb.

Note: Horizontal clearance to mailboxes is specified in the construction details contained in the *Design Standards, Index No. 532*.

Note: Transit and school bus shelters shall be placed in accordance with *Rule Chapter 14-20.003, Florida Administrative Code*. Transit bus benches shall be located in accordance with *Rule Chapter 14-20.0032, F.A.C.*

Table 2.11.10 Horizontal Clearance for ITS Poles and Related Items

<p>POLES AND OTHER ABOVE-GROUND FIXED OBJECTS</p>	<p>Shall not be located in the median except in conjunction with barriers that are justified for other reasons.</p> <p>Shall be located outside the clear zone (as close as practical to the right of way line without aerial encroachments onto private property) except as follows:</p> <p>Urban Curb or Curb and Gutter (Design Speed \leq 45 mph): Shall be located as close to the right of way line as practical; no closer than 4 feet from face of curb. Placement within sidewalks shall be such that an unobstructed sidewalk width of 4 feet or more (not including the width of curb) is provided.</p> <p>May be located behind barriers that are justified for other reasons.</p>
<p>EQUIPMENT SHELTERS AND TOWERS</p>	<p>Shall not be located within the limited-access right of way, except as allowed by <i>Policy No. 000-625-025, Telecommunications Facilities on Limited Access Rights of Way.</i></p>
<p>BREAKAWAY OBJECTS</p>	<p>Shall be located as close to the right of way line as practical, except as follows:</p> <p>Urban Curb or Curb and Gutter (Design Speed \leq 45 mph): Shall be located no closer than 4 feet from the face of curb.</p>

Table 2.11.11 Recoverable Terrain

DESIGN SPEED (mph)	≥ 1500 AADT ⁽¹⁾		< 1500 AADT ⁽¹⁾	
	TRAVEL LANES & MULTILANE RAMPS (feet)	AUXILIARY LANES & SINGLE LANE RAMPS (feet)	TRAVEL LANES & MULTILANE RAMPS (feet)	AUXILIARY LANES & SINGLE LANE RAMPS (feet)
< 45	18	10	16	10
45	24	14	20	14
50	24	14	20	14
55	30	18	24	14
> 55	36	24	30	18

(1) AADT=Mainline 20 years projected annual average daily traffic.

The above values are to be used in the process for determining the clear zone width as described in **Chapter 4** of this volume.

Figure 2.11.1 Horizontal Clearance to Guardrail

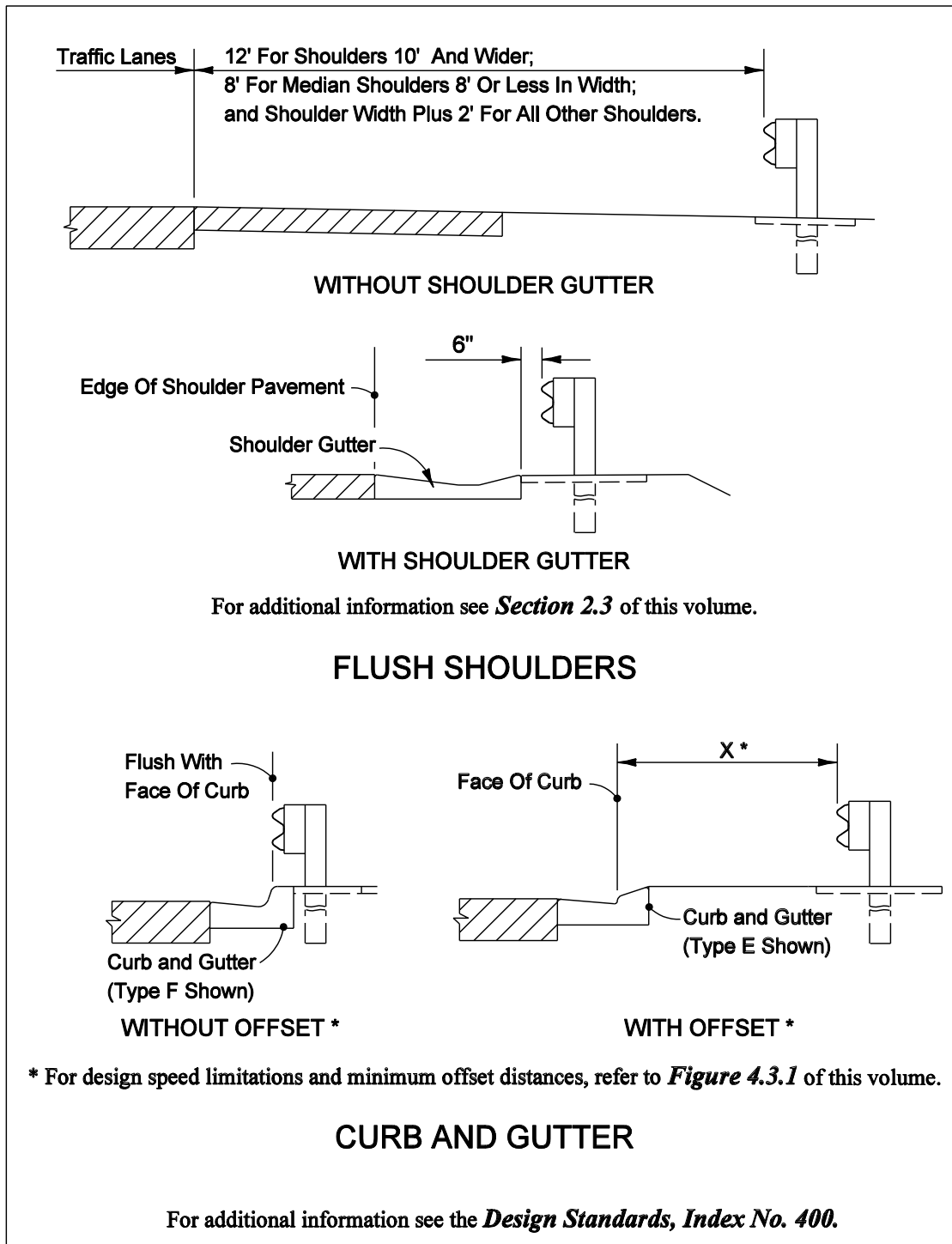

2.12 Bridge Railings and Separators

Bridge railings and separators on new and reconstruction projects shall be designed in accordance with the **Structures Design Guidelines**. On reconstruction projects, where an existing bridge is to remain, existing bridge railings must be replaced or upgraded unless the railing meets criteria for new railings. All superseded FDOT Standard New Jersey Shape and F Shape Traffic Railings conforming to the designs shown in the **Instructions for Design Standards, Index 402, "A Historical Compilation of Superseded Florida Department of Transportation 'Structures Standard Drawings' for 'F' and 'New Jersey' Shape Structure Mounted Traffic Railings"**, are both structurally and functionally adequate.

All other former FDOT bridge traffic railings not listed above, and any other traffic railings that are not based on crash tested designs, are inadequate and shall be replaced, retrofitted or excepted, as appropriate, using the criteria included in the **Structures Design Guidelines**.

Details and typical applications of various bridge rails and separators are given in **Figures 2.12.1 – 2.12.12**.

Figure 2.12.1 Bridge Traffic Railings – "F" Shapes

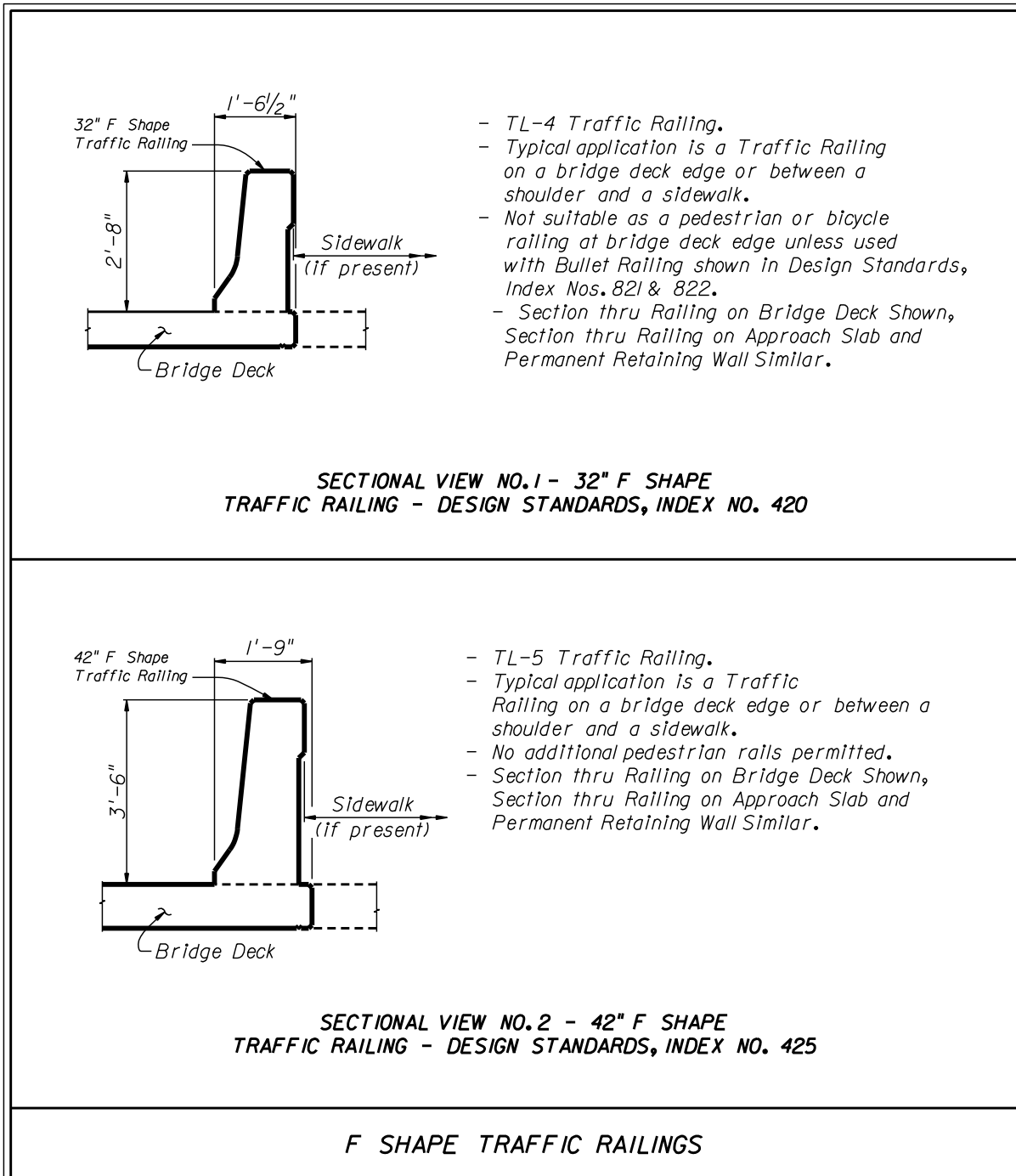

Figure 2.12.2 Bridge Traffic Railings – Vertical Shapes

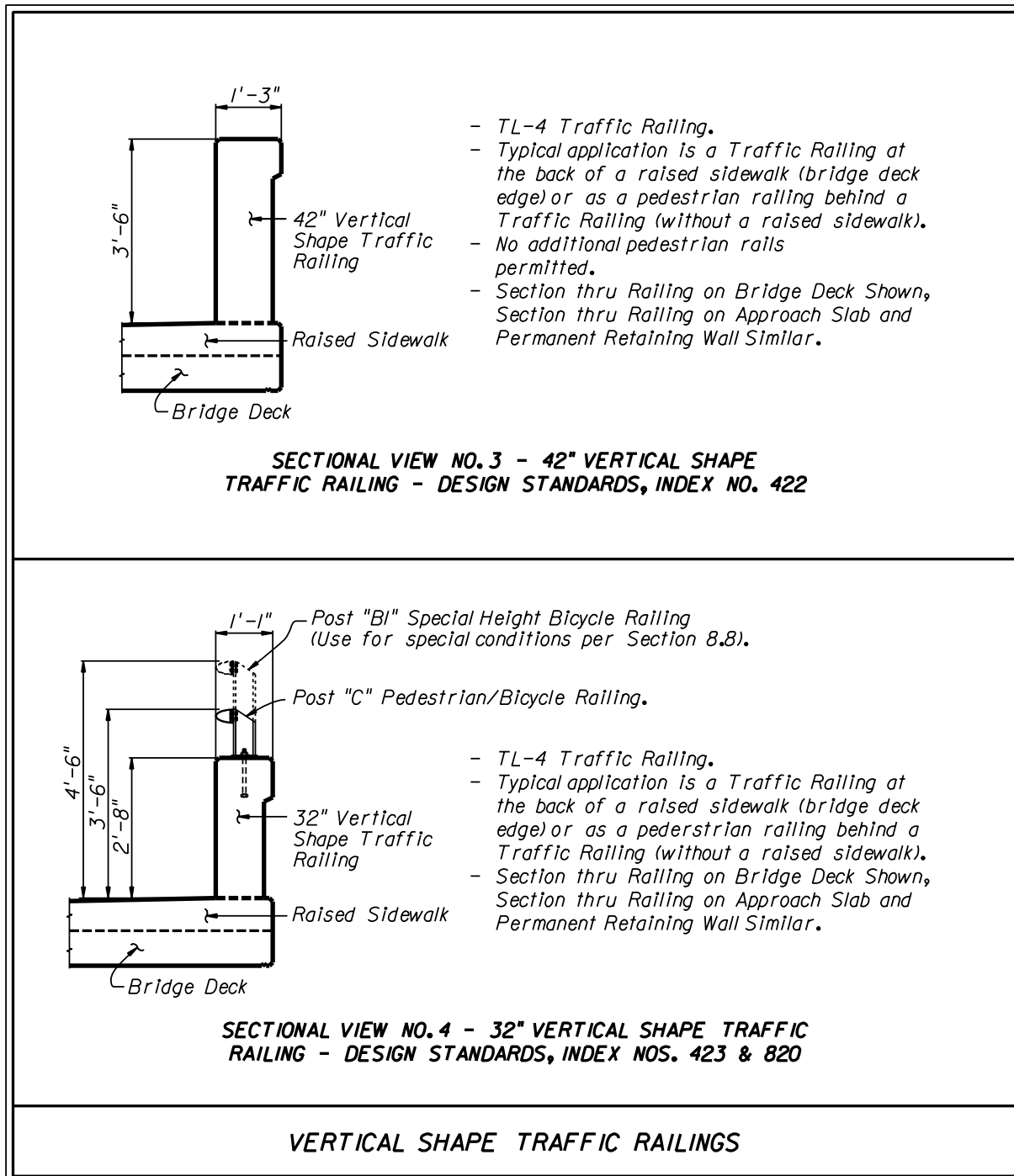

Figure 2.12.3 Bridge Traffic Railings – Other Shapes

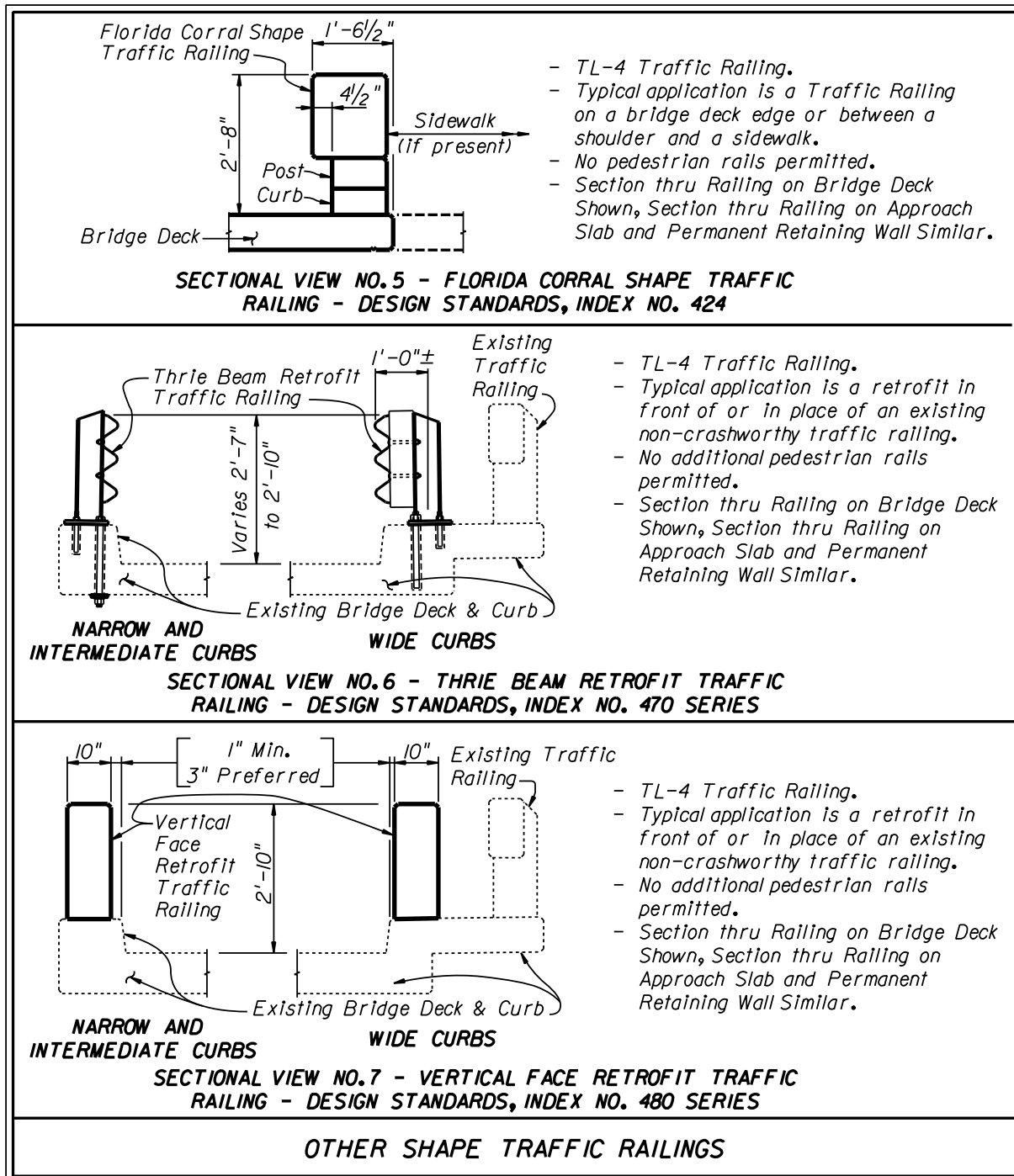

Figure 2.12.4 Bridge Traffic Railings – Noise Barrier Combination

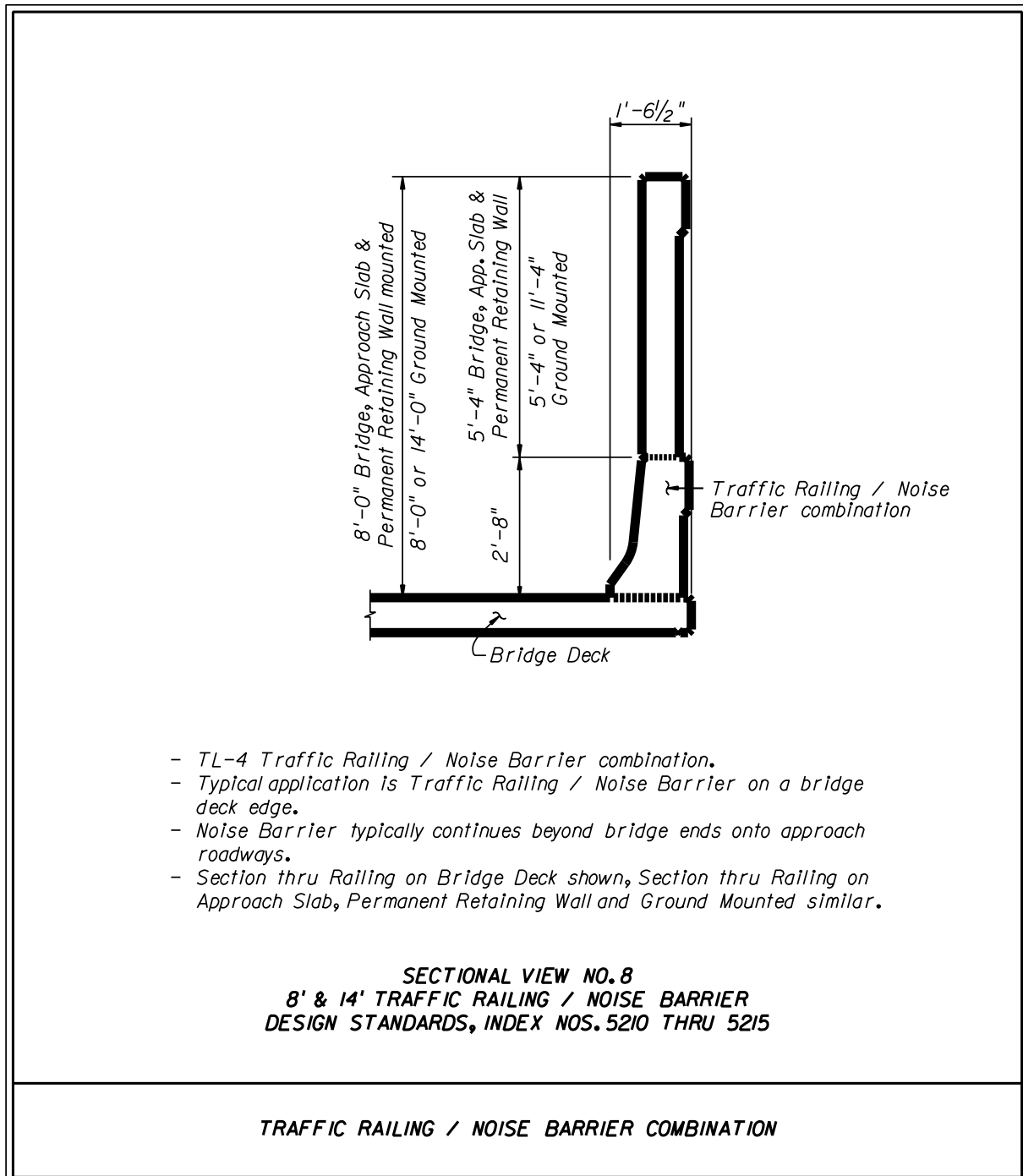

Figure 2.12.5 Bridge Railing and Separators – Median Traffic Railing and Separators

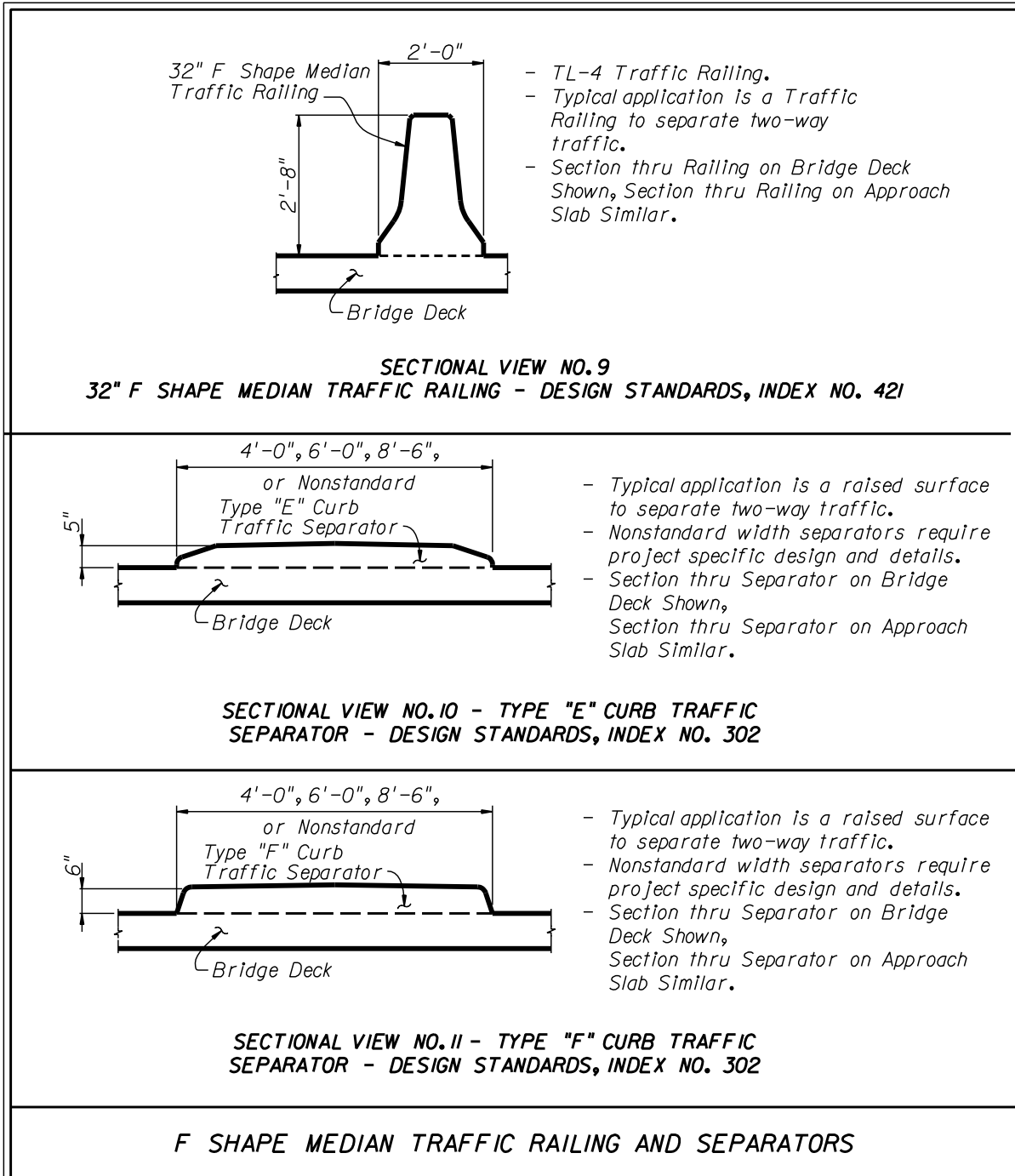

Figure 2.12.6 Bridge Fencing for Traffic Railings

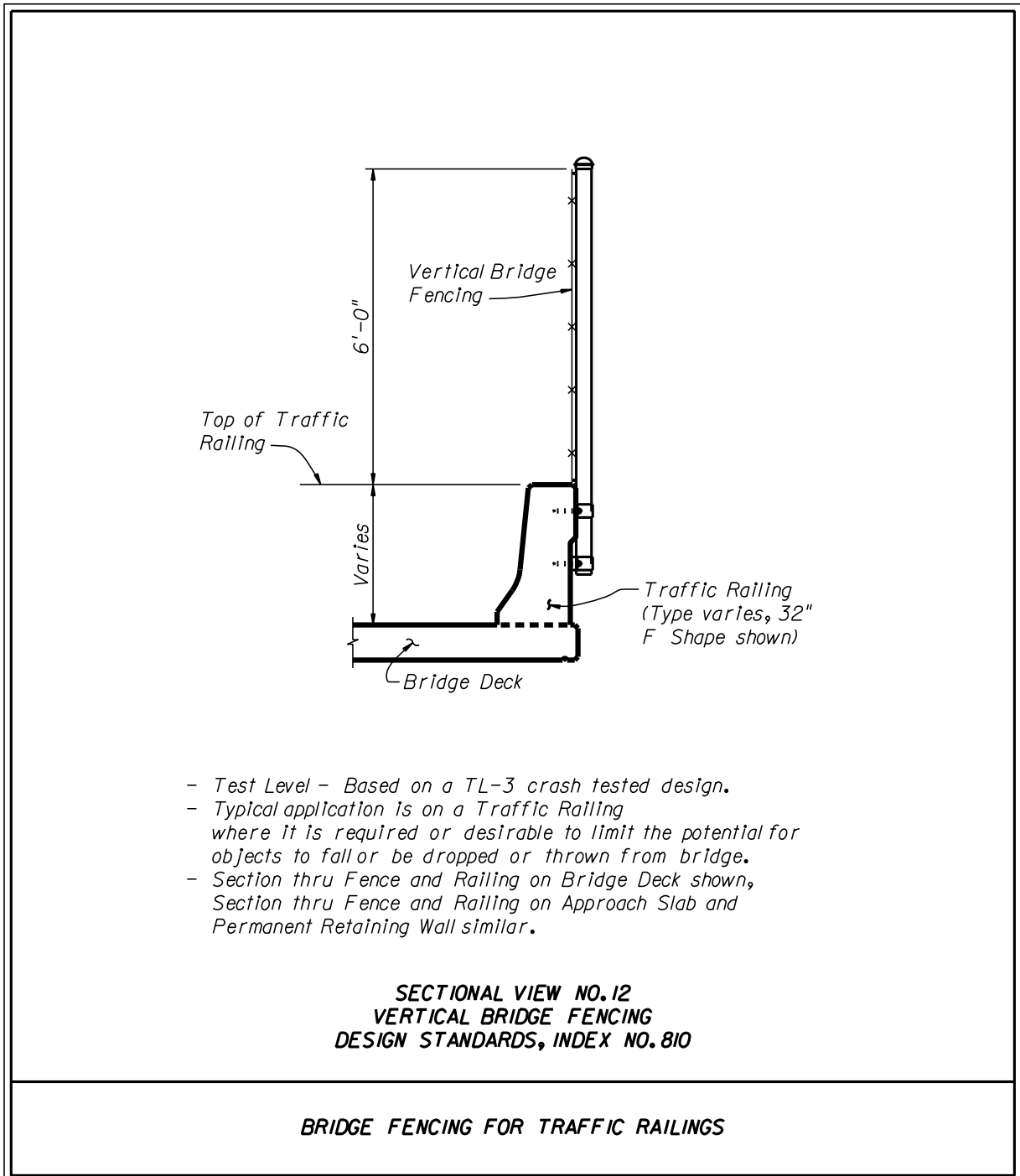

Figure 2.12.7 Bridge Railing – Pedestrian / Bicycle Railing

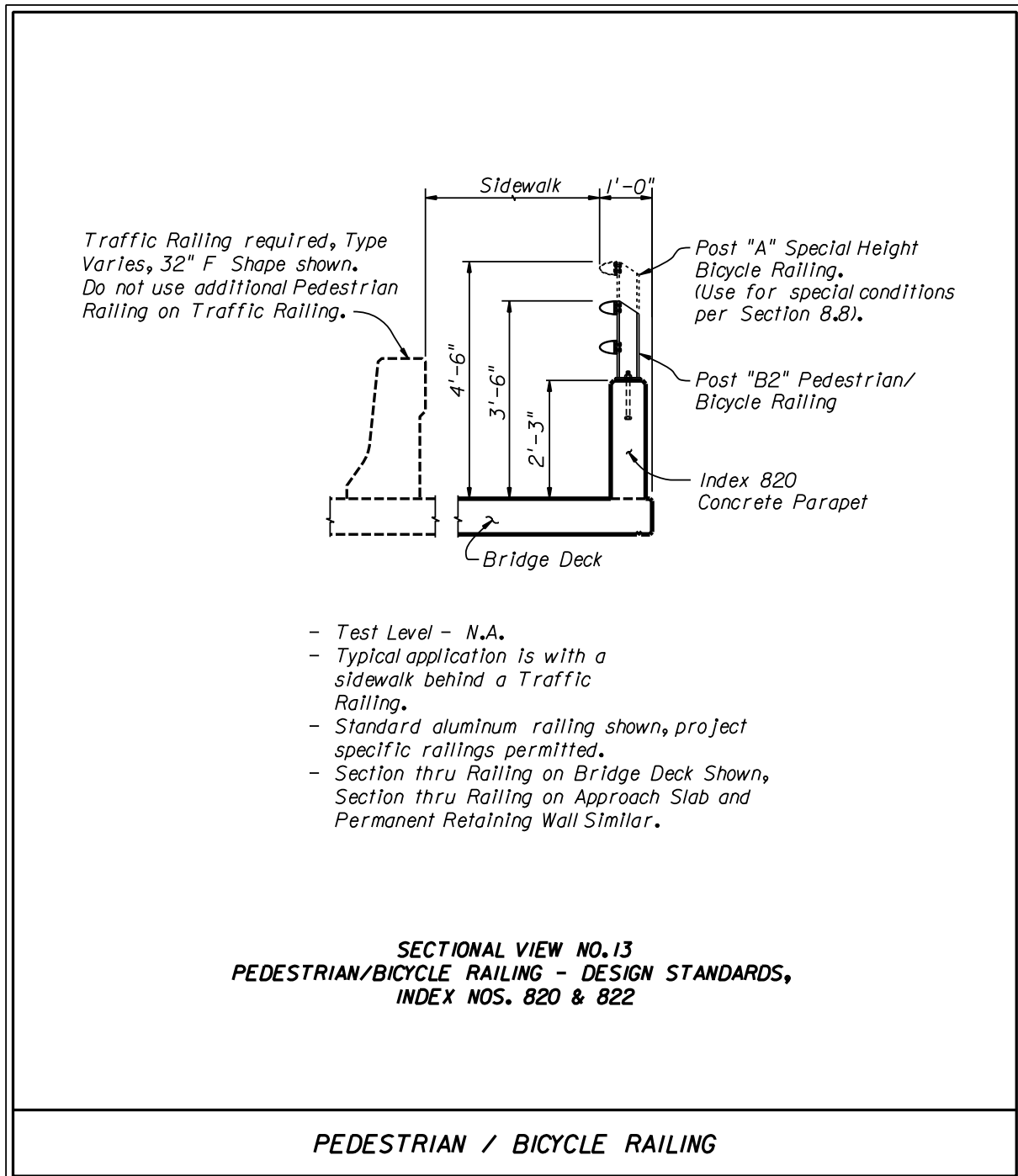

Figure 2.12.8 Bridge Railing – Pedestrian / Bicycle Railing

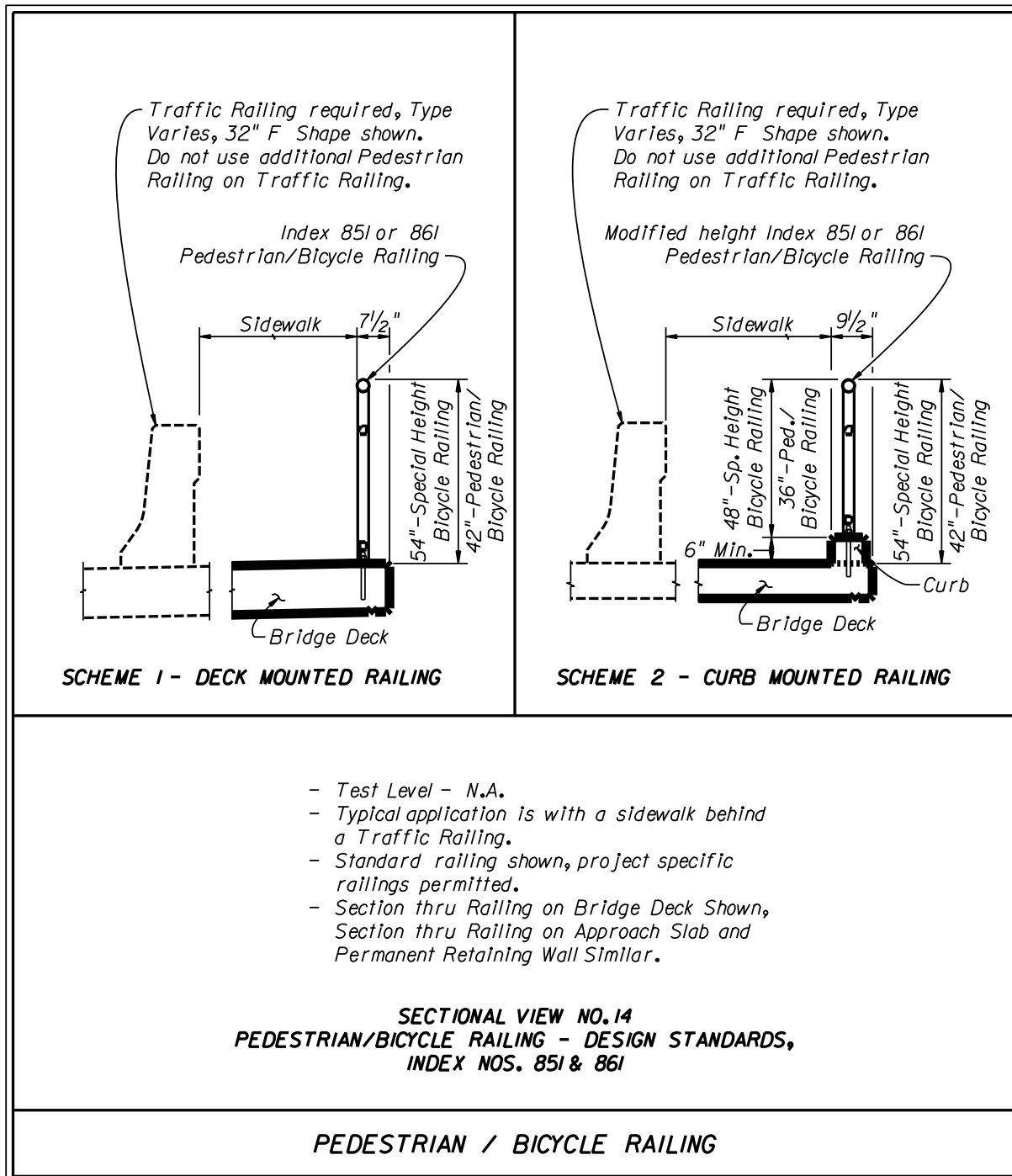

Figure 2.12.9 Bridge Railing – Pedestrian / Bicycle Railing

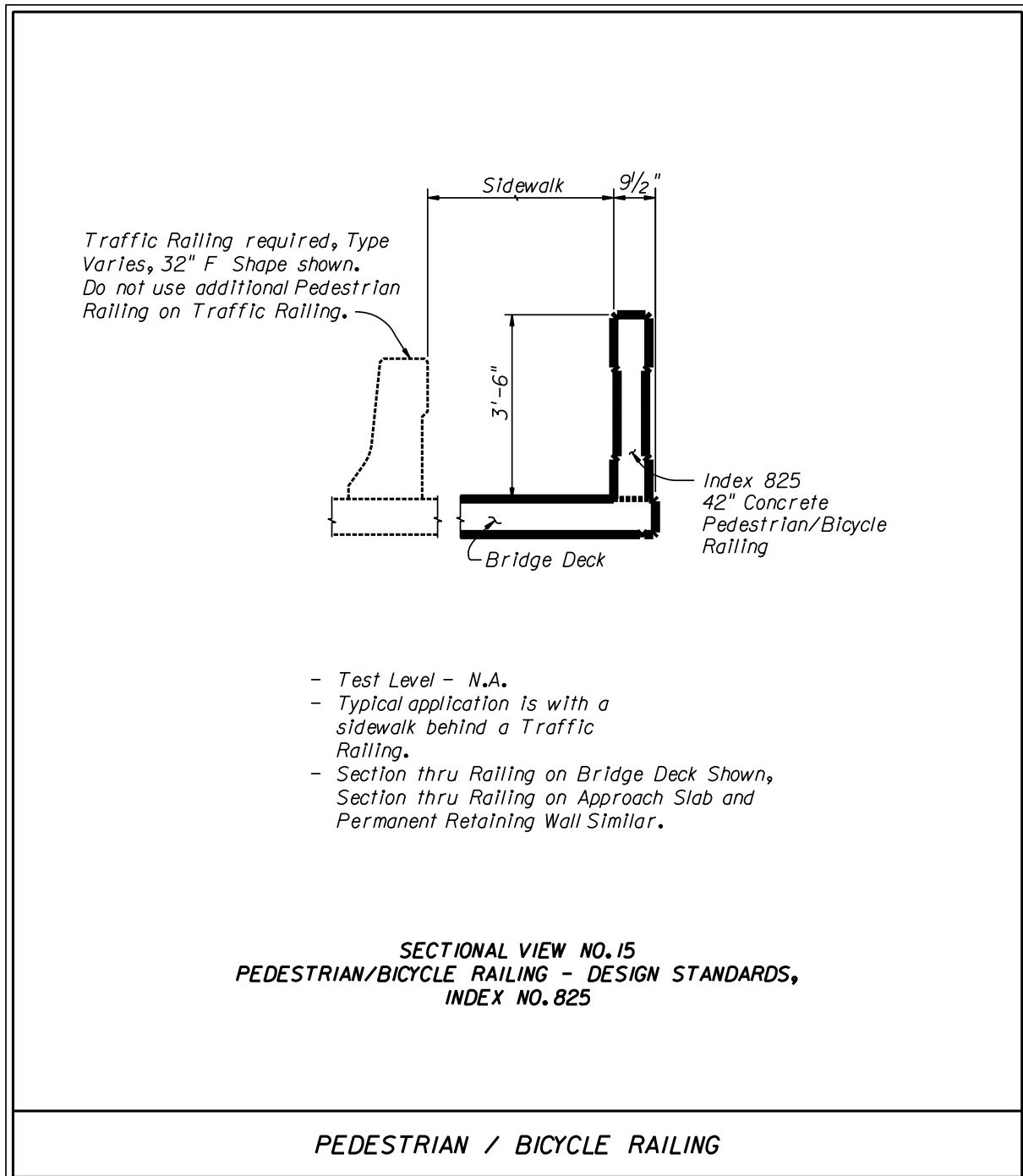

Figure 2.12.10 Bridge Railing – Pedestrian / Bicycle Retrofit Railing

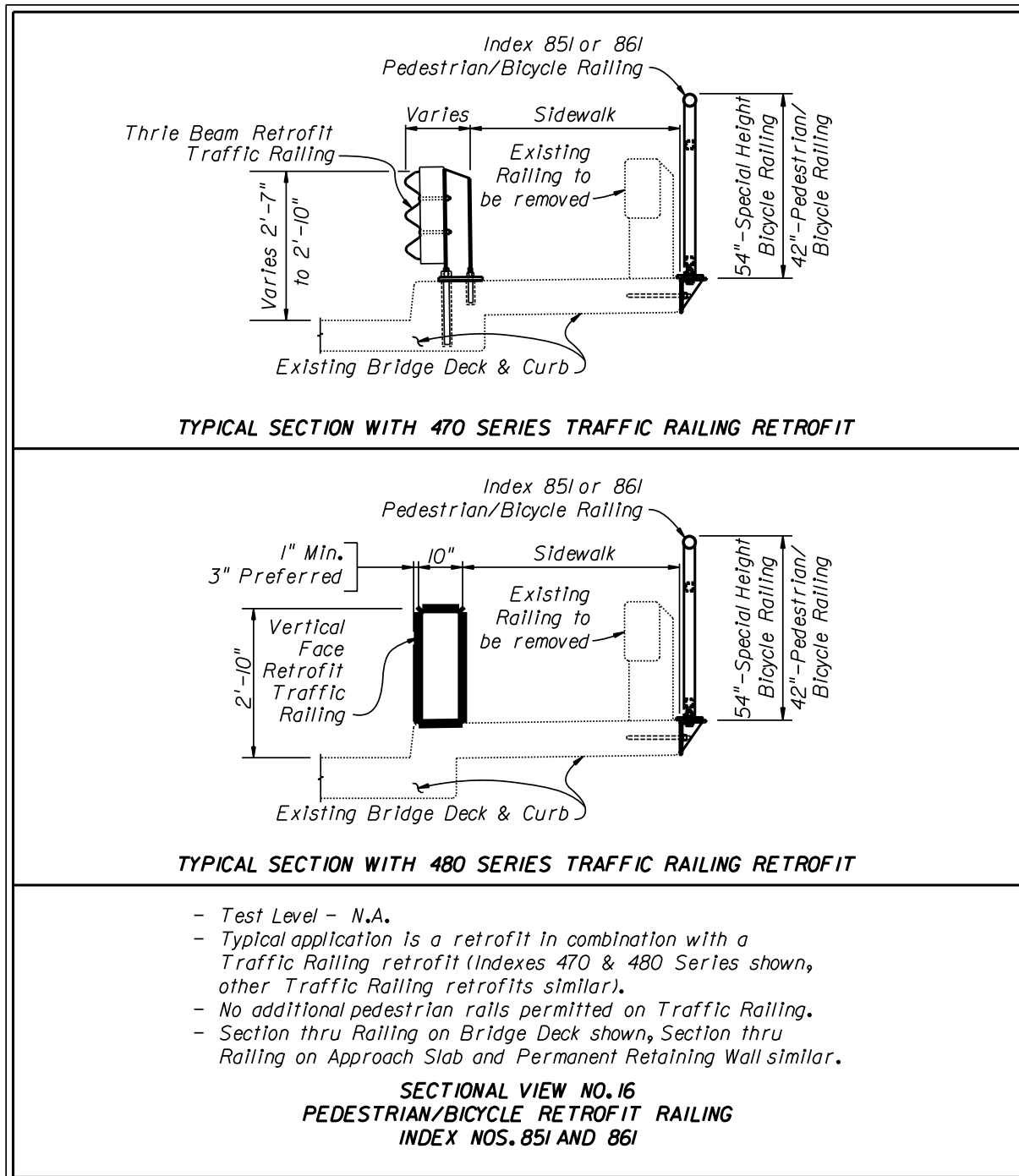

Figure 2.12.11 Bridge Fencing for Pedestrian Railing

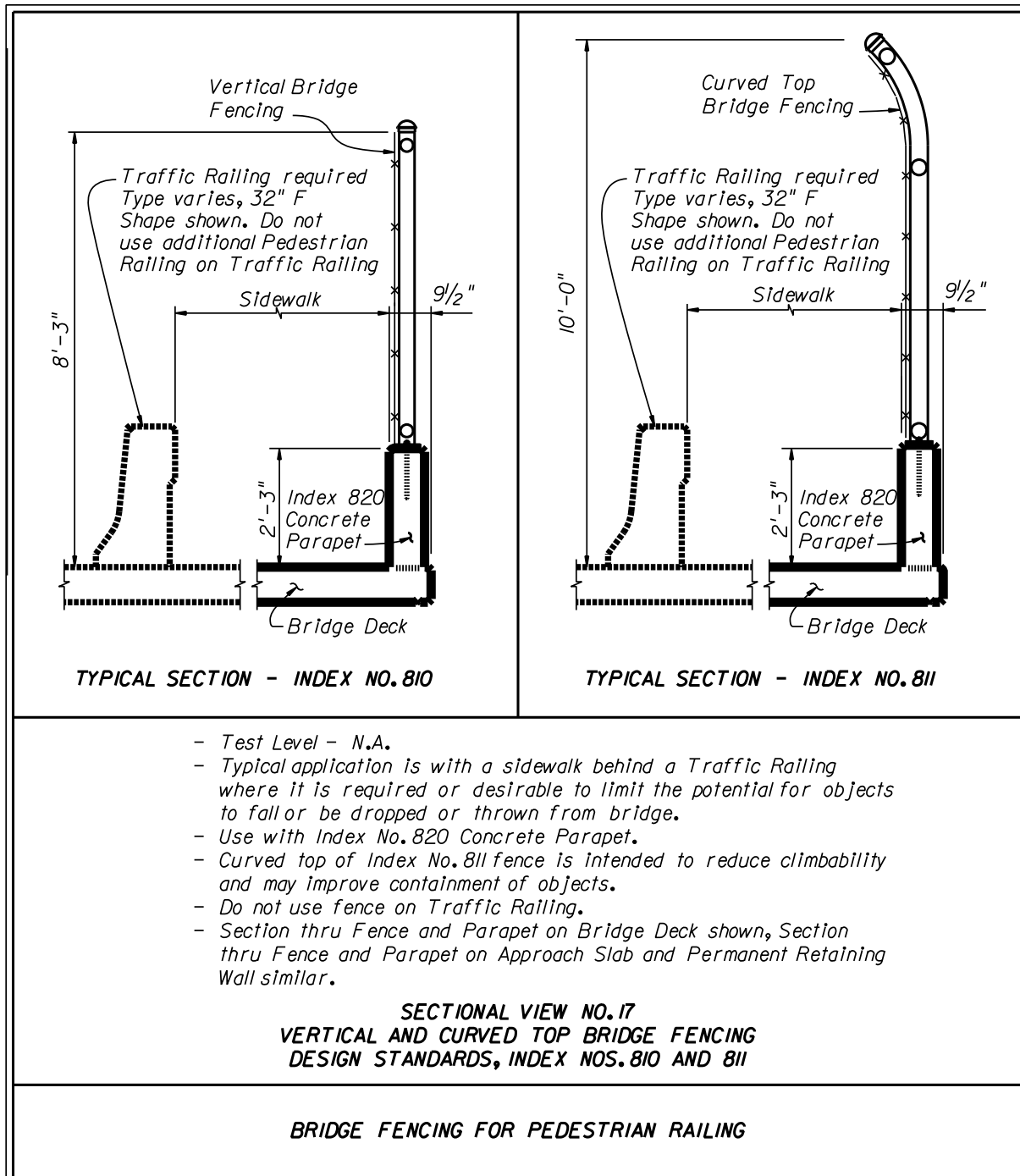
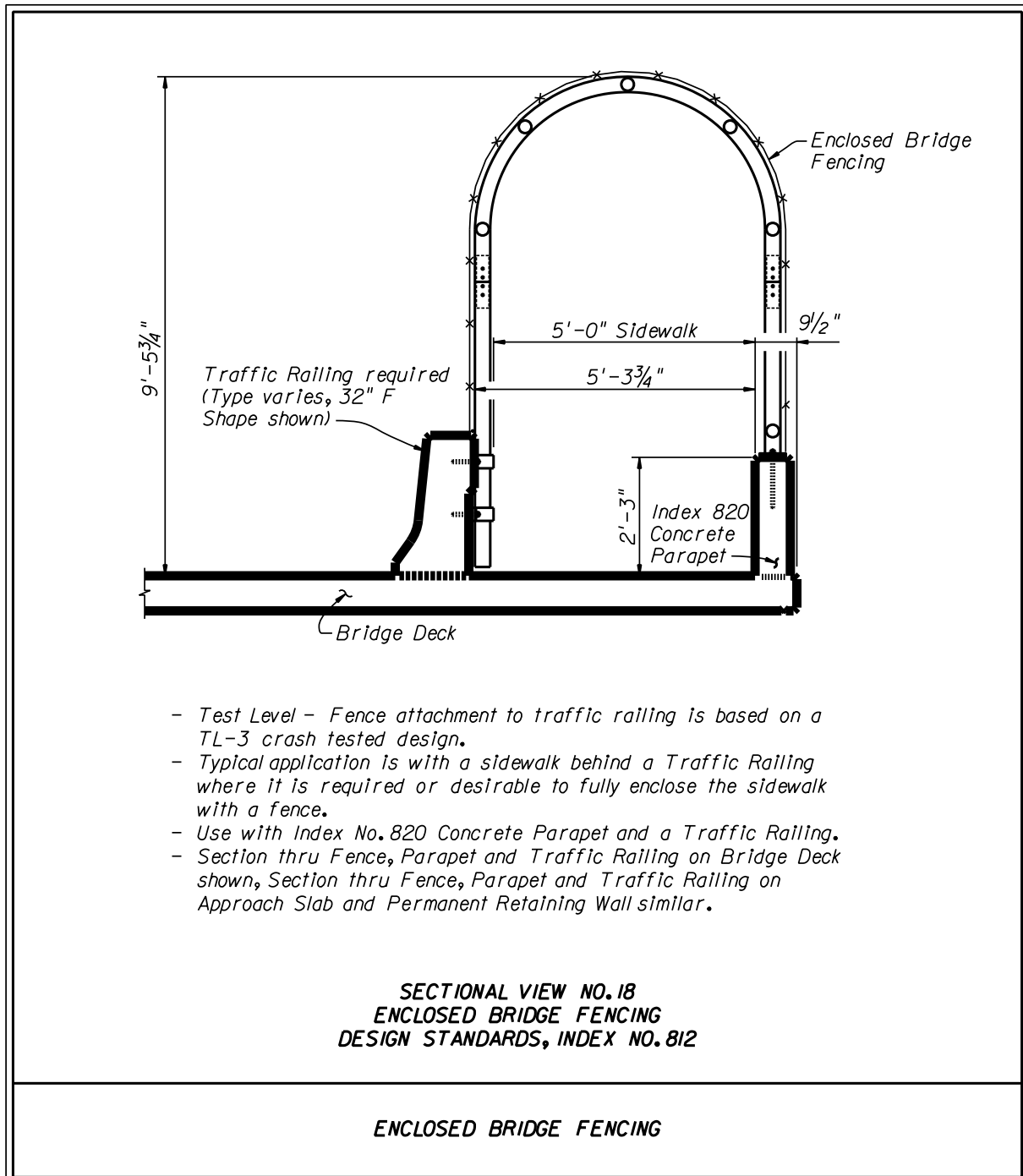

Figure 2.12.12 Enclosed Bridge Fencing for Pedestrian Railing



2.13 Intersections

Design guides and criteria presented heretofore are also applicable to the proper design of intersections.

2.13.1 Roundabouts

The ***National Cooperative Highway Research Program (NCHRP) Report 672, Roundabouts: An Informational Guide***, is adopted by FHWA and establishes criteria and procedures for the justification, operational and safety analysis of modern roundabouts in the United States. In addition, the ***Florida Intersection Design Guide*** contains Florida centric guidelines and requirements for evaluation and design of roundabouts in Florida.

Roundabouts shall be evaluated on new construction, reconstruction and safety improvement projects, as well as any time there are proposed changes in intersection control that will be more restrictive than the existing conditions.

Modification for Non-Conventional Projects:

Delete the last sentence and see the RFP for requirements.

2.13.2 Queue Length for Unsignalized Intersections

Turn lanes should comply with the ***Design Standards, Index 301*** to the extent practical. The available queue length provided should be based on a traffic study.

For low volume intersections where a traffic study is not justified, a minimum queue length of 50 ft. (2 vehicles) should be provided for rural areas and small urban areas; for other urban areas, a minimum queue length of 100 ft. (4 vehicles) should be provided.

2.13.3 Offset Left Turn Lanes

The alignment of opposing left-turn lanes and the horizontal and vertical curvature on the approaches are the principal geometric design elements that determine how much sight distance is available to a left-turning driver. Operationally, vehicles in the opposing left-turn lane waiting to turn left can also restrict the left-turning driver's view of oncoming traffic in the through lanes. The level of blockage depends on how the opposing left-turn lanes are aligned with respect to each other, as well as the type/size of vehicles in the opposing queue and their position in the opposing lane.

The offset distance is defined as the distance between the left edge of the turn lane and the right edge of the opposing turn lane. If the offset distance is to the left of the turn lane it is considered a negative offset, and if it is to the right of turn lane it is considered a positive offset.

The conventional method of designing left turn lanes is to place the left turn lanes adjacent to the through lanes. This design creates a negative offset which severely restricts the sight distance of the left-turning driver's view of oncoming traffic when another vehicle is in the opposing turn lane. **Figure 2.13.1** indicates the negative offset when the conventional design is used.

Figure 2.13.1 Typical Opposing Left Turns (22' Median with Negative 10' Offset)

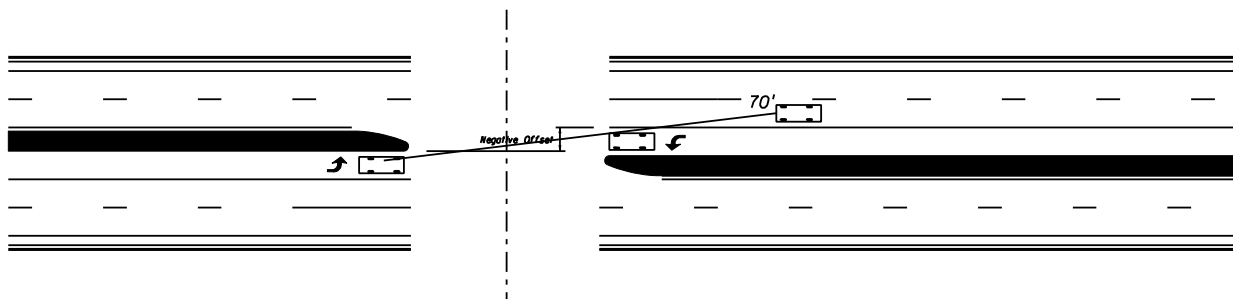

On all urban designs offset left-turn lanes should be used with median widths greater than 18 feet. A four foot traffic separator should be used when possible to channelize the left turn and provide separation from opposing traffic. On rural intersections where high turning movements are involved, offset left-turn lanes should also be considered. On median widths 30 feet or less, an offset turn lane parallel to the through lane should be used and the area between the left turn and traffic lane where vehicles are moving in the same direction should be striped out. On medians greater than 30 feet, a tapered offset should be considered. **AASHTO Exhibit 9-98** illustrates the design of parallel and tapered left turn lanes. **Figure 2.13.2** indicates an offset left turn.

Figure 2.13.2 Typical Opposing Left Turns (22' Median with Negative 1' Offset)

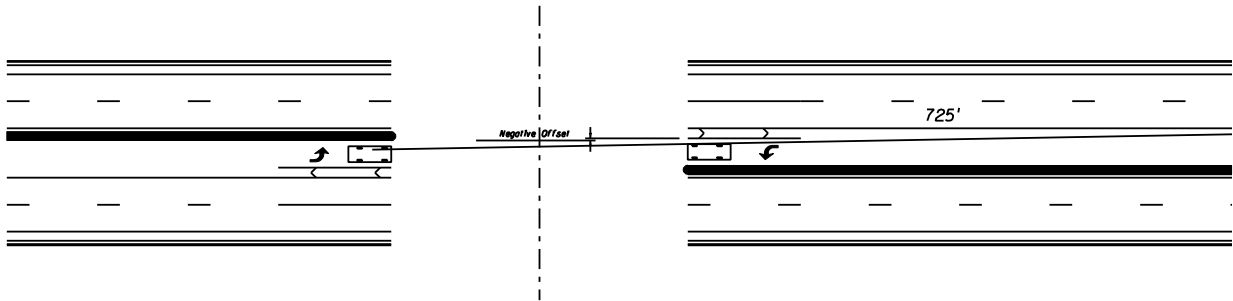

As illustrated in **Figure 2.13.2**, the sight distance is improved significantly by utilizing the offset left turn design even when a positive offset is not achieved. The graph in **Figure 2.13.3** is taken from the **Older Driver Highway Design Handbook**, and gives the left turn offset guidelines that may be considered for various design speeds and vehicle types.

Figure 2.13.3 Left Turn Offset Guidelines

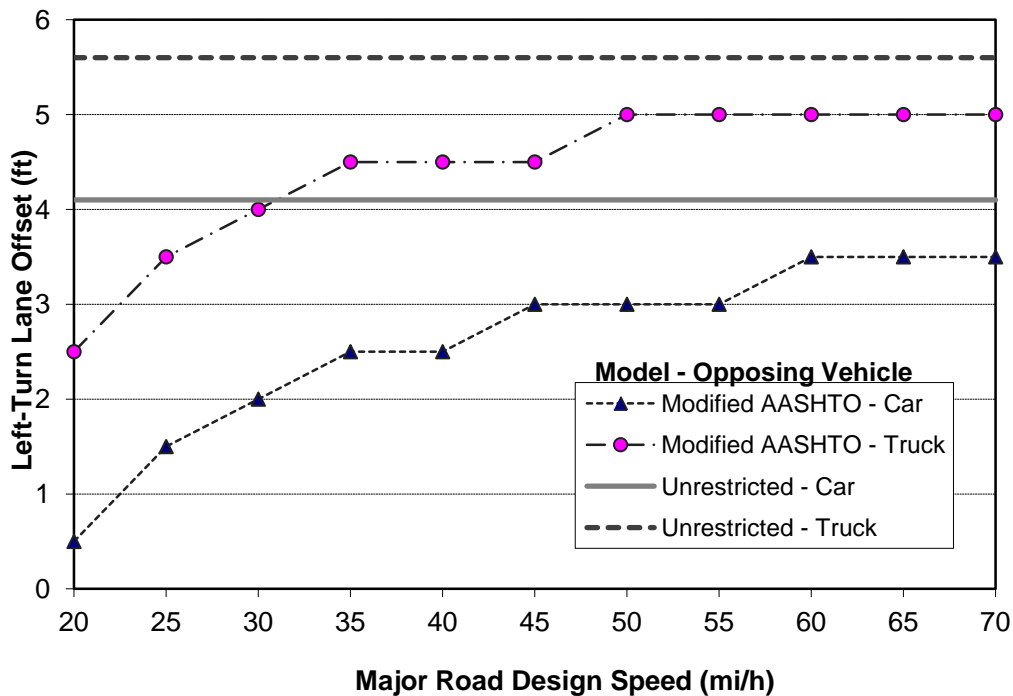

2.14 Interchanges and Median Openings/Crossovers

Design guides and criteria presented heretofore and in the *Design Standards* are also applicable to the proper design of interchanges with their inherent ramps, speed change, merging and weaving lanes. Where diamond ramps and partial cloverleaf arrangements intersect the crossroad at grade, an at-grade intersection is formed. In urbanized areas, high speed ramps, weaving areas and acceleration lanes are not appropriate. These ramp terminals should be designed as intersections consistent with the design speed and character of the roadway.

2.14.1 Limited Access Right of Way Limits at Interchanges

The following criteria will be used in establishing limited access limits along crossroads at interchanges:

1. For rural interchanges, limited access will extend along the crossroad to a point 300 ft. minimum beyond the end of the acceleration or deceleration taper. In the event these points are not opposite, the point most remote from the project will be the control and the limited access on both sides will end at that station along the crossroad. Where no taper is used, the limited access will be carried to a point 300 ft. minimum beyond the radius point of the return. In this case also, the radius point most remote from the project will control.
2. For interchanges in urban areas, the criteria given above will apply except that the limited access will end a minimum of 100 ft. beyond the end of taper or the radius point of the return.
3. For unsymmetrical interchanges such as half-diamonds and partial clover leaves, etc., the limited access right of way along the crossroad on that side having no ramp will extend to a point opposite that point controlled by the ramp.
4. Limited access along crossroads overpassing limited access facilities (with no interchange) shall be extended approximately 200 feet, measured from the mainline right of way line, along the crossroad. This distance may be reduced or omitted if the crossroad profile provides for adequate sight distance for existing or proposed driveways. The fence is generally tied into the crossroad structure end bent unless required along the crossroad.
5. Any reduction in the values shown above for limited access limits must be approved by FHWA for interstate projects and by the District Design Engineer for non-interstate limited access facilities.

Access Management Rule 14-97 standards (**14-97.003(1)j**) regulate the location of driveway connections and median openings in interchange areas on arterial roads. This standard should be applied in accordance with the District procedures for implementing the Rule, and should not be confused with minimum requirements for limited access right of way.

2.14.2 Median Openings at Interchanges

Median opening locations at interchanges on arterial roads must consider **Access Management Rule 14-97 (14-97.003(1)j2)** which states “The minimum distance to the first median opening shall be at least 1320 feet as measured from the end of the taper of the egress ramp.” This standard is to be applied in accordance with the FDOT median opening decision process. As a minimum, for all crossroad facilities at interchanges in both rural and urban areas, a median opening may be centered no less than 50 ft. beyond the end of limited access except that a minimum distance of 660 ft. to the ramp median opening will be required. In no case should access be permitted between the interchange proper and the median opening as established by these criteria.

2.14.3 Ramp Widths

Ramp widths for interchange ramp terminal design are given in **Table 2.14.1**.

Table 2.14.1 Ramp Widths - Turning Roadways

RAMP WIDTHS			
RADIUS To Inside of Curve (FEET)	1-LANE ₃		2-LANE
	Traveled Way Width ₁ Case I-C ₂ One-lane, one-way operation – no provision for passing a stalled vehicle	Traveled Way Width ₁ + Outside Paved Shoulder Width Case II-B ₂ One-lane, one-way operation – with provision for passing a stalled vehicle	Traveled Way Width ₁ Case III-A ₂ Two-lane operation – either one-way or two-way
	FEET		
50	23	26	29
75	20	23	27
100	18	22	26
150	17	21	24
200	16	20	24
300	15	20	24
400	15	19	24
≥ 500	15	19	24

For widths on the ramp proper, see **Table 2.1.3**.

For case application, see **AASHTO** and the **Design Standards, Index No. 525**.

- AASHTO adjustments do not apply.
- Note: A = Predominantly P vehicles, but some consideration for SU trucks.
 B = Sufficient SU vehicles to govern design, but some consideration for semitrailer combination trucks.
 C = Sufficient bus and combination trucks to govern design.
- Where accommodation of future resurfacing is a factor, consideration should be given to increasing the minimum width to 24 ft. where practical.

2.14.4 Crossovers on Limited Access Facilities

Permanent crossovers on freeways are sometimes necessary to avoid excessive travel distances for emergency vehicles, law enforcement vehicles, and maintenance vehicles. Median crossings shall be allowed only when there is a clear documented request and need for such a feature; however they shall be limited in number and very carefully located. The location of crossovers used for maintenance purposes should consider the needs of emergency and law enforcement vehicles and vice versa. Permanent crossovers should conform to the recommendations of **AASHTO's "Geometric Design of Highways and Streets"** (see Rural Freeway Medians). The location of all crossovers requires approval of the District Design Engineer. Note, this criteria does not apply to contra flow crossovers placed for facilitating hurricane evacuation, nor does it apply to temporary construction crossovers. For temporary construction crossovers, please see **Design Standards, Index Numbers 630 and 631**.

The following AASHTO crossover recommendations are requirements on FDOT's Limited Access Facilities:

1. Not spaced closer than 3.0 miles apart.
2. Located only in areas with above-minimum stopping sight distance and without superelevated curves.
3. Not located within 1,500 feet of the end of a speed-change taper (of a ramp or facility widening/narrowing) or any structure (bridge, overpassing facility or overhead sign).
4. Not located where the median width is less than 25 feet.

Crossover locations that do not meet the above criteria require approval by the State Roadway Design Engineer and FHWA (FHWA on Interstate facilities only).

The following additional criteria are also placed on crossovers designed for FDOT's Limited Access Facilities:

1. Not located within 1.5 miles of any interchange.
2. Not located where the median width is less than 40'.
3. Not located in urban areas
4. Where continuous median barrier is present, openings for crossovers should not be greater than 5.0 miles apart between Interchanges.

Crossovers that do not meet these additional criteria require approval by the District Design Engineer.

Typical layouts for the design of median crossovers are provided in **Figures 2.14.1, 2.14.2** and **2.14.3**. These typical layouts will not cover all situations, but are provided as a guide for developing site-specific designs. Designs should accommodate the types of emergency vehicles expected to use the crossover. Law enforcement vehicles and typical ambulance sized vehicles can usually be easily accommodated. The typical layouts in **Figures 2.14.1, 2.14.2** and **2.14.3** will accommodate an SU design vehicle. To the extent practical, designs should accommodate larger emergency response vehicles such as fire trucks. This will require acquiring information from local emergency responders on the size and configuration of vehicles used. Except where median widths are wider than normal, fire trucks and other larger vehicles will likely not be able to make u-turns without encroaching or crossing travel lanes. As a minimum, designs should provide for the necessary minimum radii and width to allow the largest design vehicle to enter the crossover and stop as close to perpendicular to traffic as practical. All designs should be tested by superimposing the turning path of the design vehicle to insure the crossover will operate as expected.

On Interstate facilities, the Federal Highway Administration directs that median shoulders approaching the crossover utilize the standard shoulder width, or existing shoulder width. The FHWA believes the safety benefits derived by making the crossovers appear less conspicuous outweigh the benefits obtained by providing paved shoulders to accommodate acceleration and deceleration lanes for emergency vehicles, law enforcement, or other authorized vehicles.

The profile of the crossover shall conform as close as practical with travel way shoulder slopes and median side slopes so that the crossover is inconspicuous as possible to traffic. The paved width of the crossover should not be any wider than that necessary to provide for the largest design vehicle. Shoulder width for the crossover should be 8' minimum. Side slopes of the crossover (parallel with the mainline travel way) shall be 1V:10H or flatter. However, side slopes may be transitioned to match the slope of a pipe culvert safety end treatment where a culvert crossing underneath the crossover is necessary to provide for proper median drainage.

In locations where a median barrier is present, the length of the barrier opening should be minimized to the extent practical. As shown in **Figure 2.14.3**, the barrier ends on each side of the opening should be offset to the extent practical. Crashworthy end treatments or crash cushions to shield the barrier ends shall be provided when the ends are within the clear zone and fall within the departure angle used to set length of need. Crashworthy end treatments or crash cushions shall also be provided whenever the angle between barrier ends is less than 30 degrees measured from the direction of mainline travel (see **Figure 2.14.3**).

Drainage requirements must be determined for each location and appropriate provisions made. The drainage culvert shown in the figures are for example only. Either a mitered end section (1:4) or preferably a u-endwall with grate (1:6) should be used for culverts parallel with the mainline. Note that in some cases existing median ditches are shallow and there will be minimal clearances available for even small size culverts. This requires that site-specific vertical and horizontal geometry be developed for each location rather than use a typical drawing.

A pavement design equivalent to a Limited Access shoulder pavement should be provided (1-1/2" Structural Course, Base Group 1 with a 12" Stabilized Subgrade).

Signing for permanent crossovers shall consist of a "No U-turn" sign (R3-4) with an "Official Use Only" plaque (FTP-66-04). To improve nighttime visibility for approaching emergency responders, install yellow RPM's placed outside the yellow edge line in advance of the crossover using the following pattern and spacing: 3 spaced 4" apart @ 1500', 2 spaced 4" apart @ 1000', and 1 @ 500' in advance of the crossover.

On reconstruction and RRR projects, the location of existing crossovers shall be evaluated for conformance to the above criteria. Those that do not meet this criterion must be removed as a part of the project unless approved by the State Roadway Design Engineer and FHWA (FHWA approval on Interstate only).

Modification for Non-Conventional Projects:

Delete the last paragraph and replace with the following:

The location of existing crossovers shall be evaluated for conformance to the above criteria. Those that do not meet this criterion must be removed.

Figure 2.14.1 Crossovers on Limited Access Facilities – 6 or More Lanes

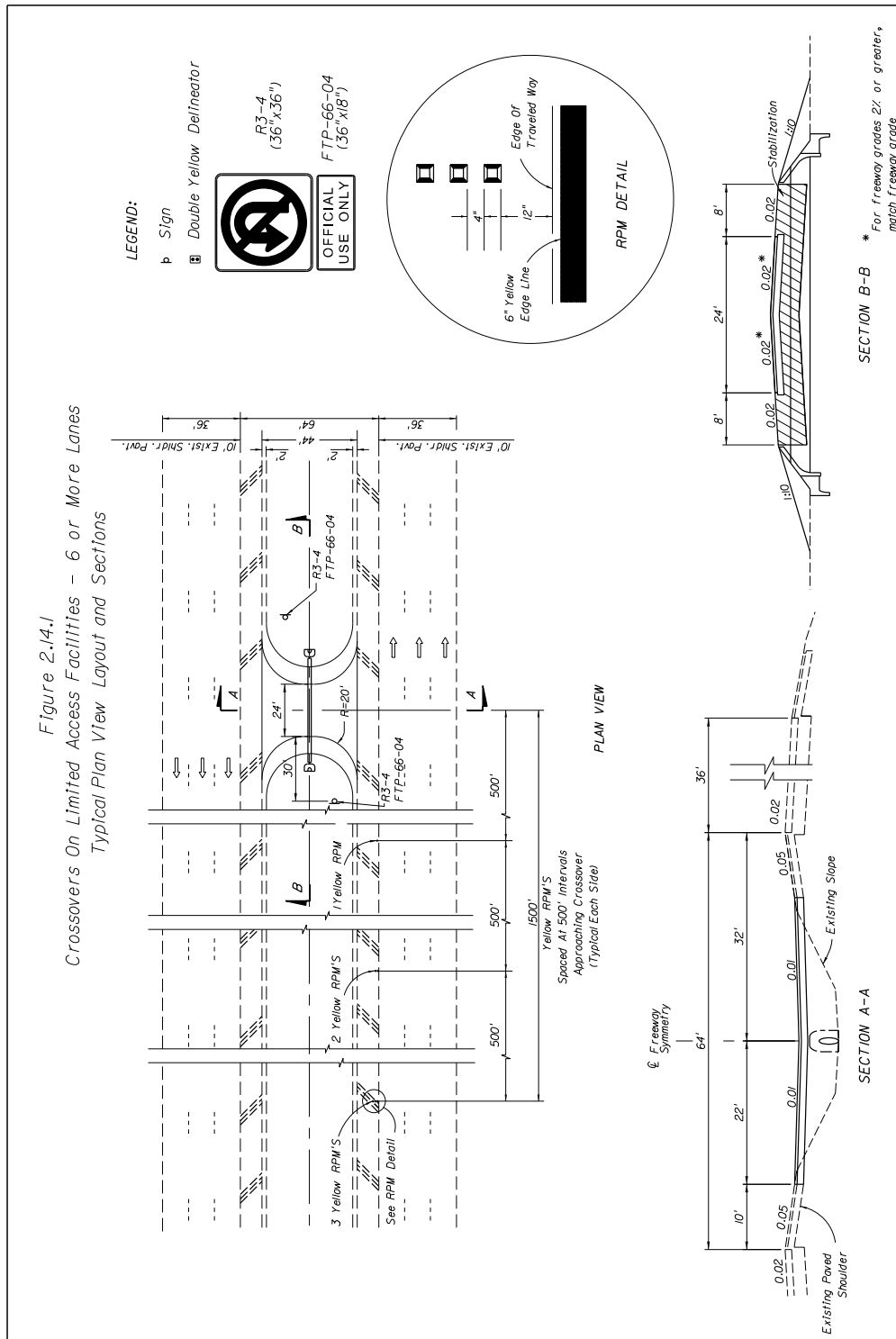

Figure 2.14.2 Crossovers on Limited Access Facilities – 4 Lanes

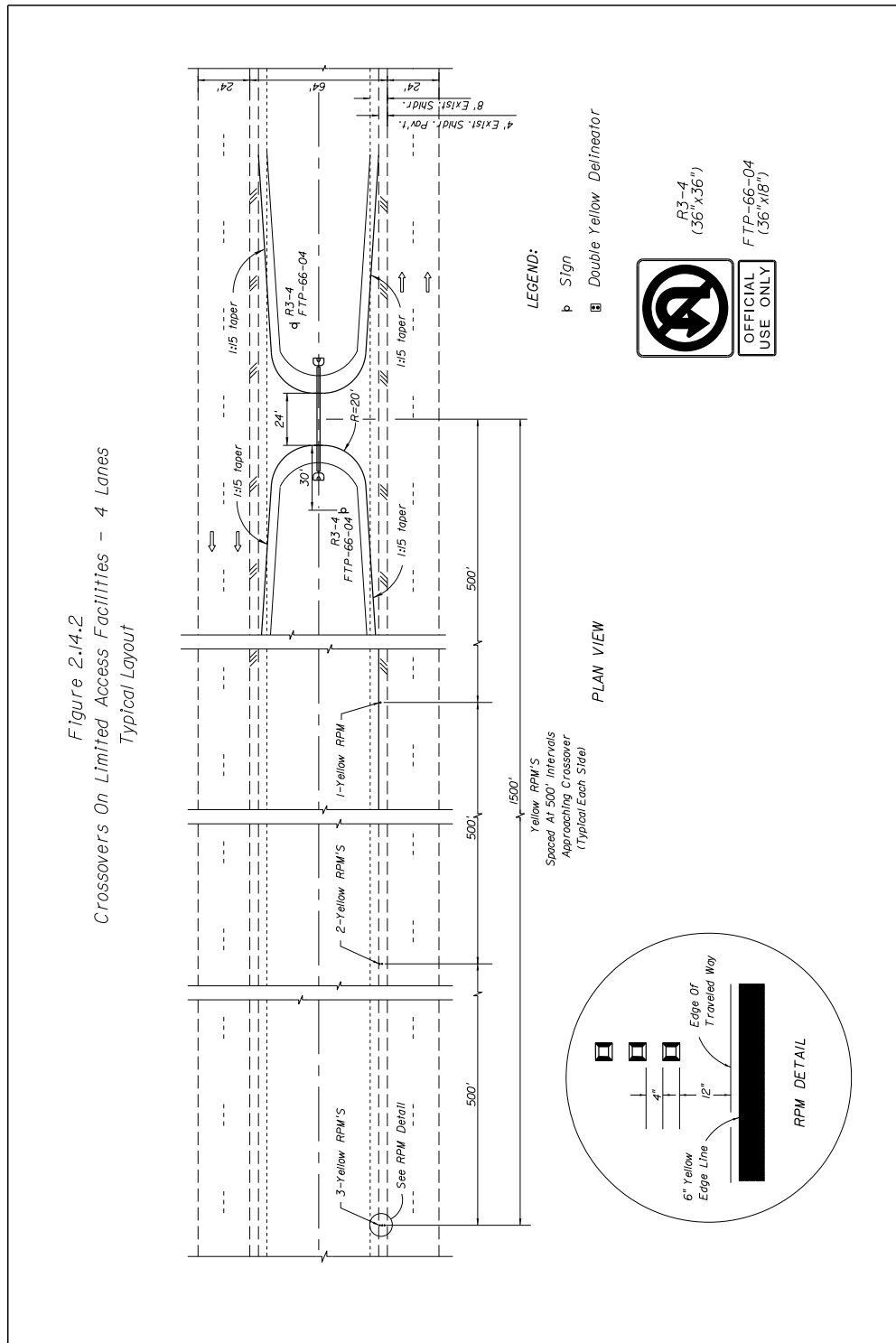
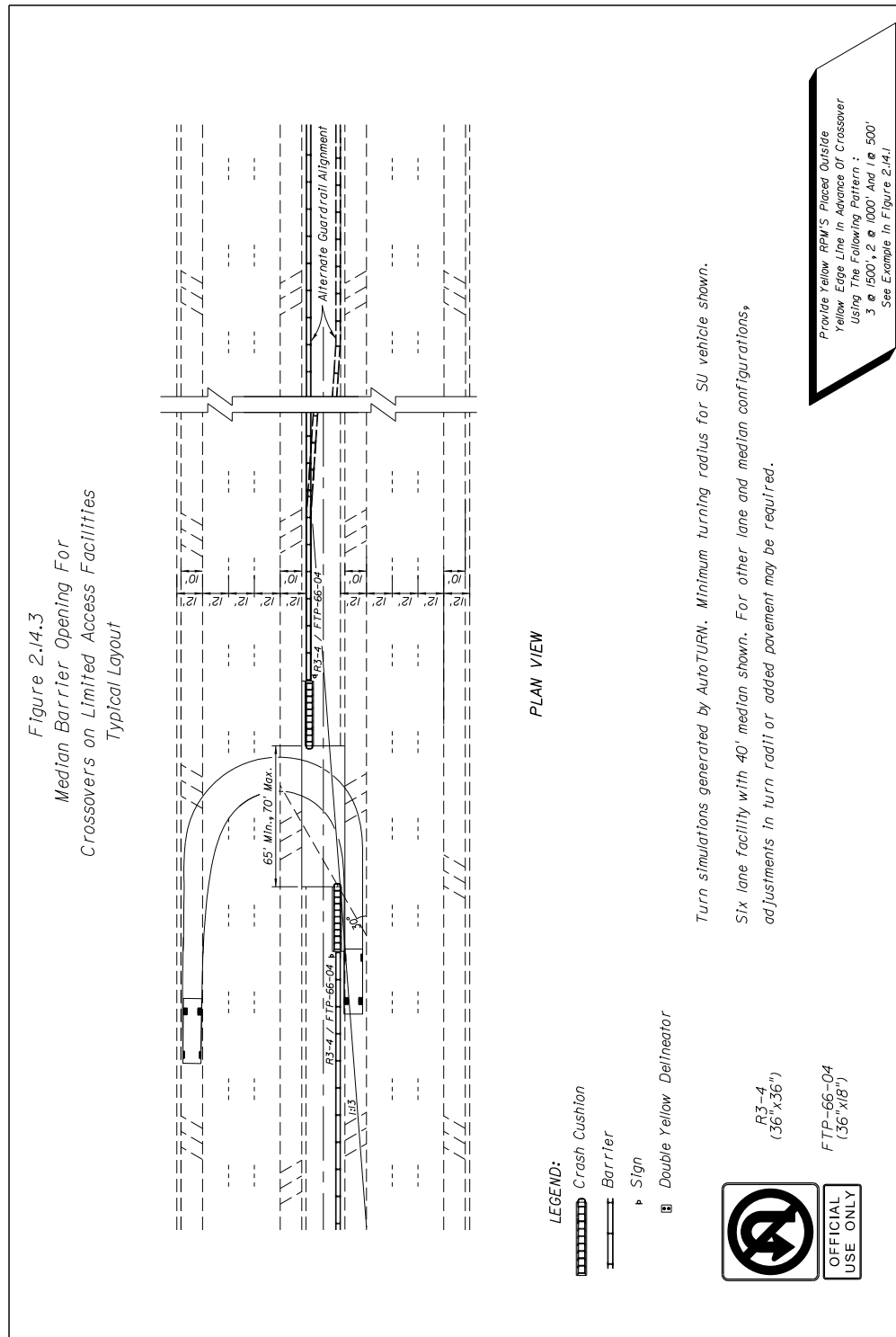

Figure 2.14.3 Median Barrier Opening for Crossovers on Limited Access Facilities



2.15 Lighting Criteria

Lighting Criteria is contained in **Chapter 7** of this volume.

2.16 High-Speed Urban and Suburban Arterial Highways

The two classifications of rural and urban are generally sufficient for the design of Florida's arterial highways; however, there are some areas that do not lend themselves to these classifications. These are transitional areas where conditions along the highway change from rural to urban or from urban to rural. Also, there are urban arterial highways where the anticipated operating speeds are higher than standard urban design speeds. Because of the undesirable effects of having curb and gutter on high speed highways, four-lane and six-lane high speed urban and suburban arterial highway typical sections have been developed to insure that these highways are designed consistently and to minimize the need to process design exceptions and variations. These typical sections are found in **Exhibit TYP-17** and **TYP-18** of **Chapter 6, Volume 2**.

Special design criteria in this section have been developed for these four-lane and six-lane high-speed urban and suburban arterial highways. For criteria and other guidance not listed below, the designer is to use the values that are commensurate with either a four-lane or six-lane rural arterial highway having the same design speed and traffic volumes. The use of these special criteria is restricted to facilities within FHWA Urban or Urbanized boundaries where right of way is constrained.

The design of the initial four-lane facility should also take into consideration the ultimate six-lane section that these roadways will have in the future. If an ultimate high speed six-lane section is planned, consideration should be made to acquire a minimum of 80 feet of right of way on each side and construction of 6.5-foot shoulders adjacent to the median as shown in the six-lane section. This can avoid future widening and curb relocation in the median as well as future right of way acquisition to obtain proper border and clear zone. In addition, special attention to the ultimate location of drainage structures, sidewalk offset and elevation, superelevation and curve radii can minimize the amount of reconstruction of these elements as well. To illustrate two possible scenarios, **Figure 2.16.1** and **Figure 2.16.2** show examples of four-lane and six-lane high-speed suburban arterial sections with the future six-lane low-speed urban arterial typical section superimposed. A six-lane high-speed urban typical section is found in **Exhibit TYP-20** of **Chapter 6, Volume 2**. A four-lane high-speed urban typical section differs from the six-lane section in median shoulder width as discussed in **Section 2.16.5**.

Modification for Non-Conventional Projects:

Delete the previous three paragraphs and see the RFP for requirements.

Figure 2.16.1 Four-Lane High-Speed Urban and Suburban Section

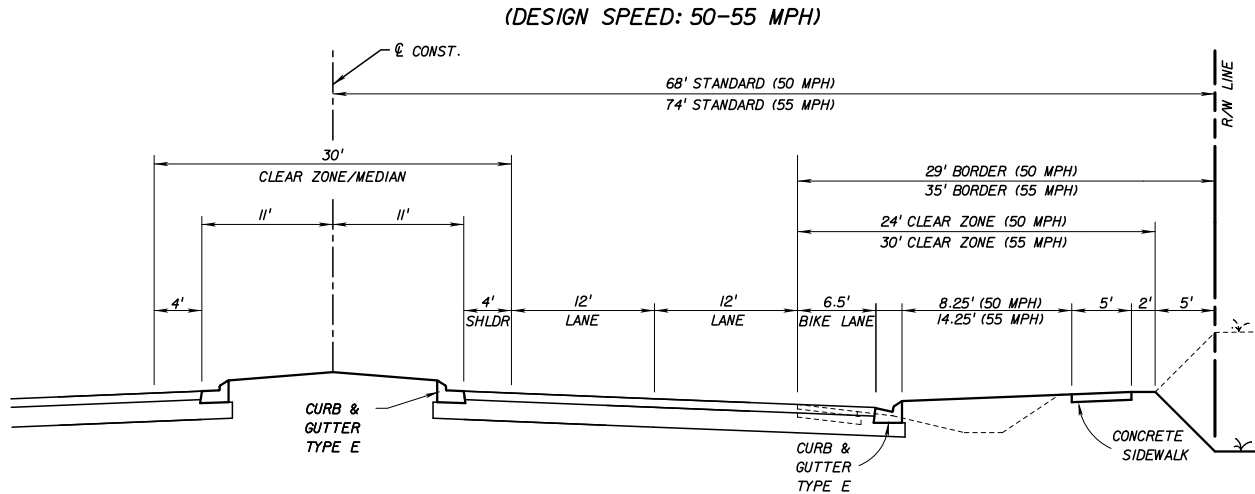
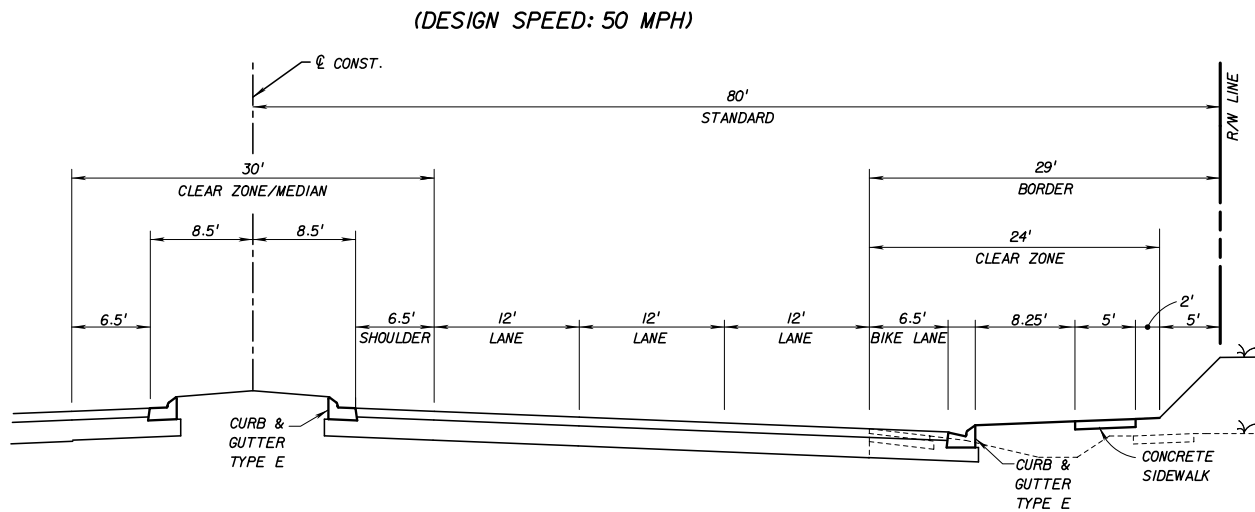

Figure 2.16.2 Six-Lane High-Speed Urban and Suburban Section



2.16.1 Design Speed

The maximum design speed of four-lane high-speed urban and suburban arterial highways is 55 mph. The maximum design speed of six-lane high-speed urban and suburban arterial highways is 50 mph.

2.16.2 Curbs

To minimize right of way requirements, the high-speed urban and suburban arterial highway typical section incorporates the use of curbs and a closed drainage system. The type of curb used within the clear zone on this section is restricted to the FDOT Type E shape (sloping curb not greater than 5 inches in height above adjacent pavement). This applies to both median and outside shoulder locations. Flush shoulders can be utilized on the outside as long as clear zone and other criteria requirements can be maintained.

2.16.3 Pedestrian and Bicycle Facilities

Four-lane and six-lane high-speed urban and suburban arterial highways shall have sidewalks which provide accommodations for pedestrians and bicycle lanes which provide accommodations for bicyclists. See **Section 2.16.5** and **Chapter 8** for additional information.

2.16.4 Medians

The minimum median width for four-lane and six-lane high-speed urban and suburban arterial highways may be reduced to 30 feet (inclusive of median shoulders) as opposed to 40 feet minimum required in **Table 2.2.1**. A 30-foot median provides sufficient width for a 30-foot clear zone. This median width also allows space at intersections for dual left turn lanes (11-foot lanes with 4-foot traffic separator), and directional median openings using 4-foot traffic separators. When this is done neither a Design Exception nor Design Variation is required.

Modification for Non-Conventional Projects:

Delete the previous paragraph and see the RFP for requirements.

2.16.5 Shoulders

The minimum median shoulder width for four-lane high speed urban and suburban arterial highways is 4 feet measured to the lip of the gutter. This provides for 5.5 feet of usable median shoulder to the curb face. The minimum median shoulder width for six-lane high-speed urban arterial highways is 6.5 feet measured to the lip of the gutter. This provides for 8 feet of usable median shoulder to the curb face. Under special circumstances (i.e., dual left turn lanes, directional median openings, etc.) it may be necessary to encroach into the median shoulder. In these locations only, the minimum median shoulder width may be reduced to 4 feet (measured to face of curb or separator) while maintaining the same median width.

Modification for Non-Conventional Projects:

Delete the last two sentences of the above paragraph.

The minimum outside shoulder width for four-lane and six-lane high speed urban and suburban arterial highways is 6.5 feet measured to the lip of the gutter. This provides for 8 feet of usable outside shoulder to the curb face. As a minimum, the outside shoulder shall be marked as a bicycle lane. The bicycle lane to the left of right turn lanes shall be 5 feet wide.

2.16.6 Friction Course

Because of the higher speeds and the associated risk of hydroplaning, FC-5 friction course is to be provided to reduce surface water. The FC-5 friction course should be placed at the lip of the gutter in accordance with the ***Design Standards, Index 300***.

2.16.7 Border Width

The border width for all high-speed urban and suburban arterial highways is measured from the outside edge of the traveled way to the right of way line. For a design speed of 55mph, the minimum border width is 35 feet. For a design speed of 50mph, the minimum border width is 29 feet.

2.16.8 Grades

The maximum grade for four-lane and six-lane high-speed urban and suburban arterial highways is 6% for a 50 mph design speed, or 5% for a 55 mph design speed.

2.16.9 Horizontal Curves

The maximum deflection without horizontal curvature is commensurate with rural new construction and comparable design speeds.

2.16.10 Superelevation

When these urban and suburban typical sections are superelevated, the superelevation rates are based on the $e_{max} = 0.10$ calculations, however the maximum superelevation rate that may be used is 0.05 (See **Figure 2.16.3**). Superelevation transition rates are to be commensurate with those for rural highways with 50 or 55 mph design speeds.

Figure 2.16.3 Superelevation Rates for High-Speed Urban and Suburban Sections

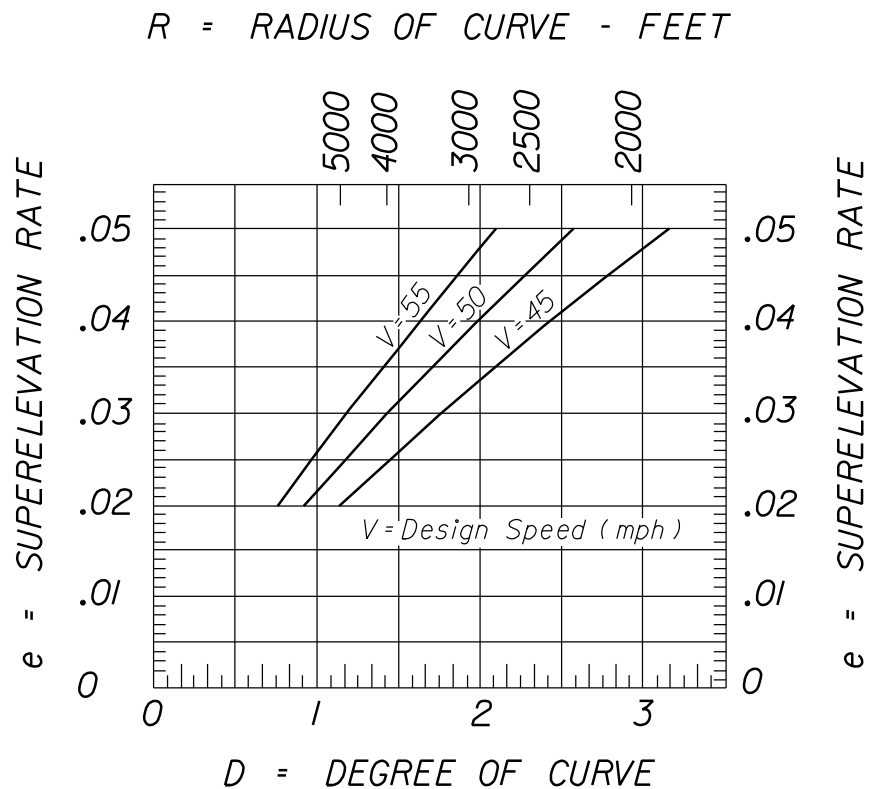

MAXIMUM DESIGN SUPERELEVATION RATE = 0.05
 (BASED ON $e_{max} = 0.10$)

2.16.11 Horizontal Clearance

Horizontal Clearance requirements are to be commensurate with new construction conditions for flush shoulder highways.

THIS PAGE LEFT BLANK INTENTIONALLY