

PLANS PREPARATION AND ASSEMBLY



**STATE OF FLORIDA
DEPARTMENT OF TRANSPORTATION**

CONTRACT PLANS

FINANCIAL PROJECT ID 196058-1-52-01
(FEDERAL FUNDS)
MANATEE COUNTY (13160)
STATE ROAD NO. 70

COMPONENTS OF CONTRACT PLANS SET
ROADWAY PLANS
SUBWAY AND PAVEMENT DIVISION PLANS
SIGNALIZATION PLANS
LIGHTING PLANS
LANDSCAPE PLANS
ARCHITECTURAL PLANS
STRUCTURE PLANS

EXAMPLE SHEET:
CONTRACT PLANS SET MAY NOT CONTAIN
ALL OF THE LISTED COMPONENTS/SHEETS.

A DETAILED INDEX APPEARS ON THE
KEY SHEET OF EACH COMPONENT

INDEX OF ROADWAY PLANS

SHEET NO.	SHEET DESCRIPTION
1	KEY SHEET
2 - 8A	SUMMARY OF PVI ITEMS
3	DRAINAGE MAP
4 - 5	TYPICAL SECTIONS
6	TYPICAL SECTION DETAILS
7	SUMMARY OF QUANTITIES
8 - 12	SOIL CONVEY DATA SHEETS
13 - 15	BACK-OF-ROADWAY PROFILES
16 - 17	SUMMARY OF DRAINAGE STRUCTURES
18 - 23	ROADWAY PLAN-PROFILES
24 - 25	SPECIAL PROFILES
26 - 27	INTERSECTION LAYOUT/DETAIL
28 - 29	DRAINAGE STRUCTURES
30 - 31	LATERAL DITCH PLAN-PROFILES
32 - 33	LATERAL DITCH CROSS SECTIONS
34 - 35	SPECIAL DETAILS
36 - 37	ROADWAY SOIL SURVEY
38 - 39	CROSS SECTIONS
40 - 41	STORM WATER POLLUTION PREVENTION PLAN
42 - 43	TRAFFIC CONTROL PLANS
44 - 45	UTILITY ADJUSTMENTS
46 - 47	SELECTIVE CLEANING AND MAINTENANCE

ROADWAY SHOP DRAWINGS TO BE SUBMITTED TO:
HARRY P. OLSEN
HALL & DALE ENGINEERING, INC.
P.O. BOX 800
TAMPA, FLORIDA 33615

PLANS PREPARED BY:
HALL & DALE ENGINEERING, INC.
P.O. BOX 800
TAMPA, FLORIDA 33615
CERTIFICATE OF AUTHORIZATION NO. 0000
CONTRACT NO. 0-000
VENDOR NO. 30

NOTE: THIS PROJECT IS TO BE LET TO CONTRACT WITH FINANCIAL PROJECT ID 1960-1-52-01.

NOTE: THE SCALE OF THESE PLANS MAY VARY THROUGHOUT THE PROJECT.

PROJECT LENGTH IS BASED ON 5% CONSTRUCTION

LENGTH OF PROJECT	
	LINEAR FEET / MILES
ROADWAY	346370 / 0.653
BRIDGES	0 / 0
KEY LENGTH OF PROJECT	346370 / 0.653
CONVEYERS	0 / 0
GROSS LENGTH OF PROJECT	346370 / 0.653

POST PROJECT NUMBER: TRUSS DULFER

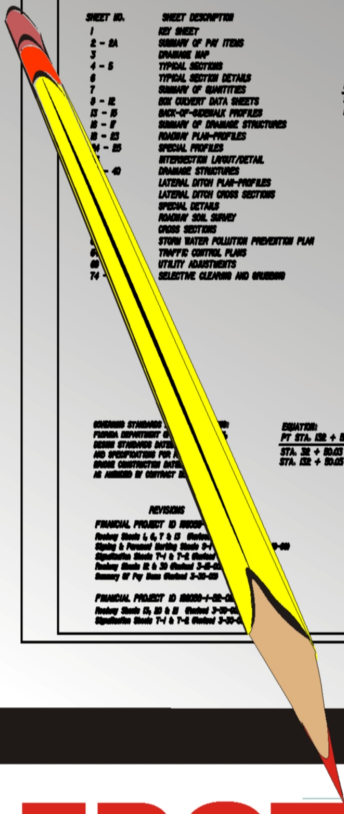

FDOT



DESIGN

Volume
II

Plans Preparation Manual

January 2006

Revised – January 1, 2007

PLANS PREPARATION AND ASSEMBLY



Florida Department Of Transportation

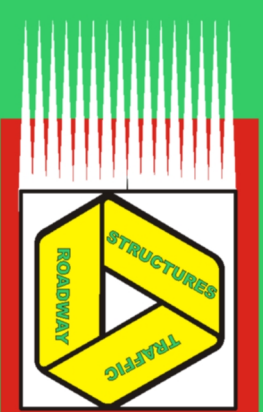

PLANS PREPARATION MANUAL

VOLUME II

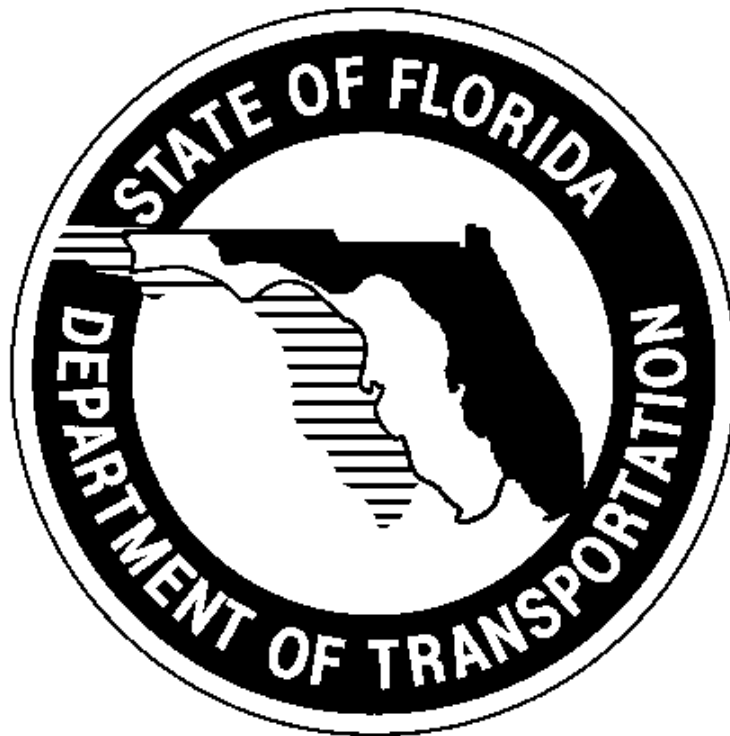

ROADWAY DESIGN OFFICE

TALLAHASSEE, FLORIDA

JANUARY 1, 2006

SECOND EDITION

REVISED – JANUARY 1, 2007

<http://www.dot.state.fl.us/rddesign/PPMManual/PPM.htm>

THIS PAGE LEFT BLANK INTENTIONALLY

Table of Contents

Introduction

Chapter 1	Production of Plans
Chapter 2	Sequence of Plans Preparation
Chapter 3	Key Sheet
Chapter 4	Summary of Pay Items
Chapter 5	Drainage Map and Bridge Hydraulic Recommendation Sheet
Chapter 6	Typical Sections
Chapter 7	Summary of Quantities
Chapter 8	Summary of Drainage Structures and Optional Materials Tabulation
Chapter 9	Project Layout
Chapter 10	Roadway Plan and Roadway Plan-Profile
Chapter 11	Special Profiles
Chapter 12	Back-of-Sidewalk Profiles
Chapter 13	Intersection and Interchange Details/Layouts
Chapter 14	Drainage Structures
Chapter 15	Lateral Ditch/Outfalls, Retention/Detention and Mitigation Areas
Chapter 16	Special Details
Chapter 17	Soil Survey
Chapter 18	Roadway Cross Sections
Chapter 19	Temporary Traffic Control Plan
Chapter 20	Utility Adjustments
Chapter 21	Selective Clearing and Grubbing
Chapter 22	Miscellaneous Structures Plans
Chapter 23	Signing and Pavement Marking Plans
Chapter 24	Signalization Plans
Chapter 25	Lighting Plans
Chapter 26	Landscape Plans
Chapter 27	Utility Joint Participation Agreement Plans
Chapter 28	Stormwater Pollution Prevention Plan
Chapter 29	Intelligent Transportation Systems Plans
Appendix A	Metric Practice

THIS PAGE LEFT BLANK INTENTIONALLY

Introduction

Plans Preparation Manual, Volume II

PURPOSE:

This *Plans Preparation Manual, Volume II* sets forth requirements for the preparation and assembly of contract plans for Florida Department of Transportation (FDOT) projects. The information contained herein applies to the preparation of contract plans for both roadways and structures.

AUTHORITY:

Sections 20.23(3)(a) and 334.048(3), Florida Statutes.

SCOPE:

This procedure impacts anyone preparing roadway and structures contract plans for the Department.

GENERAL INFORMATION:

Chapter 334 of the *Florida Statutes*, as part of the Florida Transportation Code, establishes the responsibilities of the State, counties, and municipalities for the planning and development of the transportation systems serving the people of Florida, with the objective of assuring development of an integrated, balanced statewide system. The Code's purpose is to protect the safety and general welfare of the people of the State and to preserve and improve all transportation facilities in Florida. Under *Section 334.048(3)*, the Code sets forth the powers and duties of the Department of Transportation including to adopt rules, procedures and standards for the conduct of its business operations and the implementation of any provisions of law for which the Department is responsible.

PROCEDURE:

The standards and applications contained in this volume of the **Plans Preparation Manual** are requirements for the design and preparation of contract plans used in the construction of FDOT projects. This volume is to be used in conjunction with **Volume I** of the **Plans Preparation Manual (PPM) (Topic No. 625-000-007)**.

The preparation of roadway and structures plans is primarily a matter of sound application of acceptable engineering criteria, standards and presentation techniques. While the requirements contained in this volume provide a basis for uniformity in plans preparation, precise formatting and presentation standards which apply to individual situations must rely on good engineering practice and judgment. The use of these requirements does not relieve the engineer from the professional responsibility for the accuracy and completeness of the contract plans set(s).

1. PLANS PREPARATION MANUAL, VOLUME II - MANUAL ORGANIZATION
 - a. Background

The Florida Department of Transportation's **Plans Preparation Manual** was previously published as a two volume set in 1989. The manual preceded Department requirements for use of the Metric System, and featured only English units. **Volume I** contained design criteria and process requirements, while **Volume II** addressed plans preparation and assembly.

This English version of **Volume II** was produced using the same basic format, and closely paralleling, **Volume II - Metric**. This was due in large part to the outdated information in the 1989 English version for such areas as Computer Aided Design Drafting (CADD), plans processing, sheet sizes, etc.

- b. Organization

The **Plans Preparation Manual, Volume II** contains specific requirements for plans production and assembly. The manual consists of individual chapters, each addressing the requirements for a plan sheet or component, and is ordered according to the way a standard plans set would be assembled.

2. DISTRIBUTION

This document is distributed on CD through **FDOT Maps and Publications Sales**. Copies may be obtained from:

Florida Department of Transportation
Maps and Publications Sales, Mail Station 12
605 Suwannee Street
Tallahassee, FL 32399-0450
Telephone (850) 414-4050
FAX Number (850) 414-8036
<http://www.dot.state.fl.us/MapsAndPublications/>

For updates and manual registration information contact:

Roadway Design Office, Mail Station 32
Telephone (850) 414-4310
FAX Number (850) 414-5261
<http://www.dot.state.fl.us/rddesign/>

3. REVISIONS AND UPDATES

Plans Preparation Manual holders are encouraged to submit comments and suggestions for changes to the manual to the Roadway Design Office. When ideas or suggestions are received they will be reviewed by appropriate Roadway and/or Structures Design staff in a timely manner and will be coordinated with other offices affected by the proposed change.

Structures design issues which are subject to modification and revision will be processed in coordination with the Structures Design Office.

Proposed revisions are distributed in draft form to the District Design Engineers (DDE). The DDE coordinates the review of the proposed revisions with other affected district offices such as Structures Design. The goal is to obtain a majority opinion before revisions are made.

The Roadway Design Office will also coordinate proposed revisions or additions with affected offices within the Central Office. Substantive revisions that result in policy change will be coordinated with the Executive Committee for concurrence.

Revisions are voted on jointly by the District Design Engineers and the State Roadway Design Engineer (for Roadway Design issues) or the State Structures Design Engineer (for Structures Design issues). Each district will have one vote and the central office will have two votes; for a total of ten votes. Requirements mandated by FHWA or State Rules will not be subject to this majority vote.

All revisions and updates will be coordinated with the Forms and Procedures Office prior to distribution to ensure conformance with and incorporation into the Department's Standard Operating System. The standard interval for issuing updates to the **PPM** is yearly, in January, when the adopted revisions and addenda will be distributed to registered holders of the manual.

Items warranting immediate change will be made with the approval of the State Roadway Design Engineer in the form of a Design Bulletin.

TRAINING:

None required.

FORMS ACCESS:

Documents marked as **SAMPLES** provide only a starting point allowing users to change or alter the document as needed to fit specific situations. Samples are not official forms of the Department.

Chapter 1

Production of Plans

1.1	General	1-1
1.2	Legibility Guidelines	1-2
1.3	Displaying Information and Data	1-3
1.3.1	Converting from Metric to English	1-4
1.4	Base Sheet Format	1-5
1.5	Plan Notes.....	1-6

Figures

Figure 1.1	Project Information Block	1-5
------------	---------------------------------	-----

THIS PAGE INTENTIONALLY LEFT BLANK

Chapter 1

Production of Plans

1.1 General

This volume shall be used in conjunction with ***Volume I - English*** of the ***Plans Preparation Manual***. Close attention must be paid to the harmonizing of design criteria and processes outlined in ***Volume I*** with the related areas of plans preparation and presentation required in this volume.

The contract plans set and the specifications are the key documents for project construction and on which the contractor bases his bid. Hence, it is imperative that the contract plans and specifications set forth the work to be done in a clear and concise manner.

The Engineer of Record (EOR) must provide quality control of plans, CADD files and deliverables as outlined in the Department's ***CADD Manual, Topic No. 625-050-001*** (or latest version) and this volume. These resources, in conjunction with district and project scope requirements, shall form the basis for contract plans format and assembly.

Plan sheets content and appearance will follow the requirements of this volume. Refer to the FDOT ***CADD Production Criteria Handbook*** for such features as line weight, style, color, and level.

The exhibits shown in this volume were developed using FDOT criteria/standards in force at the time of their creation. See ***Volume I*** for criteria.

1.2 Legibility Guidelines

Normally, all letters and figures should be readable from either the bottom or right edge of the sheet. The guide for reading is as follows:

1. Horizontal Line: Read left to right
2. Vertical Line: Read bottom to top
3. Diagonals: Read left to right

Abbreviations may be used where they save time and space. Abbreviations must be clear and easily understood. A list of standard abbreviations is given in the ***Design Standards, Index No. 001***.

Standard symbols for Roadway Design are shown in the ***Design Standards, Index No. 002***, the Symbol Cell Library, and other CADD sources.

1.3 Displaying Information and Data

The following rules apply for displaying information and data in the plans:

1. Dimensioning Requirements:
 - a. Typical Section Elements, including lane widths and shoulder widths - in feet, generally as a whole number.
 - b. Horizontal control points on plans, including survey centerline, baseline, intersections and alignment - in feet to 2 decimal places.
 - c. Vertical alignment control points, (PVC, PVI, PVT) and profile grade elevations - in feet to 2 decimal places.
 - d. Profile Grade - in percent to 3 decimal places.
 - e. Proposed flow lines - in feet to 2 decimal places.
 - f. Manhole tops and grate elevations - in feet to 2 decimal places.
 - g. Ditch elevations - in feet to 1 decimal place (to nearest 0.05 when controlled by percent of grade).
 - h. Box or Three-sided Culvert Spans and Heights - (Show feet as a whole number using the span by height format: e.g., 10 x 6 means the span is 10 feet and the height is 6 feet): In feet as a whole number for new construction; in feet to 2 decimal places for extensions of existing box culverts.
2. Display alignment bearings, degree of curve and delta angles for curve data in degrees, minutes and seconds, rounded to the nearest second.
3. Express slope ratios in vertical to horizontal (V:H) format. For example, show roadside slopes as 1:6, 1:4, etc.

1.3.1 Converting from Metric to English

1. When converting metric values related to surveys, right of way and other geometric alignment use the U.S. Survey Foot taken to a minimum of 8 decimal places:

$$1 \text{ foot} = \frac{12 \text{ inches/foot}}{39.37 \text{ inches/meter}} = 0.304 \ 800 \ 61 \text{ meters}$$

For other direct mathematical conversions use the SI definition: 1 foot = 0.3048 meters

2. Display direct mathematical (soft) converted values to 2 decimal places.
3. On resurfacing projects where the original construction was done in metric, hard convert typical section dimensions (lane widths, shoulder widths, etc.) where existing conditions permit.

Use direct mathematical (soft) conversion for existing pavement widths in curbed sections, existing right of way widths, and existing median widths.

Further information that may be useful in the converting Metric to English may be found in **Appendix A** of this volume.

1.4 Base Sheet Format

All plan sheet formats are contained in the FDOT Engineering/CADD Systems Software. Sheet borders include a place for the Financial Project ID. For those projects that still have a State Project Number, the number must be added to each sheet in the plans. A separate cell is available for placement above the Financial Project ID as shown below:

Figure 1.1 Project Information Block

	STATE PROJECT NO.		
	STATE OF FLORIDA DEPARTMENT OF TRANSPORTATION		
	ROAD NO.	COUNTY	FINANCIAL PROJECT ID

The blank space immediately left of the box for Financial Project ID information is provided for the Engineer of Record information as required in **Section 19.2, Volume I**.

Contract plans shall be plotted to scale on size B (11" X 17") multipurpose paper. These plots are to be generated from image files in accordance with the **CADD Manual, Section 3.8.3**. Care must be taken in setting up plotting equipment and software to center the sheet border and provide a minimum 3/4" margin at each end of the sheet. This is necessary to maintain plan sheet scales and to facilitate the reproduction process used for providing contract plan sets for advertisement and construction.

Sheets that feature grids (cross sections, plan-profile, etc.) can be plotted with minor grid lines turned off or on. If the minor grids are plotted, they are to be half-toned. The FDOT Engineering/CADD System Software provides Microstation system plot drivers for this task. Pen tables for half-toning, using CAD Net plotting, are also available from the FDOT Engineering/CADD Systems Office.

No aerial photography of any type is permitted in final contract plans.

1.5 Plan Notes

Plan notes are intended to be used to clarify design detail, construction practices or method for payment. In general, plan notes should be kept to a minimum. Only those notes that are job specific should be used. Plan notes should only be used to detail uniqueness and not to broaden or curtail requirements in the specifications. Notes that restate the standard specifications or standard indexes shall not be used. This will help to place proper emphasis on those notes that are job specific and avoid discrepancy of documents.

Chapter 2

Sequence of Plans Preparation

2.1	General	2-1
2.2	Data Collection and Presentation.....	2-2
2.2.1	Type of Project.....	2-2
2.2.2	Presentation of Existing Data.....	2-3
2.2.3	Proposed Typical Section	2-3
2.2.4	Geometrics.....	2-3
2.2.5	Cross Sections.....	2-4
2.3	Phase Submittals	2-5
2.3.1	General	2-5
2.3.2	Phases	2-5
2.3.2.1	Requirements for Phase I Submittal	2-8
2.3.2.2	Requirements for Phase II Submittal	2-10
2.3.2.3	Phase III Plans Submittal.....	2-17
2.3.2.4	Phase IV Plans Submittal	2-17
Figures		
Figure 2.1	Summary of Phase Submittals.....	2-7

THIS PAGE INTENTIONALLY LEFT BLANK

Chapter 2

Sequence of Plans Preparation

2.1 General

The set of plans depicting in detail the desired construction work is known as the "Contract Plans Set". This set consists of all sheets pertaining to roadway design (Roadway Plans), and other component plans. The other component plans are comprised of:

1. Signing and Pavement Marking Plans
2. Signalization Plans
3. Intelligent Transportation Systems (ITS) Plans
4. Lighting Plans
5. Landscape Plans
6. Architectural Plans
7. Structures Plans

All plan details shall be included in the Roadway Plans or one of the component plans listed above. Components other than those listed above shall not be used unless approved by the State Roadway Design Engineer. Such approval should be requested prior to the Phase II submittal.

Utility Joint Participation Agreement Plans have a separate Financial Project ID and are placed in the back of the contract plans set.

The contract plans set should be prepared systematically, undergoing phases of review and revision to ensure technically correct and clear plans.

If the plans are structures plans and there is no work on the approach roadway, the structures plans become the lead project. Any other sheets incidental to the project typically found within the roadway plans or other component plans (i.e., traffic control plans, signing and marking, etc.), may be included in the structures plans and numbered consecutively in accordance with the ***Structures Manual, Volume 2 – Structures Detailing Manual***.

2.2 Data Collection and Presentation

2.2.1 Type of Project

The type and amount of data required for each project depends on the project. For new construction and reconstruction projects which have had a Project Development and Environment (PD&E) phase the data to be used for plans preparation could include the following:

1. Preliminary Engineering Report
2. Project Scope
3. Project schedule
4. Field survey and/or CADD files (including existing features such as topography, ground elevations, drainage structures, and right of way)
5. R/W requirements
6. Soils information
7. Commitments for environmental permits or mitigation
8. Typical Section Package
9. Traffic Data
10. Pedestrian and bicycle considerations
11. Structural design requirements
12. Commitments to local government(s)

For projects without the PD&E phase, such as RRR or Safety projects, some of the items listed will not be required. Regardless of type, all projects should begin with a field review to determine other requirements such as additional survey needs, utility information, etc.

Additional information can be found in **Chapters 13-16 of Volume I**. These chapters contain a comprehensive discussion of the critical issues and major activities for the design process, from initial to final engineering.

2.2.2 Presentation of Existing Data

CADD files generated from the field survey will contain existing topography and other characteristics of the project site. These also include the existing utilities and drainage structures within the limits of the project.

All data pertaining to topography, horizontal location of existing utilities and drainage structures shall be shown on the plan portion of the appropriate sheets (whether they are plan view only, or plan-profile).

2.2.3 Proposed Typical Section

Typical sections show the cross sectional design elements of a roadway. In addition to the Typical Section Sheet, certain elements of the typical section are shown on various other plan sheets, such as the Plan-Profile Sheets and Cross Sections. The various chapters for individual plan sheets address the specific requirements for displaying data (including typical section elements) on those sheets.

2.2.4 Geometrics

The Engineer of Record (EOR) sets the horizontal and vertical geometrics for a project and develops or supervises development of the CADD files used in the production of various plans sheets.

Horizontal geometrics include the baseline survey/centerline construction with bearings, curve data, angles or bearings at street intersections, pavement widths, taper lengths, left turn lanes, and other geometric elements. These elements are plotted on the plan portion of the plan-profile sheets, as well as other appropriate plan sheets.

Vertical geometrics show the vertical curves and grades of the roadway along the profile grade line. On municipal projects back-of-sidewalk profiles are developed to provide a vertical alignment which addresses drainage requirements and harmonizes connections to adjacent properties. The back-of-sidewalk profiles may be included in the roadway plans as directed by the district.

On all projects which include the development of a vertical alignment the existing ground line along the baseline of survey and the proposed profile grade line shall be plotted on the profile portion of appropriate sheets in the roadway or structures plans.

2.2.5 Cross Sections

Information required for plotting existing cross sections is obtained from survey data and CADD files. These data, along with existing utilities and proposed templates, are shown on the cross sections. Refer to **Chapter 18** of this volume for additional information.

2.3 Phase Submittals

2.3.1 General

Requirements relating to the *design process* for various submittals are given in **Chapter 16, Volume I** of this manual. Refer to that chapter for additional guidance in preparing submittals for review by the Department.

For bridge submittal requirements see **Chapter 26, Volume I**.

2.3.2 Phases

The remainder of this chapter outlines, in detail, the sequence for contract plans preparation and assembly, as well as the information required to be presented on the various plan sheets which are included in design phase submittals.

As stated in **Section 16.4 of Volume I**... "The number of submittals and phase reviews shall be determined on a project-by-project basis and shall be defined in the scope. Submittals allow functional areas to review the development of the project as contained in the scope."

Standard submittal phases are as follows:

SUBMITTAL PHASES

- Phase I
- Phase II
- Phase III
- Phase IV

Minor projects should typically have two phase reviews.

Figure 2.1 summarizes the plans sheet status for each submittal. No phase is complete until all review comments have been resolved and documented.

The technical accuracy required for the design is the responsibility of the Engineer of Record. Prior to submitting the plans for a formal FDOT Phase review, the design organization (in-house or consultant) shall conduct a review to ensure technically correct and complete plans. Any revisions or corrections noted during the review shall be incorporated into the plans before submittal for the formal Phase review.

When deemed necessary by the Engineer of Record, or as requested by the district, phase submittals may include an additional plan sheet titled "Notes for Reviewers." This sheet is placed as the second sheet in the submittal package. It contains information pertinent to design criteria and special project requirements, as well as other details or notes which call the reviewer's attention to issues and features unique to the project design. The sheet is to be used only in the review process and is not included in the final plans.

Figure 2.1 Summary of Phase Submittals

ITEM	PHASE	PHASE*	PHASE	PHASE
	I	II	III	IV
Key Sheet	P	P	C	F
Summary of Pay Items		P	C	F
Drainage Map	P	P	C	F
Interchange Drainage Map	P	P	C	F
Typical Section	P	C	C	F
Summary of Quantities			C	F
Box Culvert Data			C	F
Summary of Drainage Structures			C	F
Optional Materials Tabulation		P	C	F
Project Layout	P	C	C	F
Roadway Plan-Profile	P	P	C	F
Special Profile	P	P	C	F
Back-of-Sidewalk Profile	P	C	C	F
Interchange Layout	P	P	C	F
Ramp Terminal Details		P	C	F
Intersection Layout/Detail	P	P	C	F
Drainage Structures		P	C	F
Lateral Ditch Plan-Profile		P	C	F
Lateral Ditch Cross Section		P	C	F
Retention/Detention Ponds		P	C	F
Cross Section Pattern		P	C	F
Roadway Soil Survey		P	C	F
Cross Sections	P	P	C	F
Stormwater Pollution Prevention Plan		P	C	F
Traffic Control Plans	P	P	C	F
Utility Adjustment		P	C	F
Selective Clearing and Grubbing		P	C	F
Mitigation Plans		P	C	F
Miscellaneous Structures Plans		P	C	F
Signing and Pavement Marking Plans		P	C	F
Signalization Plans		P	C	F
Intelligent Transportation System (ITS) Plans		P	C	F
Lighting Plans		P	C	F
Landscape Plans	P	P	C	F
Utility Joint Participation Agreement Plans			C	F
Computation Book			C	F
Contract Time			P	F

Status Key:

- P** - Preliminary
- C** - Complete but subject to change
- F** - Final

* Projects which have a structures plans component are required to submit the latest set of structures plans with the Phase II roadway submittal.

2.3.2.1 Requirements for Phase I Submittal

Unless otherwise directed by the district, the following elements are required for a Phase I set of plans.

KEY SHEET

Location Map w/ location of project on map
All applicable Financial Project ID's
(Federal Funds) notation, if applicable
Exceptions & Equations
County Name
State Road Number
Length of project box
North arrow and scale
Approval signature lines
Railroad crossing (if applicable)
Revision box
Governing Standards & Specifications dates
Project Manager's Name
Begin & end project station and begin mile post
Begin & end bridge stations
Consultant's name, address, contract number,
Certificate of Authorization number and vendor
number (if applicable)

DRAINAGE MAP - PLAN VIEW

North arrow and scale
Drainage divides and ground elevations
Drainage areas and flow direction arrows
Equations
High water information as required
Preliminary horizontal alignment
Section, township, range lines
Street names
Begin & end stations of project, bridge, bridge
culverts & exceptions
Existing structures & pipes with relevant
information

State, Federal, county highway numbers (as
appropriate)

DRAINAGE MAP - PROFILE VIEW

Preliminary profile grade & existing ground line
Horizontal & vertical scale
Begin & end stations of project, bridges, bridge
culverts & exceptions
Equations

INTERCHANGE DRAINAGE MAP

North arrow and scale
Stationing along baselines
Ramp baselines with nomenclature
Begin and end bridge stationing
Preliminary interchange configuration
R/W lines
Preliminary interchange drainage with drainage
areas and flow direction arrows

TYPICAL SECTIONS

Mainline and crossroad typicals
R/W lines
Special details (bifurcated sections, high fills,
etc.)
Traffic data

PROJECT LAYOUT / Reference Points

Plan-profile sheet sequence (mainline and
crossroads)
Reference points (if layout sheet is required)

PLAN AND PROFILE - PLAN VIEW

North arrow and scale
Baseline of survey, equations
Curve data (including superelevation)
Existing topography including utilities
Preliminary horizontal geometrics/dimensions
Existing & proposed R/W lines (if available)
Centerline of construction (if different from the baseline of survey)
Begin and end stations for the project, bridges, bridge culverts and exceptions
Reference points (if project layout sheet not included in plans set)

PLAN AND PROFILE - PROFILE VIEW

Scale
Appropriate existing utilities
Bench mark information
Preliminary profile grade line
Equations
Existing ground line with elevations at each end of sheet
Begin and End Stations for the Project, bridges, bridge culverts and exceptions.

SPECIAL PROFILE

Scale
Ramp profile worksheet including nose sections
Existing ground line of intersections
Preliminary grade line of intersections
Preliminary curb return profiles, if applicable

BACK-OF-SIDEWALK PROFILE (Worksheet)

Scale
Begin and end project stations
Begin and end sidewalk stations
Cross-street locations and elevations
Drainage flow direction arrows
Mainline equations
Existing driveway locations and details

Superelevation details
Back-of-sidewalk profile grades and vertical curve information
Building floor elevations with offset distance left and right
Gradeline notation: Specifically the numeric difference relative to roadway profile gradeline

INTERCHANGE DETAIL

North arrow and scale
Schematic of traffic flow and volumes
Proposed bridge limits
R/W lines
Preliminary configuration and geometrics
Quadrant Identification
Ramp Labels

INTERSECTION LAYOUT

North arrow and scale
Existing topography (if applicable)
Proposed R/W limits
Length of turn lanes
Taper lengths
Existing Utilities
Geometric dimensions (radii, offsets, widths)

CROSS SECTIONS*

Scale
Existing ground line
Existing survey baseline elevations
Station numbers
Baseline of survey labeled
Existing utilities
Proposed template with profile grade elevations along mainline and cross-streets as necessary

TRAFFIC CONTROL PLANS

Project specific
Other worksheets as necessary to convey concept and scope.

LANDSCAPE PLANS

Conceptual landscape plan

*May require accompanying cross section pattern sheet

2.3.2.2 Requirements for Phase II Submittal

Unless otherwise directed by the district, the following elements are required for a Phase II set of plans.

KEY SHEET

Index of sheets
Contract plans and component plans list

SUMMARY OF PAY ITEMS

Item numbers with descriptions (on 8 1/2" x 11" paper until the project proposal has been created)

DRAINAGE MAP - PLAN VIEW

Proposed structures with structure numbers
Proposed storm sewer pipes
Flow arrows along proposed ditches
Retention/Detention ponds, pond number and area size
Cross drains with pipe sizes and structure numbers
Bridges/bridge culverts with begin and end stations
Flood data (if applicable)

DRAINAGE MAP - PROFILE VIEW

Ditch gradients including DPIs
Final roadway profile grade line
Mainline storm sewer pipes
Mainline flow line elevations
Mainline structures with structure numbers and pipes
Bridge, Bridge Culvert
Cross drains with pipe sizes, structure numbers and flow line elevation

INTERCHANGE DRAINAGE MAP

Final geometrics including PC and PT
Proposed structures with structure numbers
Proposed storm sewer pipes
Special ditches with DPI and elevation

TYPICAL SECTIONS

Pavement Design

OPTIONAL MATERIALS TABULATION

Material type
Structure number station and description
Durability, cover requirements
Optional culvert material application
Culvert service life estimator
Design service life

PROJECT LAYOUT

Complete

PLAN AND PROFILE - PLAN VIEW

Curb return numbers, station ties and elevations
Proposed drainage structures with structure no.
Proposed R/W lines
Existing utilities
Proposed side drain pipe requirements (including size) for access and intersections
Final geometrics and dimensions including radii, station pluses, offsets, widths, taper/transition lengths, curve data
General notes (if project layout sheet not included)
Flood data if not shown elsewhere
Limits of wetlands

PLAN AND PROFILE - PROFILE VIEW

Final profile grades and vertical curve data
Mainline storm sewer pipes
Proposed special ditches
Ditch gradients with DPI station and elevation
Non-standard superelevation transition details
High water elevations
Existing utilities
Mainline drainage structures with structure numbers
Cross drains with structure number, size and flow line elevations

SPECIAL PROFILE

Final intersection profile grades
Final curb return profiles (if applicable)
Superelevation diagrams as required
Final ramp profile grades including nose sections
Preliminary access and frontage road profiles (may contain one or more types of special profiles.)

BACK-OF-SIDEWALK PROFILE

Complete

INTERCHANGE LAYOUT

Curve data including superelevation and design speed
Coordinate data, stationing and ties
Access and/or frontage roads with dimensions and R/W
Fence location
Ramp identification

RAMP TERMINAL DETAILS

Preliminary geometrics
Radii, transition/taper lengths
Ramp identification

INTERSECTION LAYOUT

Limits of proposed construction along side roads
Applicable notes
Cross drains with structure numbers and pipe sizes
Storm sewer pipes including sizes
Final geometrics including dimensions, radii, offsets, station pluses and taper/transition lengths

DRAINAGE STRUCTURES

Vertical and horizontal scale
Roadway template with profile grade elevation
Underground utilities
Special sections at conflict points
R/W lines (at critical locations)
Storm sewer construction notes
Flow arrows
Applicable notes
Structure numbers and location station along right side of sheet
Drainage structures with numbers in numerical order, type, size, location and flowline elevations

OUTFALL / LATERAL DITCH SYSTEM - PLAN VIEW

North arrow and scale
Roadway centerline
Existing and/or survey ditch centerline
Proposed ditch centerline with stationing
Begin and end ditch stations
Equations
Ditch centerline intersection stations
R/W lines
Bearings of ditch and mainline centerlines
Proposed storm sewer pipes
Ditch PI stations with deflection angle left or right
Proposed drainage structures with structure numbers
Existing topography, drainage structures, utilities
Limits of wetlands

**OUTFALL / LATERAL DITCH SYSTEM -
PROFILE VIEW**

Bench mark information
Scale
Existing ground line
Proposed ditch profile with grades
Begin and end ditch stations
High water elevations
Proposed storm sewer pipes with size
Existing Utilities
Overland flow or overtopping elevations
Proposed drainage structures with structure numbers
Typical section can be placed in either plan or profile

LATERAL DITCH CROSS SECTIONS

Horizontal and vertical scale
Existing ground line
Station numbers
Survey centerline and elevation
R/W
Begin and end ditch stations
Begin and end excavation stations
Earthwork quantities
Existing utilities
Total earthwork quantity in cubic yards (CY)
Proposed template with ditch bottom elevation

RETENTION/DETENTION POND DETAILS

North arrow and scale
Roadway centerline ties
Proposed pond centerline with stationing
Begin and end pond stations
Side slopes, dimensions, and elevations
R/W lines
Berm, fence and gate locations
Soil boring information
Proposed pond drainage structures with structure numbers
Existing topography, drainage structures, utilities
Pond sections (2 perpendicular to each other)
Pond Typical Section
Limits of wetlands

**RETENTION/DETENTION POND CROSS
SECTIONS**

Horizontal and vertical scale
Existing ground line
Station numbers
Begin and end pond stationing
Pond centerline and elevations
R/W
Soil borings
Water table
Extent of unsuitable material
Earthwork quantities
Existing utilities
Proposed template with bottom elevation

CROSS SECTION PATTERN

North arrow and scale
Interchange layout
Access and frontage roads
Mainline and ramp stationing
Begin and end bridge stations
Cross section location lines
Ramp baselines with nomenclature and stationing

ROADWAY SOIL SURVEY

Soil data
Project specific

CROSS SECTIONS

R/W
Special ditch bottom elevations
Equivalent stations for ramps and mainline
Mainline equation stations
Soil borings
Water table
Extent of unsuitable material
Proposed template with profile grade elevation
Earthwork Columns
Begin and end stationing for project, construction and earthwork, bridge and bridge culvert
Existing utilities affected by the template and where unsuitable materials are present

STORMWATER POLLUTION PREVENTION PLANS (SWPPP)

Narrative Description (with supplemental topographic maps, when used)

TRAFFIC CONTROL PLANS

Preliminary traffic control plan
Detour plan
Phasing plan
R/W - existing and additional if required
Existing Utilities

UTILITY ADJUSTMENT

All existing utilities highlighted

SELECTIVE CLEARING AND GRUBBING

Limits of construction by station and type of selective clearing and grubbing

MITIGATION PLANS

Project Specific

MISCELLANEOUS STRUCTURES PLANS

Retaining walls (Cast in place, proprietary, temporary) if required

SIGNING AND PAVEMENT MARKING PLANS - KEY SHEET

Financial Project ID
(Federal Funds) notation, if applicable
State Road Number
County Name
FDOT Project Manager's Name
Begin/end stations & exceptions
Station Equations (if location map is shown)
Engineer of Record
Consultants name & address, if applicable

SIGNING AND PAVEMENT MARKING PLANS - TABULATION OF QUANTITIES

Project Specific

SIGNING AND PAVEMENT MARKING PLANS - PLAN SHEETS

North arrow and scale
Basic Roadway Geometrics
Begin/End Stations and Exceptions
Station equations
Conflicting utilities, lighting or drainage
Pavement markings
Sign locations
Applicable pay items

SIGNING AND PAVEMENT MARKING PLANS - SIGN DETAIL SHEETS

GUIDE SIGN WORK SHEETS
Project Specific

SIGNALIZATION PLANS - KEY SHEET

Financial Project ID
(Federal Funds) notation, if applicable
State Road Number
County Name
FDOT Project Manager's Name
Begin/end stations & exceptions
Station Equations (if location map is shown)
Engineer of Record
Consultants name & address, if applicable

ITS PLANS - KEY SHEET

Financial Project ID
(Federal Funds) notation, if applicable
State Road Number
County Name
FDOT Project Manager's Name
Begin/end stations & exceptions
Station Equations (if location map is shown)
Engineer of Record
Consultants name & address, if applicable

SIGNALIZATION PLANS - TABULATION OF QUANTITIES

Project Specific

ITS PLANS - TABULATION OF QUANTITIES

Project Specific

SIGNALIZATION PLANS - PLAN SHEET

North arrow and scale
Basic Roadway Geometrics
Begin/End Stations and Exceptions
Station Equations
Conflicting utilities, lighting or drainage
Signal Pole Location
Type and location of loops
Type and location of signal heads
Pedestrian Signal
Location of Stop Bars
Location of Pedestrian Crosswalks
Sheet Title
Applicable pay items

ITS PLANS - PLAN SHEETS

Project Specific, but must include:
North arrow and scale
Basic Roadway Geometrics
Begin/End Stations and Exceptions
Station equations
Conflicting utilities, lighting or drainage
Applicable pay items

ITS PLANS - DETAIL SHEETS

Project Specific

SIGNALIZATION PLANS - POLE SCHEDULE

Pole location, number, type
Pole dimensions
Pay item number and quantity
Joint use pole details, if applicable
Foundation design

**SIGNALIZATION PLANS - INTERCONNECT/
COMMUNICATION CABLE PLAN**

Placement of interconnect/communication cable
Conflicting utilities, lighting or drainage
Other project specific details

LIGHTING PLANS - KEY SHEET

Financial Project ID
(Federal Funds) notation, if applicable
State Road Number
County Name
FDOT Project Manager's Name
Begin/end stations & exceptions
Station Equations (if location map is shown)
Engineer of Record
Consultants name & address, if applicable

LIGHTING PLANS - TABULATION OF QUANTITIES
Project Specific

LIGHTING PLANS - POLE DATA AND LEGEND SHEET

Each pole by number with location, arm length, mounting height and luminaire wattage noted.
Design value for light intensities and uniformity ratios shown.
Legend and sheet title

LIGHTING PLANS - PLAN SHEETS

North arrow and scale
Basic Roadway Geometrics
Begin/End Stations and Equations
Station Equations
Conflicting utilities, drainage, signal poles, etc.
Sheet title
Applicable pay items
Pole symbols shown at correct station location and approximate offset

LIGHTING PLANS - HIGH MAST

Foundation detail sheets (project specific)
Boring data sheets (project specific)
Conflicting utilities, drainage, lighting

LANDSCAPE PLANS - KEY SHEET

Financial Project ID
(Federal Funds) notation, if applicable
Fiscal year and sheet number
State Road Number
County Name
FDOT Project Manager's Name
Begin/end stations & exceptions
Station Equations (if location map is shown)
Landscape Architect of Record name and registration number
Consultants name, address, and contract number, if applicable
Index of landscape plans

LANDSCAPE PLANS - TABULATION OF QUANTITIES AND PLANT SCHEDULE
Project Specific

LANDSCAPE PLANS - TABULATION OF QUANTITIES AND SCHEDULE FOR IRRIGATION AND SITE AMENITIES
Project Specific

LANDSCAPE PLANS – PLANTING PLAN SHEETS

Project centerline
Edge of pavement (edge of traffic lanes)
Curbs or curb and gutter
Drainage systems
Guardrails
Right of way and/or limited access fence line
Sidewalks or other planned or existing structures
Lighting, signs, and signal poles
Intersections and driveways which are noted in the plans
Existing and proposed overhead and underground utility locations
Clear Zone/Horizontal clearance (should be plotted or safety setback distances noted frequently on each plan sheet)
View zones for permitted outdoor advertising signs
Canopy limits
Existing vegetation (to remain or be removed)
Existing off site features and conditions that affect or are affected by the project
Fence and gate locations
Setbacks from structural elements or drainage system
Limits of clear sight
Transit facilities
Proposed Planting Plan (Plant symbols and Plant quantities)

LANDSCAPE PLANS - IRRIGATION PLAN SHEETS

(if applicable)
Type of system
Location and size of mainlines and lateral lines
Type and location of spray heads and rotors
Type and location of valves, sleeves, controllers, water sources/point of connection, backflow preventers, and isolation valves

LANDSCAPE PLANS –DETAILS SHEET

Applicable landscape details
Irrigation symbology with associative descriptions (if applicable)

2.3.2.3 Phase III Plans Submittal

Ordinarily, the only other remaining work to be done will be to comply with comments received as a result of the review. The Work Zone Traffic Control items paid for on a 'per day' basis shall be estimated and included in the Phase III submittal.

The FDOT construction department will make a biddability review and will establish construction duration as a part of the Phase III review after receiving the computation book. This information should be included in the Phase III review comments transmitted back to the EOR. The estimated pay items for Work Zone Traffic Control shall be revised as necessary based on the established construction duration.

All plan sheets and computation books are complete and the Financial Management (FM) system has been updated. Final drainage tabulations shall also be furnished for review.

Utility Joint Participation Agreement (JPA) Plans, consisting of a key sheet, and mainline plan-profile showing proposed utility horizontal and vertical locations, are also to be included in the Phase III submittal.

A "marked up" set of the plans and review comments shall be returned to the EOR for incorporation of the comments into the plans. When the review comments have been resolved and documented by the designer, the plans are ready to proceed to completion.

2.3.2.4 Phase IV Plans Submittal

After all corrections noted in the Phase III submittal are complete and the cost estimate is complete, the plans are considered final.

THIS PAGE INTENTIONALLY LEFT BLANK

Chapter 3

Key Sheet

3.1	General	3-1
3.2	Project Identification	3-2
3.2.1	Financial Project ID, Federal Funds, County Name and State Road Number	3-2
3.2.2	Fiscal Year and Sheet Number	3-3
3.2.3	Length of Project Box.....	3-3
3.3	Project Location Map	3-5
3.4	North Arrow and Scale	3-7
3.5	Component Plans in Contract Plans Set.....	3-8
3.6	Index of Sheets	3-9
3.7	Professional Responsibility	3-11
3.8	Governing Specifications and Standards	3-12
3.9	State Map.....	3-12
3.10	Railroad Crossing.....	3-13
3.11	Revisions.....	3-13

THIS PAGE LEFT BLANK INTENTIONALLY

Chapter 3

Key Sheet

3.1 General

This is the first sheet in the contract plans. It describes the project, the contents of the plans, and identifies those responsible for preparing the plans. The key sheet cell can be found in the FDOT Engineering/CADD Systems Software. Levels and fonts for additional data can be found in the FDOT ***CADD Production Criteria Handbook***.

For key sheet example, see ***Exhibit KS-1***.

3.2 Project Identification

Background: On May 21, 1997, the State Highway Engineer instructed District Secretaries on the implementation of the Financial Management System. This system replaces the Work Program Administration, the Job Cost Reporting and the Federal Project Accounting systems. Once implemented, all contract documents/sheets that historically had shown project or WPI numbers were to have the new project number on every sheet. Beginning March 16, 1998, a Financial Project ID was assigned to each old project, and from then on new projects have been assigned the Financial Project ID only. In his memorandum to the District Design Engineers dated April 22, 1998, the State Roadway Design Engineer requested that, starting with the plans packages mailed to Tallahassee for the January 1999 letting, the new number be printed on all sheets. On June 30, 1998, the Secretary instructed the Department to use the Financial Project ID in all project documents.

3.2.1 Financial Project ID, Federal Funds, County Name and State Road Number

The Financial Project ID is the main number identifying each individual project within the Department. On the key sheet, this number is located immediately under the heading "CONTRACT PLANS", as shown in the exhibits. Where Federal funds are involved, the words "(Federal Funds)" are to be placed under the Financial Project ID. The county name and the state road number will be included under the Financial Project ID. Also, the "county and roadway section number" associated with Straight Line Diagrams will be placed within parentheses to the right of the county name, as shown on ***Exhibit KS-1***.

Strung projects, those that are independently prepared but are to be let in the same construction contract, shall have the additional Financial Project IDs noted on the right side of the key sheet.

On projects which have one Contract plans set, but multiple Financial Project ID's, all of the Financial Project ID's are located immediately under the heading "CONTRACT PLANS" on the key sheet. On all other plan sheets, the lead Financial Project ID is to be shown.

3.2.2 Fiscal Year and Sheet Number

The construction fiscal year to be entered in the fiscal year box on the bottom right corner is the second year in the fiscal year, i.e., enter 01 for fiscal year beginning July 2000 and ending June 2001. The key sheet of each component of the plans set will be numbered as the first sheet of that component.

3.2.3 Length of Project Box

Lengths of roadway, bridges, bridge culverts, exceptions, and net and gross lengths of the project shall be shown in a box in the center of the sheet below the location map. The length of the project is computed as follows:

1. Roadway = End Project - Begin Project - Exceptions - Bridges (not including bridge culverts) adjusted for Equations
2. Net = Roadway + Bridges
3. Gross = End Project - Begin Project (adjusted for Equations)

The roadway and bridge length shall be computed in feet and converted to miles, to three decimal places, without rounding off. The roadway and/or bridge mileage shall then be rounded so that their total equals the net length. The survey line should be used to compute the length of the project unless: the construction line is substantially different in length (100 feet or more), or the survey line is outside the right of way, or the survey line bridge length is different from the construction line bridge length. The use of the survey line will generally result in fewer equations on the key map.

If divided highways have significantly different lengths for the left and right roadways, the project length shall be based on the longer roadway. A note stating which roadway was used shall be placed adjacent to the project length box.

The "Begin Project" and "End Project" stations are the basis for computing the length. Begin and end construction stations are not to be used in computing the length of the project.

A length of project box is not required on component key sheets.

THIS PAGE INTENTIONALLY LEFT BLANK

3.3 Project Location Map

This map is placed in the center of the sheet and consists of a reproduced portion of one or more maps showing the project location. The map may be a county map or other appropriate map. County maps in raster format (*.cal) are available from the Survey and Mapping Office on CD or can be individually downloaded by county through MicroStation or AutoCAD as a raster reference attachment. Information on the county maps is available at:

<http://www.dot.state.fl.us/surveyingandmapping/geographic.htm>

A utility to download the raster county map and clip out the project location area is provided in the **FDOT CADD Software**. Requests for county maps on CD should be in writing and include the county requested, the purpose for the use, the anticipated duration of the use, the Department of Transportation project manager's name and a CD upon which to copy the data. Requests should be directed to:

Florida Department of Transportation
Survey & Mapping Office
605 Suwannee Street, MS 5L
Tallahassee, Florida 32399-0450
(850) 414-7924

The intent of the location map is to provide enough information so that the project location is easily understood. This may make it necessary to show the Section, Township, Range and County lines together with Section, Township and Range numbers to make the location clear. City and urban limits should be shown where applicable. The begin milepost, correct to three decimal places, shall be shown under the begin project station. The end milepost should be shown if the only project description available is by milepost.

Streets shall be designated by name and State Road number or U.S. Highway number, if appropriate. The name of the next incorporated city to which these roads lead shall be placed at the edge of the map. Roads and topography shall be indicated by standard symbols as shown in the **Design Standards, Index 002** and FDOT Engineering/CADD Systems Software.

Project location shall be shown by a heavy solid line of substantial width. It is sometimes advantageous to show station numbers at regular intervals, particularly with city street projects. The begin and end of projects, any station equations, begin and end of proposed bridges along the state project, bridge culverts and exceptions shall be stationed and flagged. Description by milepost may be permitted if station information is not available.

When several projects are covered by the same set of plans, the beginning and end of each project shall be indicated clearly by the Financial Project ID and stationing. The beginning of each project shall also be indicated by a milepost correct to three decimal places.

The scale of the location map should be chosen so that it will not interfere with other features on the key sheet. A common error is to position the location map on the sheet and then discover that insufficient space remains for the index of sheets, project title or the length of project box.

A location map is not required on component key sheets.

3.4 North Arrow and Scale

The north arrow shall be placed on either side of the location map, preferably to the right. The map scale shall be shown directly below the north arrow. The scale shall be indicated by using a bar scale. The scale distance shall be shown between the ticks. The map shall be oriented so that the arrow will point toward the top of the sheet. If the arrow cannot be oriented to the top, then it must be oriented to point to the right.

3.5 Component Plans in Contract Plans Set

A list of component plans included in the contract plans set shall be shown in the upper left corner. The order of listing shall be:

1. Roadway
2. Signing and Pavement Marking
3. Signalization
4. Intelligent Transportation Systems (ITS)
5. Lighting
6. Landscape
7. Architectural
8. Structures

If sheets covering items such as signing and pavement markings, signalization, ITS, lighting and landscape are included and numbered consecutively within the roadway plans (or structures plans if lead project), these are not to be shown as components of the contract plans set.

If the plans are structures plans and there is no work on the approach roadway, the structures plans become the lead project. Any other sheets incidental to the project typically found within the roadway plans or other component plans (i.e., traffic control plans, signing and marking, etc.), may be included in the structures plans and numbered consecutively in accordance with the ***Structures Manual, Volume 2 – Structures Detailing Manual***.

3.6 Index of Sheets

A complete index of roadway plan sheets shall be placed on the left side of the key sheet under the heading. When projects contain component plans, each plans set shall have an index of sheets on its respective key sheet.

Roadway plans sheets shall be assembled as follows:

1. Key Sheet
2. Summary of Pay Items
3. Drainage Map (optional)
4. Interchange Drainage Map
5. Typical Section
6. Summary of Quantities
7. Box Culvert Data Sheet (if **PSTDN55** design)
8. Summary of Drainage Structures
9. Optional Materials Tabulation
10. Project Layout (optional)
11. Roadway Plan-Profiles
12. Special Profiles
13. Back-of-Sidewalk Profiles (optional)
14. Interchange Layout
15. Ramp Terminal Details
16. Intersection Layout/Detail
17. Drainage Structures
18. Three-Sided/Box Culvert Details (if **LRFD** design)
19. Outfall/Lateral Ditch Plan-Profiles
20. Outfall/Lateral Ditch Cross Sections
21. Special Details
22. Cross Section Pattern
23. Roadway Soil Survey

24. Cross Sections
25. Stormwater Pollution Prevention Plans (SWPPP)
26. Traffic Control Plans
27. Utility Adjustments
28. Selective Clearing and Grubbing
29. Signing and Pavement Marking Plans*
30. Signalization Plans*
31. ITS Plans*
32. Lighting Plans*
33. Landscape Plans*
34. Mitigation Plans
35. Miscellaneous Structures Plans

* When not separate component plans.

In addition, the roadway plans may contain sheets which were prepared separately (perhaps by a sub-consultant) and incorporated into the roadway plans early in the design process. These sheets will appear at the end of the numbered sequence of the roadway plans and must be identified with the following prefixes:

- GR-# Soil Survey and Report of Core Borings normally associated with the roadway plans set (including miscellaneous structures but excluding bridges and walls)
- CTL-# Project Survey Control Sheets
- TR-# Tree Survey Sheets
- UTV-# Verified Utility Locate Sheets

3.7 Professional Responsibility

The name of the Engineer of Record, Architect or Landscape Architect of Record and registration number shall be included on the right side of the sheet. For specific instructions on sealing plans see ***Volume I, Chapter 19***.

For plans prepared by a consulting firm, the name, address, consultant contract number, certificate of authorization number and vendor number of the firm shall be shown on the right side of the sheet.

The Department Project Manager's name shall be shown below the length of project box for consultant and Department prepared plans. For key sheets where length of project is not required, the Department Project Manager's name shall be shown in the same relative location on the sheet.

If shop drawings are anticipated for a project, the name(s) and address(es) of the Delegated Engineer(s) for shop drawing review(s) shall be shown on the right side of the sheet.

3.8 Governing Specifications and Standards

The date of the governing ***Standard Specifications for Road and Bridge Construction*** and of the ***Design Standards*** shall be inserted in a note at the lower left corner of the lead key sheet of each plan set.

A document entitled ***Design Standards Modifications*** includes a listing of all Interim Design Standards issued since publication of the applicable booklet, plus all changes and corrections to notes and text within the booklet that do not warrant the issuance of Interim Indexes (previously handled by Special Provision). The Design Standards Modifications documents will be dated, and posted on the same web site as the Design Standards. The Design Standards Modifications will typically be updated and posted in January and July, 6 months prior to the effective letting date. For example, ***Design Standards Modifications*** dated July 1, 2005 will be posted on the web site in January 2005, but will be effective beginning with the July 2005 letting. Special updates to the Design Standards Modifications posted in between January and July will only be issued when necessary to address changes of immediate concern. When this occurs, email notification will be sent to the Districts and registered Plans Preparation Manual holders.

The applicable Design Standards Modifications and date, and Internet address shall be shown on the lower left corner of the lead key sheet of each plan set, below the Governing Specifications and Standards note, and above the Revisions area. Note that all Interim Indexes listed in the Design Standards Modifications document will be applicable. ***Interim Standards*** shall not be attached to the Contract Plans Set.

The Governing Specifications and Standards note and the Design Standards Modifications note shall not be shown on the key sheets of component plans that are listed on the lead key sheet of each plan set. ***Exhibit KS-1*** gives an example on how these notes are shown.

3.9 State Map

A small-scale state map shall be shown at the upper right portion of the key sheet. The location of the project shall be indicated thereon.

3.10 Railroad Crossing

The location of any railroad crossing within the limits of construction will be identified on the key sheet as follows: DOT/AAR crossing number, railroad milepost, name of railroad, and the highway project station number.

3.11 Revisions

The lead key sheet (usually roadway) shall show a complete record of all plans revisions. The component (such as roadway, structures, signing and pavement marking), the sheet numbers involved, and the date when the sheet was revised shall be listed. The unique numbered symbol that corresponds to the Revision Number on the Revision Memo and modified sheets shall be listed here as well.

A newly sealed lead key sheet is required when any sheet is revised.

Revisions shall be shown on the lower left corner of the key sheet in the “Revisions” area. Revisions to strung project sheets shall be listed here, under the respective Financial Project ID.

A Key Sheet Revisions Block shall be shown on the right side of each component key sheet that shall contain a record of all revisions particular to that sheet. It shall list the revision date and a brief description of the revision.

If the changes to a key sheet only involve notes in the Revisions area, no entry is made in the Key Sheet Revisions Block at the lower right corner. The Key Sheet Revisions Block is only used to record changes other than revisions notes.

THIS PAGE INTENTIONALLY LEFT BLANK

COMPONENTS OF CONTRACT PLANS SET

- ROADWAY PLANS
- SIGNING AND PAVEMENT MARKING PLANS
- SIGNALIZATION PLANS
- INTELLIGENT TRANSPORTATION SYSTEMS PLANS
- LIGHTING PLANS
- LANDSCAPE PLANS
- ARCHITECTURAL PLANS
- STRUCTURE PLANS

A DETAILED INDEX APPEARS ON THE KEY SHEET OF EACH COMPONENT

EXAMPLE ONLY: CONTRACT PLANS SET MAY NOT CONTAIN ALL OF THE LISTED COMPONENTS/SHEETS.

**STATE OF FLORIDA
DEPARTMENT OF TRANSPORTATION**

CONTRACT PLANS

FINANCIAL PROJECT ID 000001-1-52-01
(FEDERAL FUNDS)
BAY COUNTY (46001)
STATE ROAD NO. 220

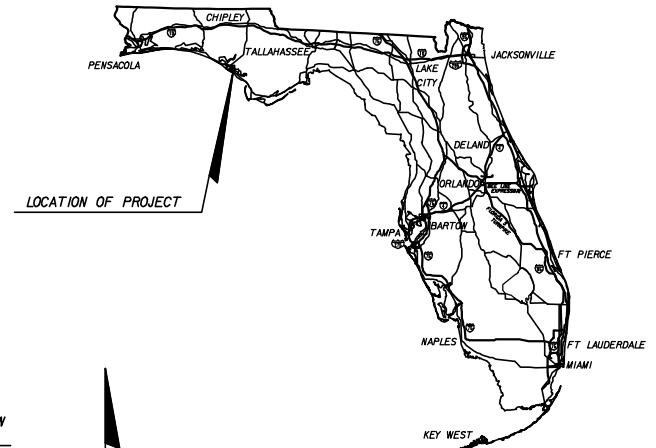

LOCATION OF PROJECT

INDEX OF ROADWAY PLANS

SHEET NO.	SHEET DESCRIPTION
1	KEY SHEET
2-2A	SUMMARY OF PAY ITEMS
3	DRAINAGE MAP
4-5	TYPICAL SECTIONS
6	TYPICAL SECTION DETAILS
7	SUMMARY OF QUANTITIES
8-14	BOX CULVERT DATA SHEETS
15-16	SUMMARY OF DRAINAGE STRUCTURES
17	PROJECT LAYOUT
18-22	ROADWAY PLAN-PROFILES
23-24	SPECIAL PROFILES
25	INTERSECTION LAYOUT/DETAIL
26-32	DRAINAGE STRUCTURES
33	LATERAL DITCH PLAN-PROFILES
34	LATERAL DITCH CROSS SECTIONS
35	SPECIAL DETAILS
36	ROADWAY SOIL SURVEY
37-47	CROSS SECTIONS
48	STORMWATER POLLUTION PREVENTION PLAN
49-52	TRAFFIC CONTROL PLANS
53-57	UTILITY ADJUSTMENTS
58-62	SELECTIVE CLEARING AND GRUBBING

GOVERNING STANDARDS AND SPECIFICATIONS:
FLORIDA DEPARTMENT OF TRANSPORTATION,
DESIGN STANDARDS DATED 2006,
AND STANDARD SPECIFICATIONS FOR ROAD AND
BRIDGE CONSTRUCTION DATED 2007,
AS AMENDED BY CONTRACT DOCUMENTS.

APPLICABLE DESIGN STANDARDS MODIFICATIONS: 1-1-07

For Design Standards Modifications click on
"Design Standards" at the following web site:
<http://www.dot.state.fl.us/rddesign/>

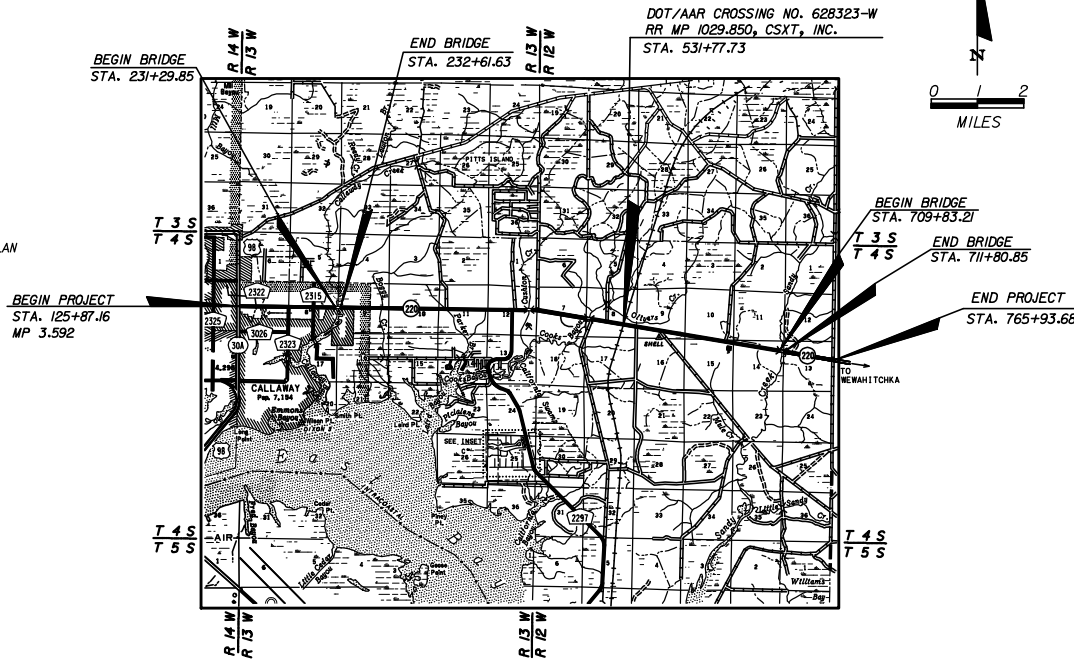

ROADWAY SHOP DRAWINGS TO BE SUBMITTED TO:

NAME(S) AND ADDRESS(ES) OF ENGINEER(S) RESPONSIBLE FOR REVIEW OF SHOP DRAWINGS, WHEN REQUIRED.

PLANS PREPARED BY:

NAME, ADDRESS, CONTRACT NUMBER, VENDOR NUMBER AND CERTIFICATE OF AUTHORIZATION NUMBER OF THE CONSULTANT FIRM WHEN THE PLANS ARE PREPARED BY A CONSULTANT.

NOTE: THIS PROJECT TO BE LET TO CONTRACT WITH FINANCIAL PROJECT ID 000002-1-52-02.

NOTE: THE SCALE OF THESE PLANS MAY HAVE CHANGED DUE TO REPRODUCTION.

EXHIBIT KS-1
Date: 1/1/07

- REVISIONS**
- FINANCIAL PROJECT ID 000001-1-52-01
 - ▲ Roadway Sheets 1, 6, 7 & 13 (Revised 01-10-07)
 - ▲ Signaling & Pavement Marking Sheets S-2 & S-3 (Revised 3-10-07)
 - ▲ Signalization Sheets T-1 & T-2 (Revised 3-10-07)
 - ▲ Roadway Sheets 14 & 33 (Revised 3-31-07)
 - ▲ Summary Of Pay Items (Revised 3-31-07)
 - FINANCIAL PROJECT ID 000002-1-52-02
 - ▲ Roadway Sheets 1, 8 & 10 (Revised 1-30-07)
 - ▲ Structure Sheets B-1 & C-1 thru C-10 (Revised 1-30-07)

LENGTH OF PROJECT		
	LINEAR FEET	MILES
ROADWAY	63,677.10	12.060
BRIDGES	329.42	0.062
NET LENGTH OF PROJ.	64,006.52	12.122
EXCEPTIONS		
GROSS LENGTH OF PROJ.	64,006.52	12.122

KEY SHEET REVISIONS	
DATE	DESCRIPTION
3-07	Revised sequence of contract plans.

ROADWAY PLANS ENGINEER OF RECORD: _____

P.E. NO. : _____

FISCAL YEAR	SHEET NO.

FDOT PROJECT MANAGER :

ELECTRONIC SIGNATURE NOTE WHEN SHEET IS ELECTRONICALLY SIGNED AND SEALED

Chapter 4

Summary of Pay Items

4.1	General	4-1
4.2	Summary of Pay Items Sheet.....	4-2

THIS PAGE LEFT BLANK INTENTIONALLY

Chapter 4

Summary of Pay Items

4.1 General

The summary of pay items sheet is generated from information provided by the Engineer of Record (EOR) and input into TRNS*PORT. In TRNS*PORT, there are differences in producing the Project Summary of Pay Items and the Proposal Summary of Pay Items. Use the appropriate report, based on the project's phase:

For early phase reviews (up to Phase III, or until the proposal has been created), the Project Summary of Pay Items Report must be used (No proposal, no proposal report). If multiple projects are anticipated to be let together, the designer should be sure to print each project's Summary of Pay Items for review. These reports may be printed on standard 8.5" by 11" paper. It is not necessary to put in CADD sheet format for phase review submittals.

For later phase reviews (Phase III or after the proposal has been created), the Proposal Summary of Pay Items Report should be used. After the designer submits the report from the designer interface menu, the output will be sent to the CADD ftp site in 5-10 minutes.

The output shall be transferred to a graphics design file and placed on a standard formatted plan sheet available in the FDOT Engineering/CADD Systems Software. The TRNS*PORT file must be established and kept current with the quantities listed in the plans. It is critical that any revisions to the TRNS*PORT file be transferred to update the graphics design file. The TRNS*PORT file is used to prepare the bid documents and must match the plans.

4.2 Summary of Pay Items Sheet

The summary of pay items sheet(s) show all items and quantities for all components (PES Categories) for the project, or projects, in a contract. CADD produced summary of pay items sheets are placed directly behind the lead key sheet and must include:

1. All the summaries for all component plans listed for the project.

These should be placed in the same order as the contract plans listed on the key sheet. They should be numbered consecutively. Alpha suffixes may be used for numbering to allow for the insertion of additional sheets without renumbering the Index of Sheets.

Note: Only the lead key sheet for the entire contract should contain reference to summary of pay items.

2. All projects let under this contract.

Projects that are let under the same contract should be combined in the same Proposal ID.

Summary of pay items notes may be included on this sheet if they do not fit on the summary of quantities sheet. For small projects, the summary of pay item sheet(s) may be combined with the summary of quantities sheet.

A summary of pay items sheet without quantities is required at the Phase II submittal, and a complete summary of pay items sheet with quantities is required at the Phase III and Phase IV submittals. Refer to **Chapter 2** for requirements of phase submittals.

For a list of standard pay item notes see **Chapter 7, Exhibit 7-1** of this volume.

Chapter 5

Drainage Map and Bridge Hydraulic Recommendation Sheet

5.1	Drainage Map.....	5-1
5.1.1	Plan Portion	5-2
5.1.2	Profile Portion	5-3
5.1.3	Flood Data Summary Box	5-4
5.1.4	Interchange Drainage Map	5-4
5.2	Bridge Hydraulic Recommendation Sheet	5-5
5.2.1	Required Information on BHRS.....	5-5
5.2.1.1	Plan View	5-6
5.2.1.2	Profile View	5-6
5.2.1.3	Location Map and Drainage Area	5-7
5.2.1.4	Existing Structures Data, Hydraulic Design Data and Hydraulic Recommendations	5-7
Exhibits		
Exhibit 5-1	Drainage Map Notes	5-9

THIS PAGE LEFT BLANK INTENTIONALLY

Chapter 5

Drainage Map and Bridge Hydraulic Recommendation Sheet

5.1 Drainage Map

When a drainage map is required (see FDOT *Drainage Manual, Topic No. 625-040-002*) it shall be prepared and included in the project file. Inclusion of a drainage map in the contract plans set is optional at the district's discretion.

Preformatted drainage map sheet cells are located in the FDOT Engineering/CADD Systems Software. The upper (grid) portion of each sheet is used for plotting the project profile, which is optional at the discretion of the district. The standard grid pattern for the profile portion of the sheet is five lines per inch, both in the horizontal and vertical. This will accommodate most scales. An optional grid with four lines per inch is available. This sheet may be used if approved by the district.

Topography of the project area shall be located in the remaining portion of the sheet. Aerial photography may be used to develop a drainage map but must not be used in the contract plans set.

The horizontal and vertical scales of the profile should be such that the stations and elevations can be read directly from the grid without the use of a scale. The horizontal scale must be the same for both the plan and profile views. Recommended scales for facility types are as follows:

<u>Type of Facility</u>	<u>Horizontal Scale</u>	<u>Vertical Scale</u>
Interstate Urban	1" = 500'	1" = 5'/1"=10'
Interstate & Other Rural	1"=1000'/2000'	1" = 10'/1"=20'
Municipal & Other	1"=200'/500'	1"= 5'/1" =10'

5.1.1 Plan Portion

The plan portion shall comply with the following requirements:

1. Stationing shall be shown every 500 feet for scales of 1" = 100'/200', every 1000 feet for a scale of 1" = 500' and every 5000 feet for scales of 1" = 1000'/2000'. For additional information see **Figure 10.1** in **Chapter 10** of this volume.

Station equations and exceptions shall be shown. Begin and end stations of project, construction, bridge and bridge culverts shall also be shown.

2. Existing physical land features affecting drainage, such as lakes, streams and swamps, shall be clearly labeled by name and direction of flow. Past high water elevations and date of occurrence, if available, and present water elevations along with the dates the readings were taken shall be shown.

Drainage divides and other information (such as pop-off elevations and spot elevations) shall be shown, where applicable, to indicate the overland flow of water. Drainage areas on maps shall be shown in acres.

Inserts shall be used to show areas that are of such magnitude that the boundaries cannot be plotted at the selected scale.

3. Existing road numbers and street names, drainage structures with type, size, flow line elevations, flow arrows and any other pertinent data shall be shown. Refer to the FDOT Engineering/CADD Systems Software and the **Design Standards, Index No. 002** for correct symbols for existing drainage facilities. In a situation of limited space, all data relating to existing drainage structures and pipes may be compiled in a table format and shown in either the plan or profile portion of the sheet. Should the space limitations be such that a table will not fit within the plan or profile view, a supplemental drainage data sheet is acceptable.
4. Proposed drainage structures, pipes, outfall structures and retention/detention pond locations, shall be shown. Structures and pipes shall be noted by structure number, and ponds by pond number. Arrows shall be shown to indicate direction of flow along proposed ditches.
5. Section, Township, Range and county lines shall be indicated for rural and urban projects when occurring within the project limits.
6. A north arrow and scale shall be shown, preferably in the upper right corner of the plan view.
7. If the drainage map is to be included in the contract plans set, include Note No. 1 (see **Exhibit 5-1**).

5.1.2 Profile Portion

The profile portion, if shown, shall comply with the following requirements:

1. The recommended vertical scale for rural and urban projects is 1" = 5' in level terrain and 1" = 10' in rolling terrain. A scale of 1" = 20' may sometimes be used for rural projects through rough terrain to avoid numerous profile breaks. The profile can be broken for rolling terrain in urban areas. However, a scale of 1" = 20' should never be used at locations of proposed storm sewer systems.
2. Elevation datum shall be shown at each side of the sheet. In cases where the profile block is insufficient and excess space is available on the plan portion of the sheet, the profile block may be expanded.
3. The profile of the existing natural ground shall be plotted and labeled and the existing elevation noted at each end.
4. The proposed profile grade line shall be plotted. Percent of grade need not be shown. The PC, PI, and PT of vertical curves shall be plotted using their respective standard symbols; however, no data (station, elevation, length of curve) needs be noted. Begin and end project, bridge and bridge culvert stations, station equations and exceptions shall be flagged. Profile grade line elevations shall be shown at begin and end project stations and at the beginning and end of each additional drainage sheet.
5. Proposed cross drains shall be plotted and identified by structure number. Do not show skew or pipe slope in plotting, but plot to elevation and location at point of crossing the construction centerline.
6. For projects with storm sewer systems, only the mainline structure and pipes shall be shown. Laterals need not be shown. Each structure shall be flagged with its appropriate structure number, and flow line elevations noted for the incoming and outgoing pipes.
7. All high water elevations affecting base clearance or roadway grades shall be shown.

5.1.3 Flood Data Summary Box

The flood data shall be shown on the drainage map, either in the plan or in the profile portion. If the drainage map is not included in the plans the flood data shall be shown on the summary of quantities sheet or on the first plan-profile sheet.

Design, base and overtopping or greatest flood discharge and stage values are required for all cross structures (culverts and bridges), regardless of size, under the following conditions:

1. All new cross structures
2. All cross structures that are being modified (extended, new end section, replaced, etc.)
3. All cross structures that have a history of flooding or other hydraulic problems, even if the structure is not to be modified; or
4. Cross structures that are not being modified but are being impacted by the modification of another cross structure within the same drainage basin.

A "disclaimer" and definitions are required to avoid misuse and possible responsibility for changes in the flood information values over which the FDOT has no control (see **Exhibit 5-1**). A preformatted summary box with disclaimer and definitions is located in the FDOT Engineering/CADD Systems Software.

The project drainage engineer shall provide the information required to complete the box.

5.1.4 Interchange Drainage Map

If projects include interchanges or rest areas, a drainage map on a 1" = 200' or 1" = 500' scale shall be included. The purpose of this detail is to show the small areas needed to calculate pipe sizes for the tabulation of drainage structures within these special areas. Should major drains pass through one of these areas, a cross reference note should indicate the proper sheet which reflects the drainage area for that through-structure.

5.2 Bridge Hydraulic Recommendation Sheet

When a Bridge Hydraulic Recommendation Sheet (BHRS) is required (see FDOT *Drainage Manual, Topic No. 625-040-002*), it shall be prepared on a preformatted sheet. The cell for this sheet is located in the FDOT Engineering/CADD Systems Software.

The inclusion of this sheet in the plans set is optional at the discretion of the district. When included in the plans, the BHRS shall be placed in the structures plans. If the BHRS is not included in the plans, sufficient details to show the location and extent of bottom and slope protection shall be contained in the plans.

Parallel (dual) bridges may be shown on one sheet, although a second sheet should be used, if necessary, to clearly convey the fit of the bridge to the stream bank. When two sheets are used, only the plan and profile information needs to be furnished on the second sheet.

A completed Bridge Hydraulic Recommendation Sheet is shown as *Exhibit BHD-1*.

5.2.1 Required Information on BHRS

The preformatted BHRS is divided into the four regions listed below. The required information for each region is described in the following sections.

1. Plan View
2. Profile View
3. Location Map and Drainage Area
4. Existing Structures, Hydraulic Design Data and Hydraulic Recommendations

5.2.1.1 Plan View

1. Stationing, scale, and north arrow.
2. Existing topography (i.e., Including existing bridge) and contours (i.e., show elevations). Sufficient detail shall be shown in the vicinity of the proposed bridge to depict how the structure will tie to natural ground.
3. Label the name of the water body (i.e., St. Johns River).
4. Arrows showing the direction of the flow.
5. Proposed bridge begin and end station.
6. Limits of riprap.

5.2.1.2 Profile View

1. Stationing and scale.
2. One cross section which most represents the section at the proposed crossing.
3. Road profile for the proposed structure (i.e., stationing and elevation).
4. Proposed bridge with low member, and pier locations (when practical).
5. Abutment locations (i.e., toe of slope).
6. Flood elevations. For non-tidal crossings, the Normal High Water (NHW) and Design Flood elevations shall be shown. For tidal crossings, the Mean High Water (MHW) and Design Flood Stage elevations shall be shown.
7. Present water elevation with month, day and year of survey.
8. Bridge Number. The bridge number should be for the new (proposed) structure.

5.2.1.3 Location Map and Drainage Area

1. A north arrow.
2. The range and township.
3. An arrow showing the project location.
4. A location map similar to that used on the key sheet for most projects. The map shall be of a scale so that the entire drainage area for the proposed structure is shown. (For projects with very large drainage areas, the map shall be of a scale that clearly shows the project location rather than a scale that shows the entire drainage area).

The drainage area boundaries shall be shown using a very heavy, broken line, with the area (in acres or square miles) shown within the boundary. The proposed structure location should be shown. Existing structures over the same water body and those structures that affect the hydraulics of the proposed structure should be located and numbered and corresponding existing structure information listed in the appropriate columns.

5.2.1.4 Existing Structures Data, Hydraulic Design Data and Hydraulic Recommendations

The *Cross Drain Handbook* provides guidance for filling out this section. Updated guidance will soon be found in the new *BHR Handbook* (which was not available at the time of this publication but should be online mid 2006).

THIS PAGE LEFT BLANK INTENTIONALLY

Exhibit 5-1 Drainage Map Notes

Below are standard notes which shall be placed on the drainage map as applicable.

1. (To be placed on the drainage map when it is to be included in the plans):
DO NOT USE THE INFORMATION ON THIS SHEET FOR CONSTRUCTION PURPOSES. This sheet is in the plans for documentation and to assist construction personnel with drainage concerns.
2. (To be placed under Flood Data Box):
Note: The hydraulic data is shown for informational purposes only, to indicate the flood discharges and water surface elevations which may be anticipated in any given year. This data was generated using highly variable factors determined by a study of the watershed. Many judgments and assumptions are required to establish these factors. The resultant hydraulic data is sensitive to changes, particularly of antecedent conditions, urbanization, channelization and land use. Users of this data are cautioned against the assumption of precision which can not be attained. Discharges are in cubic feet per second (cfs) and stages are in feet, NGVD, 1929 or NAVD 88, as appropriate.

THIS PAGE LEFT BLANK INTENTIONALLY

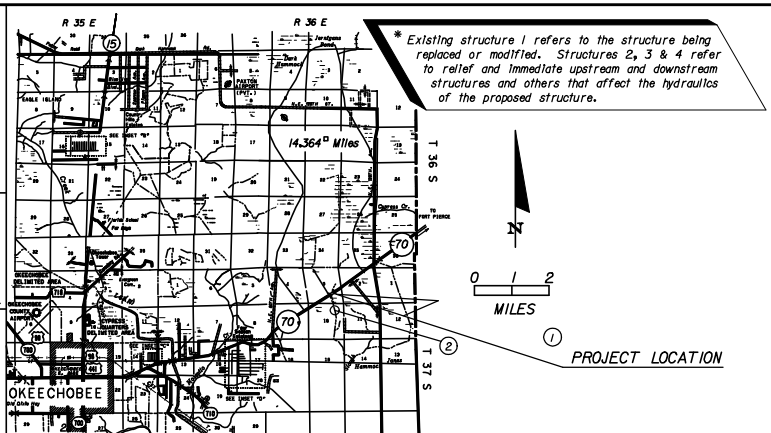
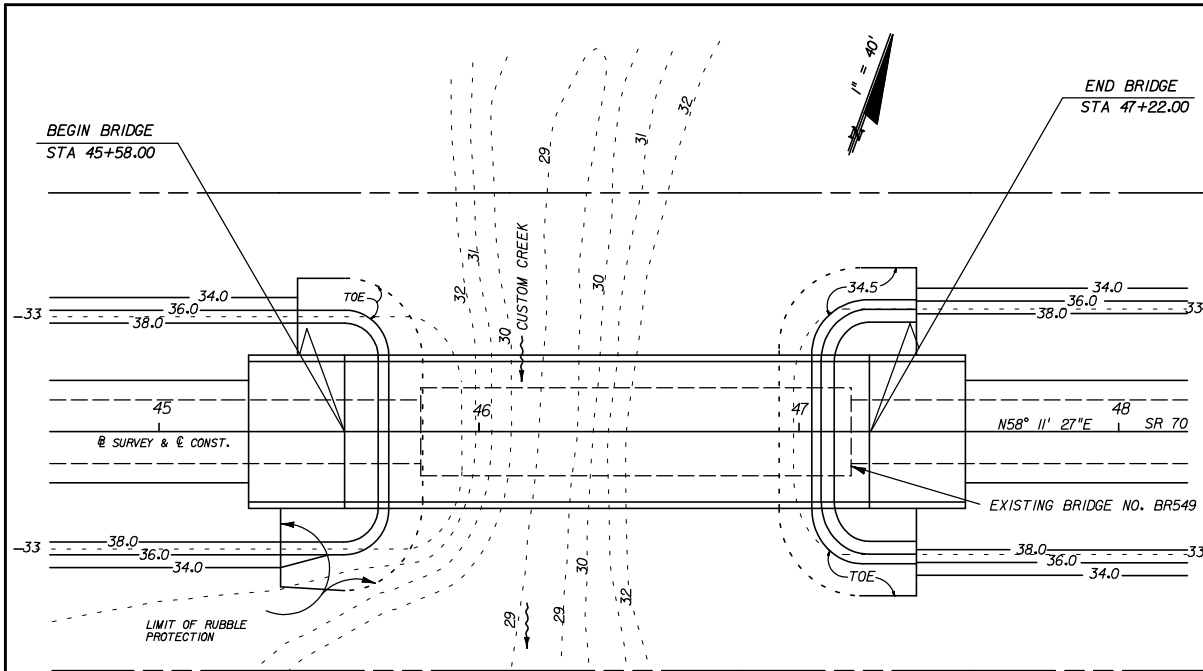

(REFERENCE)	* EXISTING STRUCTURES				PROPOSED STRUCTURE
	(1)	(2)	(3)	(4)	
FOUNDATION	Conc. Piles	Timber			Conc. Piles
OVERALL LENGTH	135	200			164 (from #4)
SPAN LENGTH	5 @ 27	20 @ 10			4 @ 41
TYPE CONSTRUCTION	Concrete	Timber			Concrete
AREA OF OPENING @ D.F.	1000	Unknown			1020
BRIDGE WIDTH	28'	Railroad (South)			44'
ELEV. LOW MEMBER	40.35	38.32			41.17

HYDRAULIC DESIGN DATA

NOTE:
The hydraulic data is shown for informational purposes only to indicate the flood discharges and water surface elevations which may be anticipated in any given year. The data was generated using highly variable factors determined by a study of the watershed. Many judgments and assumptions are required to establish these factors. The resultant hydraulic data is sensitive to changes, particularly antecedent conditions, urbanization, channelization and land use. Users of this data are cautioned against the assumption of precision which cannot be obtained.

This sheet has been included in the plans for documentation.
DO NOT USE FOR CONSTRUCTION PURPOSES.

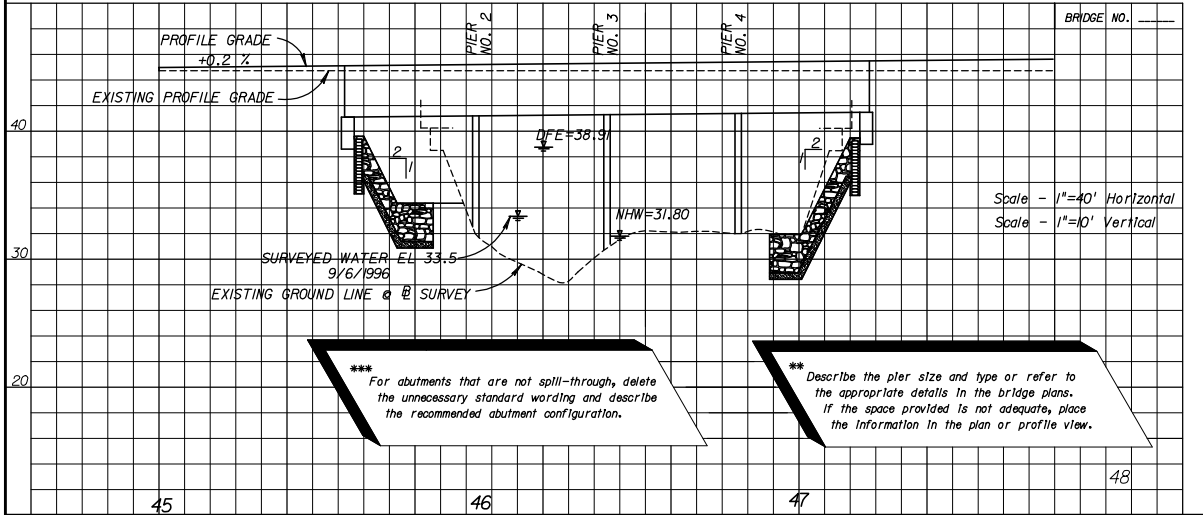

TERMS:
Design Flood: Utilized to assure a desired level of hydraulic performance.
Base Flood: Has a 1% chance of being exceeded in any given year (100 year frequency)
Overtopping Flood: Causes flow over the highway, over a watershed divide, or thru emergency relief structures.
Greatest Flood: The most severe that can be predicted where overtopping is not practicable.

WATER SURFACE ELEVATIONS:	N.H.W. (Non-Tidal)		M.H.W. (Tidal)	
	CONTROL (Non-Tidal)		M.L.W. (Tidal)	
	31.80			

FLOOD DATA:	MAX. EVENT OF RECORD		DESIGN FLOOD		BASE FLOOD		OVERTOPPING or GREATEST FLOOD
	STAGE ELEV. (ft)	58.2 (rem. #2)	38.91	39.27	39.57	43.30	
DISCHARGE (cfs)	unknown	3280	3950	413	0.2	500	
AVERAGE VELOCITY (ft/s)		3.22	3.58				
EXCEEDANCE PROB. (%)		2	1				
FREQUENCY (yr.)		50	100				

SCOUR PREDICTIONS FOR PROPOSED STRUCTURE DESCRIBED ABOVE:

NUMBERS	PIER INFORMATION		LONG TERM SCOUR ELEV.		TOTAL SCOUR ELEVATION	
	SIZE AND TYPE		WORST CASE < 100 yr. FREQ. (yr.)	100	WORST CASE < 500 yr. FREQ. (yr.)	500
2 & 3	24" Conc. Piles	N/A	18.4	16.4	16.4	16.4
4 (rem. #3)	24" Conc. Piles	N/A	27.6		25.6	25.6

HYDRAULIC RECOMMENDATIONS

- BEGIN BRIDGE STATION 45+58.00 END BRIDGE STATION 47+22.00 SKEW ABOVE 0°
- CLEARANCE PROVIDED: NAV: HORIZ. 39.0 VERT. 8.04 ABOVE EL. 33.14 DRIFT: HORIZ. 39.0 VERT. 2.26 ABOVE EL. 38.91
- MINIMUM CLEARANCE: NAV: HORIZ. 10.0 VERT. 6.0 ABOVE EL. 33.14 DRIFT: HORIZ. N/A VERT. 2.0 ABOVE EL. 38.91
- ABUTMENTS: BEGIN BRIDGE END BRIDGE

*** RUBBLE GRADE:		Bank and Shore	
SLOPE:	1:2		
BURIED OR NON-BURIED HORIZ. TOE:	Non-Buried		
TOE HORIZ. DISTANCE:	10		
LIMIT OF PROTECTION:	15' Lt., 20' Rt.		

5. DECK DRAINAGE: Spread is contained in shoulder. Runoff captured by inlets at begin bridge.

REMARKS: (1) Bridge lengthened to accommodate predicted channel migration to the west.
 (2) Based on mark provided by local resident of 43 years.
 (3) Due to predicted channel migration to the west and lack of meander cutoff, Pier No. 4 will not experience main channel scour depths.

EXHIBIT BHD-1
Date: 1/1/06

REVISIONS				STATE OF FLORIDA DEPARTMENT OF TRANSPORTATION			BRIDGE HYDRAULIC RECOMMENDATIONS	SHEET NO.
DATE	BY	DESCRIPTION	DATE	BY	DESCRIPTION			

Chapter 6

Typical Sections

6.1	General	6-1
6.2	Mandatory Information	6-3
Exhibits		
Exhibit 6-1	Standard Notes for Typical Section Sheets	6-5

THIS PAGE LEFT BLANK INTENTIONALLY

Chapter 6

Typical Sections

6.1 General

Typical sections are detailed cross section depictions of the highway's principal elements that are standard between certain station or milepost limits. These sections are the basis for construction details and information shown on the various plan sheets throughout the plans package.

Typical sections should show typical conditions only. Non-standard conditions that prevail for short distances only should not be shown. Existing elements that are to be incorporated into the highway's final section are depicted in conjunction with the proposed elements.

When more than one typical section is necessary for a project, the station limits of each section shall be shown below the typical section title. Typical section stationing shall cover the entire project. Transitions from one typical to another shall be included in the stationing of one or the other typical section. Sheets that feature more than one typical section should read from the top down, with the sections in the order in which they occur within the project.

The hierarchy for typical sections shall be as follows:

1. Project mainline
2. Ramps and service roads (for projects which include an interchange)
3. Crossing side roads
4. Minor side streets

Half sections and details which supplement or support various typical sections should be placed on the same sheet as the typical section to which they apply. In the event that this is not possible, additional sheets for details should be placed behind the typical section sheet(s).

Half sections are necessary when changes occur that affect several typical section elements such as number of lanes, border width, ditch/drainage features, clearing and grubbing, R/W width, etc.

Details and partial sections are necessary for the clarification of construction techniques or sequence, and to show alternates, such as the placement of shoulder gutter in high fill areas, changes in sidewalk location, etc. Judgment will be necessary in making decisions about when and where details should be shown.

The Department Engineering/CADD Systems Software contains a number of typical sections that can be used and adjusted to suit the conditions of a particular project. Usually typical sections are not created to scale, but the horizontal dimensions should be proportionate.

For illustrations of various typical sections, see ***Exhibits TYP-1*** thru ***TYP-16***.

6.2 Mandatory Information

Typical sections for all projects shall include the following data:

1. Design speed for each typical section
2. Traffic data (description, date and 2-way AADT)
 - a. Current Year
 - b. Estimated Opening Year
 - c. Estimated Design Year
 - d. K, D and T factors. Distinguish between T(peak hour) and T(24 hour)

For skid hazard projects, only the current year or estimated opening year for traffic data (AADT) is required to be noted.

All traffic data shown shall be consistent with the data used for pavement design.

3. Cross Slopes
 - a. Cross slopes of roadway pavement, shoulder surfaces, sidewalks and bridge decks shall be expressed as a decimal part of a foot vertical per foot horizontal. These cross slopes shall be rounded to two decimal places, i.e., 0.02, 0.06. (See **Volume I, Chapter 2**).
 - b. Median and outer slopes shall be shown by ratio, vertical to horizontal, i.e., 1:4, 1:2. (See **Volume I, Chapter 2**).
 - c. Either feathering details or notes (or both) shall be shown when resurfacing without milling in urban curb and gutter sections is specified or when milling depth is less than the overlay thickness.
 - d. When cross slope correction is necessary, special milling and layering details showing the method of correction shall be shown in the plans. (See **Exhibits TYP- 9** thru **9B**).
4. Profile grade point shall be flagged when applicable.
5. Pavement construction shall be described in a clear, precise manner by indicating the LBR requirement and the thickness of the subgrade stabilization, subbase or base, as well as thickness for structural course, friction course and shoulder pavement. Use 4 inches for both base extension on rural sections and for stabilization extension on curbed sections.

Pavement structure information shall be obtained from the approved pavement design and shall be described in the order of construction, i.e. starting with bottom layer and ending with friction course. Show pavement thickness descriptions for

leveling, overbuild, structural course and friction course in inches (and fractions of an inch). The thickness shown should be to the nearest $\frac{1}{2}$ " (except for FC-5 which is a standard $\frac{3}{4}$ ").

6. Limits of grassing.
7. Sidewalk location and width.
8. Curb and gutter location and type (show Type "E" or "F", not the dimension).

On new construction curb and gutter projects which include Asphalt Base, Type B-12.5 Only, the asphalt curb pad shall be indicated on the typical section and a detail provided. (See **Exhibit TYP – 6A**)

9. Limits of clearing and grubbing, where applicable.
10. R/W, where applicable.
11. Template dimensions:

For widening projects, the existing pavement width shall be shown as a +/- dimension, and the base widening width shall be shown with an asterisk. Note 3, of **Standard Notes for Typical Section Sheets (Exhibit 6-1)**, shall be shown as near to this noted asterisk as possible.

NOTE: For typical sections with varying dimensions, the dimensions shall be clearly indicated on the plan-profile sheets.

12. Standard notes for typical sections are shown on **Exhibit 6-1**.
13. Shoulder treatment shall be identified where applicable on RRR projects (See **Volume 1, Section 25.4.8**)

Exhibit 6-1 Standard Notes for Typical Section Sheets

Below are standard notes that shall be shown on typical section sheets as applicable.

1. For details and limits of selective clearing and grubbing see _____.
2. (Under paved shoulders):
At the contractor's option, this area may be constructed of base material at no additional compensation.
3. (On widening projects):
Actual width of base widening may vary due to actual existing pavement width. Contractor may elect to place uniform width base widening strip at no additional cost to the Department.

THIS PAGE LEFT BLANK INTENTIONALLY

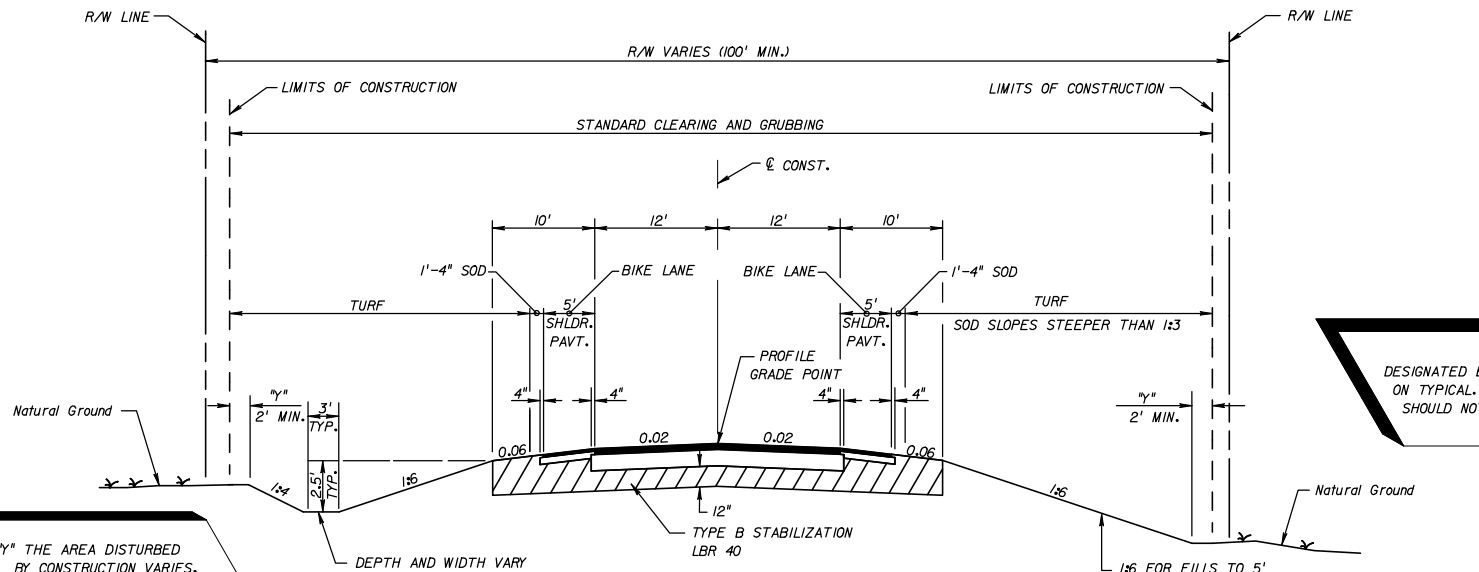

2-LANE (2-WAY)
 ARTERIAL/COLLECTOR
 NEW CONSTRUCTION
 RURAL
 WITH DESIGNATED OR
 UNDESIGNATED BIKE LANE
 DESIGN SPEED 55 MPH
 OR GREATER
 WITH PROJECTED
 20 YR. AADT OF 1500
 OR GREATER

DESIGNATED BIKE LANES SHALL BE LABELED
 ON TYPICAL. UNDESIGNATED BIKE LANES
 SHOULD NOT BE LABELED ON TYPICAL.

"y" THE AREA DISTURBED
 BY CONSTRUCTION VARIES.

DEPTH AND WIDTH VARY
 SEE CROSS SECTIONS

1:6 FOR FILLS TO 5'
 1:6 TO EDGE OF CLEAR ZONE & 1:4 FOR FILLS 5' TO 10'
 1:6 TO EDGE OF CLEAR ZONE & 1:3 FOR FILLS 10' TO 20'
 1:2 (WITH GUARDRAIL) FOR FILLS OVER 20'

TRAFFIC DATA

CURRENT YEAR = 1998 AADT = 6800
 ESTIMATED OPENING YEAR = 2000 AADT = 7600
 ESTIMATED DESIGN YEAR = 2020 AADT = 15000
 K = 6% D = 55% T = 2% (24 HOUR)
 DESIGN HOUR T = 1%
 DESIGN SPEED = 45 MPH

TRAFFIC DATA IS REQUIRED TO BE NOTED FOR
 CURRENT YEAR, OPENING YEAR AND DESIGN YEAR.
 POSTED SPEED (MPH) IS OPTIONAL.

FOR STANDARD TYPICAL SECTION NOTES
 REFER TO EXHIBIT 6-1, THIS CHAPTER.

**TYPICAL SECTION
 SR 10 (U.S. 90-A)
 STA. 10+00.00 TO STA. 267+34.89**

NEW CONSTRUCTION

OPTIONAL BASE GROUP 8 WITH
 TYPE SP STRUCTURAL COURSE (TRAFFIC C) (2")
 AND FRICTION COURSE FC-12.5 (TRAFFIC C) (1/2") (RUBBER)

SHOULDER PAVEMENT

OPTIONAL BASE GROUP 1 WITH
 FRICTION COURSE FC-12.5 (TRAFFIC C) (1/2") (RUBBER)

NOTE:
 HEIGHT OF FILL IS THE VERTICAL DISTANCE
 FROM THE EDGE OF THE OUTSIDE TRAVEL LANE
 TO TOE OF FRONT SLOPE.

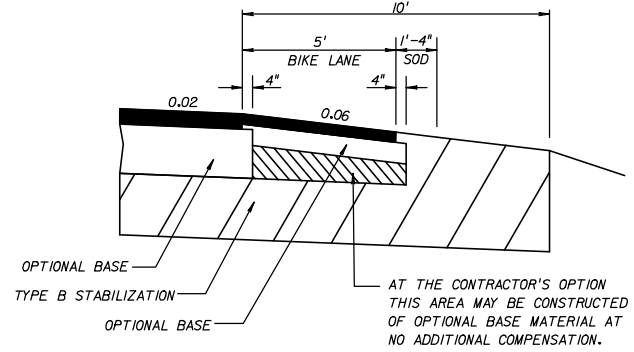

SHOULDER PAVEMENT DETAIL

AT THE CONTRACTOR'S OPTION
 THIS AREA MAY BE CONSTRUCTED
 OF OPTIONAL BASE MATERIAL AT
 NO ADDITIONAL COMPENSATION.

EXHIBIT TYP-1
 Date: 1/1/07

REVISIONS						STATE OF FLORIDA DEPARTMENT OF TRANSPORTATION			SHEET NO.
DATE	BY	DESCRIPTION	DATE	BY	DESCRIPTION	ROAD NO.	COUNTY	FINANCIAL PROJECT ID	

TYPICAL SECTION

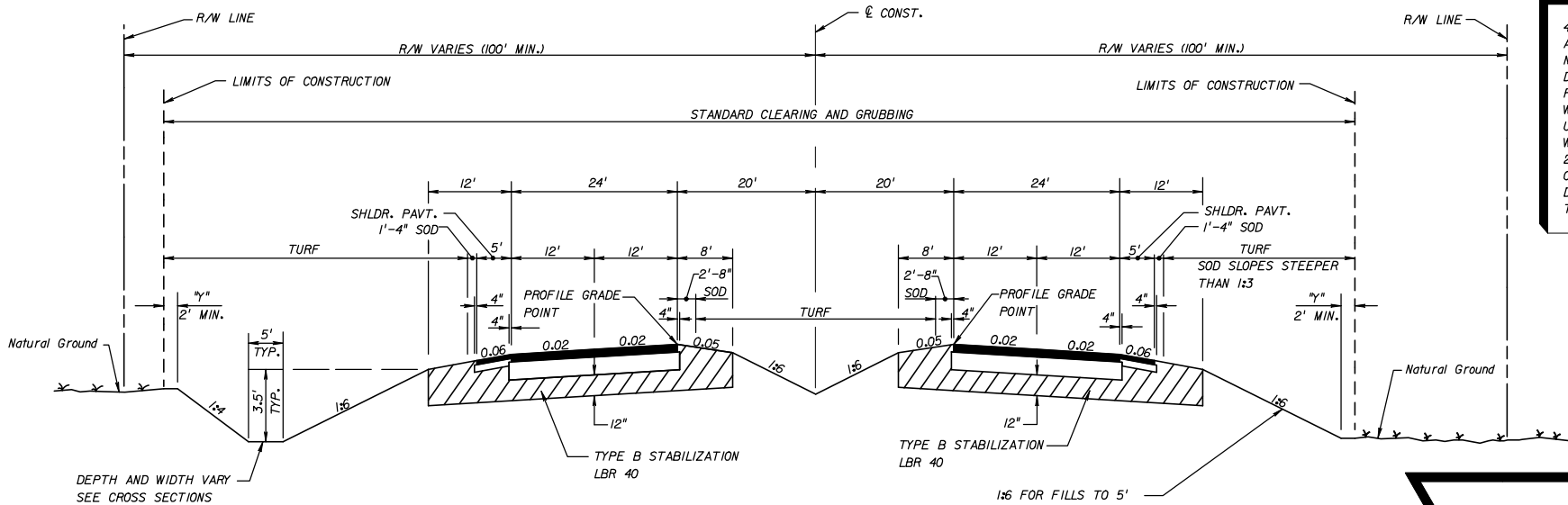

4 LANE
ARTERIAL/COLLECTOR
NEW CONSTRUCTION
DIVIDED
RURAL
WITH DESIGNATED OR
UNDESIGNATED BIKE LANE
WITH PROJECTED
20 YR. AADT OF 1500
OR GREATER
DESIGN SPEED GREATER
THAN 50 MPH

TRAFFIC DATA

CURRENT YEAR = 1998 AADT = 22300
 ESTIMATED OPENING YEAR = 2000 AADT = 23300
 ESTIMATED DESIGN YEAR = 2020 AADT = 51500
 K = 9% D = 56% T = 10% (24 HOUR)
 DESIGN HOUR T = 5%
 DESIGN SPEED = 70 MPH

**TYPICAL SECTION
SR 500
STA. 63+65.42 TO STA. 328+65.14**

NEW CONSTRUCTION

OPTIONAL BASE GROUP 9 WITH
 TYPE SP STRUCTURAL COURSE (TRAFFIC D) (2")
 TYPE SP STRUCTURAL COURSE (TRAFFIC D) (1 1/2") (PG 76-22)
 AND FRICTION COURSE FC-5 (3/4") (PG 76-22)

SHOULDER PAVEMENT

OPTIONAL BASE GROUP 1 WITH
 TYPE SP STRUCTURAL COURSE (TRAFFIC D) (1 1/2") (PG 76-22)
 AND FRICTION COURSE FC-5 (3/4") (PG 76-22)

1:6 FOR FILLS TO 5'
 1:6 TO EDGE OF CLEAR ZONE & 1:4 FOR FILLS 5' TO 10'
 1:6 TO EDGE OF CLEAR ZONE & 1:3 FOR FILLS 10' TO 20'
 1:2 (WITH GUARDRAIL) FILLS OVER 20'

NOTE:
 HEIGHT OF FILL IS THE VERTICAL DISTANCE
 FROM THE EDGE OF THE OUTSIDE TRAVEL LANE
 TO TOE OF FRONT SLOPE.

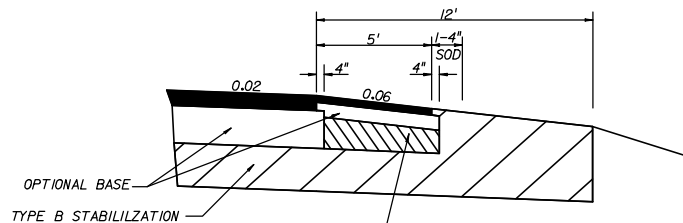

AT THE CONTRACTOR'S OPTION
 THIS AREA MAY BE CONSTRUCTED
 OF OPTIONAL BASE MATERIAL
 AT NO ADDITIONAL COMPENSATION

SHOULDER PAVEMENT DETAIL

EXHIBIT TYP-2
 Date: 1/1/07

DESIGNATED BIKE LANES SHALL BE LABELED
 ON TYPICAL. UNDESIGNATED BIKE LANES
 SHOULD NOT BE LABELED ON TYPICAL.

TRAFFIC DATA IS REQUIRED TO BE
 NOTED FOR CURRENT YEAR,
 OPENING YEAR, AND DESIGN YEAR.
 POSTED SPEED (MPH) IS OPTIONAL.

FOR STANDARD TYPICAL SECTION NOTES
 REFER TO EXHIBIT 6-1, THIS CHAPTER.

REVISIONS					
DATE	BY	DESCRIPTION	DATE	BY	DESCRIPTION

STATE OF FLORIDA DEPARTMENT OF TRANSPORTATION		
ROAD NO.	COUNTY	FINANCIAL PROJECT ID

TYPICAL SECTION	
SHEET NO.	

DESIGNATED BIKE LANES SHALL BE LABELED ON TYPICAL. UNDESIGNATED BIKE LANES SHOULD NOT BE LABELED ON TYPICAL.

5-LANE SECTIONS ARE TO INCLUDE SECTIONS OF RAISED OR RESTRICTIVE MEDIAN. SEE PPM TABLE 2.2.1.

5-LANE ARTERIAL/COLLECTOR NEW CONSTRUCTION UNDIVIDED URBAN WITH DESIGNATED OR UNDESIGNATED BIKE LANE MINIMUM RIGHT OF WAY DESIGN SPEED 40 MPH OR LESS WITH PROJECTED 20 YR. AADT OF 1500 OR GREATER

LIMITS OF CONSTRUCTION STANDARD CLEARING AND GRUBBING LIMITS OF CONSTRUCTION

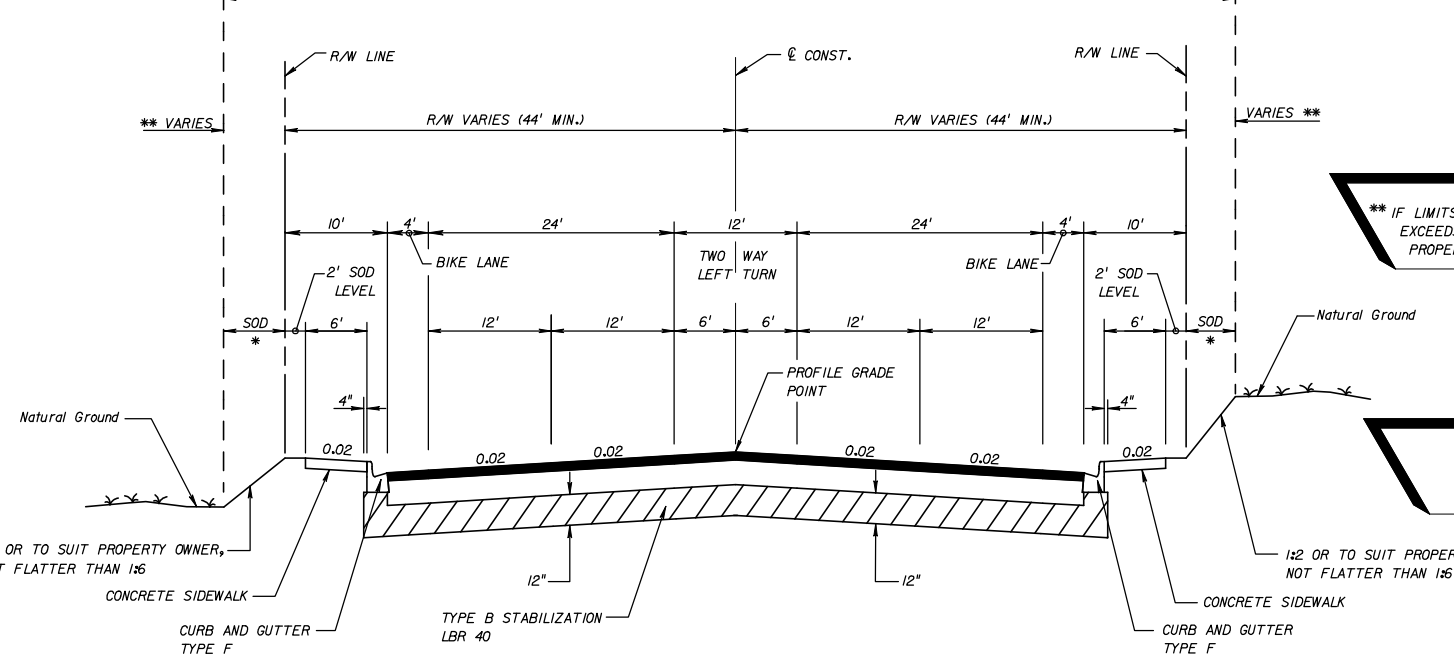

** IF LIMITS OF CONSTRUCTION EXCEEDS RIGHT OF WAY, A PROPERTY AGREEMENT IS REQUIRED.

* TURF, SOD OR TURF, SOD.

TYPICAL SECTION
SR 00 (DUVAL STREET)
STA. 252+12.00 TO STA. 323+19.42

NEW CONSTRUCTION

OPTIONAL BASE GROUP 8 WITH
TYPE SP STRUCTURAL COURSE (TRAFFIC B) (1 1/2")
AND FRICTION COURSE FC-12.5 (TRAFFIC B) (1 1/2") (RUBBER)

FOR STANDARD TYPICAL SECTION NOTES REFER TO EXHIBIT 6-1, THIS CHAPTER.

TRAFFIC DATA

CURRENT YEAR = 1998 AADT = 9900
ESTIMATED OPENING YEAR = 2000 AADT = 10600
ESTIMATED DESIGN YEAR = 2020 AADT = 14000
K = 6% D = 55% T = 2% (24 HOUR)
DESIGN HOUR T = 1%
DESIGN SPEED = 40 MPH

TRAFFIC DATA IS REQUIRED TO BE NOTED FOR CURRENT YEAR, OPENING YEAR AND DESIGN YEAR. POSTED SPEED (MPH) IS OPTIONAL.

EXHIBIT TYP-3
Date: 1/1/07

REVISIONS				STATE OF FLORIDA DEPARTMENT OF TRANSPORTATION			SHEET NO.
DATE	BY	DESCRIPTION	DATE	BY	DESCRIPTION		
						TYPICAL SECTION	

DESIGNATED BIKE LANES SHALL BE LABELED ON TYPICAL. UNDESIGNATED BIKE LANES SHOULD NOT BE LABELED ON TYPICAL.

4-LANE ARTERIAL NEW CONSTRUCTION DIVIDED URBAN WITH DESIGNATED OR UNDESIGNATED BIKE LANE DESIGN SPEED 45 MPH OR LESS

** IF LIMITS OF CONSTRUCTION EXCEED RIGHT OF WAY, A PROPERTY AGREEMENT IS REQUIRED.

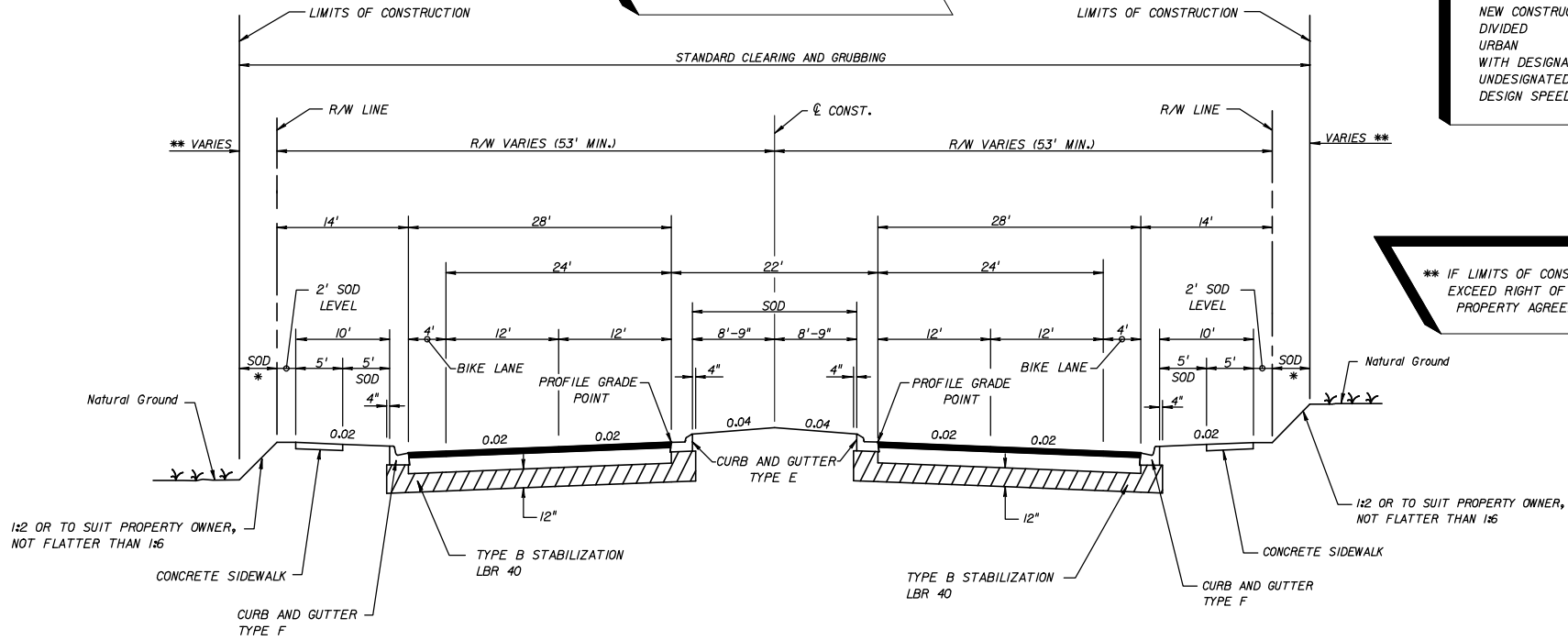

TYPICAL SECTION
SR 00 (WILSON STREET)
STA. 98+40.00 TO STA. 202+33.00

NEW CONSTRUCTION

OPTIONAL BASE GROUP 9 WITH
TYPE SP STRUCTURAL COURSE (TRAFFIC B) (1 1/2")
AND FRICTION COURSE FC-12.5 (TRAFFIC B) (1 1/2") (RUBBER)

TRAFFIC DATA

CURRENT YEAR = 1998 AADT = 22800
ESTIMATED OPENING YEAR = 2000 AADT = 25800
ESTIMATED DESIGN YEAR = 2020 AADT = 30600
K = 6% D = 55% T = 2% (24 HOUR)
DESIGN HOUR T = 1%
DESIGN SPEED = 45 MPH

TRAFFIC DATA IS REQUIRED TO BE NOTED FOR CURRENT YEAR, OPENING YEAR AND DESIGN YEAR. POSTED SPEED (MPH) IS OPTIONAL.

* TURF, SOD OR TURF, SOD.

FOR STANDARD TYPICAL SECTION NOTES REFER TO EXHIBIT 6-1, THIS CHAPTER.

EXHIBIT TYP-5
Date: 1/1/07

REVISIONS						STATE OF FLORIDA DEPARTMENT OF TRANSPORTATION			TYPICAL SECTION	SHEET NO.
DATE	BY	DESCRIPTION	DATE	BY	DESCRIPTION	ROAD NO.	COUNTY	FINANCIAL PROJECT ID		

DESIGNATED BIKE LANES SHALL BE LABELED ON TYPICAL. UNDESIGNATED BIKE LANES SHOULD NOT BE LABELED ON TYPICAL.

** IF LIMITS OF CONSTRUCTION EXCEED RIGHT OF WAY, A PROPERTY AGREEMENT IS REQUIRED.

6-LANE ARTERIAL NEW CONSTRUCTION DIVIDED URBAN WITH DESIGNATED OR UNDESIGNATED BIKE LANE DESIGN SPEED 45 MPH OR LESS

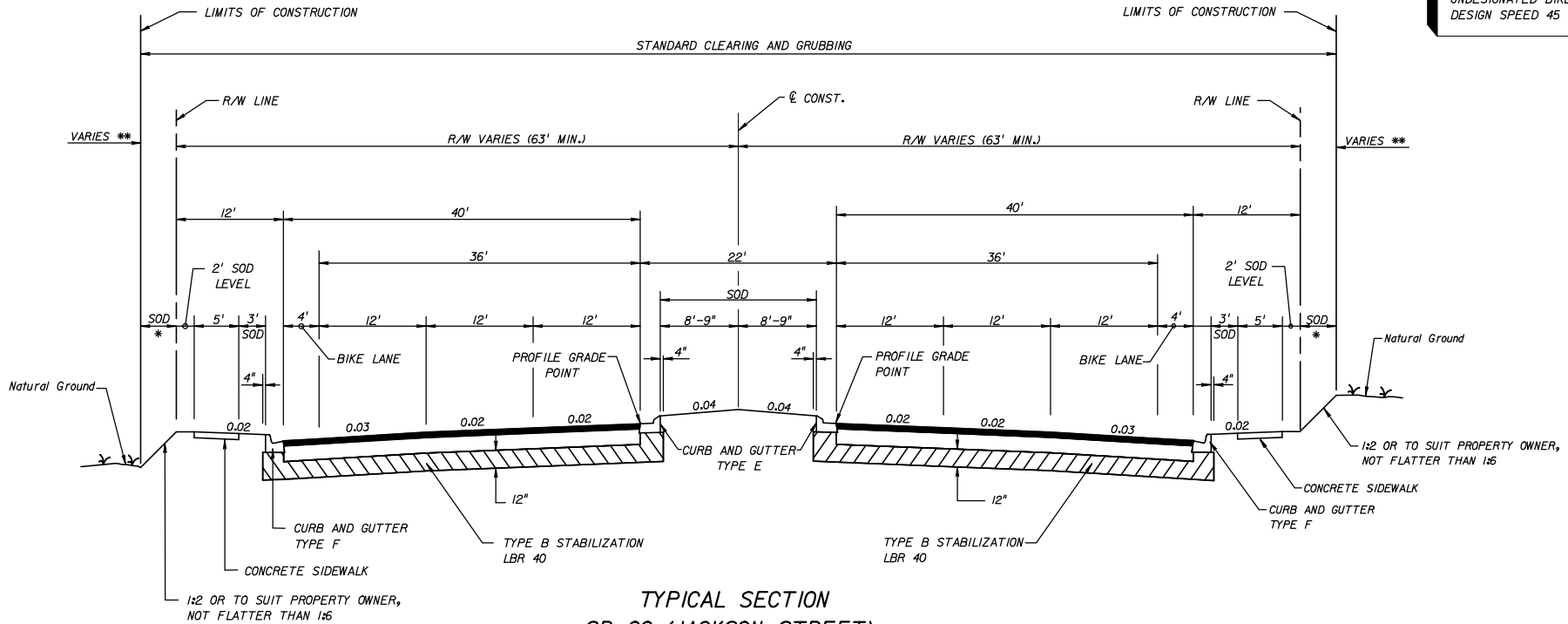

TYPICAL SECTION
SR 00 (JACKSON STREET)
STA. 101+21.00 TO STA. 221+44.00

NEW CONSTRUCTION

OPTIONAL BASE GROUP 9 WITH
TYPE SP STRUCTURAL COURSE (TRAFFIC C) (2")
AND FRICTION COURSE FC-12.5 (TRAFFIC C) (1/2") (RUBBER)

TRAFFIC DATA

CURRENT YEAR = 1998 AADT = 22800
ESTIMATED OPENING YEAR = 2000 AADT = 25800
ESTIMATED DESIGN YEAR = 2020 AADT = 30600
K = 6% D = 55% T = 2% (24 HOUR)
DESIGN HOUR T = 1%
DESIGN SPEED = 45 MPH

TRAFFIC DATA IS REQUIRED TO BE NOTED FOR CURRENT YEAR, OPENING YEAR AND DESIGN YEAR.

* TURF, SOD OR TURF, SOD.

FOR STANDARD TYPICAL SECTION NOTES REFER TO EXHIBIT 6-1, THIS CHAPTER.

EXHIBIT TYP-6
Date: 1/1/07

REVISIONS						STATE OF FLORIDA DEPARTMENT OF TRANSPORTATION			SHEET NO.
DATE	BY	DESCRIPTION	DATE	BY	DESCRIPTION	ROAD NO.	COUNTY	FINANCIAL PROJECT ID	

TYPICAL SECTION

DESIGNATED BIKE LANES SHALL BE LABELED ON TYPICAL. UNDESIGNATED BIKE LANES SHOULD NOT BE LABELED ON TYPICAL.

** IF LIMITS OF CONSTRUCTION EXCEED RIGHT OF WAY, A PROPERTY AGREEMENT IS REQUIRED.

6-LANE ARTERIAL NEW CONSTRUCTION DIVIDED URBAN WITH DESIGNATED OR UNDESIGNATED BIKE LANE DESIGN SPEED 45 MPH OR LESS

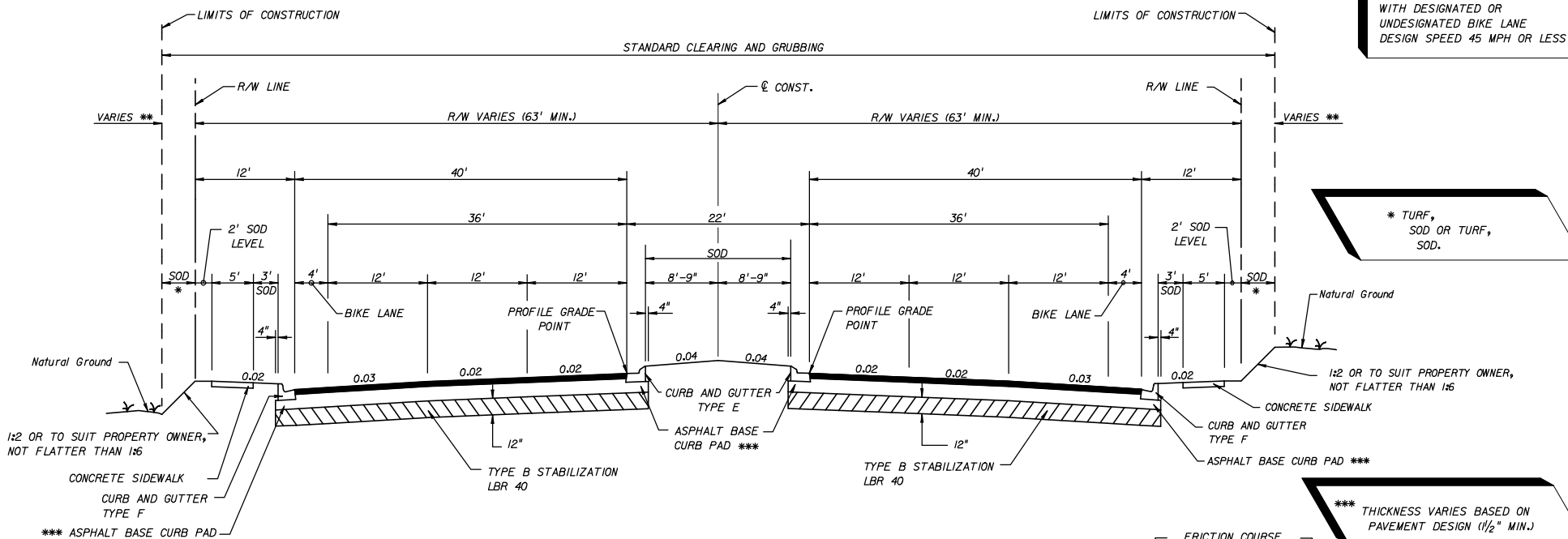

1:2 OR TO SUIT PROPERTY OWNER, NOT FLATTER THAN 1:6
CONCRETE SIDEWALK
CURB AND GUTTER TYPE F
*** ASPHALT BASE CURB PAD

1:2 OR TO SUIT PROPERTY OWNER, NOT FLATTER THAN 1:6
CONCRETE SIDEWALK
CURB AND GUTTER TYPE F
ASPHALT BASE CURB PAD ***

*** THICKNESS VARIES BASED ON PAVEMENT DESIGN (1/2" MIN.)

TRAFFIC DATA

CURRENT YEAR = 1998 AADT = 22800
ESTIMATED OPENING YEAR = 2000 AADT = 25800
ESTIMATED DESIGN YEAR = 2020 AADT = 30600
K = 6% D = 55% T = 2% (24 HOUR)
DESIGN HOUR T = 12
DESIGN SPEED = 45 MPH

**TYPICAL SECTION
SR 00 (JACKSON STREET)
STA. 101+21.00 TO STA. 221+44.00**

NEW CONSTRUCTION

OPTIONAL BASE GROUP 9 (TYPE B-12.5 ONLY), WITH TYPE SP STRUCTURAL COURSE (TRAFFIC C) (3") AND FRICTION COURSE FC-12.5 (TRAFFIC C) (1/2") (RUBBER)

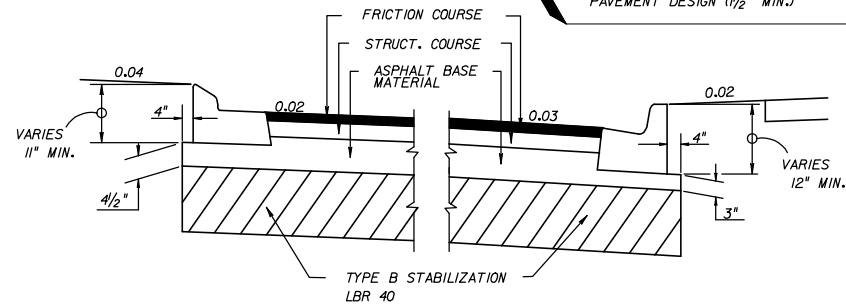

DETAIL OF ASPHALT BASE CURB PAD

FOR STANDARD TYPICAL SECTION NOTES REFER TO EXHIBIT 6-I, THIS CHAPTER

TRAFFIC DATA IS REQUIRED TO BE NOTED FOR CURRENT YEAR, OPENING YEAR AND DESIGN YEAR.

EXHIBIT TYP-6A
Date: 1/1/07

REVISIONS						STATE OF FLORIDA DEPARTMENT OF TRANSPORTATION			SHEET NO.
DATE	BY	DESCRIPTION	DATE	BY	DESCRIPTION	ROAD NO.	COUNTY	FINANCIAL PROJECT ID	

TYPICAL SECTION

DESIGNATED BIKE LANES SHALL BE LABELED ON TYPICAL, UNDESIGNATED BIKE LANES SHOULD NOT BE LABELED ON TYPICAL.

EXISTING 2-LANE (2-WAY) ARTERIAL/COLLECTOR MILLING AND RESURFACING NO CROSS SLOPE CORRECTION REQUIRED UNDIVIDED RURAL (WITH DESIGNATED OR UNDESIGNATED BIKE LANE EXISTING) WITH PROJECTED 20 YR. AADT OF 1500 OR GREATER

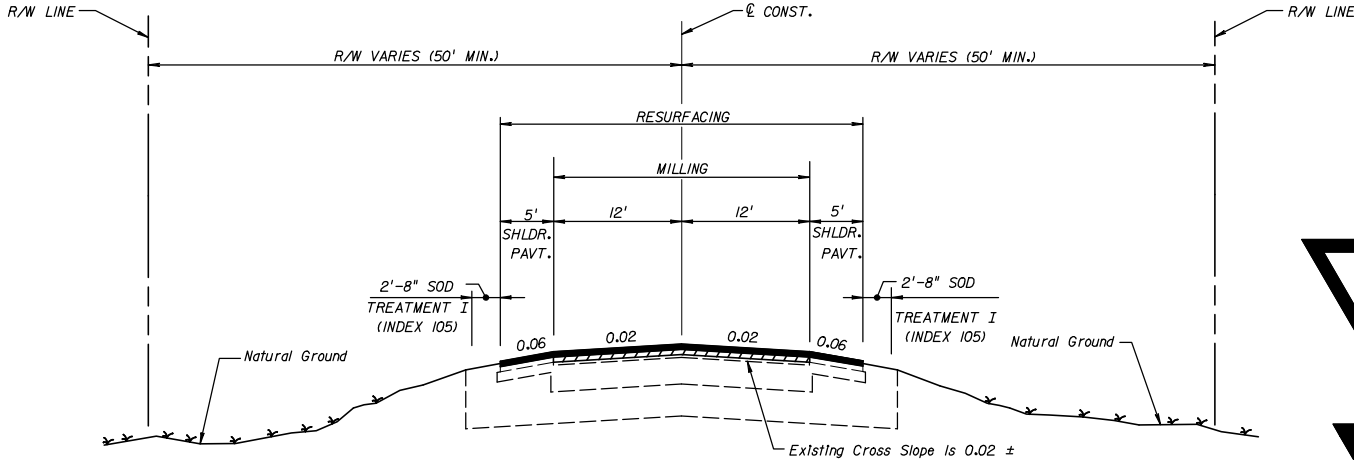

SOME PROJECTS MAY REQUIRE SHOULDER WORK. WHEN REQUIRED THIS SHOULD BE IDENTIFIED ON THE TYPICAL SECTION SHEET.

FOR STANDARD TYPICAL SECTION NOTES REFER TO EXHIBIT 6-1, THIS CHAPTER.

TRAFFIC DATA
STA. 10+53.00 TO STA. 130+77.00

CURRENT YEAR = 1998 AADT = 9670
ESTIMATED OPENING YEAR = 2000 AADT = 11900
ESTIMATED DESIGN YEAR = 2010 AADT = 20200
K = 10% D = 60% T = 7% (24 HOUR)
DESIGN HOUR T = 3%
DESIGN SPEED = 55 MPH

TYPICAL SECTION
SR 00

STA. 10+53.00 TO STA. 130+77.00
STA. 206+82.28 TO STA. 368+41.21

MILLING

MILL EXISTING ASPHALT PAVEMENT (2" AVG. DEPTH)

RESURFACING

TYPE SP STRUCTURAL COURSE (TRAFFIC B) (2")
AND FRICTION COURSE FC-9.5 (TRAFFIC B) (1") (RUBBER)

SHOULDER PAVEMENT RESURFACING

FRICTION COURSE FC-9.5 (TRAFFIC B) (1") (RUBBER)

STA. 206+82.28 TO 368+41.21

CURRENT YEAR = 1998 AADT = 6835
ESTIMATED OPENING YEAR = 2000 AADT = 8600
ESTIMATED DESIGN YEAR = 2010 AADT = 15100
K = 10% D = 65% T = 7% (24 HOUR)
DESIGN HOUR T = 3%
DESIGN SPEED = 55 MPH

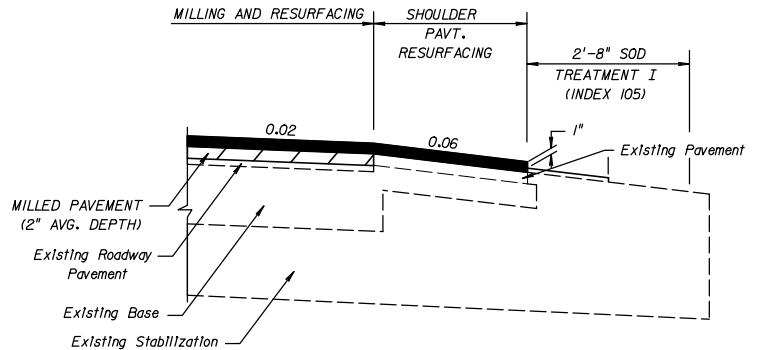

SHOULDER PAVEMENT DETAIL

TRAFFIC DATA IS REQUIRED TO BE NOTED FOR CURRENT YEAR, OPENING YEAR AND DESIGN YEAR.

EXHIBIT TYP-7
Date: 1/1/07

REVISIONS					
DATE	BY	DESCRIPTION	DATE	BY	DESCRIPTION

STATE OF FLORIDA DEPARTMENT OF TRANSPORTATION		
ROAD NO.	COUNTY	FINANCIAL PROJECT ID

TYPICAL SECTION

SHEET NO.

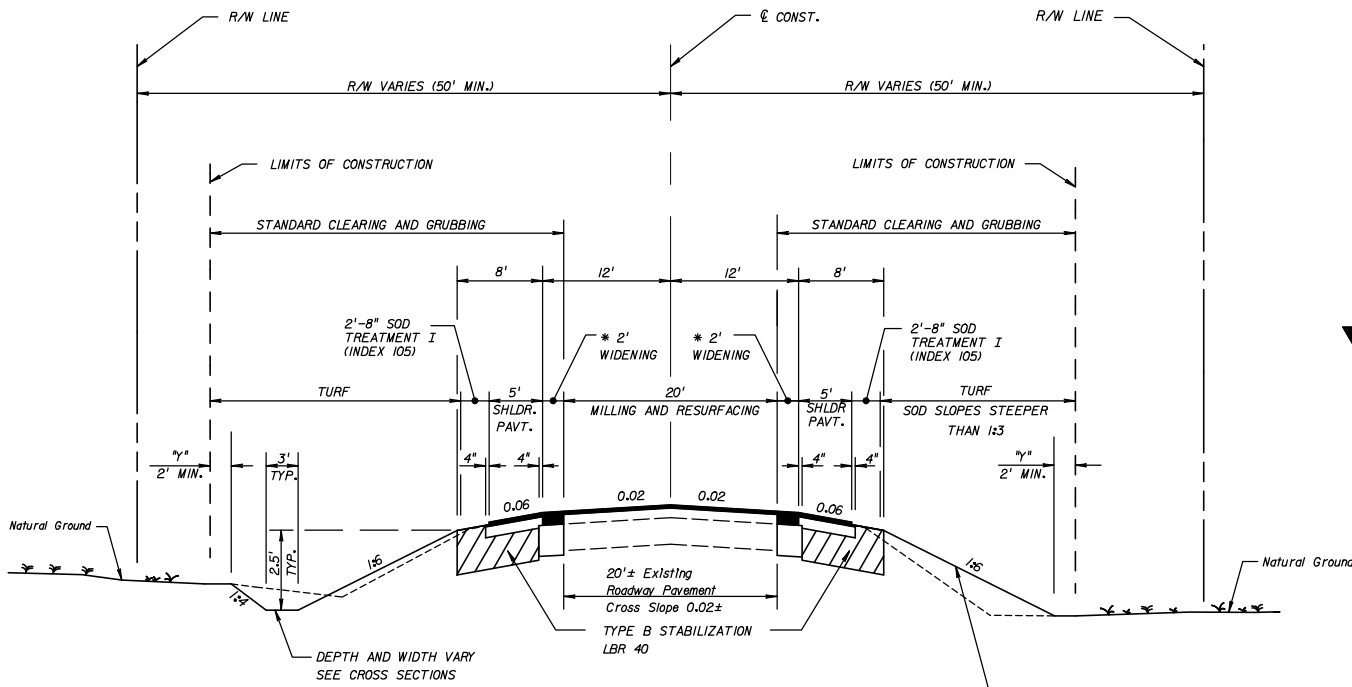

EXISTING
2-LANE (2-WAY)
ARTERIAL/COLLECTOR
WIDENING
MILLING AND RESURFACING
UNDIVIDED
RURAL
CONST. 5' SHOULDER
PAVEMENT OR BIKE LANE
WITH PROJECTED 20 YR.
AADT OF 1500 OR GREATER
DESIGN SPEED GREATER
THAN 50 MPH

DESIGNATED BIKE LANES SHALL BE LABELED
ON TYPICAL. UNDESIGNATED BIKE LANES
SHOULD NOT BE LABELED ON TYPICAL.

"n" THE AREA DISTURBED BY CONSTRUCTION VARIES.

NOTE:
HEIGHT OF FILL IS THE VERTICAL DISTANCE
FROM THE EDGE OF THE OUTSIDE TRAVEL LANE
TO TOE OF FRONT SLOPE.

FOR STANDARD TYPICAL SECTION NOTES
REFER TO EXHIBIT 6-1, THIS CHAPTER.

* SEE SHEET 2 OF 2 FOR WIDENING
AND SHOULDER PAVEMENT DETAIL

EXHIBIT TYP-8
Date: 1/1/07
SHEET 1 OF 2

TRAFFIC DATA
STA. 20+25.00 TO STA. 48+16.56

CURRENT YEAR = 1998 AADT = 8700
ESTIMATED OPENING YEAR = 2000 AADT = 9200
ESTIMATED DESIGN YEAR = 2020 AADT = 23600
K = 10% D = 56% T = 5% (24 HOUR)
DESIGN HOUR T = 3%
DESIGN SPEED = 55 MPH

STA. 57+82.78 TO STA. 93+41.21

CURRENT YEAR = 1998 AADT = 6835
ESTIMATED OPENING YEAR = 2000 AADT = 8600
ESTIMATED DESIGN YEAR = 2020 AADT = 17200
K = 10% D = 65% T = 7% (24 HOUR)
DESIGN HOUR T = 3%
DESIGN SPEED = 55 MPH

TRAFFIC DATA IS REQUIRED TO BE NOTED FOR
CURRENT YEAR, OPENING YEAR AND DESIGN YEAR.

TYPICAL SECTION
SR 000
STA. 20+25.00 TO STA. 48+16.56
STA. 57+82.78 TO STA. 93+41.21

- MILLING**
MILL EXISTING ASPHALT PAVEMENT (2" AVG. DEPTH)
- RESURFACING**
TYPE SP STRUCTURAL COURSE (TRAFFIC C) (1 1/2")
AND FRICTION COURSE FC-12.5 (TRAFFIC C) (1 1/2") (RUBBER)
- WIDENING**
OPTIONAL BASE GROUP II WITH
TYPE SP STRUCTURAL COURSE (TRAFFIC C) (3")
AND FRICTION COURSE FC-12.5 (TRAFFIC C) (1 1/2") (RUBBER)

1:6 FOR FILLS TO 5'
1:6 TO EDGE OF CLEAR ZONE & 1:4 FOR FILLS 5' TO 10'
1:6 TO EDGE OF CLEAR ZONE & 1:3 FOR FILLS 10' TO 20'
1:2 (WITH GUARDRAIL FILLS OVER 20')

REVISIONS					
DATE	BY	DESCRIPTION	DATE	BY	DESCRIPTION

STATE OF FLORIDA DEPARTMENT OF TRANSPORTATION		
ROAD NO.	COUNTY	FINANCIAL PROJECT ID

TYPICAL SECTION	SHEET NO.

DESIGNATED BIKE LANES SHALL BE LABELED ON TYPICAL. UNDESIGNATED BIKE LANES SHOULD NOT BE LABELED ON TYPICAL.

THE NEED FOR STABILIZATION IN THE SHOULDER AREA ON RRR PROJECTS IS SITE SPECIFIC AND NOT ALWAYS REQUIRED. THE USE OF STABILIZING IN NARROW TRENCH WIDENING STRIPS IS NOT RECOMMENDED GENERALLY. SEE THE FLEXIBLE PAVEMENT DESIGN MANUAL FOR FURTHER CRITERIA.

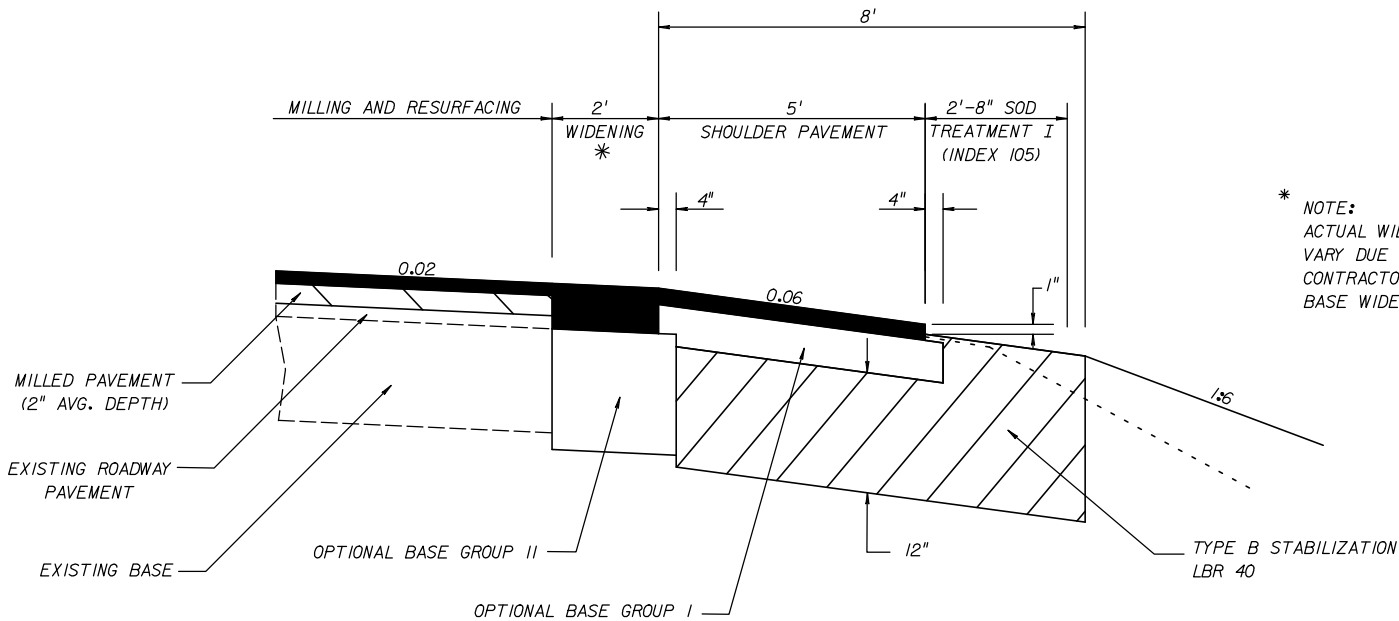

* NOTE:
ACTUAL WIDTH OF BASE WIDENING MAY VARY DUE TO ACTUAL PAVEMENT WIDTH. CONTRACTOR MAY ELECT TO PLACE UNIFORM BASE WIDENING AT NO ADDITIONAL COST.

WIDENING &
SHOULDER PAVEMENT DETAIL

WIDENING

OPTIONAL BASE GROUP II WITH
TYPE SP STRUCTURAL COURSE (TRAFFIC C) (3")
FRICTION COURSE FC-12.5 (TRAFFIC C) (1/2") (RUBBER)

SHOULDER PAVEMENT

OPTIONAL BASE GROUP I WITH
FRICTION COURSE FC-12.5 (TRAFFIC C) (1/2") (RUBBER)

FOR STANDARD TYPICAL SECTION NOTES
REFER TO EXHIBIT 6-1, THIS CHAPTER

EXHIBIT TYP-8A
Date: 1/1/07

REVISIONS						STATE OF FLORIDA DEPARTMENT OF TRANSPORTATION			TYPICAL SECTION	SHEET NO.
DATE	BY	DESCRIPTION	DATE	BY	DESCRIPTION	ROAD NO.	COUNTY	FINANCIAL PROJECT ID		

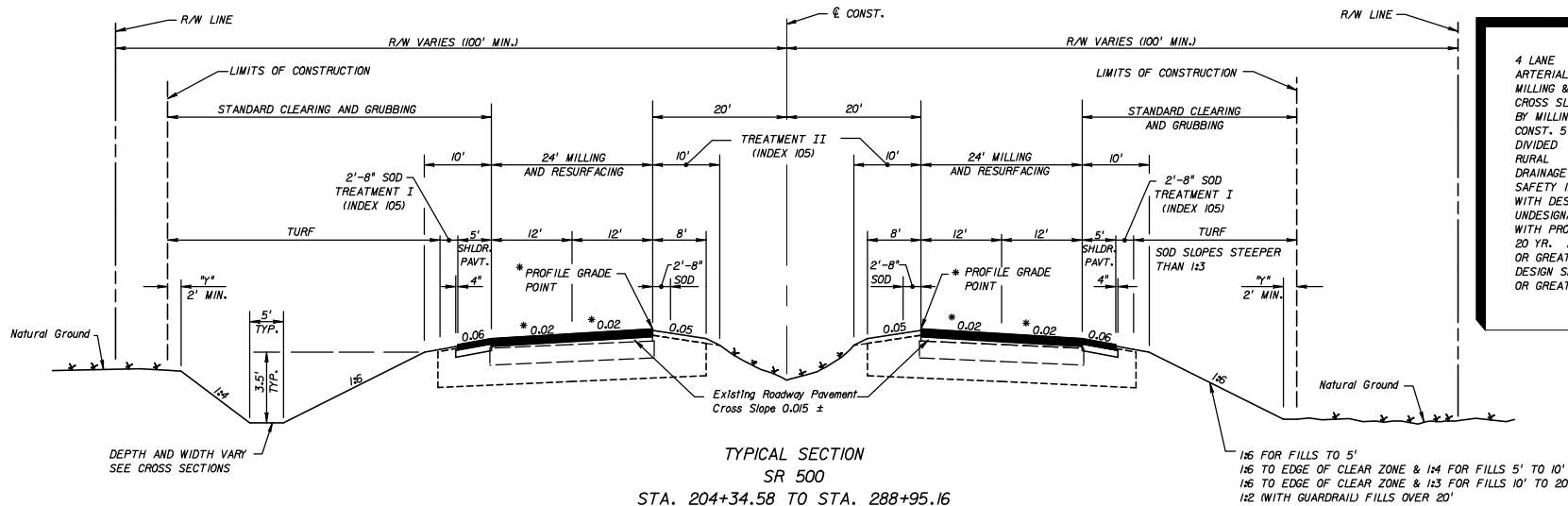

4 LANE
ARTERIAL/COLLECTOR
MILLING & RESURFACING
CROSS SLOPE CORRECTION
BY MILLING OR OVERBUILD
CONST. 5' SHLDR. PAV'T
DIVIDED
RURAL
DRAINAGE IMPROVEMENTS
SAFETY IMPROVEMENTS
WITH DESIGNATED OR
UNDESIGNATED BIKE LANE
WITH PROJECTED
20 YR. AADT OF 1500
OR GREATER
DESIGN SPEED 45 MPH
OR GREATER

DESIGNATED BIKE LANES SHALL BE LABELED ON TYPICAL. UNDESIGNATED BIKE LANES SHOULD NOT BE LABELED ON TYPICAL.

TRAFFIC DATA

CURRENT YEAR = 1998 AADT = 18100
ESTIMATED OPENING YEAR = 2000 AADT = 21000
ESTIMATED DESIGN YEAR = 2012 AADT = 30900
K = 11% D = 58% T = 22% (24 HOUR)
DESIGN HOUR T = 11%
DESIGN SPEED = 60 MPH
POSTED SPEED = 55 MPH

TRAFFIC DATA IS REQUIRED TO BE NOTED FOR CURRENT YEAR, OPENING YEAR, AND DESIGN YEAR. POSTED SPEED (MPH) IS OPTIONAL.

* WHEN CROSS SLOPE CORRECTION IS NECESSARY SPECIAL MILLING, OVERBUILD AND LAYERING DETAILS MUST BE PROVIDED TO SUPPLEMENT TYPICAL SECTION. THE NEED FOR AND LOCATION OF PROFILE GRADE POINTS WILL DEPEND ON SITE SPECIFIC CONDITIONS.

MILLING
MILL EXISTING ASPHALT PAVEMENT (1/2" AVG. DEPTH)

RESURFACING
TYPE SP STRUCTURAL COURSE (TRAFFIC D) (1/2")
TYPE SP STRUCTURAL COURSE (TRAFFIC D) (1/2") (PG 76-22)
AND FRICTION COURSE FC-5 (3/4") (PG 76-22)

SHOULDER PAVEMENT
OPTIONAL BASE GROUP 1 WITH
TYPE SP STRUCTURAL COURSE (TRAFFIC D) (1/2") (PG 76-22)
AND FRICTION COURSE FC-5 (3/4") (PG 76-22)

STA. 316+53.67 TO STA. 527+82.00

MILLING
MILL EXISTING ASPHALT PAVEMENT (1/2" AVG. DEPTH)

OVERBUILD
TYPE SP OVERBUILD (TRAFFIC D) THICKNESS VARIES (1" TO 1/2")

RESURFACING
TYPE SP STRUCTURAL COURSE (TRAFFIC D) (1/2")
TYPE SP STRUCTURAL COURSE (TRAFFIC D) (1/2") (PG 76-22)
AND FRICTION COURSE FC-5 (3/4") (PG 76-22)

SHOULDER PAVEMENT
OPTIONAL BASE GROUP 1 WITH
TYPE SP STRUCTURAL COURSE (TRAFFIC D) (1/2") (PG 76-22)
AND FRICTION COURSE FC-5 (3/4") (PG 76-22)

NOTE:
HEIGHT OF FILL IS THE VERTICAL DISTANCE FROM THE EDGE OF THE OUTSIDE TRAVEL LANE TO TOE OF FRONT SLOPE.

* THE AREA DISTURBED BY CONSTRUCTION VARIES.

FOR STANDARD TYPICAL SECTION NOTES REFER TO EXHIBIT 6-1, THIS CHAPTER.

FOR MILLING AND RESURFACING DETAILS SEE TYPICAL SECTION DETAILS SHEET 2 AND 3

EXHIBIT TYP-9
Date: 1/1/07

SHEET 1 OF 3

REVISIONS						STATE OF FLORIDA DEPARTMENT OF TRANSPORTATION			TYPICAL SECTION	SHEET NO.
DATE	BY	DESCRIPTION	DATE	BY	DESCRIPTION	ROAD NO.	COUNTY	FINANCIAL PROJECT ID		

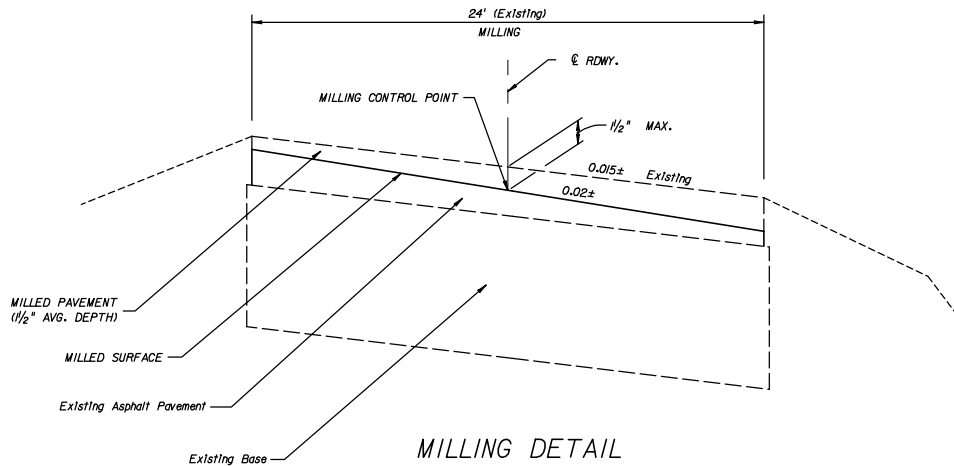

WHEN CROSS SLOPE CORRECTION IS NECESSARY SPECIAL MILLING AND LAYERING DETAILS MUST BE PROVIDED TO SUPPLEMENT TYPICAL SECTION. THE NEED FOR AND LOCATION OF PROFILE GRADE POINTS WILL DEPEND ON SITE SPECIFIC CONDITIONS.

EXAMPLE OF CROSS SLOPE CORRECTION BY MILLING.

FOR STANDARD TYPICAL SECTION NOTES REFER TO EXHIBIT 6-1, THIS CHAPTER.

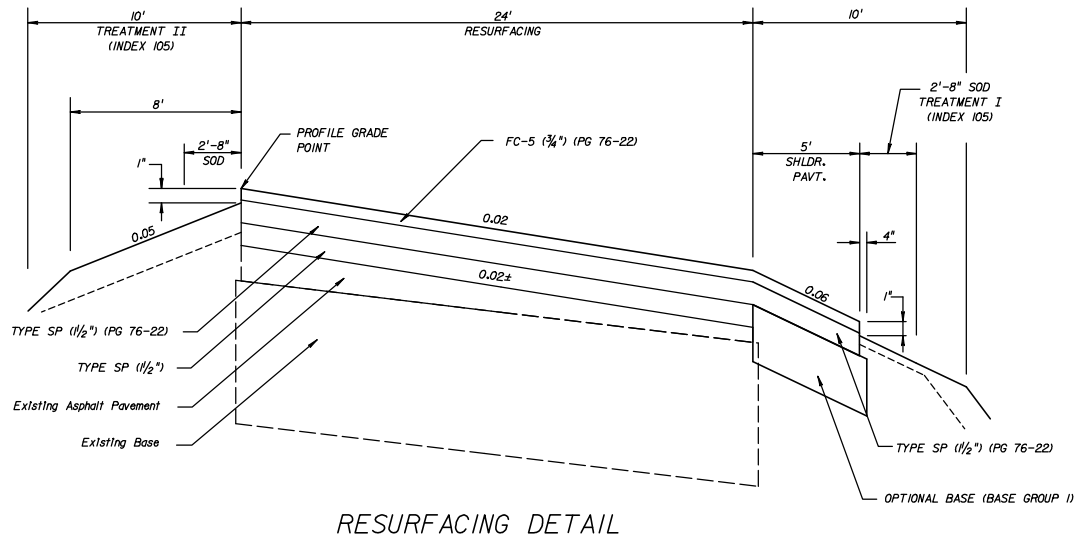

STA. 204+34.58 TO STA. 288+95.16

EXHIBIT TYP-9A
Date: 1/1/07

SHEET 2 OF 3

REVISIONS						STATE OF FLORIDA DEPARTMENT OF TRANSPORTATION			TYPICAL SECTION DETAILS	SHEET NO.
DATE	BY	DESCRIPTION	DATE	BY	DESCRIPTION	ROAD NO.	COUNTY	FINANCIAL PROJECT ID		

#USERS #DATES #TIMES #FILES

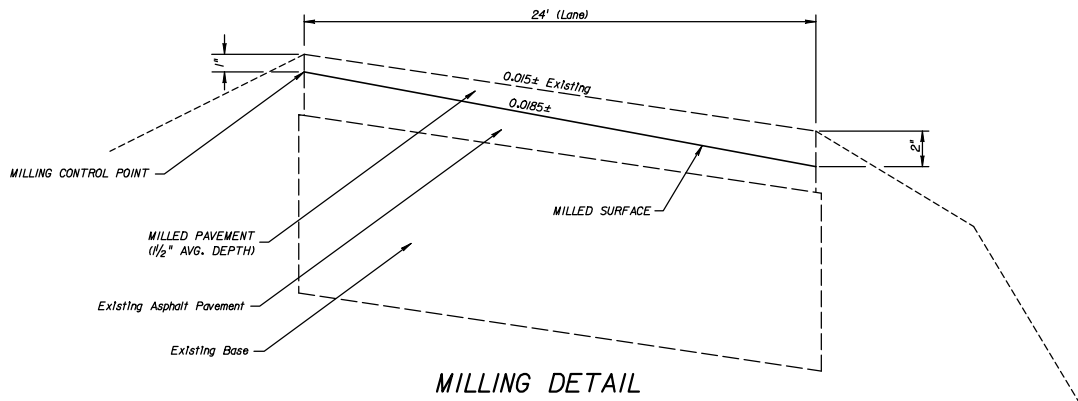

MILLING DETAIL

WHEN CROSS SLOPE CORRECTION IS NECESSARY SPECIAL MILLING, OVERBUILD AND LAYERING DETAILS MUST BE PROVIDED TO SUPPLEMENT TYPICAL SECTION. THE NEED FOR AND LOCATION OF PROFILE GRADES POINTS WILL DEPEND ON SITE SPECIFIC CONDITIONS.

EXAMPLE OF CROSS SLOPE CORRECTION BY MILLING AND OVERBUILD.

FOR STANDARD TYPICAL SECTION NOTES REFER TO EXHIBIT 6-1, THIS CHAPTER.

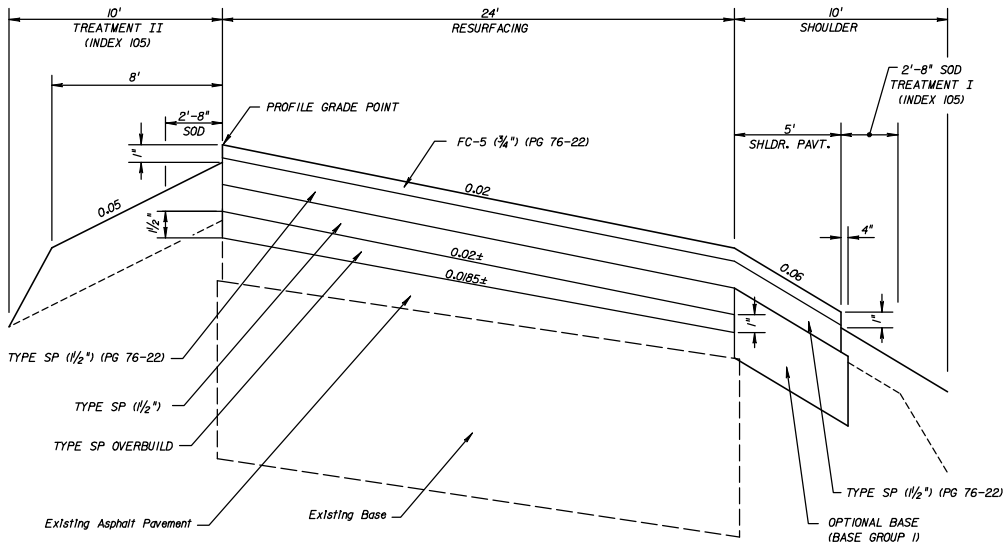

OVERBUILD AND RESURFACING DETAIL

SUGGESTED CONSTRUCTION SEQUENCES SHOWN. OTHER SEQUENCES THAT MEET SPECIFICATIONS, THICKNESS AND CROSS SLOPE REQUIREMENTS MAY BE CONSIDERED BY THE ENGINEER.

STA. 316+53.67 TO STA. 527+82.00

EXHIBIT TYP-9B
Date: 1/1/07

SHEET 3 OF 3

REVISIONS						STATE OF FLORIDA DEPARTMENT OF TRANSPORTATION			TYPICAL SECTION DETAILS	SHEET NO.
DATE	BY	DESCRIPTION	DATE	BY	DESCRIPTION	ROAD NO.	COUNTY	FINANCIAL PROJECT ID		

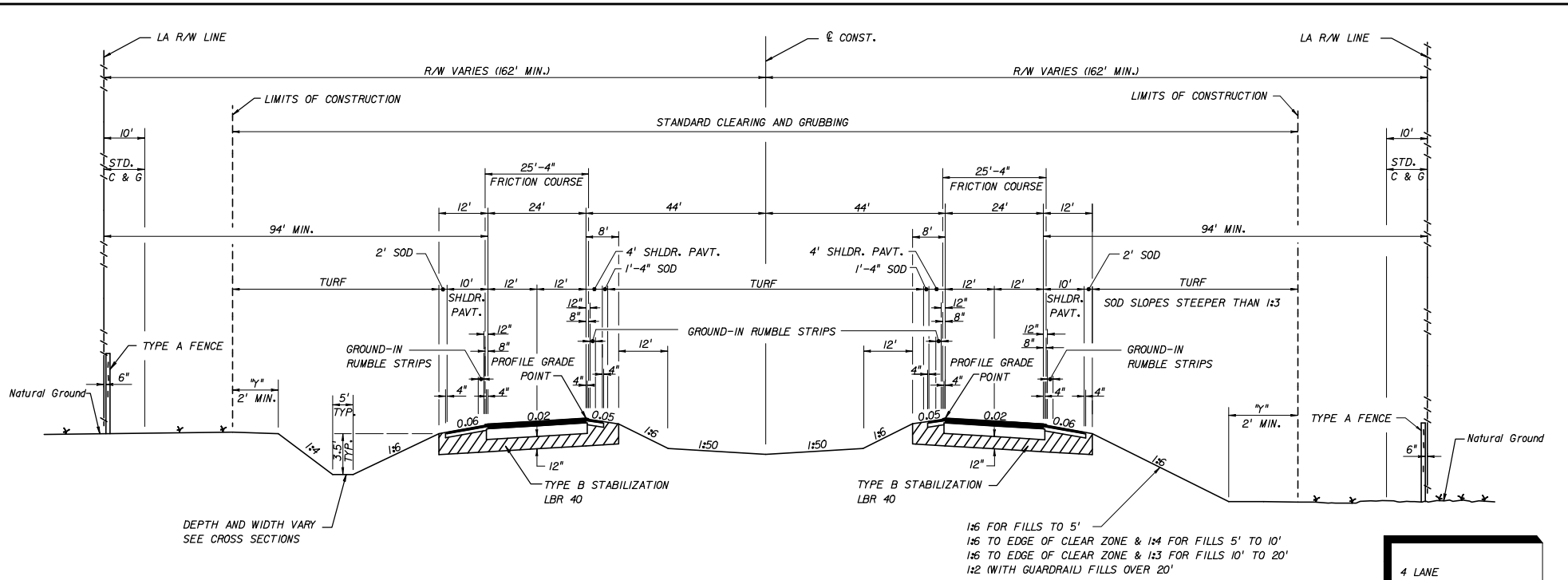

TRAFFIC DATA

CURRENT YEAR = 1998 AADT = 22300
 ESTIMATED OPENING YEAR = 2000 AADT = 23300
 ESTIMATED DESIGN YEAR = 2020 AADT = 51500
 K = 9 % D = 56 % T = 10 % (24 HOUR)
 DESIGN HOUR T = 5 %
 DESIGN SPEED = 70 MPH

TRAFFIC DATA IS REQUIRED TO BE NOTED FOR CURRENT YEAR, OPENING YEAR, AND DESIGN YEAR. POSTED SPEED (MPH) IS OPTIONAL.

FOR STANDARD TYPICAL SECTION NOTES REFER TO EXHIBIT 6-1, THIS CHAPTER

**TYPICAL SECTION
 SR 8
 STA. 567+25.67 TO STA. 1056+84.35**

NEW CONSTRUCTION
 OPTIONAL BASE GROUP 9 WITH
 TYPE SP STRUCTURAL COURSE (TRAFFIC D) (2 1/2")
 TYPE SP STRUCTURAL COURSE (TRAFFIC D) (1 1/2") (PG 76-22) AND
 FRICTION COURSE FC-5 (3/4") (PG 76-22)
MEDIAN SHOULDER PAVEMENT
 OPTIONAL BASE GROUP 1 WITH
 TYPE SP STRUCTURAL COURSE (TRAFFIC D) (1 1/2")
 TYPE SP STRUCTURAL COURSE (TRAFFIC D) (1 1/2") (PG 76-22) AND
 FRICTION COURSE FC-5 (3/4") (PG 76-22)
OUTSIDE SHOULDER PAVEMENT
 OPTIONAL BASE GROUP 1 WITH
 TYPE SP STRUCTURAL COURSE (TRAFFIC B) (1 1/2") AND
 FRICTION COURSE FC-5 (3/4") (PG 76-22)

NOTE:
 HEIGHT OF FILL IS THE VERTICAL DISTANCE FROM THE EDGE OF THE OUTSIDE TRAVEL LANE TO TOE OF FRONT SLOPE.

1:35 FOR FILLS TO 5'
 1:35 TO EDGE OF CLEAR ZONE & 1:34 FOR FILLS 5' TO 10'
 1:35 TO EDGE OF CLEAR ZONE & 1:3 FOR FILLS 10' TO 20'
 1:2 (WITH GUARDRAIL) FILLS OVER 20'

4 LANE INTERSTATE SYSTEM
 NEW CONSTRUCTION
 DIVIDED RURAL
 WITH PROJECTED 20 YR. AADT OF 1500 OR GREATER
 DESIGN SPEED TO MPH

"y" THE AREA DISTURBED BY CONSTRUCTION VARIES.

EXHIBIT TYP-10
 Date: 1/1/07

REVISIONS						STATE OF FLORIDA DEPARTMENT OF TRANSPORTATION			TYPICAL SECTION	SHEET NO.
DATE	BY	DESCRIPTION	DATE	BY	DESCRIPTION	ROAD NO.	COUNTY	FINANCIAL PROJECT ID		

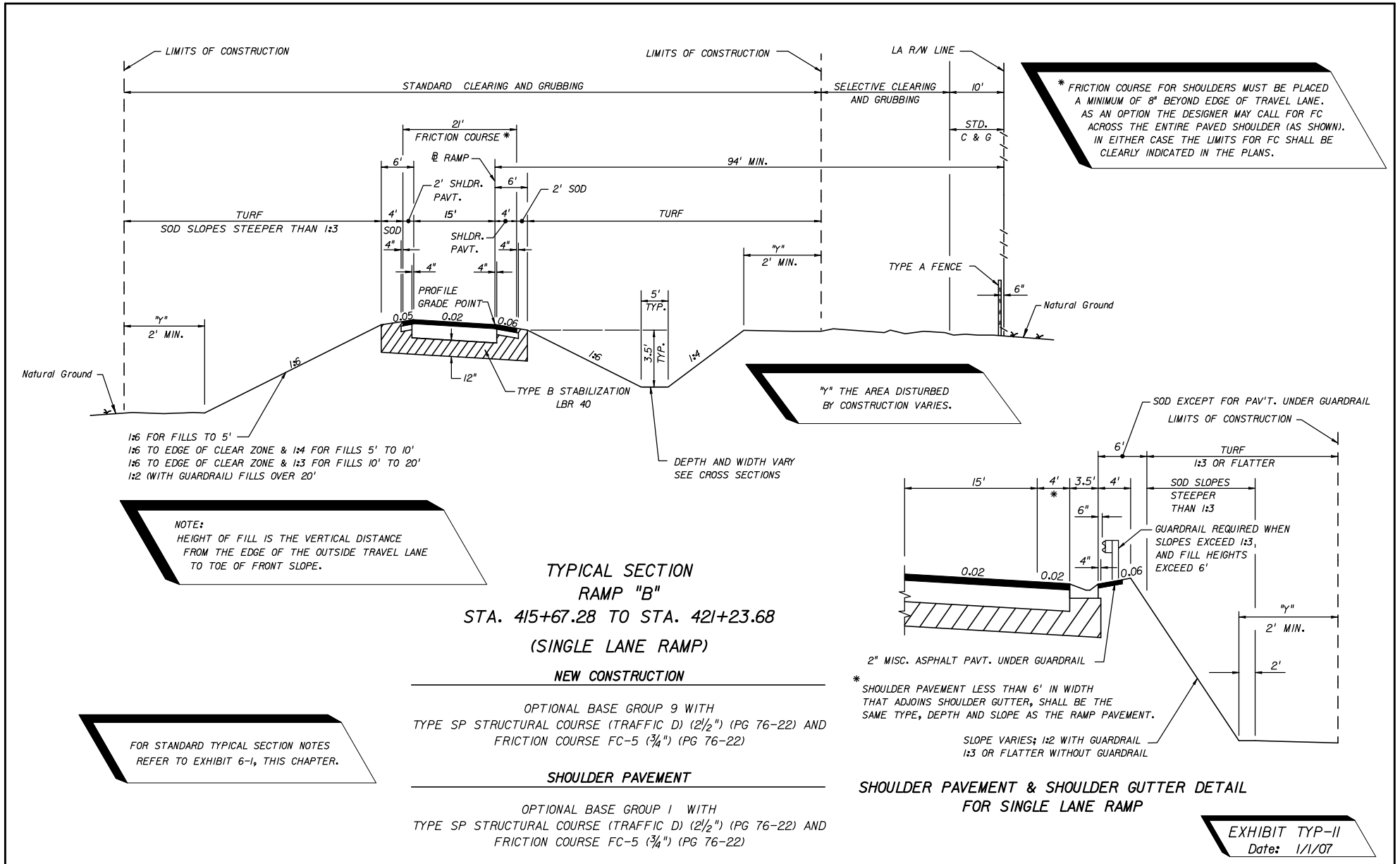

REVISIONS					STATE OF FLORIDA DEPARTMENT OF TRANSPORTATION			RAMP TYPICAL SECTION	SHEET NO.	
DATE	BY	DESCRIPTION	DATE	BY	DESCRIPTION	ROAD NO.	COUNTY			FINANCIAL PROJECT ID

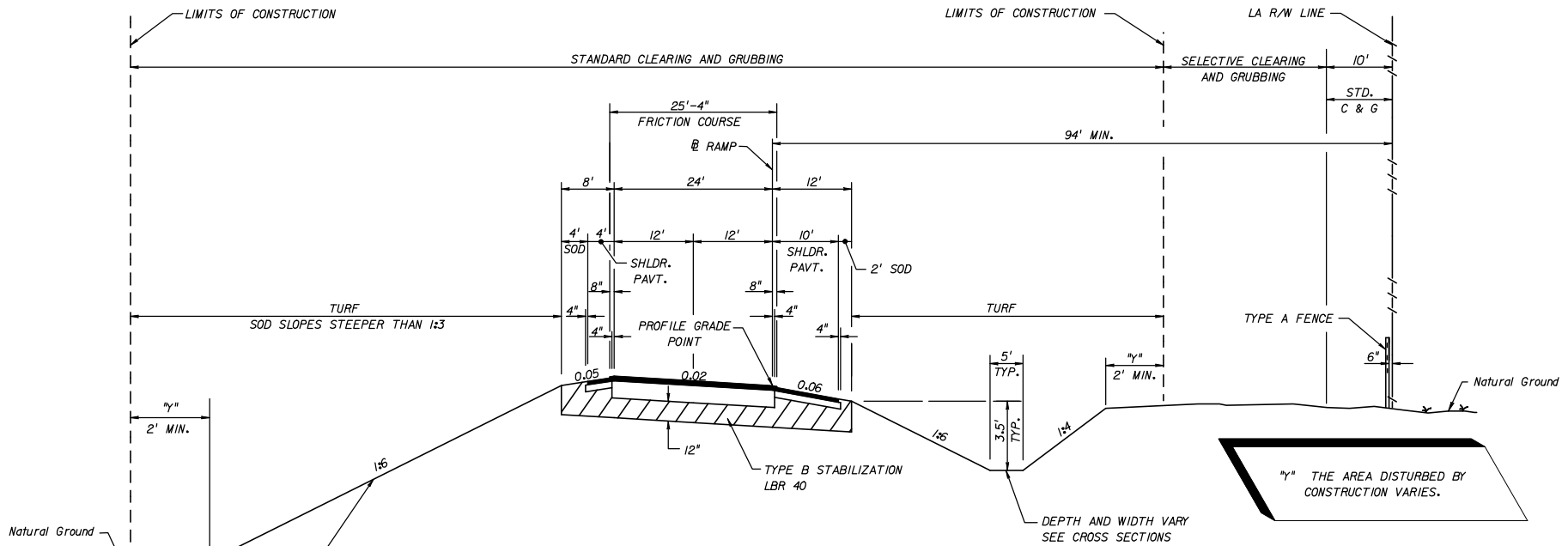

**TYPICAL SECTION
RAMP "C"
STA. 623+28.64 TO STA. 629+13.78
(TWO LANE RAMP)**

NEW CONSTRUCTION

OPTIONAL BASE GROUP 9 WITH
TYPE SP STRUCTURAL COURSE (TRAFFIC D) (2") (PG 76-22) AND
FRICTION COURSE FC-5 (3/4") (PG 76-22)

LEFT SHOULDER PAVEMENT

OPTIONAL BASE GROUP 1 WITH
TYPE SP STRUCTURAL COURSE (TRAFFIC D) (2") (PG 76-22) AND
FRICTION COURSE FC-5 (3/4") (PG 76-22)

RIGHT SHOULDER PAVEMENT

OPTIONAL BASE GROUP 1 WITH
TYPE SP STRUCTURAL COURSE (TRAFFIC B) (2") AND
FRICTION COURSE FC-5 (3/4") (PG 76-22)

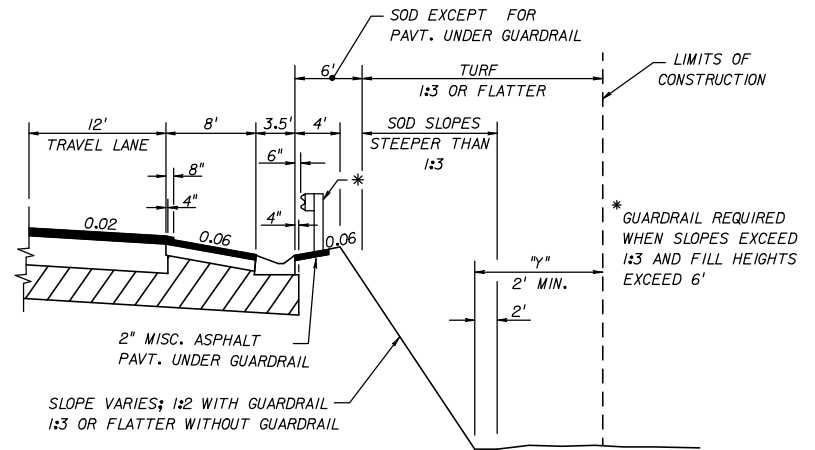

**SHOULDER PAVEMENT & SHOULDER GUTTER DETAIL
MAINLINE AND MULTILANE RAMPS**

**EXHIBIT TYP-12
Date: 1/1/07**

1:6 FOR FILLS TO 5'
1:6 TO EDGE OF CLEAR ZONE & 1:4 FOR FILLS 5' TO 10'
1:6 TO EDGE OF CLEAR ZONE & 1:3 FOR FILLS 10' TO 20'
1:2 (WITH GUARDRAIL) FILLS OVER 20'

NOTE:
HEIGHT OF FILL IS THE VERTICAL DISTANCE
FROM THE EDGE OF THE OUTSIDE TRAVEL LANE
TO TOE OF FRONT SLOPE.

FOR STANDARD TYPICAL SECTION NOTES
REFER TO EXHIBIT 6-1, THIS CHAPTER

REVISIONS					
DATE	BY	DESCRIPTION	DATE	BY	DESCRIPTION

STATE OF FLORIDA DEPARTMENT OF TRANSPORTATION		
ROAD NO.	COUNTY	FINANCIAL PROJECT ID

RAMP TYPICAL SECTION			

SHEET NO.

DESIGNATED BIKE LANES SHALL BE LABELED ON TYPICAL. UNDESIGNATED BIKE LANES SHOULD NOT BE LABELED ON TYPICAL.

IF LANDSCAPING IS DESIRED, TREES SHALL BE TYPES THAT WILL NOT HAVE AN EXPECTED GROWTH GREATER THAN 4" IN DIAMETER MEASURED 6" ABOVE THE GROUND.

TURF SLOPES 1:3 OR FLATTER
* SOD SLOPES STEEPER THAN 1:3

4-LANE
ARTERIAL
NEW CONSTRUCTION
DIVIDED
SUBURBAN
WITH DESIGNATED OR
UNDESIGNATED BIKE LANE
DESIGN SPEED 55 MPH

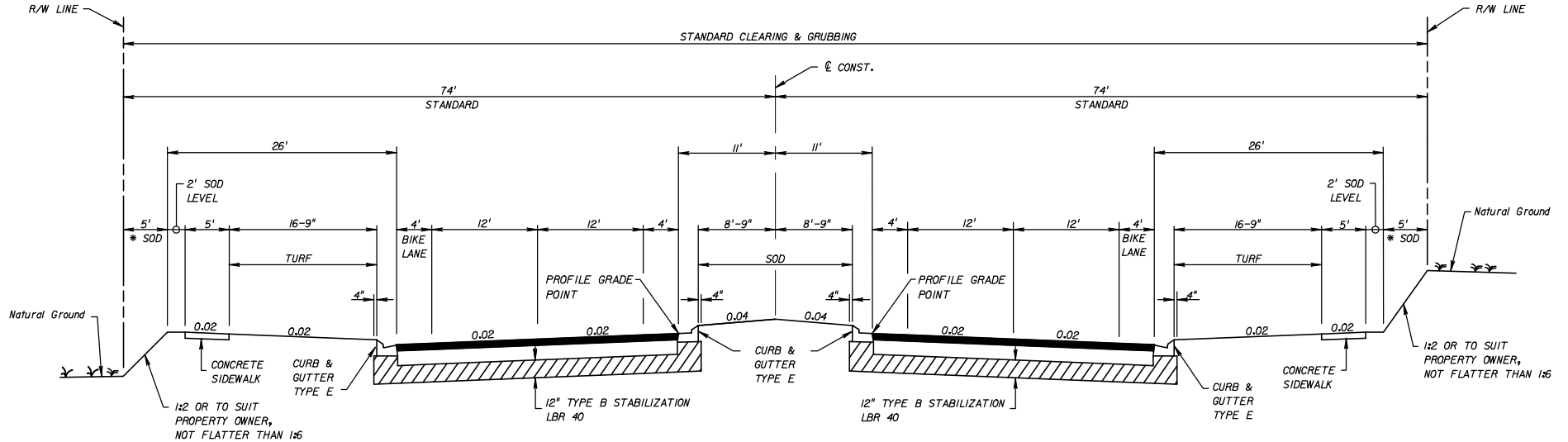

TRAFFIC DATA

CURRENT YEAR = 1999 AADT = 22800
ESTIMATED OPENING YEAR = 2002 AADT = 25800
ESTIMATED DESIGN YEAR = 2022 AADT = 30600
K = 6% D = 55% T = 2% (24 HOUR)
DESIGN HOUR T = 1%
DESIGN SPEED = 55 MPH

SUBURBAN TYPICAL SECTION
SR 00 (SARA AVE.)
STA. 50+40.00 TO STA. 125+50.00

NEW CONSTRUCTION

OPTIONAL BASE GROUP 9 WITH
TYPE SP STRUCTURAL COURSE (TRAFFIC C) (3 1/2")
AND FRICTION COURSE FC-5 (3/4") (RUBBER)

TRAFFIC DATA IS REQUIRED TO BE NOTED FOR CURRENT YEAR, OPENING YEAR AND DESIGN YEAR. POSTED SPEED (MPH) IS OPTIONAL.

FOR STANDARD TYPICAL SECTION NOTES REFER TO EXHIBIT 6-1, THIS CHAPTER.

EXHIBIT TYP-13
Date: 1/1/07

REVISIONS				STATE OF FLORIDA DEPARTMENT OF TRANSPORTATION			SUBURBAN TYPICAL SECTION	SHEET NO.
DATE	BY	DESCRIPTION	DATE	BY	DESCRIPTION			

#USERS

#DATES

#TIMES

#FILES

DESIGNATED BIKE LANES SHALL BE LABELED ON TYPICAL. UNDESIGNATED BIKE LANES SHOULD NOT BE LABELED ON TYPICAL.

4-LANE
ARTERIAL
NEW CONSTRUCTION
DIVIDED
SUBURBAN
WITH DESIGNATED OR
UNDESIGNATED BIKE LANE
DESIGN SPEED 55 MPH OR LESS

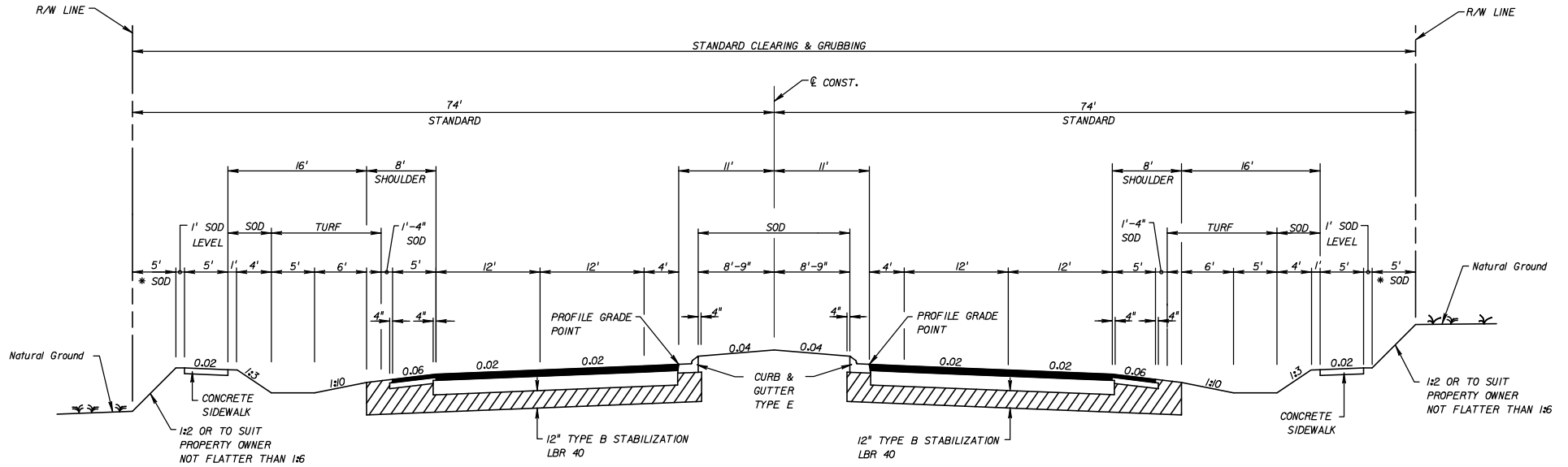

TRAFFIC DATA

CURRENT YEAR = 1999 AADT = 22800
 ESTIMATED OPENING YEAR = 2002 AADT = 25800
 ESTIMATED DESIGN YEAR = 2022 AADT = 30600
 K = 6% D = 55% T = 2% (24 HOUR)
 DESIGN HOUR T = 1%
 DESIGN SPEED = 55 MPH

TRAFFIC DATA IS REQUIRED TO BE NOTED FOR CURRENT YEAR, OPENING YEAR AND DESIGN YEAR. POSTED SPEED (MPH) IS OPTIONAL.

FOR STANDARD TYPICAL SECTION NOTES REFER TO EXHIBIT 6-1, THIS CHAPTER.

**SUBURBAN TYPICAL SECTION
 SR 00 (CODY ROAD)
 STA. 100+40.00 TO STA. 225+50.00**

NEW CONSTRUCTION

OPTIONAL BASE GROUP 9 WITH
 TYPE SP STRUCTURAL COURSE (TRAFFIC C) (3 1/2")
 AND FRICTION COURSE FC-5 (3/4") (RUBBER)

SHOULDER PAVEMENT

OPTIONAL BASE GROUP 1 WITH
 TYPE SP STRUCTURAL COURSE (TRAFFIC C) (1 1/2")
 AND FRICTION COURSE FC-5 (3/4") (RUBBER)

TURF SLOPES 1:3 OR FLATTER
 * SOD SLOPES STEEPER THAN 1:3

IF LANDSCAPING IS DESIRED, TREES SHALL BE TYPES THAT WILL NOT HAVE AN EXPECTED GROWTH GREATER THAN 4" IN DIAMETER MEASURED 6" ABOVE THE GROUND.

EXHIBIT TYP-14
 Date: 1/1/07

REVISIONS						STATE OF FLORIDA DEPARTMENT OF TRANSPORTATION			SUBURBAN TYPICAL SECTION	SHEET NO.
DATE	BY	DESCRIPTION	DATE	BY	DESCRIPTION	ROAD NO.	COUNTY	FINANCIAL PROJECT ID		

#USERS

#DATES

#TIMES

#FILES

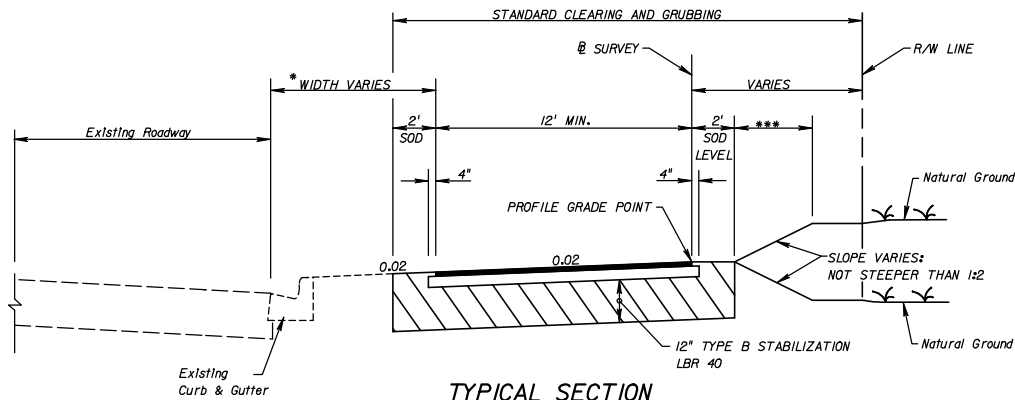

**TYPICAL SECTION
SHARED USE PATH
SR 00 (WILLOW WAY)
STA. 122+00.000 TO STA. 210+65.000
PATH**

OPTIONAL BASE GROUP I WITH
TYPE SP STRUCTURAL COURSE (TRAFFIC A) (1")

* FOR ROADWAYS WITH CURBS, A MINIMUM SEPARATION OF 5 FEET MEASURED FROM THE OUTSIDE EDGE OF TRAVELED WAY TO THE INSIDE EDGE OF THE SHARED USE PATH SHOULD BE PROVIDED.

*** TURF,
SOD OR TURF,
SOD.

NOTE:
THE DESIGN SPEED FOR SHARED USE PATHS IS 20 MPH.

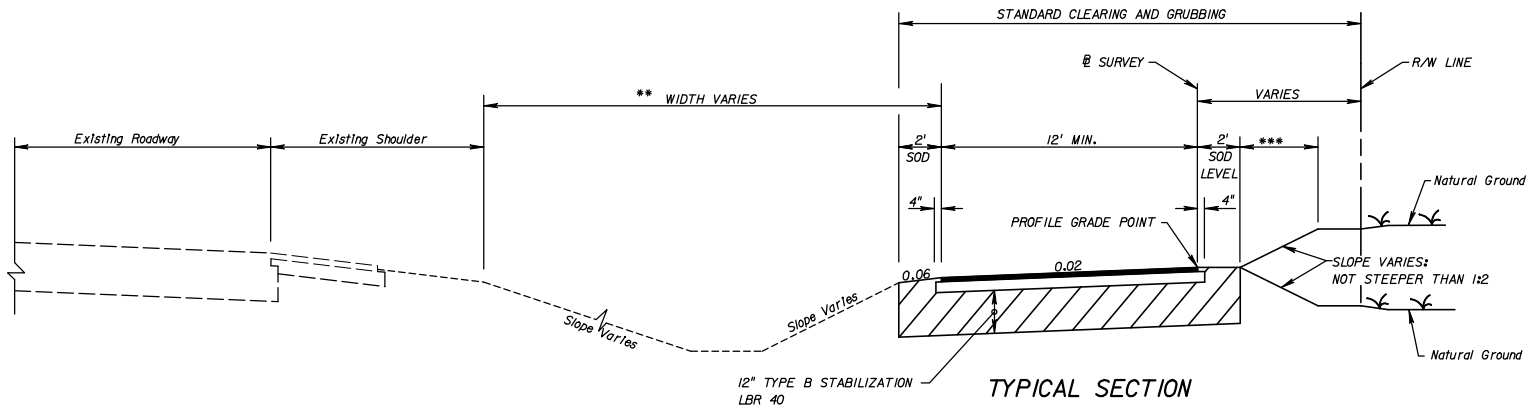

**TYPICAL SECTION
SHARED USE PATH
SR 00 (DEXTON HEIGHTS)
STA. 22+00.000 TO STA. 51+65.000
PATH**

OPTIONAL BASE GROUP I WITH
TYPE SP STRUCTURAL COURSE (TRAFFIC A) (1")

** FOR ROADWAYS WITH FLUSH SHOULDERS, A MINIMUM SEPARATION OF 5 FEET MEASURED FROM THE OUTSIDE EDGE OF SHOULDER TO THE INSIDE EDGE OF THE SHARED USE PATH SHOULD BE PROVIDED.

EXHIBIT TYP-15
Date: 1/1/07

REVISIONS					
DATE	BY	DESCRIPTION	DATE	BY	DESCRIPTION

STATE OF FLORIDA DEPARTMENT OF TRANSPORTATION		
ROAD NO.	COUNTY	FINANCIAL PROJECT ID

SHARED USE PATH

SHEET NO.

**** IF LIMITS OF CONSTRUCTION EXCEED RIGHT OF WAY, A PROPERTY AGREEMENT IS REQUIRED.

6-LANE ARTERIAL
NEW CONSTRUCTION
DIVIDED
URBAN
DESIGN SPEED 50 MPH

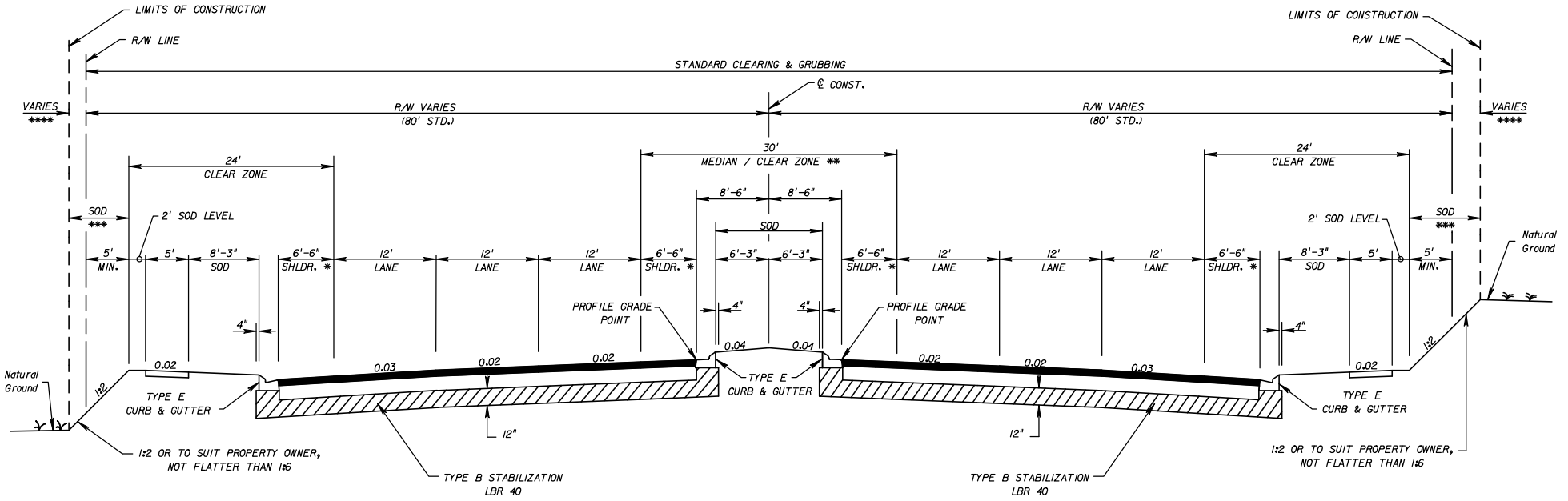

**TYPICAL SECTION
SR 00 (SOUTH INDEPENDENCE STREET)
STA. 401+30.00 TO STA. 788+66.00**

TRAFFIC DATA
CURRENT YEAR = 1998 AADT = 22800
ESTIMATED OPENING YEAR = 2000 AADT = 25800
ESTIMATED DESIGN YEAR = 2020 AADT = 30600
K = 6% D = 55% T = 2% (24 HOUR)
DESIGN HOUR T = 1%
DESIGN SPEED = 50 MPH

TRAFFIC DATA IS REQUIRED TO BE NOTED FOR CURRENT YEAR, OPENING YEAR AND DESIGN YEAR.

FOR STANDARD TYPICAL SECTION NOTES REFER TO EXHIBIT 6-1, THIS CHAPTER.

NEW CONSTRUCTION
OPTIONAL BASE GROUP 9 WITH
TYPE SP STRUCTURAL COURSE (TRAFFIC C) (3 1/2")
AND FRICTION COURSE FC-5 (3/4") (RUBBER)

* PROVIDES FOR 8' OF USABLE SHOULDER

** THE 30' MEDIAN AREA PROVIDES SUFFICIENT WIDTH FOR:
- 24' CLEAR ZONE
- DUAL LEFT TURN LANES (3 lanes, 4' separator in median shoulder)
- DIRECTIONAL MEDIAN OPENING (4' separators in median shoulder)

*** TURF, SOD OR TURF, SOD.

EXHIBIT TYP-16
Date: 1/1/07

REVISIONS						STATE OF FLORIDA DEPARTMENT OF TRANSPORTATION			TYPICAL SECTION	SHEET NO.
DATE	BY	DESCRIPTION	DATE	BY	DESCRIPTION	ROAD NO.	COUNTY	FINANCIAL PROJECT ID		

Chapter 7

Summary of Quantities

7.1	General	7-1
7.2	Item Quantity "Boxes" and Format	7-2
7.3	Box Culvert Data Sheet.....	7-3
Exhibits		
Exhibit 7-1	Standard Notes for Summary of Quantities Sheet.....	7-5

THIS PAGE LEFT BLANK INTENTIONALLY

Chapter 7

Summary of Quantities

7.1 General

The summary of quantities sheet shows individual summaries of guardrail, crash cushions, fence, turnouts, sodding, ditch pavement, side drains, mitered end sections, underdrains, and earthwork when applicable. The tabulation shall show location and quantities in the plan quantity column (P). The final quantity column (F) is reserved for construction and final estimates. As noted in **Chapter 4**, the necessary pay items and the quantities shall be shown on the summary of pay items sheet.

For examples of summary of quantities sheets see **Exhibits SQ-1** thru **4**.

7.2 Item Quantity "Boxes" and Format

The various "boxes" used for each type of summary are contained in the FDOT Engineering/CADD Systems Software. Each box is identified by the appropriate Form Number required for the Computation Book. The arrangement of these "boxes" on the sheet is dependent on the number used and the size each one must be to contain all of the necessary information.

On contracts with multiple Financial Project ID's or federal aid and non-federal aid quantities, provisions shall be made to tabulate and summarize their respective quantities.

Standard notes (see **Exhibit 7-1**) shall be shown under the appropriate box.

Applicable pay item notes, listed in **Exhibit 7-1**, shall also be included on this sheet.

7.3 Box Culvert Data Sheet

The structural design of box culverts may be done by one of two computer programs dependent on the applicable design specification as described in **Chapter 33**.

The first program is the **LRFD Box Culvert Program** and designs the culvert based on the details shown on **Index 289** of the **Design Standards**. When this program is used the Box Culvert Data Table (from the Structures Sitemenu CADD cells) and the Reinforcing Bar List shall be completed and placed on normally formatted plan sheets. These sheets should be placed together, behind the drainage structure sheets in the contract plans.

The second program is **PSTDN55** and designs the culvert based on the details shown on **Index 290** of the **Design Standards** using Load Factor Design (LFD). When this program is used the program output (data sheets) showing the concrete and steel quantities shall be transferred to a graphics design file and placed on a normally formatted plan sheet. The plan sheet shall be placed in the contract plans directly behind the Summary of Quantities Sheet(s).

THIS PAGE LEFT BLANK INTENTIONALLY

Exhibit 7-1 Standard Notes for Summary of Quantities Sheet Sheet 1 of 2

Below are standard notes that should be used on the summary of quantities sheet, as applicable:

(Under Summary of Earthwork):

Earthwork has been calculated using the _____ base option. If another option is constructed, there shall be no revision to the earthwork quantities for which payment is made by plan quantity.

Pay Item Notes

1. 102- 1- Includes approximately _____ SY of Temporary Pavement.
2. 104- 13- 1 Based on replacement every 12 months.
3. 110- 86- All salvageable material designated to be delivered by the contractor shall be delivered to:

(Provide address of nearest FDOT Maintenance Yard.)

(On applicable Utility JPA plans, also include the following note):

All utility infrastructure designated in the utility plans to be salvaged and delivered by the contractor shall be delivered to:

(Provide applicable Utility/Agency Owner address.)

4. 334- 1 Includes _____ TN for turnouts, connections to existing drives, streets, etc., as directed by the Engineer.
5. 400- 1- 15 Includes _____ CY for miscellaneous construction, as directed by the Engineer.
6. (For new construction projects with Asphalt Base, Type B-12.5 Only):
520-1-7 or 520-1-10

Cost of asphalt curb pad and additional curb thickness required to be included in the cost of curb and gutter.

7. 536- 73- (To be used for the removal of existing guardrail when FDOT Maintenance wants materials).

Existing guardrail to be dismantled and stockpiled within the right of way in areas designated by the Engineer for removal by FDOT maintenance forces.

**Exhibit 7-1 Standard Notes for Summary of Quantities Sheet
Sheet 2 of 2**

8. 538- 1- This is to include replacement of _____ panels, _____ regular posts and _____ special posts which have been determined to be non-salvageable. Additional posts and panels determined to be non-salvageable during resetting shall be paid for under 538-5 of the Specifications.
9. Temporary Turf: When required by the project design, these items shall be included in the cost of the Performance Turf items (Note: When 570-1-A items are used in the plans, 104-4 (Mowing) shall not be used). A pay item note should show the approximate quantities. For example:
 - 570- 1- 1 Includes approximately _____ SY Turf for temporary erosion control.
 - 570- 1- 2 Includes approximately _____ SY Sod for temporary erosion control.
10. 639- 2- 1 Payment shall be based on the linear feet of a single conductor.
11. The following pay item note should be shown in the Roadway Plans:
 - 710- The totals shown on the Summary of Roadway Pay Items are for painted pavement markings used for Maintenance of Traffic.

SUMMARY OF SODDING

LOCATION STA. TO STA.	SIDE	P			F			FIELD BOOK REFERENCE
		L	W	SY	L	W	SY	
<i>NB I-00</i>								
570+00 - 580+62	MED	1062	1.33	157				
570+00 - 574+57	RT	457	1.33	68				
575+45 - 576+80	RT	135	1.33	20				
576+80 - 579+95	RT	315	56	1960				
579+95 - 580+62	RT	67	32	238				
580+62 - 586+37	MED	575	1.33	85				
580+62 - 586+37	RT	575	1.33	85				
<i>SB I-00</i>								
570+00 - 580+62	MED	1062	1.33	157				
570+00 - 574+57	LT	457	1.33	68				
575+45 - 577+25	LT	180	1.33	27				
577+25 - 580+34	LT	309	48	1648				
580+34 - 580+62	LT	28	37	115				
580+62 - 586+37	MED	575	1.33	85				
580+62 - 586+37	LT	575	1.33	85				
<i>RAMP A</i>								
182+99 - 187+24	LT	425	1.33	63				
180+87 - 187+74	RT	687	1.33	102				
<i>RAMP B</i>								
276+62 - 281+75	LT	513	1.33	76				
274+47 - 280+29	RT	582	1.33	86				
<i>RAMP C</i>								
382+45 - 386+88	RT	443	1.33	65				
381+95 - 388+30	LT	635	1.33	94				
<i>RAMP D</i>								
481+05 - 485+63	LT	458	1.33	68				
480+64 - 487+31	RT	667	1.33	99				
<i>DRAINAGE STRUCTURES</i>				807				
<i>PAVED DITCHES</i>				278				
TOTAL				6536				

SUMMARY OF SIDEDRAIN & MITERED END SECTIONS

LOCATION STA. TO STA.	SIDE	PIPE LENGTH (LF)									
		15"	MES (EA)	18"	MES (EA)	24"	MES (EA)	30"	MES (EA)	36"	MES (EA)
P 150+10 - 150+50	RT	40	2								
F 160+85 - 161+21	LT			36	2						
P 176+36 - 176+78	LT						42	2			
F 181+46 - 181+98	RT					52	2				
P 192+46 - 192+82	LT	36	2								
F 194+50 - 195+14	RT								64	2	
P TOTAL		76	4	36	2	52	2	42	2	64	2
F											
P											
F											
P											
F											

EXHIBIT SQ-1
Date: 1/1/07

REVISIONS						STATE OF FLORIDA DEPARTMENT OF TRANSPORTATION			SUMMARY OF QUANTITIES	SHEET NO.
DATE	BY	DESCRIPTION	DATE	BY	DESCRIPTION	ROAD NO.	COUNTY	FINANCIAL PROJECT ID		

SUMMARY OF GUARDRAIL

LOCATION		GUARDRAIL (LF)						END ANCHORAGE ASSEMBLIES (EA)								REMARKS	FIELD BOOK REFERENCE		
STATION	SIDE	ROADWAY		ROADWAY, DOUBLE FACE		PEDESTRIAN SAFETY TREATMENT		RUBRAIL		FLARED		PARALLEL		TYPE II				TYPE CRT	
		P	F	P	F	P	F	P	F	P	F	P	F	P	F			P	F
FROM 600+50	RT	87.5				From		From 600+70		I									
TO 601+37			To 601+20																
FROM 600+10	LT	125.0				From		From											
TO 601+35			To	To															
FROM 602+25	RT	100.0				From 602+30		From		I									
TO 603+25			To 603+00	To															
FROM 600+50	MED			275.0		From		From											
TO 603+25					To	To													
FROM 604+25	RT	62.5				From		From		I									
TO 604+87			To	To															
FROM 602+45	LT	75.0				From		From											
TO 603+20			To	To															
FROM						From		From											
TO						To		To											
TOTAL		450		275						3		I		7		I			

SUMMARY OF DITCH PAVEMENT AND SODDING

LOCATION	SIDE	RIPRAP (SAND CEMENT)		RIPRAP (RUBBLE)		CONCRETE		SODDING		REMARKS	FIELD BOOK REFERENCE
		CY		TN		SY		SY			
		P	F	P	F	P	F	P	F		
128+17	LT	21.6									
128+52	RT	24.2									
137+12 (S-2)	LT					26		8			
156+14 (S-6)	LT					30		9			
158+00 (S-7)	LT/RT					96		42			
161+20 (S-9)	LT					40		10			
168+40 (S-12)	RT					108		12			
172+87 (S-15)	RT					56		10			
180+12 (S-17)	LT					20		8			
182+57 (S-20)	RT					20		7			
TOTAL		45.8				396		106			

WHEN A PEDESTRIAN SAFETY TREATMENT, AND/OR RUB RAIL TREATMENT, IS TO BE PROVIDED FOR A RUN OF GUARDRAIL, THE BEGINNING AND END STATION IS TO BE NOTED AS SHOWN IN THE SUMMARY OF GUARDRAIL ABOVE. OTHERWISE, THESE COLUMNS MAY BE DELETED.

EXHIBIT SQ-2
Date: 1/1/07

REVISIONS				STATE OF FLORIDA DEPARTMENT OF TRANSPORTATION			SUMMARY OF QUANTITIES	SHEET NO.
DATE	BY	DESCRIPTION	DATE	BY	DESCRIPTION			
ROAD NO.	COUNTY	FINANCIAL PROJECT ID						

SUMMARY OF EARTHWORK

DESCRIPTION	P	F
	CY	CY
ROADWAY EXCAVATION, MAINLINE	10,000	
ROADWAY EXCAVATION, ADAMS ST.	800	
REGULAR EXCAVATION, POND #1	1,005	
REGULAR EXCAVATION FROM LATERAL DITCHES	5,000	
TOTAL REGULAR EXCAVATION	16,805	
EMBANKMENT, MAINLINE	20,000	
EMBANKMENT, ADAMS ST.	7,000	
TOTAL EMBANKMENT	27,000	
SUBSOIL EXCAVATION, MAINLINE	2,080	
SUBSOIL EXCAVATION, ADAMS ST.	1,100	
TOTAL SUBSOIL EXCAVATION	3,180	

SUMMARY OF EARTHWORK

DESCRIPTION	P	F
	CY	CY
FILL, MAINLINE	253	
FILL, GUARDRAIL LOCATIONS	70	
FILL, CROSS DRAINS	100	
SUB-TOTAL FILL	423	
FILL ADJUSTMENT (20%) (423 x 0.20)	+85	
SUB-TOTAL WITH FILL ADJUSTMENT	508	
TRUCK ADJUSTMENT (25%) (571 x 0.25)	+127	
TOTAL BORROW EXCAVATION	635	

Earthwork has been calculated using the _____ base option.
 If another option is constructed, there shall be no revision to the
 earthwork quantities for which payment is made by Plan Quantity.

FOR PROJECTS WITH CROSS SECTIONS

FOR PROJECTS WITHOUT CROSS SECTIONS

Adjustment percentages shown are for example only.
 Contact District Materials Office or Construction
 for actual percentages to be used for each project.

EXHIBIT SQ-3
 Date: 1/1/07

REVISIONS						STATE OF FLORIDA DEPARTMENT OF TRANSPORTATION	SUMMARY OF QUANTITIES	SHEET NO.
DATE	BY	DESCRIPTION	DATE	BY	DESCRIPTION			

#USERS

#DATES

#TIMES

#FILES

SUMMARY OF PERMANENT CRASH CUSHIONS

STATION	SIDE	DESIGN SPEED	OPTIONS ALLOWED	TRANSITION REQUIRED Y/N	PAY ITEMS								
					544-75-40		544-75-22		544-75-9		544-75-14		
					P	F	P	F	P	F	P	F	
100+50	Rt	60	QuadGuard	Y	1								
			TAU II	Y									
			TRACC	Y									
103+10	Med	60	WideTRACC	Y			1						
110+65	Med	60	BRAKEMASTER	N					1				
125+23	Rt	70	QuadGuard HS	Y	1								
			TAU II	Y									
			TRACC	Y									
1175+15	Rt	35	QuadGuard	Y								1	
1321+37	Lt	50	QuadGuard	Y	1								
			TAU II	Y									
Total					3		1		1		1		

EXHIBIT SQ-4
Date: 1/1/07

REVISIONS						STATE OF FLORIDA DEPARTMENT OF TRANSPORTATION			SUMMARY OF QUANTITIES	SHEET NO.
DATE	BY	DESCRIPTION	DATE	BY	DESCRIPTION	ROAD NO.	COUNTY	FINANCIAL PROJECT ID		

Chapter 8

Summary of Drainage Structures and Optional Materials Tabulation

8.1	Summary of Drainage Structures.....	8-1
8.1.1	Sheet Setup and Data.....	8-2
8.2	Optional Materials Tabulation	8-4

THIS PAGE LEFT BLANK INTENTIONALLY

Chapter 8

Summary of Drainage Structures and Optional Materials Tabulation

8.1 Summary of Drainage Structures

The summary of drainage structures sheet shows the location, size, length, number and type of drainage structures used in a project. The sheet format is available in the FDOT Engineering/CADD Systems Software. Specific levels and fonts which shall be used are given in the FDOT ***CADD Production Criteria Handbook***.

For an illustration of the summary of drainage structures sheet, see ***Exhibit SDS-1a***.

8.1.1 Sheet Setup and Data

A summary of drainage structures shall be prepared and included in the plans. The structures shall be listed by structure number in numerical order. The location of each structure shall be identified by station along the construction centerline (**Exhibit SDS-1a**).

For cross drains, and storm sewer the summary of drainage structures shall be tabulated by structure number, providing the station, size, length and incidental quantities appropriate for the material detailed in the plans. Optional culvert material will be provided and a tabulation form shall be prepared and included (see **Section 8.2**).

Various drainage elements shall be shown in columns. This information shall be obtained from drainage structure sheets or plan-profile sheets. The order in which the elements are listed should be as follows:

1. Pipe Sizes for
 - a. Cross Drains
 - b. Storm Sewer
 - c. Gutter Drain
2. Curb Inlets
3. Manholes
4. Junction Boxes
5. Ditch Bottom Inlets
6. Gutter Inlets
7. Flared End Sections
8. Mitered End Sections
9. Sod
10. Class of Concrete
11. Reinforcing Steel
12. Riprap

The "Description" column shall be used to specify the type of structure, the outgoing pipe and the end treatment of that pipe, if applicable.

The remarks column shall contain all special notes pertaining to the structure. The "Final Quantity" line is for construction to use and shall be left blank.

On smaller projects the summary of quantities and the summary of drainage structures may be combined on one sheet.

It is recommended that structure numbers be established using the convention shown in the exhibits and described as follows:

1. For simple cross drains, one structure number is appropriate for the inlet and outlet treatments and the pipe.

Example #1 (cross drain w/o median inlet)

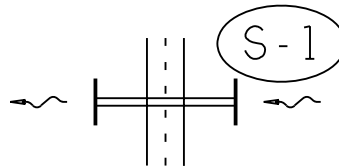

2. For complex cross drains, it is suggested that the first and all intermediate structure numbers identify the hydraulically upper end treatment and pipe. The last structure number should identify the hydraulically upper end treatment, pipe and hydraulically lower end treatment.

Example #2 (Double pipe CD and median inlet)

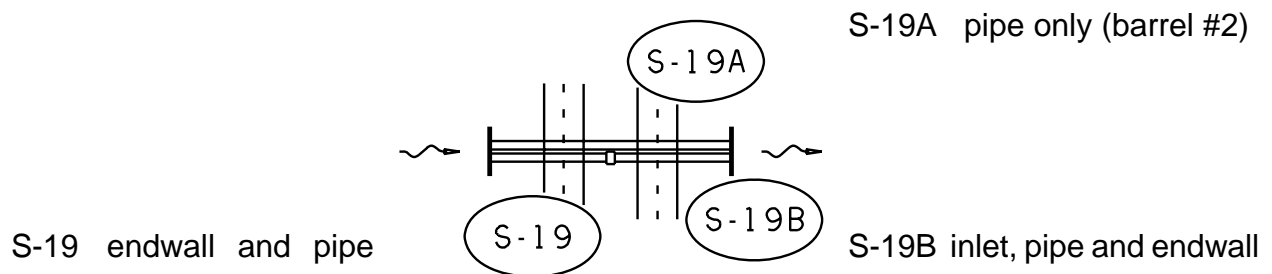

8.2 Optional Materials Tabulation

An optional materials tabulation shall be prepared and included in the plans (see **Exhibits SDS-2a** and **SDS-3a**). The sheet format is available in the FDOT Engineering Systems Software.

As a minimum, the optional pipe material tabulation should include size, thickness or class, corrugation requirements, if necessary, and protective coating, if any. Additional information such as structure number, design service life (DSL), length, and flow line information may be included.

The general notes shown on the exhibits are also required.

GENERAL NOTES

- The Contractor may use any of the optional pipe materials tabulated for a given structure. Only the material options tabulated for a given structure can be used.
- Adjustment to the bid quantities, prices and payment will not be allowed due to increase or decrease in structure size, shape, length, width, depth or accessory construction necessary to accommodate the use of an optional pipe material other than the "plotted" option; likewise there will be no added or reduced compensation for structure alterations required to relieve utility conflicts which arise from the use of an optional material other than the "plotted" option.
- Adjustment to the bid quantities, prices and payment will not be allowed due to increased or decreased excavation, bedding, borrow, backfilling, compaction, special installation requirements or disposal of excess materials due to use of any of the pipe optional materials. Likewise, adjustment in the quantities, prices and payment will not be allowed due to differences in end treatment size or types, pipe length, alternate jointing and connecting materials, saddles, cradles, filter fabrics, shoring or similar features due to the use of an optional material other than the "plotted" option.
- If adjustments are required due to plan errors or omissions or authorized field changes, the "plotted" material and not the material elected by the Contractor would be used to establish new pay quantities.
- The Contractor shall notify the Department in writing as to which optional pipe materials he chooses to use at the preconstruction conference. Once identified the Contractor may not change pipe material selected without the approval of the Engineer.
- Pipe shapes other than round (Elliptical/Arch) are summarized and paid for using equivalent round pipe diameter.

THIS EXAMPLE SHOULD BE USED WHEN PIPE FLOW LINES, AND/OR SIZES FOR INDIVIDUAL OPTIONS ARE NOT THE SAME (SEE STRUCTURE NO. 14) OR WHEN NUMEROUS EXCEPTIONS OCCUR.

STR. NO.	DSL YEARS	SIZE (Inches)	PLOTTED	MATERIAL & THICKNESS	FL	FL	AS BUILT	REMARKS
1	100	18	X	SRCP CLASS II				
2	100	18	X	SRCP CLASS II				
3	100	15	X	SRCP CLASS II SRAP	7.0			
4	100	36	X	SRCP CLASS II SRSP, 12 GA. SRAP, 12 GA. SRASP, 16 GA.	5.7			
5	100	15	X	SRCP CLASS II SRAP	7.7			
6	100	36	X	SRCP CLASS II SRSP, 12 GA. SRAP, 12 GA. SRASP, 16 GA.	6.4	5.7		
7	100	36	X	SRCP CLASS II	6.5	6.4		
8	100	42	X	SRCP CLASS II SRAP SRSP	7.9	7.7		
9	100	30	X	SRCP CLASS II SRAP, 16 GA. SRSP, 16 GA.	6.8	6.5		
10	100	18	X	SRCP CLASS II SRAP, 16 GA. SRSP, 14 GA. SRASP, 16 GA.	7.6	7.2		
11	100	18	X	SRCP CLASS II SRAP, 16 GA. SRSP, 14 GA. SRASP, 16 GA.	8.0	7.6		
12	100	24	X	SRCP CLASS III				ENDWALL
13	100	24x38 35x24	X	ERCP CLASS II ASPA, 14 GA.	10.4	10.3		
14	50	30	X	SRCP CLASS III SRASP 14 GA. SRAP, 14 GA. PEP-1 PVC CAP, 16 GA. CSP, 16 GA. BIT. COATED	6.0	5.9		
14A	50	19x30 28x20	X	ERCP CLASS III ASPA 14 GA.	5.9	5.8		

EXHIBIT SDS-2a
Date: 1/1/06

REVISIONS						STATE OF FLORIDA DEPARTMENT OF TRANSPORTATION			OPTIONAL MATERIALS TABULATION	SHEET NO.
DATE	BY	DESCRIPTION	DATE	BY	DESCRIPTION	ROAD NO.	COUNTY	FINANCIAL PROJECT ID		

Chapter 9

Project Layout

9.1	General	9-1
9.2	Alignment Sheet Sequence.....	9-2
9.3	Survey Reference Points	9-3
9.4	General Notes	9-4

THIS PAGE LEFT BLANK INTENTIONALLY

Chapter 9

Project Layout

9.1 General

The project layout sheet (or sheets) shows the horizontal alignment and plan or plan-profile sheet sequence and numbering for the project. This is an optional sheet, to be included in the plans set at the discretion of the district. The project layout sheet can prove to be of great advantage for large or complicated projects involving large interchanges with a number of diverging routes. If included in the plans set, this sheet should also show all survey reference points and list all general notes applicable to the project.

The layout sheet shall be prepared on a standard plan format sheet in the FDOT Engineering/CADD Systems Software. Scale shall be such that clarity and legibility are preserved. North arrow and scale shall be shown at a point of maximum visibility on the sheet. For large, complicated projects, more than one sheet may be required to clearly depict all required information. Appropriate match lines shall be shown if more than one sheet is required.

9.2 Alignment Sheet Sequence

Complete project alignment with baseline of survey and/or centerline of construction shall be shown. Edge of pavements shall be shown if scale permits. Outlines of the plan, or plan-profile sheets shall be superimposed on the alignment to depict the sheet sequence with relation to the alignment stationing. Each sheet outline shall contain the appropriate plan sheet number. The order of plan/plan-profile sheet numbering shall be as follows:

1. Mainline (for widely separated roadways, the right roadway in the direction of stationing takes precedence)
2. Crossroads
3. Ramps
4. Frontage roads
5. Access roads

Beginning and ending stations for project, construction and ramps shall be flagged and labeled, including equations and/or exceptions.

9.3 Survey Reference Points

Generally, survey reference points should be shown on the project layout sheet just beneath the alignment sheet sequence plan or where other space allows. Baseline survey and reference points, with all ties, shall be clearly indicated. Complete length of survey baseline between two consecutive reference points need not be shown. Each reference point shall be clearly labeled, beginning at the first reference point within the limits of the project, and progressing in the direction of stationing. Usually, reference points need not be drawn to any particular scale, but distances and angles shown shall be proportionate. Care should be taken to ensure that clarity and legibility are maintained.

9.4 General Notes

When the layout sheet is included in the plans set, applicable general notes should be included on the layout sheet instead of the first plan-profile sheet to help simplify the plan-profile sheets.

For a list of general notes, refer to ***Exhibit 10-1*** in ***Chapter 10*** of this volume.

Chapter 10

Roadway Plan and Roadway Plan-Profile

10.1	General	10-1
10.2	Roadway Plan Portion.....	10-2
10.2.1	Centerline.....	10-2
10.2.2	Horizontal Curves	10-4
10.2.3	Existing Topography	10-5
10.2.4	Reference Data.....	10-6
10.2.5	Construction and Project Limits	10-6
10.2.6	Drainage Structures and Bridges.....	10-7
10.2.7	Plan Layout.....	10-7
10.3	Roadway Profile Portion.....	10-9
10.3.1	General Data.....	10-9
10.3.2	Vertical Alignment	10-10
10.3.3	Grades	10-10
10.3.4	Superelevation and Special Profiles	10-10
10.3.5	Other Profile Features.....	10-11
10.4	General Notes for Roadway Plan and Roadway Plan-Profile Sheets	10-13

Figures

Figure 10.1	Centerline Station Numbering and Tick Marks.....	10-3
-------------	--	------

Exhibits

Exhibit 10-1	General Notes for Roadway Plan and Roadway Plan-Profile Sheets	10-14
--------------	---	-------

THIS PAGE LEFT BLANK INTENTIONALLY

Chapter 10

Roadway Plan and Roadway Plan-Profile

10.1 General

The roadway plan sheet shows the project's complete horizontal alignment. The plan-profile sheet shows the project's complete horizontal and vertical alignments. Various roadway elements such as pavement width, medians, paved shoulders, curbs, drainage elements, tapers, turn provisions, and intersecting roadways, are also shown on these sheets.

Roadway plan and roadway plan-profile sheets shall be prepared on standard formatted sheets that are contained in the FDOT Engineering/CADD Systems Software. Plotting should typically be done at a horizontal scale of 1" = 40' or 1" = 50' for urban jobs. For rural jobs, the scale should typically be from 1" = 100' or 1" = 200' horizontally, depending on the project specific details.

If a project layout sheet is not included in the plans set, provision shall be made on the first plan-profile sheet to show applicable general notes. Refer to **Exhibit 10-1** for a list of general notes.

10.2 Roadway Plan Portion

10.2.1 Centerline

The baseline survey and/or centerline of construction should be centered in the plan portion of the sheet, with stationing running from left to right. For resurfacing projects, simple projects, or sections of a project without a profile view, “stacking” multiple plans on one sheet is generally permitted if clarity and legibility are maintained. When multiple plan views are shown on a plan sheet, they shall be stacked from top to bottom. When alignment includes horizontal curves, the centerline should be positioned on the sheet to avoid breaks or match lines (except at the beginning or end of the sheet).

A "tick" mark shall be placed on the upper side of the centerline at every station. In addition, intermediate ticks shall be placed as shown in **Figure 10.1**. Intermediate ticks should be about half the length of those at each station.

Station numbers should be placed close to tick marks for scales up to and including 1" = 50' and outside the R/W lines for smaller scales.

In cases where the construction centerline does not coincide with the survey baseline, the construction centerline shall be identified with complete alignment data and ties to the survey baseline. However, the construction centerline need not be shown when it is uniformly offset from the survey baseline for the entire length of the project, and is shown on the typical sections. All station equations shall be included. These include equations occurring on the survey baseline and those equating the survey baseline and construction centerline.

A north arrow and scale shall be shown at a point of maximum visibility, preferably in the upper right portion of the plan view.

Figure 10.1 Centerline Station Numbering and Tick Marks

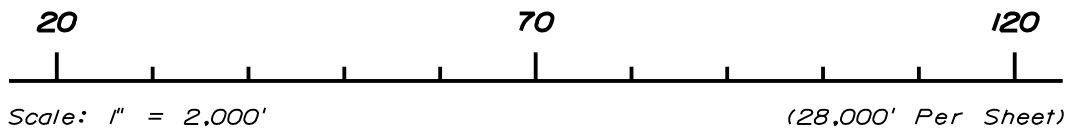
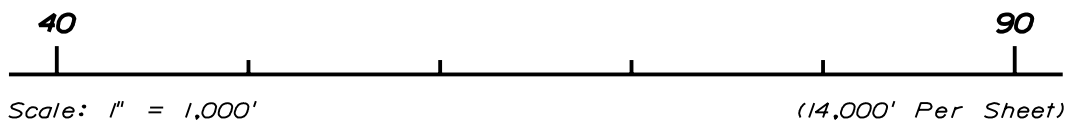
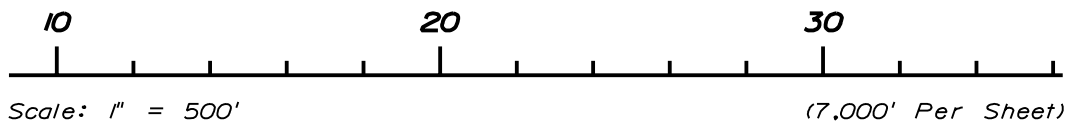
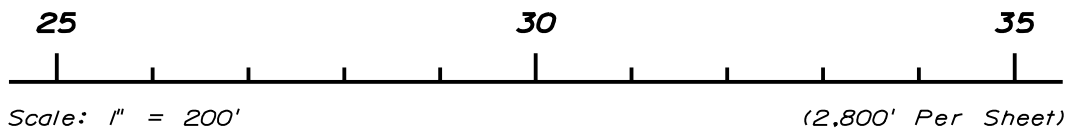
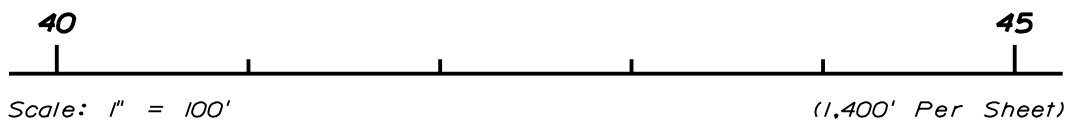
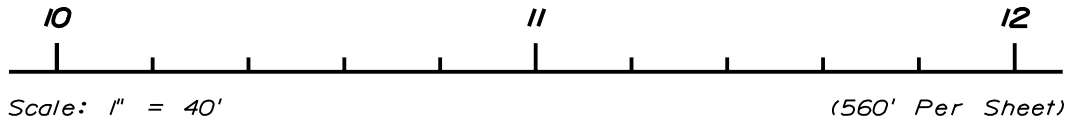

10.2.2 Horizontal Curves

PC and PT points of horizontal curves shall be indicated by small circles. Short radial lines shall be drawn from these points and identified. PI's shall be noted by the use of a small triangle with a short section of tangent on either side. Care must be taken in the clipping of plan sheets to properly orient the horizontal curves within the plan view. In cases where the curve extends over more than one sheet, the curve data shall be repeated on each sheet showing the curve.

Complete curve data shall be shown for each horizontal curve using the following format:

CURVE DATA

- PI (Station)
- Δ (Delta Angle with Direction)
- D (Degree of Curve)
- T (Tangent Length)
- L (Length of Curve)
- R (Radius Length)
- PC (Station)
- PT (Station)
- e (Superelevation Rate)

10.2.3 Existing Topography

All existing topography shall be shown. Existing roads, streets, drives, buildings, underground and overhead utilities, walls, curbs, pavements, fences, railroads, bridges, drainage structures and similar items shall be plotted and labeled. Streams, ponds, lakes, wooded areas, ditches and all other physical features shall also be shown.

All existing utilities shall be shown on the plan and noted by an appropriate symbol (see the ***Design Standards, Index 002*** and the FDOT Engineering/CADD Systems Software for standard symbols). If the type of utility is unknown it should be labeled as such. Existing gasoline storage tanks within limits of topographical survey shall be located and illustrated.

10.2.4 Reference Data

Bearings, in the direction of stationing, shall be shown for all tangent sections.

Station equivalencies, angles with mainline centerline and/or bearings in the direction of stationing of the crossroad shall be shown for all roads and streets intersecting or crossing the project.

All the survey reference points shall be shown (if layout sheet is not included in plans set) at locations removed from the centerline.

If section lines or city limits are encountered within the limits of the project, the intersection shall be tied by station and angle/bearings to the baseline of survey.

10.2.5 Construction and Project Limits

Proposed construction and project limits shall be indicated in the plans. The limits to be flagged and stationed are:

1. Begin and end of project, and begin and end of construction where construction limits are other than project limits. If plans cover more than one project, the limits of each shall be clearly identified by station and Financial Project ID. Limits identification shall be shown both in plan and in profile.

It is the responsibility of the Engineer of Record (EOR) to set the project and construction limits. If the plans cover more than one project or are part of a corridor improvement, the project limits should be at the beginning of the full typical sections, with any construction (transitions, etc.) outside these limits being within the construction limits. Examples of types of work that may fall within construction limits but outside project limits are feathering, friction course, guardrail, drainage work and signing and marking work.

2. The limits of project breakdown necessary for separation of length and quantities for federal aid and non-federal aid projects.
3. The limits of each type of construction classification where more than one type is involved, such as, new construction, resurfacing, bridge work, widening, and milling.
4. The begin and end of exceptions and equations.

10.2.6 Drainage Structures and Bridges

Proposed cross drain pipes and box and three-sided culverts shall be indicated in the plan by a symbol and identified by a drainage structure number. Cross drain pipe sizes and lengths shall be shown. (Box and three-sided culvert lengths shall be shown on the drainage structure sheets).

Box and three-sided culverts (single or multiple) of 20 feet total span or more between inside faces of end supports, measured along the center of the roadway, shall be designated as bridge culverts and shall be identified by both a bridge number and a drainage structure number. The beginning and ending stations (outside wall to outside wall) shall be flagged.

Proposed bridges and approach slabs shall be shown by simple outline. Bridges shall be identified by bridge number and their beginning and ending stations noted by station flags. The beginning and ending stations of approach slabs shall be noted.

A short section of lateral ditch/outfall centerline shall be shown, when appropriate, on the roadway plan-profile sheet, together with a note referring to lateral ditch/outfall sheets for details.

The proposed drainage system is indicated by showing storm sewer pipes with a single line, and the outline of inlets, manholes and junction boxes. The outline of structure bottoms may be shown at the designer's discretion. The pipe size and length between structures shall be given. Structure numbers shall be provided for inlets, manholes, junction boxes and special structures.

10.2.7 Plan Layout

1. Right of way lines shall be shown. Right of way shall be dimensioned only if the applicable typical section shows a varying dimension from the baseline or centerline. Dimensions of the R/W line shall be from the centerline or baseline, if survey and construction lines are parallel; otherwise it shall be dimensioned from the construction centerline.
2. The showing of detailed information regarding median openings or intersections should be avoided when they are of a type that can be detailed and grouped on a separate sheet. When this is the case, median openings and intersections shall be identified by station location.

3. At locations along the alignment where traveled way dimensions change, or begin to change, the station and dimensions of the traveled way shall be shown.
4. Curb, curb and gutter, traffic separators, sidewalks, curb ramps, retaining walls, etc. shall be shown. Driveways shall be shown as required by **Volume I, Section 1.8**.
5. Stations of return points shall be shown in tabular form or shown on the plan, unless shown on an intersection detail sheet. Offsets shall also be shown, if not governed by a typical.
6. Station of radius points of traffic separator or median curb at median openings shall be shown in the plan. Elevation of these points shall also be shown if not shown in the intersection details sheet or unobtainable in plans.
7. Control radii for traffic turns that set median nose locations shall be indicated, unless shown on the intersection detail sheet.
8. Station of end of curb and gutter at side street intersections (when end is not at a return point) shall be shown with proposed gutter grade elevation of these points.
9. Limits of pavement and grading at side street intersections shall be indicated.
10. When incidental construction extends beyond the right of way lines, construction easements or license agreements may be required and should be shown on the plan sheets.
11. Limits of wetlands shall be shown based on permit or regulatory requirements.
12. All utilities shall be shown in the plan. All major utilities that have been field verified (see *Quality Level "A" locates*, **Volume I, Chapter 5**) shall be labeled in accordance with the following symbol:

V_{vh} = Verified Vertical Elevation and Horizontal Location

13. All traffic monitoring sites on or within one-half mile of the project shall be identified with the following notation:

Traffic Monitoring Site Number (XXXX)

Roadway Identifying Number (RCI Section #) Milepost (XX.XXX)

Site includes vehicle detectors in roadway and pedestal, pole or base mounted cabinet, buried cable, and solar power unit on right of way.

Inquiries about monitoring sites should be addressed to the Traffic Data Section Manager of the Transportation Statistics Section, Office of Planning.

10.3 Roadway Profile Portion

10.3.1 General Data

Preformatted plan-profile sheets are located in the FDOT Engineering/CADD Systems Software. The grid portion of each sheet is used for plotting the project profile. The standard grid pattern for the profile portion of the sheet is five lines per inch, both in the horizontal and vertical. This will accommodate most scales. An optional grid with four lines per inch is available. This sheet may be used if approved by the district.

The horizontal scale for the profile portion of the sheet shall be the same as that used for the plan portion. Station limits of the profile shall correspond to those of the plan portion of each sheet. Station numbers shall be placed across the bottom of the sheet just above the title block. Intervals for profile stations shall be the same as those in the plan view.

Vertical elevation datum selected shall be such that the profile will not crowd either the upper or lower limits of the profile format. A general guideline is the vertical scale should be 10% of the horizontal grid. Elevation datum shall be shown on both the left and right sides of the sheet in the space provided adjacent to the grid.

The existing ground line profile shall be shown and labeled. Existing ground line elevations shall be noted vertically, just above the station numbers at each end of the sheet only.

All high water elevations affecting base clearance or roadway grades shall be shown and labeled.

Benchmark data shall normally be given just below the upper margin of the profile portion. However, if space permits, it may be placed in the plan portion just above the upper profile margin at the appropriate corresponding station. Refer to **Exhibit PP-2** for correct format.

Station equations and exceptions shall be shown. Begin and end stations of project, construction, bridge and bridge culverts shall also be shown.

10.3.2 Vertical Alignment

The proposed profile grade shall be shown and labeled. Vertical curve PC's and PT's shall be indicated by small circles and PI's by a small triangle with short sections of tangent shown on each side. Percents of grade to 3 significant decimal places shall be shown on the tangent line (trailing zeros need not be shown). Vertical lines shall be extended from the PC and PT points and a dimension line placed between these lines indicating the length of the vertical curve. The PC and PT stations and elevations shall be indicated on the vertical lines.

For vertical curves, the profile grade elevations shall be given on even stations and at appropriate intervals. The elevations shall be placed between the dimension line and the grade line. The curve length, dimension lines and the profile grade elevations shall be placed above the grade line for sag vertical curves and below the grade line for crest vertical curves. The dimensions and elevations shall be placed reasonably near the grade line whenever possible. The PI station and elevation shall be noted, lettered vertically above the PI symbol for crest curves and below for sag curves.

The profile grade elevation of the beginning and ending station of each sheet shall be shown vertically just above the grade line, except when the beginning or ending station on the sheet is on a vertical curve.

10.3.3 Grades

Percents of grades to 3 decimal places shall be indicated for each tangent section on every sheet (trailing zeros need not be shown). When two tangent grades intersect and no vertical curve is required the PI station and elevation shall be labeled vertically, using the same criteria as for vertical curves.

10.3.4 Superelevation and Special Profiles

For non-standard superelevated sections of the project, the begin and end superelevation stations should be indicated on the profile with a note:

"For Superelevation details see Special Profiles Sheet"

Other special profiles that cannot be clearly shown on the plan-profile sheets shall be referenced in a similar manner to non-standard superelevated sections. For additional information regarding special profiles see **Chapter 11** of this volume.

10.3.5 Other Profile Features

For rural construction projects, special ditches shall be indicated in the profile and labeled. Percent of ditch grade and a beginning or ending ditch PI with elevation and station plus shall be shown. For multi-lane divided projects, three special ditch grades (right and left roadway ditches and median ditch) sometimes occur at the same location. In such cases it may be advantageous to show the median ditch at a convenient location on the sheet with a separate elevation datum.

Uniform ditches of non-standard depth should be indicated by a dimension line in the lower portion of the grid and noted as a special ditch with location and depth, or they should be indicated by flagging the DPI's at each end with station elevation and side. Standard depth ditches are not shown.

Special gutter grades shall be shown in profile for cases where the gutter grades are not controlled by the typical section and no "special profiles" are included in the plans set.

Prolongations of gutter profile grades across street intersections shall be included on plan-profile sheets if an inlet is not provided before the intersection.

Storm sewer pipe, inlets and manholes along the main line shall be shown. Pipes shall be noted by size. Proposed structures may be shown by structure number only. Flow line elevations shall be shown for all pipes entering and leaving the structure.

Proposed cross drain pipes and culverts shall be plotted. The section shall be shown at the correct location and elevation of the proposed structure crossing the centerline of construction. Cross drains shall be identified by structure number only.

Where the project overpasses a road or railroad, the cross section template of the road/railroad under the bridge shall be shown at the appropriate location in profile.

Except for transverse utilities, no underground utilities shall be shown in profile.

THIS PAGE LEFT BLANK INTENTIONALLY

10.4 General Notes for Roadway Plan and Roadway Plan-Profile Sheets

General notes for the project shall be placed on the left portion of the first plan-profile sheet if a project layout sheet is not included in the plans set, otherwise, they shall be included on the layout sheet. See ***Exhibit 10-1*** for a list of General Notes required.

Exhibit 10-1 General Notes for Roadway Plan and Roadway Plan-Profile Sheets

1. (The bench mark datum used for the plans (whether NGVD 29, NAVD 88 or other) shall be noted in the first General Note.)
2. Buildings to be removed by others, unless otherwise noted.
3. Existing drainage structures within construction limits shall (be removed/remain) unless otherwise noted.
4. (When there are no utility adjustment sheets in the plans, the notes shown in **Exhibit 20-1** shall be included here as part of the general notes).
5. (If there are no drainage structure sheets in the plans, the following notes shall be included in the general notes, if applicable):
 - a. Special attention is directed to the fact that portions of some drainage structures extend into the stabilized portion of the roadbed and extreme caution will be necessary in stabilization operations at these locations.
 - b. All drainage structures have optional materials. The Optional Materials Tabulation Sheet(s) shows all materials allowed as well as indicating which material is plotted on these sheets and used as the basis for pay quantities.
6. Any public land corner within the limits of construction is to be protected. If a corner monument is in danger of being destroyed and has not been properly referenced, the Engineer should notify the District Location Surveyor, without delay, by telephone.
7. Existing driveways within the limits of this project are to be replaced at the same location and width, unless otherwise shown in the plans.

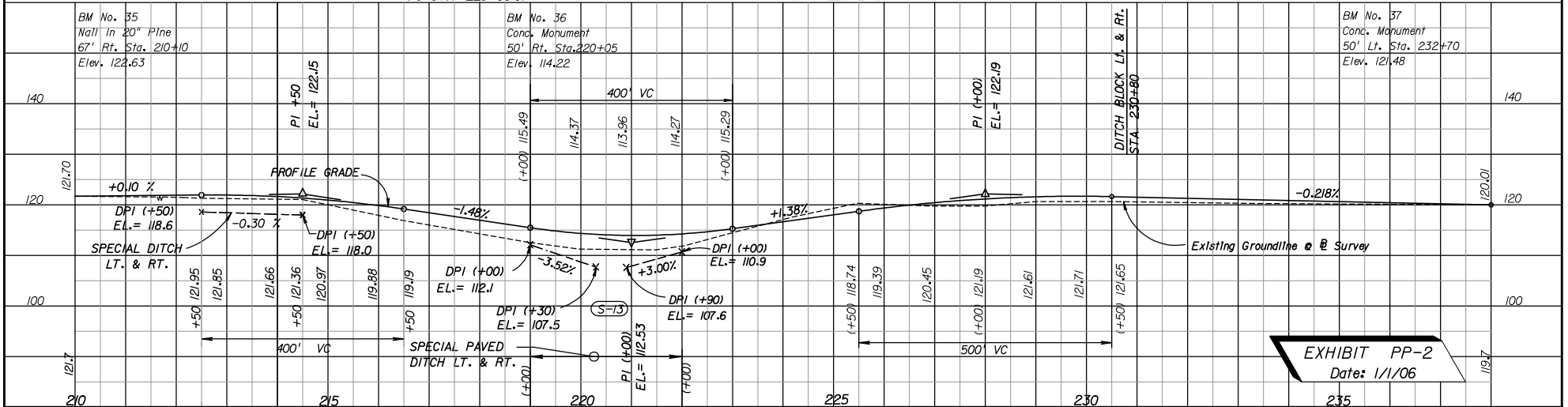
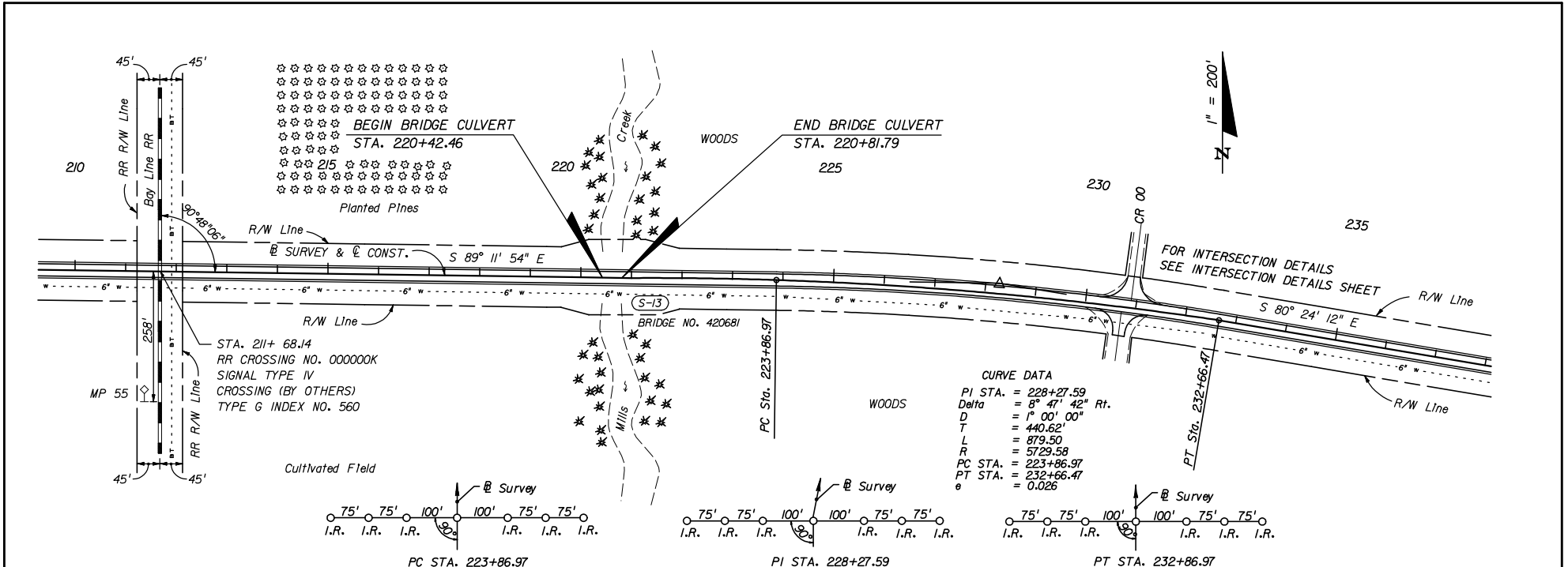

REVISIONS			
DATE	BY	DESCRIPTION	DESCRIPTION

STATE OF FLORIDA DEPARTMENT OF TRANSPORTATION			PLAN & PROFILE	SHEET NO.
ROAD NO.	COUNTY	FINANCIAL PROJECT ID		

EXHIBIT PP-2
Date: 1/1/06

Chapter 11

Special Profiles

11.1	General	11-1
11.2	Intersections.....	11-1
11.3	Curb Returns.....	11-2
11.4	Ramps.....	11-3
11.5	Spline Grade	11-4
11.6	Superelevation	11-5
11.7	At-Grade Railroad Crossings	11-6

THIS PAGE LEFT BLANK INTENTIONALLY

Chapter 11

Special Profiles

11.1 General

The special profiles sheet shows profiles of pavement edges or gutter flow lines. Special profiles occur at street intersections, ramp termini, curb returns, railroad crossings and roadway or bridge sections requiring special superelevation details. Vertical transitions between roadways and bridges may also require special profiling. All of these areas require special analysis and design to ensure a safe, efficient, well drained, and smooth roadway/bridge system. The special profiles sheet shall show details at close intervals and at a scale large enough to clearly identify all construction details within these areas.

11.2 Intersections

In addition to normal profile grade lines, supplemental profiles and sections at intersections may be necessary to define edge of pavement profiles. Sections showing pavement surface elevations shall be shown for nose points and other critical locations. It is important to develop accurate profiles and sections at locations of curbed channelization to ensure proper drainage.

When plan-profile format is used for intersection details, the profile's horizontal scale shall be the same as that for the plan portion. A vertical scale of 1" = 2' for the profile portion is recommended as it enables intermediate elevations to be determined from the profile with reasonable accuracy. The existing ground line and/or curb line shall be as called for in the **FDOT CADD Production Criteria Handbook**.

For intersections detailed on a plan only format, the profile and sections shall be shown on a separate grid sheet. The standard cross section sheet, available in the FDOT Engineering/CADD Systems Software, should be used. This sheet features a standard grid of five lines per inch, both in the vertical and horizontal. The vertical scale can be altered to ten lines per inch by utilizing a toggle feature in the CADD software.

For street intersections of municipal projects, a scale of 1" = 20' horizontally and 1" = 2' vertically, or 1" = 50' horizontally and 1" = 5' vertically is recommended.

11.3 Curb Returns

Curb return profiles show the profiles of the gutter flow line from the PC to the PT point of the return at an intersection.

Curb return profiles shall be shown on a grid format. They shall be included in the plans set if the required information cannot clearly be shown on the plan-profile sheet or intersection detail sheet, or if extreme grades are involved, rendering the standard curb return profiles (***Index 303*** of the ***Design Standards***) inadequate.

Standard scale used should be 1" = 20' horizontally and 1" = 2' vertically. Other scales may be used provided all construction details are clearly and legibly shown. Each return profile shall be identified and its PC and PT stations shown. Elevations should be shown at appropriate intervals and low and high spots shall be identified by location and elevation.

11.4 Ramps

Ramp profile grades shall be developed along the baseline of each ramp. A profile of the edge of the pavement opposite the baseline shall also be shown. These profiles shall be shown on a grid format. Data required to be shown shall be similar to that required for roadway profile (**Chapter 10** of this volume).

Recommended scales for ramp profiles are: 1" = 20' horizontally and 1" = 2' vertically, or 1" = 40' or 50' horizontally and 1" = 4' or 5' vertically.

Sections at nose points are required. They may be shown using a scale of 1" = 20' horizontally and 1" = 2' vertically.

11.5 Spline Grade

Intersections of ramp pavement with mainline pavement and other sections of pavement within special superelevated zones need special attention, not only during the design phase of the project, but also during construction. Hence, all construction details pertaining to these areas should be clearly and accurately shown in the plans.

Spline grades are often used to show the interconnection and interrelation of the edges of pavement with the mainline edge of pavement. This profile proves to be especially helpful if the mainline pavement is superelevated or within the superelevation transition zone.

A spline grade shall show the elevations at intervals of 20 to 100 feet, depending on the scale. Elevations shall be shown for the outer edge of mainline pavement and inner and outer edges of the ramp pavement at the nose areas.

Grades of the three pavement edges shall be shown on a grid format. Recommended scales are: 1"=20' horizontally, 1"=2' vertically, or 1"= 40' or 50' horizontally and 1"= 4' or 5' vertically.

Grades of each pavement edge shall be joined by smooth splines or simple curves. The three grade profiles shall be clearly labeled and all equality stations indicated. Nose stations shall be flagged and labeled. Scale shall be indicated in close proximity of the profile and shall be clearly visible.

11.6 Superelevation

The standard superelevation details (***Indexes 510*** and ***511*** of the ***Design Standards***) may be used for projects which include simple curves. For projects which include reverse curves, or compound curves, or any other situation requiring special superelevation not covered in the standards, the superelevation diagram shall be shown in the plans. Special profile details may be used to design superelevation on multilane facilities, when a simple diagram will not be sufficient.

Complete profile grade line and right and left edges of pavement within the superelevation zone shall be shown on the grid format. A scale of 1"= 20' horizontally and 1"= 2' vertically is recommended for clarity. The begin and end superelevation stations shall be labeled and indicated by a solid vertical line at the appropriate station. A horizontal dimension line shall be utilized to indicate a section in full superelevation.

11.7 At-Grade Railroad Crossings

In addition to normal profile grade lines, supplemental profiles for at-grade railroad crossings may be necessary to define lane lines, edges of pavement, and/or gutter flow lines. It is important to develop accurate profiles to ensure proper drainage.

For at-grade railroad crossings that cannot be adequately detailed on the plan-profile sheets, the profiles shall be shown on a separate grid format. A horizontal scale of 1" = 20' and a vertical scale of 1" = 2' are recommended.

Chapter 12

Back-of-Sidewalk Profiles

12.1	General	12-1
12.2	Sheet Setup	12-2
12.3	Required Information.....	12-3

THIS PAGE LEFT BLANK INTENTIONALLY

Chapter 12

Back-of-Sidewalk Profiles

12.1 General

Back-of-sidewalk profiles are used to establish the profile grade and therefore play an important role in plan preparation, especially if the project site is located in a built-up urban area. Profiles help ensure the constructability of the project within the right of way without excessive disturbance or rework of adjoining properties. Back-of-sidewalk profiles are also used for checking of stormwater trapped behind the sidewalks and as a major input for establishing centerline grade profiles.

Grades shown on this sheet are at the back of the proposed sidewalk, and grades shown on roadway plan-profile sheets are at the profile grade line (PGL) denoted on the typical section.

The inclusion of the back-of-sidewalk profiles in the plans set is optional - at the discretion of the district. Work sheets may be required with phase reviews.

12.2 Sheet Setup

Back-of-sidewalk profiles shall be prepared on standard cross section format. For simple projects which do not involve many cross streets or driveways, the sheet may be divided horizontally to maximize usage. Stationing shall progress from left to right and multiple profile views shall be stacked from top to bottom. Match lines shall be stationed. Care should be taken to preserve clarity and legibility.

12.3 Required Information

Profiles for use in establishing back-of-sidewalk grades consist of existing profiles along the back edge of each proposed sidewalk. The existing profiles shall be shown so as to distinguish between the profiles for the right and left sidewalk, and in accordance with the ***FDOT CADD Production Criteria Handbook***.

The standard scales are 1" = 100' horizontally and 1" = 5' vertically. This combination works well for projects having few locations where back-of-sidewalk grades would be critical. It may be advantageous to use a vertical scale of 1" = 2' and a horizontal scale of 1" = 50' for projects located in business and commercial areas, or where greater clarity is required. Elevation datum shall be shown on both sides of the sheet, with station numbers below the profile.

Limits of existing pavement, such as parking areas and drives, which should be matched as closely as possible, shall be identified on all sidewalk profiles. The centerline for each intersecting street and driveway shall be indicated with a vertical line at the proper station and the street name and station noted. Intersecting streets and driveways on the right shall be shown below the profile, and those on the left above the profile.

At each station, as well as locations of significant drainage, arrows shall be drawn to indicate the slope of ground at the outer edges of the sidewalk.

Drainage arrows shall be placed below the profile line for the right profile and above the profile line for the left profile. Arrows pointing outwards from the profile indicate drainage away from the project, while arrows pointing inwards indicate drainage to the project.

Floor elevations for buildings shall be indicated by a horizontal line drawn at the floor elevation between the building limits. The numeric elevation shall be shown, as well as the offset (distance and side) from centerline of project to the face of the building. Entrances to buildings, elevations of top of existing major utilities (as defined in ***Chapter 5 of Volume I***), and water table elevation may be shown when appropriate.

Once the proposed back-of-sidewalk profile has been developed, percents of grade, PI stations and elevations shall be shown. Vertical curves, if any, shall be dimensioned. Elevations along vertical curves are not required. Stations for begin and end project, exceptions, and back-of-sidewalk special profiles shall be flagged and labeled. Mainline station equations within the limits of the sidewalk profile shall also be flagged and labeled.

The difference in elevation between the profile grade and back-of-sidewalk profile grade shall be noted on the sheet. Superelevation notes, if applicable, shall also be noted on the sheet.

Chapter 13

Intersection and Interchange Details/Layouts

13.1	General	13-1
13.2	Intersections.....	13-2
13.3	Interchanges	13-3
13.3.1	Geometric Layout.....	13-3
13.3.2	Ramp Terminal Details.....	13-5
13.3.3	Cross Section Pattern Sheet.....	13-6
Figures		
Figure 13.1	Interchange Layout	13-4

THIS PAGE LEFT BLANK INTENTIONALLY

Chapter 13

Intersection and Interchange Details/Layouts

13.1 General

These sheets provide layouts and details for intersections and interchanges, with consideration for turning and weaving movements of vehicular traffic. For a safe and efficient roadway system (including provisions for bicycles and pedestrians), these areas must be designed with special attention to channelization, turning movements, signalization, drainage and vertical alignment. The various design details shall be shown explicitly for accurate construction.

Intersection and interchange layout sheets shall show all necessary details and geometric controls/access management features, including channelization, tapers, turn lanes, special drainage, and grading. The sheets shall be prepared on a standard plan format using a scale large enough to show details clearly and legibly.

13.2 Intersections

Intersection details shall be shown on separate plan sheet format if they cannot be shown clearly on the plan-profile sheet format.

In cases of simple, nonsignalized intersections covering relatively small areas, regular plan-profile format may be used. The intersection layout shall be placed, using an appropriate scale, in the plan portion, and the necessary profile grades in the profile portion.

For larger, more complicated intersections involving channelization, signalization or tapered connections, the layout shall be placed on a standard plan format. Match lines should be used when more than one sheet is required.

The profiles shall be presented separately on a grid format. (See **Chapter 11 - Special Profiles**).

Existing topography need not be shown on these details if it is shown elsewhere in the plans. Information given is generally the same as in the plan portion. Pavement edges, R/W lines, curb and gutter, channelizing and median curbs, driveways, drainage structures, pavement dimensions, radii and appropriate notes shall be included.

All intersection layouts shall be dimensioned, stationed adequately, and shall include all pertinent construction notes and alignment data. Design speed data shall be given when appropriate. Widths of turning lanes and turning paths shall be checked for possible encroachments or conflicts.

A north arrow and scale shall be shown at a point of maximum visibility on the plan. The scale used shall be sufficient to cover all necessary details, preferably 1" = 40'. The scale shall not be smaller than 1" = 50'.

13.3 Interchanges

13.3.1 Geometric Layout

Interchange layouts shall be prepared on a standard plan format. The entire interchange shall be placed on one sheet when possible, using a scale not smaller than 1" = 400'. In cases of large cloverleaf or directional interchanges, more than one sheet may be required. Appropriate match lines shall be shown.

Layouts shall be dimensioned and completely stationed, with all alignment data and construction notes included. All curves shall be assigned a number and curve data presented in a tabular form. It is preferred that the tabular curve and coordinate data be placed on the same sheet as the interchange layout.

Interchange ramps shall be identified by the use of letters or a combination of letters and numbers. The recommended practice for assigning ramp names is as follows:

1. Ramps in the first left quadrant along mainline stationing should be assigned first. Name assignments shall progress in a counterclockwise direction around the interchange (see **Figure 13.1**). For projects with two or more interchanges, continue name assignments with the next letter and in same counter clockwise direction noted above.
2. Ramp baselines are usually located on the right edge of the pavement with relation to the direction of traffic, and shall be clearly indicated. Stationing of ramps should be in the same direction as the project.

Figure 13.1 Interchange Layout

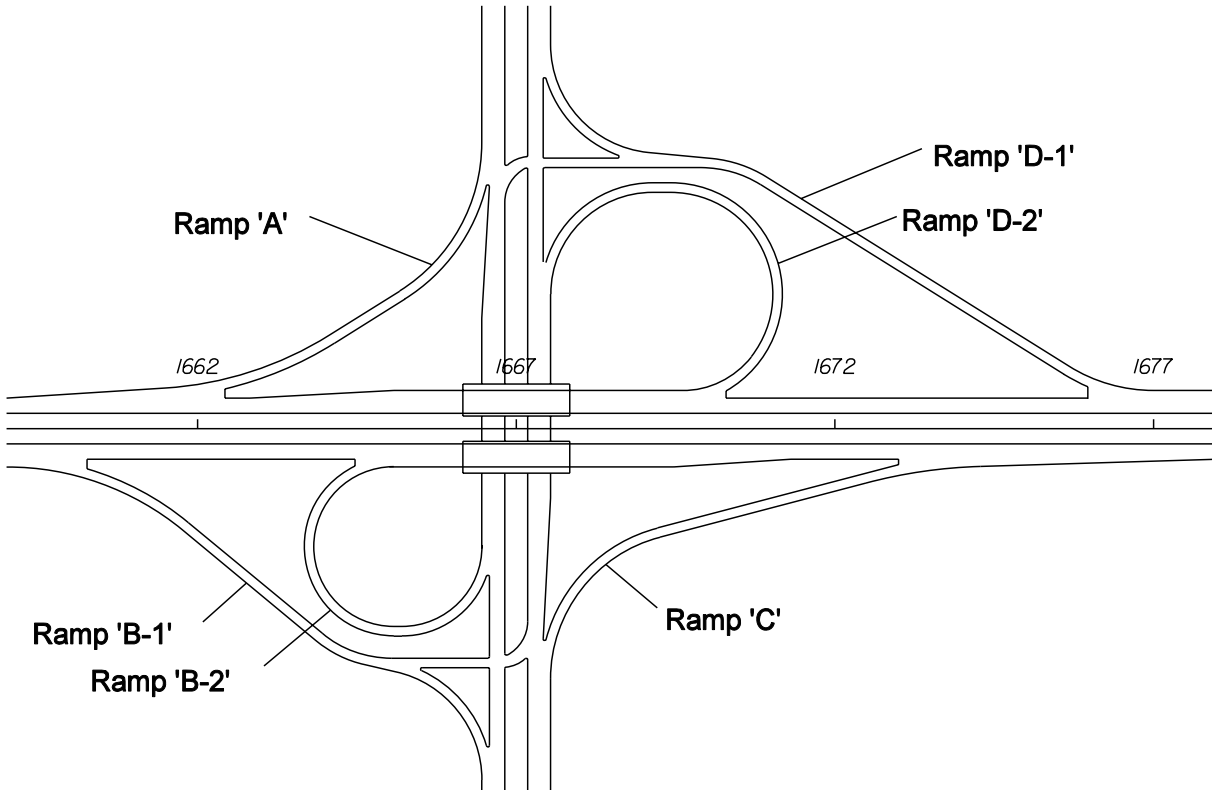

A topographic worksheet for all interchanges is required and will be considered as the preliminary layout of the interchange. This worksheet shall be prepared on a standard plan format on a scale not smaller than 1" = 400'. The following information shall be shown:

1. All topography, such as existing roads, property lines, utilities, buildings, driveways, etc.
2. Preliminary interchange geometrics and proposed right of way limits.
3. Drainage right of way and easements.
4. Proposed reconstruction of the crossroad, and all access roads and frontage roads within the interchange.
5. Frontage roads should be assigned a unique alpha or numeric designation to avoid confusion with ramp nomenclature.
6. Contours, unless the terrain is relatively flat.
7. Traffic diagram with AADT, DHV, K, D and T values.
8. The length of speed change lanes.

9. Design speed for ramps and crossroads.
10. Proposed bridge limits.
11. Pavement transitions.
12. Limits of construction along the crossroad.

The contract plans set shall include the following interchange sheets:

1. Interchange geometric layout.
2. Interchange drainage map.
3. Interchange topographic map.
4. Interchange cross section pattern sheet.
5. Ramp terminal details.
6. Ramp cross sections.

13.3.2 Ramp Terminal Details

Details of ramp terminals with mainline and crossroads shall be shown on separate plan sheets. The scale used shall not be smaller than 1" = 50'. Standard scale 1" = 40' is preferred. Complete details of the terminal shall be shown including:

1. Curve data.
2. Station equality and horizontal tie to mainline or crossroad at critical ramp locations.
3. Turning radii, taper/transition lengths, curb/curb and gutter (if any).
4. Channelization (if any).
5. Ramp and crossroad intersection station and angle.
6. Median nose data (if any).
7. Limits of construction.
8. R/W.
9. Limited Access R/W and fence location.
10. Drainage structures.
11. Spot elevations (as needed).
12. Roadway dimensions.
13. Station pluses and offsets.

13.3.3 Cross Section Pattern Sheet

The cross section pattern sheet shows the entire interchange layout including frontage and access roads, if any, with location and extent of proposed cross sections. This information is of special importance for projects involving new interchanges located in rural, undeveloped areas. Information to be shown shall include:

1. North arrow and scale.
2. Interchange layout.
3. Access and frontage roads (if any).
4. Centerline construction and baseline survey.
5. Ramp base lines.
6. Stationing along mainline, crossroads, ramps, access and frontage roads.
7. PC and PT points by symbol.
8. Bridge outline.
9. Cross section pattern.

This sheet shall be prepared on a standard plan format. The scale shall be such that the complete interchange is shown on one plan sheet, with care taken to ensure clarity and legibility. Normal scale is 1" = 400'. North arrow and scale shall be located at a point of maximum visibility.

Chapter 14

Drainage Structures

14.1	General	14-1
14.2	Required Information.....	14-1
14.3	Utility Conflicts.....	14-3
14.4	Sheet Setup	14-3
Exhibits		
Exhibit 14-1	Drainage Structure Notes	14-4

THIS PAGE LEFT BLANK INTENTIONALLY

Chapter 14

Drainage Structures

14.1 General

Drainage structure sheets show the drainage structures, their location, cross section, flow line elevations of all weirs or slots, top of grates, culverts and top of manhole elevations, and similar data. Drainage structure sheets also show the vertical relationships of the entire drainage system. During the process of design/placement of the drainage structures, potential conflicts with existing or proposed utilities shall be identified and resolved early, thereby avoiding costly time delays during the construction phases.

All projects require the plotting of drainage structures. When only cross drains are to be constructed or modified, drainage structures may be plotted on the cross section sheets. Otherwise drainage structures should be plotted on separate drainage structure sheets, utilizing the cross section sheet cell available in the FDOT Engineering/CADD Systems Software (see *Exhibit DS-2*). See *Chapter 22* for additional requirements for box and three-sided culverts utilized as drainage structures.

14.2 Required Information

The existing ground line for rural projects shall be shown at the location of the structure, with the existing elevation placed immediately below the ground line at the survey baseline. No existing structures shall be shown except those to be incorporated into the proposed drainage system or otherwise modified. These shall be shown and their flow line elevations noted. Where storm sewers run laterally or diagonally across the project, the drawing should show the pipe cover.

The roadway template and proposed structures shall be shown, with the proposed profile grade elevation placed above the grade point. The structure shall be located by station and offset to the centerline of construction. Flow line information shall be provided at each structure and at each culvert end. Structures are to be plotted in detail according to the applicable index of the *Design Standards*, with walls, grates, tops, pipes, etc. shown.

Cross drain sections shall include the size and length for each proposed structure.

Sections for skewed cross drains shall be depicted along the centerline of the structure. Clear zone distances are to be measured at right angles to the traffic lane for all structures.

All structure locations should be checked and R/W shown where the R/W may have potential impact on construction of a structure.

For each drainage structure, all necessary information shall be shown by note, including, as appropriate: size, end treatment and flow lines, as well as structure, index and station number. The note shall be placed as close to the structure as possible, preferably below the plotted structure. Elevations shall be given for manhole tops, and ditch bottom inlet grates and slots. Grate elevations for shoulder gutter and edge of pavement elevations for curb and gutter inlets shall be shown.

Alternate "G" or other special grate treatment shall be included with the inlet note. Additional details, such as special bedding, 36" manhole rings, etc., shall be indicated. Flow direction arrows shall be shown.

Material options shall be shown on the Optional Materials Tabulation Sheet. (See **Exhibits SDS-2a** and **SDS-3a** at the back of **Chapter 8** of this volume).

If existing structures are to be filled and/or plugged and are to remain in place, they should be shown in the plans with an appropriate note.

Applicable notes to be shown on the first drainage structure sheet are given in **Exhibit 14-1**.

14.3 Utility Conflicts

All major underground utilities, as defined in **Chapter 5** of **Volume I**, shall be plotted in conjunction with the structures so that conflicts may be detected during design, and to alert construction forces of potential conflicts.

In the case of longitudinal pipes, a section should be plotted for each location of a crossing of any major underground line.

Utilities that have been verified (Quality Level "A" locate) shall be noted and plotted to scale in the appropriate locations on the Drainage Structure Sheets, Cross Section Sheets and bridge foundation plans. These utilities should be labeled with the following symbol:

V_{vh} = Verified Vertical Elevation and Horizontal Location

14.4 Sheet Setup

Structures should be plotted as sections along the centerline of the structure. They should be shown on a standard cross section format with the sections spaced sufficiently apart to avoid overlapping of structures or notes. Beginning at the bottom of the sheet, the sections should be shown successively by stations and should be numbered sequentially, from the beginning to the end of the project. The structure number and location station should be shown near the right border of the sheet.

If a structure must be shown out of order, a note shall be placed in the correct sequence, referring to the sheet where the structure is shown. The scale shall be the same as that used for roadway cross sections, with the centerline of construction placed near the center of the sheet.

Exhibit 14-1 Drainage Structure Notes

These notes, when required, are to be placed on the first drainage structure sheet.

1. Special attention is directed to the fact that portions of some drainage structures extend into the stabilized portion of the roadbed and extreme caution will be necessary in stabilization operations at these locations.
2. All drainage structures have optional materials. The Optional Materials Tabulation Sheet(s) shows all materials allowed as well as indicating which material is plotted on these sheets and used as the basis for pay quantities.

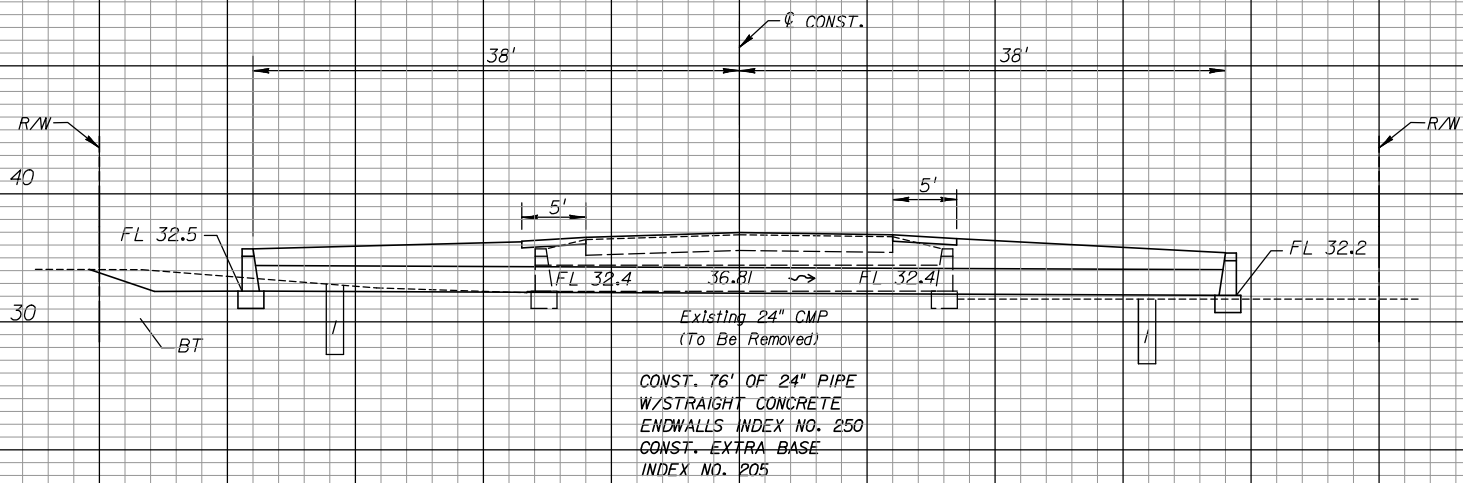

116+24.16
S-14

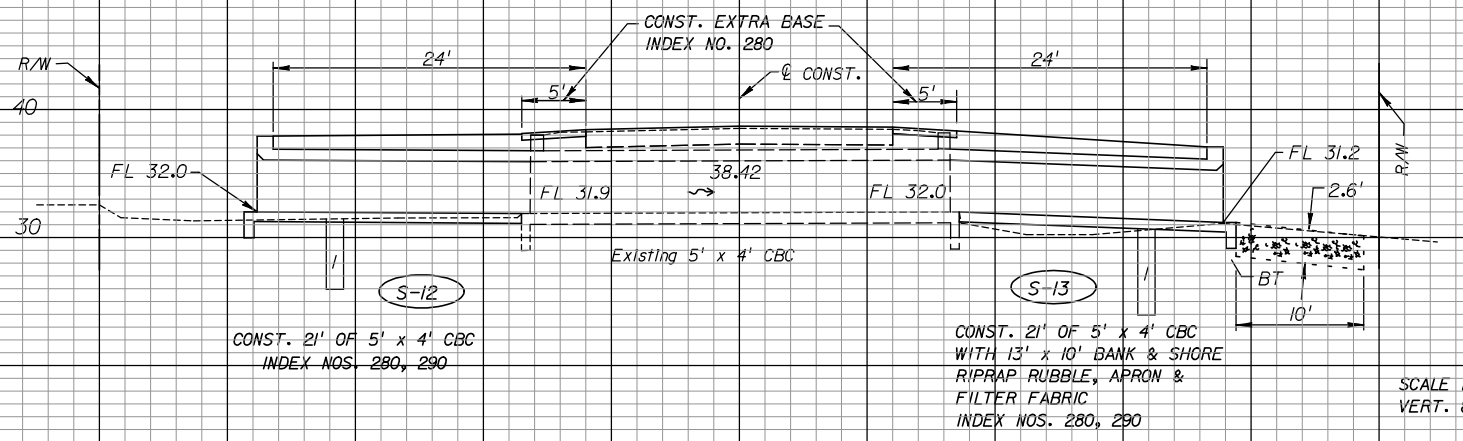

98+17.28
S-13
S-12

SCALE 1" = 10'
VERT. & HORIZ.

EXHIBIT DS-2
Date: 1/1/06

DATE		BY		DESCRIPTION	

STATE OF FLORIDA DEPARTMENT OF TRANSPORTATION		
ROAD NO.	COUNTY	FINANCIAL PROJECT ID

DRAINAGE STRUCTURES

SHEET NO.

Chapter 15

Lateral Ditch/Outfalls, Retention/Detention and Mitigation Areas

15.1	General	15-1
15.2	Lateral Ditch/Outfall.....	15-2
15.2.1	Plan Portion	15-2
15.2.2	Profile Portion	15-2
15.2.3	Typical Section.....	15-3
15.2.4	Ditch Cross Sections.....	15-3
15.3	Retention or Detention Areas.....	15-4
15.3.1	Pond Detail Sheet	15-4
15.3.2	Typical Section.....	15-5
15.3.3	Pond Cross Sections	15-5
15.4	Mitigation Areas	15-6

THIS PAGE LEFT BLANK INTENTIONALLY

Chapter 15

Lateral Ditch/Outfalls, Retention/Detention and Mitigation Areas

15.1 General

Drainage systems that convey stormwater from the roadway may be made up of many components such as inlets, manholes, pipes, ditches, and retention/detention areas. Usually, these systems require additional right of way and/or easements.

Mitigation areas, although not usually a component of the highway drainage system, may have drainage components in them.

If space permits, drainage components adjacent to the roadway may be shown on the roadway plan-profile sheets. Drainage components not adjacent to the roadway may require separate plan view sheets. In either case, profile views and/or cross sections may also be needed to provide enough detail to construct the components.

Plans for drainage components can generally be grouped into three categories:

1. Lateral ditch/outfalls
2. Retention/detention areas
3. Mitigation areas

15.2 Lateral Ditch/Outfall

Lateral ditch plans and profiles shall be prepared on a standard plan-profile format using a horizontal scale of 1" = 100'. However, if storm drain construction is proposed for a portion of the ditch, a scale of 1" = 40' or 1" = 50' may be used.

15.2.1 Plan Portion

Data presentation in the plan portion shall be oriented so that the lateral ditch/outfall centerline is parallel to the long side of the sheet. Information shall be shown in a manner similar to that described in **Chapter 10, Roadway Plan and Roadway Plan-Profile**.

Right of way (or easement) alignment data and topography shall be shown in the plan portion. An alignment tie between the lateral ditch/outfall and the project shall also be shown. The north arrow and scale shall be placed at the proper location on the sheet (refer to **Chapter 10** of this volume).

15.2.2 Profile Portion

The profile portion shall be prepared in the same manner as the profile portion of the roadway plan-profile sheets (**Chapter 10**). Existing ground line profiles, high water elevations, underground utilities, benchmark information and elevation datum shall be shown as described for roadway plan-profiles.

Where the lateral ditch/outfall survey baseline does not follow the flow line of the existing ditch or channel, the existing ditch or channel profile shall be shown with a broken line and identified.

If storm drain construction is proposed along a lateral ditch/outfall, the proposed structures shall be plotted on the drainage structures sheets, or in the lateral ditch/outfall profile. Structures shown in the profile will include flow line, structure numbers, pipe or culvert sizes, and utilities (if applicable).

The normal water elevation of the receiving system shall be indicated and labeled.

15.2.3 Typical Section

A typical section showing the width of proposed clearing and grubbing, right of way, ditch bottom width and side slopes shall be shown on the lateral ditch plan and profile sheet. This section does not need to be to scale, but shall be dimensionally proportionate. If the width of clearing and grubbing is variable for a lateral ditch/outfall, the various widths and their respective station limits shall be noted below the typical section.

15.2.4 Ditch Cross Sections

Lateral ditch cross section sheets are included in the plans. These sheets show the right of way required, the extent of clearing and grubbing required and the amount of earthwork.

Lateral ditch cross sections shall be prepared in a manner similar to that of roadway cross sections (**Chapter 18** of this volume). The scale, generally, should be 1" = 10', vertical and horizontal. Regardless of the horizontal scale used, the vertical scale shall always be 1" = 10'.

Often it is possible to place two or more columns of ditch cross sections on one sheet. They shall be plotted with the stationing progressing from the bottom of the sheet to the top, and the columns shall be placed from left to right.

Usually, soil surveys are made along the lateral ditch only when a large amount of material is expected to be excavated.

Guidance given in **Roadway Cross Sections (Chapter 18)** shall be applicable equally to lateral ditch cross sections.

15.3 Retention or Detention Areas

15.3.1 Pond Detail Sheet

The retention or detention pond, including the outlet structure, is usually the end point of the drainage system for a particular project. The retention/detention pond detail sheet shall show the pond in plan view, with station and offset ties to the project centerline of construction. The plan view shall also include the following:

1. Locations of pond sections.
2. Side slopes and base dimensions.
3. Bottom and top elevations.
4. Location of maintenance berm.
5. Fence and gate locations.
6. Right of way.
7. Pond drainage structures with structure numbers.
8. Soil boring locations, and
9. Any other necessary data pertaining to the pond.

The pond sections shall show the bottom width and elevation, side slopes, normal water depth, if applicable, as well as soil borings. A minimum of two (2) sections, taken in directions perpendicular to each other, shall be shown.

15.3.2 Typical Section

A typical section is required when the pond sections do not represent the *typical* design features of the pond. Following is a list of appropriate information to be shown on the typical section:

1. Limits of clearing and grubbing
2. Typical side slopes
3. Bottom and top elevations
4. Details of maintenance berm
5. Fence location
6. Right of way
7. Water level information
8. Vegetation requirements

The typical section does not need to be to scale, but shall be dimensionally proportionate. It should be shown on the pond detail sheet, if room allows, or on a separate sheet when necessary.

15.3.3 Pond Cross Sections

Pond cross sections shall be prepared in a manner similar to that for roadway cross sections (**Chapter 18** of this volume). As with lateral ditches, the standard scale is 1" = 10' vertical. The standard horizontal scale is also 1" = 10', although another scale may be used if necessary.

If material is to be excavated from the pond the data from the soil survey sheet shall be shown on the cross sections.

Guidance given in **Roadway Cross Sections (Chapter 18)** shall be applicable to pond cross sections.

15.4 Mitigation Areas

If construction details for mitigation areas are included in the plans, follow the requirements for retention/detention areas.

Chapter 16

Special Details

16.1 General16-1

THIS PAGE LEFT BLANK INTENTIONALLY

Chapter 16

Special Details

16.1 General

Special details sheets are usually included in the plans set if the project contains areas that require special attention to some construction elements. Construction details that are not covered in the ***Design Standards*** booklet or elsewhere in the plans set shall be shown on the special details sheet.

This sheet shall be prepared on a standard plan format. Any convenient scale may be used, provided the information shown is clear and legible. Details shown shall be clear, legible, labeled, completed in all respects and should be adequately cross-referenced in the plans set.

THIS PAGE LEFT BLANK INTENTIONALLY

Chapter 17

Soil Survey

17.1	General	17-1
17.2	Roadway Soil Survey	17-2
	17.2.1 Method of Compilation and Presentation	17-2
17.3	Other Soil Surveys	17-3

THIS PAGE LEFT BLANK INTENTIONALLY

Chapter 17

Soil Survey

17.1 General

The soil survey sheet, essentially a soil test analysis sheet, depicts the various types of soils encountered within the limits of the project. This sheet also shows the classification, mechanical properties and recommended usage of those soils. A preformatted CADD sheet can be found in the FDOT Engineering/CADD Systems Software.

Soils having identical characteristics shall be assigned to the same stratum and group for identification and recommendation purposes. The test analysis sheet shall be signed by the responsible Engineer.

17.2 Roadway Soil Survey

17.2.1 Method of Compilation and Presentation

Upon completion of the proposed typical section, and after placing alignment, proposed grades and existing utilities on the plan-profile sheets and preliminary sections, prints of these sheets shall be utilized for determining the location and depth of borings for the sampling of soils for testing and classifications. These classification and test results, including pH, resistivity, sulfides and chlorides shall be shown on the test analysis sheet. Date and weather conditions at the time of sampling shall also be shown. Refer to **Exhibit SS-1** for an example of soil survey sheet.

After completion of soils testing, the boring data shall be shown on cross sections by columns approximately 1/4 inch wide below the ground line at test sample locations. Stratum limits and numbers shall be shown inside the column. This information shall be transmitted to the appropriate responsible materials engineer for verification. One hard copy of the soils information, including cross sections with soils information, shall be retained in the Soils Engineer's Record.

17.3 Other Soil Surveys

Soil surveys other than those for roadway plans are required for various plans components. Included in these are soil surveys/borings for retention/detention ponds, overhead sign structures, high mast poles and traffic signal mast arms.

Soil survey sheets generated for such components are generally located in the plans set with the other details and information for each component. Requirements for the soil survey sheets are similar to those prepared for the roadway soil survey, showing such things as the location of test holes, various strata encountered, soil properties, classification and recommended usage.

THIS PAGE LEFT BLANK INTENTIONALLY

STATE OF FLORIDA
DEPARTMENT OF TRANSPORTATION
MATERIALS AND RESEARCH

DATE OF SURVEY : 2/15/95 -5/1/95
SURVEY MADE BY : HARTFORD TESTING COMPANY
SUBMITTED BY : LARRY BALLARD, P.E.

FINANCIAL PROJECT ID : _____

DISTRICT : 3
ROAD NO : S.R. 29
COUNTY : HOUSTON

CROSS SECTION SOIL SURVEY FOR THE DESIGN OF ROADS

SURVEY BEGINS STA. : 400+00 SURVEY ENDS STA. : 554+00

STRATUM NO.	ORGANIC CONTENT		MOISTURE CONTENT	SIEVE ANALYSIS RESULTS % PASS					ATTERBERG LIMITS (%)			DESCRIPTION	CORROSION TEST RESULTS						
	NO. OF TESTS	% ORGANIC		NO. OF TESTS	10 MESH	40 MESH	60 MESH	100 MESH	200 MESH	NO. OF TESTS	LIQUID LIMIT		PLASTIC INDEX	AASHTO GROUP	NO. OF TESTS	RESISTIVITY ohms-cm	CHLORIDE ppm	SULFATES ppm	pH
1											N.P.		ROCK BASE ASPHALTIC CONCRETE						
2				4	98-97	93-77	82-59	55-44	10-3			N.P.	A-3	SUBGRADE (GRAY & TAN SAND W/TRACE SILT, L.R. & SHELL)					
3	7	3.5-2.5		7	100-94	94-86	71-65	45-34	21-15			N.P.	A-2-4	FILL (DARK BROWN SAND W/SOME SILT & TRACE L.R.)	7	43000-34000	60-40	72-18	8.3-6.4
4	3	1.5-1.9		4	100-84	93-71	90-60	82-53	45-37	4	38-25	9-5	A-4	GRAY AND BROWN SILTY SAND W/TRACE CLAY AND L.R.	4	26000-23000	120-60	96-84	8.9-8.4
5				3	100	100-99	98-96	80-75	34-30	3	44-42	15-11	A-2-7	TAN AND LIGHT GRAY SILTY SAND W/SOME CLAY AND TRACE SHELL	3	8000-6600	120-60	216-156	8.2-7.5
6	3	18.2-40	20-60						46-30	3	33-25	15-10	A-8	MUCK (DARK BROWN SILTY SAND W/SOME CLAY)					
7				3	100	92-88	79-73	69-60	55-51	3	61-55	53-38	A-7	YELLOW AND GRAY SILTY SAND CLAY					
8	3	15.5-20	20-58	3	100-99	99-97	97-88	80-77	15-10			N.P.	A-8	MUCK (BROWN SAND W/SOME ORGANIC AND TRACE SHELL)	3	35000-20000	120	120	5.2-4.6

EMBANKMENT AND SUBGRADE MATERIAL

STRATA BOUNDARIES ARE APPROXIMATE MAKE FINAL CHECK AFTER GRADING

W - WATER TABLE ENCOUNTERED

GNE - GROUND WATER NOT ENCOUNTERED

The material from Stratum Number 1 is Rock Base under Asphaltic Concrete.

The material from Stratum Number 2 appears satisfactory for use in the embankment when utilized in accordance with Index 505.

The material from Stratum Number 3 appears satisfactory for use in the embankment when utilized in accordance with Index 505. However, this material is likely to retain excess moisture and be difficult to dry and compact. It should be used in the embankment above the water level existing at the time of construction. This material may not be used in the subgrade portion of the roadbed due to its organic content.

The materials from Stratum Numbers 4 and 5 are plastic materials and shall be removed in accordance with Index 500. They may be placed above the existing water level at the time of construction, to within 4 feet of the proposed base. They should be placed uniformly in the lower portion of the embankment for some distances along the project rather than full depths for short distances.

The material from Stratum Numbers 6 and 8 is ORGANIC/A-8 material and shall be removed in accordance with Index 500.

The material from Stratum Number 7 is Highly Plastic material and shall be removed in accordance with Index 500. It may be used within the project limits as indicated in Index 505 only when excavated within the project limits and is not to be used when obtained from outside the project limits.

EXHIBIT SS-1
Date: 1/1/07

REVISIONS						STATE OF FLORIDA DEPARTMENT OF TRANSPORTATION			ROADWAY SOILS SURVEY	SHEET NO.
DATE	BY	DESCRIPTION	DATE	BY	DESCRIPTION	ROAD NO.	COUNTY	FINANCIAL PROJECT ID		

#USERS

#DATES

#TIMES

#FILES

Chapter 18

Roadway Cross Sections

18.1	General	18-1
18.2	Required Information.....	18-1
18.3	Sheet Set Up.....	18-3

THIS PAGE LEFT BLANK INTENTIONALLY

Chapter 18

Roadway Cross Sections

18.1 General

Cross sections depict the existing ground conditions, including all manmade features, as sections perpendicular to the respective stations along a survey baseline or construction centerline. The proposed cross-sectional outline of the new facility with all its functional elements is also shown on cross sections. Standard cross section sheets shall be used for showing roadway cross sections. The preformatted sheet cell is located in the FDOT Engineering/CADD Systems Software. This sheet features a standard grid of five lines per inch, both in the vertical and horizontal. The vertical scale can be altered to ten lines per inch by utilizing a toggle feature in the CADD software.

The recommended vertical scale is 1" = 10'. The horizontal scale shall be such that the entire roadway R/W is shown on the sheet (generally 1" = 10' or 1" = 20'), but shall not be smaller than 1" = 40' horizontal. If the entire R/W cannot be shown on one sheet, more sheets may be utilized and appropriate match lines shall be shown with referenced sheet numbers. The scale shall be shown at the bottom right corner of the sheet above the title box.

18.2 Required Information

Existing ground lines shall be shown and the existing elevation at the centerline shall be noted just below the ground line at the centerline. The station number of the section shall be indicated opposite the ground line on the right side of the sheet and location baseline of survey indicated along the top and bottom of the sheet. Lines parallel to the baseline of survey should show station equivalencies to the baseline of survey.

The surface, as well as the below ground portions of existing features such as pavements, curbs and sidewalks, shall be shown.

Existing parallel underground utilities which lie within the horizontal limits of the project shall be shown along with verification notation for those locations which have been verified. Utilities that have been verified should be labeled as shown in **Section 14.3** of this volume. Small distribution or service lines need not be drafted.

Soil data and water table shall be shown on cross sections as described in **Section 17.2.1** of this volume. If it is determined that an organic or plastic material must be removed below the finished grading template, the lower limits of removal of organic or plastic material will be shown to determine the area and volume of subsoil excavation.

The proposed roadway template shall be shown. The proposed profile grade elevation shall be placed vertically or at an angle to the horizontal, just above the profile grade line. Special ditch elevations shall also be shown.

Station equations shall be shown, even though a cross section may not be plotted at that point. For ramp cross sections equivalent mainline stations shall also be shown.

The right of way limits shall be symbolically shown for each cross section.

The begin and end stations for project, construction, exceptions, bridge/bridge culvert and the toe of slope under the bridge shall be shown. The beginning and ending earthwork stations shall be shown.

On projects with grade separations, intersections, interchanges, etc., the earthwork shall be totaled on the last cross section sheet for each of the above and noted as to the station in which the earthwork is included on the project cross sections. Earthwork quantities shall be indicated in the appropriate columns on the right side of the sheet. Earthwork summaries shall be shown on the last cross section sheet of each roadway, ramp, etc. The grand total shall be tabulated in the Summary of Earthwork and shown on the Summary of Quantities Sheet.

The order of assembling the cross sections in the plans set shall be:

1. Mainline
2. Side streets
3. Ramps

18.3 Sheet Set Up

Cross sections shall be shown on a standard preformatted cross section sheet (available in the FDOT Engineering/CADD Systems Software) with stations increasing from the bottom to the top of the sheet. Usually, only one column of sections shall be placed on a sheet.

The interval selected for showing sections on the cross section sheet will vary according to project specific factors. For new construction and reconstruction, the normal interval for cross sections is 100 feet for rural projects and 50 feet for urban projects. These intervals may also be appropriate on RRR projects, depending on the variability of earthwork along the project. Other factors that may influence the frequency of cross sections include the presence of intersections, extent of driveway and turnout construction or reconstruction, ADA related work, drainage improvements, etc.

Sections shall be centered on the sheet with the survey baseline or the construction centerline placed vertically in the center. In cases where additional lanes are to be constructed adjacent to existing lanes, centering the sections will depend upon the location of the survey line and the side on which the new construction is to be placed. Sections shall be oriented such that the complete ultimate section will be approximately centered on the sheet. When the centerlines of construction and survey are not parallel, the distance between the two at each cross section shall be shown.

As many sections as possible shall be placed on a sheet with sections being spaced to avoid overlapping. The soil profile should be checked for possible unsuitable material below existing ground which may cause overlapping of sections.

When right of way is narrow enough and a horizontal scale of 1" = 20' is used, two columns of cross sections may be placed on a sheet. Cross section stationing shall progress from the bottom to the top of the sheet and multiple columns shall be placed from the left to the right. The sheet shall be set up to provide earthwork columns for each column of sections.

For additional information on cross sections see ***Volume I, Chapter 3.***

THIS PAGE LEFT BLANK INTENTIONALLY

Chapter 19

Temporary Traffic Control Plan

19.1	General	19-1
19.2	Required Information.....	19-1
19.3	Levels of Complexity to be Anticipated for Temporary Traffic Control Plans.....	19-2
19.3.1	Level I	19-2
19.3.2	Level II	19-2
19.3.3	Level III	19-3
19.4	Format.....	19-4

THIS PAGE LEFT BLANK INTENTIONALLY

Chapter 19

Temporary Traffic Control Plan

19.1 General

A Temporary Traffic Control (TTC) plan will accompany all plans for a construction project. The TTC plan is the final document that summarizes the considerations and investigations made in the development of a comprehensive plan for maintaining traffic through a work zone.

The TTC plan is used to describe the actions to be taken by the contractor to minimize traffic impacts while conveying traffic safely through a work zone. The TTC plans may include, but are not limited to, general notes, phase notes, phase typical sections, phase plan-profile sheets, special details, and temporary cross sections.

19.2 Required Information

Specific temporary traffic control plans are required on all projects. The information provided on the TCP plans may consist of nothing more than notes and references to the ***Design Standards, Series 600*** or may be as elaborate as detailed individual phase layouts using profile sheets and interchange and intersection layout sheets. Information shall be provided to inform the contractor of the following:

1. location of the centerline, pavement edge, curb line, shoulder;
2. placement of temporary pavement markings;
3. lane configurations;
4. locations of work zone signs and any other temporary work zone traffic control devices (including variable message signs, advanced warning arrow panels, barriers, crash cushions, temporary signals, etc.);
5. layouts and placement of channelizing devices;
6. work to be accomplished during the individual phases of construction,
7. lane closures and other restrictions that apply;
8. regulatory speed limits for each phase;
9. project specific requirements such as school zones, railroads, waterborne vessels, etc.

When a project requires more than one phase of construction, the temporary traffic control plans should address each individual phase. MOT quantities should be tabulated by phase in the temporary traffic control plans or shown in the computation book.

19.3 Levels of Complexity to be Anticipated for Temporary Traffic Control Plans

The following guidelines have been developed to assist in determining the level of detail and complexity that may be required for a project.

19.3.1 Level I

Application - Simple projects where method of construction is straight forward. (Examples: RRR, Enhancements, Resurfacing, Minor Widening).

Components of the TTC Plan

1. General Notes (including references to the applicable indexes in the **Design Standards**)
2. Phase Typical Section(s)
3. Special Details - MINIMAL - where unique situations for the project exist

19.3.2 Level II

Application - Moderately complex Construction projects, such as reconstruction of roadways. (Examples: Urban or rural widening projects, Projects with Diversions or Detours)

Components of the TTC Plan

1. General Notes
2. Phase Notes (including references to the applicable indexes in the **Design Standards**)
3. Phase Typical Section(s)
4. Detailed plan sheets (when an index in the **Design Standards** does not apply)
5. Cross Sections as determined necessary (Example: diversions, temporary drainage, temporary bridge structure)
6. Special Details - As necessary for constructability (Example: temporary drainage, slope requirements due to diversions, temporary signalization, railroad work, etc.)

19.3.3 Level III

Application - Complex projects.

Components of the TTC Plan

1. General Notes
2. Phase Notes (including any references to the applicable standard indexes)
3. Phase Typical Section(s)
4. Detailed Plan Sheets
5. Cross Sections
6. Special Details may include - Temporary Drainage; Temporary Signalization; Intersection Details; etc.

19.4 Format

TTC plans will be prepared on standard plan sheet format. A scaled drawing is not always required; however, clarity and legibility are critical. When scaled drawings are required, the scale shall not be less than 1" = 100' for plan sheets and 1" = 40' for special details. Levels, fonts and line weights shall be in accordance with the ***FDOT CADD Production Criteria Handbook***.

Tools are available in FDOT Engineering/CADD Systems Software to assist in the development of Temporary Traffic Control Plans.

Chapter 20

Utility Adjustments

20.1	General	20-1
20.2	Required Information.....	20-2
20.3	Sheet Format	20-3
Exhibits		
Exhibit 20-1	General Notes for Utility Adjustments	20-4

THIS PAGE LEFT BLANK INTENTIONALLY

Chapter 20

Utility Adjustments

20.1 General

The purpose of utility adjustment sheets is to provide coordination between the contractor and the affected utility companies. These sheets show the contractor the approximate locations of existing, proposed and relocated utilities, and thus aid the contractor in avoiding possible conflicts or damage to the utilities involved.

20.2 Required Information

Locations of all existing and proposed utilities within the project limits shall be shown on the plans.

All proposed and relocated utilities shall be clearly shown on the plan using lines and standard utility symbols, and shall be labeled (see ***Index No. 002*** of the ***Design Standards*** and the ***FDOT CADD Production Criteria Handbook***). Disposition of all existing utilities that are not to remain in place and in service shall be clearly indicated: for example "To Be Removed", "To Be Adjusted", "To Be Relocated", etc. The disposition of existing utilities that are to remain in place and in service need not be labeled. All proposed utilities shall be appropriately labeled.

Applicable general notes shall also be shown on the first utility adjustment sheet (see ***Exhibit 20-1***).

20.3 Sheet Format

The utility adjustment sheets shall be prepared from CADD files generated for the plan or plan-profile sheets, and only the plan portion should be shown. Levels, fonts and line weights shall be in accordance with the ***FDOT CADD Production Criteria Handbook***.

Information and graphic data that is not necessary for utility adjustment sheets may be removed by turning off the appropriate level(s) on which the data is stored. This will help ensure that information pertinent to utility adjustments is more easily seen. However, the utility adjustment sheets shall show the following information as a minimum:

1. Baseline and/or centerline of survey.
2. Curb and gutter or edge of pavement.
3. Drainage structures (existing and proposed).
4. Right of way lines.
5. Station numbers.
6. Street names.
7. Location of existing utilities. All major utilities that have been field verified (see *Quality Level "A" locates, Volume I, Chapter 5*) shall be labeled in accordance with the following symbol:

V_{vh} = Verified Vertical Elevation and Horizontal Location

At the District's option, a table of field verified utilities containing the following information can replace the profile view on each sheet:

V_{vh} No.	Utility Description	Station	Offset	Existing Ground Elevation	Top Elevation	Comments

8. Disposition of existing utilities that are not to remain in place and in service.
9. Location of new or relocated utilities.

Exhibit 20-1 General Notes for Utility Adjustments

The following notes shall be placed on the first Utility Adjustment Sheet. (If there are no utility adjustment sheets in the plans, these notes shall be included in the General Notes shown on **Exhibit 10-1**).

1. The location(s) of the utilities shown in the plans (including those designated V_v , V_h and V_{vh}) are based on limited investigation techniques and should be considered approximate only. The verified locations/elevations apply only at the points shown. Interpolations between these points have not been verified.
2. Existing utilities are to remain in place unless otherwise noted.
3. Utility/Agency Owners:

Companies

Telephone Numbers

(Note: The above company names and phone numbers are for emergency utility contacts. Contact information shall also be included for persons responsible for the maintenance (by contract or internally) of any FDOT utility infrastructure such as traffic counters, lighting, signal components, and ITS.)

If there is a traffic-monitoring site on the project or within one-half mile of the construction, the Transportation Statistics Office in Tallahassee shall be added to the list of Utility/Agency Owners. The contact person is the Traffic Data Section Manager. Refer to **Chapter 10, Section 10.2.7, Item No. 13** for plan requirements involving traffic-monitoring sites).

Chapter 21

Selective Clearing and Grubbing

21.1	General	21-1
21.2	Required Information and Sheet Set Up	21-2
21.3	Standard Symbols and Notes	21-3

THIS PAGE LEFT BLANK INTENTIONALLY

Chapter 21

Selective Clearing and Grubbing

21.1 General

Selective clearing and grubbing plans show the extent and type of clearing operation required within the project right of way limits. This information may be shown on the plan-profile sheet, if no substantial clutter of the sheet results. Otherwise, selective clearing and grubbing shall be shown on a separate plan sheet.

21.2 Required Information and Sheet Set Up

When separate selective clearing and grubbing sheets are required, they shall be shown on a standard plan format. Complete existing topography shall be shown together with centerline of construction with stationing, R/W lines and limits of construction. The type of selective clearing and grubbing operation to be performed shall be clearly shown by symbol (refer to **Section 21.3**).

A north arrow and graphic scale shall be placed at a point of maximum visibility on the sheet. Any convenient scale may be used provided clarity and legibility are preserved. However, it is recommended that the selective clearing and grubbing plans be prepared at the same scale as the roadway plan-profile sheets. Appropriate match lines shall be used when necessary.

For an illustration of a selective clearing and grubbing sheet, see **Exhibit SCG-2**.

21.3 Standard Symbols and Notes

The amount and type of notes required for selective clearing and grubbing will vary depending on the project. It may be desirable to provide a separate detail sheet in the plans to display the notes, symbols and details that are applicable to the project. An example of such a sheet is given in ***Exhibit SCG-1***.

All areas that are not included in one of the selective clearing and grubbing categories, as shown on the detail sheet or elsewhere in the plans, shall be standard clearing and grubbing.

Undesirable exotic pest plants, including Australian Pine, Brazilian Pepper, Malaleuca and Chinese Tallow trees, as well as Cogon grass should be labeled to be totally removed, regardless of size or location within the project limits.

THIS PAGE LEFT BLANK INTENTIONALLY

SELECTIVE CLEARING AND GRUBBING - GENERAL NOTES

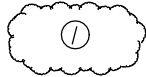

DESIGNATES AREAS TO REMAIN NATURAL. NO CLEARING OR GRUBBING IN THESE AREAS. NO EQUIPMENT SHALL ENTER THESE AREAS. NO STAGING, STORAGE OR DUMPING IN THIS AREA.



DESIGNATES AREAS WHERE TREES AND STUMPS OVER 3" IN DIAMETER SHALL BE CUT FLUSH WITH THE GROUND OR REMOVED, AND ALL UNDERGROWTH IS TO REMAIN NATURAL. NO EQUIPMENT SHALL ENTER THESE AREAS THAT WOULD IN ANY WAY DAMAGE THE PLANT MATERIAL TO REMAIN. NO STAGING, STORAGE OR DUMPING IN THIS AREA.



DESIGNATES AREAS WHERE TREES OF 3" IN DIAMETER OR GREATER ARE TO REMAIN AND ALL UNDERGROWTH IS TO BE REMOVED. ONLY RUBBER TIRE EQUIPMENT SHALL ENTER THESE AREAS, AND REMAINING TREES SHALL BE PROTECTED FROM ROOT AND TRUNK DAMAGE. NO STAGING, STORAGE OR DUMPING IN THIS AREA.



DESIGNATES AREAS WHERE THE TYPE AND EXTENT OF CLEARING AND GRUBBING SHALL BE DETERMINED BY THE ENGINEER ACCORDING TO FIELD CONDITIONS.



DESIGNATES AREAS THAT SHALL REMAIN NATURAL WHEN, IN THE OPINION OF THE ENGINEER, ADEQUATE AND DESIRABLE NATURAL VEGETATION OR GRASS EXIST. WHERE THIS TYPE VEGETATION DOES NOT EXIST, ONLY HARROWING DISKING, LEVELING, AND/OR CLEAN-UP SHALL BE UNDERTAKEN, TO A DEGREE SUFFICIENT TO PREPARE THE AREA FOR GRASSING OPERATIONS.

AREAS WHERE EQUIPMENT IS NOT ALLOWED AND OTHER LOCATIONS, AS DIRECTED BY THE ENGINEER, MUST BE PROTECTED BY TREE GUARDS. THE LOCATION FOR TREE GUARDS SHALL BE SHOWN IN THE PLANS.

ALL OTHER AREAS NOT INCLUDED IN ONE OF THE ABOVE CATEGORIES, OR THOSE DESIGNATED BY THE TYPICAL SECTIONS, SHALL BE STANDARD CLEARING AND GRUBBING.

WHERE UNFORSEEN SITE CONDITIONS EXIST, ADJUSTMENTS OR EXCEPTIONS MAY BE MADE TO THE ABOVE PROCEDURE AT THE DIRECTION OF THE ENGINEER.

FINISH SOIL LAYER - GENERAL NOTES

STOCKPILING OF FINISH SOIL LAYER MATERIAL IS TO BE DONE ONLY IN AREAS REQUIRING STANDARD CLEARING AND GRUBBING AND/OR AREAS DESIGNATED AS TYPE 5 (SEE SELECTIVE CLEARING AND GRUBBING - GENERAL NOTES).

TYPE 4 AREAS MAY BE USED FOR STOCKPILING OF FINISH SOIL LAYER MATERIAL ONLY WHERE SUCH AREAS HAVE BEEN CLEARED, AT THE DIRECTION OF THE ENGINEER DURING CONSTRUCTION OPERATIONS.

SUFFICIENT AREA HAS BEEN DESIGNATED SO THAT ALL STOCKPILING MAY BE DONE IN ACCORDANCE WITH THE REQUIREMENTS LISTED ABOVE.

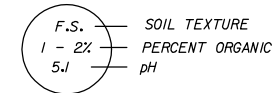

SOIL INFORMATION DETAIL

EXPLANATION OF SYMBOLS & SOIL TEXTURE ABBREVIATIONS

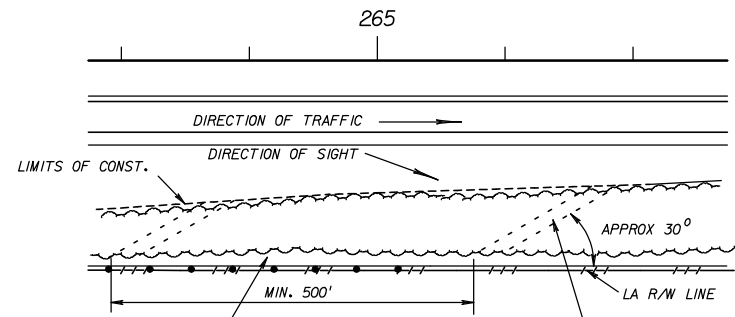

10' STRIP WHICH MAY BE CLEARED FOR FENCE CONSTRUCTION WITH SELECTED DESIRABLE TREES ALLOWED TO REMAIN, AS DIRECTED BY THE ENGINEER.

AT THE DIRECTION OF THE ENGINEER, DIAGONAL PATH MAY BE CUT IN AREAS TO REMAIN NATURAL, AS SHOWN ABOVE, FOR THE REMOVAL OF TIMBER AND STUMPS FROM THE AREA CLEARED FOR FENCE CONSTRUCTION.

ACCESS FOR FENCE CONSTRUCTION

(APPLIES TO ALL TYPES OF SELECTIVE CLEARING AND GRUBBING)

EXHIBIT SCG-1
Date: 1/1/06

REVISIONS						STATE OF FLORIDA DEPARTMENT OF TRANSPORTATION			SELECTIVE CLEARING AND GRUBBING	SHEET NO.
DATE	BY	DESCRIPTION	DATE	BY	DESCRIPTION	ROAD NO.	COUNTY	FINANCIAL PROJECT ID		

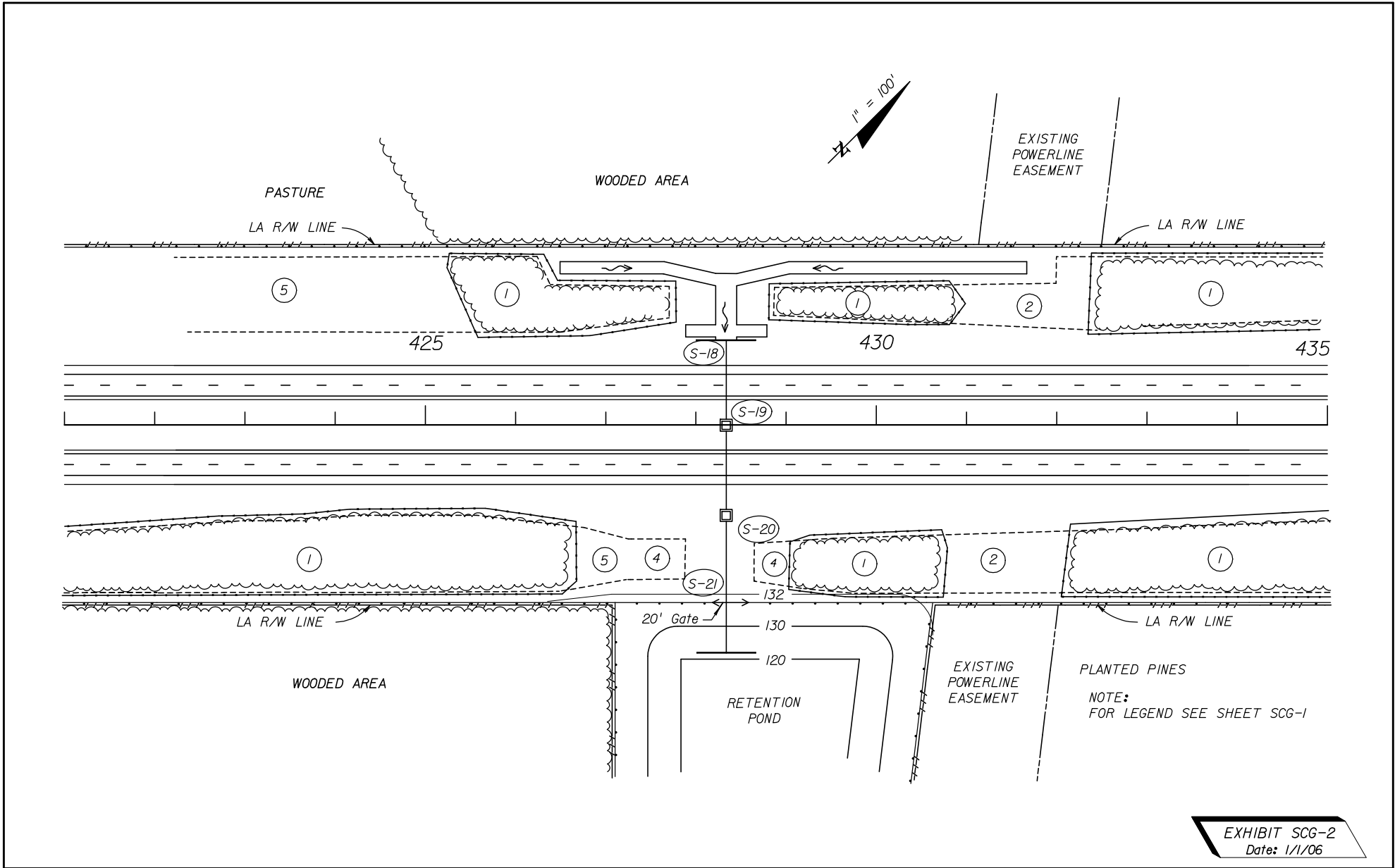

EXHIBIT SCG-2
Date: 1/1/06

REVISIONS						STATE OF FLORIDA DEPARTMENT OF TRANSPORTATION			SELECTIVE CLEARING AND GRUBBING	SHEET NO.
DATE	BY	DESCRIPTION	DATE	BY	DESCRIPTION	ROAD NO.	COUNTY	FINANCIAL PROJECT ID		

Chapter 22

Miscellaneous Structures Plans

22.1	General	22-1
22.2	Approach Slabs	22-2
22.3	Retaining Walls (Cast in Place, Proprietary, Temporary).....	22-3
22.4	Concrete Box Culverts	22-4
22.5	Three-Sided Concrete Culverts.....	22-6
Exhibits		
Exhibit 22-1	Three-sided Concrete Culvert Notes.....	22-7

THIS PAGE LEFT BLANK INTENTIONALLY

Chapter 22

Miscellaneous Structures Plans

22.1 General

Miscellaneous structures not included in the bridge plans shall be included in the appropriate component plans. This includes box or three-sided culvert details, high mast lighting supports, traffic mast arm supports, signal strain poles, overhead sign supports, rest area structures or buildings, barrier walls (traffic or sound), retaining walls and toll facilities.

For guidelines on structural detailing, refer to the *Structures Detailing Manual* (Topic No. 625-020-200).

22.2 Approach Slabs

As of the July, 1999 letting, approach slab details sheets are included in the structures plans. However, some roadway elements may need to be carried onto the approach slab, and in these cases special attention must be given to clarifying in the plans which elements are to be included as part of the roadway.

The stabilization required under the approach slabs shall be paid for using the standard roadway pay item and the quantity included in the roadway plans. In addition, roadway elements such as guardrail, earthwork, sidewalks, approach slab surfacing, etc., which are part of the roadway approaches to the bridge and which interface with the approach slabs areas, will also be included and paid for in the roadway quantities.

22.3 Retaining Walls (Cast in Place, Proprietary, Temporary)

When cast in place retaining walls other than standard gravity walls are required, complete design and construction details, including pay items and quantities are required in the contract plans. The same is true for steel or concrete sheet piles for either permanent or temporary retaining walls.

Proprietary walls are handled differently than cast in place, steel and concrete sheet pile retaining walls. A set of control plan details must be developed for retaining walls. (See **Chapter 30, Volume I** for a discussion concerning the requirements for control plan details).

On projects with bridges the control plan details shall be included in the bridge plans. When there are no bridge plans the control plan details shall be included in the appropriate component plans. Examples of control plan details are included as exhibits at the back of this chapter.

Standard drawings from the preapproved wall companies are included in the **Design Standards** (available as Interim Index Drawings).

22.4 Concrete Box Culverts

Complete design and construction details, including pay items and quantities are required in the contract plans for concrete box culverts. Include the following minimum design details:

1. Plan view (usually shown on the Plan-Profile sheet – see **Chapter 10, Exhibit PP-2**) showing: Grid north arrow; scale bar; existing highway boundaries including existing ROW monuments; new right of way line(s) including proposed ROW monuments; culvert or bridge identification number; culvert and highway alignment; survey baseline; profile grade line; direction of stationing; stream channel alignment; stream flow direction; skew angle of the culvert relative to the centerline of roadway; stationing along the profile grade line including begin and end station of culvert (outside face of sidewalls); length of culvert; subsurface exploration locations (e.g., boring locations); culvert end treatment (headwall and wing wall orientation); scour protection; slope protection; limit of stream work; utilities; traffic railing and pedestrian/bicycle railing type.
2. Elevation view (usually shown on the Plan-Profile sheet – see **Chapter 10, Exhibit PP-2**) showing: Elevation vertical scale; profile grade line and vertical data; existing stream bottom and ground line (along PGL); utilities.
3. A longitudinal section along the culvert centerline (usually shown on the Drainage Structures sheet – see **Chapter 14, Exhibit DS-2**) showing: Culvert or bridge identification number; invert elevations; existing stream bottom or original ground; culvert stationing at centerline; typical highway section (including rail treatment); design earth cover height (measured from the top of the top slab to the top of pavement); limits of scour protection (including any keyways or geotextile fabric lining); channel work; culvert end treatments; utility (either attached to the fascia, or in the embankment, traffic railing or sidewalk); wing walls; headwalls; cutoff walls; reference to the appropriate Design Standard Indexes.
4. Data Sheets (see **Chapter 7.3**):
 - a) For LRFD Designs: Box Culvert Data Table and Reinforcing Bar List.
 - b) For LFD Designs: Box Culvert Data Sheet.
5. Miscellaneous details showing (usually shown on Box Culvert Detail sheets, located after the Drainage Structure sheets): Construction phasing information (affects lengths of precast segments and potential need for skewed segments) including appropriate excavation support and protection systems (e.g., critical temporary walls); traffic railing details including connection details; slope and/or stream bank protection; channel section detail; culvert-end safety grate, guardrail or fencing details when applicable; removal of existing culvert(s); cofferdams or water diversion.

6. Notes (usually on the Box Culvert Data Sheets) indicating: Live loading requirements (HL-93 or HS-25); hydraulic data (show 100-year design flow or the design flow used and the minimum hydraulic area perpendicular to flow below the Design High Water); environmental classification for durability; minimum concrete class and reinforcing steel grade; assumed soil weight, angle of internal friction and nominal bearing capacity; differential soil settlement height and effective length (when significant); precast culvert limitations; any special joint waterproofing requirements; erosion and sediment control and stormwater pollution prevention plan requirements; restrictions for work in streams; estimated quantities.

22.5 Three-Sided Concrete Culverts

Complete footing, wingwall and channel lining designs and construction details are required for three-sided culverts. However only conceptual culvert barrel and headwall design details need to be provided. Include the following minimum design details in the roadway plans and place directly after the Drainage Structure sheets:

1. Plan view showing the orientation of the ends of the structure. The two most typical options for culverts on a skew are ends parallel to the centerline of the roadway (skewed ends) or ends perpendicular to the centerline of the structure (square ends). The end treatment depends upon the skew, whether it is in a fill section or at grade, the location within the right of way, conflicts with utilities, phased construction details, the alignment of the feature crossed, and other site limitations.
2. Elevation view showing the configuration of the most appropriate type unit (e.g., frame or arch). Any limitations on using a larger span must be shown. (Some manufacturers only fabricate units at fixed increments of span length, therefore showing the limitations will allow the manufacturers to bid using special units or the next larger span length of their standard units). Show other acceptable structure types in separate partial elevation views. Limiting spans and heights must be shown for all alternatives.
3. No precast manufacturer should be eliminated from consideration for a given project. However, specific project requirements that may exclude some manufacturers must be identified (such as fabrication on a skew or a desired arched appearance).
4. Complete details for a cast-in-place footing design, including design loads and assumptions for the spread footings.
5. Complete details for cast-in-place wingwalls, including geometry and reinforcement details.
6. Estimated quantities for concrete and reinforcing steel for cast-in-place elements, but do not include separate pay items.
7. Payment limits shall be identified as the length of the total structure along a longitudinal centerline of the structure.
8. The applicable details in **Section 22.4** shall also be included.
9. See **Exhibit 22-1** for a list of applicable notes that may be required.

Exhibit 22-1 Three-sided Concrete Culvert Notes

The following notes shall be included adjacent to the plan or elevation views, as applicable:

1. The assumed foundation vertical reaction is ____ kips/ft. The assumed foundation horizontal reaction is ____ kips/ft. The Contractor must submit a revised foundation design to the Engineer if the actual loads of the supplied structure exceed these assumed values. Any revised foundation design must be included in the shop drawings and submitted for approval at the same time as the design calculations for the three-sided structure.
2. (In cases where squaring of the unit ends would create a geometric conflict with right of way, utilities, phase construction or site geometry, include the following note):
Due to site restrictions, only skewed end units are acceptable.
3. (If site constraints do not eliminate the squaring of the ends, include the following note):
Squared end units may be substituted for skewed end units with no change in the payment limits and no additional cost to the Department.
4. (When traffic railings are attached to skewed headwalls and site constraints do not eliminate the squaring of the ends, include the following note):
If the Contractor proposes to substitute square ends, details of the traffic railing attachment must be provided in the shop drawings and approved by the Engineer.

THIS PAGE LEFT BLANK INTENTIONALLY

PERMANENT RETAINING WALL SYSTEM DATA TABLES

GEOTECHNICAL INFORMATION						
		Reinforced Soil & Random Backfill	Loose Fine Sand	Firm Fine Sand	Loose Clayey Fine Sand	Firm Clayey Fine Sand
Depth Below Existing Ground Line (ft.)	Wall No. 1 & 2	—	0'-6'	6'-33'	33'-39'	—
	Wall No. 3	—	0'-10'	10'-26'	—	26'-39'
Effective Unit Weight (pcf)		110 (moist weight in-place)	118	118	120	110
Cohesion (psf)		0	0	0	122	122
Internal Friction Angle		30°	30°	32°	0	0

NOTE:
If the unit weight and/or internal friction angle of the fill proposed by the Contractor differs from that shown above, the Project Engineer will contact both the District Geotechnical Engineer and the Wall Designer for a possible redesign.

RETAINING WALL VARIABLES			
Wall No.	Wall Settlement		
	Long Term Settlement (in.)	Short Term Settlement (in.)	Differential Settlement (in./ft.)
1 & 2	2" to 3"	1" to 2"	1/16"/1'
3	2" to 3"	1" to 2"	1/16"/1'

NOTE:
Design walls for the settlements noted in the table.
Long term settlement is measured from the beginning of wall construction.

SOIL REINFORCEMENT LENGTHS FOR EXTERNAL STABILITY												
Wall No. 1 & 2	Wall Height (ft.)	0-11	12	13-14	15	16-17	18	19-20	21	22-23	24	25
	Reinforcement Length (ft.)	8	9	10	11	12	13	14	15	16	17	18
	Factored Bearing Resistance (psf)	1984	2295	2546	2857	3108	3419	3671	3980	4233	4543	4851
Wall No. 3	Wall Height (ft.)	0-11	12	13-14	15	16-17	18	19-20	—	—	—	—
	Reinforcement Length (ft.)	8	9	10	11	12	13	14	—	—	—	—
	Factored Bearing Resistance (psf)	2467	2467	2467	2467	2467	2467	2467	—	—	—	—

NOTES:
1. The reinforcement strap lengths shown above are the minimum lengths required for external stability. The reinforcement lengths used in the construction of the retaining walls will be the longer of that required for external or internal stability (determined by proprietary wall companies).
2. The Factored Bearing Resistances shown above are the critical (lowest) values from all the load cases analyzed using LRFD methodology.

NOTES:

- Concrete facing panels surfaces treatment will be a fluted, trapezoid, V-groove, fractured rib 3/4" on 1 1/2" centers similar to Burke Form Liner, Pattern No. BG312 (Waterfall).
- If required, the soil reinforcement and fasteners for the abutment back wall will be designed and furnished by proprietary wall company. The soil reinforcement will be designed to resist a factored horizontal load of 3.5 kips/ft of back wall width. The cost of soil reinforcement and fasteners will be included in the cost of the retaining wall system.
- Applicable FDOT Wall Types for each wall location are listed below. See the Qualified Products List for approved wall systems and the Table of FDOT Wall Types on Index No. 5300 of the Design Standards for allowable wall type substitutions.

Wall No. 1, 2 & 3 - FDOT Wall Type 2B

- See Design Standards Index No. 5300 for General Notes And Details.
- Longitudinal dimensions shown in the plans are measured along the exterior face of the wall. Elevations shown are to the top of coping, top of leveling pad or top of wall footing.

Note: Use CADD Cell "05300".
Work this cell with Design Standards, Index No. 5300.

EXHIBIT CP-1
Date: 1/1/07

REVISIONS						ENGINEER OF RECORD			FLORIDA DEPARTMENT OF TRANSPORTATION			SHEET TITLE	
DATE	BY	DESCRIPTION	DATE	BY	DESCRIPTION	DRAWN BY	NAME	DATES	ROAD NO.	COUNTY	FINANCIAL PROJECT ID	WALL CONTROL DRAWINGS AND GENERAL NOTES	
						CHECKED BY						PROJECT NAME	SHEET NO.
						DESIGNED BY							
						CHECKED BY							
						APPROVED BY							

#USER# #DATE# #TIME# #FILE#



Provide guardrail approach transition.
See Design Index No. 400 Detail J.

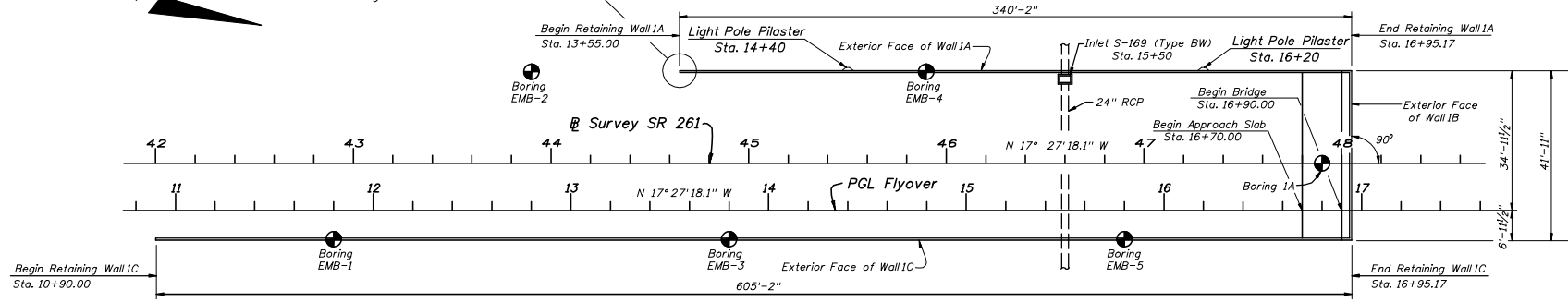

PLAN

- NOTES:
1. For Top of Coping Elevations see sheet BW-6.
 2. Top of footing embedment depth shall be a minimum of 2'-0" (See Sheet BW-1 for details).
 3. Provide 3/4" open joints in Traffic Railing Barrier at a maximum of 90 ft. intervals.
 4. ● indicates Soil Boring. See Sheets B-8 thru B-12a for boring data.
 5. CPT Sounding Locations are not shown. See Sheets B-12b thru B-12q for CPT data.
 6. For Additional Information regarding Drainage Structures and Utility Locations, See Roadway Plans.

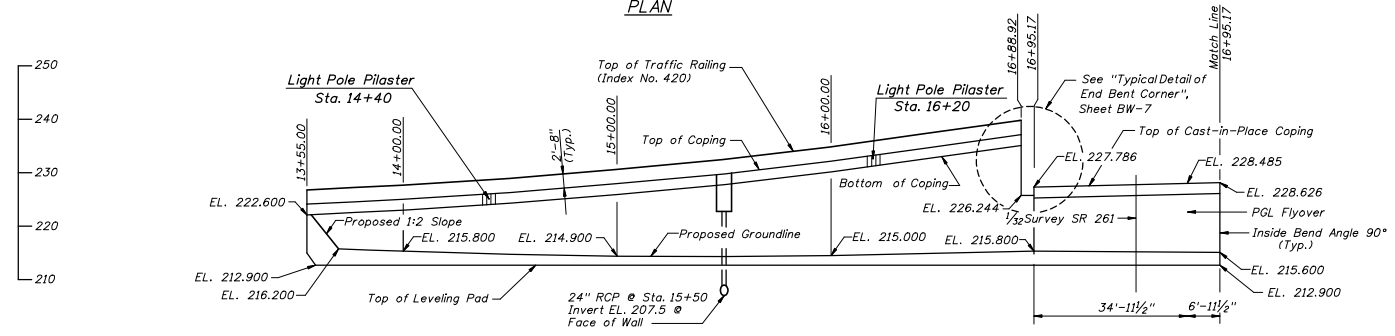

ELEVATION - WALLS 1A AND 1B
(REFLECTED VIEW)

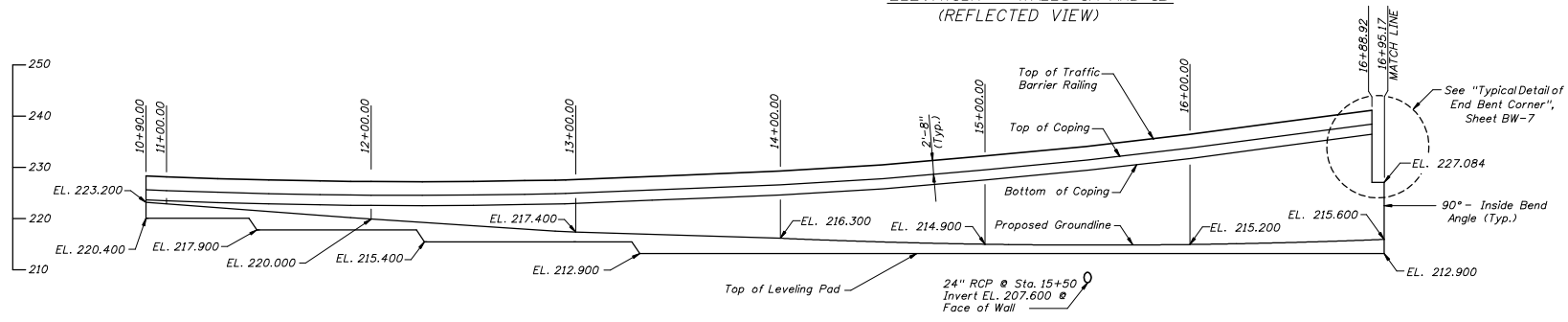

ELEVATION - WALL 1C

EXHIBIT CP-2
Date: 1/1/06

REVISIONS				NAMES		DATES		ENGINEER OF RECORD			FLORIDA DEPARTMENT OF TRANSPORTATION			SHEET TITLE	
DATE	BY	DESCRIPTION	DATE	BY	DESCRIPTION	DATE	BY	ROAD NO.	COUNTY	FINANCIAL PROJECT ID	PROJECT NAME	MSE WALL NO. 1		SHEET NO.	

#USER# #DATE# #TIME# #FILE#

WALL No. 1A

PGL Flyover Station	Exposed Face of Wall 1A Offset from PGL Flyover (ft.)	Top of Coping Elevation @ Wall 1A (ft.)
13+55.00	34.958	224.600
13+75.00	34.958	224.969
14+00.00	34.958	225.503
14+25.00	34.958	226.116
14+50.00	34.958	226.809
14+75.00	34.958	227.583
15+00.00	34.958	228.436
15+25.00	34.958	229.370
15+50.00	34.958	230.383
15+75.00	34.958	231.477
16+00.00	34.958	232.650
16+25.00	34.958	233.904
16+50.00	34.958	235.390
16+75.00	34.958	236.848
16+88.92	34.958	237.615
16+93.50	34.958	-

WALL No. 2A

PGL Flyover Station	Exposed Face of Wall 2A Offset from PGL Flyover (ft.)	Top of Coping Elevation @ Wall 2A (ft.)
26+78.83	34.958	-
26+85.08	34.958	239.246
27+00.00	34.958	238.327
27+25.00	34.958	236.948
27+50.00	34.958	235.969
27+75.00	34.958	234.191
28+00.00	34.958	232.812
28+25.00	34.958	231.433
28+50.00	34.958	230.055
28+75.00	34.958	228.676
29+00.00	34.958	227.297
29+25.00	34.958	226.058
29+50.00	34.958	224.927
29+75.00	34.958	223.891
30+00.00	34.958	222.950
30+25.00	34.958	222.109
30+50.00	34.958	221.525
30+70.00	22.958	221.121

WALL No. 3

SR 61 @ Construction Station	Exposed Face of Wall 3 Offset from SR 61 (ft.)	Top of Coping Elevation @ Wall 3 (ft.)
265+20.00	69.708	212.650
265+40.00	69.708	212.210
265+42.48	69.708	212.160
265+60.00	68.550	211.810
265+80.00	67.227	211.400
266+00.00	65.905	211.000
266+20.00	64.582	210.590
266+40.00	63.260	210.190
266+60.00	61.938	209.780
266+80.00	60.615	209.380
267+00.00	59.293	209.010
267+20.00	57.970	208.670
267+23.96	57.708	208.610
267+40.00	57.708	208.330
267+60.00	57.708	208.030
267+80.00	57.708	207.770
268+00.00	57.708	207.550
268+20.00	57.708	207.350
268+40.00	57.708	207.210
268+60.00	57.708	207.090
268+80.00	57.708	207.010
269+00.00	57.708	206.970
269+20.00	57.708	206.970
269+40.00	57.708	207.010
269+60.00	57.708	207.090
269+80.00	57.708	207.210
270+00.00	57.708	207.350
270+20.00	57.708	207.550
270+40.00	57.708	207.770
270+60.00	57.708	208.030
270+80.00	57.708	208.330
271+00.00	57.708	208.670
271+20.00	57.708	209.050
271+25.00	57.708	209.150

WALL No. 1C

PGL Flyover Station	Exposed Face of Wall 1C Offset from PGL Flyover (ft.)	Top of Coping Elevation @ Wall 1C (ft.)
10+90.00	6.958	225.647
11+00.00	6.958	225.486
11+25.00	6.958	225.139
11+50.00	6.958	224.872
11+75.00	6.958	224.685
12+00.00	6.958	224.578
12+25.00	6.958	224.551
12+50.00	6.958	224.604
12+75.00	6.958	224.737
13+00.00	6.958	224.950
13+25.00	6.958	225.243
13+50.00	6.958	225.616
13+75.00	6.958	226.069
14+00.00	6.958	226.603
14+25.00	6.958	227.216
14+50.00	6.958	227.909
14+75.00	6.958	228.683
15+00.00	6.958	229.536
15+25.00	6.958	230.470
15+50.00	6.958	231.483
15+75.00	6.958	232.577
16+00.00	6.958	233.750
16+25.00	6.958	235.004
16+50.00	6.958	236.323
16+75.00	6.958	237.648
16+88.92	6.958	238.477
16+93.50	6.958	-

WALL No. 2C

PGL Flyover Station	Exposed Face of Wall 2C Offset from PGL Flyover (ft.)	Top of Coping Elevation @ Wall 2C (ft.)
26+78.83	6.958	-
26+85.08	6.958	238.015
27+00.00	6.958	237.310
27+25.00	6.958	236.055
27+50.00	6.958	234.804
27+75.00	6.958	233.554
28+00.00	6.958	232.314
28+25.00	6.958	231.102
28+50.00	6.958	229.890
28+75.00	6.958	228.678
29+00.00	6.958	227.466
29+25.00	6.958	226.258
29+50.00	6.958	225.127
29+75.00	6.958	224.091
30+00.00	6.958	223.150
30+25.00	6.958	222.307
30+50.00	6.958	221.656
30+70.00	18.958	221.201

NOTES:

- Offsets are given to the exterior face of the proprietary wall (See Sheet BW-1 for detail).
- Top of Coping Elevation detail shown on Sheet BW-1.
- For existing and proposed ground elevations for all walls, see Sheets BW-2 thru BW-5.

EXHIBIT: CP-4
Date: 1/1/06

REVISIONS				ENGINEER OF RECORD			FLORIDA DEPARTMENT OF TRANSPORTATION			SHEET TITLE		
DATE	BY	DESCRIPTION	DATE	BY	DESCRIPTION	NAME	DATE	ROAD NO.	COUNTY	FINANCIAL PROJECT ID	MSE WALL ELEVATIONS	
											PROJECT NAME	SHEET NO.

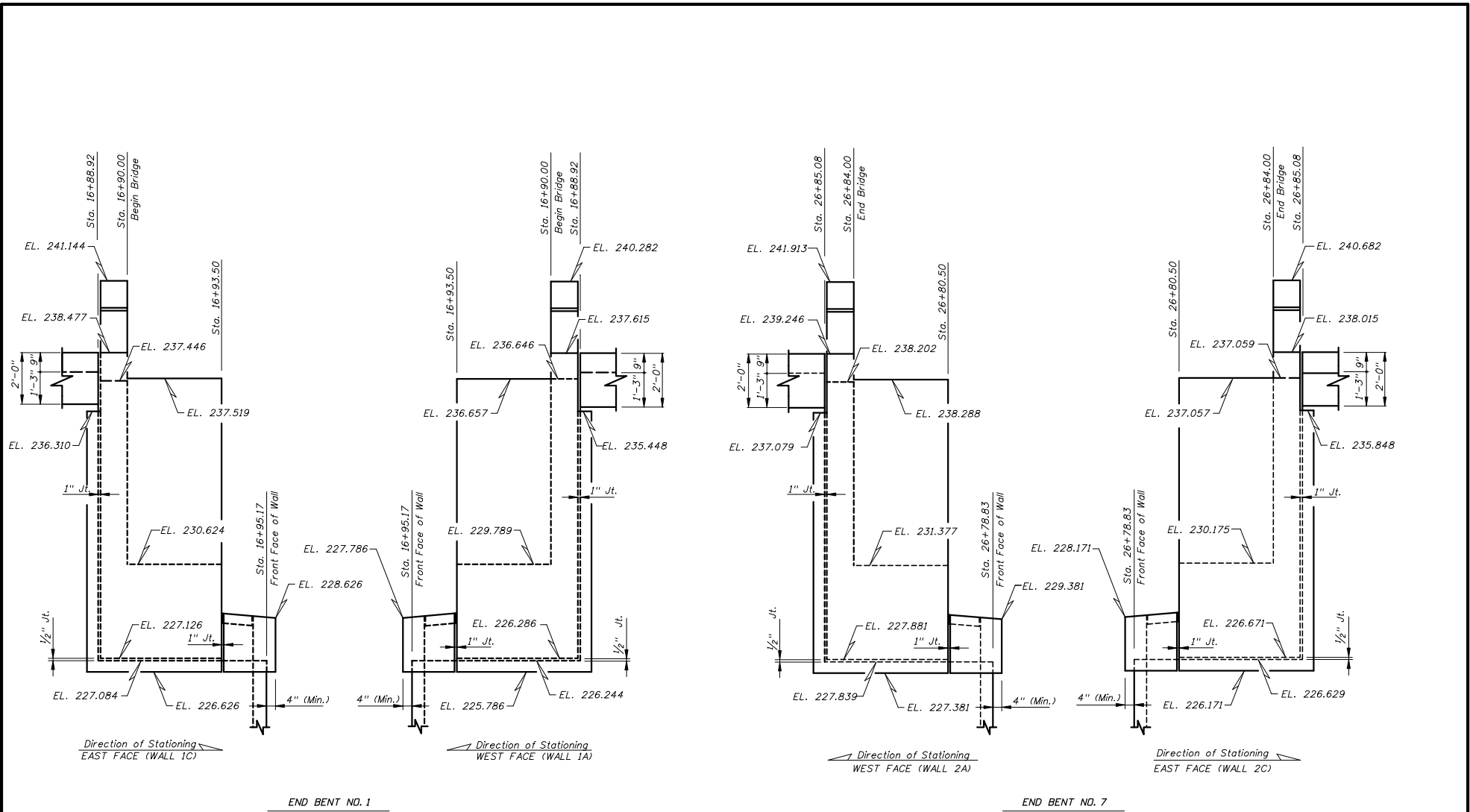

EXHIBIT CP-5
Date: 1/1/06

REVISIONS				ENGINEER OF RECORD		FLORIDA DEPARTMENT OF TRANSPORTATION			SHEET TITLE	
DATE	BY	DESCRIPTION	DATE	BY	DESCRIPTION	ROAD NO.	COUNTY	FINANCIAL PROJECT ID	MSE WALLS MISCELLANEOUS DEATILS	
									PROJECT NAME	SHEET NO.

#USER# #DATE# #TIME# #FILE#

TEMPORARY RETAINING WALL SYSTEM DATA TABLES

GEOTECHNICAL INFORMATION						
		Reinforced Soil & Random Backfill	Loose Fine Sand	Firm Fine Sand	Loose Clayey Fine Sand	Firm Clayey Fine Sand
Depth Below Existing Ground Line (ft.)	Wall No. 1	—	0'-9'	9'-23'	23'-37'	37'-45'
	Wall No. 2	—	0'-9'	9'-23'	23'-37'	37'-45'
Effective Unit Weight (pcf)		110	118	118	120	110
Cohesion (psf)		0	0	0	0	0
Internal Friction Angle		30°	34°	34°	35°	30°
Depth Below Existing Ground Line (ft.)	Wall No. 3	—	0'-10'	10'-15'	15'-17'	17'-45'
	Wall No. 4	—	0'-10'	10'-15'	15'-17'	17'-45'
Effective Unit Weight (pcf)		110	116	118	120	116
Cohesion (psf)		0	0	0	4177	0
Internal Friction Angle		30°	32°	34°	0	34°

NOTES:

1. See the Qualified Products List for approved Wall Systems (Type 3).
2. See Design Standards Index No. 5301 for General Notes and Details

NOTE:

If the unit weight and/or internal friction angle of the fill proposed by the Contractor differs from that shown above, the Project Engineer will contact both the District Geotechnical Engineer and the Wall Designer for a possible redesign.

RETAINING WALL VARIABLES				
Wall No.	Wall Settlement			Air Contaminants Classification
	Long Term Settlement (in.)	Short Term Settlement (in.)	Differential Settlement (in./ft.)	
1 & 2	1/2"	3/8"	1/16"/1'	Extremely Aggressive
3 & 4	1/2"	1/4"	1/16"/1'	Extremely Aggressive

NOTE:

Design walls for the settlements noted in the table. Long term settlement is measured from the beginning of wall construction.

SOIL REINFORCEMENT LENGTHS FOR EXTERNAL STABILITY										
Walls 1 thru 4	Wall Height (ft.)	5'-0"	5'-6"	6'-0"	6'-6"	7'-0"	7'-6"			
	Reinforcement Length (ft.)	7'-0"	7'-0"	7'-0"	7'-0"	7'-0"	7'-0"			
	Factored Bearing Resistance (psf)	1082	1241	1426	1648	1454	1623			

NOTES:

1. The reinforcement strap lengths shown above are the minimum lengths required for external stability. The reinforcement lengths used in the construction of the retaining walls will be the longer of that required for external or internal stability (determined by proprietary wall companies).
2. The Factored Bearing Resistances shown above are the critical (lowest) values from all the load cases analyzed using LRFD methodology.

Note: Use CADD Cell "05301".
Work this cell with Design Standards, Index No. 5301.

EXHIBIT CP-6
Date: 1/1/07

REVISIONS						ENGINEER OF RECORD			FLORIDA DEPARTMENT OF TRANSPORTATION			SHEET TITLE		
DATE	BY	DESCRIPTION	DATE	BY	DESCRIPTION	NAME	DATE	ROAD NO.	COUNTY	FINANCIAL PROJECT ID	TEMPORARY WALL CONTROL DRAWINGS GENERAL NOTES		PROJECT NAME	SHEET NO.

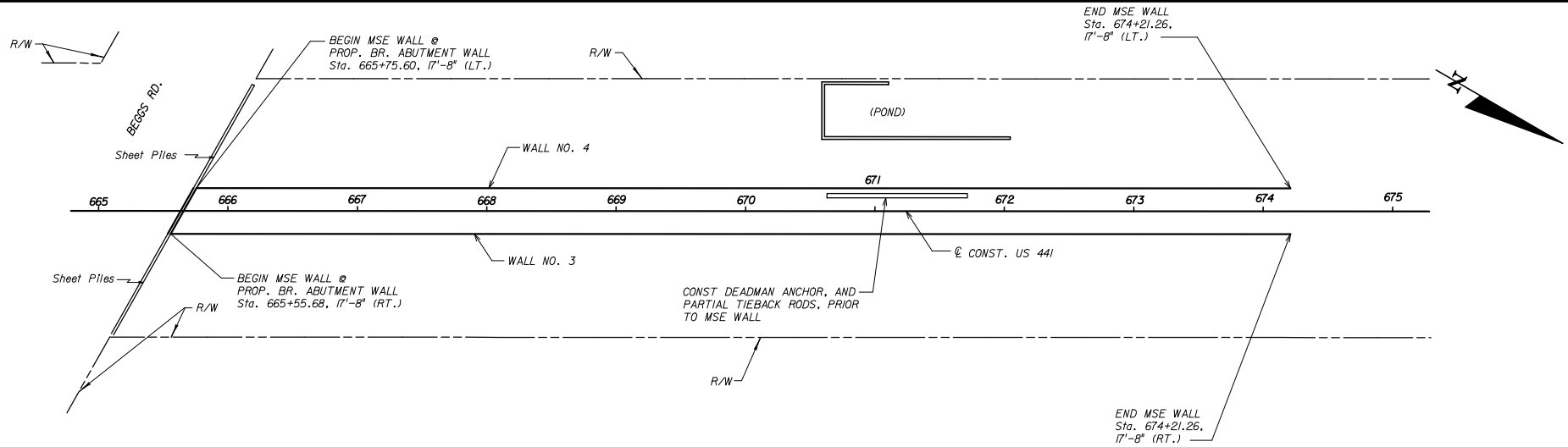

PLAN VIEW TEMP. MSE WALL NOS. 3 & 4

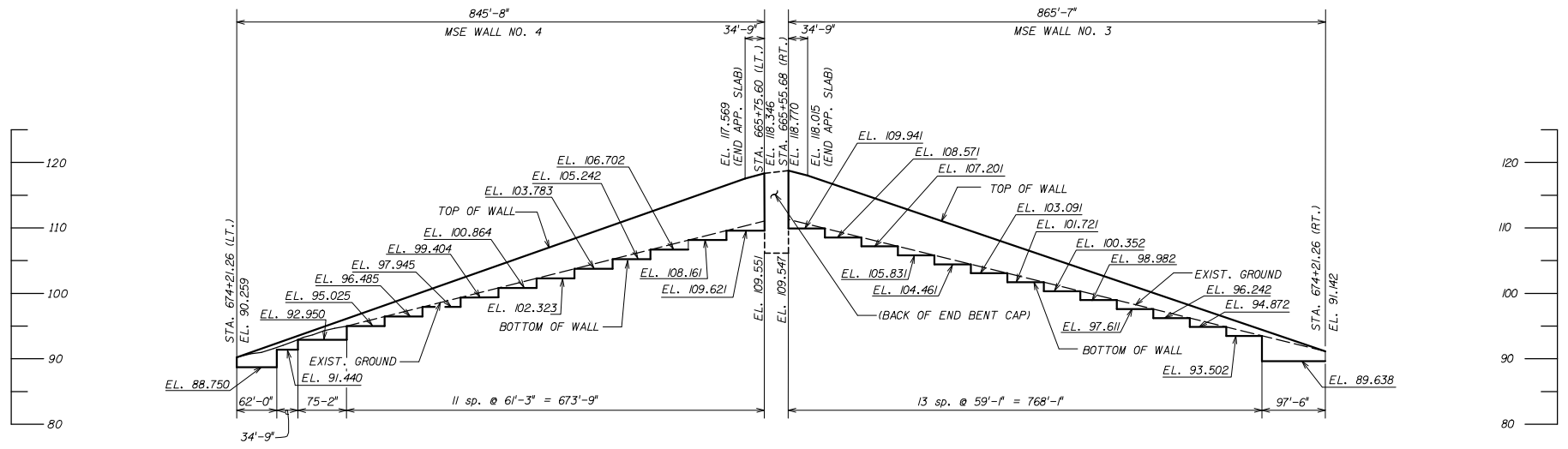

EXPANDED ELEVATION VIEWS (TEMP. MSE WALL NOS. 3 & 4, LOOKING AT FRONT FACE OF WALL)

EXHIBIT CP-8
Date: 1/1/06

REVISIONS				NAMES		DATES		ENGINEER OF RECORD			FLORIDA DEPARTMENT OF TRANSPORTATION			SHEET TITLE	
DATE	BY	DESCRIPTION	DATE	BY	DESCRIPTION	DRAWN BY	CHECKED BY	DESIGNED BY	APPROVED BY	ROAD NO.	COUNTY	FINANCIAL PROJECT ID	PROJECT NAME	SHEET NO.	
													TEMPORARY MSE WALL NOS. 3 & 4		

#USER# #DATE# #TIME# #FILE#

Chapter 23

Signing and Pavement Marking Plans

23.1	General	23-1
23.2	Key Sheet.....	23-2
23.3	Tabulation of Quantities and Pay Item Notes.....	23-3
23.4	General Notes	23-4
23.5	Plan Sheets	23-5
23.5.1	Format and Scale.....	23-5
23.5.2	Required Information	23-5
23.6	Guide Sign Worksheet	23-7
23.7	Sign Supports.....	23-8
23.7.1	Multi-Post Signs	23-8
23.7.2	Overhead Sign Cross Section and Support Structure	23-8
23.8	Typical Pavement Marking Sheet	23-9
23.9	Plans for Thermoplastic Markings.....	23-10
Exhibits		
Exhibit 23-1	Standard Notes for Signing and Pavement Marking Plans	23-11

THIS PAGE LEFT BLANK INTENTIONALLY

Chapter 23

Signing and Pavement Marking Plans

23.1 General

Signing and pavement marking plans are usually a component set of plans. Projects with minor signing and pavement markings may include these features on sheets in the roadway plan set or detailed on roadway sheets. When prepared as component plans they shall be assembled as a separate plans set complete with a key sheet, tabulation of quantities and all other signing and pavement marking sheets. When prepared as component plans, the sheets shall be numbered consecutively with the sheet numbers prefixed by the letter "S".

A complete set of signing and pavement marking plans shall include the following sheets:

1. Key Sheet
2. Tabulation of Quantities
3. Plan Sheets
4. Guide Sign worksheet (if required)
5. Overhead Sign Cross Section Sheet (if required)
6. Overhead Sign Support Design (if required)
7. Foundation Details (if required)
8. Boring Data Sheets (if required)

In addition, the signing and pavement marking plans may contain sheets which were prepared separately (perhaps by a sub-consultant) and incorporated into the roadway plans early in the design process. These sheets will appear at the end of the numbered sequence of the roadway plans and must be identified with the following prefixes:

GS-# Soil Survey and Report of Core Borings normally associated with the signing and pavement marking plans set (including miscellaneous structures but excluding bridges and walls)

Pavement marking material on projects that include new asphalt surfaces will generally be paint, rather than thermoplastic. This is based on the requirement of a 90-day curing period for new asphalt. Thermoplastic markings on these projects must be placed using a

separate contract. Exceptions must be coordinated with the District Construction Office.

Section 23.9 provides guidance for preparation of separate plans for Thermoplastic Markings.

Thermoplastic may be called for in the plans on those projects that are exclusively of concrete pavement surfaces.

23.2 Key Sheet

The key sheet is the first sheet in the set and shall be prepared on a standard key sheet format as described in **Chapter 3** of this volume. Contract plans set information, location map and length of project box are not required on this sheet when shown on the lead key sheet. A complete index of signing and pavement marking plans shall be shown on the left side of the sheet.

Other data, including name, consultant contract number, vendor number, and certificate of authorization number of the firm (when plans are prepared by a consultant) shall be shown as described in **Chapter 3** of this volume.

If shop drawings are anticipated, the name(s) and address(es) of the Delegated Engineer(s) for shop drawing review(s) shall be shown on the right side of the sheet.

23.3 Tabulation of Quantities and Pay Item Notes

The tabulation of quantities sheet shall be prepared on the standard plan format and shall show quantities, standard sign numbers, pay item numbers (except for pavement markings pay items) and size of sign for all pay items. The sign size and standard sign number is not required if shown in the plans sheets. Pay items shall be listed in numerical order and quantities shall be tabulated per sheet or by station. Provisions shall be made to show the original and final quantities. Pay item notes shall also be shown on this sheet.

On contracts with multiple Financial Project ID's or federal aid and nonfederal aid quantities, provisions shall be made to tabulate and summarize their respective quantities.

The Painted Pavement Markings (Final Surface) Lump Sum pay item will include the cost of two (2) applications of all painted pavement markings and one (1) application of Retro-reflective Pavement Markers. Refer to **Section 710** of the **Standard Specifications** for detailed information. For these items, the Signing and Pavement Making tabulation of quantities sheet should show the detailed description of the pay item and the quantities for each pay item EXCEPT in lieu of the pay item number substitute an "*" in the Bid Item Number Column (see **Exhibit 23-1**).

A pay item note is included in the Roadway Plans as shown in **Exhibit 7-1** in **Chapter 7** of this Volume.

23.4 General Notes

General notes pertaining to signing and pavement markings may be shown on a separate plan format sheet. This sheet shall be placed behind the tabulation of quantities in the plans assembly. On minor projects, general notes may be combined with the tabulation of quantities sheet.

23.5 Plan Sheets

23.5.1 Format and Scale

The plan sheets shall be prepared on a standard plan format. The scale shall be such that all details are clear and legible. See the requirements of **Section 10.1** as a guide. For simple projects, or sections of a project, “stacking” multiple plans on one sheet is generally permitted if clarity and legibility are maintained. Stationing shall progress from left to right and multiple plan views shall be stacked from top to bottom.

A north arrow and scale shall be shown at a point of maximum visibility on the sheet. If two plans are “stacked” on one sheet, then each plan portion shall contain a north arrow and scale.

Typical drawings may be used on rural projects with long sections of roadway that show only edge and lane delineation lines. Detail sheets should be used to depict markings at intersections along with typicals to depict the remaining areas. Signs may be tabulated to indicate location and disposition.

23.5.2 Required Information

The basic information pertaining to roadway geometrics and project limits required on the signing and pavement marking plan sheets is the same as that required on the plan portion of the plan-profile sheets (**Chapter 10** of this volume). Topography and construction details need not be shown. Utilities, drainage, lighting, sidewalks, driveways, landscape features, etc. shall be checked for conflicts. Those that may cause conflicts with sign placement shall be shown.

All pavement markings shall be clearly shown and labeled with their widths, color and spacing specified. Either the begin and end pavement marking stations, with offset or the begin pavement marking station with offset and the total length of roadway for pavement marking shall be shown. The location of raised pavement markers and delineators shall be indicated by specifying the type, color, spacing, and limits of application by stations.

All regulatory, warning and directional signs shall be shown at the proper locations. Each sign face shall be shown in close proximity to its respective sign with a leader line connecting the sign location and sign face. Each sign face shall be oriented on the plan sheet to be read as viewed from the direction of travel along the roadway. The location of all signs shall be indicated by station or milepost.

The pay item number and standard sign designation, or assigned number if nonstandard, shall be shown for each sign.

Any signs to be mounted on signal span wires should be shown and listed on the signalization plan for illustration and placement purposes. Sign details should be included on the signing plans.

Begin and end stations shall be shown.

23.6 Guide Sign Worksheet

The sign face, with the complete message layout with legend spacing (vertical and horizontal), margins, border widths and corner radii shall be shown on the guide sign worksheet.

For multi-support roadside signs, cross sections are not required in the plans set, but the support data (size and average length) for each sign shall be tabulated on the guide sign worksheet.

This sheet should be prepared on the standard plan sheet format to any convenient scale that will preserve clarity and legibility. The number of signs that may be shown on a single sheet depends on the sign size and complexity. The format of the sheet is flexible as long as the information listed above is shown. The output from the Transoft **GuidSign** Program or a similar format may be used for the sheet.

23.7 Sign Supports

23.7.1 Multi-Post Signs

Standard foundations for multi-post signs are provided in the **Design Standards**. These foundations are based on the sign support size. However, the post size and length are not included in the **Design Standards** and must be included as a part of the design and shown in the plans.

23.7.2 Overhead Sign Cross Section and Support Structure

The sign cross section sheet shows the location of overhead sign(s) in cross section. A standard profile format should be utilized. The cross section of the roadway at the sign location shall be shown and fully dimensioned. The recommended scale for the cross section is 1" = 10' horizontally and vertically.

For overhead signs, the design of the support truss, columns and foundations, along with the boring data information, shall be included in the signing and marking plans. The "Cantilever Sign Structures Data Table" and the "Span Sign Structures Data Table" work in conjunction with **Index Nos. 11310 and 11320** of the **Design Standards**. These tables include the information noted above and should be completed by the Structures Design Engineer of Record and inserted as a sheet in the plans.

A computer program for the design of overhead cantilever sign structures and a program for the design of overhead span sign structures are available. The programs were developed by the Structures Design Office and may be downloaded from the Structures Design web site.

The design of the attachment system for signs mounted on bridge structures shall be the responsibility of the Structures Design Engineer of Record. The design shall be included in the structures plans if bridge work is included in the project. If bridge work is not in the project, design details shall be included in the signing and pavement marking plans.

23.8 Typical Pavement Marking Sheet

For simple projects, or sections of a project, it may be possible to show signing and pavement marking plan details schematically using straight-line format and typical markings. All signs shall be properly identified and shown at their graphic location on the straight-line diagram. Pavement markings shall be shown and labeled on a typical marking plan.

23.9 Plans for Thermoplastic Markings

As discussed under **Section 23.1**, placement of thermoplastic markings on most projects will require a separate contract to be let after original construction (and striping with paint) is complete. For convenience and economy several projects may be let under one contract.

As a minimum, contract plans will consist of a Key Sheet, Summary of Pay Items, Tabulation of Quantities and details about the areas to be marked. This will include any changes in pavement markings that may have occurred since completion of the original project. The scope and final content of the plans shall be as directed by the district.

Exhibit 23-1 Standard Notes for Signing and Pavement Marking Plans

Add the following note at the bottom of the Tabulation of Quantities sheet:

- * These quantities are paid for under Painted Pavement Markings (Final Surface), Lump Sum - Item No. 710-90. The quantities shown are for one application; see **Specification 710** for the number of applications required.

THIS PAGE LEFT BLANK INTENTIONALLY

Chapter 24

Signalization Plans

24.1	General	24-1
24.2	Key Sheet.....	24-2
24.3	Tabulation of Quantities and Standard Notes	24-3
24.4	General Notes	24-4
24.5	Plan Sheets	24-5
	24.5.1 Format and Scale.....	24-5
	24.5.2 Required Information	24-5
24.6	Interconnect/Communication Plan	24-7
24.7	Mast Arm Sheets.....	24-8
24.8	Monotube Sheets	24-13

THIS PAGE LEFT BLANK INTENTIONALLY

Chapter 24

Signalization Plans

24.1 General

Signalization Plans are usually a component set of plans. Projects with minor signalization may include these features on sheets in the roadway plans set or on the roadway sheets (or in another component plans set or on that component's sheets when appropriate). When prepared as component plans they shall be assembled as a separate plans set complete with a key sheet, tabulation of quantities and all other relevant signal sheets. When prepared as component plans, the sheets shall be numbered consecutively with the sheet numbers prefixed by the letter "T".

The signalization plans show the construction details, electrical circuits, signal phasing and other relevant data.

A complete set of signalization plans shall include the following sheets:

1. Key Sheet
2. Tabulation of Quantities
3. Plan Sheets
4. Mast Arm Details (if required)
5. Foundation Details - Mast Arms (if required)
6. Boring Data Sheets - Mast Arms (if required)

In addition, the signalization plans may contain sheets which were prepared separately (perhaps by a sub-consultant) and incorporated into the roadway plans early in the design process. These sheets will appear at the end of the numbered sequence of the roadway plans and must be identified with the following prefixes:

- GT-# Soil Survey and Report of Core Borings normally associated with the signalization plans set
- PTM-# Portable Traffic Monitoring Site Sheets

24.2 Key Sheet

The key sheet is the first sheet in the component plans set and shall be prepared as described in **Chapter 3** of this volume. The location map, length of project box and contract plans set information are not required on this sheet when shown on the lead key sheet. The index of signalization plans shall be shown on the left of the sheet. Other data, including name, consultant contract number, vendor number, and certificate of authorization number of the firm (when plans are prepared by a consultant), shall be shown as described in **Chapter 3** of this volume.

If shop drawings are anticipated, the name(s) and address(es) of the Delegated Engineer(s) for shop drawing review(s) shall be shown on the right side of the sheet.

24.3 Tabulation of Quantities and Standard Notes

The tabulation of quantities sheet lists the item numbers, description and quantity of materials. This sheet shall be placed behind the key sheet in plans assembly.

Pay item numbers shall be listed in numerical order. Provisions shall be made to show the original and final quantities per sheet or by station. Pay item notes and general notes that refer to item numbers, description of work to be performed and quantity estimates shall also be shown on this sheet. If space is limited, notes may be shown on a General Notes Sheet.

On contracts with multiple Financial Project ID's, or Federal Aid and non-Federal Aid quantities, provisions shall be made to tabulate and summarize their respective quantities.

24.4 General Notes

The general notes sheet lists special signal design information such as controller operations, loop installations, signal heads, interconnect cable, and computer interface that is generally not covered in the FDOT Standard Specifications, Supplement or Special Provisions. This sheet shall be placed behind the tabulation of quantities in the plans assembly. On minor projects, general notes may be combined with the tabulation of quantities sheet.

24.5 Plan Sheets

24.5.1 Format and Scale

Signalization Plans shall be prepared on standard plan format at a scale large enough to show all details clearly and legibly. The recommended scale is 1" = 40' or 1" = 50'. Usually, the complete intersection shall be shown on one plan sheet. However, for large intersections more sheets may be used with appropriate match lines. A north arrow and scale shall be shown at a point of maximum visibility on the sheet.

24.5.2 Required Information

The basic information requirements include roadway geometrics, street names, construction stationing or milepost, curb and gutter, drainage inlets, sidewalks and right of way lines as similarly required on the plan portion of the roadway plan-profile sheets. Those underground and overhead utilities, signing structures, and lighting structures that may cause construction conflicts with signal components shall be shown. All locations, including existing trees, should be checked for potential conflicts.

The plan sheet shall also show:

1. Signal head locations with directional arrows and movements (movements 2 and 6 shall be the major streets).
2. Details of signal heads in tabular form with pay item numbers.
3. Phasing diagram/signal operating plan (NOTE: If the SOP conforms to the ***Index No. 17870*** of the ***Design Standards***, then the reference to the index is all that is required. For all other operating plans, the plan shall be shown).
4. Signal controller timing chart.
5. Loop detectors.
6. Electrical service location.
7. Location of signal poles and span wires (ground elevation and elevation of roadway crown).
8. Signal wire signs.
9. Pedestrian signals.
10. Turning radii.

11. Median nose locations.
12. Location of "stop bars" and pedestrian crosswalks.
13. Coordination unit-timing chart.
14. Lane lines with directional arrows.

All equipment shown on the plan shall be clearly labeled and their respective pay item numbers and quantity indicated.

A separate signalization plan shall be prepared for each signalized intersection included in the construction project.

Any span wire or mast arm mounted signs shall be coordinated with the appropriate signing and pavement marking plans to avoid duplication.

The sign details for signs must be included on the signalization plans, if signing and pavement markings are not included in the plans package.

24.6 Interconnect/Communication Plan

The interconnect/communication plan is required when signal equipment is being coordinated with other signal installations or with a computerized system. The interconnect/communication plan shows pictorially the placement of interconnect/communication cable, either underground or aerial, and tabulates all related interconnect quantities. The interconnect/communication plan sheet shall indicate all signal poles, service poles, and/or joint-use poles to which interconnect/communication cable will be attached.

The interconnect/communication plan shall be prepared on standard plan format. Unless otherwise approved, the preferred scale of the interconnect/communication plan shall be 1" = 100' for underground cable, and 1" = 200' for aerial cable. For simple projects, or sections of a project, "stacking" two plans on one sheet is generally permitted if clarity and legibility are maintained. Stationing shall progress from left to right and multiple plan views shall be stacked from top to bottom.

A north arrow and scale shall be shown at a point of maximum visibility on the sheet. If two plans are "stacked" on one sheet, each plan portion shall contain a north arrow and scale.

The basic plan information requirements include roadway schematic, showing cross streets and driveways, cable information, pole location, pole number, utility pole identification number, pay item number and quantity.

24.7 Mast Arm Sheets

The Mast Arm Tabulation Sheet, completed by the signal designer, and the “Standard Mast Arm Assemblies Data Table”, and the Structures CADD cell table completed by the structures designer, will be included in the plans. These are the only plan sheets required for mast arm assemblies which meet the Department's Standard and are included on the Qualified Products List. The structures data table may be placed on a signal plan sheet, if space permits. Mast arm assemblies that do not meet the mast arm standard will require a special design. The completed “Special Mast Arm Assemblies Data Table” will be included in the plans for special designs.

The following instructions are for use with the Mast Arm Tabulation Sheet:

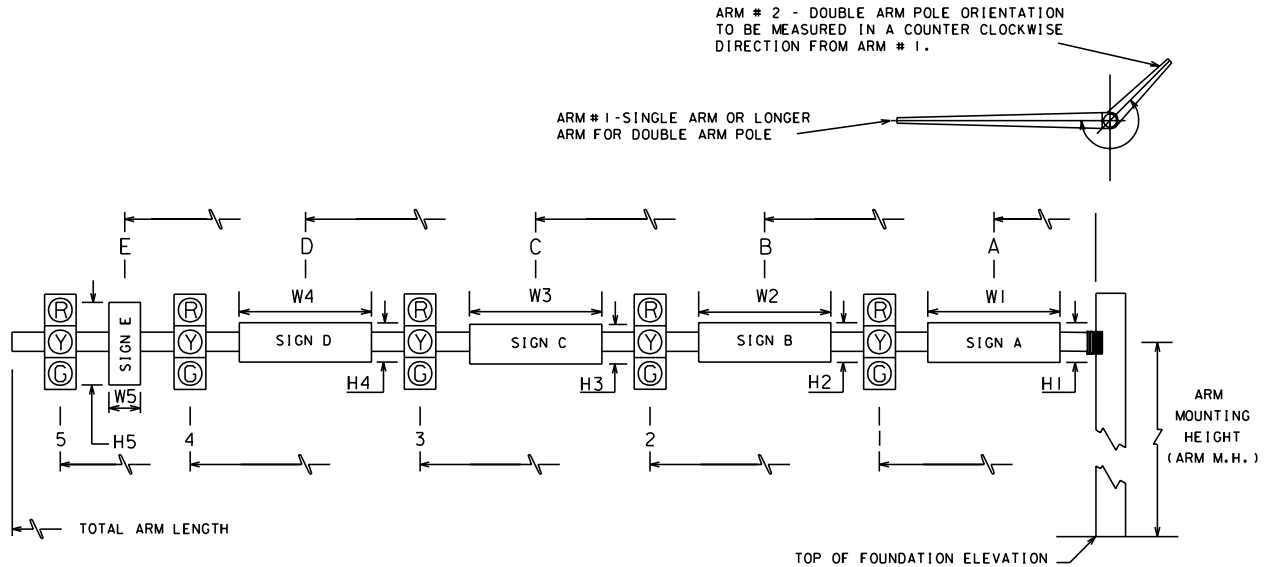

1. Each mast arm assembly is identified by a unique ID number.
2. Dimensions 1-5 are for signals and dimensions A-E are for signs. Record the distance from the edge of the pole, at ground level, to the center of the signal or sign.
3. Signals may be mounted vertically or horizontally. Indicate the mounting in the appropriate column in the table.
4. The entire line for arm #2 and the space for the angle between dual arms are left blank for single arm assemblies.
5. All arms and poles will be galvanized. If a color is required, indicate the color in the table, otherwise leave blank.
6. Starting at the pole, select the signals and/or signs that match the configuration you are tabulating. The spaces representing the signs or signals not used will be blank. Example 1: If no sign is located between the pole and signal 1, the spaces for Sign A would be blank. Example 2: A configuration for three signals and one sign between signal 1 and signal 2 - Only the spaces for signals 1, 2, 3 and sign B would be completed; the others will be blank.
7. Record the number of sections in each signal head in the space following the distance to that head.
8. Record the height and width of each sign in the space following the distance to the sign.

Following are examples for use with the Standard Mast Arm Assemblies Data Table:

EXAMPLE 1

Single Arm Structure as shown,
90 mph Wind Speed with Signal Backplates.

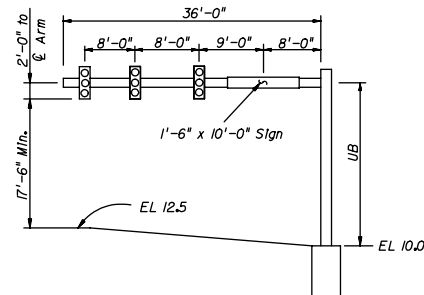

EXAMPLE 2

First Arm Structure as shown, Second Arm same as Example 1
except 110 mph Wind Speed with Signal Backplates.

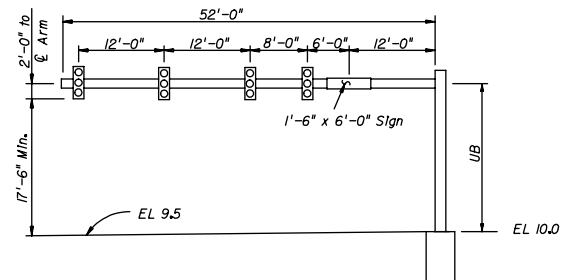

STANDARD MAST ARM ASSEMBLIES DATA TABLE															
STRUCTURE ID NUMBERS	ASSEMBLY (1)	FIRST ARM			SECOND ARM			UF (deg)	LL (deg)	POLE			SPECIAL DRILLED SHAF		
		ARM TYPE	FAA(2) (ft.)	FBA(2) (In.)	ARM TYPE	FAA(2) (ft.)	FBA(2) (In.)			POLE TYPE	UAA(3) (ft.)	UB (ft.)	UCA(3) (In.)	DA (ft.)	DB (ft.)
Example 1	C1 - R1	C1								R1		22			
Example 2	B5 - B2 - Q3	B5	28	9.08	B2			270		Q3	22	20	18.92		

TABLE NOTES:

(1) Assembly Number Legend

Single Armz
Arm Type - Pole Type = B# - Q#
= C# - R#

Double Armz
First Arm Type - Second Arm Type - Pole Type = B# - B# - Q#
= C# - C# - R#

(2) If an entry appears in columns "FAA" and "FBA", a shorter arm is required. This is obtained by removing length from the arm tip. For these cases the mast arm length shall be shortened from "FA" to "FAA" and the tip diameter shall be increased from "FB" to "FBA".

(3) If an entry appears in columns "UAA" and "UCA", a shorter pole is required. This is obtained by removing length from the pole tip. For these cases the pole height shall be shortened from "UA" to "UAA" and the pole tip diameter shall be increased from "UC" to "UCA".

(4) The foundations for Standard Mast Arm Assemblies are pre-designed and are based upon the following conservative soil criteria which covers the great majority of soil types found in Florida. Only complete the "Special Drilled Shaft Data" information if site conditions dictate drilled shafts with additional foundation capacity.

Classification = Cohesionless (Fine Sand)
Friction Angle = 30 Degrees (30°)
Unit Weight = 50 lbs./cu. ft. (assumed saturated)

EXAMPLE 1

1. Select Arm Type.

Investigate Arm C1. Compare attachment sizes and locations with design loading tree in **Figure 29.3** of **Volume 1**. All signals and signs are no further from the pole than shown in the Arm C1 design loading tree. Select Arm Type C1.

2. Select Pole Type.

Use Pole Selection Tables in **Index 17743** of the **Design Standards**. Select Pole Type R1.

3. Determine Arm Mounting Height.

$UB + 10' = 12.5' + 17.5' \text{ min.} + 2'$
 $UB = 22' \text{ min.}$ Use 22'

EXAMPLE 2

1. Select First Arm Type.

Designate longest arm as First Arm. For 52' arm, investigate Arm B5. Compare attachment sizes and locations with design loading tree. All signals and signs are no larger than and are no further from the pole than shown in the Arm B5 design loading tree. Select Arm Type B5.

2. Specify shorter arm.

Enter 28' under FAA.

$$\text{FAA} + \text{FE} - \text{Splice} = 28' + 26' - 2' = 52'$$

Determine actual tip diameter.

$$\text{FBA} = \text{FB} + (60' - 52') \times \text{taper} = 7.96'' + 8' (0.14''/\text{ft}) = 9.08''$$

3. Select Second Arm Type.

Select Arm Type B2.

4. Enter angle between arms.

Angle UF is measured counter-clockwise from the First Arm and must be either 90° or 270°.

5. Select Pole Type.

Use Pole Selection Tables. Select Pole Type Q3.

6. Determine Arm Mounting Height.

$$\text{UB} + 10' = 9.5' + 17.5' \text{min.} + 2'$$

$$\text{UB} = 19' \text{ min. Use } 20'$$

7. Specify shorter pole.

Enter 22' under UAA.

Determine actual tip diameter.

$$\text{UCA} = \text{UC} + (24' - 22') \times \text{taper} = 18.64'' + 2' (0.14''/\text{ft}) = 18.92''$$

24.8 Monotube Sheets

The Monotube Tabulation Sheet, completed by the signal designer, and the “Standard Monotube Signal Structure Data Table”, and the Structures CADD cell table completed by the structures designer will be included in the plans. These are the only plan sheets required for Monotube assemblies which meet the Department's Standard and are included on the Qualified Products List. The structures data table may be placed on a signal plan sheet, if space permits. Monotube assemblies which do not meet the mast arm standard will require a special design. The Structures Design Engineer will provide all design details for a special design to be included in the plans. For a special design, place a note in the plans stating “Shop drawings will be required.”

THIS PAGE LEFT BLANK INTENTIONALLY

Chapter 25

Lighting Plans

25.1	General	25-1
25.2	Key Sheet.....	25-2
25.3	Tabulation of Quantities and Standard Notes	25-3
25.4	Pole Data and Legend Sheet	25-4
25.5	Plan Sheets	25-5
25.5.1	Format and Scale.....	25-5
25.5.2	Required Information	25-5
25.6	Foundations and Boring Detail Sheets.....	25-7

THIS PAGE LEFT BLANK INTENTIONALLY

Chapter 25

Lighting Plans

25.1 General

Lighting Plans are usually a component set of plans. Projects with minor lighting may include these features on sheets in the roadway plan set or detailed on the roadway plans. When prepared as component plans they shall be assembled as a separate plans set complete with a key sheet, tabulation of quantities and all other relevant lighting sheets. When prepared as component plans, the sheets shall be numbered consecutively with the sheet numbers prefixed by the letter "L".

The lighting plans shall show the construction details, electrical circuits, pole data, conduits, service points, luminaires, foundations, boring details and other relevant data.

A complete set of lighting plans shall include the following sheets:

1. Key Sheet
2. Tabulation of Quantities
3. Pole Data and Legend Sheet
4. Plan Sheets or Layout Sheets
5. Foundation Details - High Mast (if required)
6. Boring Data Sheets - High Mast (if required)

In addition, the lighting plans may contain sheets which were prepared separately (perhaps by a sub-consultant) and incorporated into the roadway plans early in the design process. These sheets will appear at the end of the numbered sequence of the roadway plans and must be identified with the following prefixes:

GL-# Soil Survey and Report of Core Borings normally associated with the lighting plans set

25.2 Key Sheet

The key sheet is the first sheet in the component plans set and shall be prepared as described in **Chapter 3**. The location map, length of project box and contract plans set information are not required on this sheet when shown on the lead key sheet. Index of lighting plans shall be shown on the left of the sheet. Other data, including name, consultant contract number, vendor number, and certificate of authorization number of the firm (when plans are prepared by a consultant), shall be shown as described in **Chapter 3**.

If shop drawings are anticipated, the name(s) and address(es) of the Delegated Engineer(s) for shop drawing review(s) shall be shown on the right side of the sheet.

25.3 Tabulation of Quantities and Standard Notes

The tabulation of quantities sheet lists the item numbers, description and quantity of materials. This sheet shall be placed behind the key sheet in plans assembly.

Pay item numbers shall be listed in numerical order. Provisions shall be made to show the original and final quantities per sheet or by station.

On contracts with multiple Financial Project ID's, or Federal Aid and non-Federal Aid quantities, provisions shall be made to tabulate and summarize their respective quantities.

Pay item notes and standard notes that refer to item numbers shall also be shown on this sheet. General notes shall be shown on a separate plan format sheet. This sheet shall be placed behind the tabulation of quantities in the plans assembly. On minor projects, general notes may be combined with the tabulation of quantities sheet.

25.4 Pole Data and Legend Sheet

The pole data sheet shall be prepared on a standard plan format and shall include details and notes pertaining to pole placement and construction.

This sheet shall provide a listing of each pole by pole number. The following information shall also be given for each pole:

1. Circuit Number
2. Roadway Station and Offset
3. Arm Length
4. Luminaire Wattage
5. Mounting Height
6. Pay Item Number

The pay item number will indicate if the pole is a standard pole or a special design. Two pay item numbers are utilized: one for standard poles and one for non-standard poles.

The design values for light intensities and uniformity ratios shall be shown together with a legend and description of the symbols used on the plan sheets.

25.5 Plan Sheets

25.5.1 Format and Scale

The plan sheets shall be prepared on a standard plan format. The scale shall be such that all details are clear and legible. However, the scale shall not be smaller than 1" = 100'. For simple projects, or for narrow sections of a project, it may be possible to "stack" two plans on one sheet, one below the other. Stationing shall progress from left to right and shall be stacked from top to bottom. Clarity and legibility shall be preserved in all cases.

A north arrow and scale shall be shown at a point of maximum visibility on the sheet. If two plans are "stacked" on one sheet, each plan portion shall contain a north arrow and scale.

25.5.2 Required Information

The basic information pertaining to roadway geometrics and project limits required on the lighting plan sheets is the same as that required on the plan portion of the roadway plan-profile sheets. Topography and construction details need not be shown. Utilities, drainage, signal structures, sign structures, landscape features, sidewalks, driveways, etc. shall be checked for conflicts. Those that may cause conflicts shall be shown.

The lighting layout shall be shown on the plan format. This shall be accomplished by symbols which represent poles, conduits and service points. The symbols used shall be in accordance with the requirements of the FDOT Engineering/CADD Systems Software and shall be used throughout the plans. A flag or note shall be used to identify conduit runs with conductor size or numbers different than that shown on the pole data sheet legend.

The beginning and ending of the lighting limits shall be shown on the appropriate plan sheet(s). The symbols for poles shall be shown at the correct baseline or centerline station and the approximate offset from the roadway noted.

The poles shall be flagged and specific information for each pole shall be shown. The pole number, baseline or centerline station, circuit number and offset from baseline or centerline (for high mast) shall be shown.

The service point locations shall be shown on the plan sheets as determined through utility negotiations. **Index No. 17504** of the **Design Standards** provides details for the service

point. The service point shall be shown at the location where it is to be installed. The following information is not covered on the index and must be shown on the plan sheet:

Description--voltages, phases, etc. Ex: 240/480 Volt, 3 wire, Overhead Breaker sizes--The main breaker size and the number of branch circuits and the breaker size of each.

25.6 Foundations and Boring Detail Sheets

The foundation design for standard conventional poles is shown in the ***Design Standards, Index 17515*** and ***Index 17503*** for non-standard conventional poles. These foundations do not need to be shown in the plans. Foundations for high mast poles are not in the Standards and must be designed by the responsible structures design engineer of record.

Plans showing the foundation details and boring data for high mast poles shall be included in the lighting plans.

THIS PAGE LEFT BLANK INTENTIONALLY

Chapter 26

Landscape Plans

26.1	General	26-1
26.2	Key Sheet.....	26-2
26.3	Tabulation of Quantities and Schedule	26-3
26.3.1	Tabulation of Quantities and Plant Schedule	26-3
26.3.2	Tabulation of Quantities and Schedule for Irrigation and Site Amenities	26-3
26.4	General Notes	26-4
26.5	Plan Sheets	26-4
26.5.1	Format and Scale.....	26-4
26.5.2	Requirements for Plan Sheets	26-4
26.6	Details Sheet.....	26-6

Tables

Table 26.1	Example Tabulation of Quantities and Schedule for Irrigation and Site Amenities	26-3
------------	--	------

THIS PAGE LEFT BLANK INTENTIONALLY

Chapter 26

Landscape Plans

26.1 General

“Landscape” or “landscaping” means any vegetation, mulches, irrigation systems, and any site amenities, such as street furniture, decorative paving, fences, and lighting (excluding public utility street and area lighting). The Legislature has requested that the Department commit program dollars to landscaping. In order for the Department to capture that information, it is critical that all landscape pay items shall be placed in TRNS*PORT Category 0600 whether the landscape plans are a component set of plans, or prepared independently. Projects with minor landscaping may include these features on separate sheets in the roadway plans set or features may be detailed on roadway plans sheets. When prepared as component plans they shall be assembled as a separate plans set complete with a key sheet, tabulation of quantities, schedule, and all other relevant landscape sheets. When prepared as component plans, the sheets shall be numbered consecutively with the sheet numbers prefixed by the letters “LD”.

A complete set of landscape plans shall include the following:

1. Key Sheet
2. Tabulation of Quantities and Plant Schedule
3. Tabulation of Quantities and Schedule for Irrigation and Site Amenities
4. Plan Sheets
5. Details Sheet
6. Other relevant plan sheets as outlined in this chapter

26.2 Key Sheet

The key sheet is the first sheet in the component plans set and shall be prepared as described in **Chapter 3**. The location map, length of project box and contract plans set information are not required if shown on the lead key sheet. The index of landscape plans shall be shown on the left of the sheet. Other data, including name, consultant contract number, vendor number, and certificate of authorization number of the firm (when plans are prepared by a consultant) shall be shown as described in **Chapter 3**.

26.3 Tabulation of Quantities and Schedule

26.3.1 Tabulation of Quantities and Plant Schedule

The tabulation of quantities and plant schedule sheet or a similar sheet should be utilized to tabulate the materials required for the construction of the landscaping and provide the description, size and quantity of materials in a tabular format. The tabulation of quantities and plant schedule sheet is required to conform with the format of **Exhibit LD-1** and shall be prepared separately from the tabulation of quantities for irrigation and site amenities.

26.3.2 Tabulation of Quantities and Schedule for Irrigation and Site Amenities

The tabulation of quantities and schedule for irrigation and site amenities shall utilize the standard tabulation of quantities sheet and provide the additional information given in the example in **Table 26.1**.

Table 26.1 Example Tabulation of Quantities and Schedule for Irrigation and Site Amenities

Symbol	Quantity	Unit	Description / Remarks
LP	5000	LF	½" PVC Sch 40 (or C-160) zone / lateral pipe & appropriate fittings
PR	100	EA	6" pop-up rotor, nozzle, riser & appropriate fittings
CM	1	EA	Control module, latching solenoid, run shut-off device & appropriate fittings
ABB	5	EA	Arcata, backless bench, PolySite recycled plastic, Powdercoat 'Frost'
WCB	10	EA	Wausau Conical Bollard TF6071, B1 finish

On contracts with multiple Financial Project ID's or Federal Aid and non-Federal Aid quantities, provisions shall be made to tabulate and summarize their respective quantities.

26.4 General Notes

General notes pertaining to landscape plans may be shown on a separate plan format sheet. This sheet shall be placed behind the tabulation of quantities in the plans assembly.

26.5 Plan Sheets

Plan sheets shall be prepared in a manner that is consistent with a set of construction documents rather than an illustrative plan. Therefore plan sheets shall utilize simplified symbols depicting the location of materials in a legible manner. Plan sets shall employ a level of detail and clarity that allow the reviewer to assess the relationship between the proposed landscape design, the roadway plans, utilities, outdoor advertising signs, and adjoining land use.

26.5.1 Format and Scale

Plan sheets shall be prepared on a standard plan sheet format. The scale shall be such that all details are clear and legible. However, the scale shall not be smaller than 1" = 100'. For simple projects, or narrow sections of a project, it may be possible to "stack" two plans on one sheet, one below the other. Stationing shall progress from left to right and shall be stacked from top to bottom. Irrigation plan sheets may be prepared at a larger scale than the planting plan sheets. Clarity and legibility shall be preserved in all cases.

A north arrow and scale shall be shown, as applicable, at a point of maximum visibility on the sheet. If two plans are "stacked" on one sheet, each plan portion shall contain a north arrow and scale.

26.5.2 Requirements for Plan Sheets

The base information required is as follows:

1. Project centerline
2. Edge of pavement (edge of traffic lanes)
3. Curbs or curb and gutter
4. Drainage systems
5. Guardrails

6. Right of way and/or limited access fence line
7. Sidewalks or other planned or existing structures
8. Lighting, signs and signal poles
9. Intersections and driveways which are noted in the plans
10. Existing and proposed overhead and underground utility locations
11. Clear Zone/Horizontal clearance (should be plotted or safety setback distances noted frequently on each plan sheet)
12. View zones for permitted outdoor advertising signs
13. Canopy limits
14. Existing vegetation (to remain or be removed)
15. Existing off site features and conditions that affect or are affected by the project
16. Fence and gate locations
17. Setbacks from structural elements or drainage system
18. Limits of clear sight (***Index No. 546*** of the ***Design Standards***)
19. Transit Facilities

Planting plan sheets shall also provide at a minimum the plant symbols and the plant quantities. Additional information such as the common name and botanical name of each plant may be provided.

Site amenities, such as street furniture, decorative paving, fences, and lighting (excluding public utility street and area lighting) shall be included on the planting plan sheets with appropriate annotation.

Irrigation plan sheets shall be prepared using the planting plan sheets (devoid of unnecessary text and labeling) and shall contain information pertaining to the irrigation system. Information on the sheet shall include the approximate location of spray heads and rotors, valves, mainlines, lateral lines, sleeves, controllers, water sources / point of connection, backflow preventers, and isolation valves.

26.6 Details Sheet

This sheet shall show all landscape details, hardscape details and irrigation details, which are applicable to the project and not addressed in the ***Design Standards***.

The details sheet shall include a legend clearly depicting the symbology used in the irrigation plan sheets and an associative description for each entry. Additional information such as the nozzle schedule and irrigation zone / lateral schedule can be included on these sheets.

TABULATION OF QUANTITIES/PLANT SCHEDULE

PAY ITEM NO.	PAYSIZE	SYM	BOTANICAL NAME	COMMON NAME	INSTALLED SIZE	MAX. MAINTAINED SIZE	SPACING	REMARKS	UNIT	SHEET NUMBERS										TOTAL THIS SHEET		GRAND TOTAL	
										LD-5		LD-6		LD-7		LD-8		LD-9		PLAN	FINAL	PLAN	FINAL
										PLAN	FINAL	PLAN	FINAL	PLAN	FINAL	PLAN	FINAL	PLAN	FINAL				
570-1-2		SOD	STENOTAPHRUM SECUNDATUM	ST. AUGUSTINE GRASS				LAY SOLIDLY IN ALL INDICATED AREAS	SY	330.78		140.89		346.11		4193.44		44		5055.22		5055.22	
580-1-1	SMALL	AG	ARACHIS GLABRATA	PERENNIAL PEANUT	1 GAL.	6" HT.	18" OC	MOW REGULARLY TO PROMOTE FLOWERING	EA	1655		1118		2729		0		334		5836		5836	
	SMALL	LEG	LIRIOPE MUSCARI "EVERGREEN GIANT"	EVERGREEN GIANT LIRIOPE	1 GAL.	16" HT.	24" OC	THIN BY PLANT DIVISION EVERY 3-5 YEARS	EA	434		381		0		805		0		1620		1620	
	SMALL	AS	ARISTIDA STRICTA	WIREGRASS	1 GAL.	2'-4' HT. 2'-3' SPREAD	2' OC	NO SERIOUS PESTS	EA	465		513		0		0		0		978		978	
	SMALL	IVD	ILEX VOMITORIA "SHELLINGS"	DWARF YAUPON	3 GAL.	3'-4' HT. 3'-4' SPREAD	3' OC	9 FEMALES TO 1 MALE/ MINIMAL PRUNING REQUIRED	EA	89		134		0		109		0		332		332	
	SMALL	HF	HERMERCALLIS FULVA	DAYLILY	1 GAL.	4' HT.	24" OC	THIN BY PLANT DIVISION EVERY 3-5 YEARS	EA	131		288		530		0		0		949		949	
	SMALL	TA	TRACHELOSPERMUM ASIATICUM	STAR JASMINE	1 QUART	2' HT. 4'-5' SPREAD	24" OC	TRIM TO MAINTAIN BEDLINES	EA	0		753		431		0		383		1567		1567	
	SMALL	CL	COREOPSIS	COREOPSIS	1 GAL.	3' HT.	24" OC	REMOVE DEAD STEMS	EA	0		0		0		453		0		453		453	
	SMALL	IV	IRIS VIRGINICA	SOUTHERN BLUE FLAG IRIS	1 GAL.	18" HT.	12" OC	THIN BY PLANT DIVISION EVERY 3-5 YEARS	EA	0		0		0		461		0		461		461	
580-1-2	LARGE	QV	QUERCUS VIRGINIANA	LIVE OAK	14' HT. 65 GAL.	40' HT.	AS SHOWN ON PLANS	2" MINIMUM CALIPER/ MINIMAL PRUNING REQUIRED	EA	7		1		0		9		0		17		17	
	LARGE	VO	VIBURNUM OBOVATUM	WALTER'S VIBURNUM	42" HT. 7 GAL.	6' HT.	48" OC	PRUNE TO MAINTAIN NATURAL SHAPE	EA	181		183		0		57		0		424		424	
	LARGE	LIS	LAGERSTROEMIA INDICA	CREPE MYRTLE STANDARD	8'-10' HT. 30 GAL.	20' HT.	AS SHOWN ON PLANS	MULTI-TRUNK 3" MINIMUM CALIPER/" PER BRANCH	EA	0		13		2		0		3		18		18	
	LARGE	IOE	ILEX OPACA "EAST PALATKA"	EAST PALATKA HOLLY	12' HT. 30 GAL.	25' HT.	AS SHOWN ON PLANS	9 FEMALES TO 1 MALE/ MINIMAL PRUNING REQUIRED	EA	0		3		0		0		0		3		3	
	LARGE	TD	TAXODIUM DISTICHUM	BALD CYPRESS	8' HT. 30 GAL.	50' HT.	AS SHOWN ON PLANS	2" MINIMUM CALIPER/ MINIMAL PRUNING REQUIRED	EA	0		0		0		3		0		3		3	
	LARGE	BN	BETULA NIGRA	RIVER BIRCH	12' HT. 30 GAL.	50' HT.	AS SHOWN ON PLANS	2" MINIMUM CALIPER/ WELL SHAPED	EA	0		0		0		3		0		3		3	

Pay size in accordance with the Basis of Estimates Handbook

Small plants Include:

1. All ground covers
2. Shrubs to less than 7 gallon
3. Trees to less than 7 gallon
4. Palms clustering type less than 6 foot overall height
5. Cycads to less than 7 gallon

Large plants Include:

1. Shrubs 7 gallon or greater
2. Trees 7 gallon and greater
3. All palms single trunk
4. Palms clustering type 6 foot overall height and greater
5. Cycads 7 gallon or greater
6. All sabal palms (a.k.a. sabal palmetto, cabbage palm, state tree)

EXHIBIT: LD-1
Date: 1/1/06

REVISIONS						STATE OF FLORIDA DEPARTMENT OF TRANSPORTATION			TABULATION OF QUANTITIES/ PLANT SCHEDULE	SHEET NO.
DATE	BY	DESCRIPTION	DATE	BY	DESCRIPTION	ROAD NO.	COUNTY	FINANCIAL PROJECT ID		

#USERS

#DATES

#TIMES

#FILES

Chapter 27

Utility Joint Participation Agreement Plans

27.1	General	27-1
27.2	Key Sheet.....	27-2
27.3	Tabulation of Quantities	27-3
27.4	Plan Sheets.....	27-4

THIS PAGE LEFT BLANK INTENTIONALLY

Chapter 27

Utility Joint Participation Agreement Plans

27.1 General

Most utility adjustment work is performed by the utility owners or their contractor. In some cases it is advantageous to the FDOT and Utility to include the utility work as part of the roadway contract. In such cases the FDOT will enter into an agreement with a Utility for this purpose. These agreements are called Joint Participation Agreements or JPAs. The highway contractor is required to construct or relocate the specified utilities in accordance with the plans and special provisions developed by the Utility and incorporated as part of the bid package. More than one utility plans set may be included. For example, the contract plans may include separate plans for a gas utility and a water utility. It is also possible for the utilities to combine their individual facilities into one plans set and supply them to the FDOT. It is essential that the Engineer of Record (EOR) be aware which method is to be used. This is necessary because reimbursable costs and quantities must be separated and identified in each utility project.

Occasionally utility work may extend outside the normal construction limits of the project. When this is the case the limits of the utility work shall be shown or noted on the plans.

For JPAs, the utility plans shall be prepared in the same basic format as FDOT plans and as a separate plans set. The plans shall contain the following:

1. Key Sheet
2. Tabulation of Quantities
3. Plan-Profile Sheets
4. Cross Sections (as required)
5. Detail Sheets (as required)

The plans shall also reflect any special technical or relocation agreement provisions. In some cases it may not be practical or reasonable to develop separate plans sets for incidental construction under a JPA. The EOR should consult with the District Utility Engineer to determine the requirements in these cases. For further guidance, the FDOT's *Utility User's Handbook* and the *JPA Handbook* should be used.

27.2 Key Sheet

The key sheet, which shall be the first sheet in the set, shall be prepared on a standard key sheet format as described in **Chapter 3** of this volume. Contract plans set information, location map and length of project box are not required if shown on the lead key sheet (usually roadway). An index of plan sheets shall be shown on the left side of the utility plans key sheet. The date of the governing **Standard Specifications for Road and Bridge Construction** and the **Design Standards** shall be inserted in a note at the lower left corner of the key sheet. The applicable Design Standards Modifications and date, and Internet address shall be shown on the lower left corner of the lead Key Sheet, below the Governing Specifications and Standards note.

In the Financial Project ID, the phase number 56 indicates reimbursable work, and 52 indicates non-reimbursable work. All other data shall be as described in **Chapter 3** of this volume.

27.3 Tabulation of Quantities

The tabulation of quantities sheet shall be prepared in standard FDOT format and should show any quantities tabulated for location, size, quantity, etc. Standard notes referring to item numbers shall also be shown on this sheet or on plan sheets.

Summary of pay item sheets will be prepared as noted in **Chapter 4** of this volume.

27.4 Plan Sheets

Utility plans shall show full construction details for all utilities to be relocated or constructed by the contractor as covered by the JPA. A plan-profile sheet format should be utilized where appropriate. All underground utilities shall be shown in the plan portion, and those which equal or exceed 4" shall also be shown in the profile portion. All above ground Utilities shall be shown in the plan portion (inclusive of underground connections).

When the construction limits are restricted such as when a power line is above and near a sanitary or water facility, either the facility (overhead lines) must be identified and shown in profile, or the minimum available vertical clearances, along with the type facility, stated on the plans. Applicable project information shall be shown similar to that described in **Chapter 10** of this volume. Utilities to be relocated or constructed shall be shown in plan and profile and in accordance with the FDOT Engineering/CADD Systems Software. When practical, the scale used should be the same as that used for the roadway plan-profile sheets.

The disposition and final ownership of any utility infrastructure that is to be removed by the contractor and salvaged shall be identified in the plans. The address of the Utility/Agency Owner receiving the salvaged utility infrastructure shall be included in the pay item notes on the Summary of Quantity Sheet (see **Exhibit 7-1**).

Chapter 28

Stormwater Pollution Prevention Plan

28.1	General	28-1
28.2	Narrative Description.....	28-2
28.3	Site Map	28-4
28.4	Controls.....	28-5
28.5	Maintenance, Inspection and Non-Stormwater Discharges	28-6

THIS PAGE LEFT BLANK INTENTIONALLY

Chapter 28

Stormwater Pollution Prevention Plan

28.1 General

The Stormwater Pollution Prevention Plan (SWPPP) sheets document the designer's site evaluation and selection of control measures and other items to comply with the terms and conditions of the State of Florida Department of Environmental Protection Generic Permit for Stormwater Discharges from Large and Small Construction Activities (DEP Generic Permit) discussed in **Volume I, Chapter 11**. The SWPPP includes several items: a narrative description, the documents referenced in the narrative, a site map, the contractor's approved Erosion and Sediment Control Plan required by **Specification Section 104**, and reports of inspections made during construction.

For examples of SWPPP sheets, see **Exhibits SWP-1** thru **SWP-3**. Additional guidance for developing a SWPPP may be found in the DEP SWPPP template, found on the DEP web page at:

<http://www.dep.state.fl.us/water/stormwater/npdes/swppp.htm>

28.2 Narrative Description

The SWPPP sheets include a narrative that refers to other documents such as the **Standard Specifications** or the **Design Standards** as necessary. Use the following outline to prepare the narrative:

1. Site Description
 - a. A Description of the Construction Activity
 - b. Sequence of Major Soil Disturbing Activities
 - c. Area Estimates (The total project area and the area expected to be disturbed.)
 - d. Runoff Data consisting of:
 - 1) Rational runoff coefficient before, during, and after construction,
 - 2) The size of the drainage area for each outfall,
 - 3) The location of each outfall, in terms of latitude and longitude (to the nearest 15 seconds),
 - 4) Existing data describing the soil or the quality of discharge from the site
 - e. Site Map (Include a narrative of the site map as described in **Section 28.3**)
 - f. Receiving Waters (The name of the receiving waters for each outfall and the wetland area on the site.)
2. Controls
 - a. Erosion and Sediment Controls
 - 1) Stabilization Practices
 - 2) Structural Practices
 - b. Stormwater Management
 - c. Other Controls
 - 1) Waste Disposal
 - 2) Off-Site Vehicle Tracking & Generation of Dust
 - 3) State or Local Regulations
 - 4) Application of Fertilizers and Pesticides
 - 5) Toxic Substances
 - d. State and Local Plans

3. Maintenance
4. Inspection
5. Non-Stormwater Discharges

The sheets may also include supplemental design details and plan views of the location of the controls. Additional information for preparing the SWPPP sheets can be found in the ***FDOT Erosion and Sediment Control Handbook***.

28.3 Site Map

The following information shall be shown on a site map:

1. Drainage patterns
2. Approximate slopes
3. Areas of soil disturbance
4. Areas that are not to be disturbed
5. Locations of controls identified in the plan
6. Areas that are to be stabilized against erosion
7. Surface waters (including wetlands)
8. Locations where stormwater is discharged to a surface water

The above information is shown in a typical set of construction plans. A narrative description of the site map shall be prepared which identifies the construction plan sheets where the site map information required by the DEP Generic Permit can be found.

The locations of the temporary controls may be shown on SWPPP sheets, Erosion Control sheets, Plan-Profile sheets, or Traffic Control Plan (TCP) sheets. For projects where plan view sheets are not available, the locations of the controls shall be summarized in a tabular format.

If an optional Drainage Map is included in the construction plans, then the drainage patterns will be shown on it. If the Drainage Map is not included, a topographic map (for example, a USGS quadrangle map) showing contour lines shall be prepared. This map will supplement the construction plan sheets that show the other site map requirements. If this supplemental site map is not in aerial format, include it in the SWPPP sheets. If this supplemental site map is in aerial format, it cannot be placed in the contract plans set and must be delivered to the resident engineer to have available on site.

28.4 Controls

The SWPPP shall include a description of the controls that will be implemented at the construction site. For each of the major activities identified in **Part 1.b** of the **Narrative**, describe the timing of the implementation of control measures during the construction process. Also describe the stormwater management measures that will be installed during construction to control pollutants in the stormwater discharges that will occur after construction.

Details should be prepared for all controls that are not detailed in the **Design Standards**. The details should show the work intended, where and how the control is to be placed, and any other special design details. Any Technical Special Provisions required by the erosion control items of work should be prepared for the specification package.

The narrative for some of the other controls will be supplied by the contractor at the preconstruction conference. A plan for off-site vehicle tracking is an exception and must be included in the SWPPP prepared during design.

Any Water Management District or Local Water Management District permits obtained in connection with the project should be noted.

28.5 Maintenance, Inspection and Non-Stormwater Discharges

Include a description of any maintenance requirements that are not stated in the standard specifications. Include the inspection requirements, which will be either requirements of the DEP or the applicable requirements of another regulatory agency, whichever is more stringent. If special procedures have been developed to minimize turbidity associated with normal construction dewatering, include a description of those procedures.

Special monitoring requirements described in the DEP Generic Permit may apply where the project discharges to waters listed in **Section 303(d)** of the **Clean Water Act**. Consult with the district environmental permitting staff to determine if the monitoring requirements apply. If applicable, describe the special monitoring requirements in the inspection section of the narrative.

THIS EXHIBIT IS AN EXAMPLE NARRATIVE OF A STORMWATER POLLUTION PREVENTION PLAN (SWPPP) FOR A MAJOR RECONSTRUCTION PROJECT. ACTUAL PROJECT CONDITIONS OFTEN DICTATE DIFFERENT APPROACHES THAN SHOWN HERE. THE ENGINEER IS RESPONSIBLE FOR DEVELOPING A SITE SPECIFIC SWPPP THAT COMPLIES WITH VOLUME I CHAPTER II OF THE PLANS PREPARATION MANUAL.

The following narrative of the Stormwater Pollution Prevention Plan contains references to the Standard Specifications for Road and Bridge Construction, the Design Standards, and other sheets of these construction plans. The first sheet of the construction plans (called the Key Sheet) contains an Index to the other sheets. The complete Stormwater Pollution Prevention Plan includes several items: this narrative description, the documents referenced in this narrative, the contractor's approved Erosion Control Plan required by Specification Section 104, and reports of inspections made during construction.

1.0 SITE DESCRIPTION:

1.a. Nature of Construction Activity:

The project is the reconstruction of SR 007 (James Bond Boulevard) to a major urban roadway. This involves constructing roadway surface, curb and gutter, sidewalk, underground storm sewer systems, and stormwater management facilities. The project extends from north of Paul Russell Road to Perkins Street, a distance of approximately 1.1 miles.

1.b. Sequence of Major Soil Disturbing Activities:

In the Section 104 Erosion Control Plan, the contractor shall provide a detailed sequence of construction for all construction activities. The contractor shall follow the sequence of major activities described below, unless the contractor proposes a different sequence that is equal or better at controlling erosion and trapping sediment and is approved by the Engineer.

For each construction phase, install perimeter controls after clearing and grubbing necessary for installation of controls but before beginning other work for the construction phase. Remove perimeter controls only after all upstream areas are stabilized.

1. Clearing and grubbing, earthwork, and storm sewer construction for the outfall from the ponds.
2. Clearing and grubbing, earthwork for pond construction.
3. Storm sewer and roadway underdrain construction. Construct the storm drain pipe in the upstream direction.
4. Earthwork associated with roadway, and construction of gravity wall, curb, subgrade, base, pavement, and sidewalk.
5. Construct underdrain in pond bottom.

1.c. Area Estimates:

Total site area: 19.6 acres.
Total area to be disturbed: 19.6 acres.

1.d. Runoff Data:

Runoff Coefficients: Before: 0.62.
During: varies from 0.62 to 0.76.
After: 0.76.

Soils Data: The results of the soil borings along the roadway are shown in the Roadway Soil Survey Sheet(s). The results of soil borings done in the ponds are shown on the Pond Detail Sheets. The numbers for these are identified on the Key Sheet of these construction plans. In general, the soils are clayey sands.

Outfall Information: There are 4 outfalls.

#1 Description: Existing pond at Laura Lee.
Location: Latitude 30° 24' 30", Longitude, 84° 16' 45".
Est. Drainage Area Size: 13.6 acres.
Receiving Water Name: Not applicable.

#2 Description: Pond 1. This discharges to the storm sewer system that runs under Orange Avenue. This system in turn discharges to the box culvert at Sta. 531+00.
Location: Latitude 30° 24' 45", Longitude 84° 17' 00".
Est. Drainage Area Size: 7.3 acres.
Receiving Water Name: East Ditch.

#3 Description: Box culvert at Sta. 531+00.
Location: Latitude 30° 24' 45", Longitude 84° 17' 00".
Est. Drainage Area Size: 4.2 square miles.
Receiving Water Name: East Ditch.

#4 Description: Pond 2. This discharges to the SR 007 storm sewer system that drains to the box culvert at Sta. 531+00.
Location: Latitude 30° 25' 00", Longitude 84° 17' 00".
Est. Drainage Area Size: 15.4 acres.
Receiving Water Name: East Ditch.

1.e. Site Maps:

The construction plans are being used as the site maps. The location of the required information is described below. The sheet numbers for the plan sheets referenced are identified on the Key Sheet of these construction plans.

* Drainage Patterns: The drainage basin divides and flow directions are shown on the Drainage Maps. The Back of Sidewalk Profile Sheets show overland flow direction at the right of way line. The arrows above and below the profile represent the flow direction at the left and right property line, respectively. Arrows pointing to the profile indicate runoff coming to the site. Pointing away from the site indicate runoff leaving the site.

* Approximate Slopes: The slopes of the site can be seen in the Cross Section Sheets and the Plan-Profile Sheets. There are pond cross sections located with the Pond Detail Sheets.

* Areas Of Soil Disturbance: The areas to be disturbed are indicated on the Plan-Profile Sheets, the Cross Section Sheets, and the Pond Detail Sheets. Any areas where permanent features are shown to be constructed above or below ground will be disturbed.

* Areas Not To Be Disturbed: Essentially the whole project will be disturbed during construction.

* Locations of Temporary Controls: These are shown on the Erosion Control Sheets except for the controls associated with the box culvert replacement which are shown on the Box Culvert Construction Detail Sheet. Tables providing summaries of temporary erosion and sediment control items are provided in the Summary of Quantity Sheets.

* Locations of Permanent Controls: The stormwater ponds are the primary permanent stormwater management controls. These are shown on the Pond Detail Sheets.

* Areas To Be Stabilized: Temporary stabilization practices are shown in the same location as the temporary controls mentioned above. Permanent stabilization is shown on the Typical Section Sheets, the Plan-Profile Sheets and the Pond Detail Sheets.

* Surface Waters: The only surface water within the site is the East Ditch, which flows through the culvert at Station 531+00. This is located on the Plan-Profile Sheets and the Box Culvert Construction Detail Sheet.

* Discharge Points To Surface Waters: There is only one. This is shown on the Plan-Profile Sheets at the East Ditch (culvert at Station 531+00).

1.f. Receiving Waters:

See Item 1.d for the outfall locations and receiving water names. There are no wetland areas on the project site.

EXHIBIT SWP-1
DATE: 1/1/06

REVISIONS						STATE OF FLORIDA DEPARTMENT OF TRANSPORTATION			STORMWATER POLLUTION PREVENTION PLAN	SHEET NO.
DATE	BY	DESCRIPTION	DATE	BY	DESCRIPTION	ROAD NO.	COUNTY	FINANCIAL PROJECT ID		

#USERS

#DATES

#TIMES

#FILES

THIS EXHIBIT IS AN EXAMPLE NARRATIVE OF A STORMWATER POLLUTION PREVENTION PLAN (SWPPP) FOR A MAJOR RECONSTRUCTION PROJECT. ACTUAL PROJECT CONDITIONS OFTEN DICTATE DIFFERENT APPROACHES THAN SHOWN HERE. THE ENGINEER IS RESPONSIBLE FOR DEVELOPING A SITE SPECIFIC SWPPP THAT COMPLIES WITH VOLUME I CHAPTER 11 OF THE PLANS PREPARATION MANUAL.

2.0 CONTROLS:

2.a. Erosion And Sediment Controls:

In the Section 104 Erosion Control Plan, the contractor shall describe the proposed stabilization and structural practices based on the contractor's proposed Traffic Control Plan. The following recommended guidelines are based on the Traffic Control Plan (TCP) outlined in the construction plans. Where following the Traffic Control Plan (TCP) outlined in these construction plans, the contractor may chose to accept the following guidelines or modify them in the Section 104 Erosion Control Plan, subject to approval of the Engineer. As work progresses, the contractor shall modify the plan to adapt to seasonal variation, changes in construction activities, and the need for better practices.

For each construction phase, install perimeter controls after clearing and grubbing necessary for installation of controls but before beginning other work for the construction phase. Remove perimeter controls only after all upstream areas are stabilized.

Phase I of Traffic Control Plans.

Roadway, Station 501+10 to 520+40 Right:

Immediately after constructing the temporary pavement, stabilize the entire area between the temporary pavement and the right of way line using temporary sod.

Outfall of Pond 1:

Construct the outfall pipe from S-106 towards the pond. The contractor shall have sandbags available at all times during the pipe construction to substantially block runoff in the trench from entering the pipe. Construct pipe to the pond and construct the outlet structure of the pond.

Pond 1 Construction:

Clear and grub the pond site. Initially excavate the pond only enough to construct Type IV Silt Fence as detailed in the TCP. Then excavate the pond to approximate proposed dimensions. Turf all disturbed areas of the pond site above elevation 51.0. Final grading will be done at the end of phase two of the TCP.

Roadway, Station 510+10 to 523+70 Left:

Construct the storm sewer from the pond to the roadway and then in the upstream direction along the left side of the project. During the subsoil excavation, and construction of the roadway underdrain, storm sewer, and wall, use S-19 as the primary inlet for conveyance to the pond. Stage construct the inlet as detailed in the TCP.

Roadway, Station 501+10 to 510+40 Left:

During the subsoil excavation, and construction of the underdrain, storm sewer, and wall, use S-12 as the primary inlet for conveyance to the Laura Lee pond. S-12 should be constructed before disturbing soil upstream. Stage construct and protect the inlet as detailed in the TCP.

Phase II of the Traffic Control Plans:

Roadway, Station 510+10 to 523+10 Right:

During the subsoil excavation, and construction of the roadway underdrain, and storm sewer, use S-20 as the primary inlet for conveyance to Pond 1. Stage construct and protect the inlet in a manner similar to S-19 in Phase I of the TCP.

Roadway, Station 501+10 to 510+40 Right:

During the subsoil excavation, and construction of the underdrain, storm sewer, and walls, use S-10 as the primary inlet for conveyance to the Laura Lee pond. Stage construct and protect the inlet in a manner similar to S-12 in Phase I of the TCP.

Pond 1 Construction:

After entire basin is permanently stabilized, construct underdrain in the pond bottom.

2.a.1 Stabilization Practices:

In the Section 104 Erosion Control Plan, the contractor shall describe the stabilization practices proposed to control erosion. The contractor shall initiate all stabilization measures as soon as practical, but in no case more than 7 days, in portions of the site where construction activities have temporarily or permanently ceased. The stabilization practices shall include at least the following, unless otherwise approved by the Engineer.

THE PARAGRAPH ABOVE REFERS TO A 7 DAY LIMIT BEFORE INITIATING STABILIZATION. THE DEP GENERIC PERMIT SPECIFIES 7 DAYS, BUT STRICTER REQUIREMENTS FROM OTHER PERMITTING AGENCIES WILL OFTEN APPLY AND SHOULD BE NOTED. FOR EXAMPLE, ST. JOHNS RIVER WATER MANAGEMENT DISTRICT HAS A 7 DAY LIMIT IN 40C-42 F.A.C.

Temporary:

- * Artificial coverings in accordance with Specification Section 104.
- * Turf and sod in accordance with Specification Section 104.

Permanent:

- * Asphalt or concrete surface.
- * Sod in accordance with Specification Section 570.

2.a.2 Structural Practices:

In the Section 104 Erosion Control Plan, the contractor shall describe the proposed structural practices to control or trap sediment and otherwise prevent the discharge of pollutants from exposed areas of the site. Sediment controls shall be in place before disturbing soil upstream of the control. The structural practices shall include at least the following, unless otherwise approved by the Engineer.

Temporary:

- * Silt fence in accordance with Design Standard 102 and Specification Section 104.

- * Synthetic Bales in accordance with Design Standard 102 and Specification Section 104.

- * Sandbags to control erosion and trap silt.

- * Inlet protection in accordance with Design Standard 102 and special details shown in the TCP.

- * Sediment Basin. The permanent stormwater ponds will be temporarily modified according to the details in the TCP.

Permanent:

- * Stormwater ponds.

- * Sod.

2.b Stormwater Management:

Several storm sewer systems will be constructed to convey runoff to three (3) stormwater retention / detention ponds. The facilities have been permitted by the Florida Department of Environmental Protection (FDEP) and the City of Narcoossee and comply with applicable design standards.

EXHIBIT SWP-2
DATE: 1/1/07

REVISIONS						STATE OF FLORIDA DEPARTMENT OF TRANSPORTATION			STORMWATER POLLUTION PREVENTION PLAN	SHEET NO.
DATE	BY	DESCRIPTION	DATE	BY	DESCRIPTION	ROAD NO.	COUNTY	FINANCIAL PROJECT ID		

#USERS

#DATES

#TIMES

#FILES

THIS EXHIBIT IS AN EXAMPLE NARRATIVE OF A STORMWATER POLLUTION PREVENTION PLAN (SWPPP) FOR A MAJOR RECONSTRUCTION PROJECT. ACTUAL PROJECT CONDITIONS OFTEN DICTATE DIFFERENT APPROACHES THAN SHOWN HERE. THE ENGINEER IS RESPONSIBLE FOR DEVELOPING A SITE SPECIFIC SWPPP THAT COMPLIES WITH VOLUME I CHAPTER II OF THE PLANS PREPARATION MANUAL.

2.c Other Controls:

2.c.1 Waste Disposal:

In the Section 104 Erosion Control Plan, the contractor shall describe the proposed methods to prevent the discharge of solid materials, including building materials, to waters of the United States. The proposed methods shall include at least the following, unless otherwise approved by the Engineer.

- * Providing litter control and collection within the project during construction activities.
- * Disposing of all fertilizer or other chemical containers according to EPA's standard practices as detailed by the manufacturer.
- * Disposing of solid materials including building and construction materials off the project site but not in surface waters, or wetlands.

2.c.2 Off-Site Vehicle Tracking & Dust Control:

In the Section 104 Erosion Control Plan, the contractor shall describe the proposed methods for minimizing offsite vehicle tracking of sediments and generating dust. The proposed methods shall include at least the following, unless otherwise approved by the Engineer.

- * Covering loaded haul trucks with tarpaulins.
- * Removing excess dirt from roads daily.
- * Stabilizing construction entrances according to Design Standard 106.
- * Using roadway sweepers during dust generating activities such as excavation and milling operations.

2.c.3 State and Local Regulations For Waste Disposal, Sanitary Sewer, Or Septic Tank Regulations:

In the Section 104 Erosion Control Plan, the contractor shall describe the proposed procedures to comply with applicable state and local regulations for waste disposal, and sanitary sewer or septic systems.

2.c.4 Fertilizers and Pesticides:

In the Section 104 Erosion Control Plan, the contractor shall describe the procedures for applying fertilizers and pesticides. The proposed procedures shall comply with applicable subsections of either Section 570 or 577 of the Specifications.

2.c.5 Toxic Substances:

In the Section 104 Erosion Control Plan, the contractor shall provide a list of toxic substances that are likely to be used on the job and provide a plan addressing the generation, application, migration, storage, and disposal of these substances.

2.d.4 Approved State and Local Plans and Permits:

- * FDEP Rule Chapter 62-25 F.A.C.
- * City of Narcoossee Environmental Management Ordinance Number 90-0-0044aa.

3.0 MAINTENANCE:

In the Section 104 Erosion Control Plan, the contractor shall provide a plan for maintaining all erosion and sediment controls throughout construction. The maintenance plan shall at a minimum, comply with the following.

- * Silt Fence: Maintain per Section 104. The contractor should anticipate replacing silt fence on 12 month intervals.
- * Synthetic Bales : Remove sediment when it reaches 1/2 height of bales or when water ponds in unacceptable amounts or areas.
- * Ponds One and Two: The ponds are temporary sediment basins until the areas that drain to them are stabilized, so until then, remove sediment from the pond when it becomes 1.5' deep at any point.

4.0 INSPECTIONS:

Qualified personnel shall inspect the following items at least once every seven calendar days and within 24 hours of the end of a storm that is 0.50 inches or greater. To comply, the contractor shall install and maintain rain gages and record the daily rainfall. Where sites have been permanently stabilized, inspections shall be conducted at least once every month. The contractor shall also inspect that controls installed in the field agree with the latest Stormwater Pollution Prevention Plan.

- * Points of discharge to waters of the United States.
- * Points of discharge to municipal separate storm sewer systems.
- * Disturbed areas of the site that have not been finally stabilized.
- * Areas used for storage of materials that are exposed to precipitation.
- * Structural controls.
- * Stormwater management systems.
- * Locations where vehicles enter or exit the site.

The contractor shall initiate repairs within 24 hours of inspections that indicate items are not in good working order.

If inspections indicate that the installed stabilization and structural practices are not sufficient to minimize erosion, retain sediment, and prevent discharging pollutants, the contractor shall provide additional measures, as approved by the Engineer.

5.0 NON-STORMWATER DISCHARGES:

In the Section 104 Erosion Control Plan, the contractor shall identify all anticipated non-stormwater discharges (except flows from fire fighting activities). The contractor shall describe the proposed measures to prevent pollution of these non-stormwater discharges. If the contractor encounters contaminated soil or groundwater, contact Dave Letterman, District Hazardous Materials Coordinator at 305-63BR549.

EXHIBIT SWP-3
DATE: 1/1/07

REVISIONS						STATE OF FLORIDA DEPARTMENT OF TRANSPORTATION			STORMWATER POLLUTION PREVENTION PLAN	SHEET NO.
DATE	BY	DESCRIPTION	DATE	BY	DESCRIPTION	ROAD NO.	COUNTY	FINANCIAL PROJECT ID		

#USERS

#DATES

#TIMES

#FILES

Chapter 29

Intelligent Transportation Systems Plans

29.1	General	29-1
29.2	Key Sheet.....	29-3
29.3	Tabulation of Quantities and Standard Notes	29-4
29.4	General Notes	29-5
29.5	Plan Sheets	29-6
29.5.1	Format and Scale.....	29-6
29.5.2	Required Information	29-6
29.5.2.1	Dynamic Message Sign	29-7
29.5.2.2	Highway Advisory Radio	29-7
29.5.2.3	Video Display Equipment.....	29-7
29.5.2.4	Network Devices	29-8
29.5.2.5	Fiber Optic Cable and Interconnect	29-8
29.5.2.6	Vehicle Detection and Data Collection.....	29-9

THIS PAGE LEFT BLANK INTENTIONALLY

Chapter 29

Intelligent Transportation Systems Plans

29.1 General

The incorporation of Intelligent Transportation Systems (ITS) Plans is a relatively new development, yet it is becoming more widespread. This chapter was developed to introduce some standardization for ITS Plans. ITS Plans are usually a component set of plans. Projects with minor ITS involvement may include these features on sheets in the roadway plans set or on the roadway sheets (or on sheets in the signalization plans set or on the signalization sheets if applicable). When prepared as component plans they shall be assembled as a separate plans set complete with a key sheet, tabulation of quantities and all other relevant ITS sheets. When prepared as component plans, the sheets shall be numbered consecutively with the sheet numbers prefixed by the letters "IT".

A complete set of ITS Plans shall include the following sheets:

1. Key Sheet
2. Tabulation of Quantities
3. Plan Sheets or "letter type" plan sets
4. Detail Sheets (as required)

The ITS Plans show the construction details, electrical circuits, and other data relevant to an ITS project. Some of the different systems that may be produced under the ITS component set of plans include, but are not limited to, the following:

- | | |
|---------------------------------|---|
| 1. Freeway Management System | 6. Electronic Toll Collection |
| 2. Incident Management System | 7. Electronic Fare Payment |
| 3. Arterial Management System | 8. Highway Rail Intersections (under electronic surveillance) |
| 4. Emergency Management Systems | 9. Regional Multimodal Traveler Information |
| 5. Transit Management Systems | |

The Districts have been gravitating toward utilizing a modified plans format for ITS projects. The modified plans format would allow for "letter type" plans and include a table to locate the devices by mile post to three decimal places, plus an offset dimension given for each

above-ground structure. Global positioning system (GPS) coordinates can be utilized as supplemental information in the table.

For construction purposes the plans should include the following:

1. Table (spreadsheet) to locate devices by mile post to three decimal places.
2. For above-ground installations, give an offset dimension from the edge of the travelway to the ITS device.
3. For such devices as DMS that require overhead structures, include a cross section using “assumed” elevation.
4. For conduit, include number and sizes.
5. For fiber optic cable, include number of fibers.

Regarding as-built records, aerial photographs may be furnished with the table above to provide supplementary information. The aerials will not include the extra features of the ROW, baseline, or roadway edges being drawn in. The aerials are to be used as a base for the as-built plans with the mile post and offset dimensions provided by the Contractor.

29.2 Key Sheet

The key sheet is the first sheet in the component plans set and shall be prepared as described in **Chapter 3** of this volume. The location map, length of project box and contract plans set information are not required on this sheet when shown on the lead key sheet. The index of ITS plans shall be shown on the left of the sheet.

Other data, including name, consultant contract number, vendor number, and certificate of authorization number of the firm (when plans are prepared by a consultant), shall be shown as described in **Chapter 3** of this volume.

If shop drawings are anticipated, the name(s) and address(es) of the Delegated Engineer(s) for shop drawing review(s) shall be shown on the right side of the sheet.

29.3 Tabulation of Quantities and Standard Notes

The tabulation of quantities sheet lists the item numbers, description and quantity of materials. This sheet shall be placed behind the key sheet in plans assembly.

Pay item numbers shall be listed in numerical order. Provisions shall be made to show the original and final quantities per sheet. Pay item notes and general notes that refer to item numbers, description of work to be performed and quantity estimates shall also be shown on this sheet. If space is limited, notes may be shown on a General Notes Sheet.

On contracts with multiple Financial Project ID's, or Federal Aid and non-Federal Aid quantities, provisions shall be made to tabulate and summarize their respective quantities.

29.4 General Notes

General notes pertaining to ITS may be shown on a separate plan format sheet. The general notes sheet lists special ITS design information that is generally not covered in the FDOT Standard Specifications, Supplement or Special Provisions. This sheet shall be placed behind the tabulation of quantities in the plans assembly. On minor projects, general notes may be combined with the tabulation of quantities sheet.

29.5 Plan Sheets

29.5.1 Format and Scale

ITS Plans shall be prepared on standard plan format. The scale shall be such that all details are clear and legible. See the requirements of **Section 10.1** of this volume as a guide. A north arrow and scale shall be shown at a point of maximum visibility on the sheet.

29.5.2 Required Information

The basic information requirements include roadway geometrics, project limits, street names, construction stationing or milepost, curb and gutter, drainage inlets, sidewalks and right of way lines as similarly required on the plan portion of the roadway plan-profile sheets. Those underground and overhead utilities, signing structures, and lighting structures that may cause construction conflicts with ITS components shall be shown. All locations, including existing trees, should be checked for potential conflicts.

If letter type plans are utilized, the table should include at a minimum the device ID, description, milepost, offset, and a comment field. Add an extra column to the table if GPS coordinates are provided for the devices.

All equipment shown on the plan shall be clearly labeled and their respective pay item numbers and quantity indicated. In addition, the following plan elements should be shown:

1. Cabling, fiber optic splicing, and interconnects.
2. System communication devices.
3. Electrical power service equipment and interconnects.
4. Grounding and transient voltage protection details.
5. Structure-mounted or ground-mounted field cabinets for system electronics, maintenance service points, and interconnect.

29.5.2.1 Dynamic Message Sign

Plans for a DMS installation should illustrate the location, placement, and typical details of the following components:

1. DMS display enclosure.
2. DMS controller.
3. DMS support structures (including external walkways, safety railings, ladders, etc.).
4. DMS mounting brackets and hardware.
5. A ground-level access point for maintenance personnel to perform diagnostic work on the sign.

29.5.2.2 Highway Advisory Radio

The design for an HAR installation should illustrate the location, placement, and typical details of the following components:

1. HAR operator workstation and central recording facility.
2. HAR antennas.
3. HAR transmitter and electronics.
4. HAR support structures, signage, and beacons.
5. HAR mounting brackets and hardware.

29.5.2.3 Video Display Equipment

Provide mounting and installation plan sheets for each color video monitor, flat panel display, and rear projection video unit in the video display system. Depict in the mounting plans detailed structural mounting information, including support structures, wall attachment methods, and the weights of the display units. Provide cable routing plan sheets and diagrams for the devices, along with maintenance/service points and structural certification.

The plans should illustrate the location, placement, and typical details of the following video display system components:

1. Video display controller.
2. Operator workstations.

3. Encoders, decoders, multiplexers, and routing equipment.

Develop sheets that detail cross-sections and elevations for all modifications to existing wall systems in the TMC facility and submit them to the Engineer.

For the rear projection video unit mounting and installation plans, include details that illustrate stacking configuration and support design, along with a ventilation and climate control plan. Provide cable routing plans that include detailed connection diagrams for individual and stacked configurations.

29.5.2.4 Network Devices

Plans including network devices should illustrate the following system attributes:

1. System diagrams illustrating network and device interconnect.
2. General network topology.
3. Notes regarding any special configurations or options for specific devices that are required to achieve a specific system function.

29.5.2.5 Fiber Optic Cable and Interconnect

The plans for fiber optic cable systems should illustrate the location, placement, and typical details of the following components:

1. Fiber optic conduits.
2. Fiber optic cables.
3. Fiber optic splices and terminations.
4. Fiber optic cable designating system.
5. Fiber optic cable access points.

29.5.2.6 Vehicle Detection and Data Collection

The plans for vehicle detection systems should illustrate the location, placement, and typical details of the following components:

1. Diagrams illustrating detection system interconnect.
2. General network topology.
3. Notes regarding any special configurations or options for specific devices that are required to achieve a specific system function.

THIS PAGE LEFT BLANK INTENTIONALLY

APPENDIX A

Metric Practice

THIS PAGE LEFT BLANK INTENTIONALLY

METRIC PRACTICE

GENERAL

This Appendix was originally included in the Metric PPM and was used as guidelines for the development of Metric plans. This was a useful tool especially for the English to Metric conversion of design information. This Appendix has now been included in the English PPM as a tool for use in cases where the designer may need to obtain information from Metric plans. This may provide the designer some insight as to how those Metric plans were developed.

SUMMARY OF RULES

1. Convert values related to surveys, right of way and other geometric alignment using the U. S. Survey Foot taken to a minimum of 8 decimal places:

$$1 \text{ foot} = \frac{12 \text{ inches/foot}}{39.37 \text{ inches/meter}} = 0.304 \ 800 \ 61 \text{ meters}$$

For other direct mathematical conversions use the SI definition:

$$1 \text{ foot} = 0.3048 \text{ meters}$$

2. Display direct mathematical (soft) converted values to the nearest 0.001 m or 1 mm.
3. Do not use commas to separate digits if a number has more than 4 digits. For numbers with more than 4 digits either right or left of the decimal, leave a space when practical. (Where the displayed number must be used in a mathematical operation on a computer the space may not be recognized properly and should not be used).

Example: 10 000 or 0.609 35 or 13 471.359

4. To the extent practical, use the following rules for dimensioning roadway plans:
 - a. For dimensions in meters, display values to at least one decimal place.

- b. For dimensions in millimeters, display values as whole numbers with no decimal place.
 - c. Do not use the centimeter.
 - d. Using the above rules, do not show the unit symbols "m" and "mm" unless needed for clarification. Show even dimensions in meters with a decimal and following zero digit, e.g. 300.0 to avoid confusion with 300 mm.
5. If a dimensioned item has a numerical quantity that is part of a group of numbers in a different range, select the unit that most adequately covers the range without unduly large or small numbers. For example, if 300 mm is part of a group of numbers shown in meters, show it as 0.3 m.
6. Show long dimensions, including all horizontal and vertical geometry, wall lengths, bridge span lengths and box or three sided culvert lengths, spans and heights in meters.
7. In general, show cross section dimensions of structural members in millimeters. This will normally include most drainage structures (except box culverts), drainage pipe, and special drainage structure details. (Note: The actual size of drainage pipe and standard drainage structure boxes will remain the same. However, label these items in nominal size based on 1" = 25 mm. Example: Label 24" pipe as 600 mm pipe; Label a 4' diameter structure as a 1200 mm structure.)
8. Show pavement thickness descriptions in millimeters.
9. Use 0.1 m for both base extension on rural sections (formerly 3") and for stabilization extension on curbed sections (formerly 6").
10. On typical sections, show type of curb, "E" or "F", not the dimension.
11. As a general rule, display metric dimensions to one more decimal place than the corresponding dimension in English units:
 - a. Typical Section Elements, including lane widths and shoulder widths - in meters, generally to 1 decimal place.
 - b. Horizontal control points on plans, including survey centerline, baseline, intersections and alignment - in meters to 3 decimal places. The normal station interval for centerlines and baselines is 100 meters. (1 + 00.000 = 100

- m)
- c. Vertical alignment control points, (PVC, PVI, PVT) and profile grade elevations - in meters to 3 decimal places.
 - d. Profile Grade - in percent to 4 decimal places.
 - e. Proposed flow lines - in meters to 2 decimal places.
 - f. Manhole tops and grate elevations - in meters to 2 decimal places.
 - g. Ditch elevations - in meters to 2 decimal places.
 - h. Box Culvert or Three-sided Spans and Heights - in meters to 1 decimal for new construction; in meters to 2 decimal places for extensions of existing box culverts originally constructed to English dimensions.
12. Where practical, round short radius curves (<150.0 m), including curb returns and control radii, to the nearest meter. Round longer radius curves to the nearest 5 meters. (See attached tables.)
13. Display alignment bearings and delta angles in curve data in degrees, minutes and seconds, rounded to the nearest second.
14. Omit "degree of curvature" from curve data. It has no definition in the metric system. Instead, use the radius definition. Equations:

$$\text{Tangent } T = R \tan\left(\frac{\Delta}{2}\right)$$

$$\text{Length } T = R (\Delta \text{ in Radians})$$

$$\text{Long Chord } LC = 2 R \sin\left(\frac{\Delta}{2}\right)$$

15. On resurfacing projects, hard convert typical section dimensions (lane widths, shoulder widths, etc.) where existing conditions permit. Exception: Use direct mathematical (soft) conversion (Rule Number 2) for existing pavement widths in curbed sections, existing right of way widths, and existing median widths.

16. Continue to post sign messages for speed limits and distances in English units. Note: The posted speed for curb and gutter sections with design speed of 80 km/h (corresponds to 50 mph), should not exceed 45 mph.
17. A "hard" metric project is defined as one where metric standard index drawings and metric specifications are used, and the design complies with adopted metric criteria.
18. Beginning with metric projects express slope ratios in vertical to horizontal (V:H) format. For example, show roadside slopes as 1:6, 1:4, rather than past convention as 6:1 or 4:1.
19. As a general guideline for new construction and reconstruction, show cross sections in 20 meter intervals for urban projects and 50 meter intervals for rural projects. Project specific factors may dictate greater or lesser intervals.
20. When project limits are identified by kilometer point location on the Key Sheet, show the equivalent milepost using direct mathematical conversion.

 (example: kp 1.609 = MP 1.000)
21. Label existing and proposed utilities in metric. Use the FDOT Basis of Estimates Handbook utility pay item list of metric sizes as a guide.

PLAN SCALES

ENGLISH SCALE	METRIC SCALE
1" = 2'	1: 25
1" = 5'	1: 50
1" = 10'	1: 100
1" = 20'	1: 200
1" = 40'	1: 400 or 1: 500
1" = 50'	1: 500
1" = 100'	1: 1000
1" = 200'	1: 2000
1" = 400'	1: 5000

Plan sheet size will remain the same. The viewing area of a plan sheet will be 800 mm long on "D" size sheets and 400 mm on "B" size sheets. Allowing for open space at each side, this provides a coverage of 140 m at 1:400 scale, 350 m at 1:1000 and 700 m at 1:2000 on "B" size sheets.

Plan/ Profiles:

	Sheet Size	Horizontal	Vertical
Rural -	D	1:1000	1:50 or 1:100
	B	1:2000	1:100 or 1:200
Urban -	D	1:200	1:50
	B	1:400 or 1:500	1:50 or 1:100

Show centerline major tick marks at each station. Show centerline minor tick marks at 20 meter intervals when using 1:200 and 1:400 scale, and at 25 meter intervals when using 1:500 scale.

Cross Sections:

	Sheet Size	Horizontal	Vertical
Normal	D	1:50	1:25
	B	1:100	1:50
Wide Sections	D	1:100	1:25 or 1:50
	B	1:200	1:50 or 1:100
Narrow Sections	D	1:25	1:25
	B	1:50	1:50

As a guideline, the normal interval for cross sections is 20 meters for urban projects and 50 meters for rural projects.

COMPARISON OF ENGLISH AND METRIC VALUES

LANE WIDTHS

CURRENT	SOFT	HARD
8 ft	2.438 m	2.4 m
9 ft	2.743 m	2.7 m
10 ft	3.048 m	3.0 m
11 ft	3.353 m	3.3 m
12 ft	3.658 m	3.6 m
14 ft	4.267 m	4.2 m
15 ft	4.572 m	4.5 m

BIKE LANE WIDTHS

4 ft	1.219 m	1.2 m
5 ft	1.524 m	1.5 m

SIDEWALK AND UTILITY STRIP WIDTHS

CURRENT	SOFT	HARD
2 ft	0.610 m	0.6 m
3 ft	0.914 m	0.9 m
4 ft	1.219 m	1.2 m
5 ft	1.524 m	1.5 m
6 ft	1.829 m	1.8 m
7 ft	2.134 m	2.1 m
8 ft	2.438 m	2.4 m
9 ft	2.743 m	2.7 m
10 ft	3.048 m	3.0 m

CURB AND GUTTER WIDTHS

TYPE	CURRENT	SOFT	HARD
E	2.25 ft	686 mm	675 mm
F	2.00 ft	610 mm	600 mm
Shoulder			
Gutter	3.50	1067 mm	1050 mm

SHOULDER WIDTHS

CURRENT	SOFT	HARD
2 ft	0.610 m	0.6 m
4 ft	1.219 m	1.2 m
5 ft	1.524 m	1.5 m
6 ft	1.829 m	1.8 m
8 ft	2.438 m	2.4 m
10 ft	3.048 m	3.0 m
12 ft	3.658 m	3.6 m

COMPARISON OF ENGLISH AND METRIC VALUES

TRAFFIC SEPARATOR WIDTHS

CURRENT	SOFT	HARD
4 ft	1.219 m	1.2 m
6 ft	1.829 m	1.8 m
8.5 ft	2.591 m	2.6 m

MEDIAN WIDTHS

CURRENT	SOFT	HARD
15.5 ft	4.724 m	5.0 m
17.5 ft	5.334 m	N/A
19.5 ft	5.944 m	6.0 m
22 ft	6.706 m	6.6 m
26 ft	7.925 m	7.8 m
30 ft	9.144 m	9.0 m
40 ft	12.192 m	12.0 m
50 ft	15.240 m	15.0 m
60 ft	18.288 m	18.0 m
64 ft	19.507 m	19.2 m
88 ft	26.822 m	26.4 m

DITCH WIDTHS

CURRENT	SOFT	HARD
3 ft	0.914 m	0.9 m
3.5 ft	1.067 m	1.0 m
4 ft	1.219 m	1.2 m
5 ft	1.524 m	1.5 m

DESIGN SPEED

CURRENT	METRIC
20	30
25	40
30	50
35	60
40	60
45	70
50	80
55	90
60	100
65	110
70	110

METRIC CONVERSIONS

RETURN RADII CONTROL RADII SHORT RADIUS CURVE RADII

TURNING SPEED mph	RADIUS (feet)	SOFT (meters)	HARD (meters)	TURNING SPEED km/h	RADIUS (meters)
10	15	4.572	5.0	15	7.0
	20	6.096	6.0		
	25	7.620	8.0		
	30	9.144	9.0		
	35	10.668	11.0		
15	40	12.192	12.0	20	10.0
	45	13.716	14.0		
	50	15.240	15.0		
	60	18.288	18.0		
20	75	22.860	23.0	30	25.0
	90	27.432	27.0		
	100	30.480	30.0		
25	150	45.720	46.0	40	50.0
30	230	70.104	70.0	50	80.0
35	310	94.488	94.0	60	115.0
40	430	131.064	131.0	60	115.0
					Small Radii ↑
	550	167.640	170.0		↓ Large Radii
	690	210.312	210.0		
	840	256.032	255.0		
	1040	316.992	315.0		

Note: Selection of appropriate radii should also consider design vehicle.

Conversions on this sheet and the next are accomplished as follows:

1. Radius in feet x (12 ÷ 39.37) = radius in meters (soft)
2. Values for metric turning speeds based on proposed AASHTO metric criteria.

COMPARISON OF ENGLISH AND METRIC VALUES

DEGREE OF CURVE TO RADIUS VALUES			
DEGREE	RADIUS	RADIUS-Soft (meters)	RADIUS-Hard (meters)
0°-15'	22918.31	6985.515	6985.0
0°-30'	11459.16	3492.758	3495.0
0°-45'	7639.44	2328.505	2330.0
1°-00'	5729.58	1746.379	1745.0
1°-15'	4583.66	1397.103	1395.0
1°-30'	3819.72	1164.253	1165.0
1°-45'	3274.04	997.931	1000.0
2°-00'	2864.79	873.189	875.0
2°-15'	2546.48	776.168	775.0
2°-30'	2291.83	698.552	700.0
2°-45'	2083.48	635.047	635.0
3°-00'	1909.86	582.126	580.0
3°-15'	1762.95	537.347	535.0
3°-30'	1637.02	498.965	500.0
3°-45'	1527.89	465.701	465.0
4°-00'	1432.39	436.595	435.0
4°-15'	1348.14	410.913	410.0
4°-30'	1273.24	388.084	390.0
4°-45'	1206.23	367.659	370.0
5°-00'	1145.92	349.276	350.0
5°-30'	1041.74	317.523	320.0
6°-00'	954.93	291.063	290.0
7°-00'	818.51	249.483	250.0
8°-00'	716.20	218.297	220.0
9°-00'	636.62	194.042	195.0
10°-00'	572.96	174.638	175.0

Note: Degree of Curvature is not used in the Metric System.

GENERAL METRIC INFORMATION

SI PREFIXES

M mega $10^6 = 1\,000\,000$
 k kilo $10^3 = 1\,000$
 m milli $10^{-3} = 0.001$

Base SI Units			Related Units		
Quantity	Unit	Symbol	Unit	Symbol	Relation
length	meter	m	millimeter	mm	=0.001 m (10^{-3} m)
			kilometer	km	=1000 m (10^3 m)
mass	kilogram	kg	gram	g	=0.001kg (10^{-3} kg)
			megagram	Mg	=1000 kg (10^3 kg)
			metric ton	t	=1000 kg (10^3 kg)
time	second	s	hour	h	=3600 s

DERIVED SI UNITS WITH SPECIAL NAMES

Quantity	Unit	Symbol	Formula
force	newton	N	kg·m/s ²
pressure	pascal	Pa	N/m ²
moment	newton meter	N·m	N·m
Temperature	degree Celsius	°C	---

GENERAL METRIC INFORMATION

Common Derived Units of SI			Related Units			
Quantity	Unit	Symbol	Unit	Symbol	Relation	
acceleration	meter/second ²	m/s ²				
area	square meter	m ²	sq. millimeter	m m ²	=0.000 001 m ²	(10 ⁻⁶ m ²)
			hectare	ha	=10 000 m ²	(10 ⁴ m ²)
			sq. Kilometer	k m ²	=1 000 000 m ²	(10 ⁶ m ²)
density, mass	kilogram/cubic	kg/m ³				
velocity	meter/second	m/s	kilometer/hour	km/h	=0.2778 m/s	
volume	cubic meter	m ³	liter	L	=0.001 m ³	(10 ⁻³ m ³)
			milliliter	mL	=0.000 001 m ³	(10 ⁻⁶ m ³)

GENERAL METRIC INFORMATION

SOFT CONVERSION FACTORS

CLASS	MULTIPLY	BY	TO GET
LENGTH	inches	25.400 000	mm
	inches	0.025 400	m
	feet	0.304 800 **	m
	yards	0.914 400	m
	miles	1609.344 000	m
	miles	1.609 344	km
AREA	sq inches	645.160 000	mm ²
	sq feet	0.092 903	m ²
	sq yard	0.836 127	m ²
	acres	4046.873 000	m ²
	sq miles	2.589 988	km ²
VOLUME	board feet	0.002 360	m ³
	cubic feet	0.028 317	m ³
	cubic yard	0.764 555	m ³
	gallon (fluid)	3.785 412	L
	ounce (fluid)	29.573 530	ML
	bushels	0.035 239	m ³
MASS	ounce	0.028 350	kg
	pound	0.453 592	kg
	ton	907.184 700	kg
	lb/ft	1.488 164	kg/m
	lb/ft ²	4.882 425	kg/m ²
	lb/ft ³	16.018 460	kg/m ³
	ounces/ft ²	0.305 152	kg/m ²
FORCE	pound (force)	4.448 222	N
	lb/ft	14.593 900	N/m
	lb/ft ²	47.880 260	N/m ²
	lb/ft ³	157.087 5	n/m ³
STRESS	psi	6894.757 000	Pa
	kips/in ²	6.894 757	N/mm ²
VELOCITY	fps	0.304 800	m/s
	mph	0.447 040	m/s
	mph	1.609 344	km/h
TEMPERATURE	(°F-32) / 1.8 = °C		
ANGLES	(no change)	deg, min, sec	

** For conversion from U.S. Geodetic Survey, the U.S. survey foot equals 0.304 800 610 m