

NOTES:

1. Work this sheet with Index No. 20510 - Composite Elastomeric Bearing Pads, and the 'BEARING PLATE DATA TABLE' in the Structures Plans.
 2. Embedded Bearing Plates A are required for all Florida-I beams. Beveled Bearing Plates B with Embedded Bearing Plates A are required for beams as scheduled in the 'BEARING PLATE DATA TABLE' in the Structures Plans.
 3. Bearing plate material shall conform to ASTM A36 or ASTM A709 (Grade 36 or 50). Headed Concrete Anchor Studs shall conform to Specification Section 502. Hot-dip galvanize Bearing Plates A & B after fabrication except that Galvanized Caps may be welded in place after hot-dip galvanizing. Drill Bearing Plates A and B as an assembled unit, thread Bearing Plate A only. Holes are not required in Plate A when Plate B is not required. Drill and thread holes perpendicular to Embedded Plate A and prior to plates being galvanized (ASTM A 123).
 4. Provide Electroplated, Flat Head Cap Screws in accordance with ASTM F 835. Electroplating shall be ASTM B633, SC 2, Type 1. Provide screws long enough to maintain a $\frac{3}{4}$ " minimum embedment into Embedded Bearing Plate A and Galvanized Cap. Provide steel Galvanized Caps with $\frac{1}{2}$ " Min. to $1\frac{1}{2}$ " Max. height and nominal 1" inside diameter.
 5. Include the cost of Bearing Plates in the pay item for Prestressed Beams.
 6. For Pad Type and Dimensions C, D, E, F and G, see the 'BEARING PLATE DATA TABLE' in the Structures Plans. For Dimensions J, K1 and K2, see 'TABLE OF BEAM VARIABLES' in the Structures Plans.
 7. All details and dimensions shown are along \bar{C} Beam, except for dimensions to $\frac{3}{4}$ " Dia. Screws and $\frac{1}{2}$ " Dia. x $2\frac{1}{8}$ " Anchor Studs, which are along \bar{C} Screws or \bar{C} Anchor Studs. Positive Slope shown, Negative Slope similar.
 8. When Skew = 0°, F = D = 3'-0" (Florida-I Beams) or 1'-4" (AASHTO Type II Beams) E = C, and G = 1'-1 $\frac{1}{2}$ ".
 9. Slope is determined along \bar{C} Beam at \bar{C} Bearing. See 'BEARING PLATE DATA TABLE' in the Structures Plans for Slope and Angle θ .
- CROSS REFERENCE:
See Sheet 2 for Detail "A".

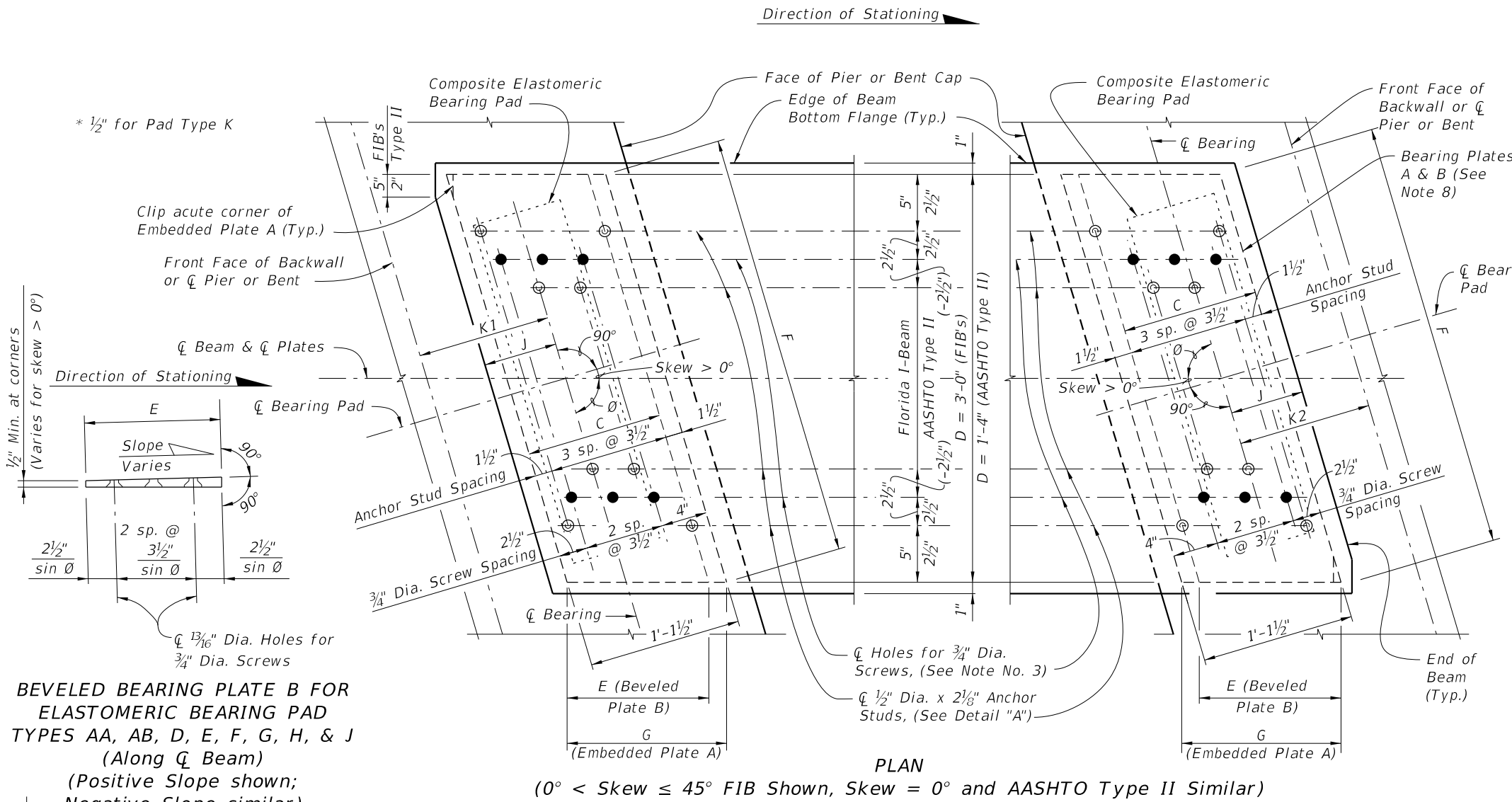

BEVELED BEARING PLATE B FOR ELASTOMERIC BEARING PAD TYPES AA, AB, D, E, F, G, H, & J (Along \bar{C} Beam)
(Positive Slope shown; Negative Slope similar)

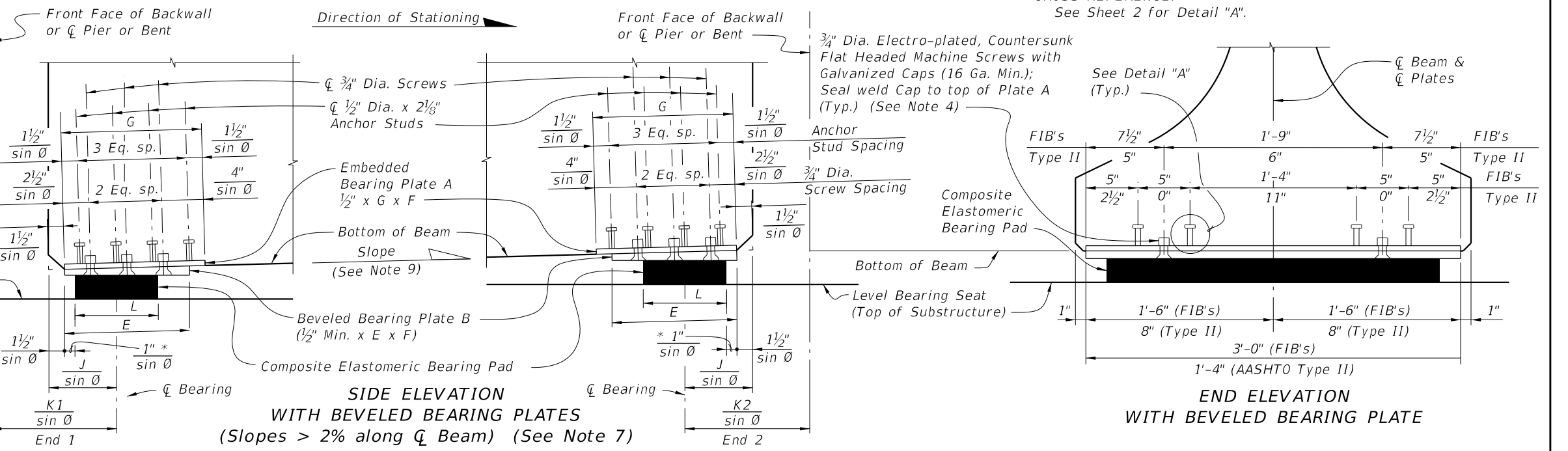
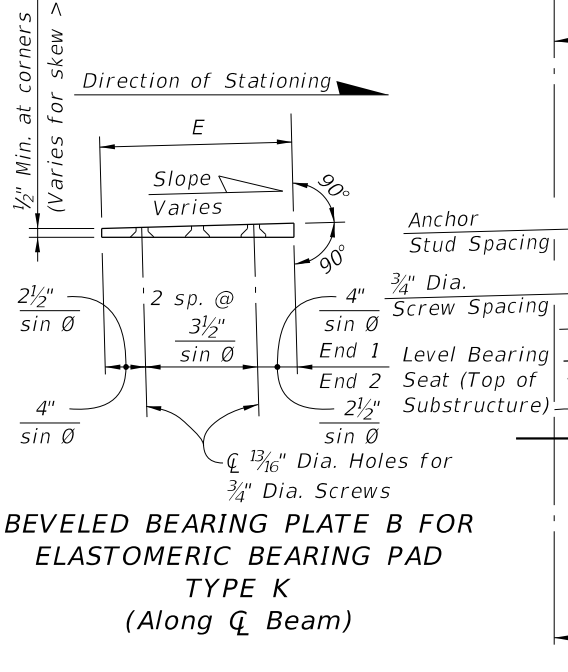

10/26/2016 8:59:19 AM

LAST REVISION	DESCRIPTION:	FDOT FY 2017-18 DESIGN STANDARDS	BEARING PLATES (TYPE 1) - PRESTRESSED FLORIDA-I AND AASHTO TYPE II BEAMS	INDEX NO.	SHEET NO.
07/01/14				20511	1 of 2

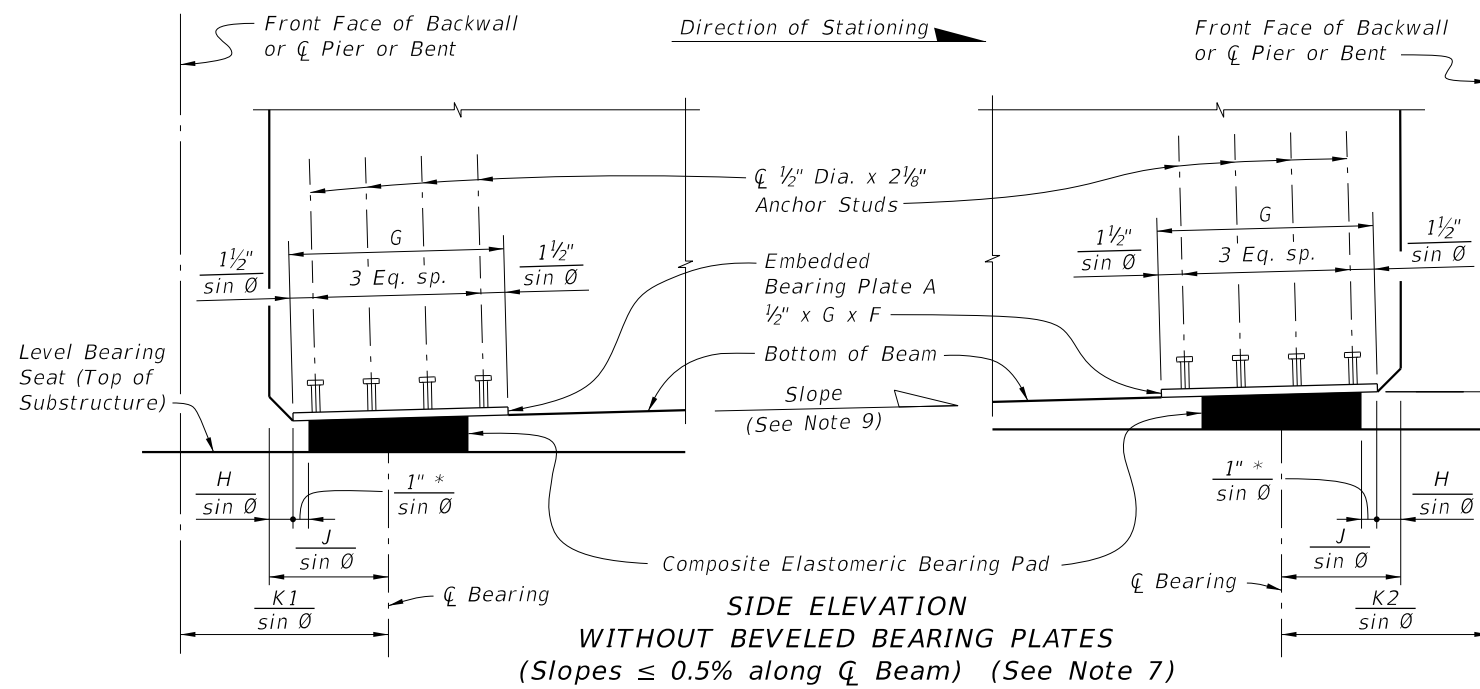

* $1/2"$ Pad Type K

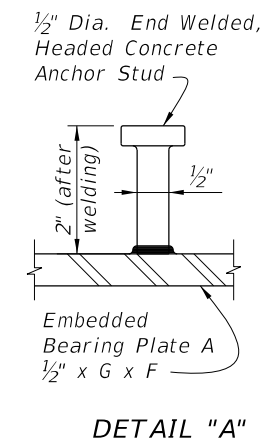
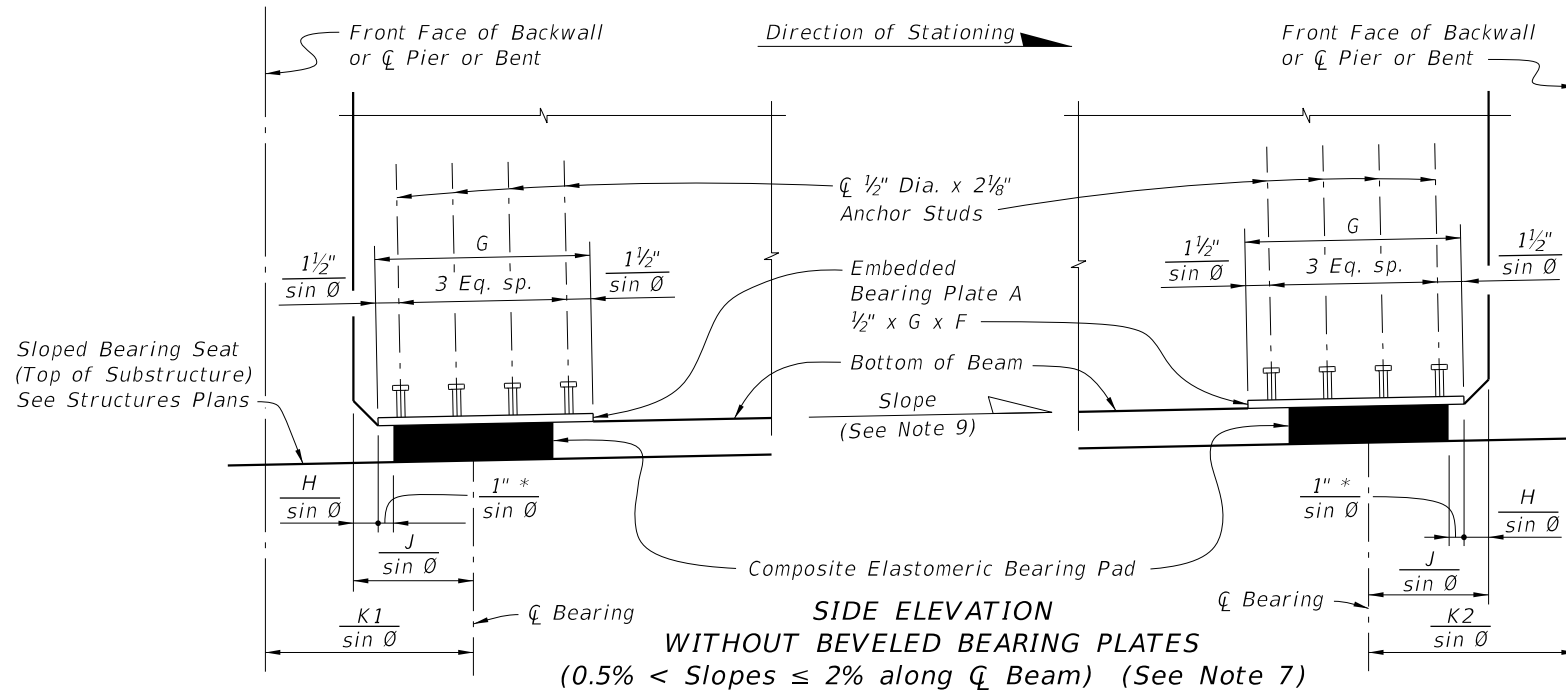
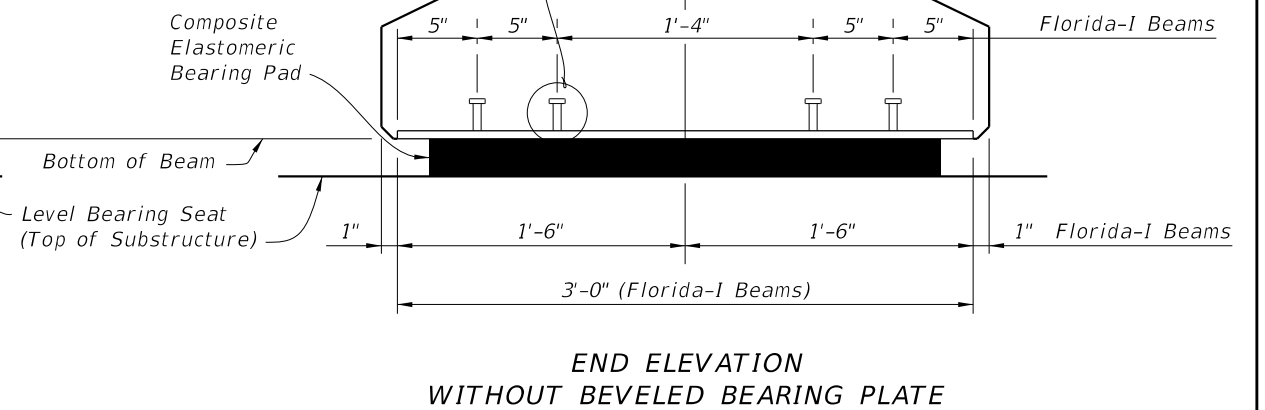

CROSS REFERENCE:
See Sheet 1 for dimension H and Notes.

10/26/2016 8:59:22 AM

LAST REVISION 07/01/14	DESCRIPTION:	FY 2017-18 DESIGN STANDARDS	BEARING PLATES (TYPE 1) - PRESTRESSED FLORIDA-I AND AASHTO TYPE II BEAMS	INDEX NO. 20511	SHEET NO. 2 of 2
---------------------------	--------------	--	---	---------------------------	----------------------------