

* Guardrail or Crash Cushion may also be shown in the Contract Plans, in lieu of the Tapered End Transition.

SCHEMATIC PLAN VIEW - NEAR LANE APPROACH

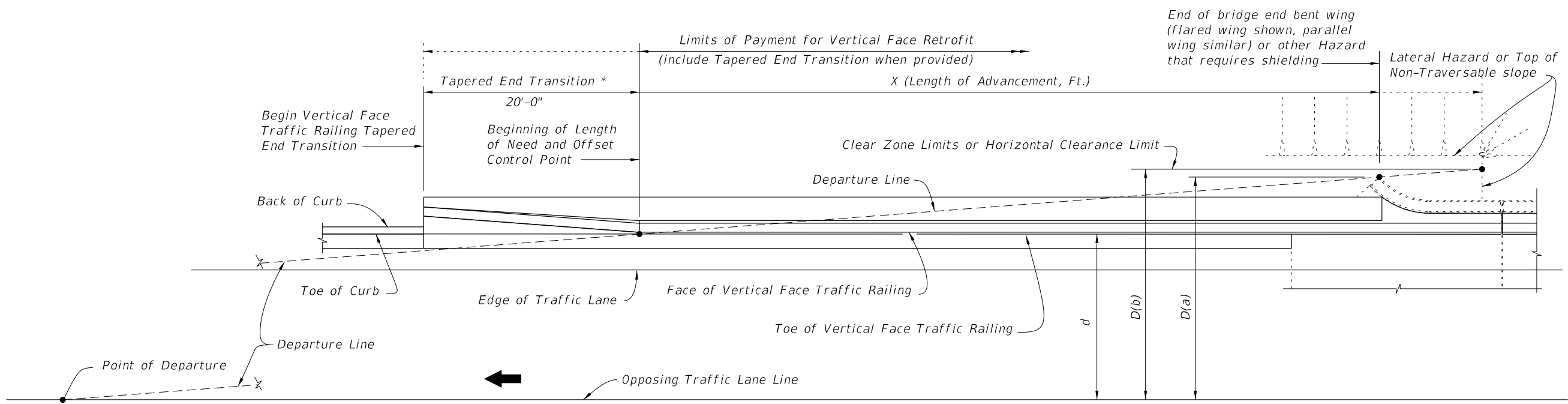

SCHEMATIC PLAN VIEW - OPPOSING LANE APPROACH

LENGTH OF ADVANCEMENT - TAPERED END TRANSITION (40 MPH OR LESS)

Design Speed (mph)	Length of Advancement, Ft. (X)
≤ 40	= 16 (D-d)

Notes:
 1. The minimum length of advancement for both near lane and opposing lane approaches is 20'.
 2. For Design Speeds greater than 40 mph the Tapered End Transition is not permitted. See Index No. 400 for length of Advancement of guardrail or other project specific end treatments.

DESIGN NOTES:

The Tapered End Transition should only be used when space is limited which precludes the use of a guardrail end treatment or crash cushion.

D = Distance in feet from near edge of near approach traffic lane to either:
 (a) the back of hazard, when the hazard is located inside the clear zone or horizontal clearance;
 (b) the clear zone or horizontal clearance outer limits, when hazard extends to, or goes beyond the clear zone or horizontal clearance limits.
 For left side hazards on two way undivided facilities, "D" is measured from the inside edge of the near approach traffic lane as shown above.

d = Distance in feet from near edge of near approach traffic lane to face of traffic railing (at offset control point). For left side hazards on two-way undivided facilities "d" is measured from the inside edge of the nearest opposing traffic lane as shown above.

CROSS REFERENCES:

For General Notes, Dowel Details, Expansion Dowel Details, Reinforcing Steel Notes and Reinforcing Steel Bending Diagram see Index No. 480.

10/26/2016 8:23:16 AM

Approach Slab Transition
(See Schemes 1 thru 7 for
Details and Reinforcement)

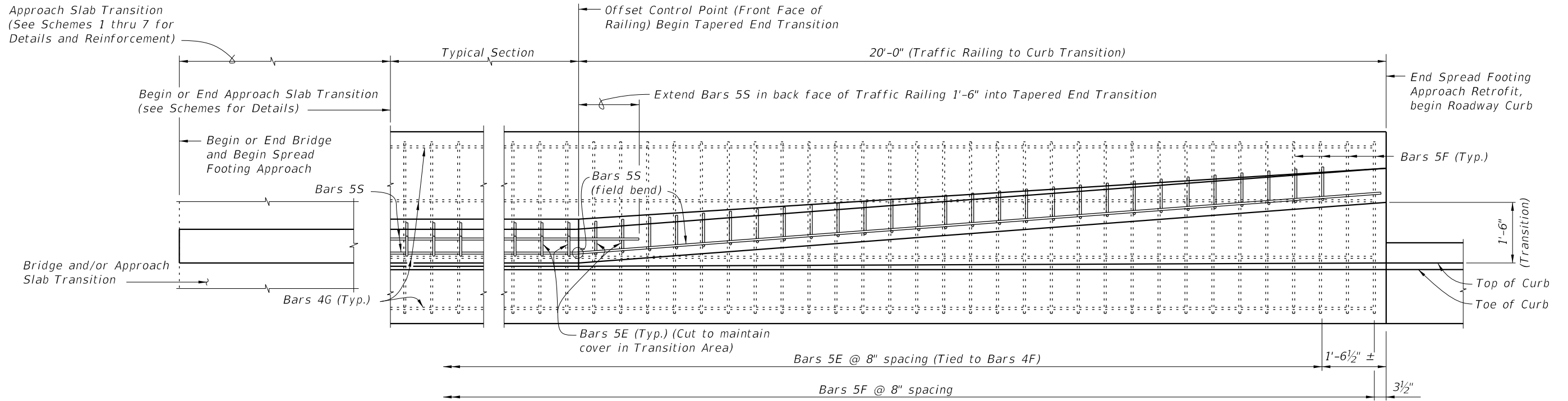

PARTIAL PLAN VIEW

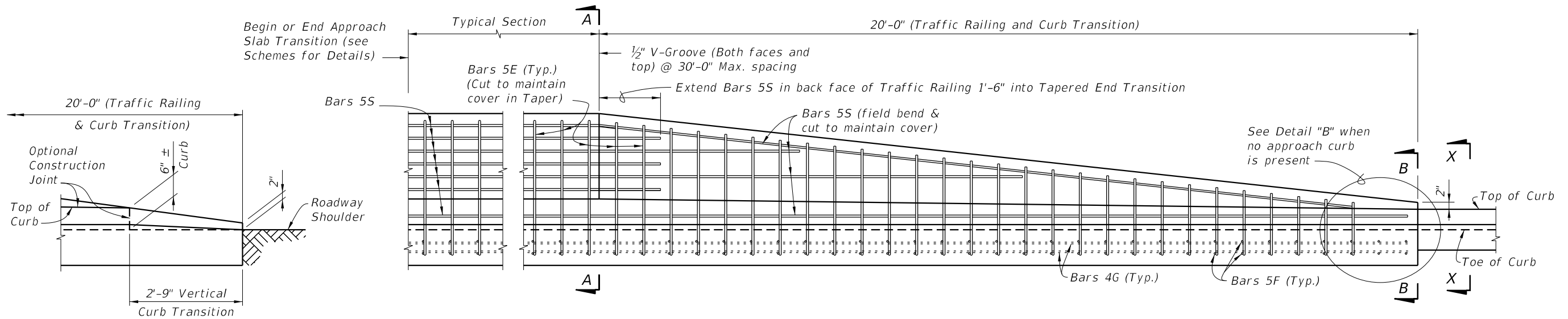

PARTIAL ELEVATION VIEW

DETAIL "B"
TRANSITION TO NON-CURB APPROACH
(Reinforcing Not Shown For Clarity)

TAPERED END TRANSITION

CROSS REFERENCES:
For Section A-A, B-B and X-X see Sheet 4.

10/26/2016 8:23:19 AM

LAST REVISION 07/01/09	REVISION	DESCRIPTION:	 FY 2017-18 DESIGN STANDARDS	TRAFFIC RAILING - (VERTICAL FACE RETROFIT) SPREAD FOOTING APPROACH	INDEX NO. 484	SHEET NO. 2 of 10
---------------------------	----------	--------------	--	---	------------------	----------------------

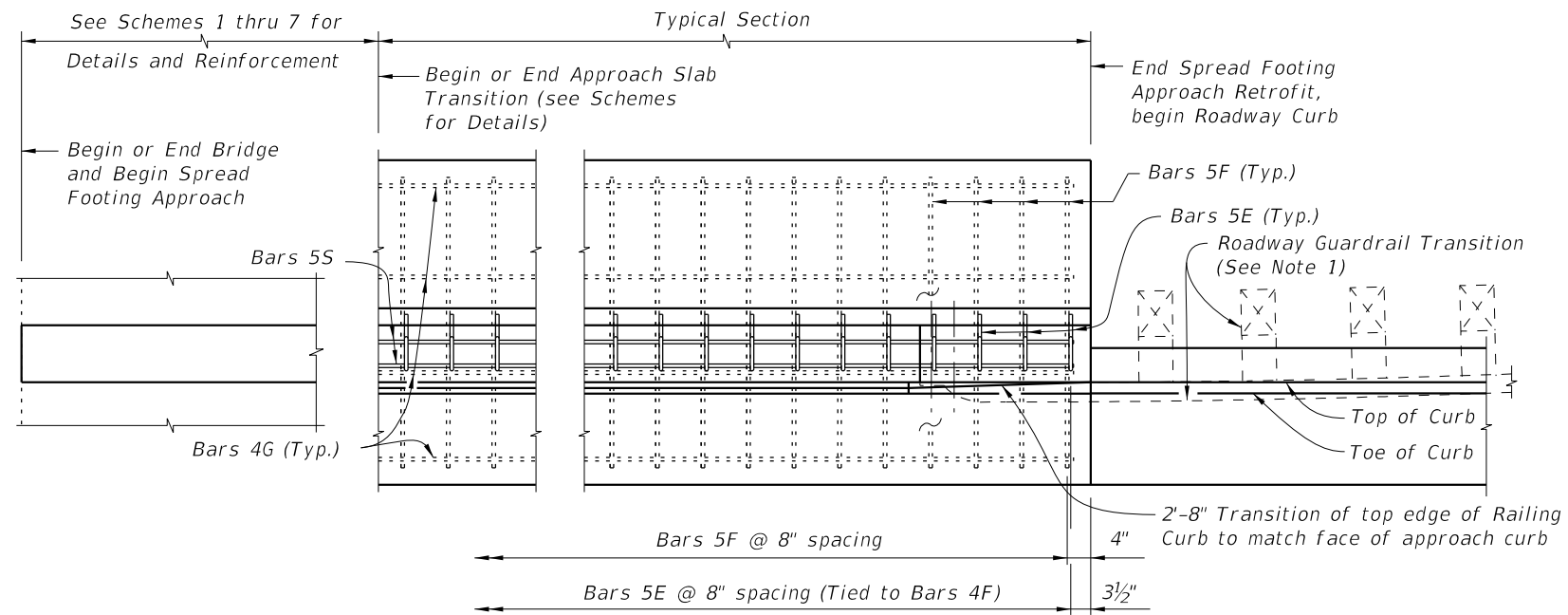

**PARTIAL PLAN VIEW
(With Curb Approach)**

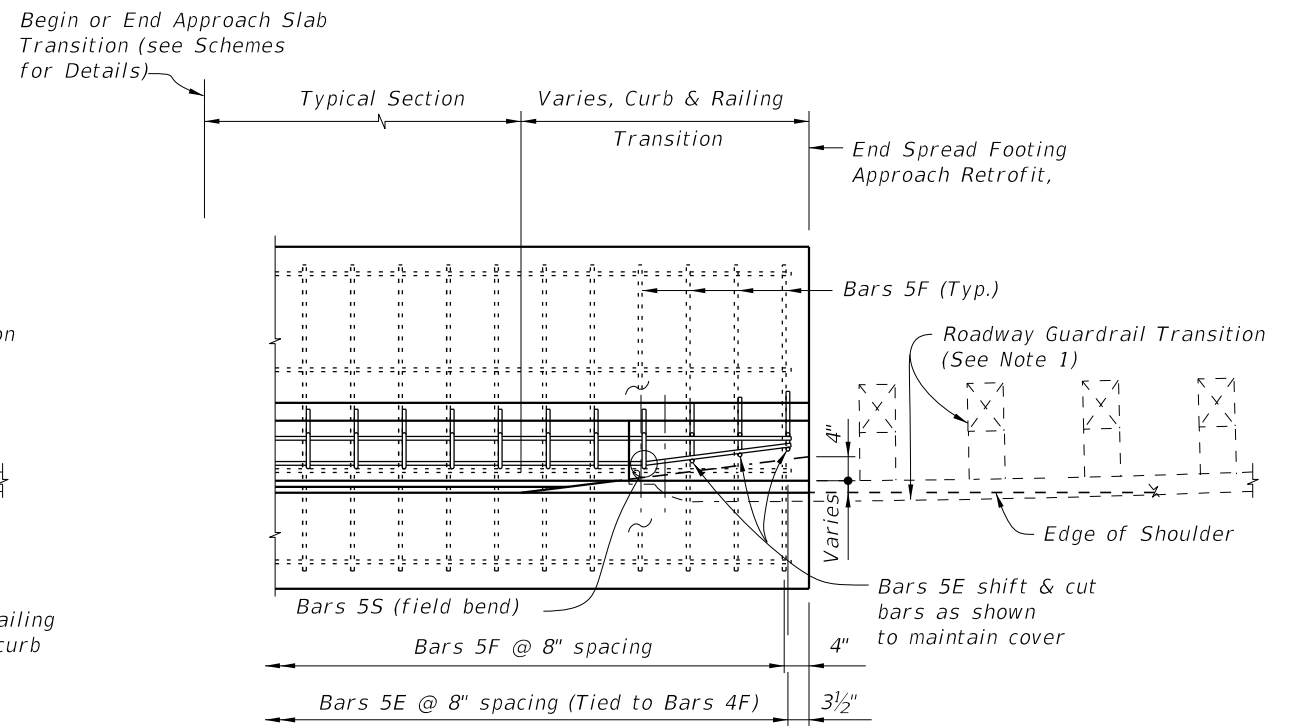

**PARTIAL PLAN VIEW
(Without Curb Approach)**

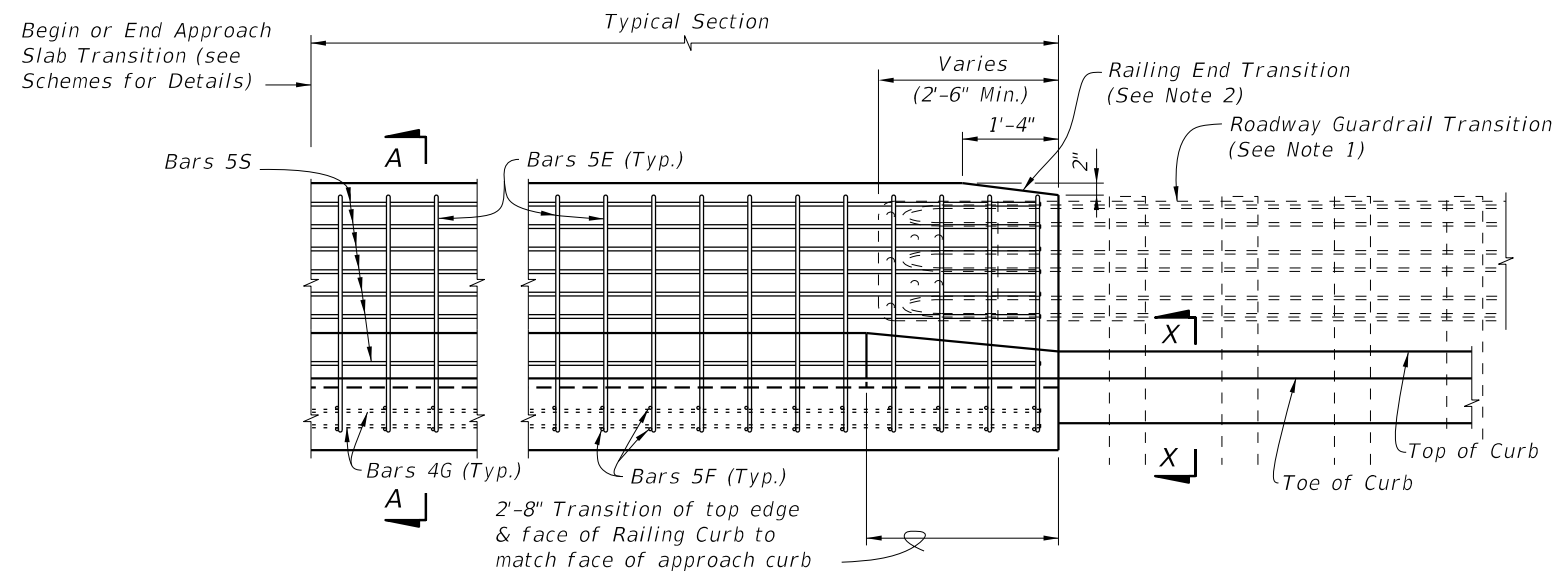

**PARTIAL ELEVATION VIEW
(With Curb Approach)**

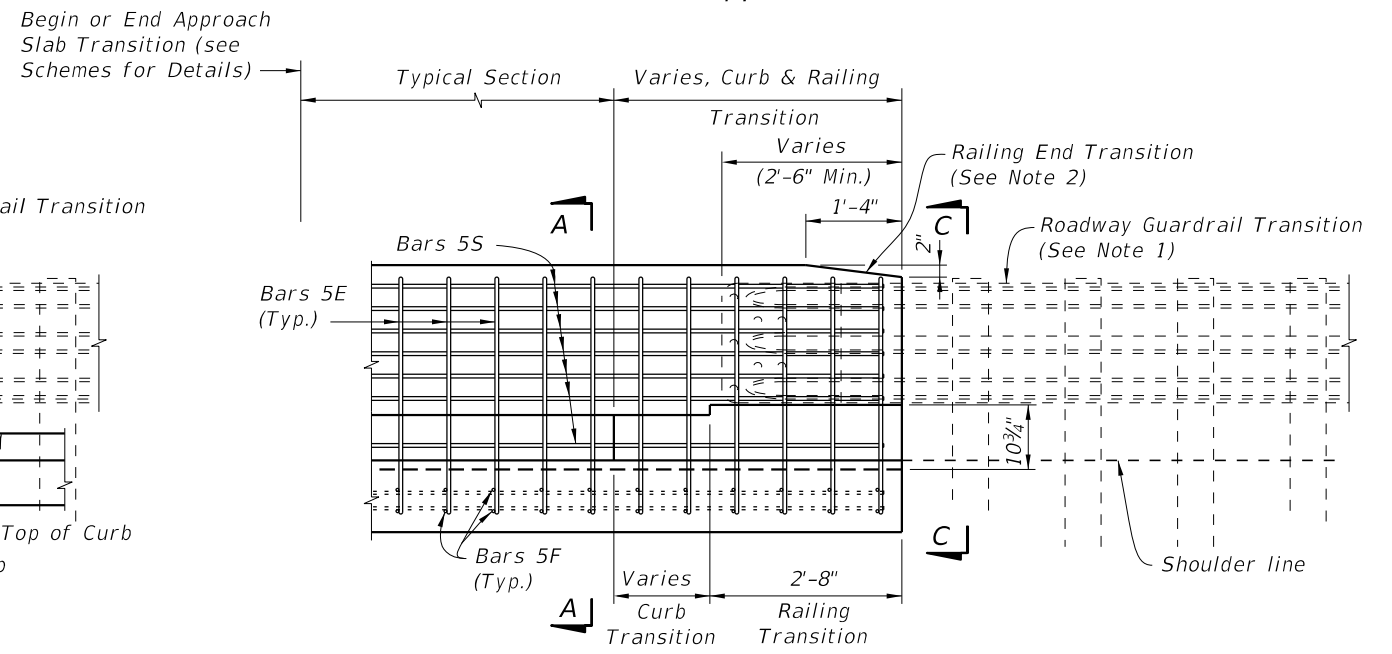

**PARTIAL ELEVATION VIEW
(Without Curb Approach)**

GUARDRAIL END TRANSITION

NOTES:

1. On approach end provide a Roadway Guardrail Transition, Index No. 402 (Sheet 16 - Scheme 1) or other site specific treatment. See Roadway Plans for limiting station of Roadway Guardrail Transition or other site specific treatment.
2. Provide Railing & Curb Base Transitions (as shown) if curb does not extend beyond end of Spread Footing Approach, see Roadway Plans. Railing End Transition & Railing & Curb Base Transitions may be omitted on trailing ends with no opposing traffic.

CROSS REFERENCES:

For Section A-A, C-C and X-X see Sheet 4.

10/26/2016 8:23:21 AM

LAST REVISION	DESCRIPTION:
07/01/09	



**FY 2017-18
DESIGN STANDARDS**

**TRAFFIC RAILING - (VERTICAL FACE RETROFIT)
SPREAD FOOTING APPROACH**

**INDEX NO.
484**

**SHEET NO.
3 of 10**

ESTIMATED TRAFFIC RAILING RETROFIT SPREAD FOOTING APPROACH QUANTITIES		
ITEM	UNIT	QUANTITY
		9" Curb
Concrete - Typical Section	CY/Ft.	0.25
Reinforcing Steel - Typical Section	Lb./Ft.	38
Concrete - 20'-0" Tapered End Transition plus Footing	CY	4.57 Total
Reinforcing Steel - 20'-0" Tapered End Transition plus Footing	Lb.	776 Total

NOTE: Quantities are based on a 9" curb, no curb cross slope.

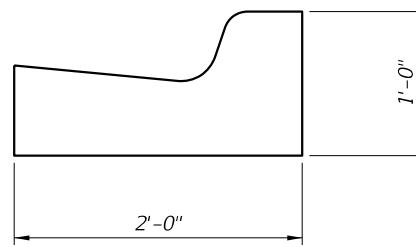

SECTION X-X (TYPICAL CURB, TYPE VARIES, TYPE F SHOWN)
(See Index No. 300 and Plans for Details)

* Match Cross Slope of high side and low side at begin or end bridge or approach slab.

** Match curb height of adjacent bridge and approach slab. Adjust height in Transition area to match adjoining Roadway curb.

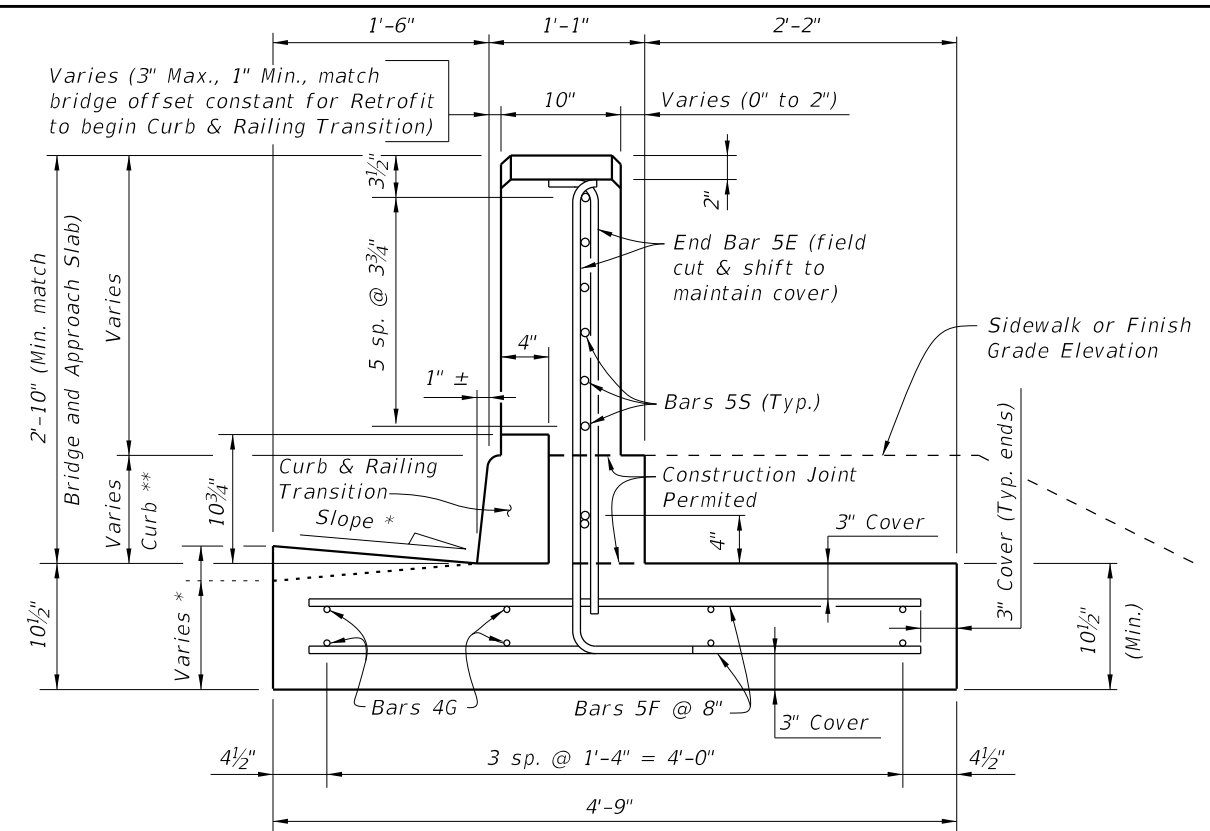

SECTION C-C
(GUARDRAIL END TRANSITION)

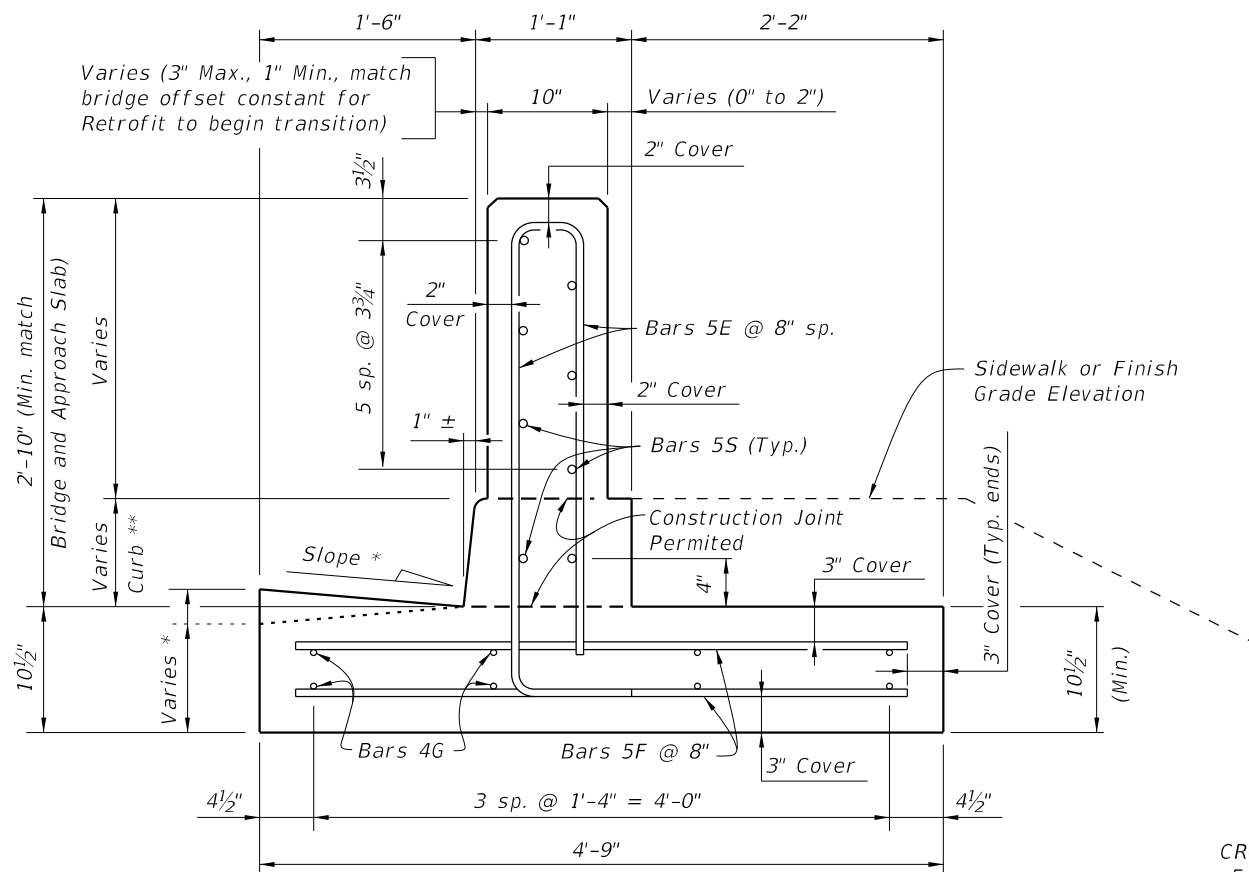

SECTION A-A
TYPICAL SECTION
(9" Curb shown, 6" Curb similar)

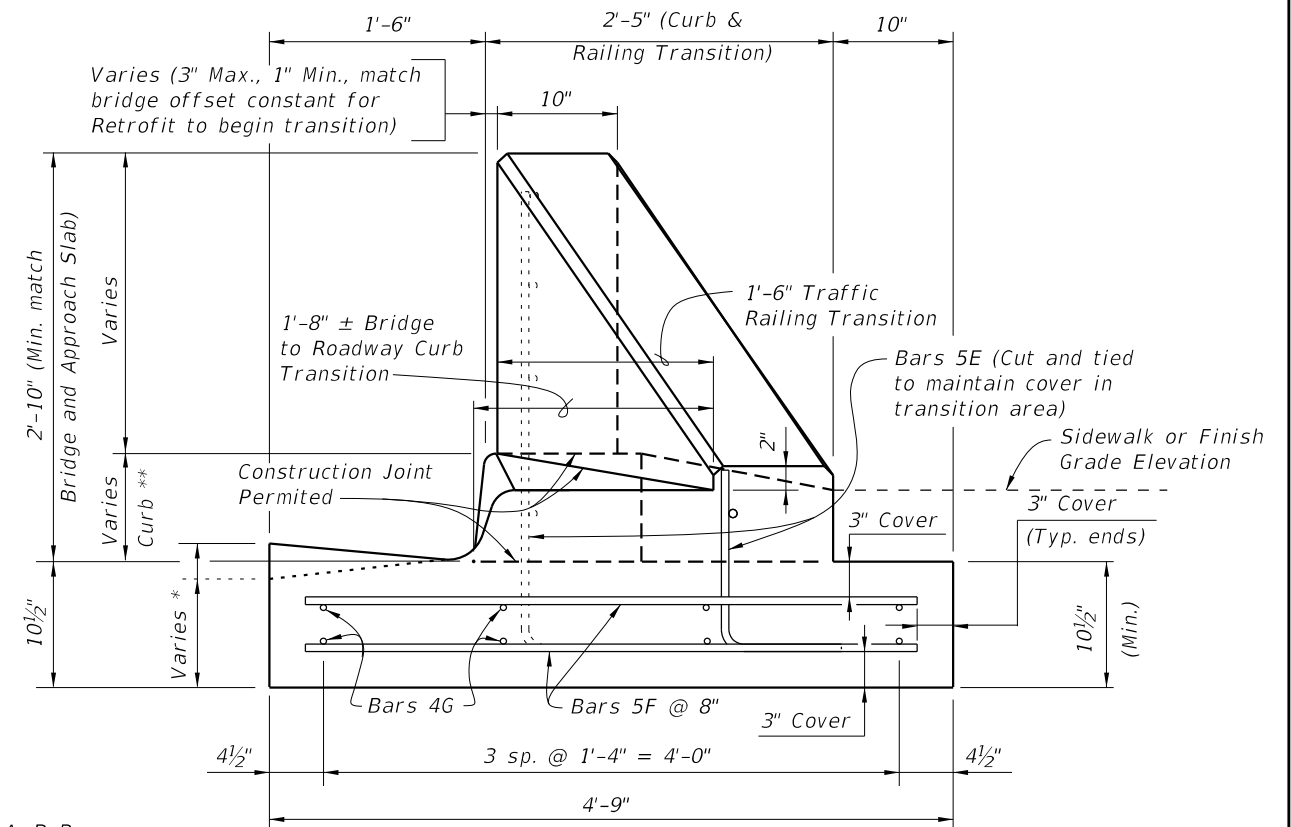

SECTION B-B
TAPERED END TRANSITION
(Bars 5S not shown for clarity)

CROSS REFERENCES:
For location of Sections A-A, B-B and X-X see Sheet 2.
For location of Section C-C see Sheet 3.

10/26/2016 8:23:23 AM

LAST REVISION	DESCRIPTION:
07/01/09	

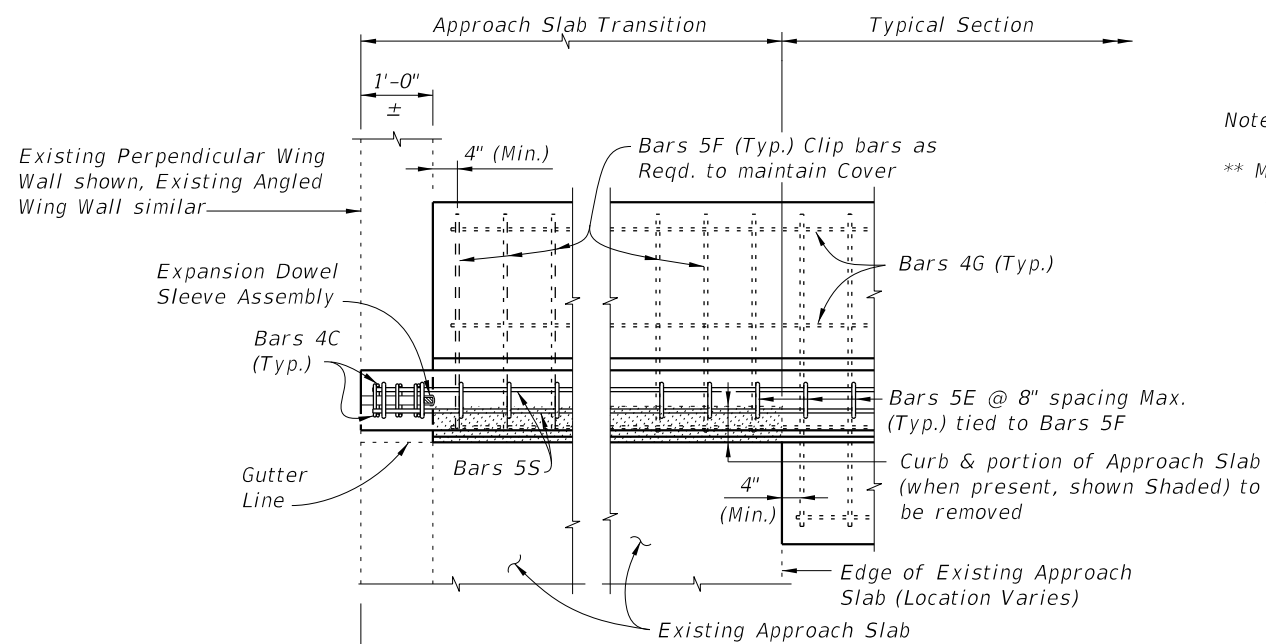

Existing Perpendicular Wing Wall shown, Existing Angled Wing Wall similar

PARTIAL PLAN

Note:

** Match curb height of adjacent bridge and approach slab.

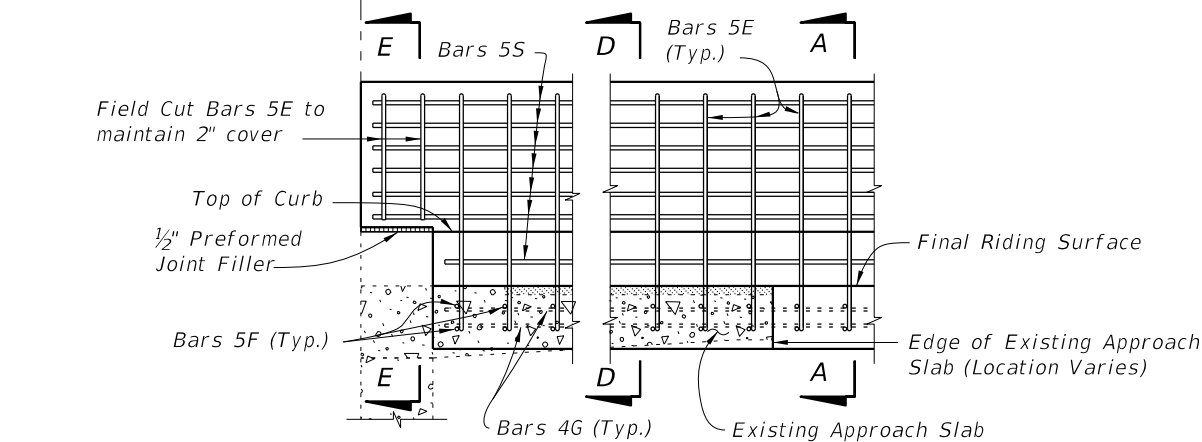

PARTIAL ELEVATION OF INSIDE FACE OF RAILING
(Expansion Dowel Assemblies and Bars 4C not shown for clarity)

SCHEME 1 ~ MODIFICATION FOR INDEX NO. 481, 482 AND 483 - SCHEME 1
RAILING END TREATMENT FOR PERPENDICULAR OR ANGLED WING WALLS WITH NARROW CURBS (SHOWN), WIDE CURBS AND INTERMEDIATE CURBS (SIMILAR)

CROSS REFERENCE:
For Section A-A see Sheet 4.
For Expansion Dowel Assembly and placement of Dowel Bars 6D Details see Index 480.

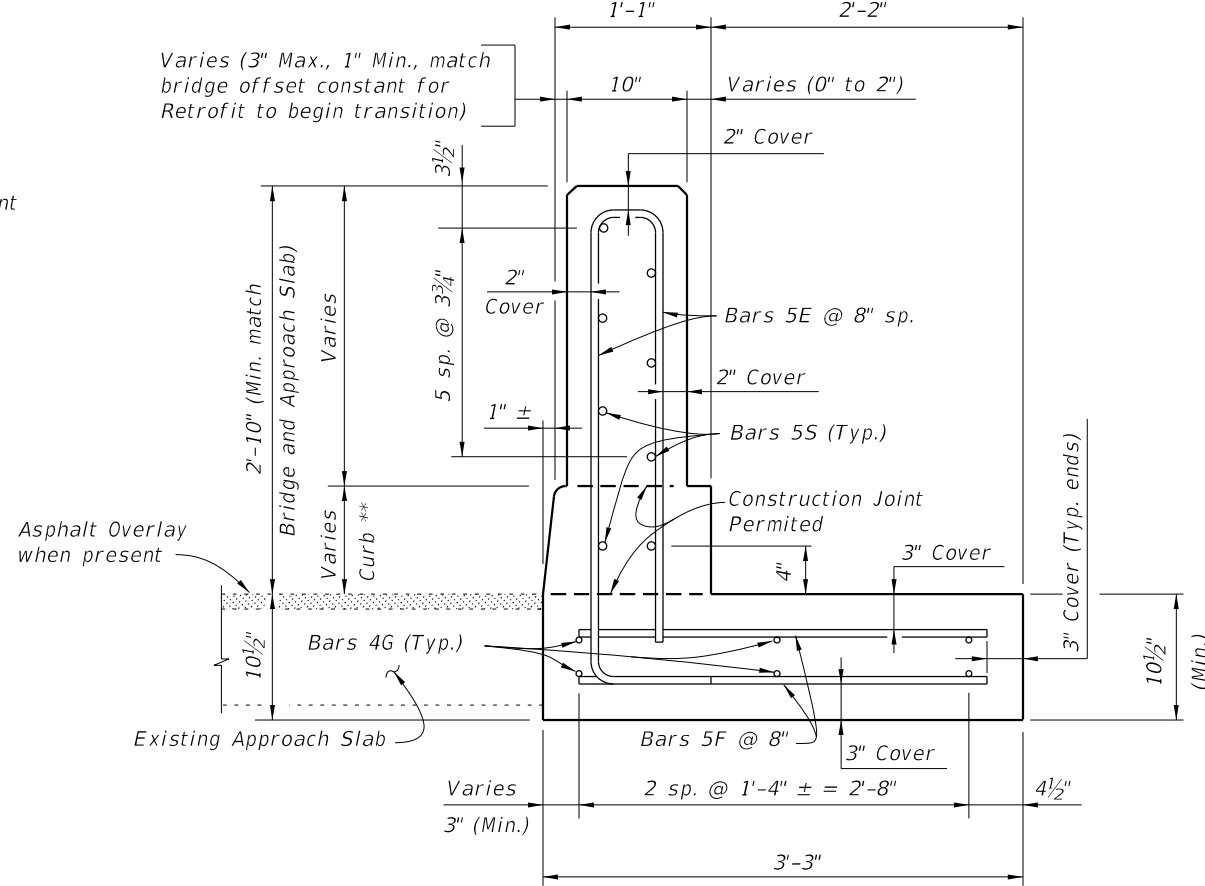

SECTION D-D

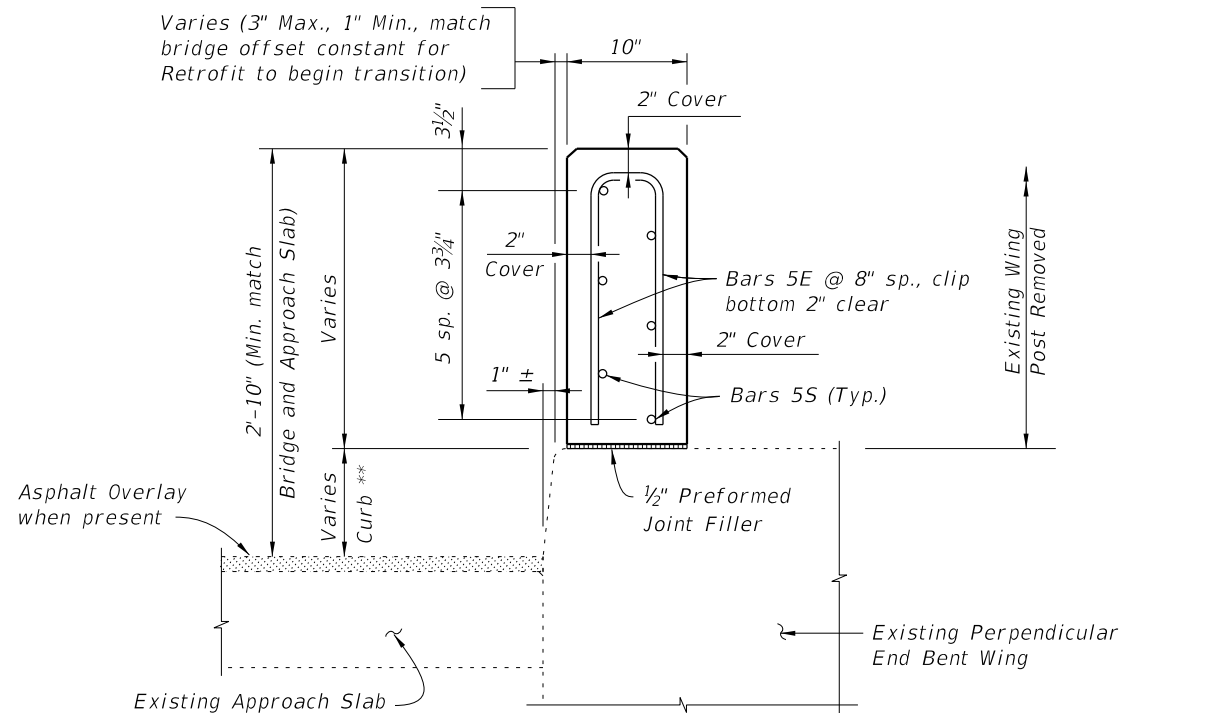

SECTION E-E (NARROW CURB SHOWN, WIDE AND INTERMEDIATE CURBS SIMILAR)

10/26/2016 8:23:26 AM

LAST REVISION 07/01/09	REVISION	DESCRIPTION:	 FY 2017-18 DESIGN STANDARDS	TRAFFIC RAILING - (VERTICAL FACE RETROFIT) SPREAD FOOTING APPROACH	INDEX NO. 484	SHEET NO. 5 of 10
---------------------------	----------	--------------	--	---	-------------------------	-----------------------------

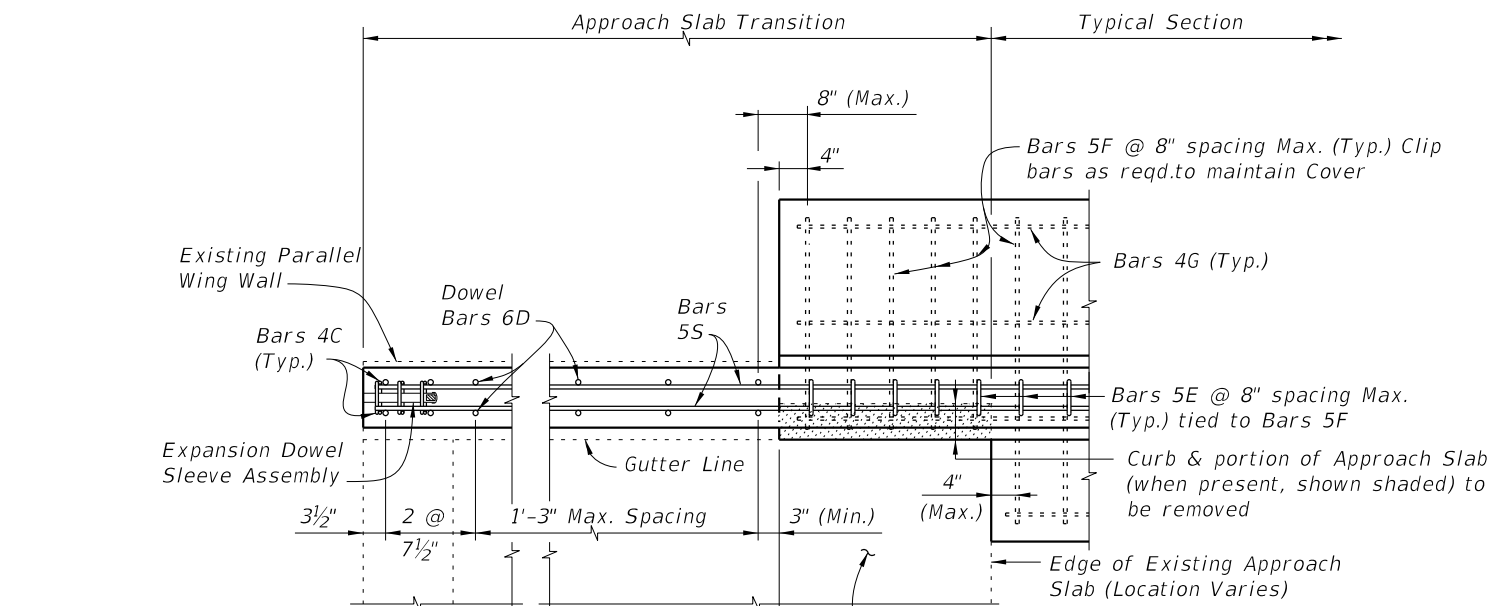

PARTIAL PLAN

Front Face of Backwall, Begin or End Bridge & Match Line (See Index No. 481, Sheet 2)

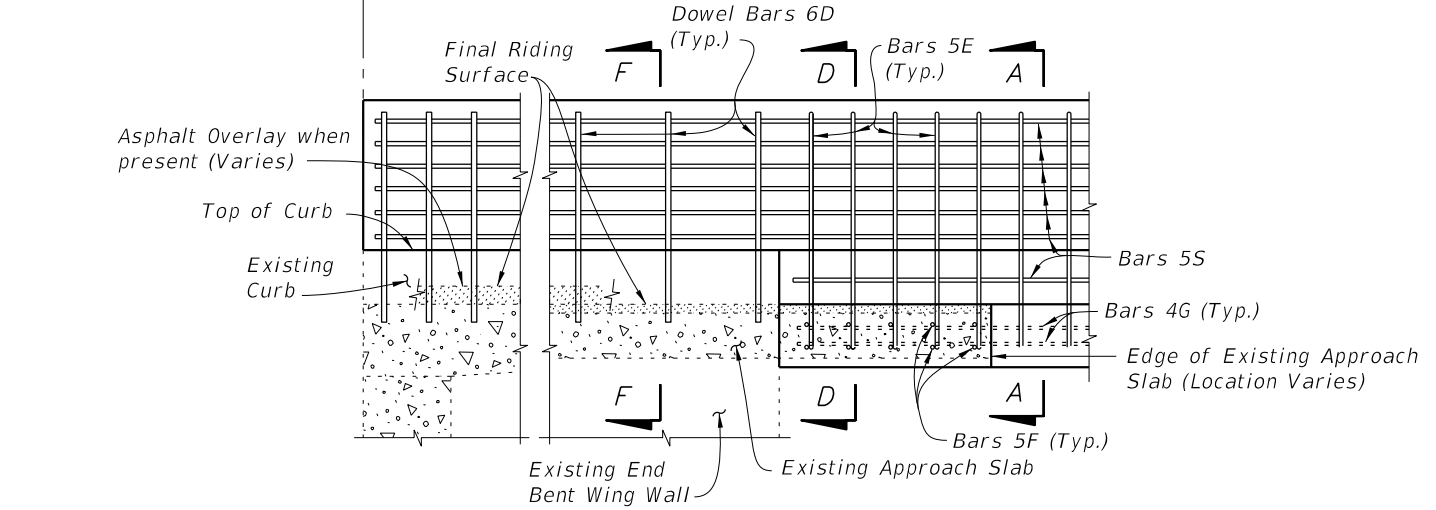

PARTIAL ELEVATION OF INSIDE FACE OF RAILING
(Expansion Dowel Assemblies and Bars 4C not shown for clarity)

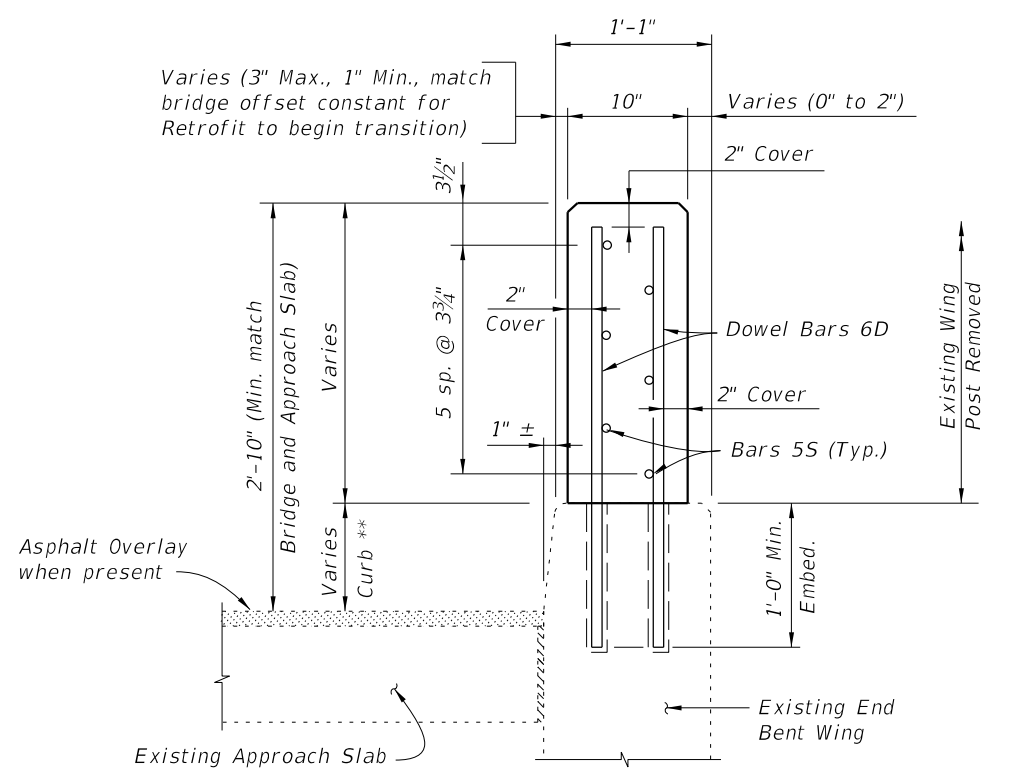

SECTION F-F

Note:
** Match curb height at adjoining existing end bent wing.

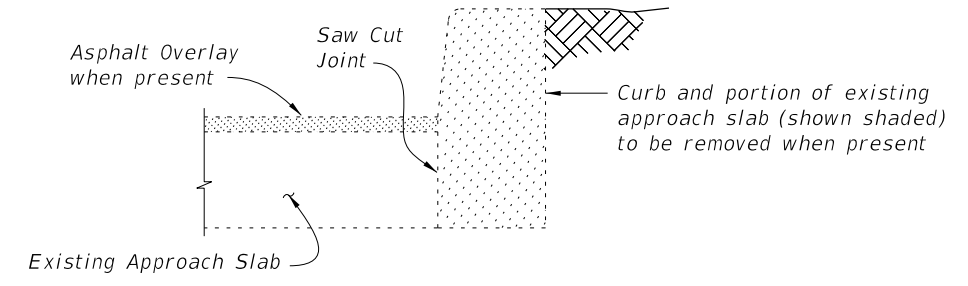

SECTION THRU EXISTING CURB AND APPROACH SLAB TO BE REMOVED
(Free Standing Curb Similar)

SCHEME 2 ~ MODIFICATION FOR INDEX NO. 481 - SCHEME 2
RAILING END TREATMENT FOR PARALLEL WING WALLS WITH NARROW CURBS

- NOTES:
1. Remove existing concrete along saw cut joints. Existing reinforcing steel may be cut at joint or extended into new concrete. Exposed existing reinforcing not encased in new concrete shall be removed 1" below existing concrete surface and grouted over.

- CROSS REFERENCES:
- For Section A-A see Sheet 4.
 - For Section D-D see Sheet 5.
 - For Expansion Dowel Assembly and placement of Dowel Bars 6D Details see Index 480.

10/26/2016 8:23:28 AM

LAST REVISION 07/01/09	DESCRIPTION:	 FY 2017-18 DESIGN STANDARDS	TRAFFIC RAILING - (VERTICAL FACE RETROFIT) SPREAD FOOTING APPROACH	INDEX NO. 484	SHEET NO. 6 of 10
---------------------------	--------------	--	---	-------------------------	-----------------------------

10/26/2016 8:23:31 AM

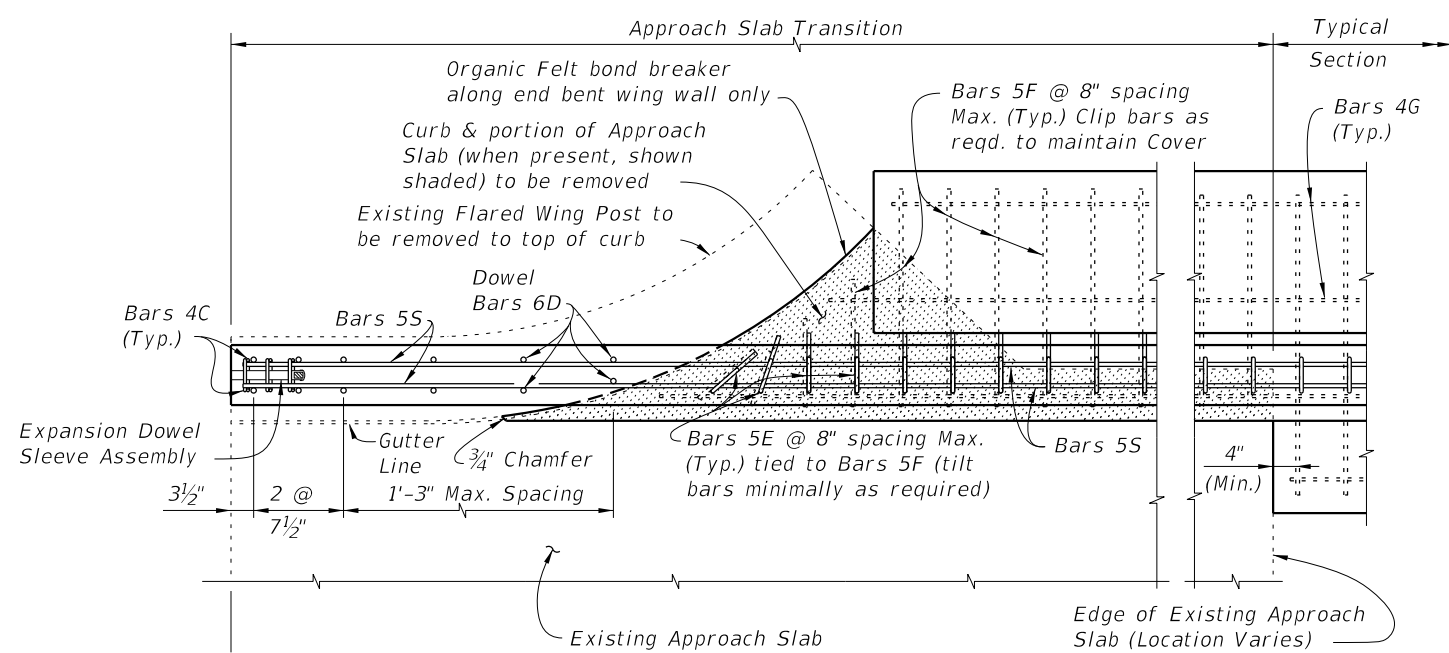

PARTIAL PLAN OF RAILING

Front Face of Backwall, Begin or End Bridge & Match Line (See Index No. 481, Sheet 3)

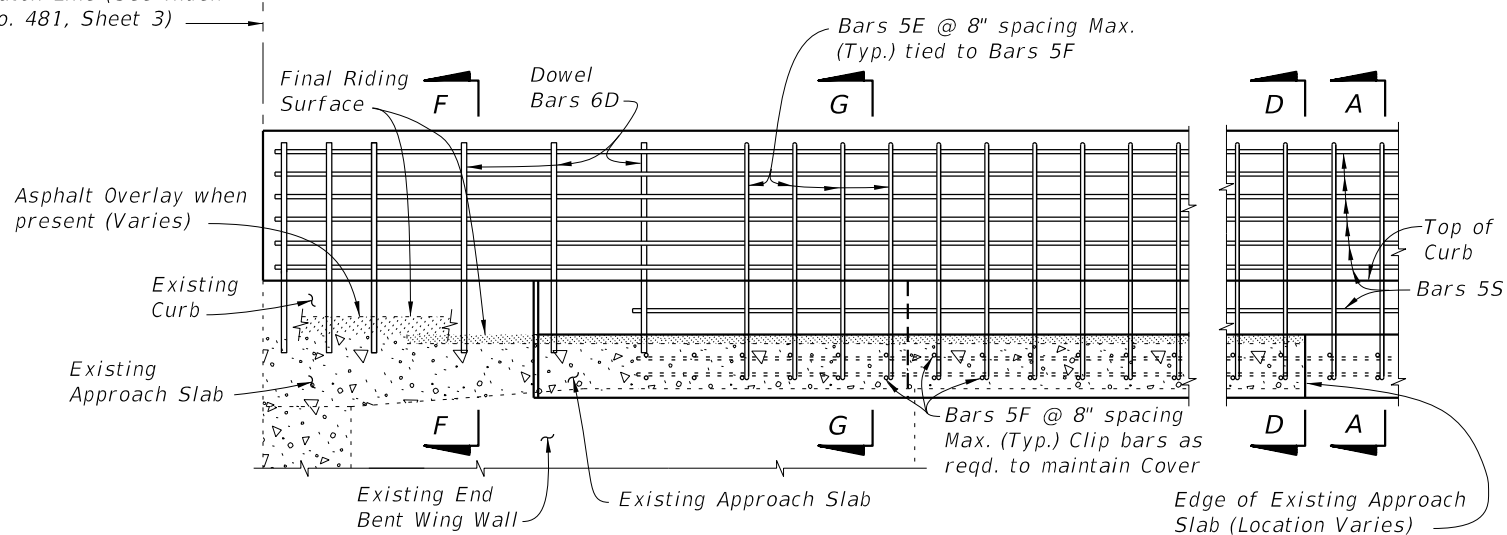

PARTIAL ELEVATION OF INSIDE FACE OF RAILING
(Expansion Dowel Assemblies and Bars 4C not shown for clarity)

SCHEME 3 ~ MODIFICATION FOR INDEX NO. 481 SCHEME 3
RAILING END TREATMENT FOR FLARED WING WALLS
WITH NARROW CURBS

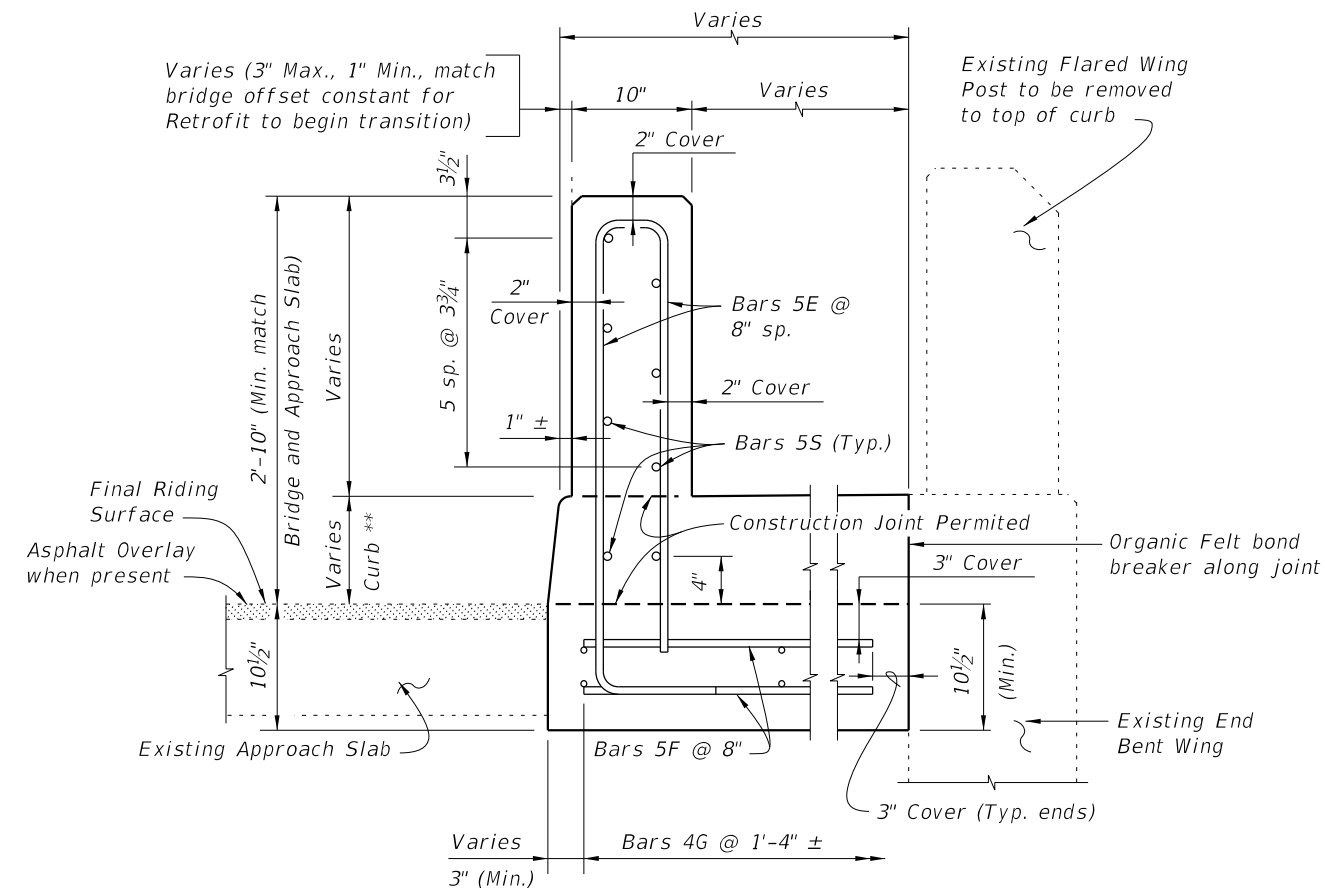

SECTION G-G

Note:
** Match curb height at adjoining existing end bent wing.

CROSS REFERENCES:
For Section A-A see Sheet 4.
For Section D-D see Sheet 5.
For Section F-F see Sheet 6.
For Expansion Dowel Assemblies Details and placement of Dowel Bars 6D see Index 480.

LAST REVISION 11/01/16	DESCRIPTION:	FY 2017-18 DESIGN STANDARDS	TRAFFIC RAILING - (VERTICAL FACE RETROFIT) SPREAD FOOTING APPROACH	INDEX NO. 484	SHEET NO. 7 of 10
---------------------------	--------------	--	---	-------------------------	-----------------------------

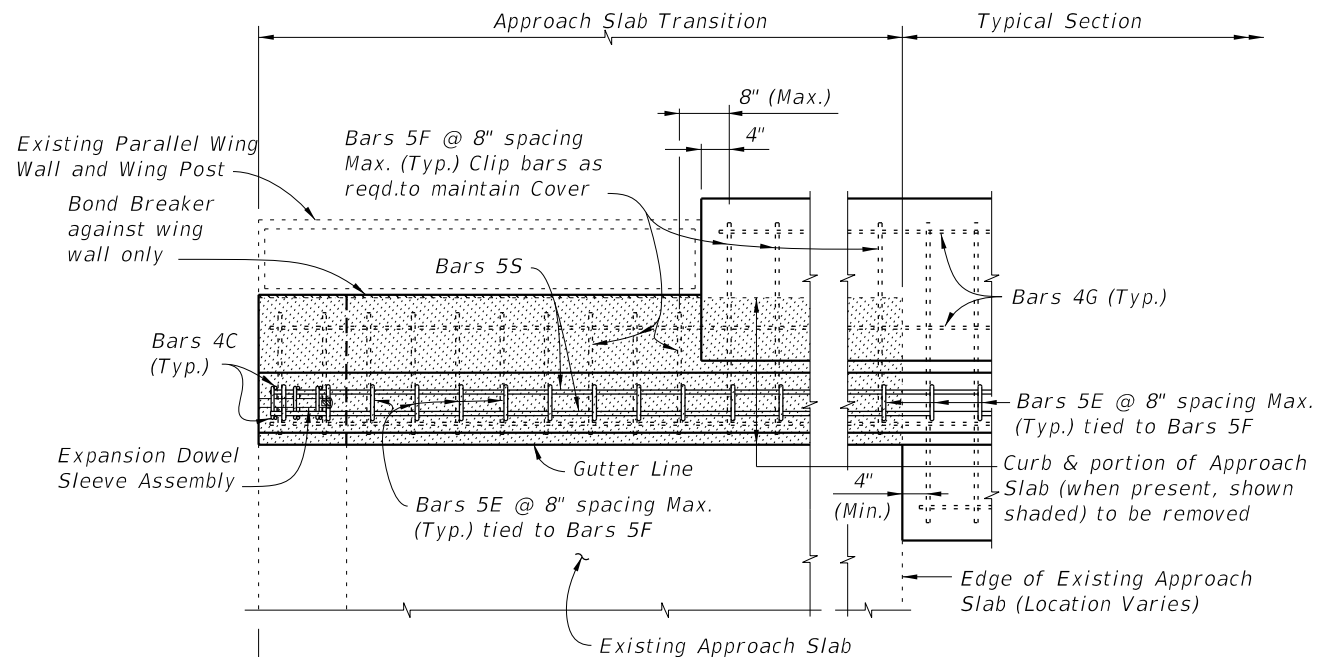

PARTIAL PLAN OF RAILING

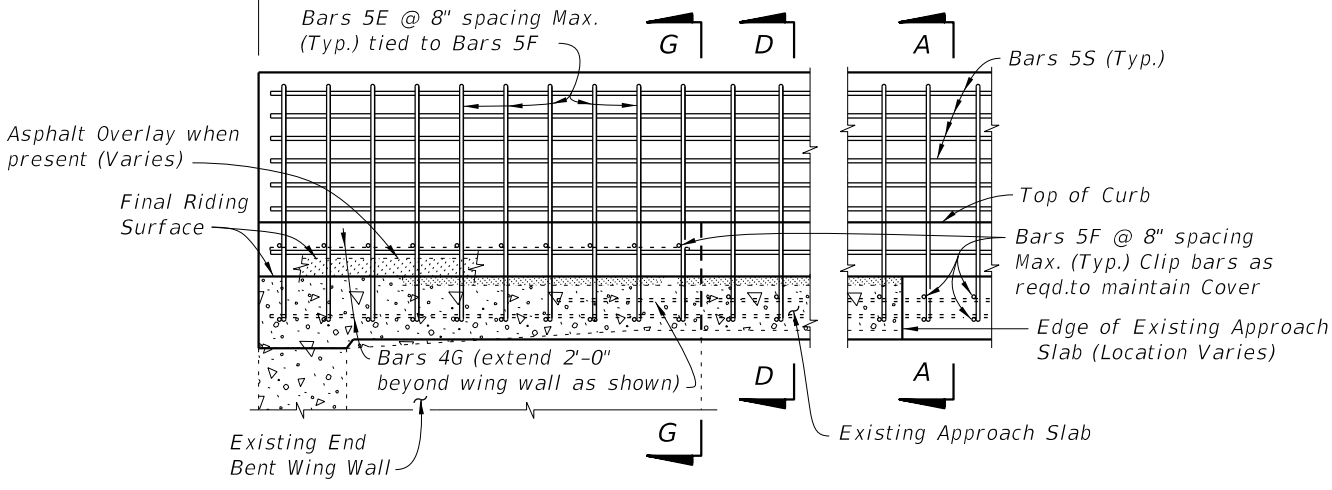

PARTIAL ELEVATION OF INSIDE FACE OF RAILING
(Existing Wing Post, Expansion Dowel Assemblies and Bars 4C not shown for clarity)

SCHEME 4 ~ MODIFICATION FOR INDEX NO. 482 SCHEME 2
RAILING END TREATMENT FOR PARALLEL CURBS AND WING WALLS WITH WIDE CURBS

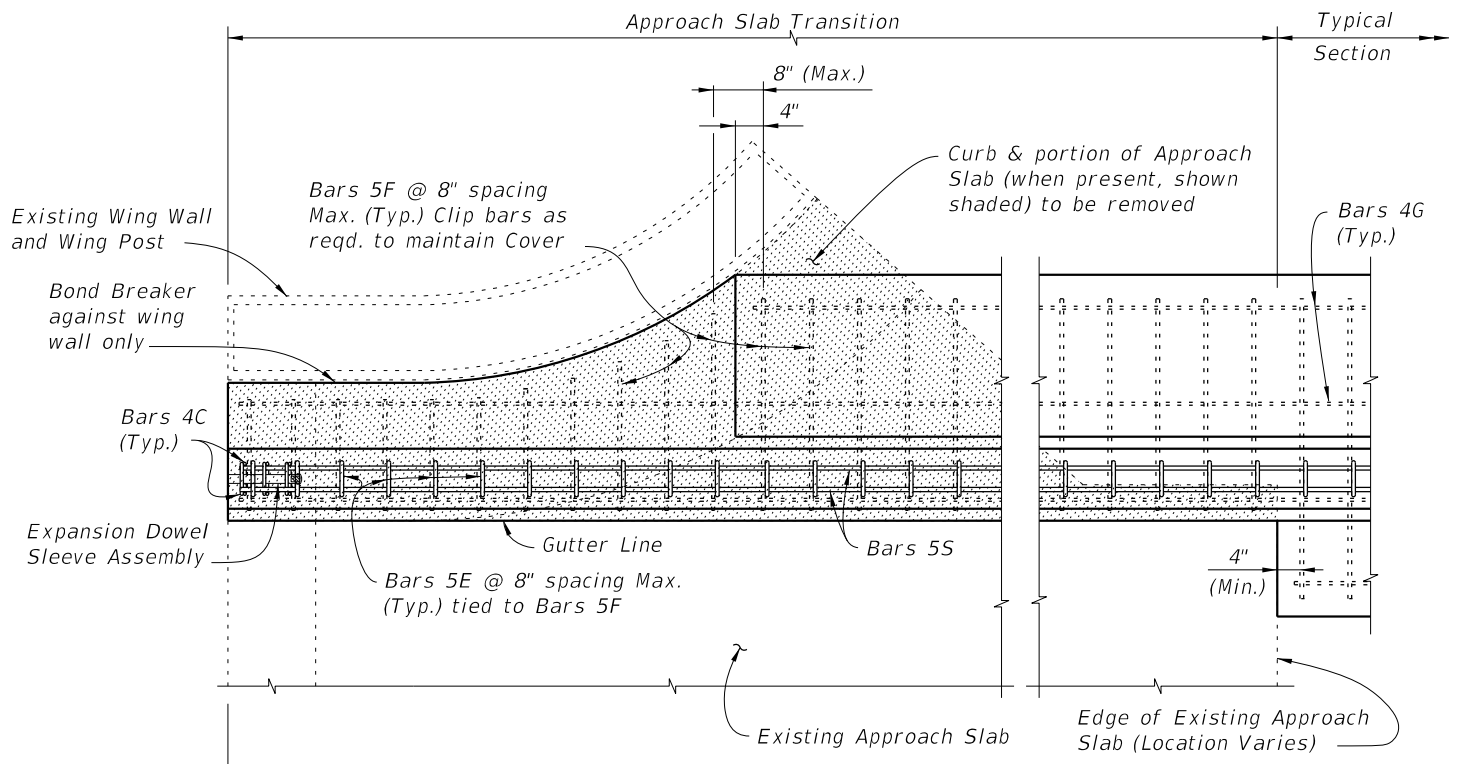

PARTIAL PLAN OF RAILING

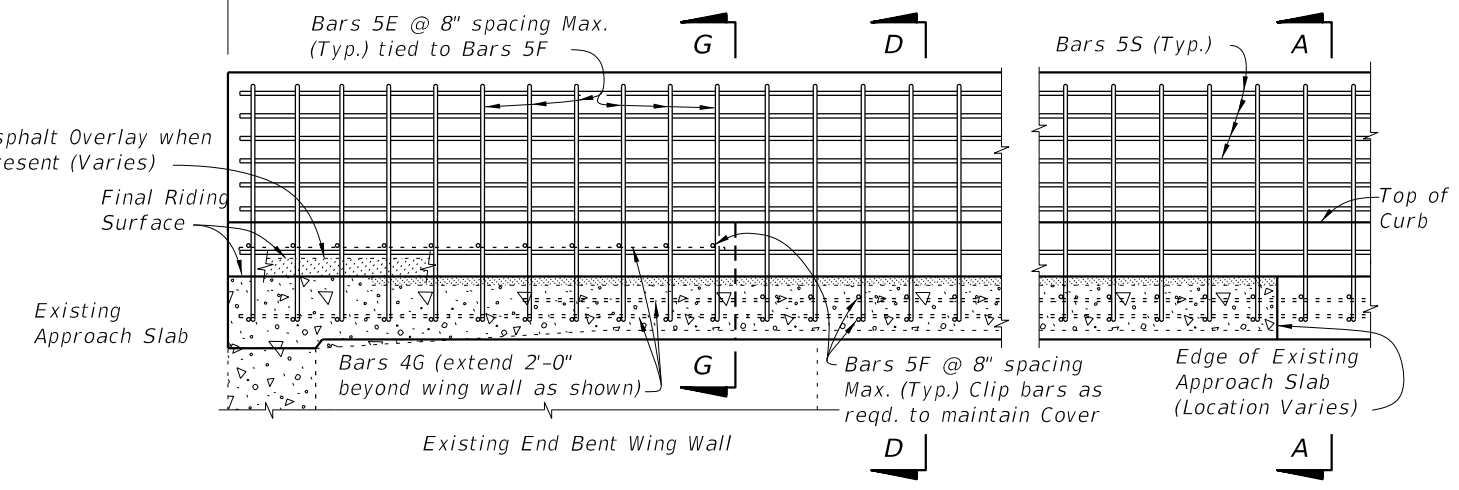

PARTIAL ELEVATION OF INSIDE FACE OF RAILING
(Existing Wing Post, Expansion Dowel Assemblies and Bars 4C not shown for clarity)

SCHEME 5 ~ MODIFICATION FOR INDEX NO. 482 SCHEME 3 AND 4
RAILING END TREATMENT FOR PARALLEL CURBS AND FLARED WING WALLS WITH WIDE CURBS

CROSS REFERENCES:
For Section A-A see Sheet 4
For Section D-D see Sheet 5.
For Section G-G see Sheet 7.
For Expansion Dowel Assemblies Details see Index 480.

10/26/2016 8:23:33 AM

LAST REVISION 07/01/09	REVISION	DESCRIPTION:	 FY 2017-18 DESIGN STANDARDS	TRAFFIC RAILING - (VERTICAL FACE RETROFIT) SPREAD FOOTING APPROACH	INDEX NO. 484	SHEET NO. 8 of 10
---------------------------	----------	--------------	---	---	------------------	----------------------

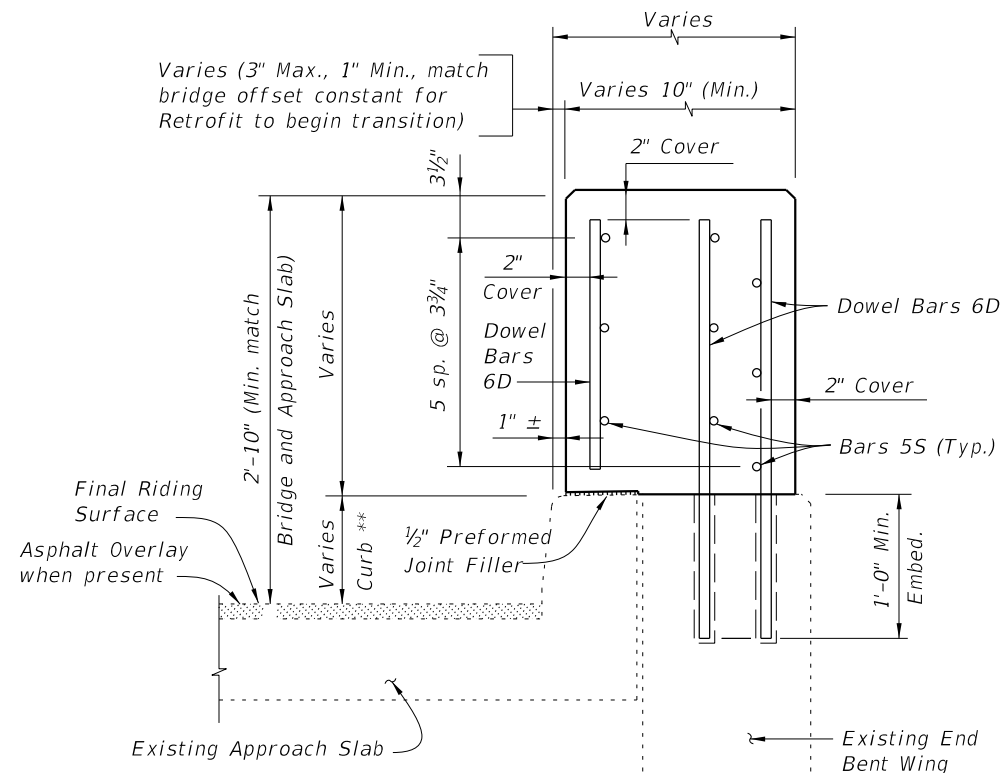
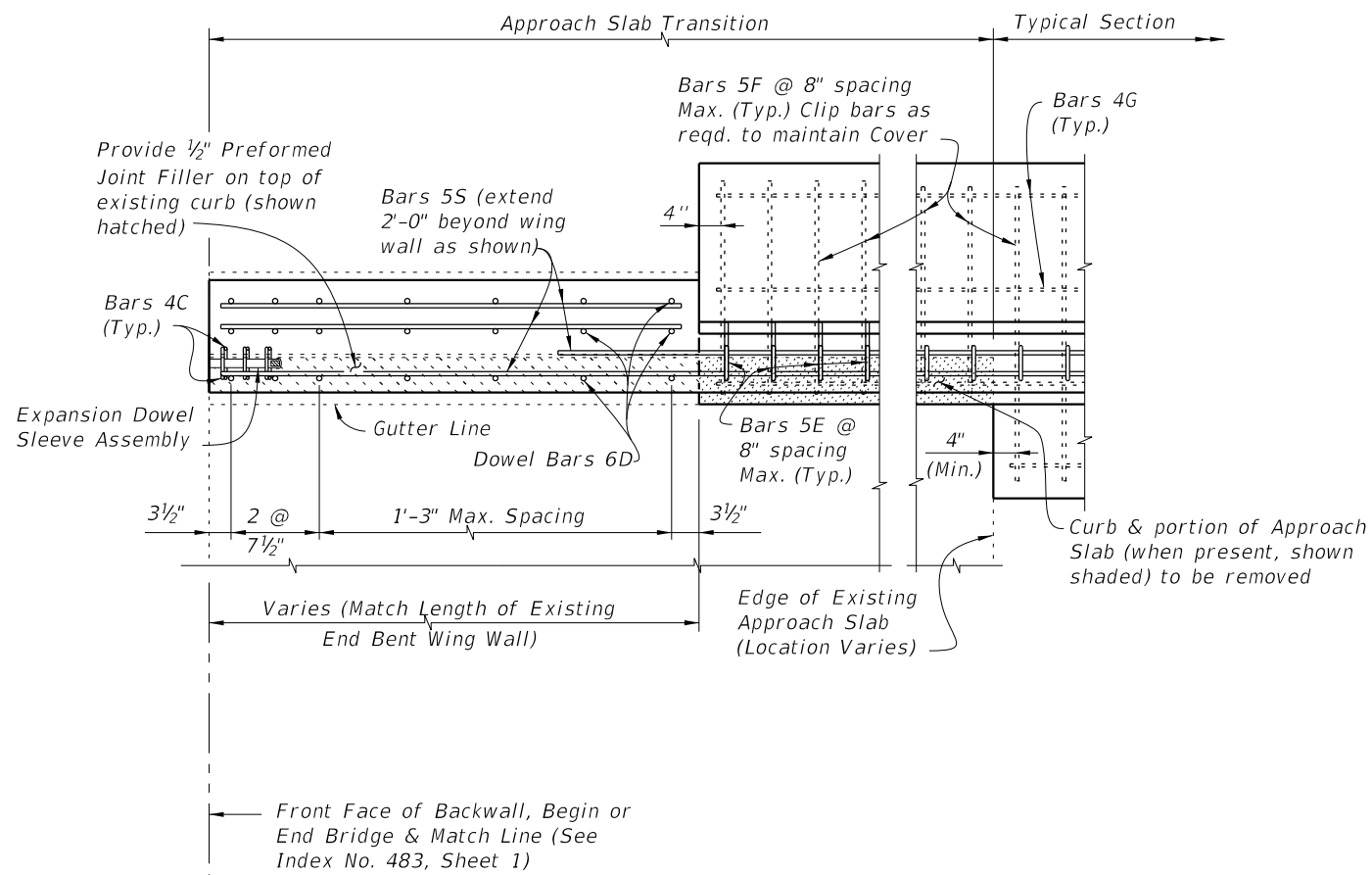

SECTION H-H

Note:
 ** Match curb height at adjoining existing end bent wing.

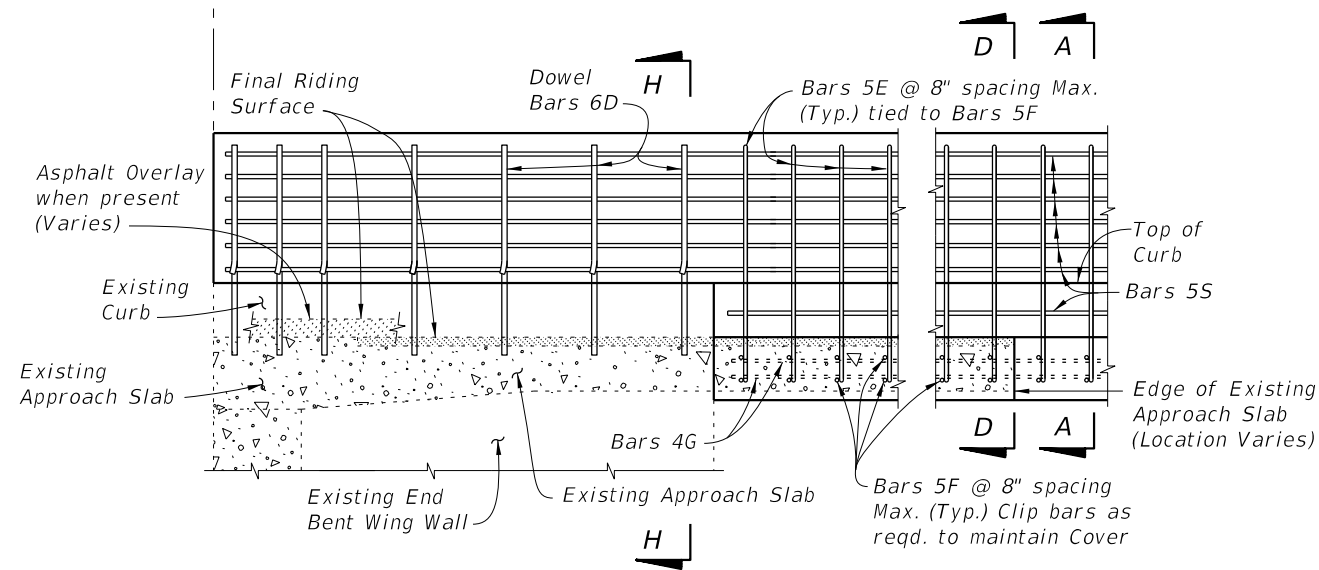

PARTIAL ELEVATION OF INSIDE FACE OF RAILING
 (Expansion Dowel Assemblies and Bars 4C not shown for clarity)

SCHEME 6 ~ MODIFICATION FOR INDEX NO. 483 SCHEME 2
 RAILING END TREATMENT FOR PARALLEL CURBS AND WING WALLS WITH INTERMEDIATE CURBS

CROSS REFERENCES:
 For Section A-A see Sheet 4.
 For Section D-D see Sheet 5.
 For Expansion Dowel Assembly and placement of Dowel Bars 6D Details see Index 480.

10/26/2016 8:23:36 AM

LAST REVISION 07/01/09	DESCRIPTION:	FDOT FY 2017-18 DESIGN STANDARDS	TRAFFIC RAILING - (VERTICAL FACE RETROFIT) SPREAD FOOTING APPROACH	INDEX NO. 484	SHEET NO. 9 of 10
---------------------------	--------------	--	---	------------------	----------------------

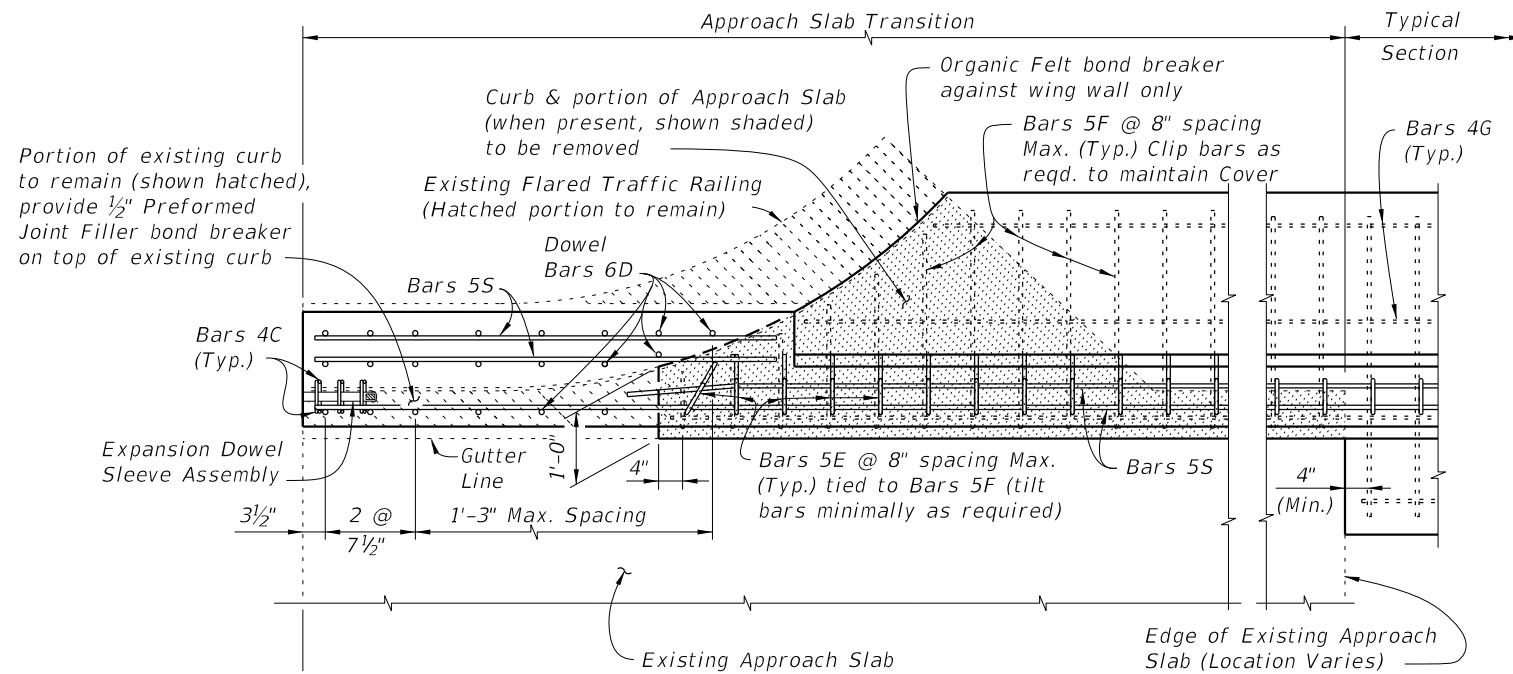

PARTIAL PLAN OF RAILING

Front Face of Backwall, Begin or End Bridge & Match Line (See Index No. 483, Sheet 3)

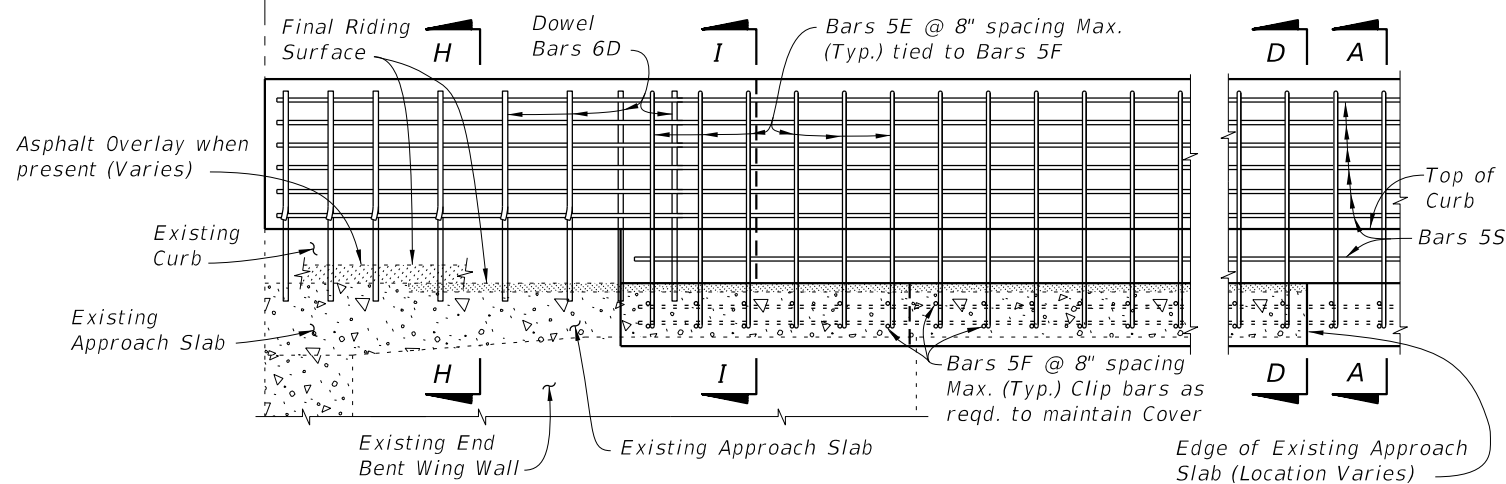

PARTIAL ELEVATION OF INSIDE FACE OF RAILING
(Expansion Dowel Assemblies and Bars 4C not shown for clarity)

SCHEME 7 ~ MODIFICATION FOR INDEX NO. 483 SCHEME 3
RAILING END TREATMENT FOR PARALLEL CURBS AND
FLARED WING WALLS WITH INTERMEDIATE CURBS

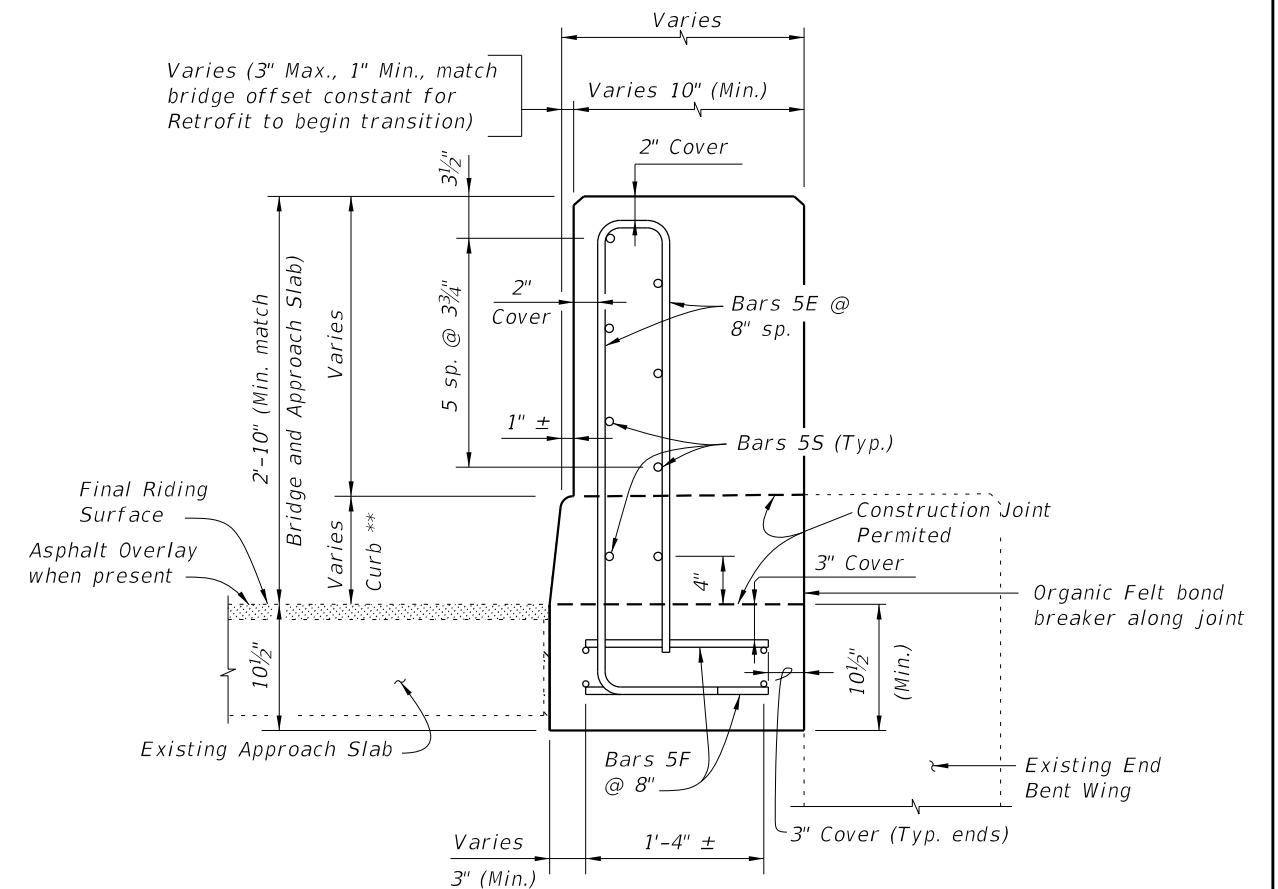

SECTION I-I

Note:
** Match curb height at adjoining existing end bent wing.

CROSS REFERENCES:
For Section A-A see Sheet 4.
For Section D-D see Sheet 5.
For Section H-H see Sheet 9.
For Expansion Dowel Assemblies and placement of Dowel Bars 6D Details see Index 480.

10/26/2016 8:23:38 AM

LAST REVISION 11/01/16	REVISION	DESCRIPTION:	 FY 2017-18 DESIGN STANDARDS	TRAFFIC RAILING - (VERTICAL FACE RETROFIT) SPREAD FOOTING APPROACH	INDEX NO. 484	SHEET NO. 10 of 10
---------------------------	----------	--------------	------------------------------------	---	------------------	-----------------------