

GENERAL NOTES

CONCRETE: Concrete for the Traffic Railing (Vertical Face Retrofit) shall be Class IV. Concrete for Curb Transition Blocks shall be Class II (Bridge Deck).

ADHESIVE-BONDED DOWELS: Adhesive Bonding Material Systems for Dowels shall comply with Specification Section 937 and be installed in accordance with Specification Section 416. The field testing proof loads required by Specification Section 416 shall be 23,800 lbs. for Dowel Bars 6D on the inside face (traffic side) of the railing (1'-0" embedment) and 18,500 lbs for Dowel Bars 6D along the outside face of the traffic railing (5" min. embedment).

BRIDGES ON CURVED ALIGNMENTS: The details presented in this Standard are shown for bridges on tangent alignments. Details for bridges on horizontally curved alignments are similar.

BARRIER DELINEATORS: Barrier Delineators shall meet Specification Section 993. Install Barrier Delineators on top of the Traffic Railing along the entire length of the bridge 2" from the face on the traffic side at the spacing shown in the table below. Barrier Delineator color (white or yellow) shall match the color of the near edgeline.

GUARDRAIL: See Index 400 for guardrail component details, geometric layouts and associated notes not fully detailed herein.

BRIDGE NAME PLATE: If a portion of the existing Traffic Railing is to be removed that carries the bridge name, number and or date, or if the installation of the Traffic Railing (Thrie Beam Retrofit) will obscure the bridge name, number and or date, then replace the information that has been removed or obscured, with 3" tall black lettering on white nonreflective sheeting applied to the top of the adjacent guardrail. The information must be clearly visible from the right side of the approaching travel lane. The sheeting and adhesive backing shall comply with Specification Section 994 and may comprise individual decals of letters and numbers.

PAYMENT: Guardrail Bridge Anchorage Assembly (each) includes all barrier delineators for the entire bridge length, transition blocks, and necessary hardware to complete the Guardrail transitions shown.

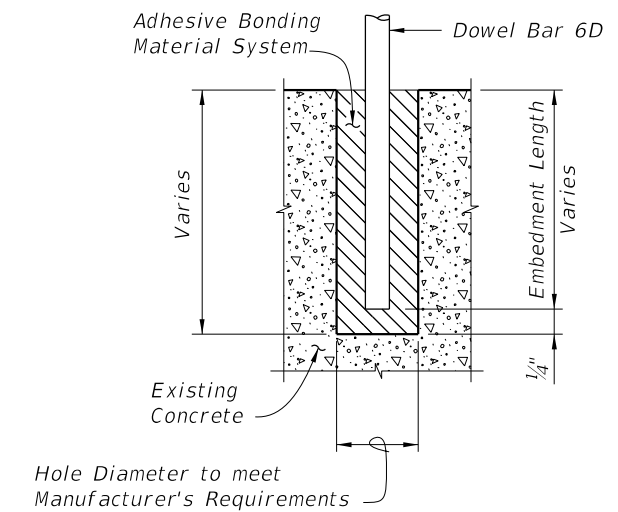

DOWEL DETAIL

Note:
Shift dowel holes to clear if the existing reinforcement is encountered.

BARRIER DELINEATOR SPACING	
Distance - Edge of Travel Lane to Face of Railing	Spacing (Ft.)
< 4'	40'
4' to 8'	80'
> than 8'	None Required

10/24/2016 9:16:57 AM

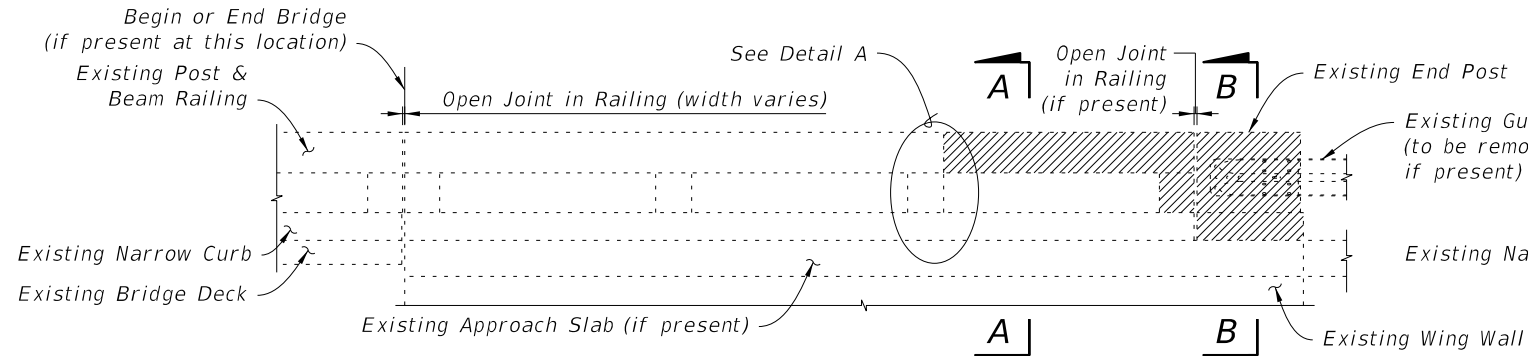

3 OR MORE CONTINUOUS RAILING PANELS ON WINGWALL ADJACENT TO END POST

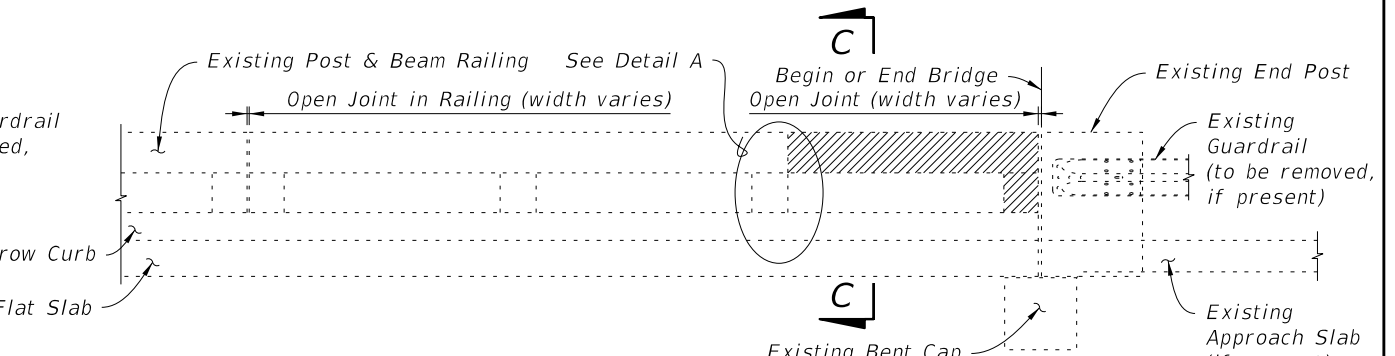

3 OR MORE CONTINUOUS RAILING PANELS ADJACENT TO BEGIN OR END BRIDGE

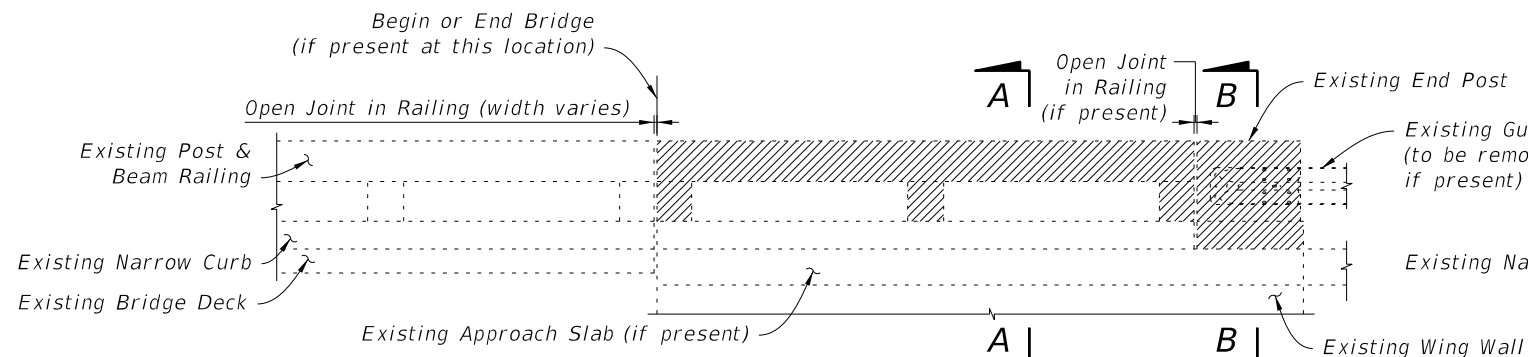

2 CONTINUOUS RAILING PANELS ON WINGWALL ADJACENT TO END POST

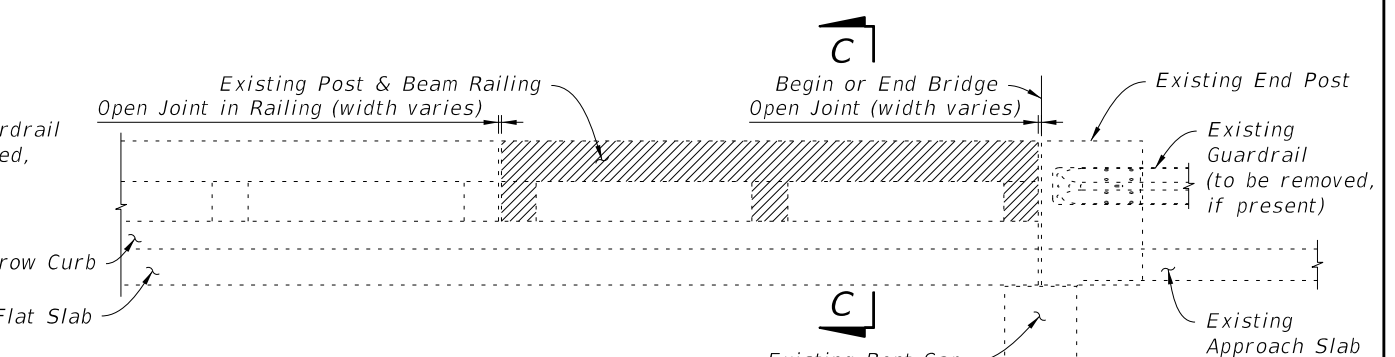

2 CONTINUOUS RAILING PANELS ADJACENT TO BEGIN OR END BRIDGE

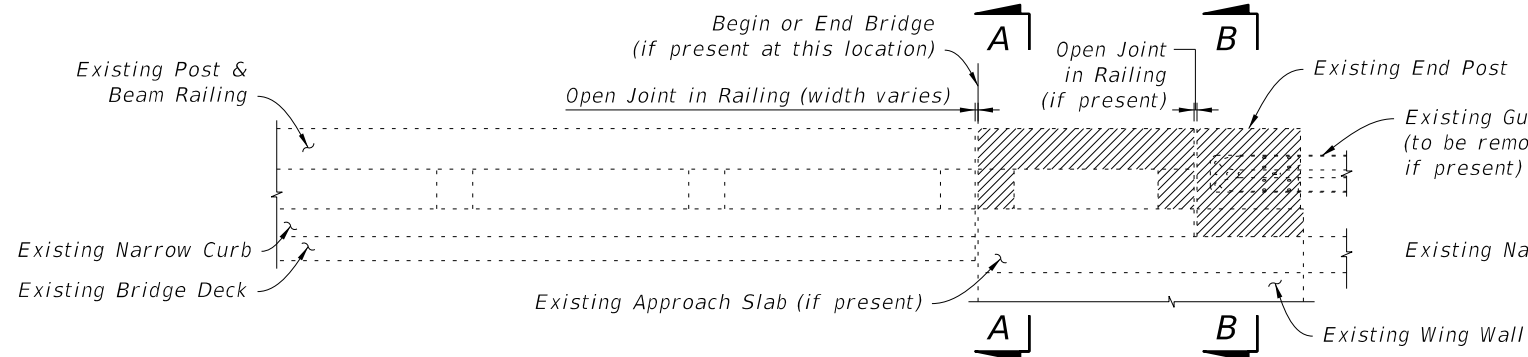

1 RAILING PANEL ON WINGWALL ADJACENT TO END POST

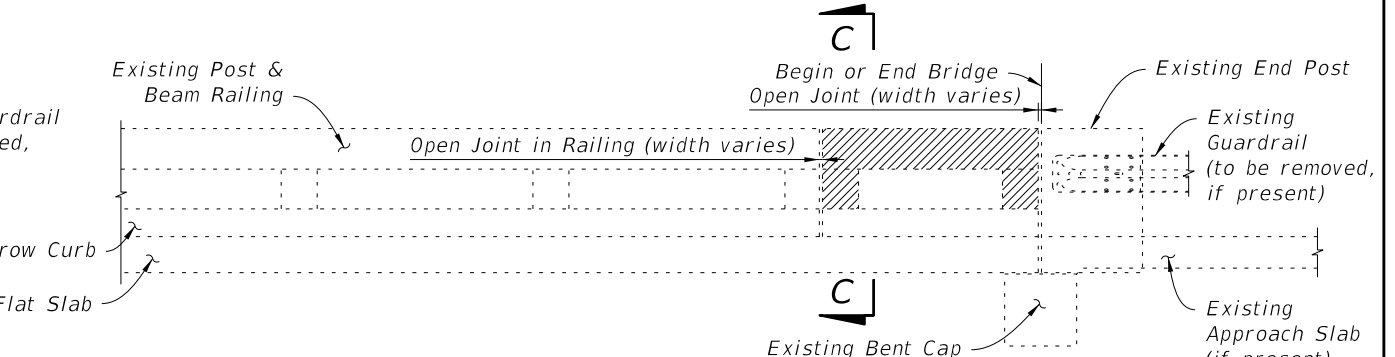

1 RAILING PANEL ADJACENT TO BEGIN OR END BRIDGE

SCHEME 1 - APPROACH ENDS OF BRIDGES WITH BEAM OR GIRDER SUPERSTRUCTURE

SCHEME 2 - APPROACH ENDS OF BRIDGES WITH FLAT SLAB SUPERSTRUCTURE & PARALLEL WINGWALLS (SHOWN) OR BEAM OR GIRDER SUPERSTRUCTURE & PARALLEL OR CURVED WINGWALLS (SIMILAR)

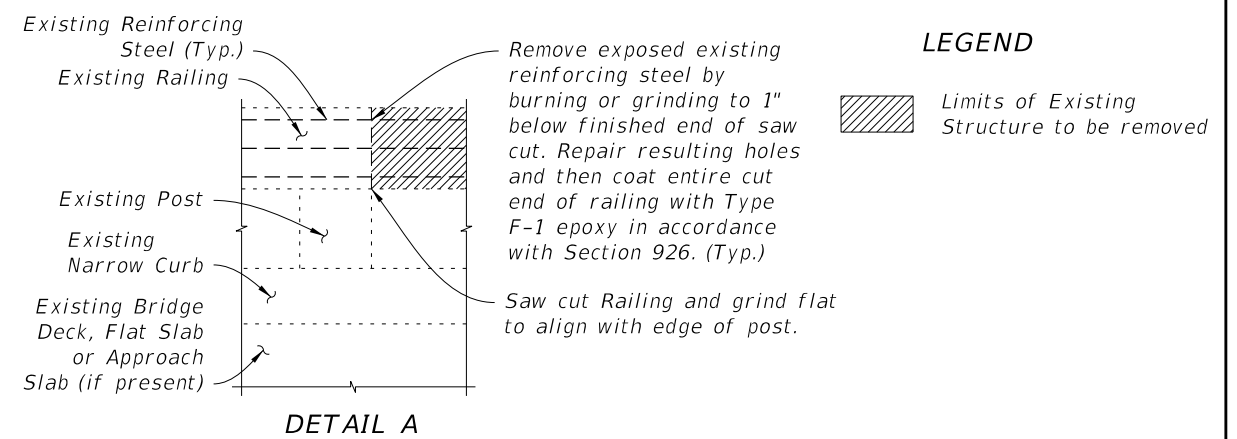
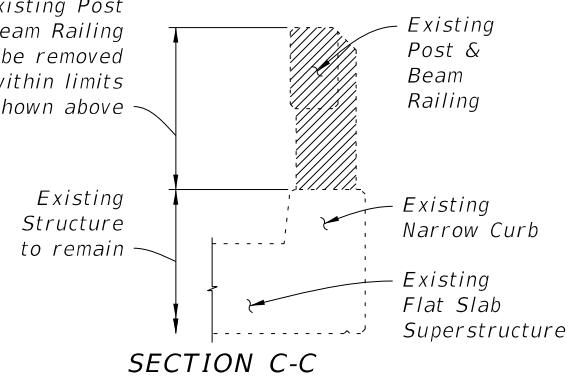
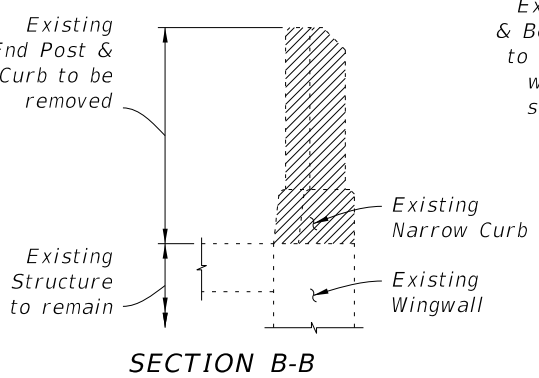
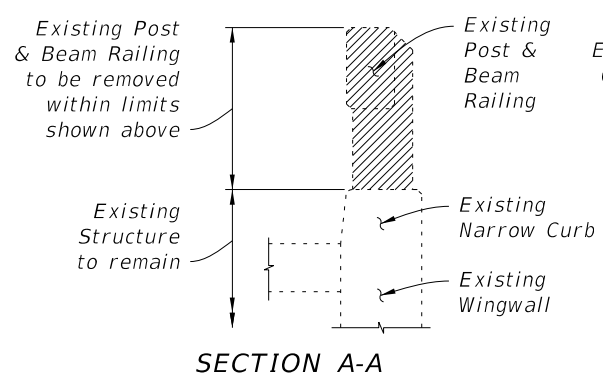

LEGEND
 Limits of Existing Structure to be removed

LIMITS OF REMOVAL OF EXISTING STRUCTURE - POST & BEAM RAILING WITH NARROW CURB

10/24/2016 9:16:59 AM

LAST REVISION	DESCRIPTION:
07/01/13	

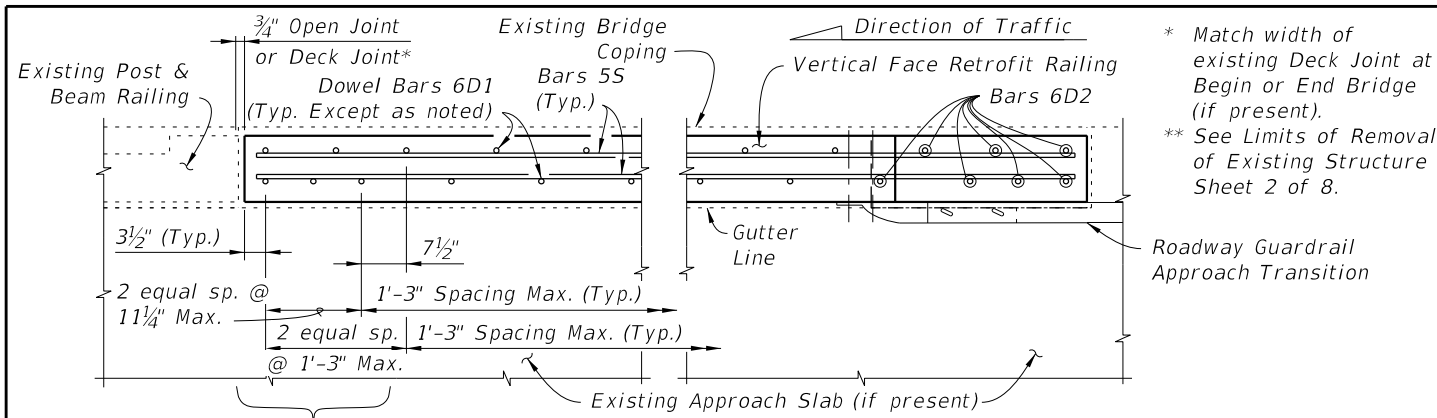

PARTIAL PLAN OF RAILING

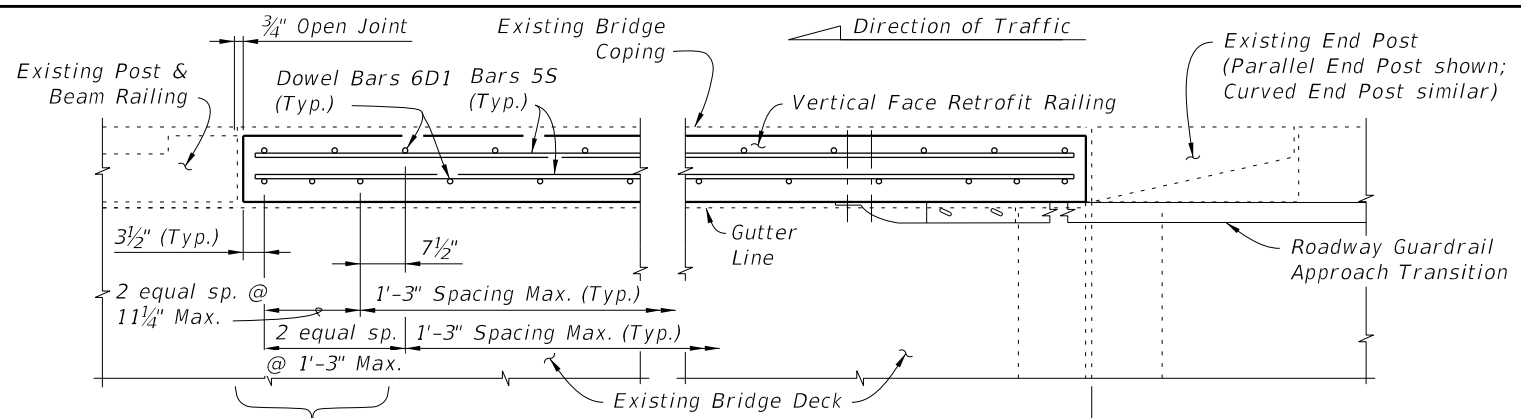

PARTIAL PLAN OF RAILING

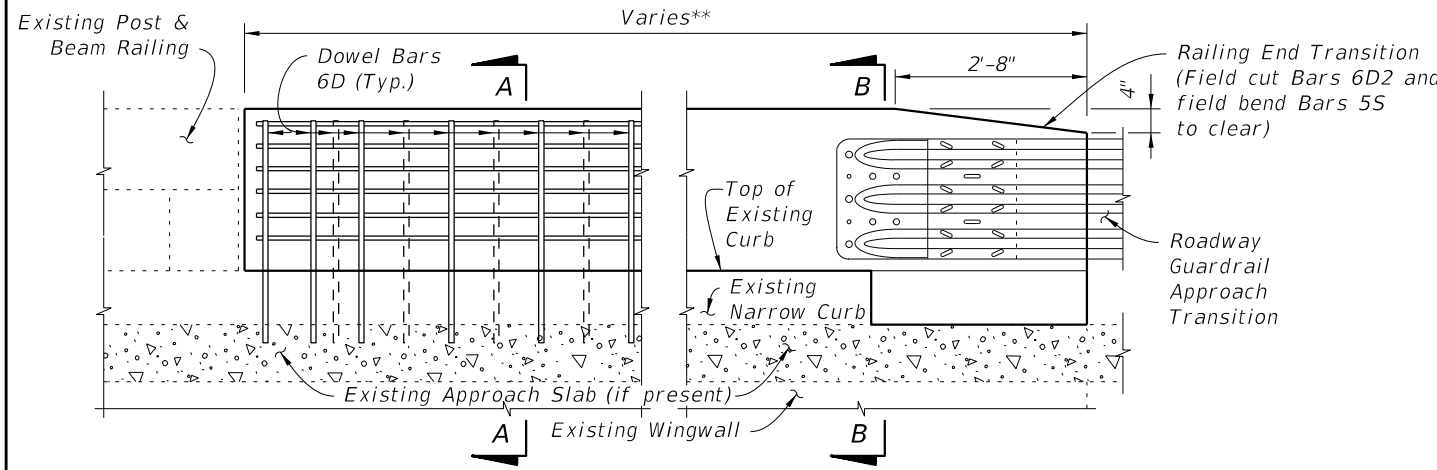

PARTIAL ELEVATION OF INSIDE FACE OF RAILING

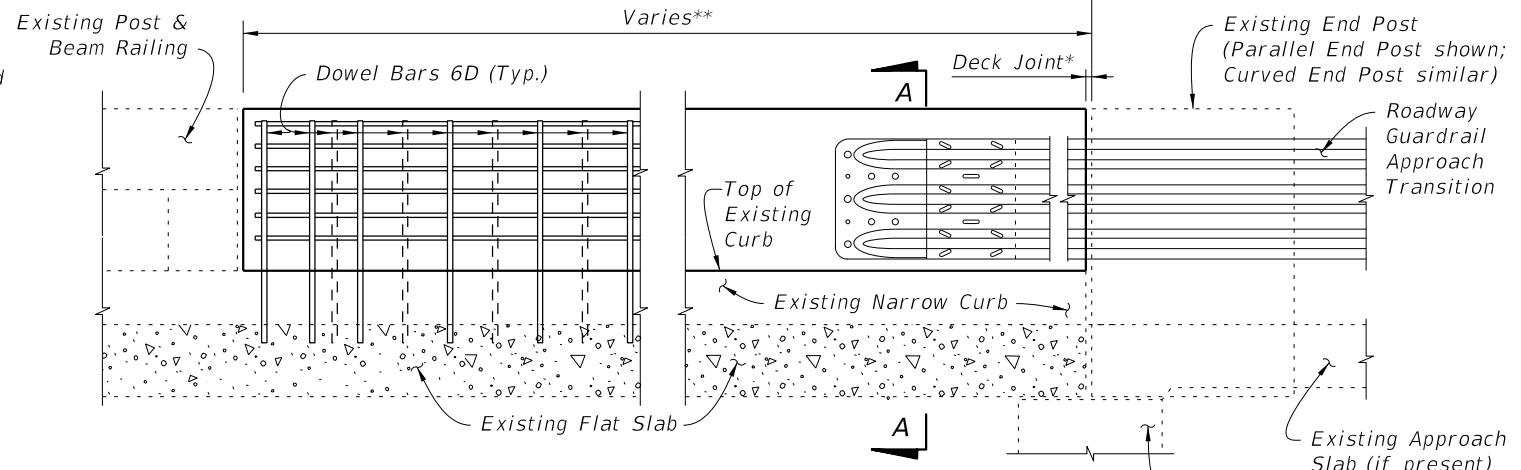

PARTIAL ELEVATION OF INSIDE FACE OF RAILING

SCHEME 1 - APPROACH ENDS OF BRIDGES WITH BEAM OR GIRDER SUPERSTRUCTURE

SCHEME 2 - APPROACH ENDS OF BRIDGES WITH FLAT SLAB SUPERSTRUCTURE & PARALLEL WINGWALLS (SHOWN) OR BEAM OR GIRDER SUPERSTRUCTURE & PARALLEL OR CURVED WINGWALLS (SIMILAR)

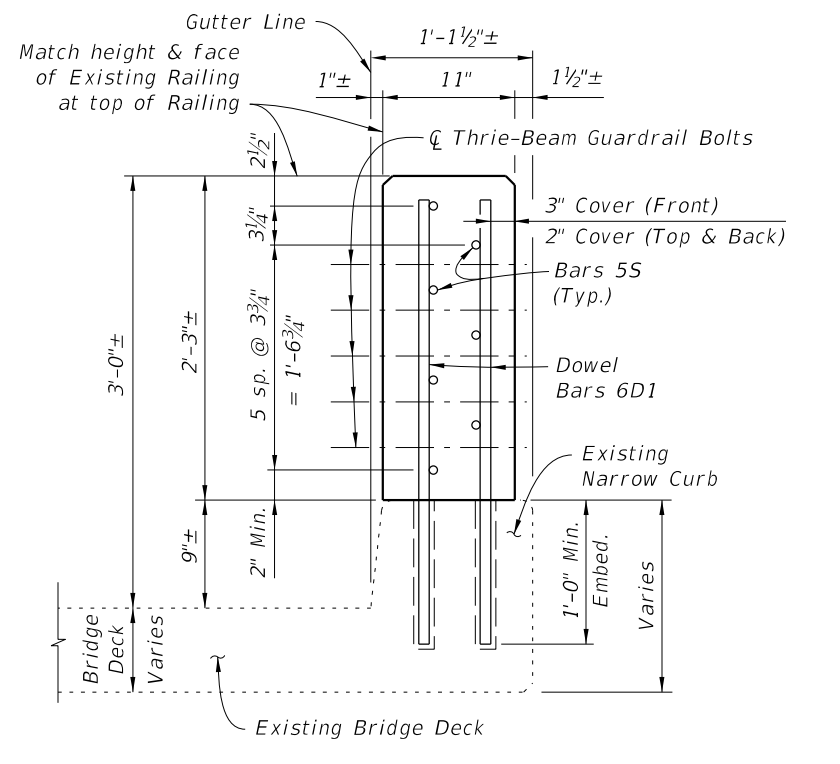

SECTION A-A

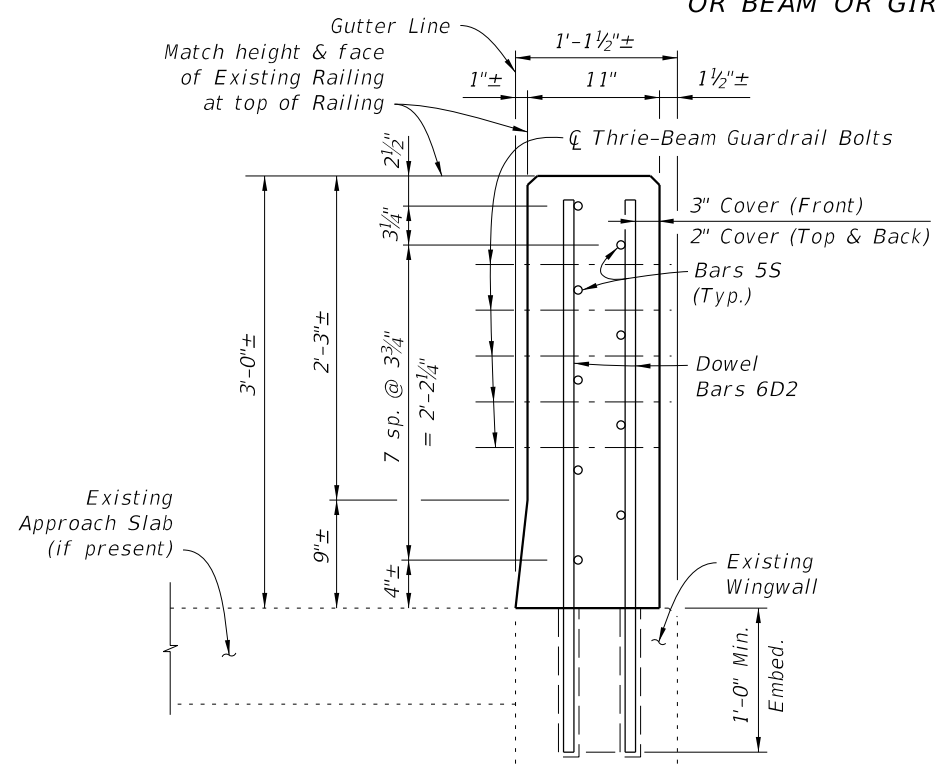

SECTION B-B

VERTICAL FACE RETROFIT RAILING DETAILS - POST & BEAM RAILING WITH NARROW CURB

ESTIMATED TRAFFIC RAILING QUANTITIES		
ITEM	UNIT	QUANTITY
Concrete	CY/FT	0.076
Reinforcing Steel	LB/FT	14.71

CONVENTIONAL REINFORCING STEEL BENDING DIAGRAM			
BILL OF REINFORCING STEEL			
MARK	SIZE	LENGTH	
D1	6	3'-1"	Bars 6D1
D2	6	3'-10"	Bars 6D2
S	5	AS REQD.	Bars 5S

BARS 6D & 5S

- REINFORCING STEEL NOTES:**
1. All bar dimensions in the bending diagrams are out to out.
 2. The reinforcement for the railing on a retaining wall shall be the same as detailed for a bridge deck.
 3. All reinforcing steel in the Vertical Face Retrofit Railing shall have a 2" minimum cover.

10/24/2016 9:17:03 AM

LAST REVISION	DESCRIPTION:
07/01/13	

FDOT FY 2017-18 DESIGN STANDARDS

GUARDRAIL TRANSITIONS-EXISTING POST & BEAM BRIDGE RAILINGS (NARROW & RECESSED CURBS)

INDEX NO. **404** SHEET NO. **3 of 8**

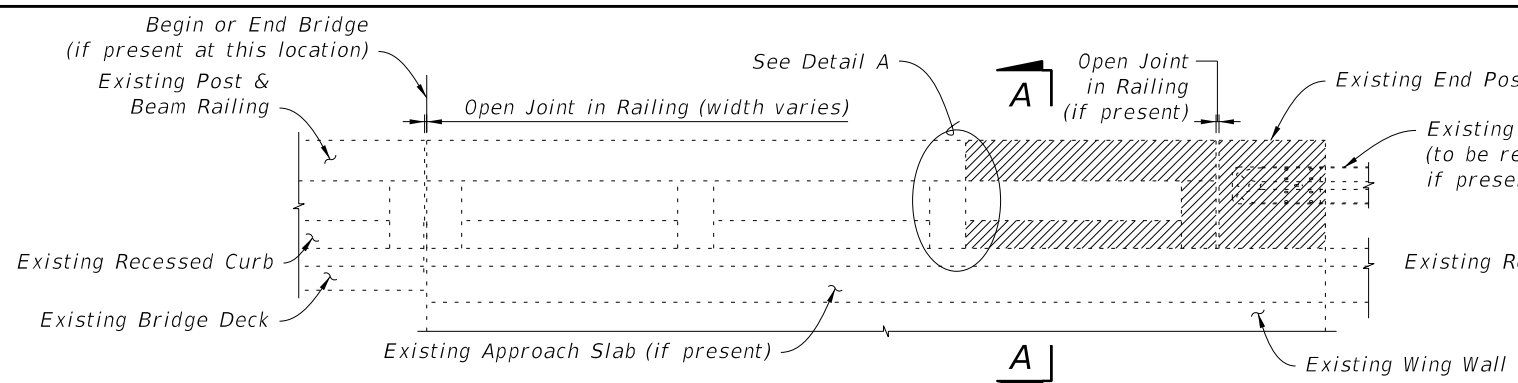

3 OR MORE CONTINUOUS RAILING PANELS ON WINGWALL ADJACENT TO END POST

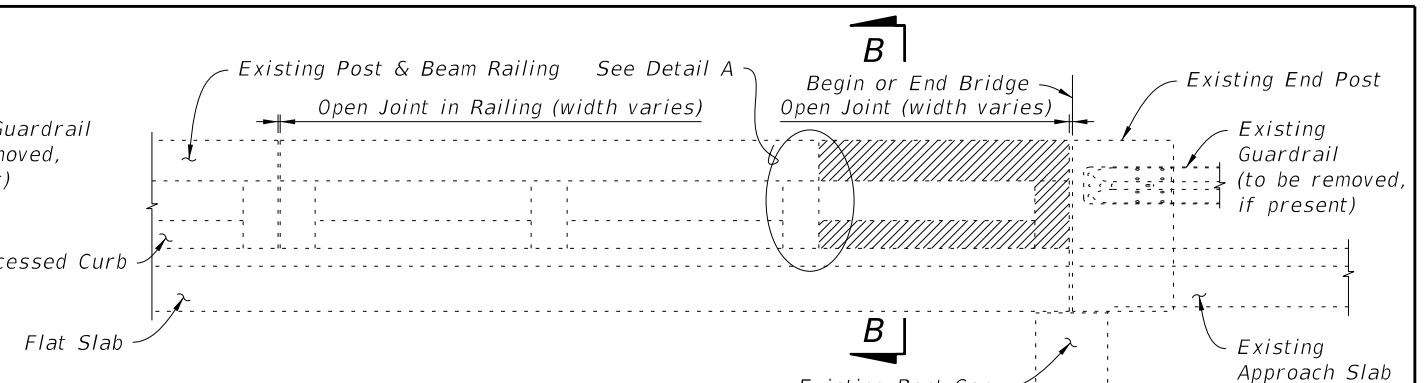

3 OR MORE CONTINUOUS RAILING PANELS ADJACENT TO BEGIN OR END BRIDGE

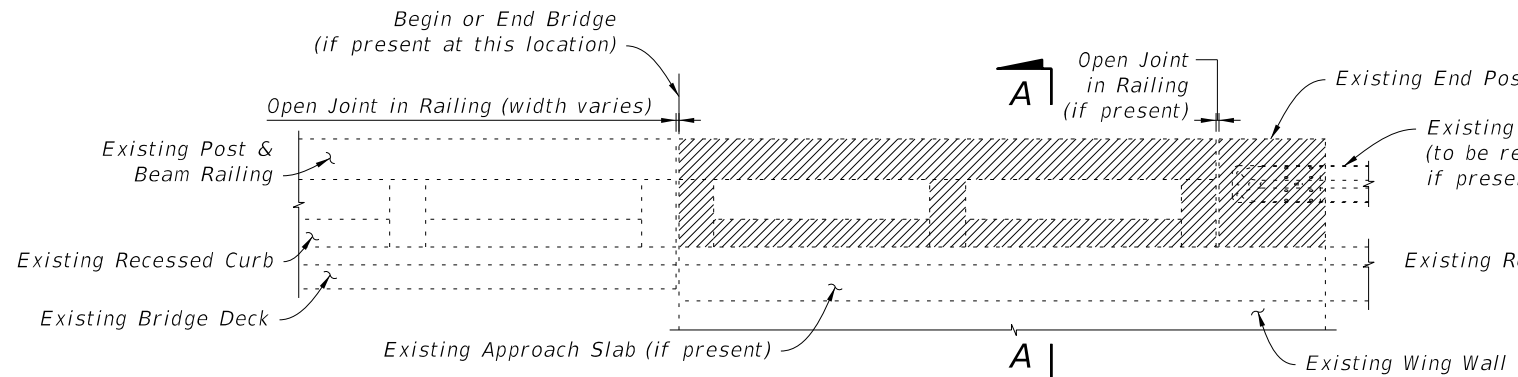

2 CONTINUOUS RAILING PANELS ON WINGWALL ADJACENT TO END POST

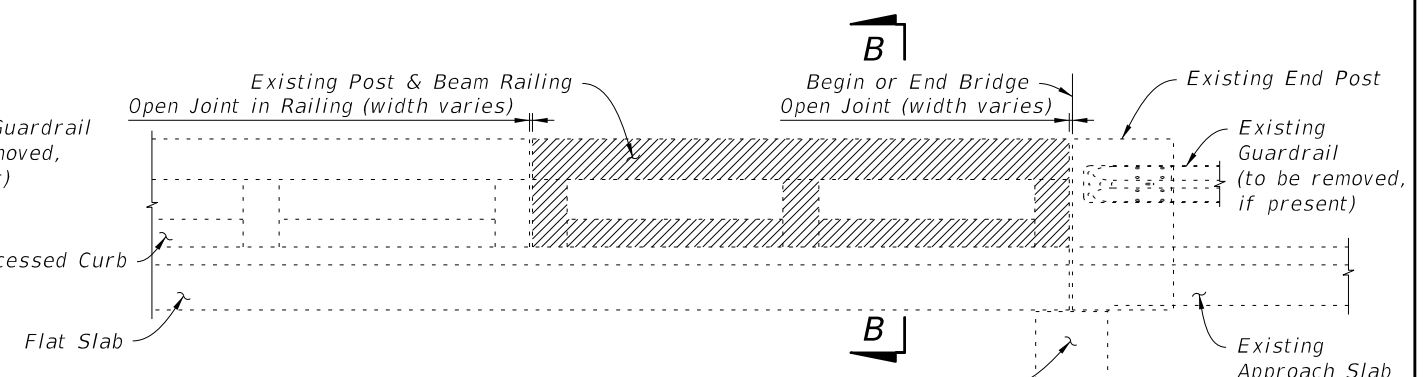

2 CONTINUOUS RAILING PANELS ADJACENT TO BEGIN OR END BRIDGE

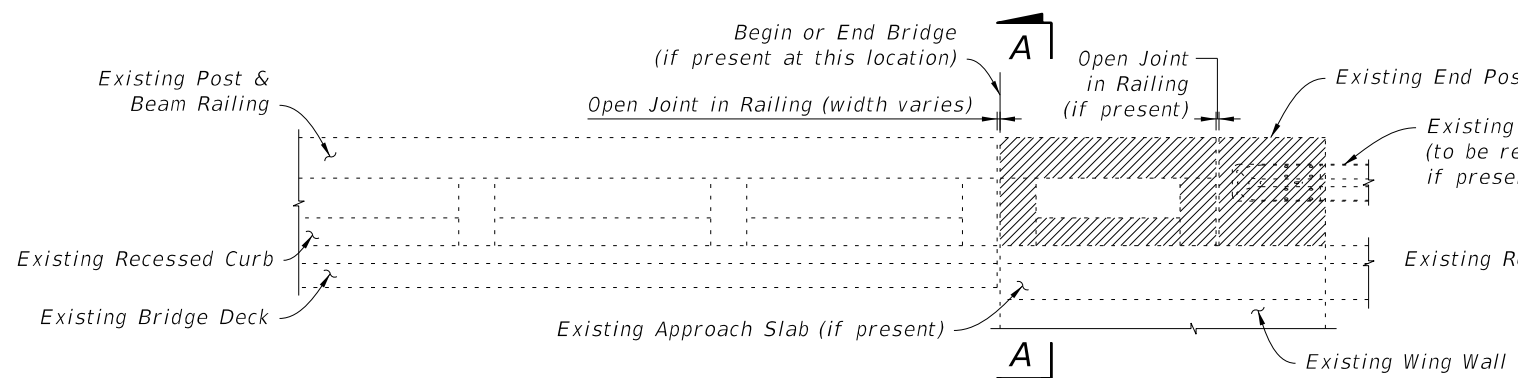

1 RAILING PANEL ON WINGWALL ADJACENT TO END POST

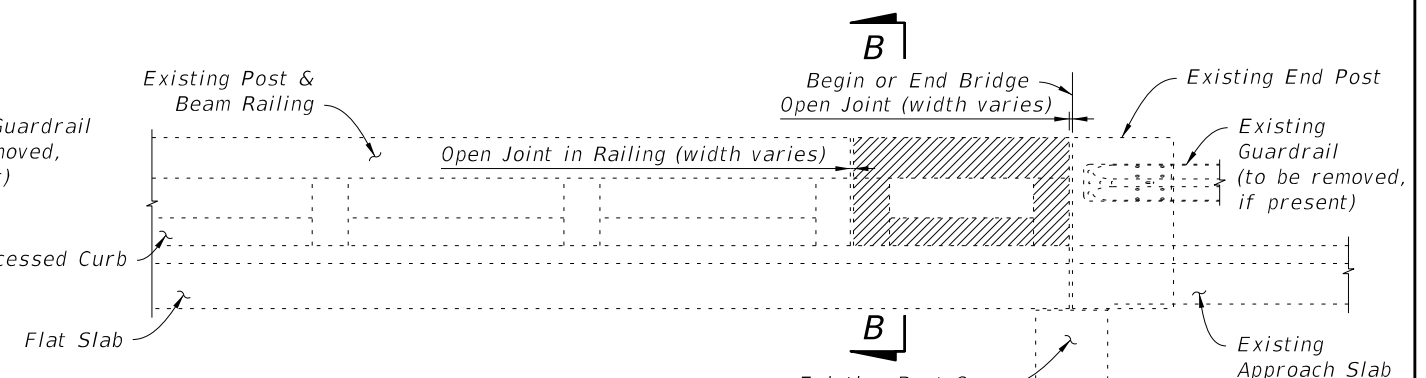

1 RAILING PANEL ADJACENT TO BEGIN OR END BRIDGE

SCHEME 3 - APPROACH ENDS OF BRIDGES WITH BEAM OR GIRDER SUPERSTRUCTURE

SCHEME 4 - APPROACH ENDS OF BRIDGES WITH FLAT SLAB SUPERSTRUCTURE & PARALLEL WINGWALLS (SHOWN) OR BEAM OR GIRDER SUPERSTRUCTURE & PARALLEL OR CURVED WINGWALLS (SIMILAR)

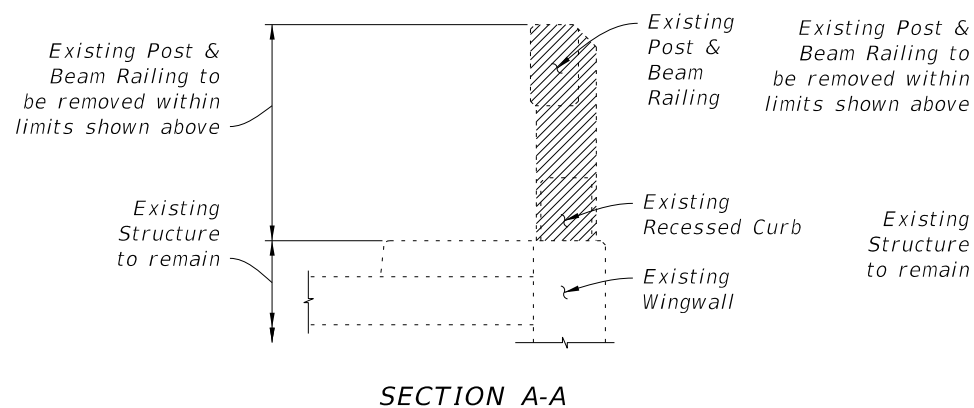

SECTION A-A

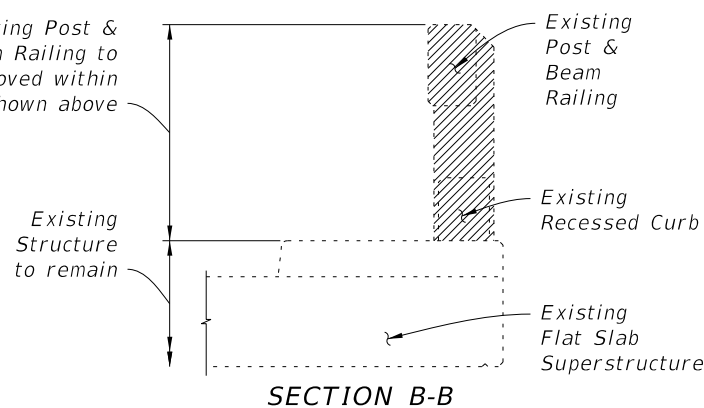

SECTION B-B

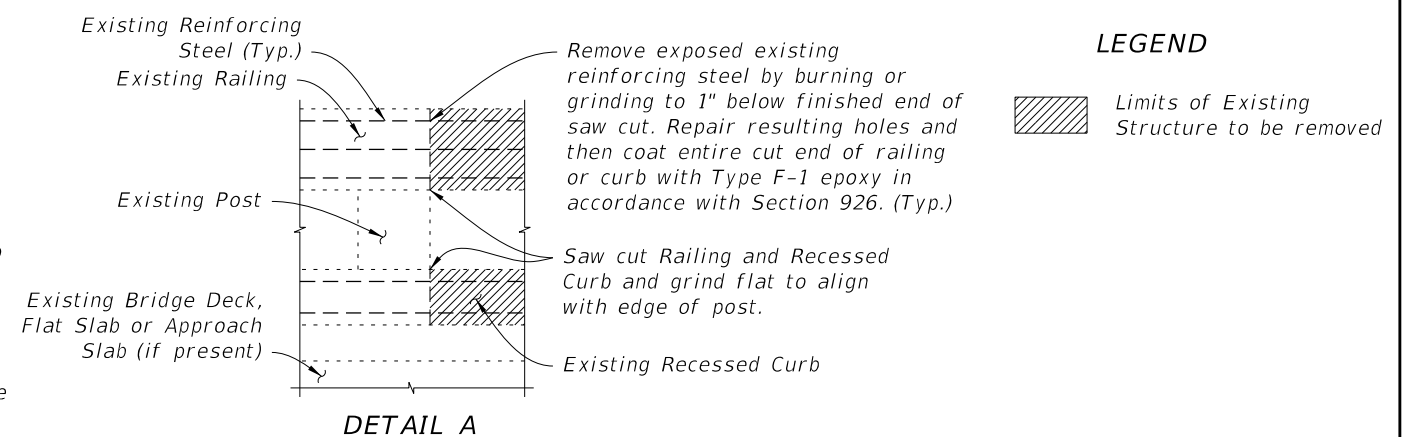

DETAIL A

LEGEND

Limits of Existing Structure to be removed

Remove exposed existing reinforcing steel by burning or grinding to 1" below finished end of saw cut. Repair resulting holes and then coat entire cut end of railing or curb with Type F-1 epoxy in accordance with Section 926. (Typ.)

Saw cut Railing and Recessed Curb and grind flat to align with edge of post.

LIMITS OF REMOVAL OF EXISTING STRUCTURE - POST & BEAM RAILING WITH RECESSED CURB

LAST REVISION 07/01/13	REVISION	DESCRIPTION:
---------------------------	----------	--------------

10/24/2016 9:17:06 AM

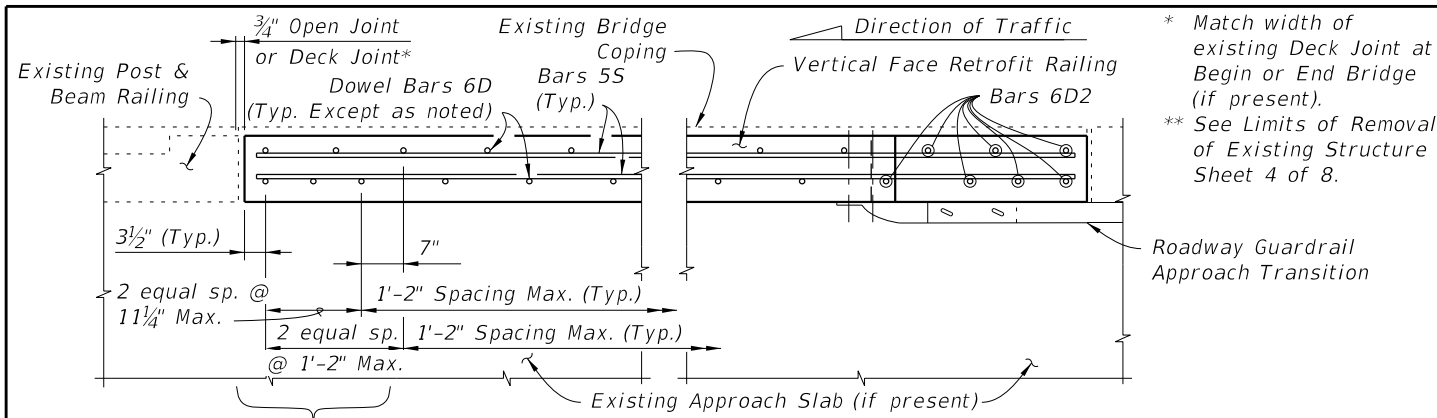

PARTIAL PLAN OF RAILING

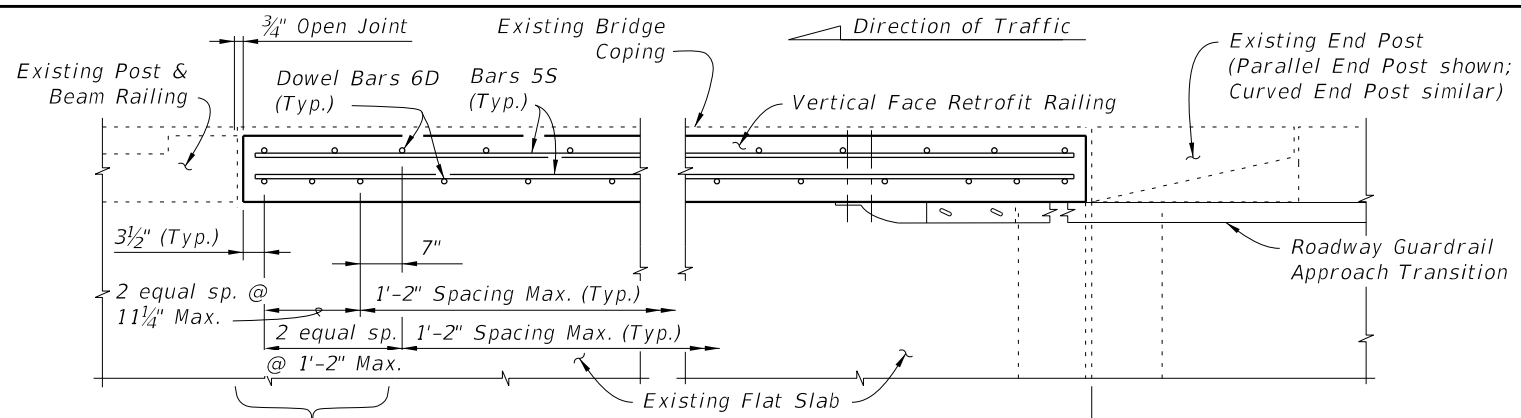

PARTIAL PLAN OF RAILING

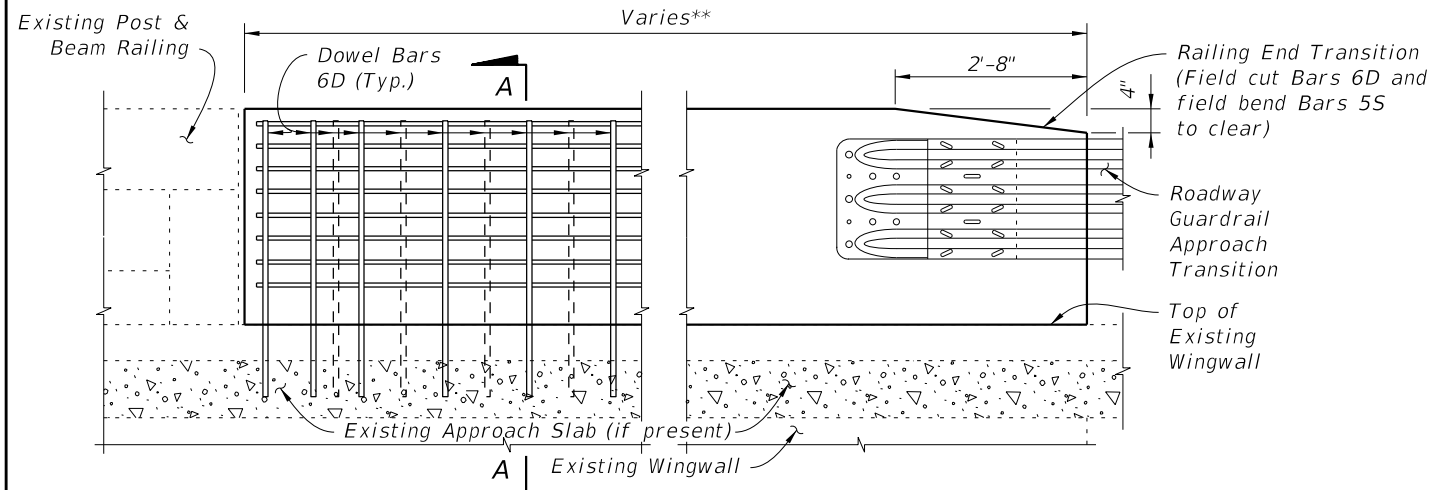

PARTIAL ELEVATION OF INSIDE FACE OF RAILING

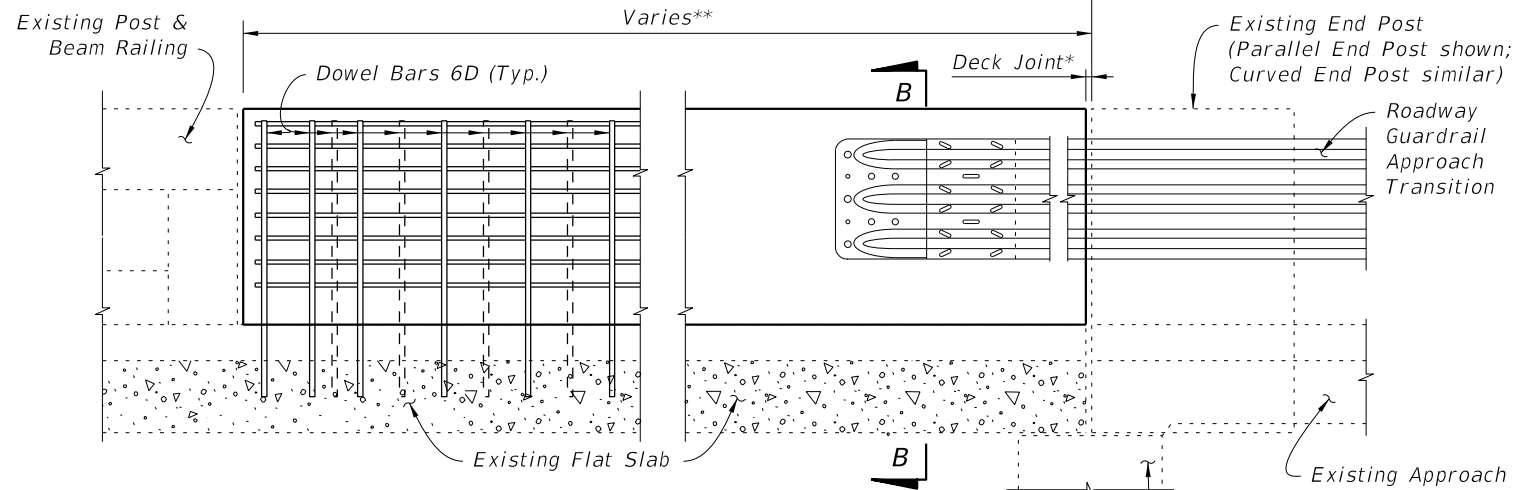

PARTIAL ELEVATION OF INSIDE FACE OF RAILING

SCHEME 4 - APPROACH ENDS OF BRIDGES WITH FLAT SLAB SUPERSTRUCTURE & PARALLEL WINGWALLS (SHOWN) OR BEAM OR GIRDER SUPERSTRUCTURE & PARALLEL OR CURVED WINGWALLS (SIMILAR)

SCHEME 3 - APPROACH ENDS OF BRIDGES WITH BEAM OR GIRDER SUPERSTRUCTURE

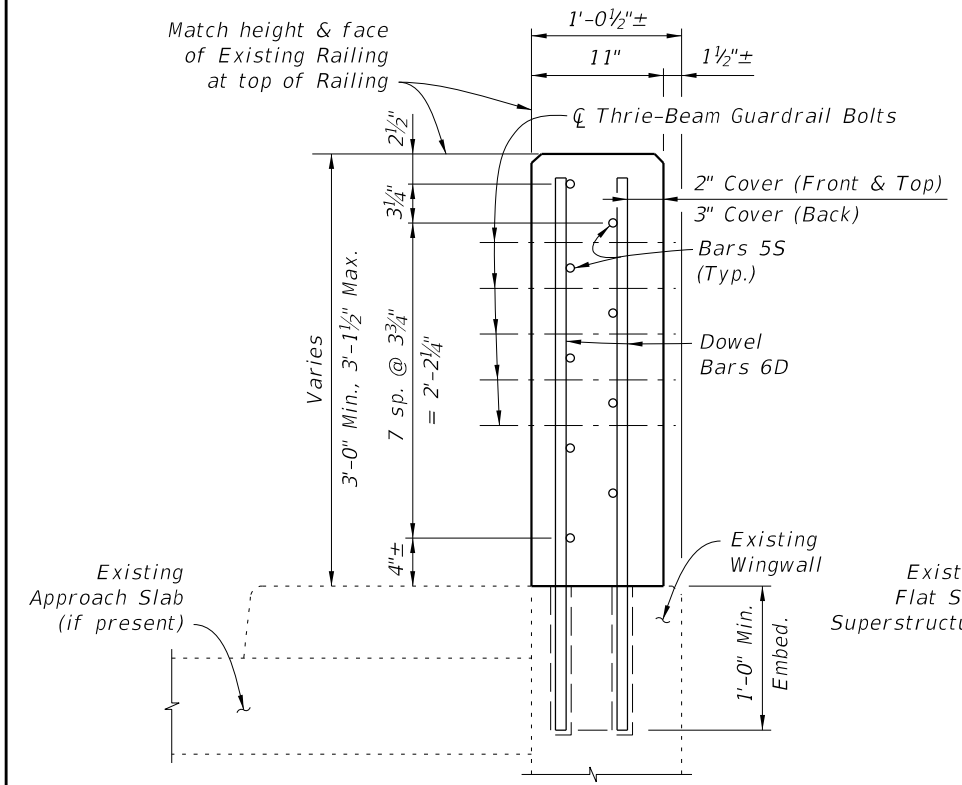

SECTION A-A

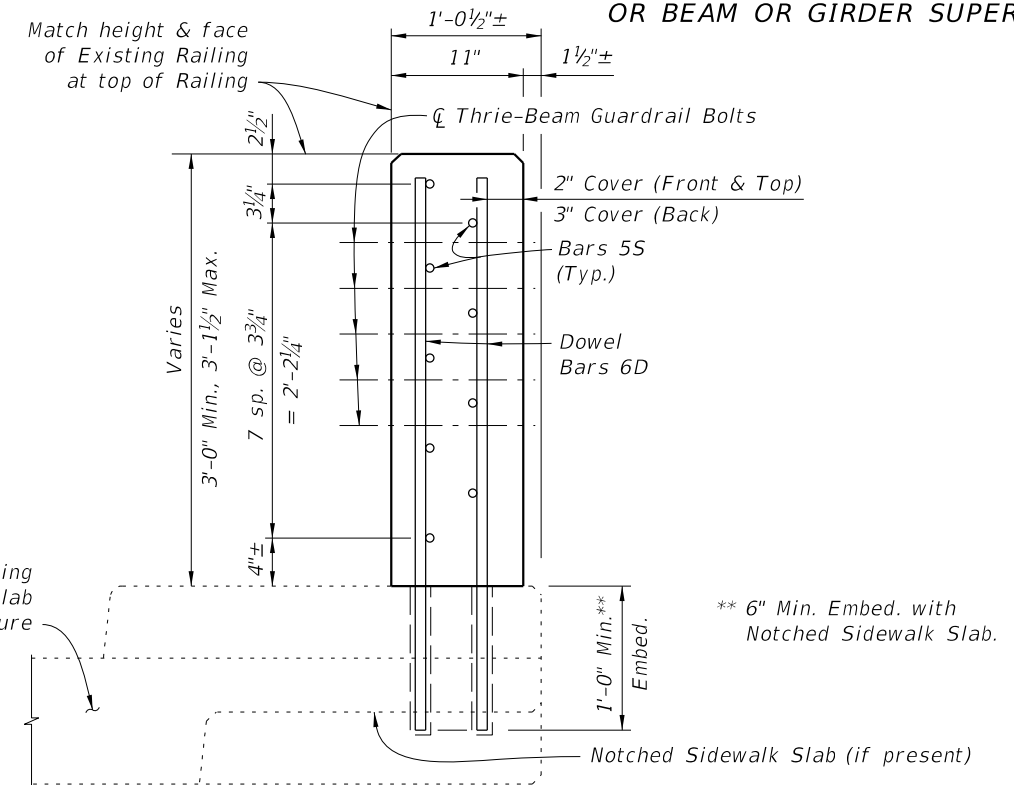

SECTION B-B

VERTICAL FACE RETROFIT RAILING DETAILS - POST & BEAM RAILING WITH RECESSED CURB

ESTIMATED TRAFFIC RAILING QUANTITIES		
ITEM	UNIT	QUANTITY
Concrete	CY/FT	0.102
Reinforcing Steel	LB/FT	17.97

CONVENTIONAL REINFORCING STEEL BENDING DIAGRAM			
BILL OF REINFORCING STEEL			
MARK	SIZE	LENGTH	
D	6	3'-4"	BARS 6D & 5S
S	5	AS REQD.	

- REINFORCING STEEL NOTES:**
1. All bar dimensions in the bending diagrams are out to out.
 2. The reinforcement for the railing on a retaining wall shall be the same as detailed for a bridge deck.
 3. All reinforcing steel in the Vertical Face Retrofit Railing shall have a 2" minimum cover.

10/24/2016 9:17:09 AM

LAST REVISION	DESCRIPTION:
07/01/13	

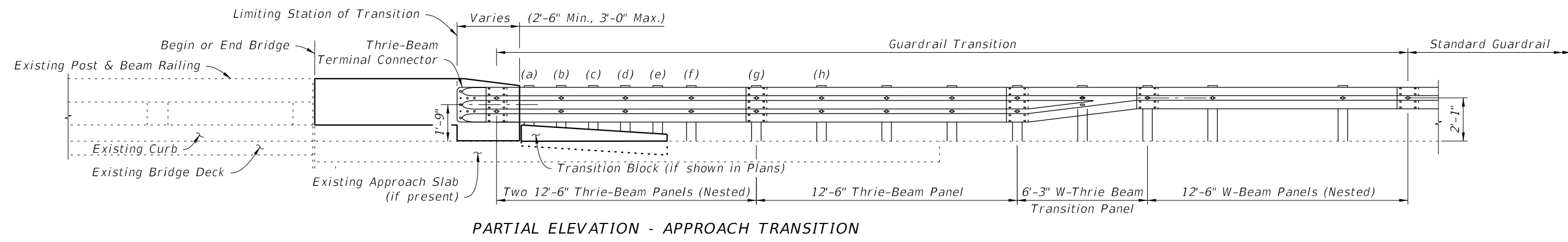
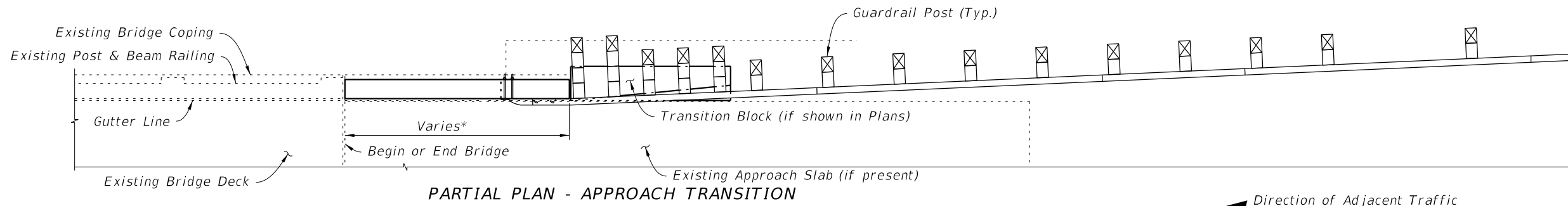

SCHMES 1 & 3
(Narrow Curb Shown, Recessed Curb Similar)

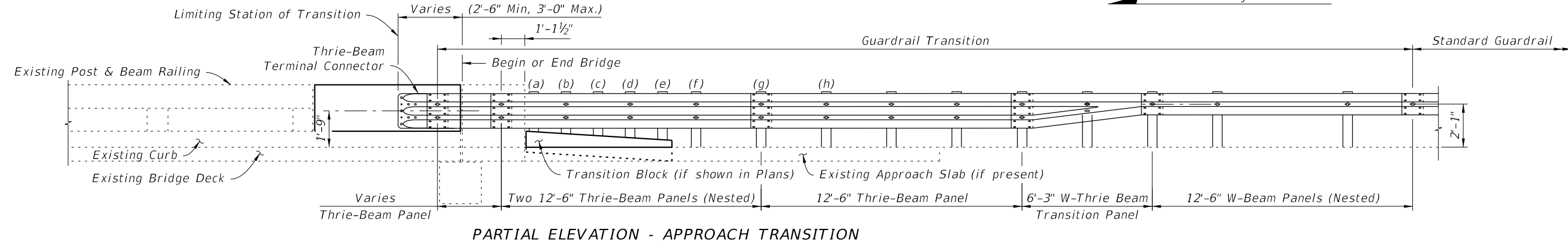
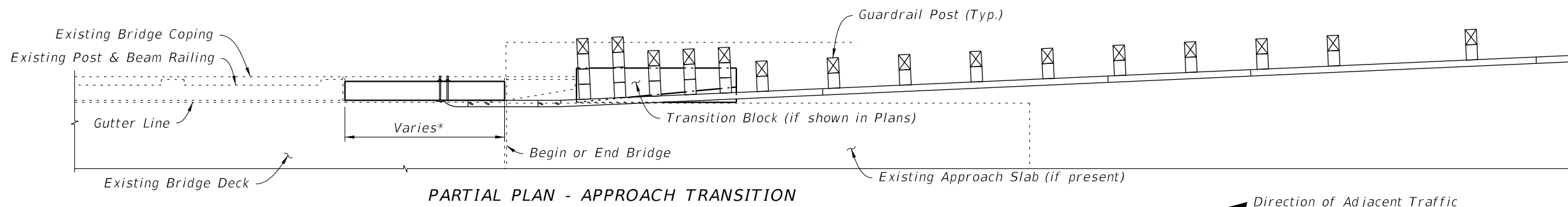

SCHMES 2 & 4
(Narrow Curb Shown, Recessed Curb Similar, Flat Slab Superstructure Shown, Beam or Girder Superstructure Similar)

* See Limits of Removal of Existing Structure, Sheets 2 of 8 and 4 of 8.

10/24/2016 9:17:12 AM

LAST REVISION 07/01/14	REVISION	DESCRIPTION:	 FY 2017-18 DESIGN STANDARDS	GUARDRAIL TRANSITIONS-EXISTING POST & BEAM BRIDGE RAILINGS (NARROW & RECESSED CURBS)	INDEX NO. 404	SHEET NO. 6 of 8
---------------------------	----------	--------------	---	---	-------------------------	----------------------------

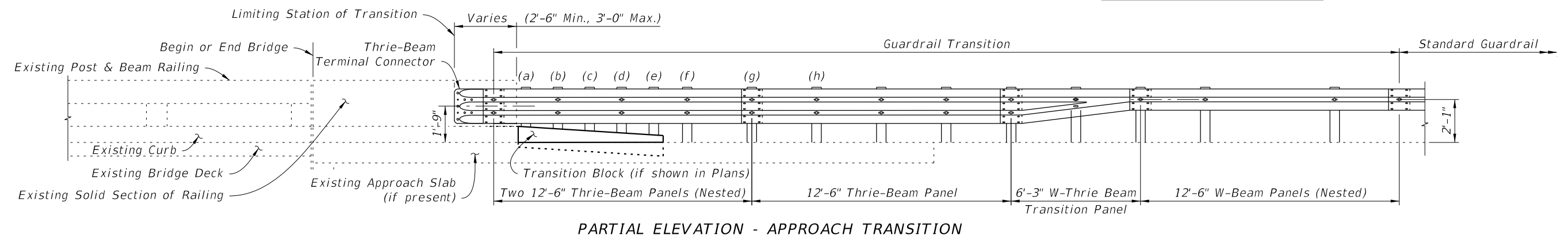
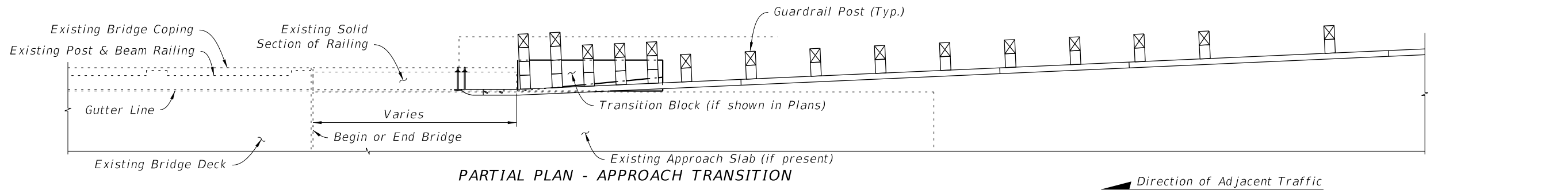

PARTIAL ELEVATION - APPROACH TRANSITION

SCHEME 5

(Narrow Curb shown; Recessed Curb similar)

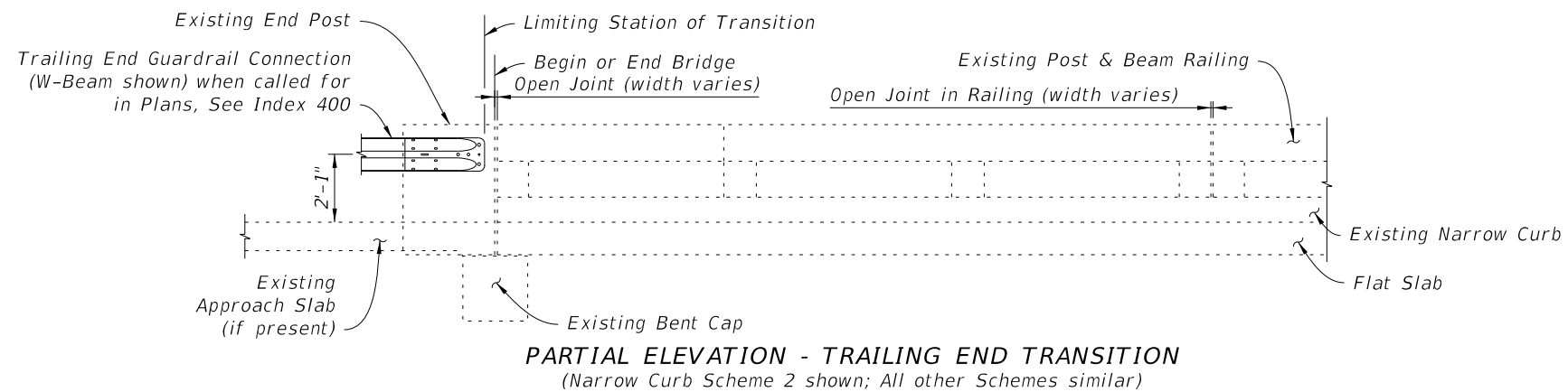

PARTIAL ELEVATION - TRAILING END TRANSITION

(Narrow Curb Scheme 2 shown; All other Schemes similar)

SCHEME 6

10/24/2016 9:17:15 AM

LAST REVISION 07/01/14	REVISION	DESCRIPTION:
---------------------------	----------	--------------

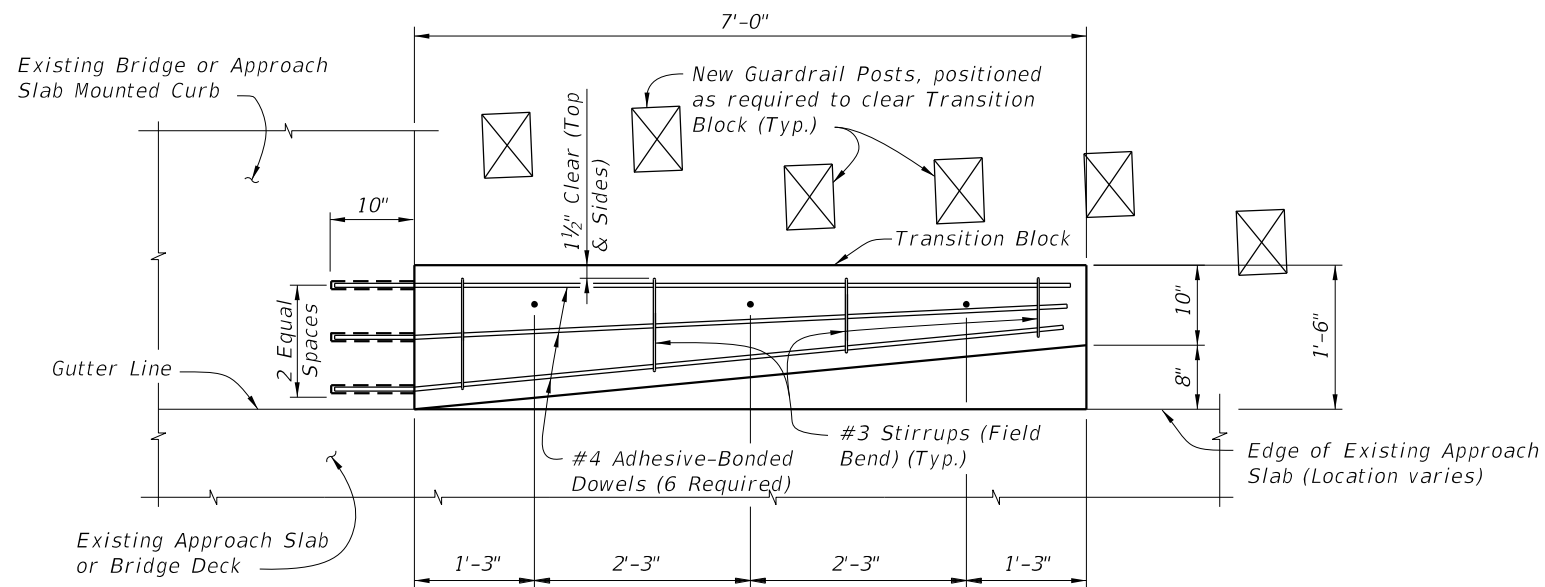

PLAN VIEW OF TRANSITION BLOCK
(GUARDRAIL NOT SHOWN FOR CLARITY)

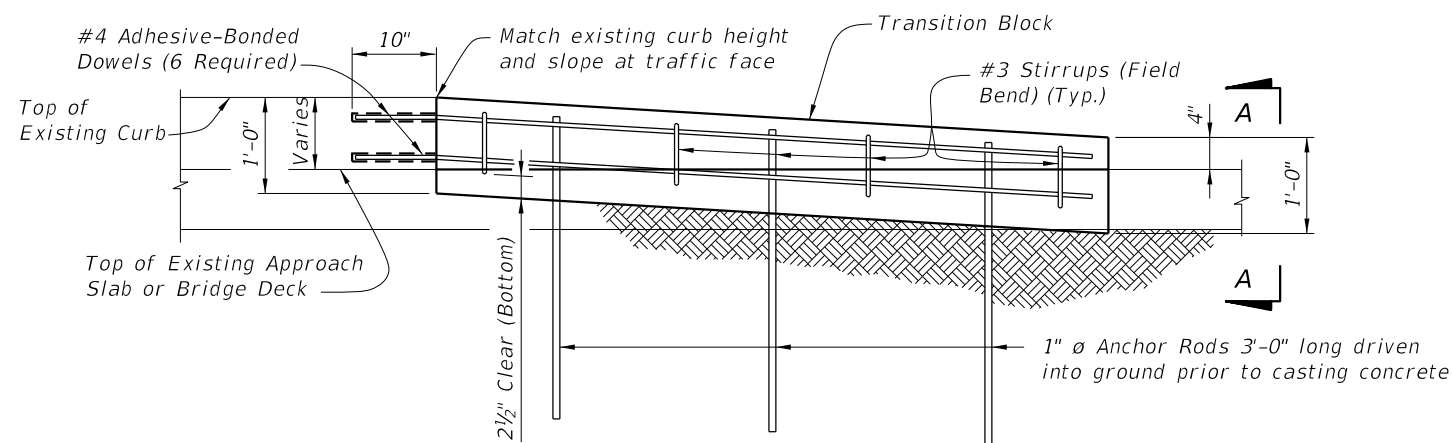

ELEVATION OF TRANSITION BLOCK
(GUARDRAIL AND POSTS NOT SHOWN FOR CLARITY)

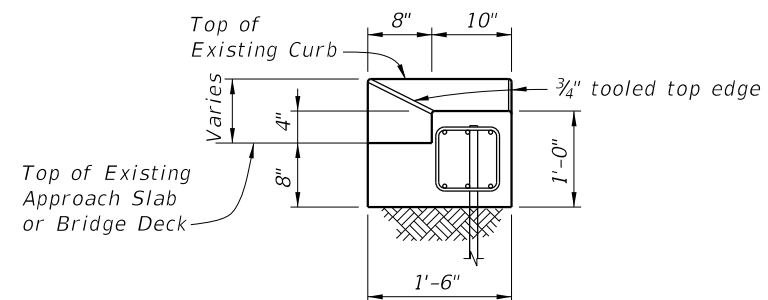

END VIEW A-A

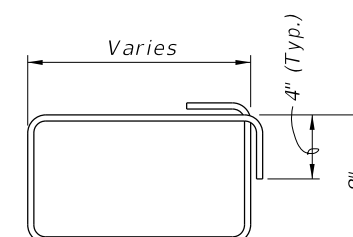

#3 STIRRUP (FIELD BEND)

NOTES:

ANCHOR RODS: Steel Anchor Rods shall be ASTM A36, ASTM A709 Grade 36 or ASTM A615 Grade 60 hot-dip galvanized in accordance with Specification Section 962.

ADHESIVE-BONDED DOWELS: Adhesive Bonded Dowels are shown installed in an existing curb or sidewalk integrally reinforced with Approach Slab, Wingwall or Bridge Deck. For installations in existing detached curbs or sidewalks, install dowels in available sound concrete.

Shift bars (as needed) to install six dowels into existing bridge or approach slab mounted curb.

ESTIMATED QUANTITIES PER TRANSITION BLOCK		
ITEM	UNIT	QUANTITY
Concrete Class II (Bridge Deck)	CY	0.4
Reinforcing Steel	LB	61

10/24/2016 9:17:17 AM

LAST REVISION 07/01/13	DESCRIPTION:
---------------------------	--------------

FDOT
FY 2017-18
DESIGN STANDARDS

GUARDRAIL TRANSITIONS-EXISTING POST & BEAM
BRIDGE RAILINGS (NARROW & RECESSED CURBS)

INDEX NO.
404

SHEET NO.
8 of 8