

**PLAN**  
(Rails, Posts and Reinforcing Steel not shown for clarity)

| BARRIER DELINEATOR SPACING                        |               |
|---|---------------|
| Distance - Edge of Travel Lane to Face of Railing | Spacing (Ft.) |
| < 4'  | 40'           |
| 4' to 8'  | 80'           |
| > than 8'   | None Required |

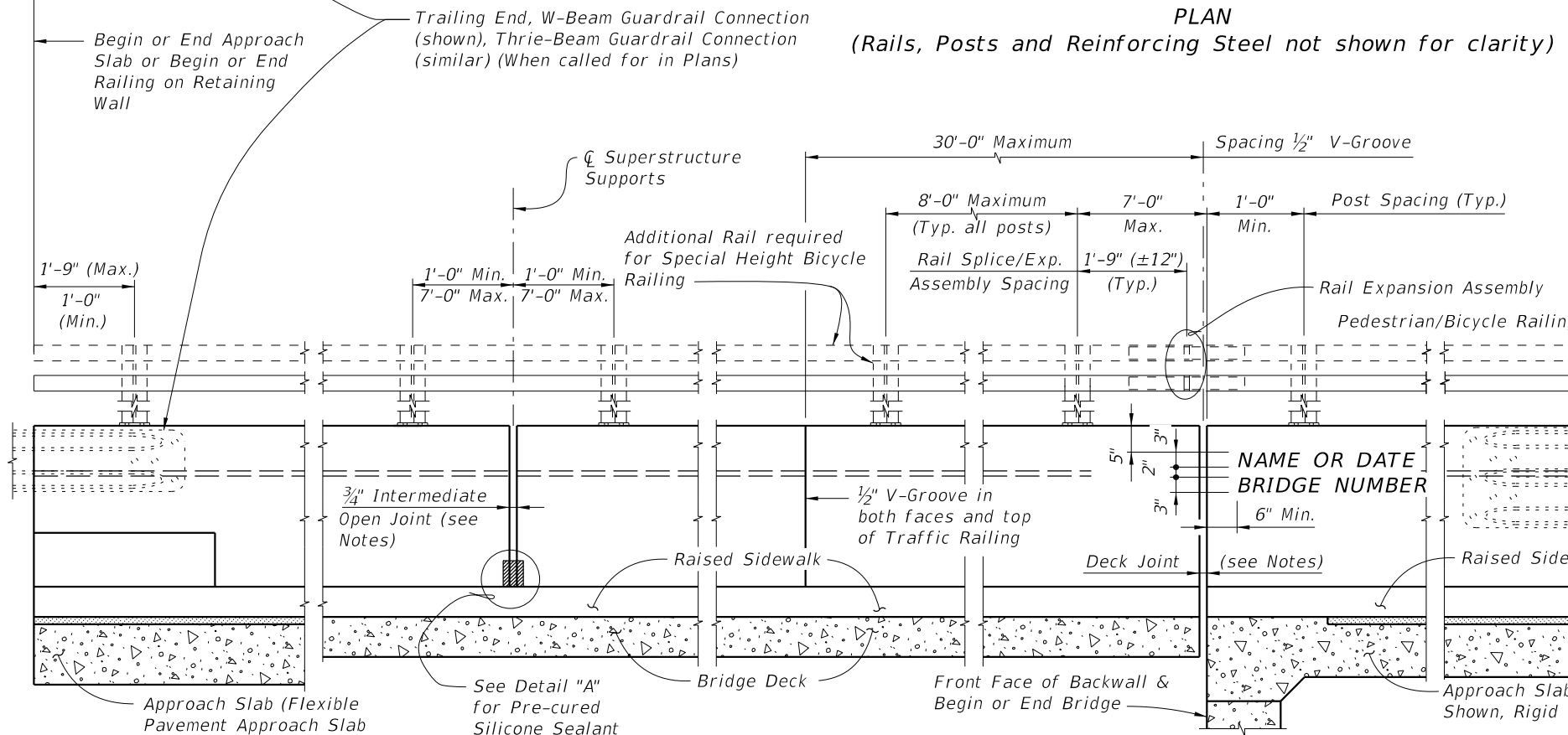

**ELEVATION OF INSIDE FACE OF RAILING**  
(Reinforcing Steel not shown for clarity)

**TRAFFIC RAILING NOTES**

This railing has been structurally evaluated to be equivalent or greater in strength to other safety shape railings which have been crash tested to NCHRP Report 350 TL-4 Criteria.

- CONCRETE AND REINFORCING STEEL :** See Structures Plans, General Notes.
- GUARDRAIL :** For Guardrail connection details, see Index 400.
- PEDESTRIAN/BICYCLE RAILING AND SPECIAL HEIGHT BICYCLE RAILING DETAILS :** See Index 822 for Post, Rail and Rail Splice/Expansion Assembly fabrication and installation Details and Notes.
- V-GROOVES :** Construct 1/2" V-Grooves plumb. Space V-Grooves equally between 3/4" Open Joints and/or Deck Joints and at V-Groove locations on Retaining Wall footings.
- BARRIER DELINEATORS:** Barrier Delineators shall meet Specification Section 993. Install Barrier Delineators on top of the Traffic Railing 2" from the face on the traffic side at the spacing shown in the table above. Barrier Delineator color (white or yellow) shall match the color of the near edgeline. The cost of the Barrier Delineators shall be included in the Contract Unit Price for the Traffic Railing.

- RAILINGS ON RETAINING WALLS :** If the Traffic Railing is to be provided on a retaining wall, the railing section will be the same as shown on Sheet 2. All other details such as the guardrail transition attachment, the maximum spacing of the 3/4" open joints and 1/2" V-Groove shall apply.
- NAME, DATE, AND BRIDGE NUMBER :** The Name and Bridge Number shall be placed on the Traffic Railing so as to be seen on the driver's right side when approaching the bridge. The Date shall be placed on the driver's left side when approaching the bridge. The Name shall be as shown in the General Notes of the Structures Plans. The Date shall be the year the bridge is completed. For a widening when the existing railing is removed, use both the existing date and the year of the widening. Black plastic letters and figures 3" in height may be used, as approved by the Engineer, in lieu of the letters and figures formed by 3/8" V-Grooves. V-Grooves shall be formed by preformed letters and figures.
- OPEN JOINTS :** See Structures Plans, Superstructure, Approach Slab Sheets and Retaining Walls for actual dimensions and joint orientation. Provide open Traffic Railing Joints at Deck Expansion Joint locations matching the dimensions of the Deck Joint. For treatment of Railings on skewed bridges see Index 420. Provide 3/4" Intermediate Open Joints at :
  - (1) - Superstructure supports where slab is continuous.
  - (2) - Ends of approach slabs when adjacent to retaining walls and at expansion joints on retaining wall junction slabs.

**CROSS REFERENCE:**  
For Section A-A and View B-B, see Sheet 2.  
For Detail "A" see Sheet 3.

12/17/2015 11:16:31 AM

|                           |              |  |   |                         |                            |
|---------------------------|--------------|--|---|-------------------------|----------------------------|
| LAST REVISION<br>07/01/15 | DESCRIPTION: | <br><b>FY 2016-17</b><br><b>DESIGN STANDARDS</b> | <b>TRAFFIC RAILING - (32" VERTICAL SHAPE)</b> | INDEX NO.<br><b>423</b> | SHEET NO.<br><b>1 of 3</b> |
|---------------------------|--------------|--|---|-------------------------|----------------------------|

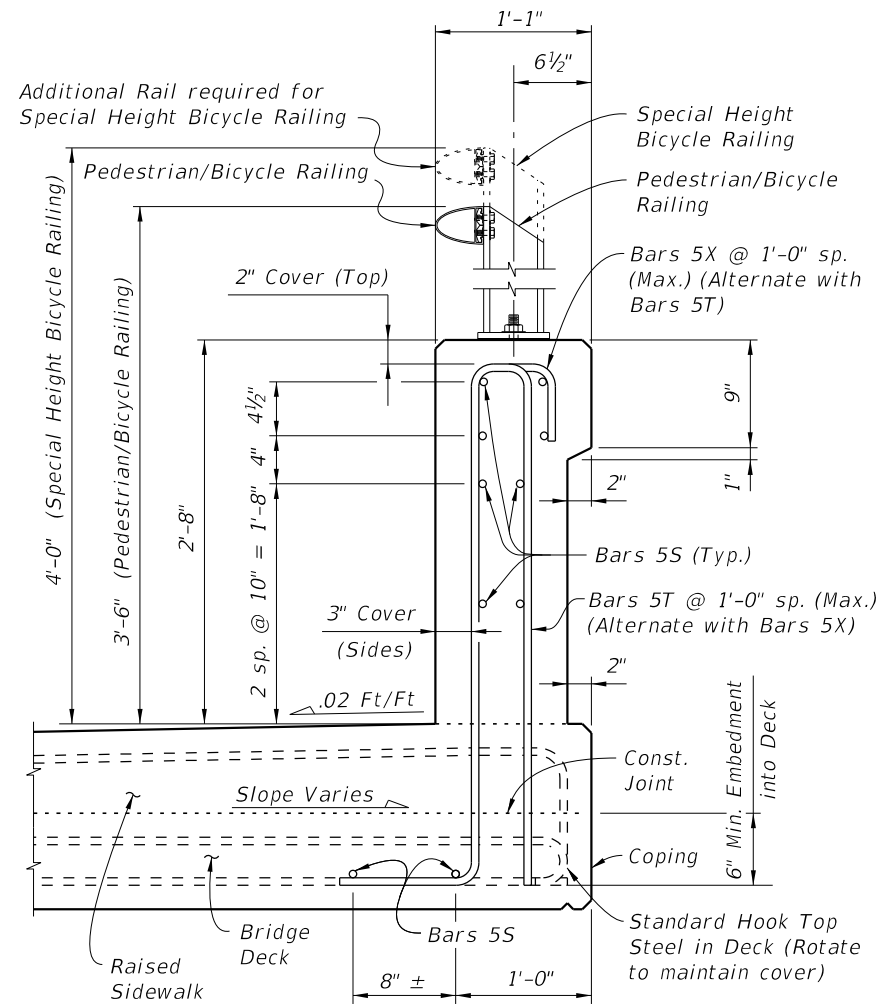

SECTION A-A  
TYPICAL SECTION THRU TRAFFIC RAILING  
SECTION THRU BRIDGE DECK SHOWN

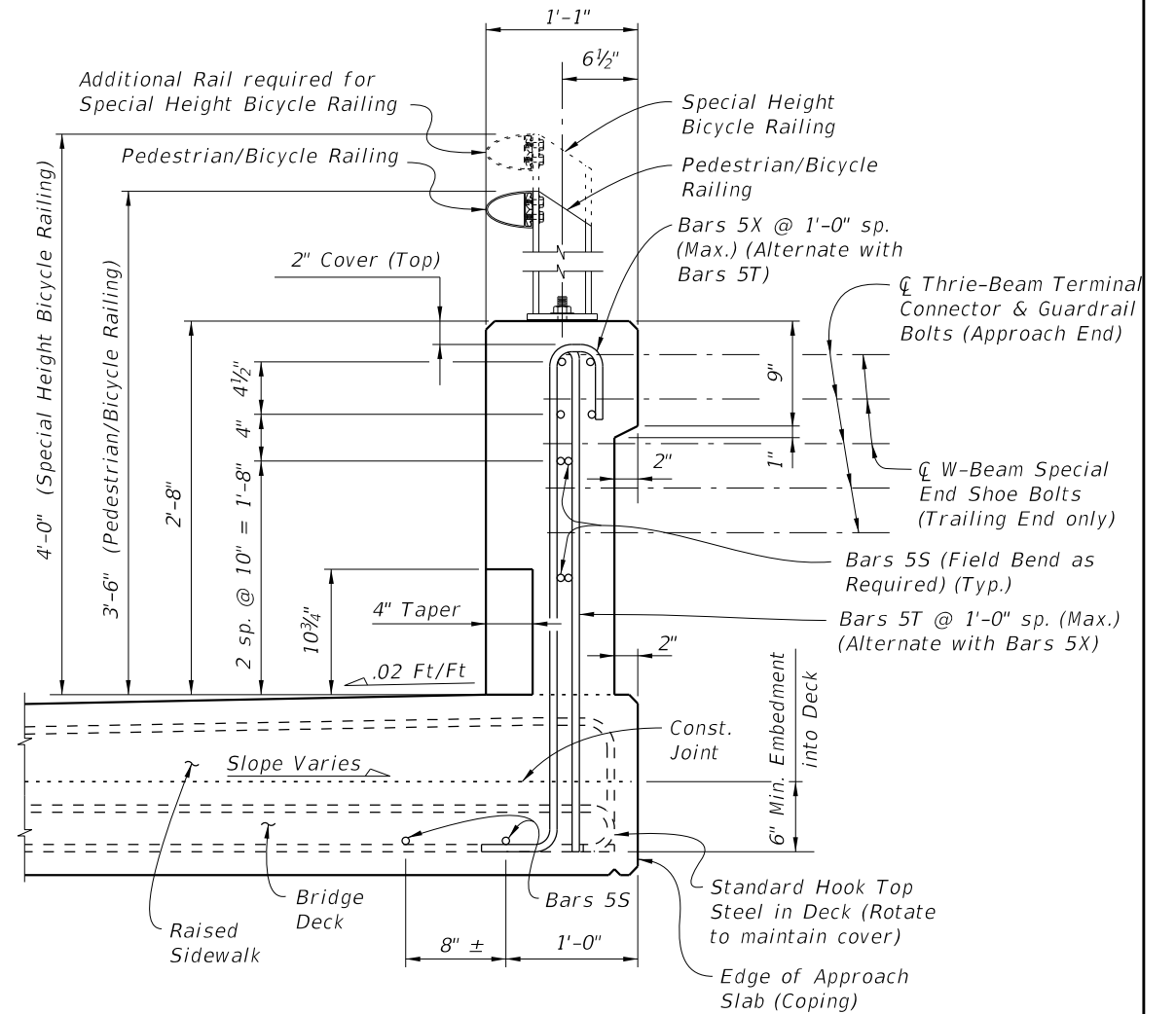

VIEW B-B  
APPROACH SLAB END VIEW  
OF TRAFFIC RAILING

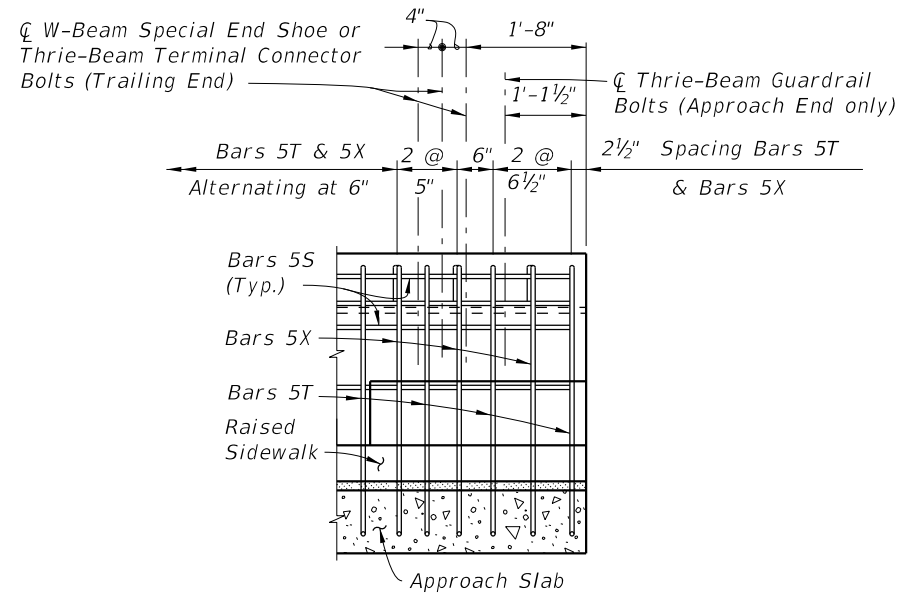

RAILING END DETAIL

CROSS REFERENCE:  
For location of Section A-A and View B-B  
see Sheet 1.

NOTE: For Post "B", Post "C" and Rail Details,  
see Index No. 822.

NOTES:  
Omit Railing End Taper and Guardrail if Concrete Barrier Wall is used beyond the Approach Slab. See Structures Plans, Plan and Elevation Sheet and Roadway Plans. If Railing End Taper is omitted, extend Typical Section to the end of the Approach Slab. Begin placing Railing Bars 5T and 5X on Approach Slab at the railing end and proceed toward Begin or End Bridge to ensure placement of guardrail bolt holes. If required, adjustments to the bar spacing for Bars 5T and 5X shall be made immediately adjacent to Begin or End Bridge. Shift and rotate Bars 5T and 5X on Approach Slab in end taper section as required to maintain cover.

12/17/2015 11:16:32 AM

|                           |          |              |  |  |                  |                     |
|---------------------------|----------|--------------|--|--|------------------|---------------------|
| LAST REVISION<br>07/01/15 | REVISION | DESCRIPTION: |  FY 2016-17<br>DESIGN STANDARDS | TRAFFIC RAILING - (32" VERTICAL SHAPE) | INDEX NO.<br>423 | SHEET NO.<br>2 of 3 |
|---------------------------|----------|--------------|--|--|------------------|---------------------|

CONVENTIONAL REINFORCING STEEL BENDING DIAGRAMS

| BILL OF REINFORCING STEEL |      |           |
|---------------------------|------|-----------|
| MARK                      | SIZE | LENGTH    |
| S                         | 5    | As Req'd. |
| T                         | 5    | 9'-0"     |
| X                         | 5    | 5'-10"    |

| ROADWAY CROSS-SLOPE | ØA         |             |
|---------------------|------------|-------------|
|                     | LOW GUTTER | HIGH GUTTER |
| 0% to 2%            | 90°        | 90°         |
| 2% to 6%            | 87°        | 93°         |
| 6% to 10%           | 84°        | 96°         |

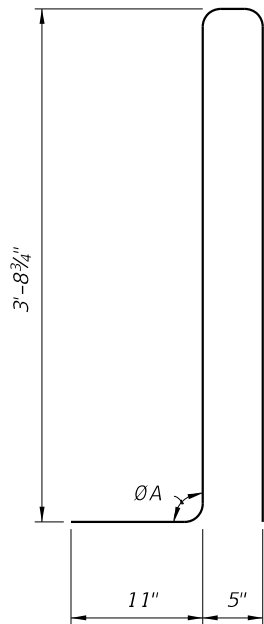

STIRRUP BAR 5T

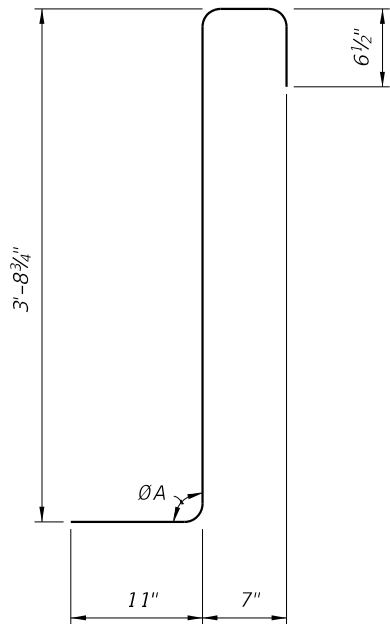

STIRRUP BAR 5X

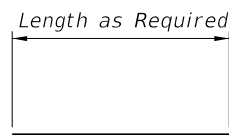

BAR 5S

REINFORCING STEEL NOTES:

1. All bar dimensions in the bending diagrams are out to out.
2. The 3'-8 3/4" vertical dimensions shown for Bars 5T and 5X are based on a bridge deck with a 6" thick x 6' wide raised sidewalk at low side of deck, 2% deck cross slope and a counter 2% raised sidewalk cross slope. If the raised sidewalk thickness, width or cross slopes vary from the above amounts, adjust these vertical dimensions accordingly to achieve a 6" minimum embedment into the bridge deck.
3. The reinforcement for the railing on a Retaining Wall shall be the same as detailed with ØA = 90°.
4. All reinforcing steel at the open joints shall have a 2" minimum cover.
5. Bars 5S may be continuous or spliced at the construction joints. Bar splices for Bars 5S shall be a minimum of 2'-2".
6. The Contractor may utilize Welded Wire Reinforcement (WWR) when approved by the Engineer. WWR must consist of Deformed wire meeting the requirements of Specification Section 931.

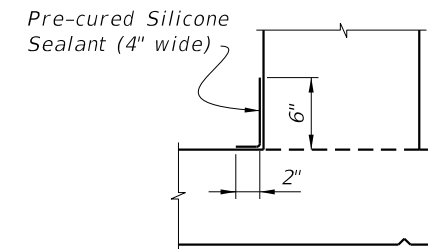

DETAIL "A" - SECTION AT INTERMEDIATE OPEN JOINT

INTERMEDIATE JOINT SEAL NOTES:

1. At Intermediate Open Joints, seal the lower 6" portion of the open joint with Pre-cured Silicone Sealant in accordance with Specification Section 932.
2. Apply sealant prior to any Class V finish coating and remove all curing compound and loose material from the surface prior to application of bonding agent.
3. The cost of the Pre-cured Silicone Sealant shall be included in the Contract Unit Price for the Traffic Railing.

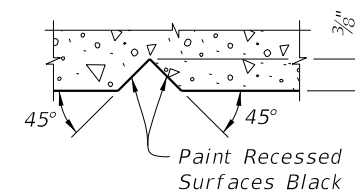

SECTION THRU RECESSED "V" GROOVE TO FORM INSCRIBED LETTERS AND FIGURES

| ESTIMATED TRAFFIC RAILING QUANTITIES |       |          |
|--------------------------------------|-------|----------|
| ITEM                                 | UNIT  | QUANTITY |
| Concrete                             | CY/LF | 0.095    |
| Reinforcing Steel                    | LB/LF | 25.90    |

(The above quantities are based on a 6" thick x 6' wide raised sidewalk at low side of deck, 2% deck cross slope and counter 2% sidewalk cross slope.)

12/17/2015 11:16:33 AM

|                           |          |              |  |   |                         |                            |
|---------------------------|----------|--------------|--|---|-------------------------|----------------------------|
| LAST REVISION<br>07/01/13 | REVISION | DESCRIPTION: |  <b>FY 2016-17<br/>DESIGN STANDARDS</b> | <b>TRAFFIC RAILING - (32" VERTICAL SHAPE)</b> | INDEX NO.<br><b>423</b> | SHEET NO.<br><b>3 of 3</b> |
|---------------------------|----------|--------------|--|---|-------------------------|----------------------------|