

SOP 1

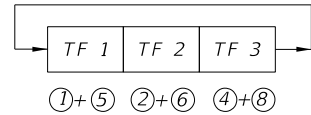

SOP 2

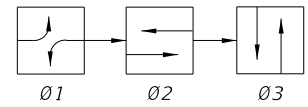
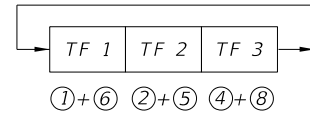
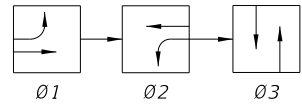

SOP 3

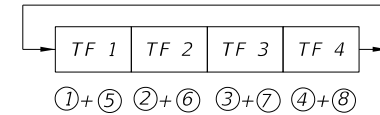
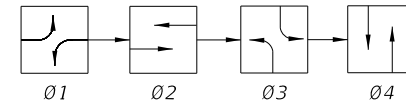

SOP 4

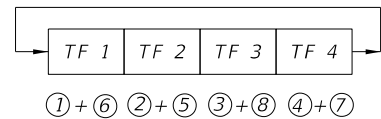
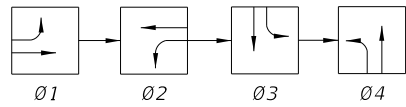

SOP 5

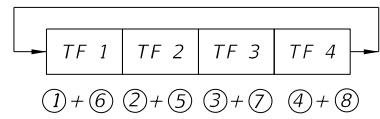
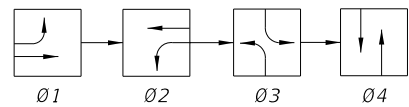

SOP 6

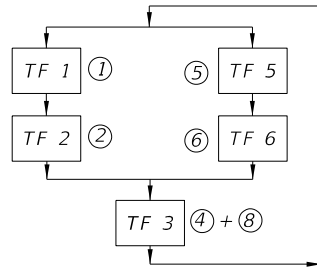
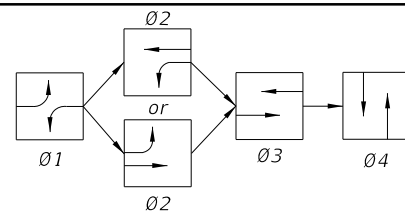

SOP 7

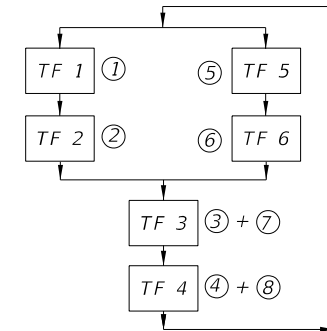
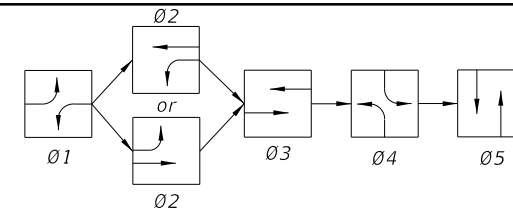

SOP 8

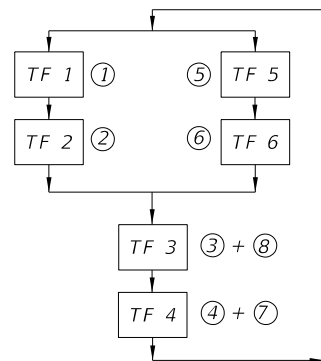
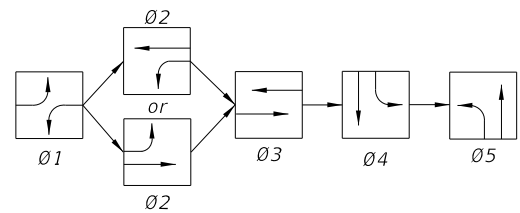

SOP 9

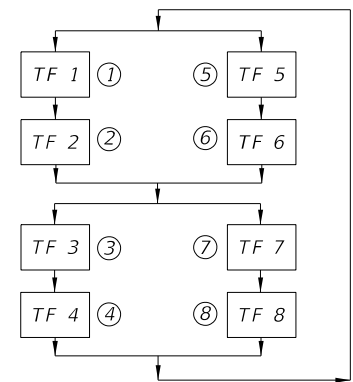
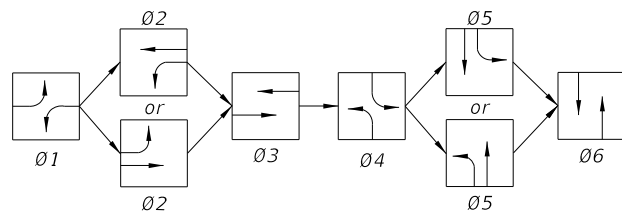

SOP 10

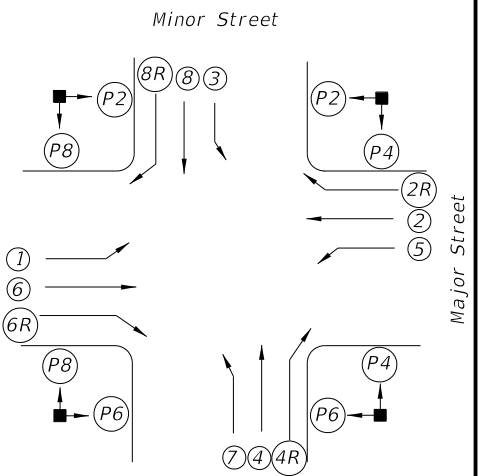

SIGNALIZED INTERSECTION

Vehicle movements & signal head number assignments are not directionally oriented but shall maintain their relative orientation about the intersection (I.E., movements 7 and 4 are always to the right of movements 1 and 6 etc.).

LEGEND

- ⊗ Vehicle Movement Number
- ⊗PX Pedestrian Movement Number
- TF X Timing Function Number
- ∅X Phase Number
- ↔ Green Arrow (Left or Right)
- ↔R Red Arrow
- ↔ Yellow Arrow

SIGNAL CLEARANCE TABLE
(Blank Indicates No Clearance Required)

From \ To	SIGNAL INDICATIONS						
	R	↔R	G	↔	↔	WALK	DONT WALK
R			Y	↔	Y		
↔R			Y	↔	Y		
G				↔			
↔							
↔							
WALK							
DONT WALK						Flash DONT WALK	

5/21/2014 4:46:03 PM

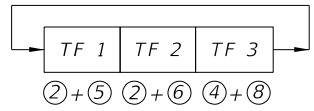
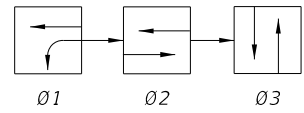

SOP 11

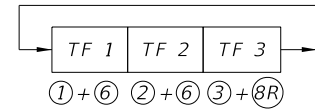
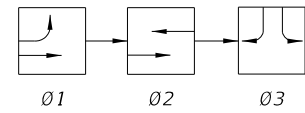

SOP 12

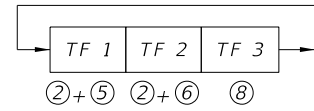
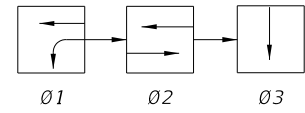

SOP 13

(ONE-WAY STREET INTERSECTION)

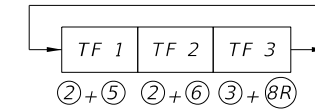
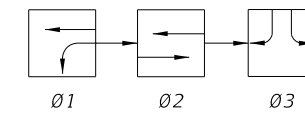

SOP 14

(DIAMOND INTERCHANGE OPERATION)

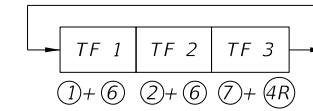
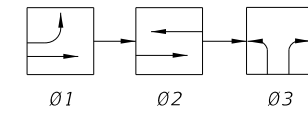

SOP 15

(DIAMOND INTERCHANGE OPERATION)

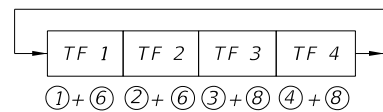
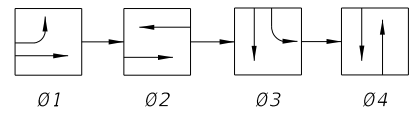

SOP 16

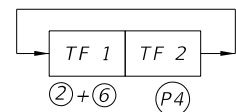
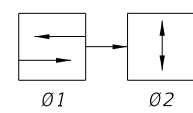

SOP 17

(MIDBLOCK)

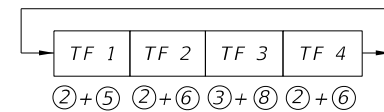
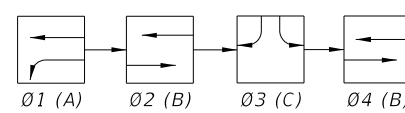

SOP 18

(DIAMOND INTERCHANGE OPERATIONS)

NOTE:
Only 02 Or 04 Used, Not Both To Obtain
ABC, Or ACB Operation.

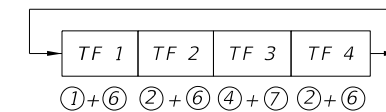
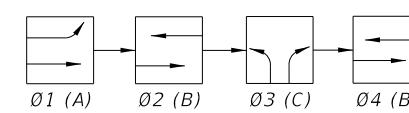

SOP 19

(DIAMOND INTERCHANGE OPERATIONS)

NOTE:
Only 02 Or 04 Used, Not Both To Obtain
ABC, Or ACB Operation.

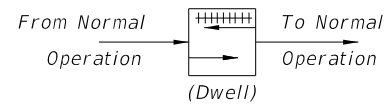

POP 1

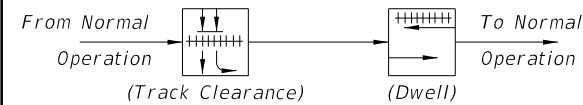

POP 2

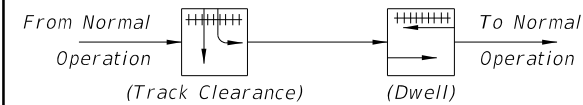

POP 3

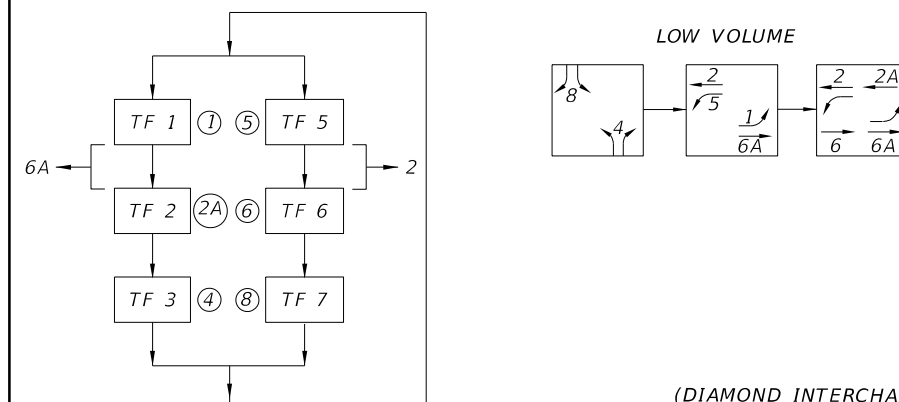
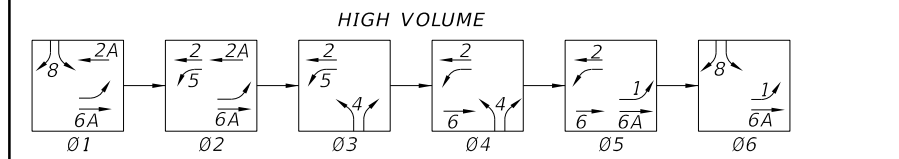

SOP 20

(DIAMOND INTERCHANGE OPERATIONS)

5/21/2014 4:46:03 PM

LAST REVISION
07/01/00

DESCRIPTION:

2015
FDOT DESIGN STANDARDS

STANDARD SIGNAL OPERATING PLANS

INDEX NO.
17870

SHEET NO.
2 of 2