

C:\projects\standards\structures\current\ready\4release\2014B00K\00476-1of4.dgn
 sm970re
 5:49:44 PM
 6/24/2013

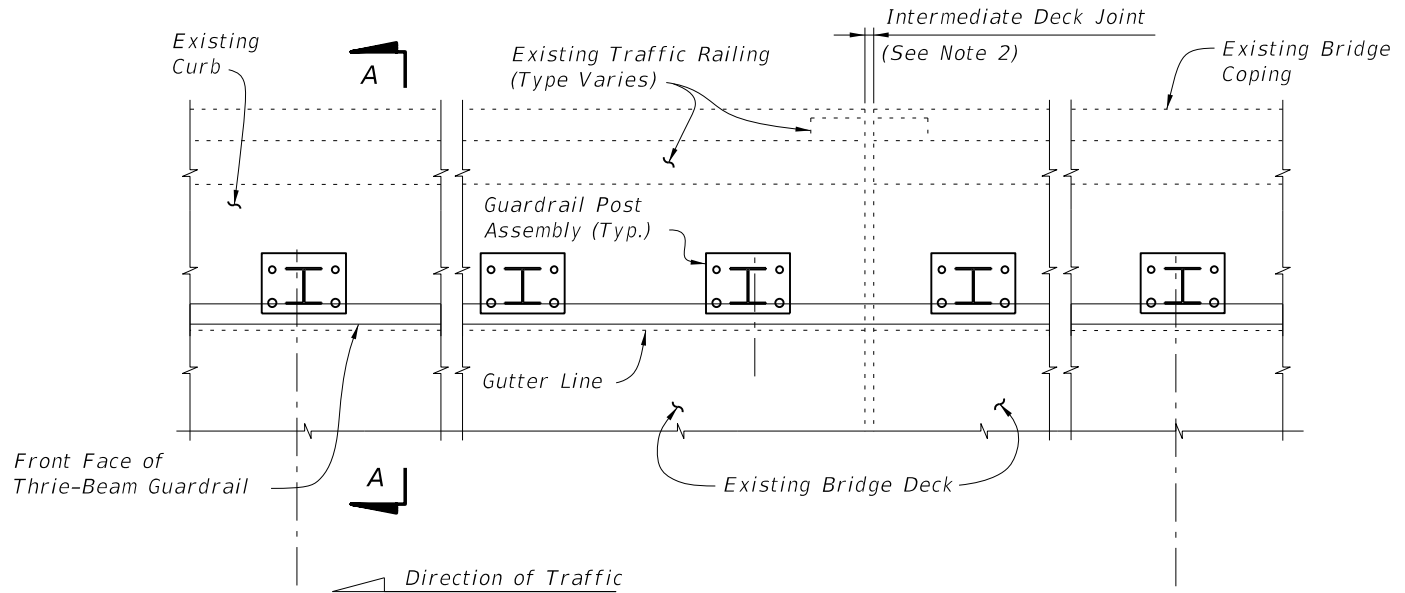

PARTIAL PLAN OF RAILING

☐ Post Bolts and Match Line (Trailing End) (See Sheets 3 and 4)
 ☐ Post Bolts and Match Line (Approach End) (See Sheets 3 and 4)

3'-1 1/2" spacing (Typ. except as noted along Bridge, see Note 2)

11" Min. for non skewed joints. For treatment of skewed Intermediate Deck Joints (see Skew Detail Index No. 470, Sheet 2) (Typ.)

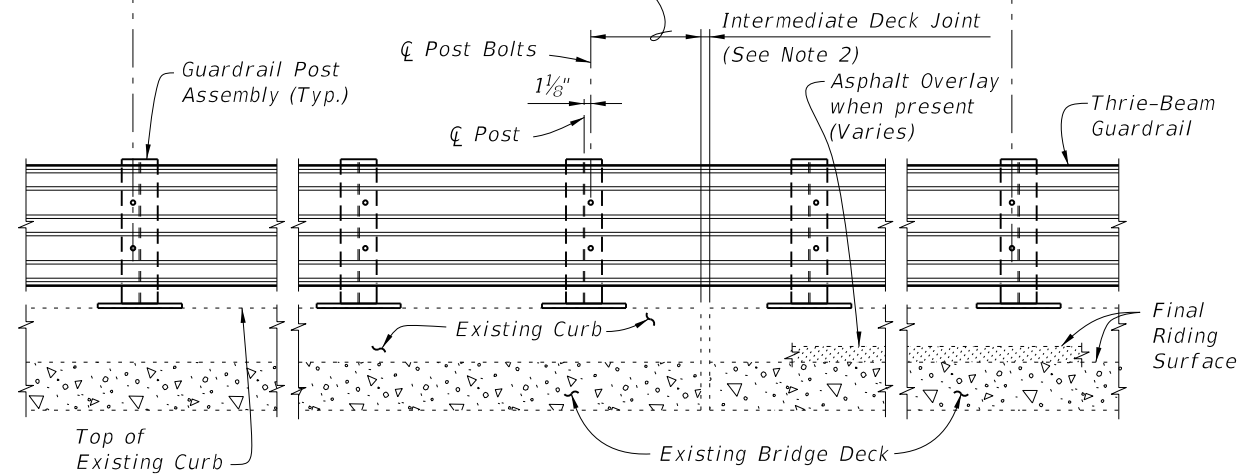

PARTIAL ELEVATION OF INSIDE FACE OF RAILING
(Existing Traffic Railing not shown for clarity)

==== TYPICAL TREATMENT OF RAILING ALONG BRIDGE ====

NOTES:

1. On approach end provide Index No. 402 (as shown) or other site specific treatment, see Roadway Plans. For treatment of trailing end see Roadway Plans.
2. Actual joint dimension and orientation vary. For Intermediate Deck Joints use the Modified Post Spacing at Intermediate Deck Joints Detail, Index No. 470, Sheet 2, as required.
3. Areas where existing structure has been removed shall match adjoining areas and shall be finished flat by grouting or grinding as required. Exposed existing reinforcing steel shall be burned off 1" below existing concrete and grouted over.

CROSS REFERENCES:

For Section A-A see Sheet 2.
 For Traffic Railing Notes and Details see Index No. 470.

| | | | | | | |
|---------------------------|----------|--------------|--|---|-------------------------|----------------------------|
| LAST REVISION 01/01/08 | REVISION | DESCRIPTION: |  FDOT 2014 DESIGN STANDARDS | TRAFFIC RAILING - (THRIE-BEAM RETROFIT) WIDE CURB TYPE 2 | INDEX NO. 476 | SHEET NO. 1 of 4 |
|---------------------------|----------|--------------|--|---|-------------------------|----------------------------|

C:\projects\standards\structures\current\ready\4release\2014BOOK\00476-2of4.dgn 5:49:46 PM 6/24/2013

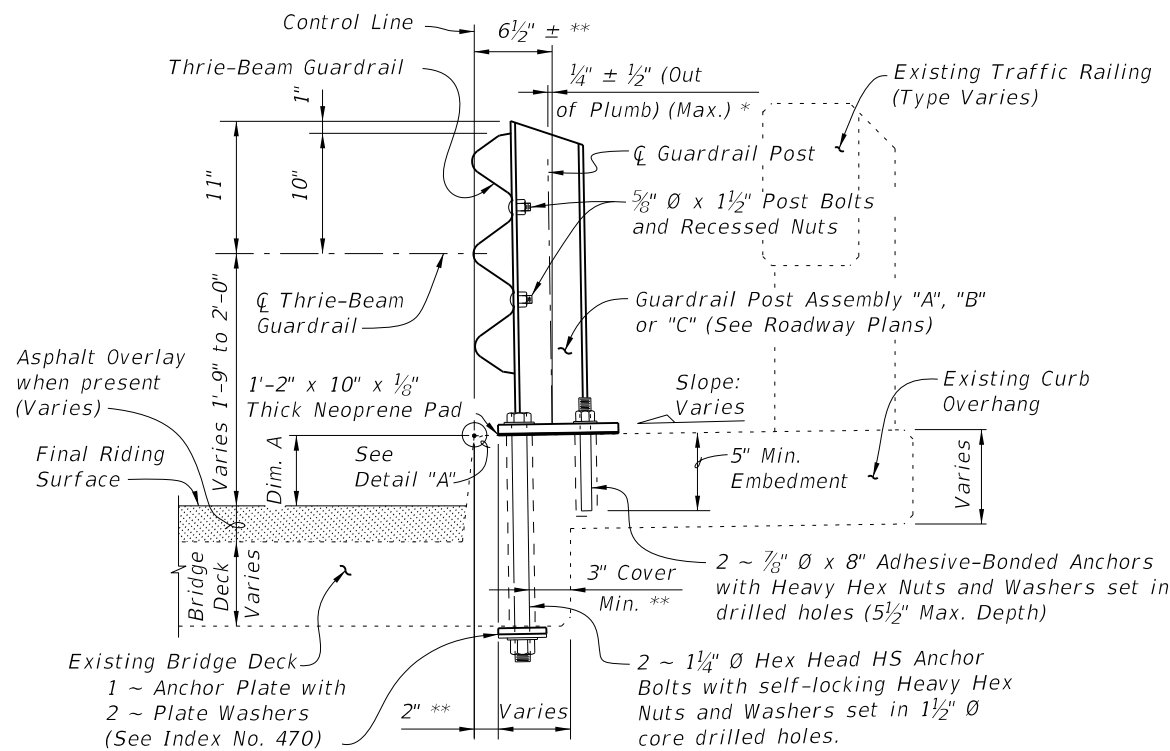

SECTION A-A
TYPICAL SECTION THRU RAILING ON BRIDGE DECK

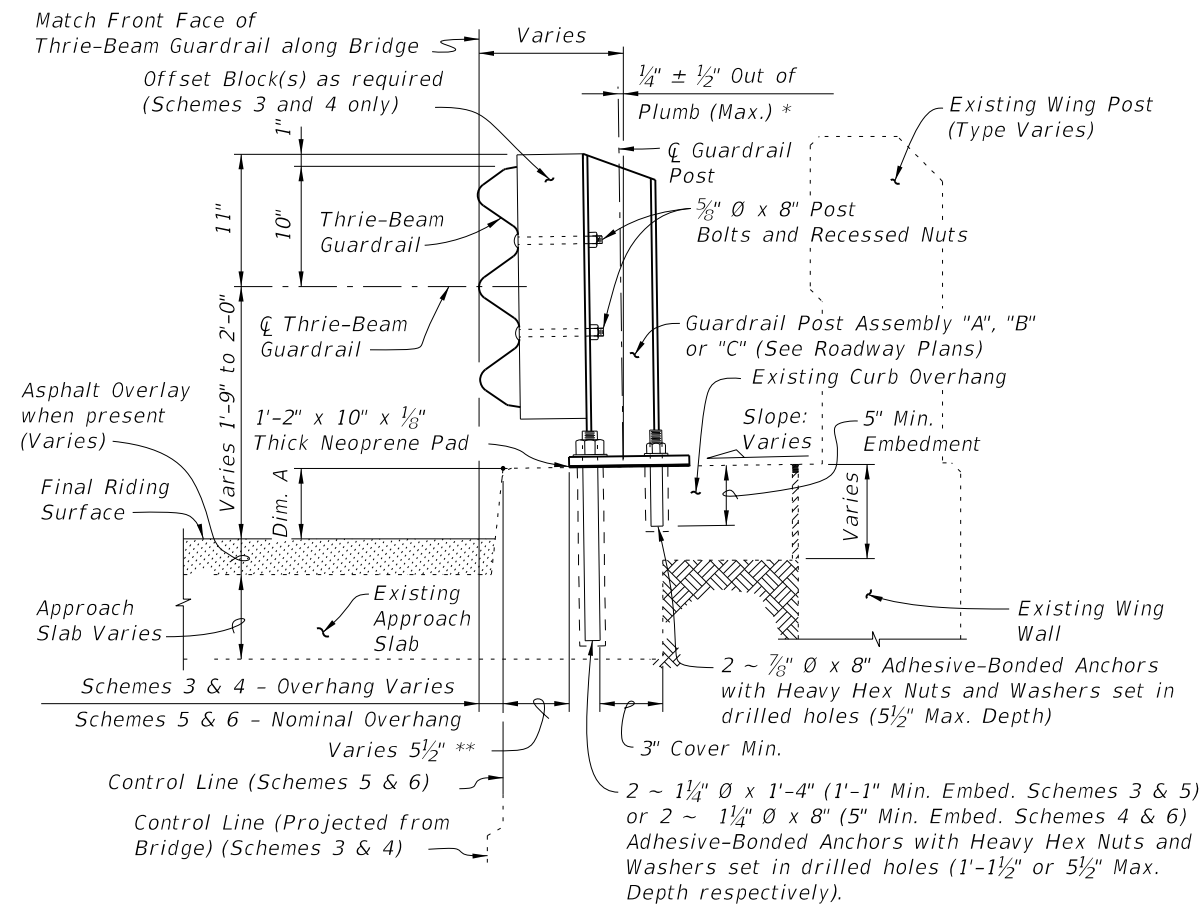

SECTION B-B
TYPICAL SECTION THRU RAILING ALONG APPROACH SLAB
(SCHEMES 5 AND 6 SHOWN, SCHEMES 3 AND 4 SIMILAR)

| BILL OF REINFORCING STEEL | | | BAR BENDING DIAGRAMS | |
|---------------------------|------|--------|----------------------|--|
| MARK | SIZE | LENGTH | | |
| D | 4 | 3'-7" | | |
| L | 4 | 4'-1" | | |
| M | 4 | 2'-8" | | |

NOTE: All bar dimensions are out to out.

* Shim with washers around Anchors as required to maintain tolerance.

** Offset may vary ± 1 " for Adhesive-Bonded Anchors to clear existing curb reinforcing and provide minimum edge clearance. Offset shall be consistent along length of bridge.

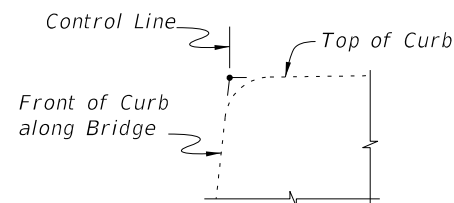

DETAIL "A"

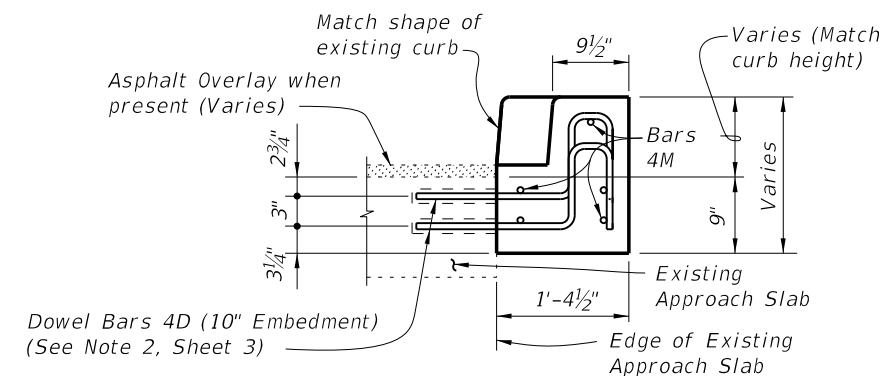

VIEW C-C

CROSS REFERENCES:
For location of Section A-A see Sheet 1, 3 & 4.
For location of Section B-B see Sheet 4.
For location of Section C-C see Sheet 3.
For application of Dim. A see Post Dimension Table on Index 470, Sheet 3.

C:\projects\standards\structures\current\ready\4release_2014\BOOK\00476-3of4.dgn
sm970re
5:49:48 PM
6/24/2013

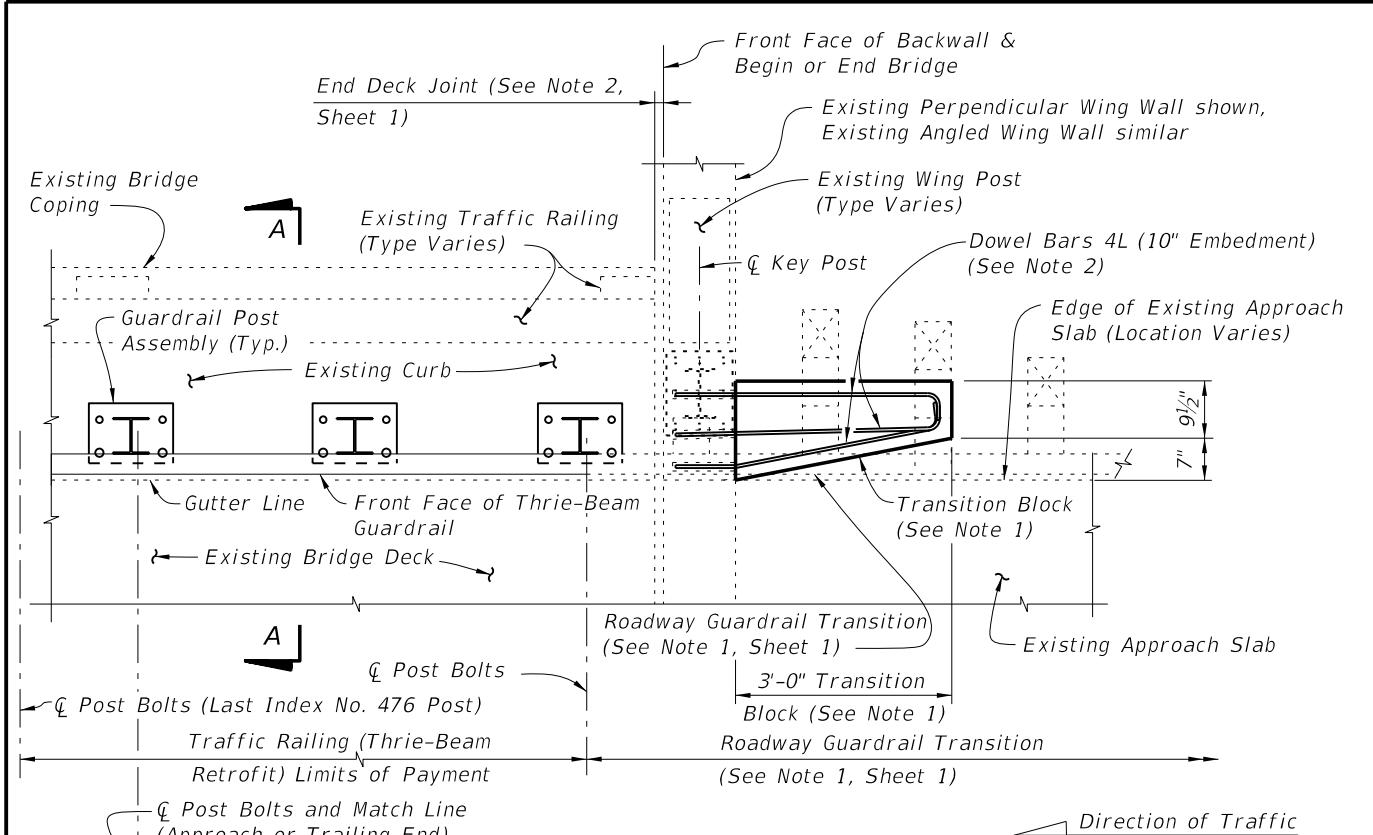

PARTIAL PLAN OF RAILING

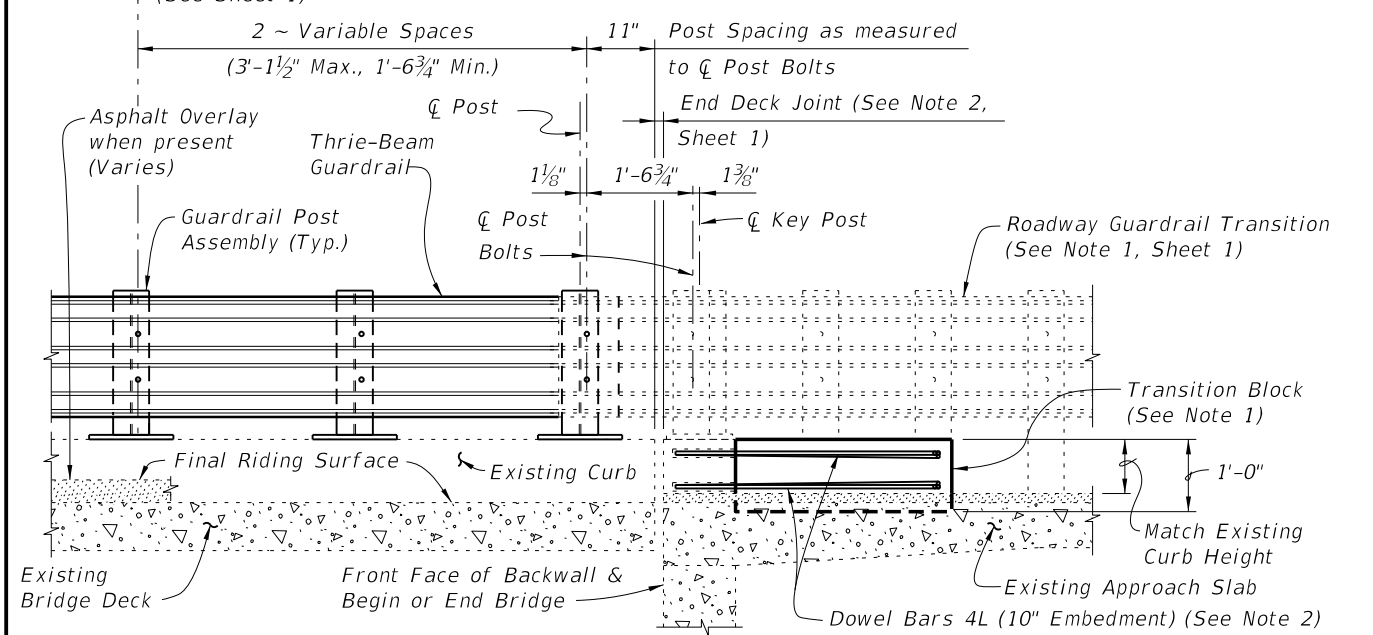

PARTIAL ELEVATION OF INSIDE FACE OF RAILING
(Existing Wing Post and Traffic Railing not shown for clarity)

SCHEME 1
RAILING END TREATMENT FOR PERPENDICULAR OR ANGLED WING WALLS

- SCHEME 1 NOTES:**
1. Provide Transition Block (as shown) or Curb if existing Approach Slab does not have a curb, see Roadway Plans. Shape and height of Transition Block or Curb shall match existing bridge curb. Transition Block may be omitted on trailing ends with no opposing traffic.
 2. Field bend Dowel Bars 4L within Transition Block as required to maintain 2" top and side clearance and 3" bottom clearance.

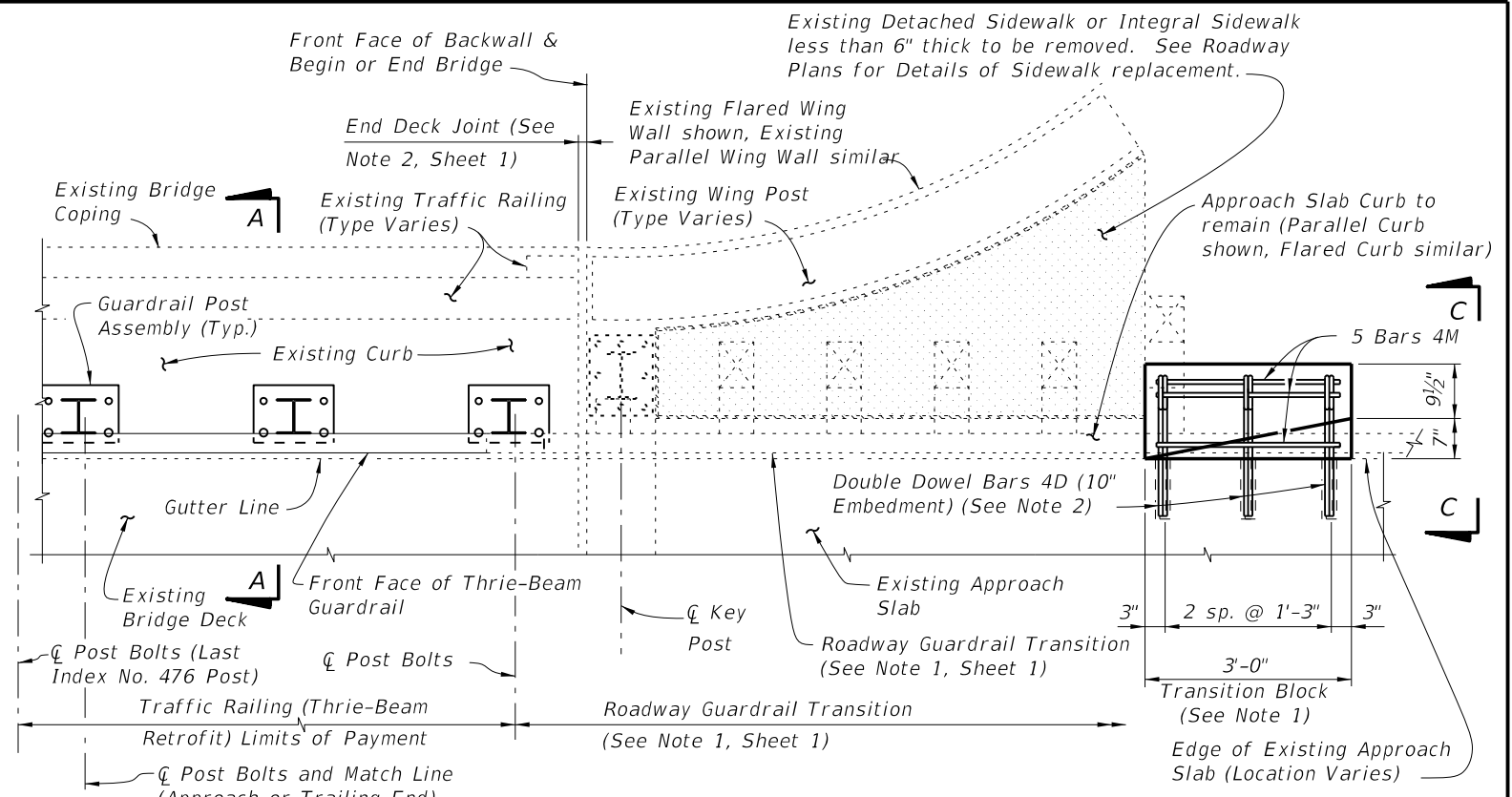

PARTIAL PLAN OF RAILING

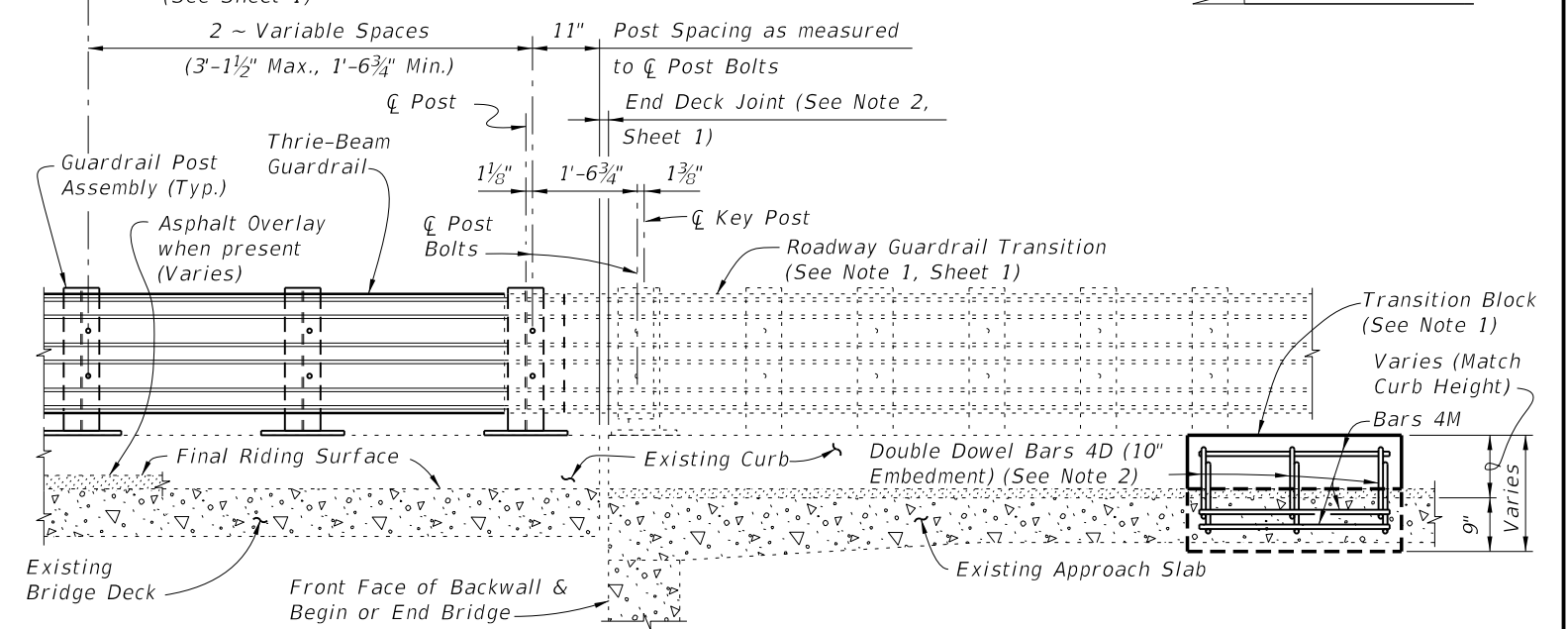

PARTIAL ELEVATION OF INSIDE FACE OF RAILING
(Existing Wing Post and Traffic Railing not shown for clarity)

SCHEME 2
RAILING END TREATMENT FOR PARALLEL OR FLARED CURBS WITH DETACHED SIDEWALKS OR INTEGRAL SIDEWALK LESS THAN 6" THICK

- SCHEME 2 NOTES:**
1. Provide Transition Block (as shown) or Curb if existing Approach Slab Curb does not extend to end of Approach Slab. Shape and height of Transition Block or Curb shall match existing bridge curb. Transition Block may be omitted on trailing ends with no opposing traffic and on bridges with flared Approach Slab Curbs.
 2. Field bend or tilt Dowel Bars 4D and Bars 4M within Transition Block as required to maintain 2" top and side clearance and 3" bottom clearance.

| | | | | | | |
|---------------------------|----------|--------------|--|---|------------------|---------------------|
| LAST REVISION 01/01/08 | REVISION | DESCRIPTION: |  FDOT 2014 DESIGN STANDARDS | TRAFFIC RAILING - (THRIE-BEAM RETROFIT) WIDE CURB TYPE 2 | INDEX NO. 476 | SHEET NO. 3 of 4 |
|---------------------------|----------|--------------|--|---|------------------|---------------------|

C:\projects\standards\structures\current\year4\release_2014\BOOK\00476-4of4.dgn
 5:49:50 PM
 6/24/2013

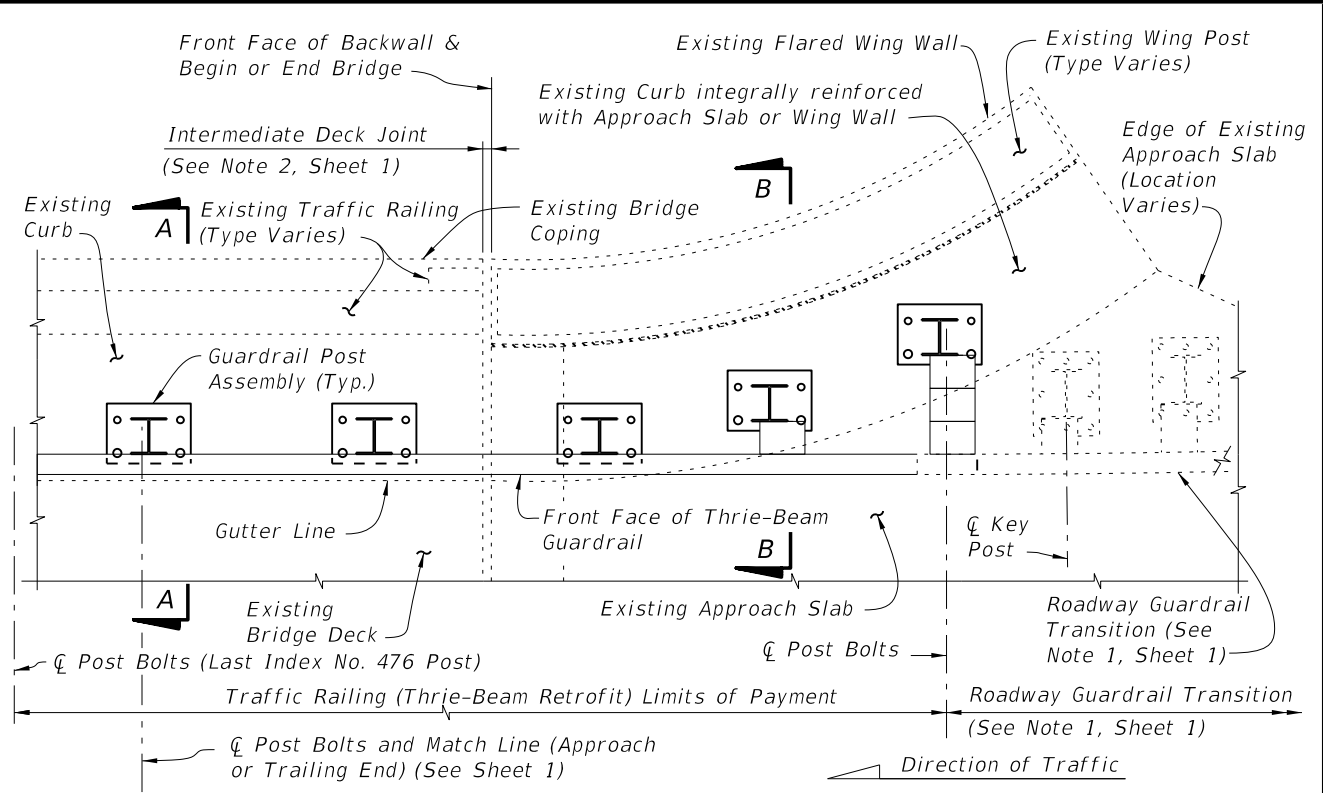

PARTIAL PLAN OF RAILING

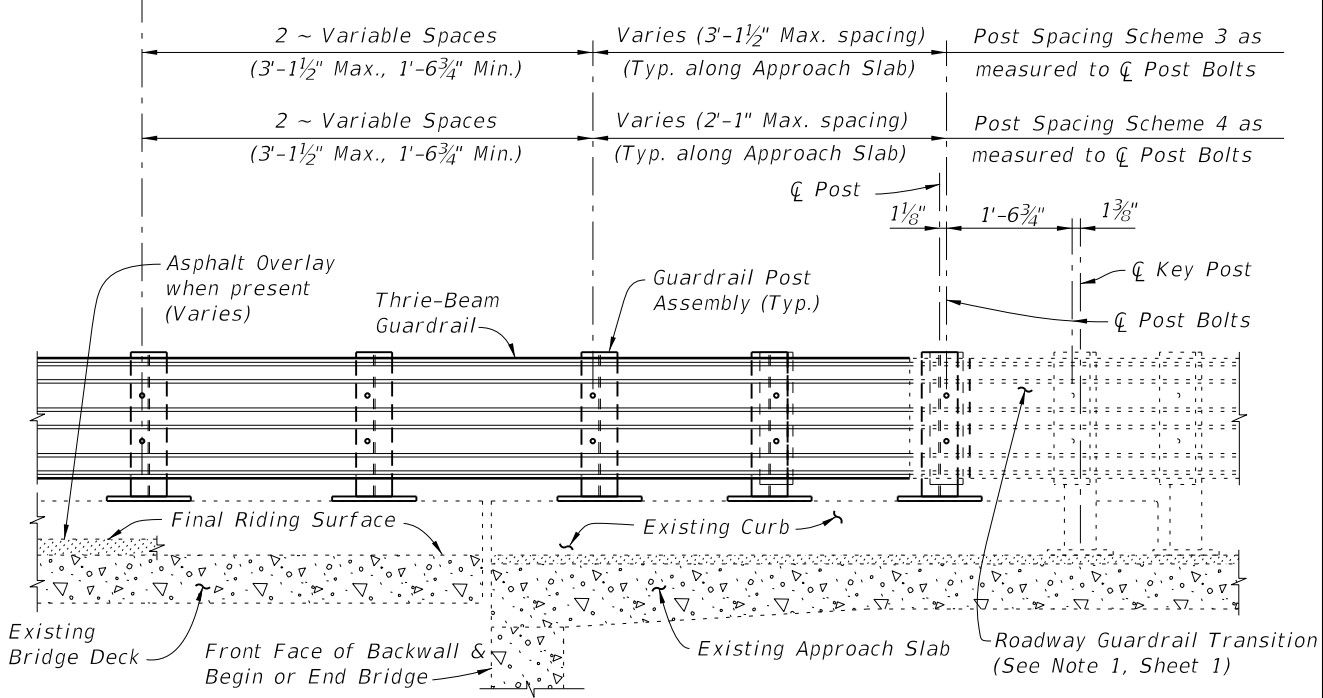

PARTIAL ELEVATION OF INSIDE FACE OF RAILING
(Existing Wing Post and Traffic Railing not shown for clarity)

SCHEMES 3 AND 4
RAILING END TREATMENT FOR FLARED INTEGRAL CURBS

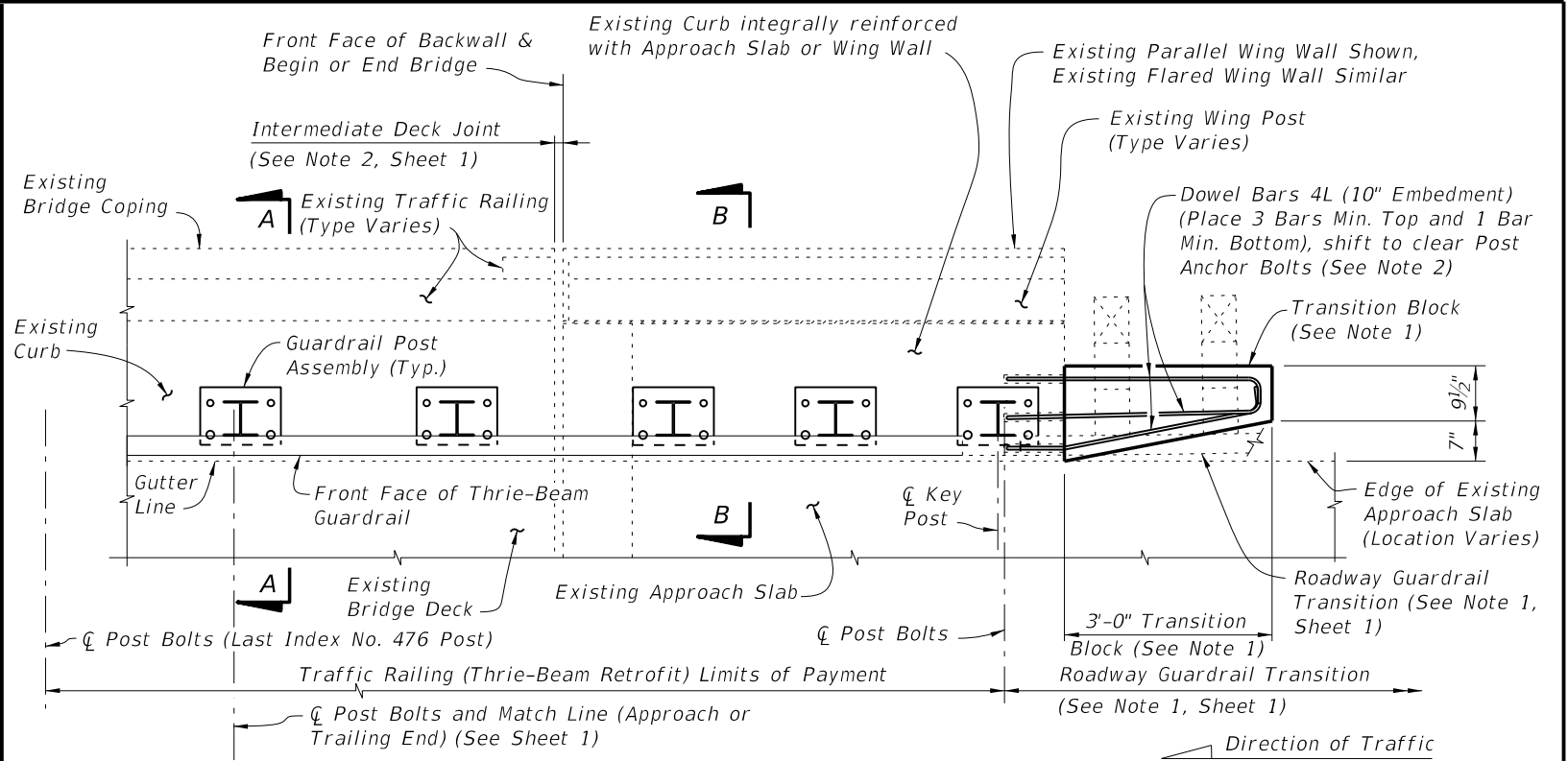

PARTIAL PLAN OF RAILING

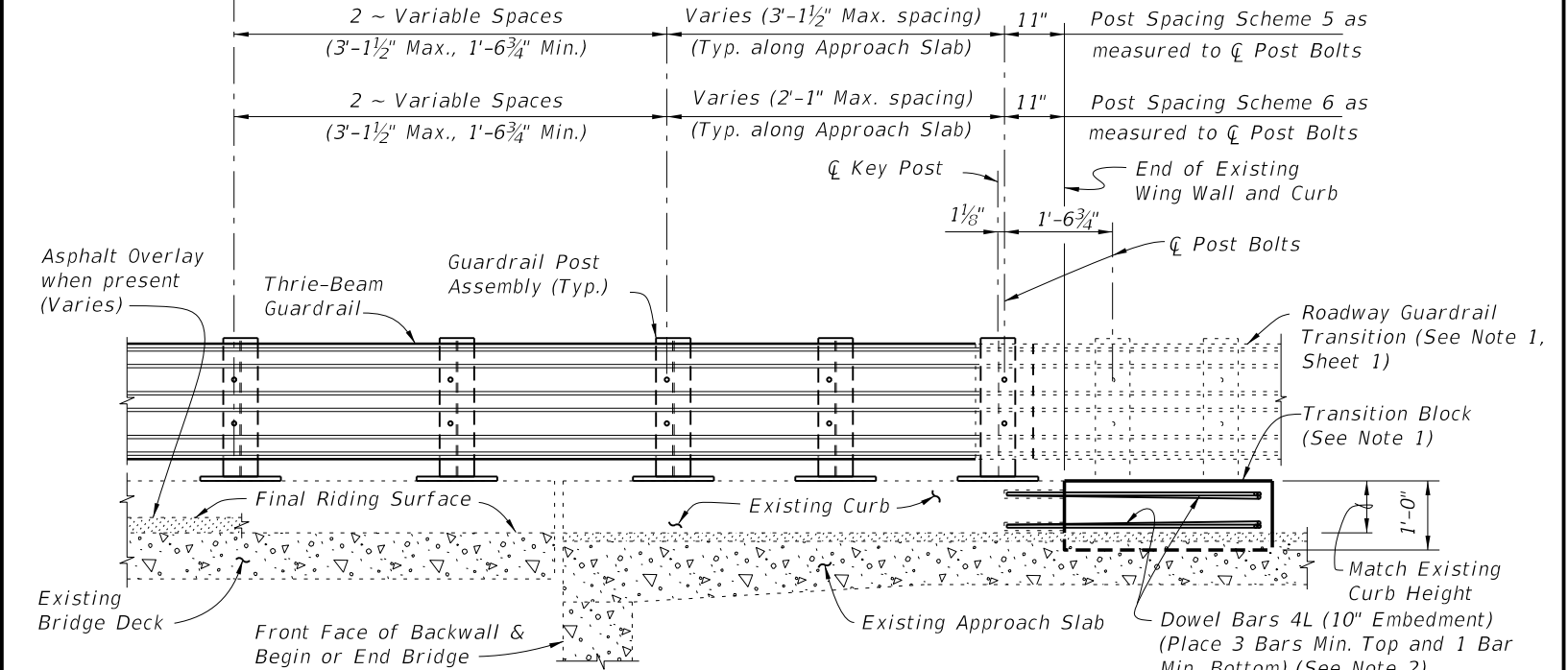

PARTIAL ELEVATION OF INSIDE FACE OF RAILING
(Existing Wing Post and Traffic Railing not shown for clarity)

SCHEMES 5 AND 6
RAILING END TREATMENT FOR PARALLEL INTEGRAL CURBS

- SCHEMES 5 AND 6 NOTES:**
1. Provide Transition Block (as shown) or Curb if existing Approach Slab Curb does not extend to end of Approach Slab. Shape and height of Transition Block or Curb shall match existing bridge curb. Transition Block may be omitted on trailing ends with no opposing traffic.
 2. Field bend Dowel Bars 4L within Transition Block as required to maintain 2" top and side clearance and 3" bottom clearance.

| | | | | | | |
|---------------------------|----------|--------------|---|---|-------------------------|----------------------------|
| LAST REVISION 01/01/08 | REVISION | DESCRIPTION: |  FDOT 2014 DESIGN STANDARDS | TRAFFIC RAILING - (THRIE-BEAM RETROFIT) WIDE CURB TYPE 2 | INDEX NO. 476 | SHEET NO. 4 of 4 |
|---------------------------|----------|--------------|---|---|-------------------------|----------------------------|