

PARTIAL PLAN OF RAILING

- NOTES:
1. On approach end provide Index No. 402 (as shown) or other site specific treatment, see Roadway Plans. For treatment of trailing end see Roadway Plans.
  2. Actual joint dimension and orientation vary. For Intermediate Deck Joints use the Modified Post Spacing at Intermediate Deck Joints Detail, Index No. 470, Sheet 2, as required.
  3. Areas where existing structure has been removed shall match adjoining areas and shall be finished flat by grouting or grinding as required. Exposed existing reinforcing steel shall be burned off 1" below existing concrete and grouted over.

☐ Post Bolts and Match Line (Trailing End) (See Sheets 3 and 4)

☐ Post Bolts and Match Line (Approach End) (See Sheets 3 and 4)

3'-1 1/2" spacing (Typ. except as noted along Bridge, see Note 2)

1'-2" Min. for non skewed joints. For treatment of skewed Intermediate Deck Joints (see Skew Detail Index No. 470, Sheet 2) (Typ.)

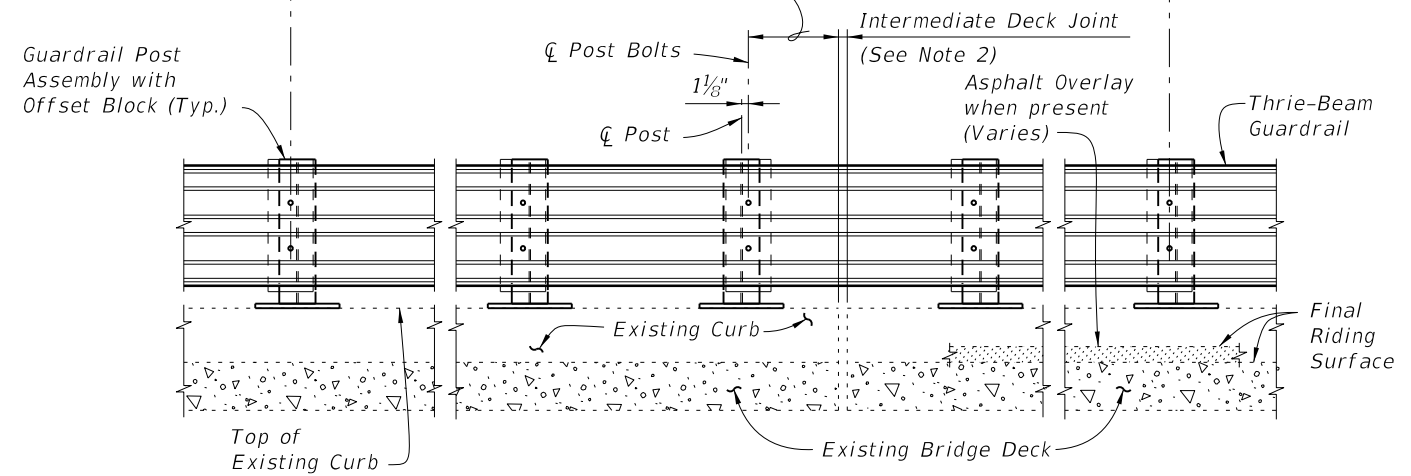

PARTIAL ELEVATION OF INSIDE FACE OF RAILING  
(Existing Traffic Railing not shown for clarity)

==== TYPICAL TREATMENT OF RAILING ALONG BRIDGE ====

CROSS REFERENCES:  
For Section A-A see Sheet 2.  
For Traffic Railing Notes and Details see Index No. 470.

C:\projects\standards\structures\2013book\00475-1of4.dgn  
rd960rh  
10:16:29 AM  
6/29/2012

|               |          |              |   |                                      |  |           |           |
|---------------|----------|--------------|---|--------------------------------------|--|-----------|-----------|
| LAST REVISION | REVISION | DESCRIPTION: |  | <b>FDOT DESIGN STANDARDS</b><br>2013 | <b>TRAFFIC RAILING - (THRIE-BEAM RETROFIT)</b><br>WIDE CURB TYPE 1 | INDEX NO. | SHEET NO. |
| 01/01/08      |          |              |   |                                      |  | 475       | 1         |

6/29/2012 10:16:32 AM rd960rh C:\projects\standards\structures\2013book\00475-2of4.dgn

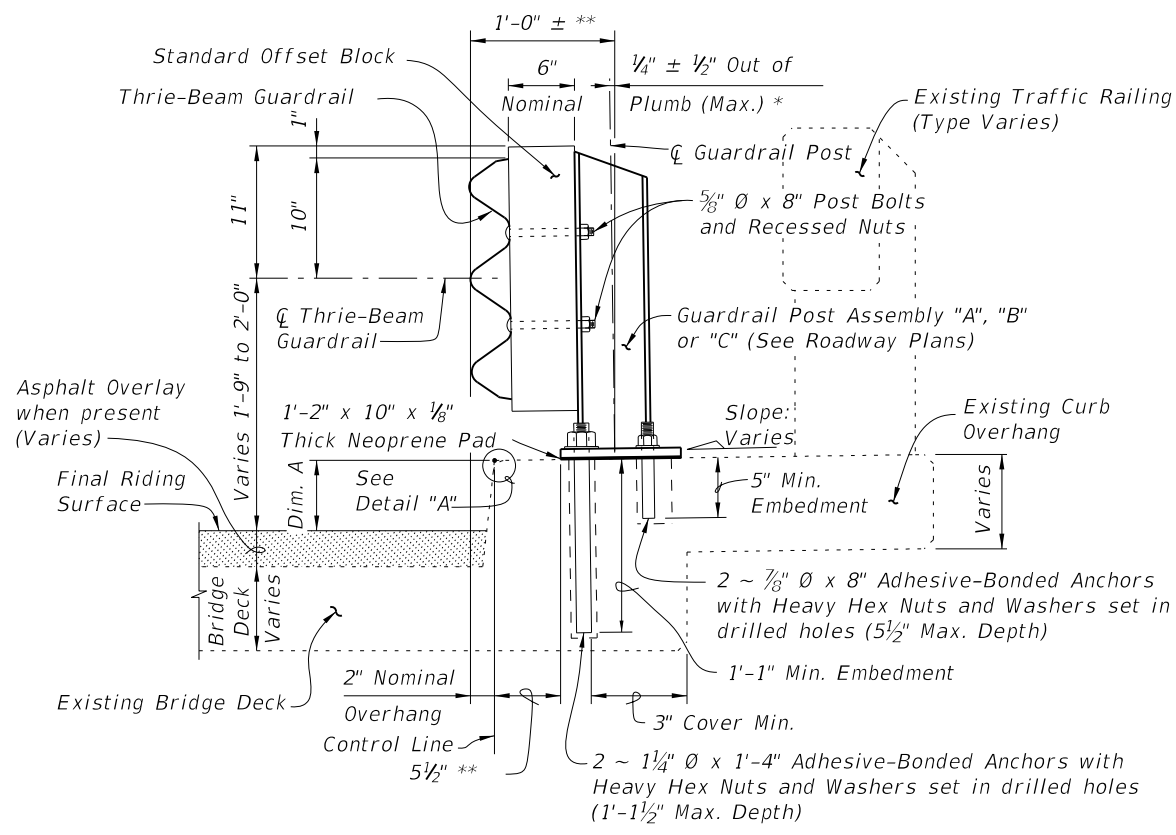

**SECTION A-A**  
TYPICAL SECTION THRU RAILING ON BRIDGE DECK

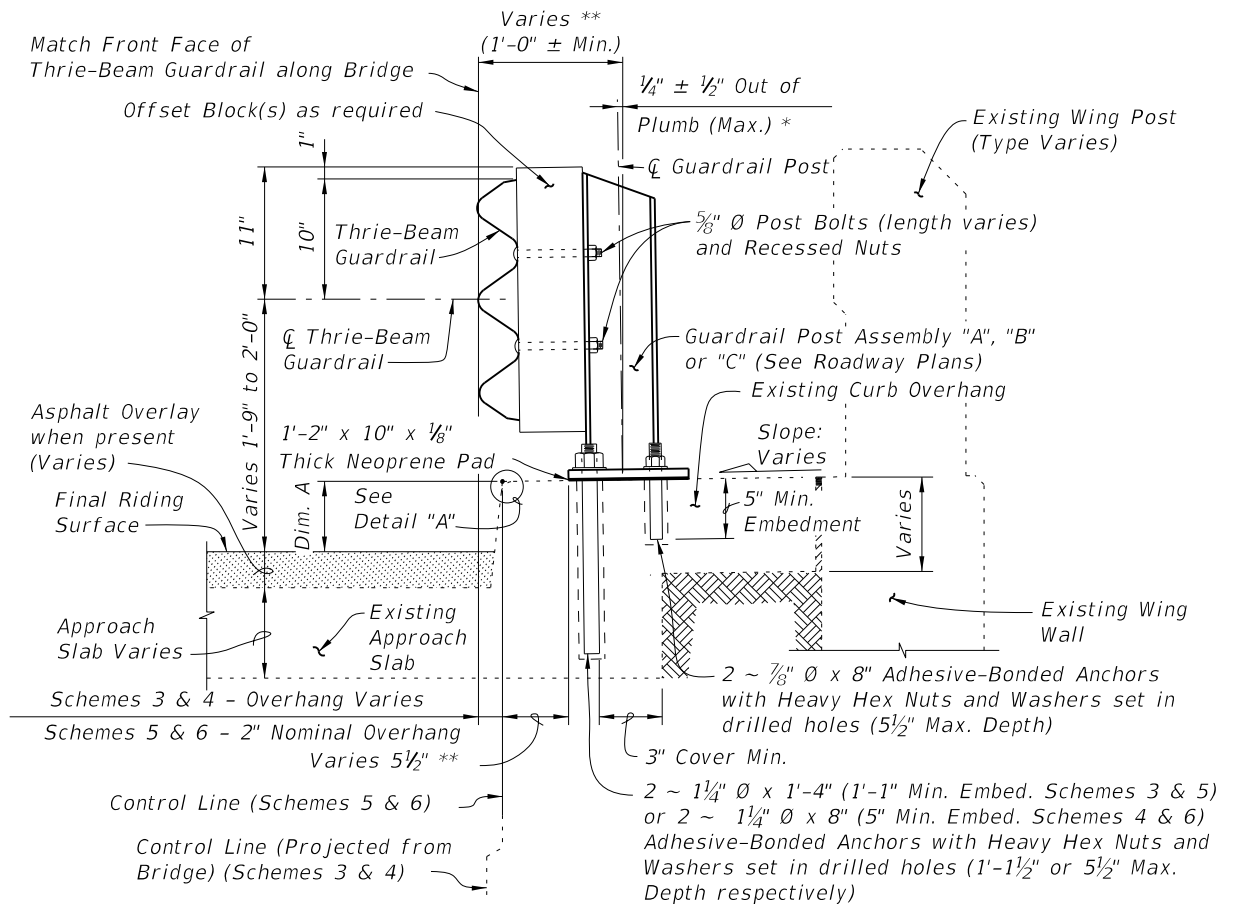

**SECTION B-B**  
TYPICAL SECTION THRU RAILING ALONG APPROACH SLAB  
(SCHEMES 5 AND 6 SHOWN, SCHEMES 3 AND 4 SIMILAR)

| BILL OF REINFORCING STEEL |      |        | BAR BENDING DIAGRAMS |  |
|---------------------------|------|--------|----------------------|--|
| MARK                      | SIZE | LENGTH |                      |  |
| D                         | 4    | 3'-7"  |                      |  |
| L                         | 4    | 4'-1"  |                      |  |
| M                         | 4    | 2'-8"  |                      |  |

  

|              |        |
|--------------|--------|
|              |        |
| DOWEL BAR 4L | BAR 4M |

NOTE: All bar dimensions are out to out.

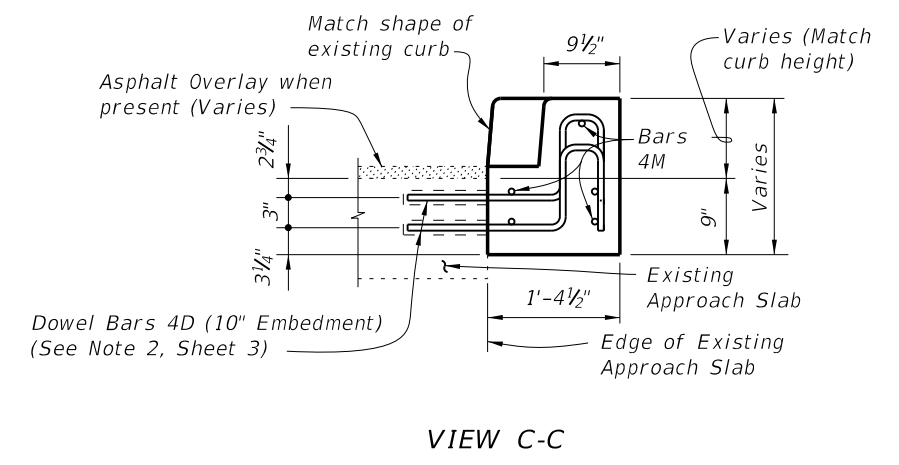
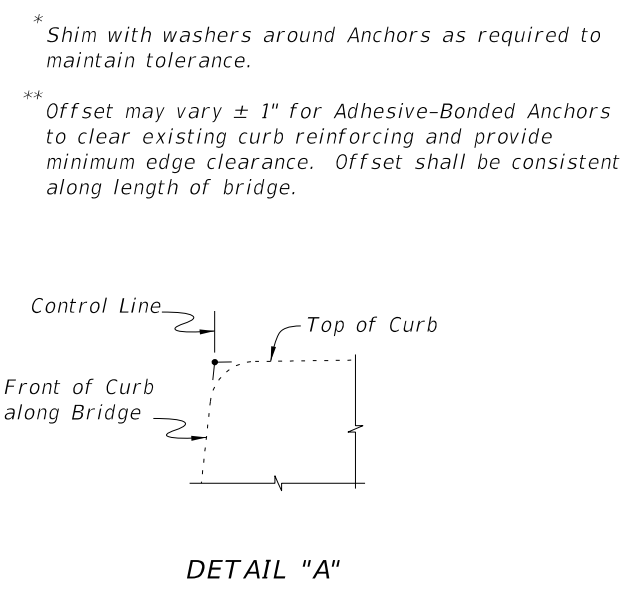

**CROSS REFERENCES:**  
 For location of Section A-A see Sheet 1, 3 & 4.  
 For location of Section B-B see Sheet 4.  
 For location of View C-C see Sheet 3.  
 For application of Dim. A see Post Dimension Table on Index 470, Sheet 3.

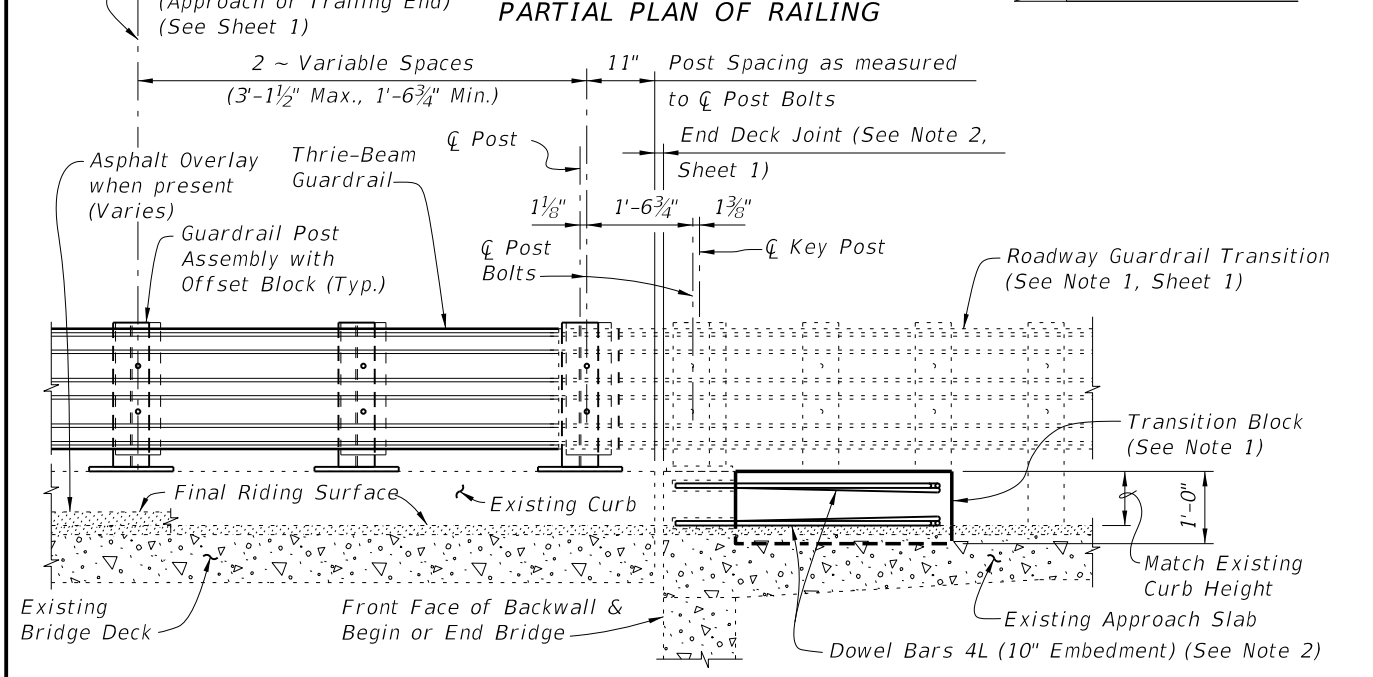
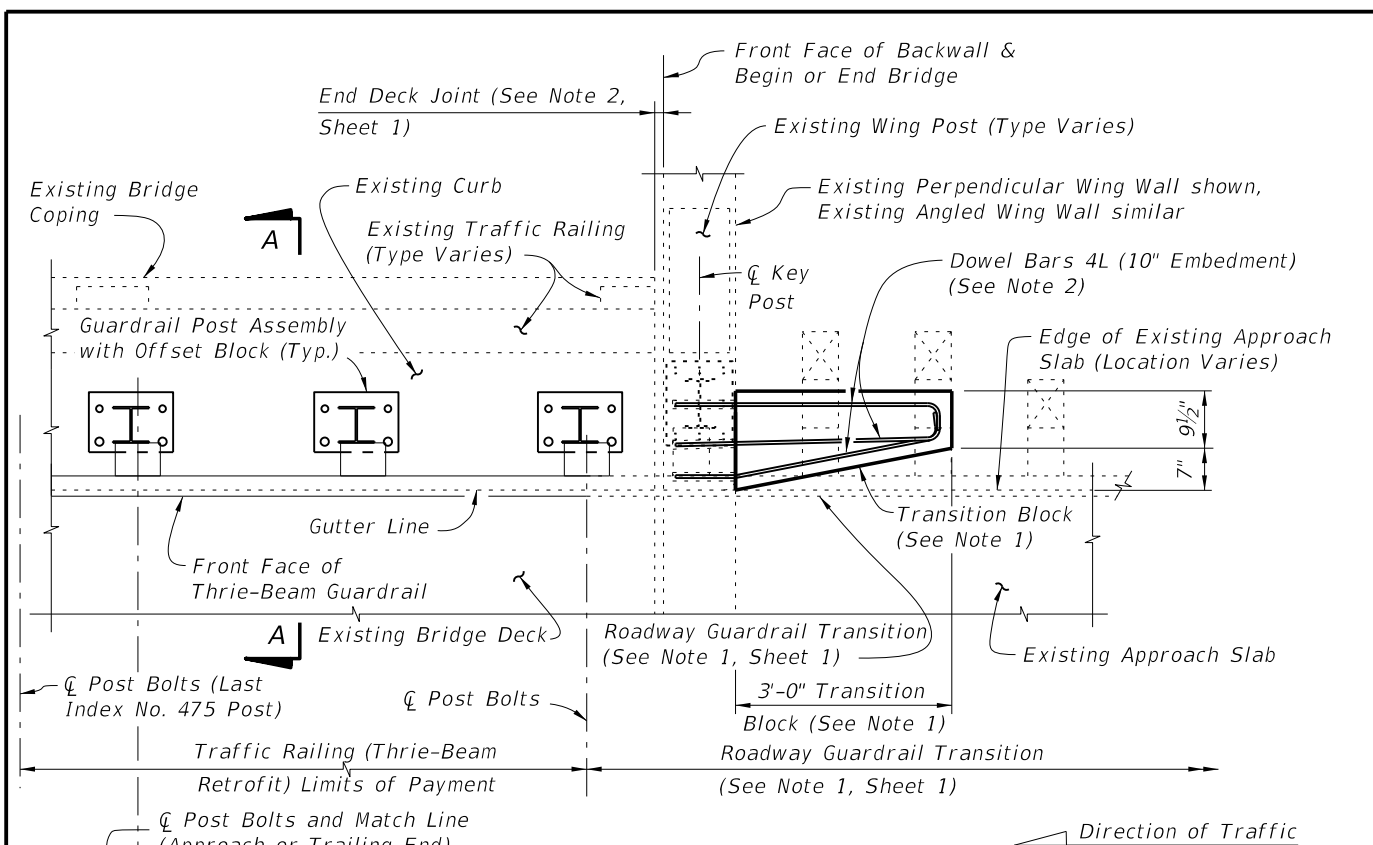

**PARTIAL ELEVATION OF INSIDE FACE OF RAILING**  
 (Existing Wing Post and Traffic Railing not shown for clarity)

**SCHEME 1**

**RAILING END TREATMENT FOR PERPENDICULAR OR ANGLED WING WALLS**

**SCHEME 1 NOTES:**

1. Provide Transition Block (as shown) or Curb if existing Approach Slab does not have a curb, see Roadway Plans. Shape and height of Transition Block or Curb shall match existing bridge curb. Transition Block may be omitted on trailing ends with no opposing traffic.
2. Field bend Dowel Bars 4L within Transition Block as required to maintain 2" top and side clearance and 3" bottom clearance.

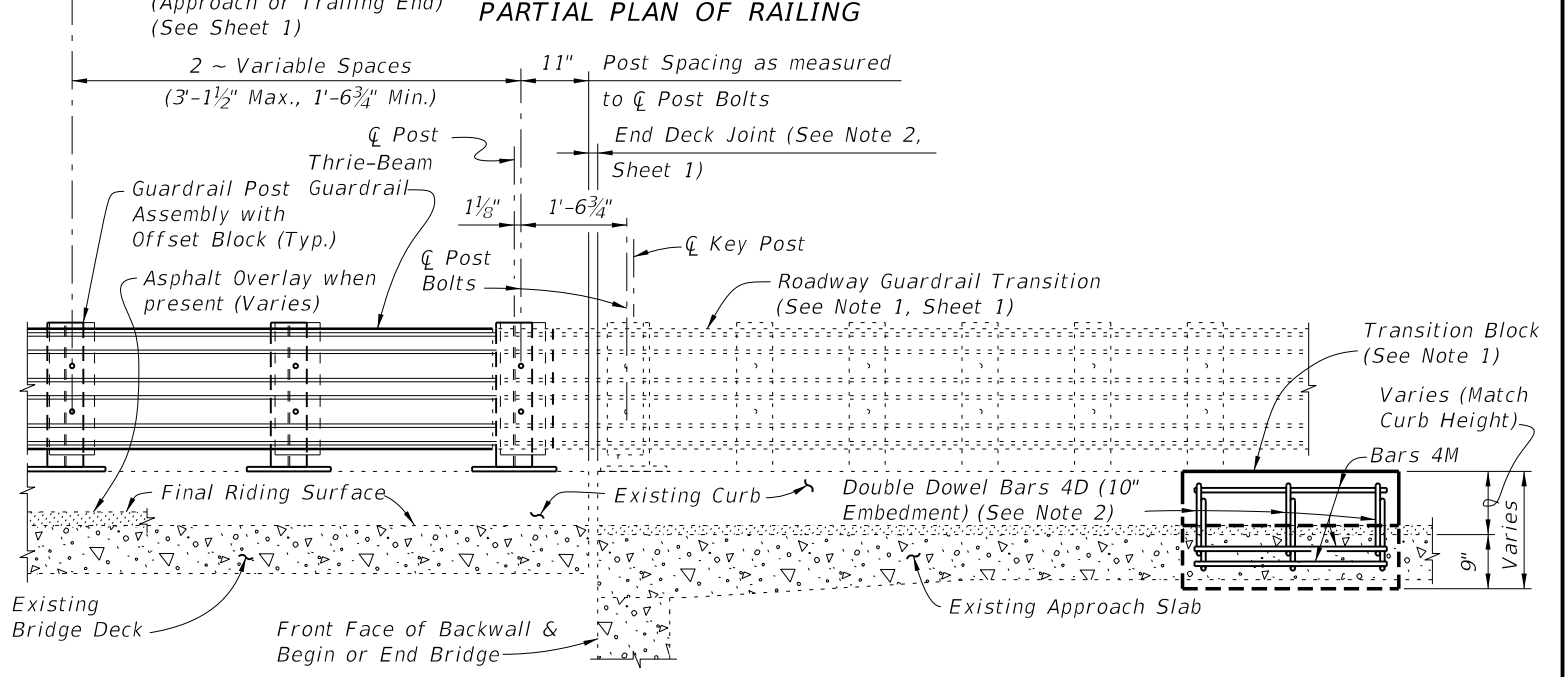
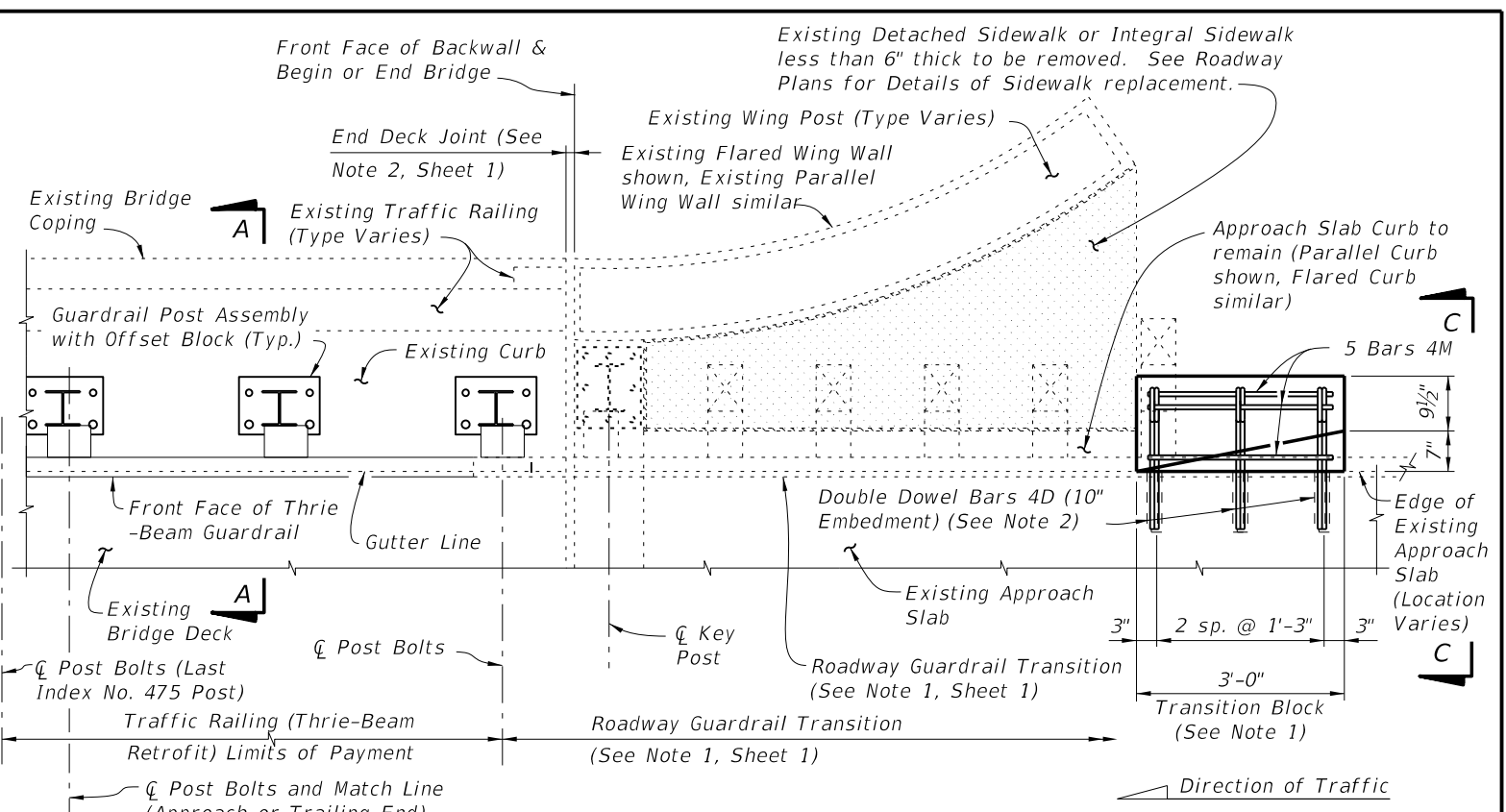

**PARTIAL ELEVATION OF INSIDE FACE OF RAILING**  
 (Existing Wing Post and Traffic Railing not shown for clarity)

**SCHEME 2**

**RAILING END TREATMENT FOR PARALLEL OR FLARED CURBS WITH DETACHED SIDEWALKS OR INTEGRAL SIDEWALKS LESS THAN 6" THICK**

**SCHEME 2 NOTES:**

1. Provide Transition Block (as shown) or Curb if existing Approach Slab Curb does not extend to end of Approach Slab. Shape and height of Transition Block or Curb shall match existing bridge curb. Transition Block may be omitted on trailing ends with no opposing traffic and on bridges with flared Approach Slab Curbs.
2. Field bend or tilt Dowel Bars 4D and Bars 4M within Transition Block as required to maintain 2" top and side clearance and 3" bottom clearance.

C:\projects\standards\structures\2013book\00475-3of4.dgn  
 rd960rh  
 10:16:34 AM  
 6/29/2012

|               |          |              |   |   |                                |                              |
|---------------|----------|--------------|---|---|--------------------------------|------------------------------|
| LAST REVISION | REVISION | DESCRIPTION: | <b>FDOT DESIGN STANDARDS</b><br><b>2013</b> | <b>TRAFFIC RAILING - (THRIE-BEAM RETROFIT)</b><br><b>WIDE CURB TYPE 1</b> | <b>INDEX NO.</b><br><b>475</b> | <b>SHEET NO.</b><br><b>3</b> |
| 01/01/08      |          |              |   |   |                                |                              |

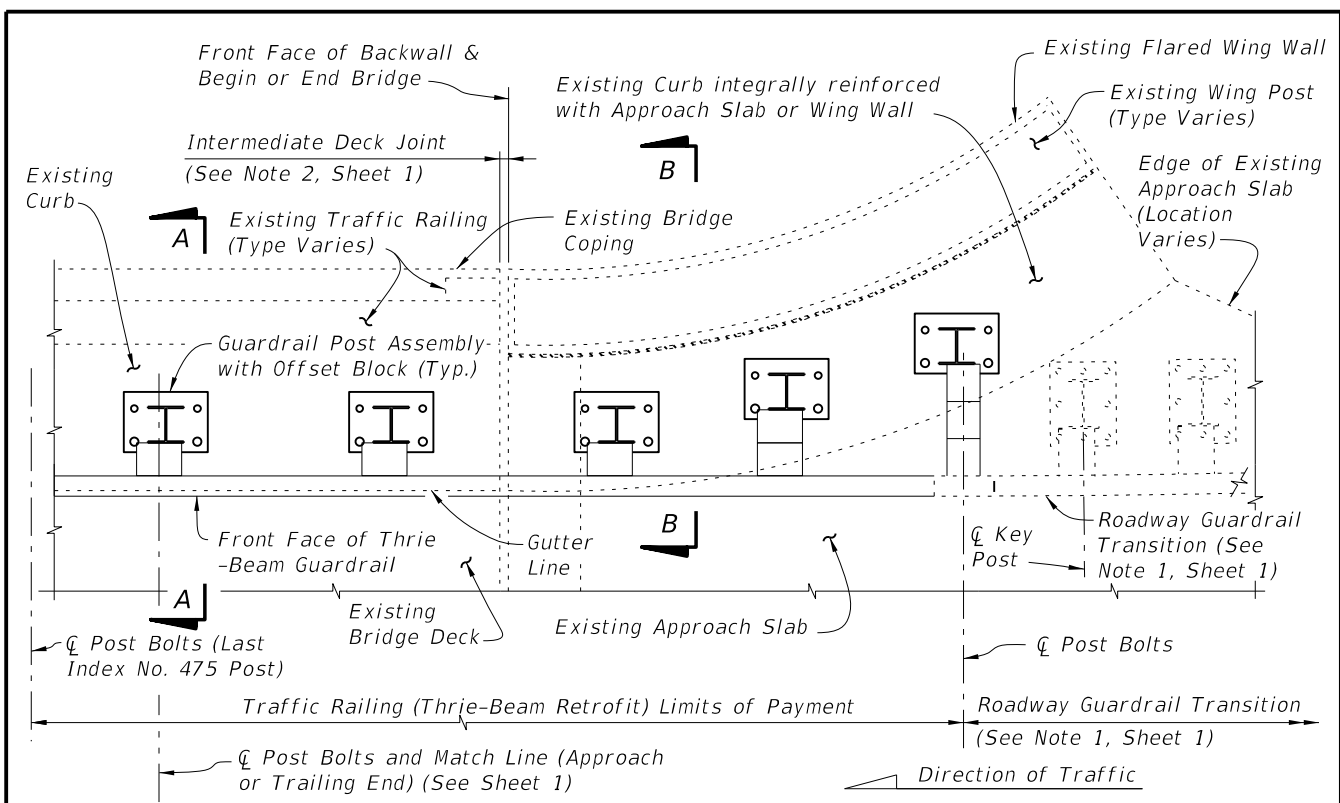

**PARTIAL PLAN OF RAILING**

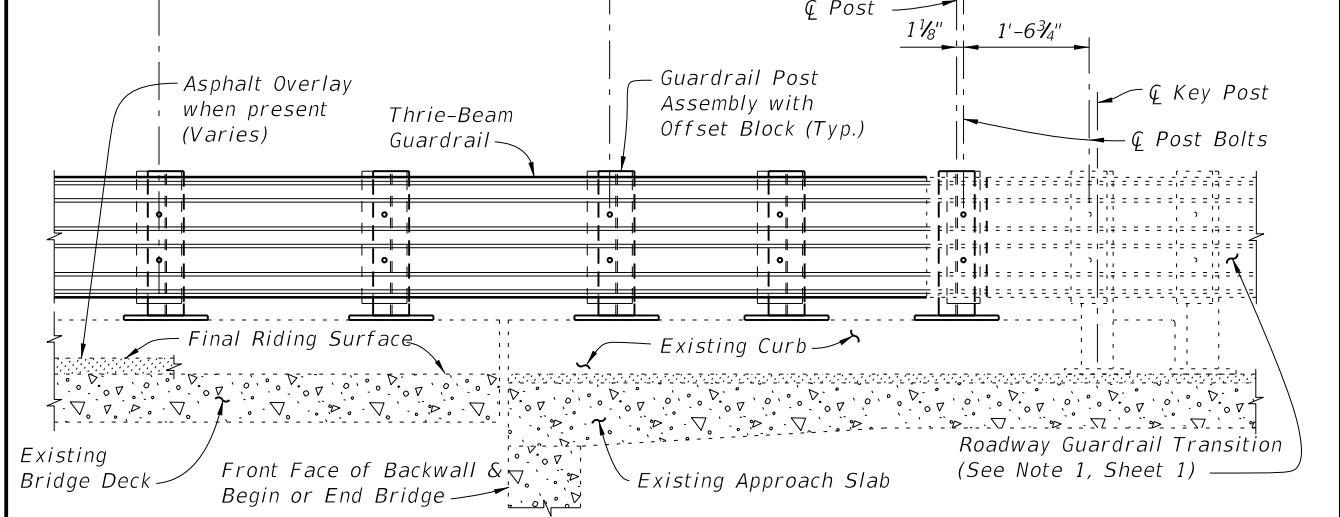
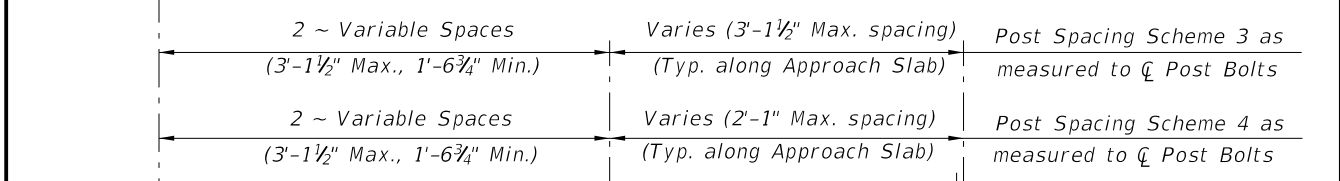

**PARTIAL ELEVATION OF INSIDE FACE OF RAILING**  
(Existing Wing Post and Traffic Railing not shown for clarity)

**SCHEMES 3 AND 4**  
**RAILING END TREATMENT FOR FLARED INTEGRAL CURBS**

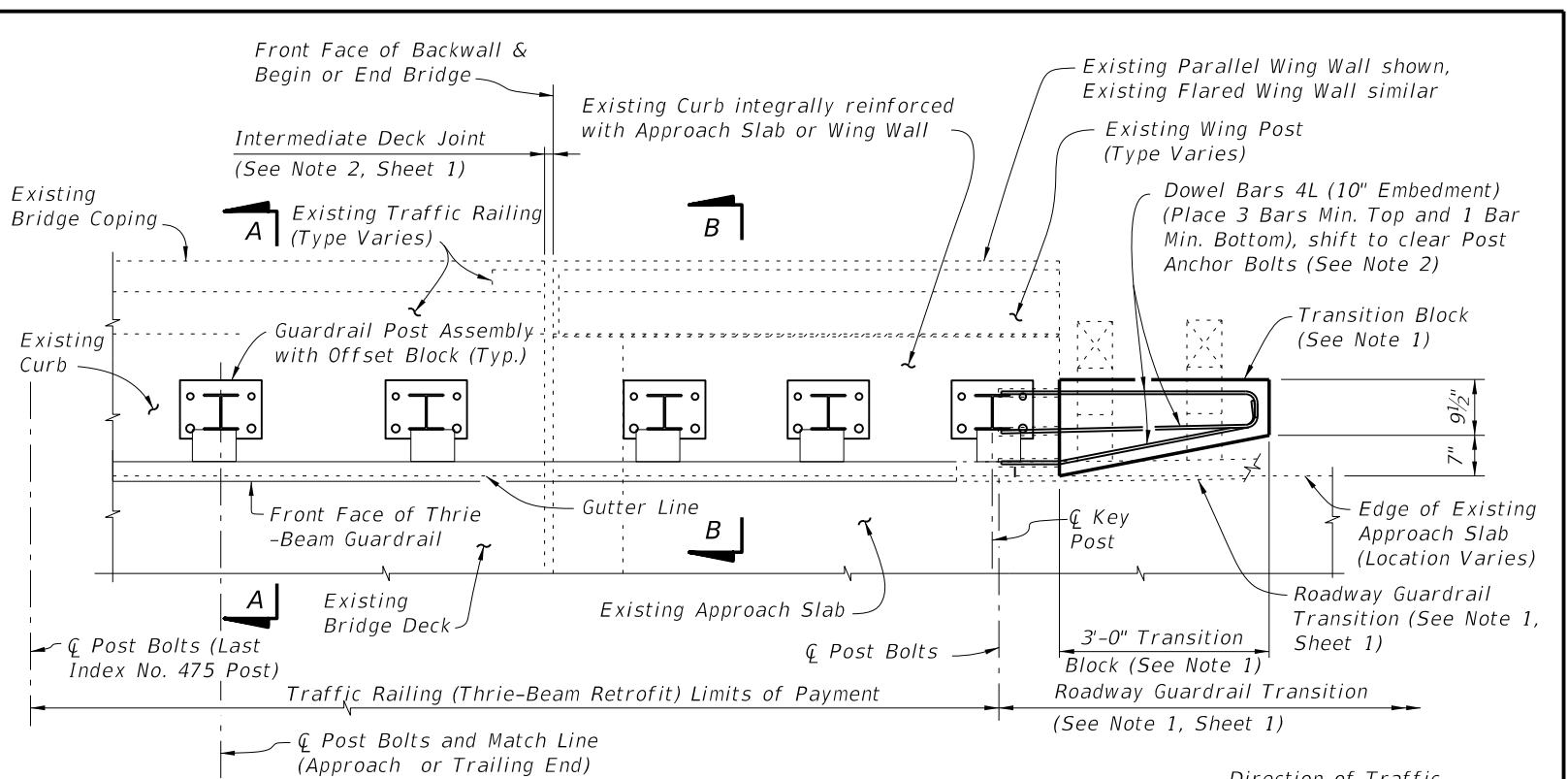

**PARTIAL PLAN OF RAILING**

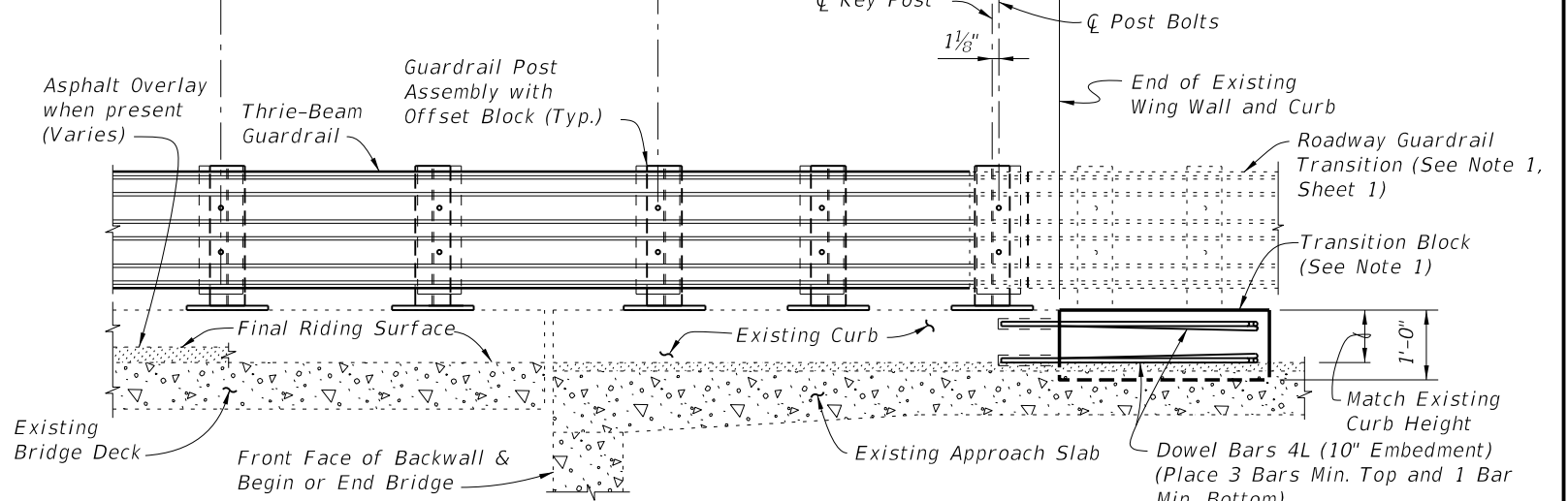
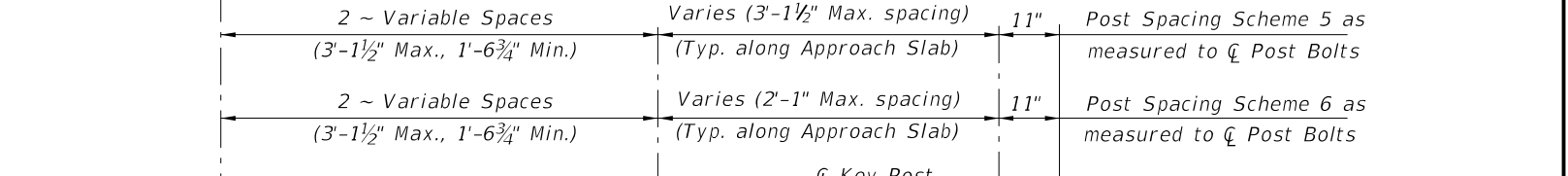

**PARTIAL ELEVATION OF INSIDE FACE OF RAILING**  
(Existing Wing Post and Traffic Railing not shown for clarity)

**SCHEMES 5 AND 6**  
**RAILING END TREATMENT FOR PARALLEL INTEGRAL CURBS**

- SCHEMES 5 AND 6 NOTES:**
1. Provide Transition Block (as shown) or Curb if existing Approach Slab Curb does not extend to end of Approach Slab. Shape and height of Transition Block or Curb shall match existing bridge curb. Transition Block may be omitted on trailing ends with no opposing traffic.
  2. Field bend Dowel Bars 4L within Transition Block as required to maintain 2" top and side clearance and 3" bottom clearance.

C:\projects\standards\structures\2013book\00475-4of4.dgn 6/29/2012 10:16:37 AM rd960rh

|               |          |              |  |  |           |           |
|---------------|----------|--------------|--|--|-----------|-----------|
| LAST REVISION | 01/01/08 | DESCRIPTION: |  <b>FDOT DESIGN STANDARDS</b><br>2013 | <b>TRAFFIC RAILING - (THRIE-BEAM RETROFIT)</b><br>WIDE CURB TYPE 1 | INDEX NO. | SHEET NO. |
|               |          |              |  |  | 475       | 4         |