

FTP-11-06  
16'-6" X 7'-6"  
12" Radii 2" Border  
12" Series E Legend  
Blue Background  
White Legend and Border

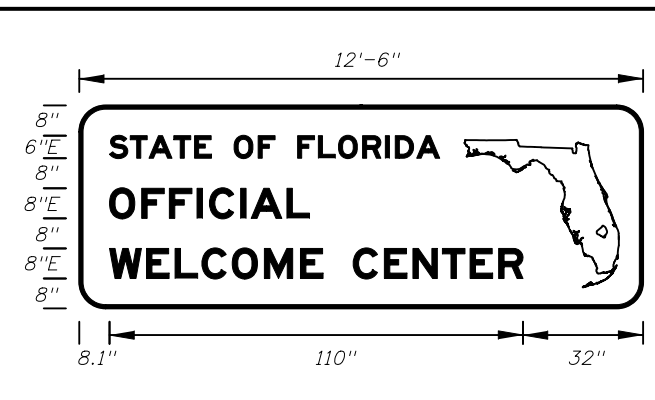

FTP-12-06  
12'-6" X 4'-6"  
7" Radii 2" Border  
6" and 8" Series E Legend  
Blue Background  
White Legend and Border

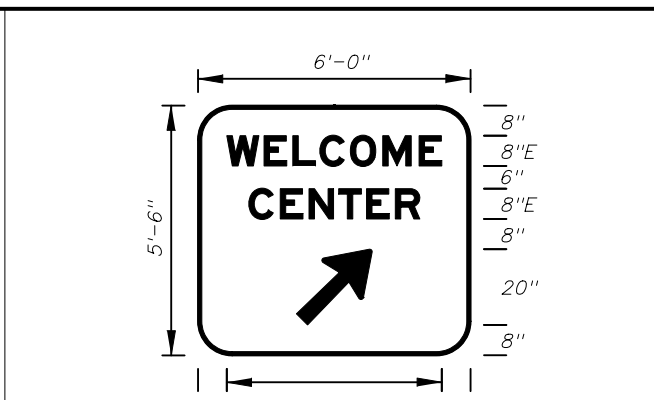

FTP-13-06  
6' 0" X 5'-6"  
9" Radii 2" Border  
8" Series E Legend  
Blue Background  
White Legend and Border

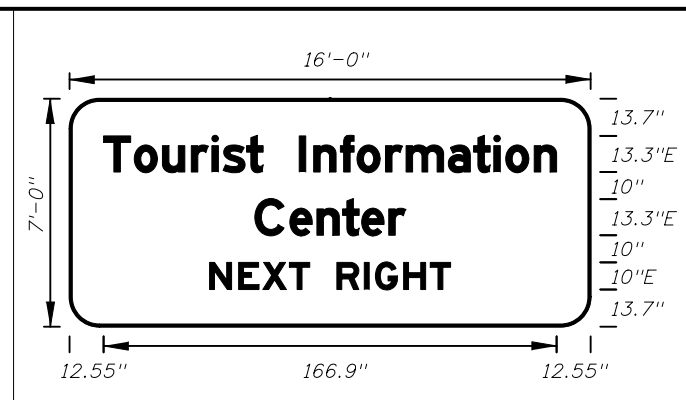

FTP-14-06  
16'-0" X 7'-0"  
11" Radii 2" Border  
13.3 and 10" Series E Legend  
Blue Background  
White Legend and Border

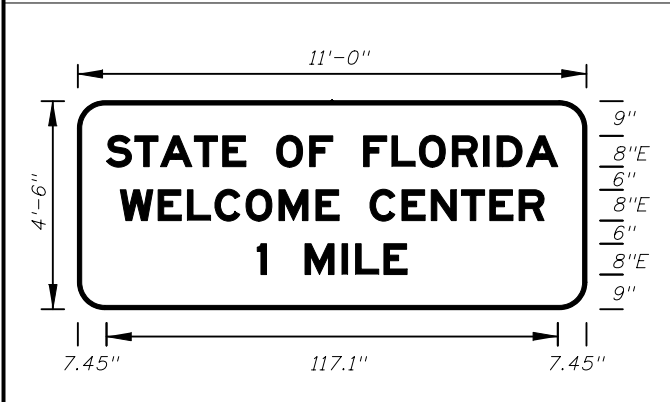

FTP-15A-06  
11'-0" X 4'-6"  
7" Radii 2" Border  
8" Series E Legend  
Blue Background  
White Legend and Border

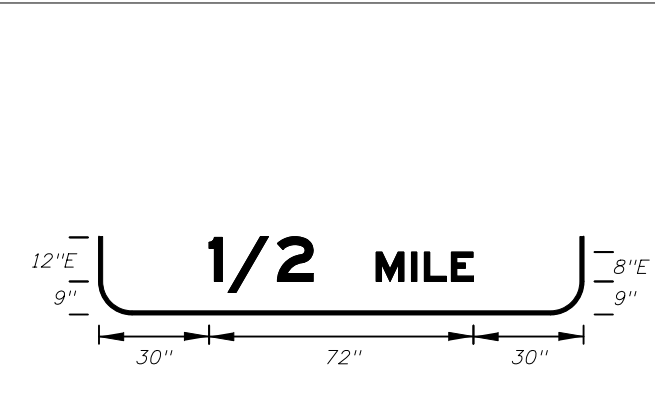

FTP-15B-06  
11'-0" X 5'-0"  
8" Radii 2" Border  
8" and 12" Series E Legend  
Blue Background  
White Legend and Border

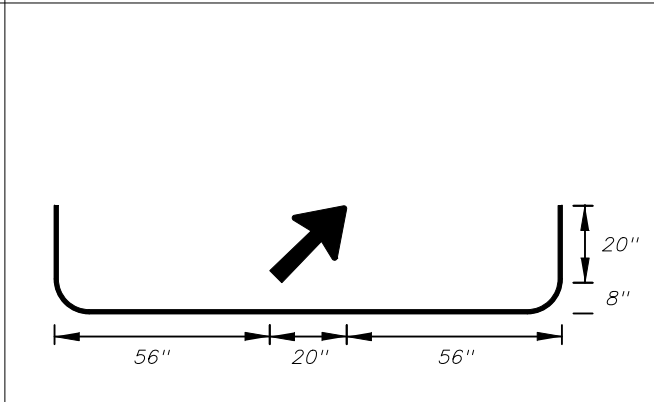

FTP-15C-06  
11'-0" X 5'-6"  
9" Radii 2" Border  
8" Series E Legend  
Blue Background  
White Legend and Border

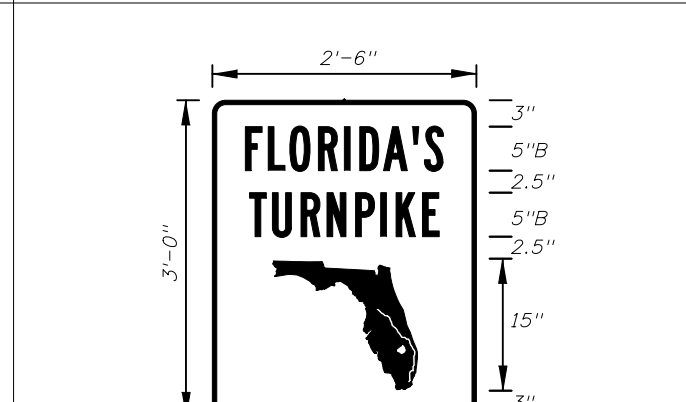

FTP-16-10  
2'-6" X 3'-0"  
1.5" Radii 3/4" Border  
5" Series B Legend  
Green Background  
White Legend, Border, and Florida Symbol

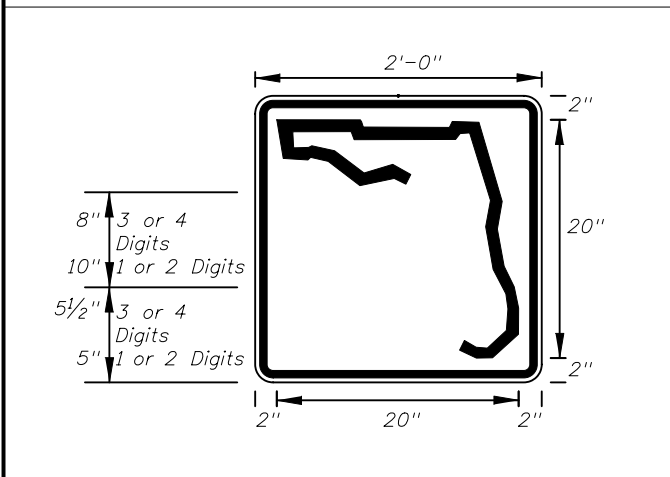

FTP-17-06  
2' X 2'  
1.13" Radii .0521" Border  
White Background  
Black Legend and Border  
See Sheet 3 of 11  
For Additional Details

	2010 Interim Design Standard	Interim Date 01/01/11	Sheet No. 2 of 11
	<b>SPECIAL SIGN DETAILS</b>	Index No. <b>17355</b>	

REVISIONS					
DATE	BY	DESCRIPTION	DATE	BY	DESCRIPTION
08/19/10	C.H.	Sign Detail FTP-16-06 was completely revised details were removed new removed new design was added as shown in FTP-16-10.			

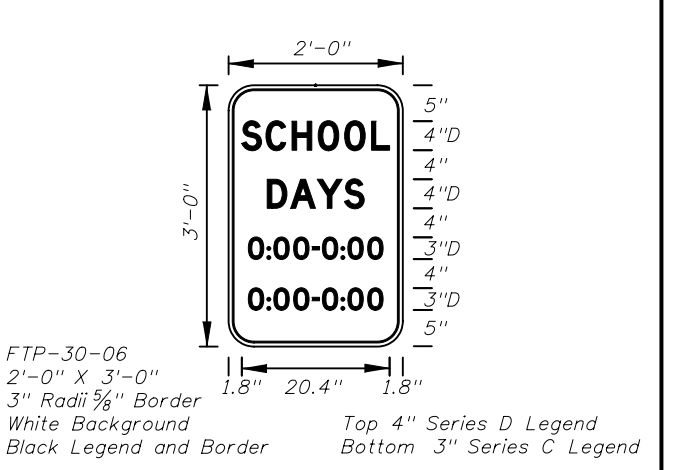
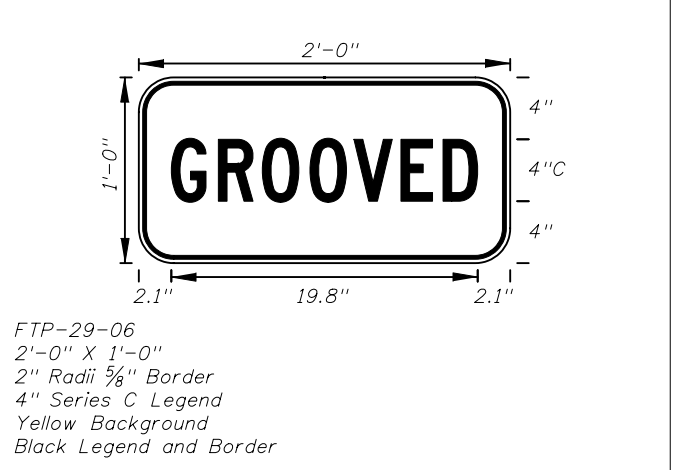
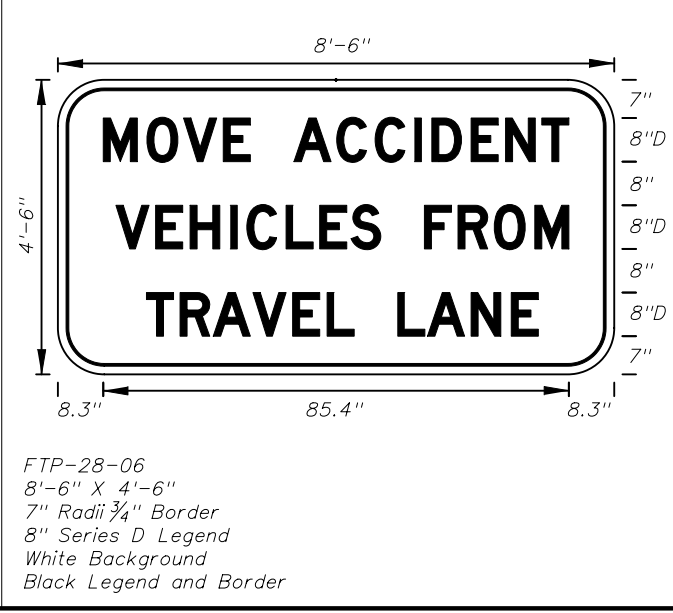
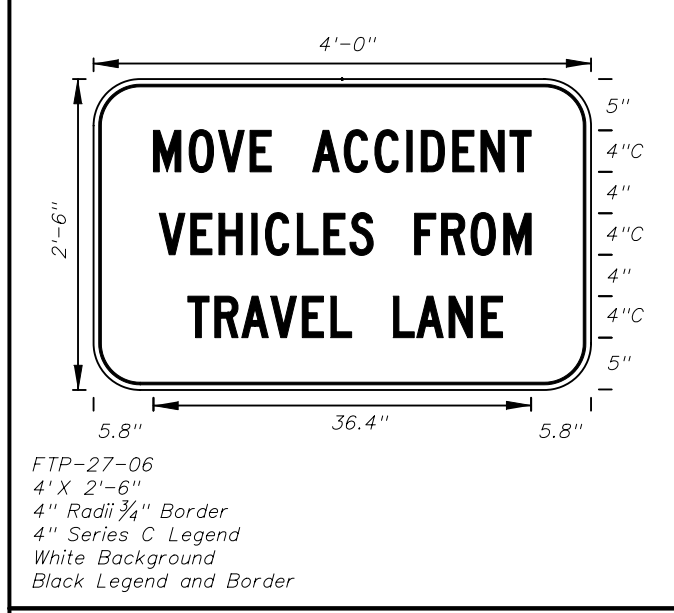
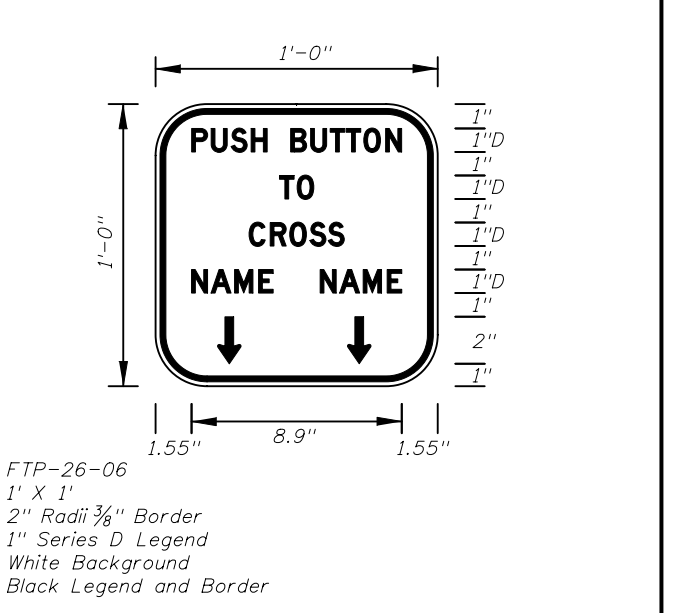
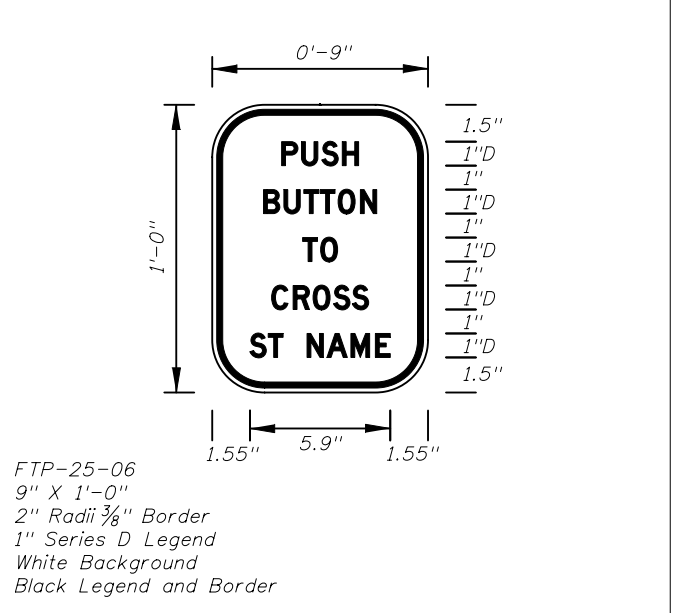
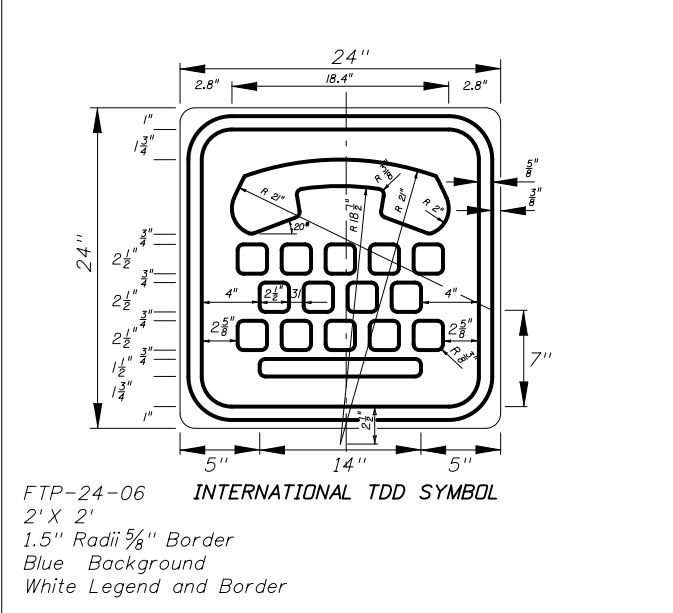
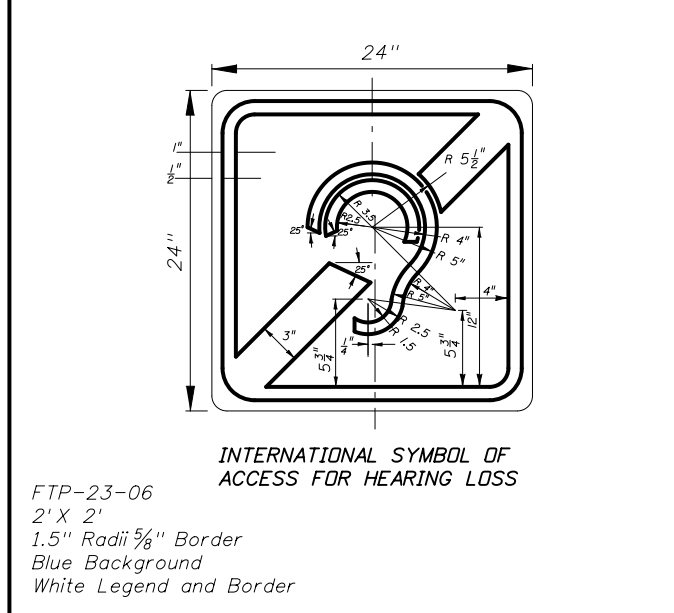
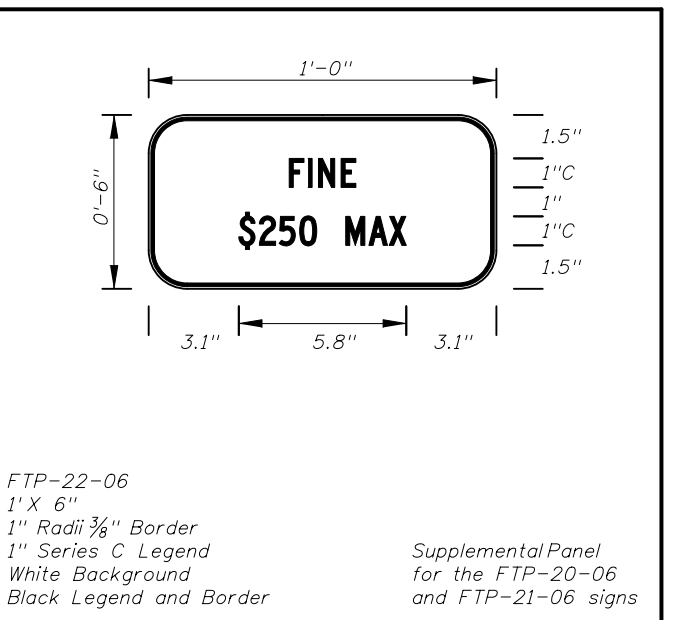
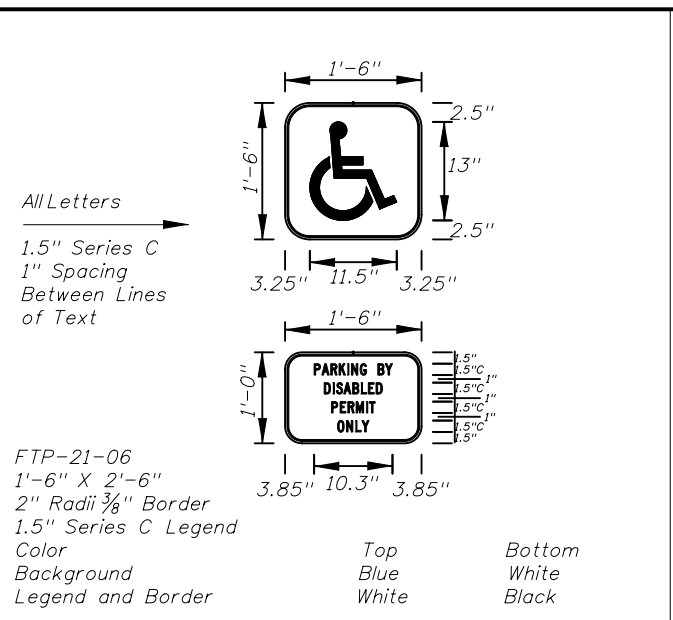
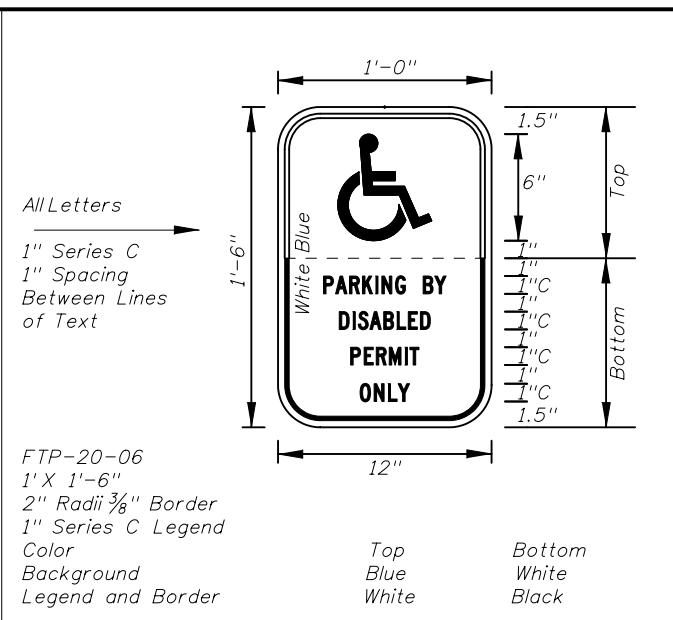
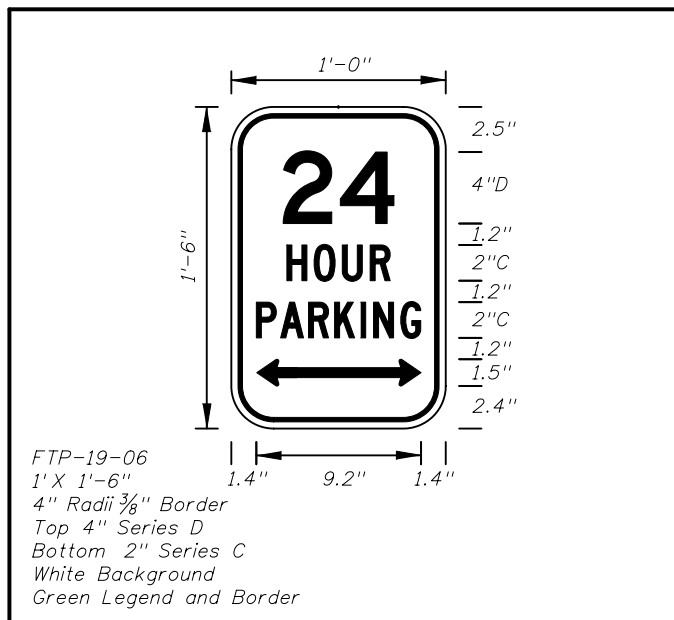

2010 Interim Design Standard

SPECIAL SIGN DETAILS

Interim Date 01/01/11  
Sheet No. 4 of 11  
Index No. 17355

REVISIONS					
DATE	BY	DESCRIPTION	DATE	BY	DESCRIPTION
08/05/10	C.H.	Changed Message on Sign No. FTP-22-06			

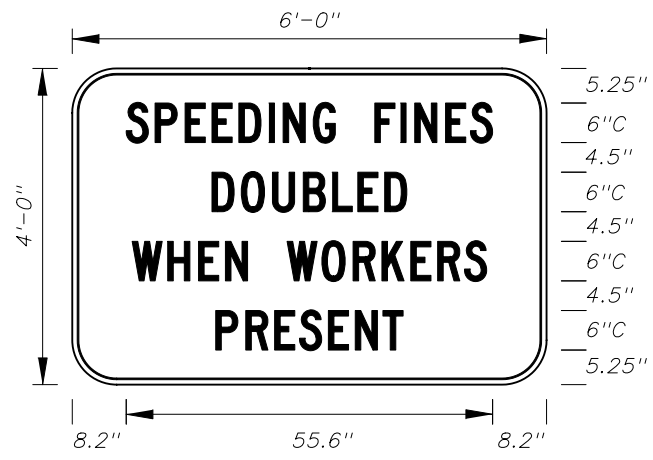

MDT-13-06 Freeway Sign  
6' X 4'  
6" Radii 3/4" Border  
6" Series C Legend  
White Background  
Black Legend and Border

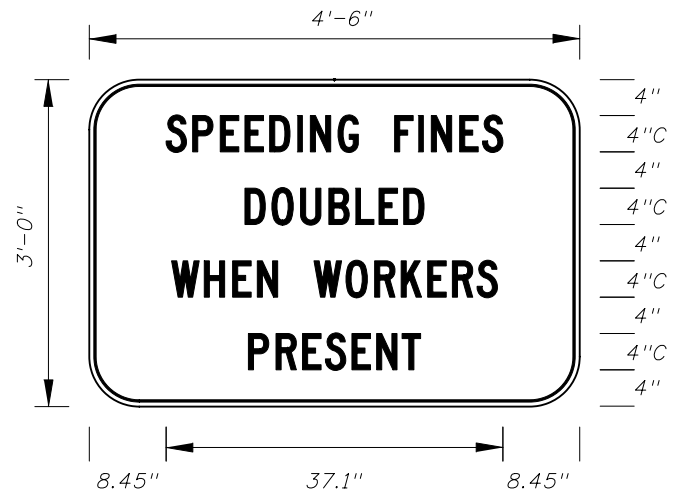

MDT-14-06 Arterial Sign  
4'-6" X 3'  
5" Radii 3/4" Border  
4" Series C Legend  
White Background  
Black Legend and Border

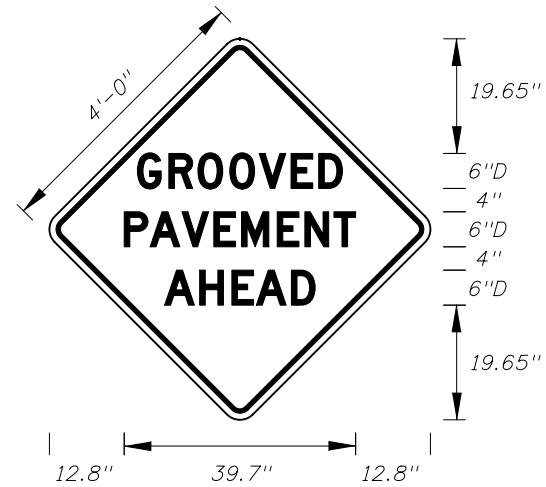

MDT-15-06  
4' X 4'  
2" Radii 3/4" Border  
6" Series D Legend  
Orange Background  
Black Legend and Border

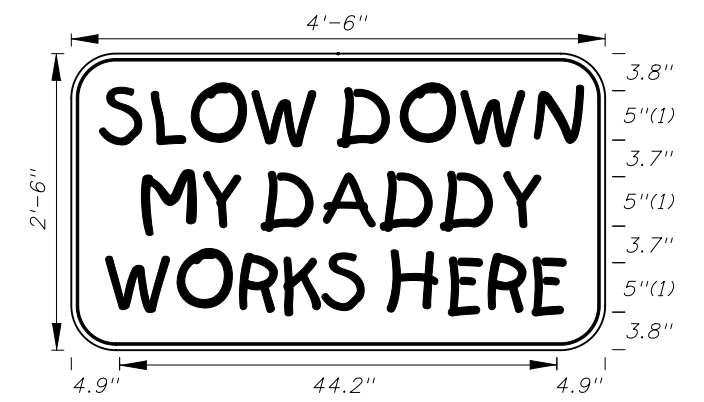

MDT-16-06  
4'-6" X 2'-6"  
4" Radii 3/4" Border  
5" Kids Series Legend  
Orange Background  
Black Legend and Border

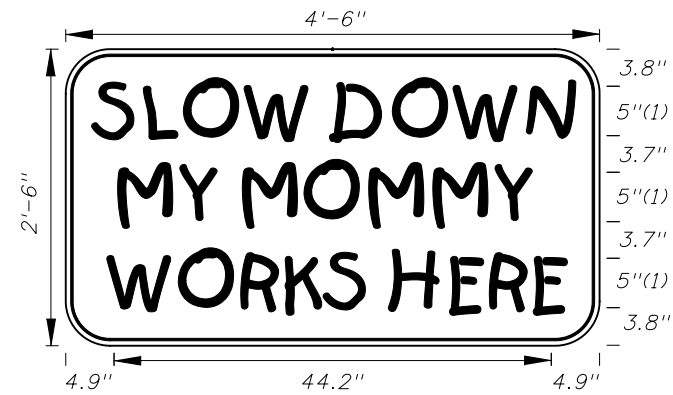

MDT-17-06  
4'-6" X 2'-6"  
4" Radii 3/4" Border  
5" Kids Series Legend  
Orange Background  
Black Legend and Border

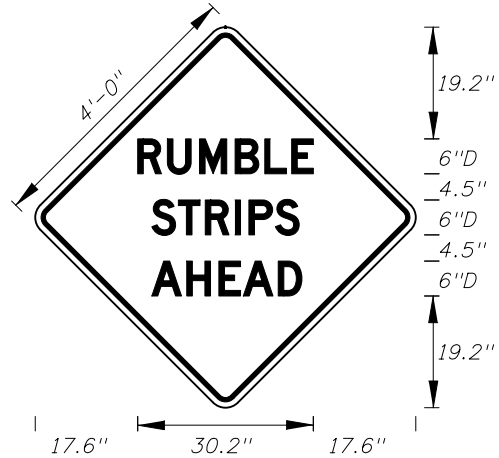

MDT-18-10  
4' X 4'  
2" Radii 3/4" Border  
6" Series D Legend  
Orange Background  
Black Legend and Border

REVISIONS

DATE	BY	DESCRIPTION	DATE	BY	DESCRIPTION
01/01/11	CA	Added sign MDT-18-10, RUMBLE STRIPS AHEAD.			

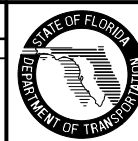

2010 Interim Design Standard

SPECIAL SIGN DETAILS

Interim Date  
01/01/11  
Sheet No.  
11 of 11  
Index No.  
17355