

**1" - 3 1/2" CALIPER TREE PLANTING**

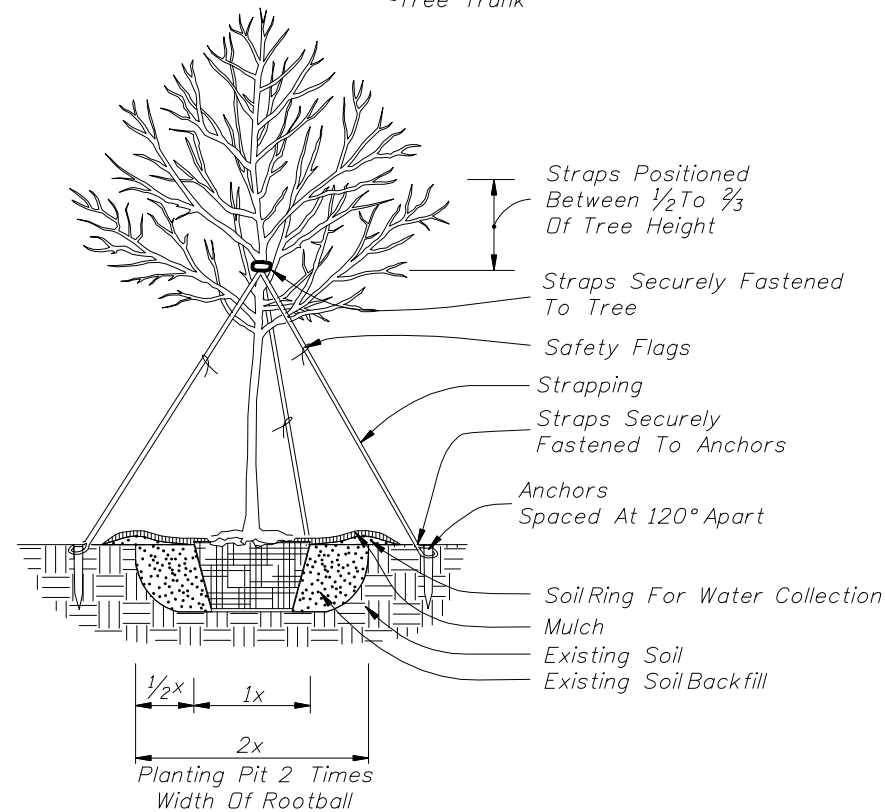

**4" AND LARGER CALIPER TREE PLANTING**

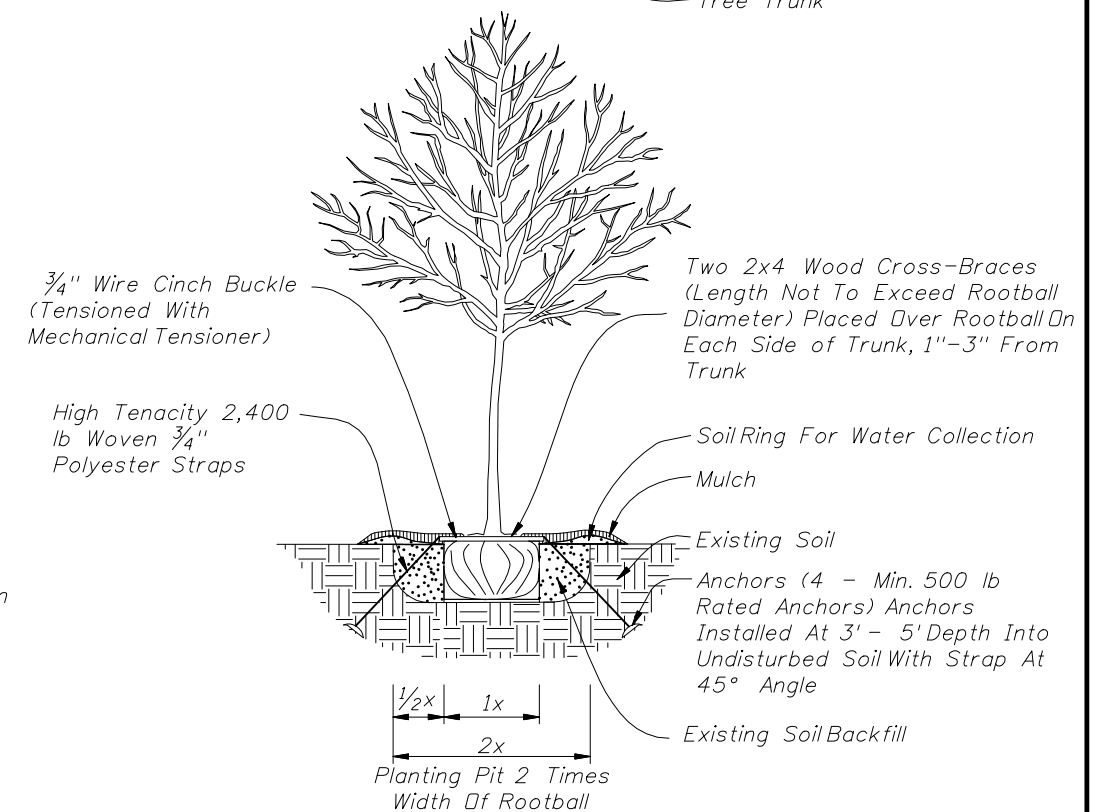

**1" - 3 1/2" CALIPER TREE PLANTING WITH UNDERGROUND BRACING**

**GENERAL NOTES:**

1. All dimensions 6" and less are exaggerated for illustrative purposes only.
2. Plant containers shall be removed prior to planting. If plants are not container grown, remove a minimum of the top 1/3 of burlap, fabric, or wire mesh. Never lift or handle the tree by the trunk.
3. The uppermost root on all trees shall be covered by less than 1" of soil. Use hand tools to carefully remove all excess soil. The top of root ball shall be set 1"-2" above finish grade and set plumb to the horizon. If planting pit is too deep, remove the tree and firmly pack additional soil in the bottom of the planting pit to raise the rootball. After positioning the tree in the planting pit, slice through rootballs with 3 or 4 vertical slices (top to bottom) equally distributed around the tree.
4. Backfill shall be loosened existing soil. Remove rocks, sticks, or other deleterious material greater than 1" in any direction prior to backfilling. Water and tamp to remove air pockets. If existing soils contain excessive sand, clay, or other material not conducive to proper plant growth, contact Engineer prior to planting.
5. Soilrings shall be constructed of existing soil at the outer edge of the planting pit, with a height of 3" and gently sloping sides. Do not pile soil on top of rootball.
6. Mulch shall be a 3" deep layer placed to the edge of the trunk flare, around the base of shrub, or solidly around groundcover. Never pile mulch against the tree trunk.
7. Straps shall be minimum 1" wide nylon or polypropylene. All wood stakes or anchors shall be located beyond the edge of soilring and located below finished grade, unless otherwise specified.
8. Sabal Palms may be hurricane cut. All other palms must have fronds tied with biodegradable twine. Palm trunks shall have no burn marks, scars, or sanding.
9. All dimensions provided for wood materials are nominal.
10. When a permanent, subsurface, or drip irrigation system is provided, a soilring is not required. Mulch to edge of planting pit.
11. Alternate tree bracing and guying systems approved by the Engineer may be used in lieu of the tree bracing and guying methods detailed on the Index. Alternate tree protection systems approved by the Engineer may be used in lieu of the tree protection barricade detailed on the index.
12. Remove aboveground guying systems at the end of the establishment period.



2010 FDOT Design Standards

**LANDSCAPE INSTALLATION**

Last Revision

07/01/07

Sheet No.

1 of 3

Index No.

**544**

2 x 4 Wood Braces (Minimum Of Three Wood Braces) Spaced At 120° Apart. Saw Cut Ends At Proper Angle To Allow For Flush Connection To Wood Batten. Nail Wood Braces Securely To Wood Batten

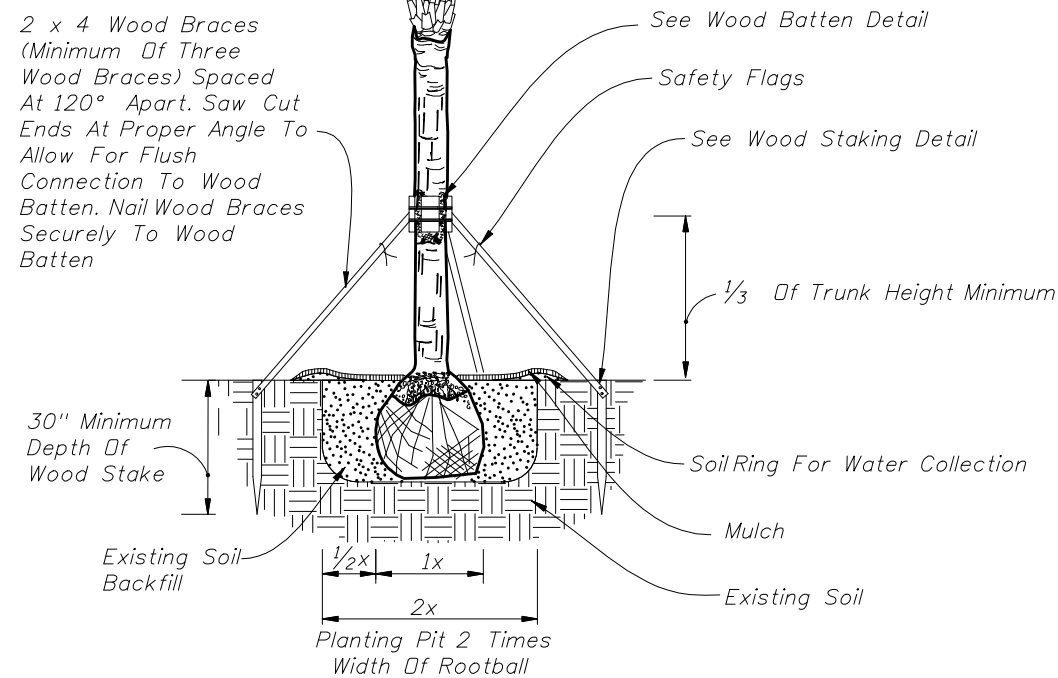

NOTE: For All Other Palms, Use Detail Provided By Landscape Architect In Contract Plans.

**CABBAGE PALM PLANTING FOR UP TO 24' CLEAR TRUNK**

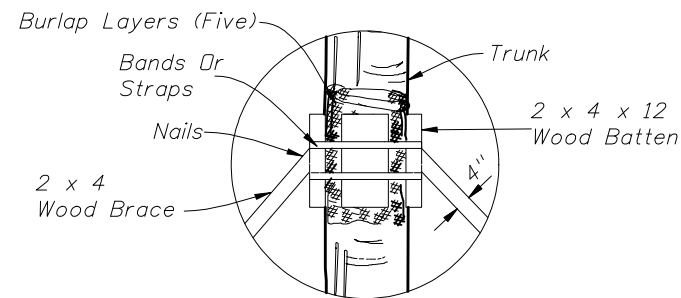

**WOOD BATTEN DETAIL**

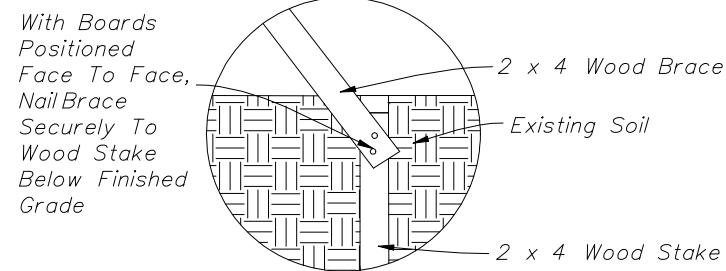

NOTE: Stake Into Firm, Existing Soil.

**WOOD STAKING DETAIL**

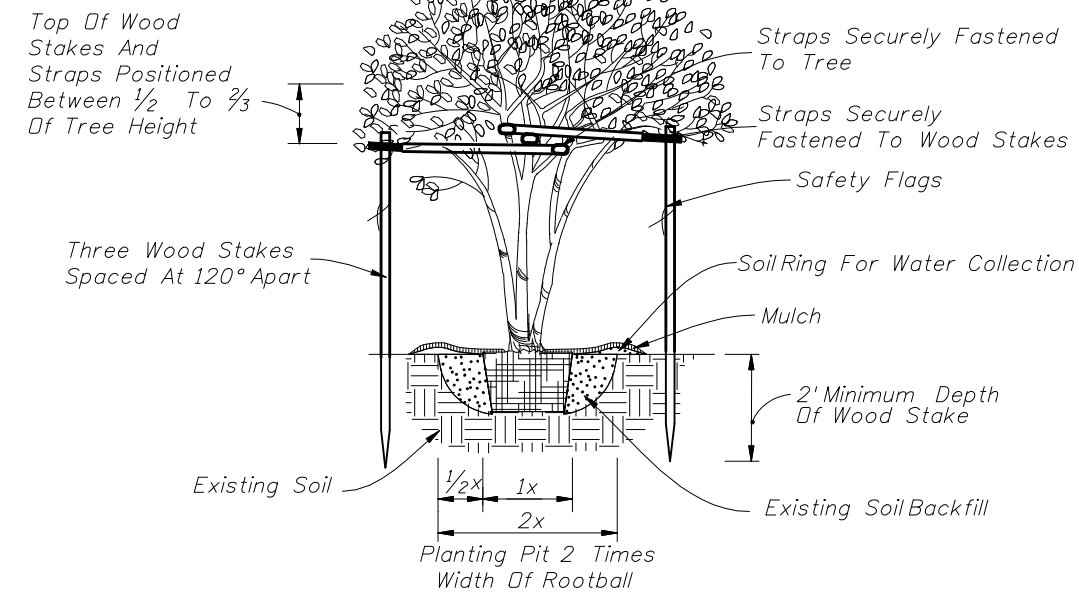
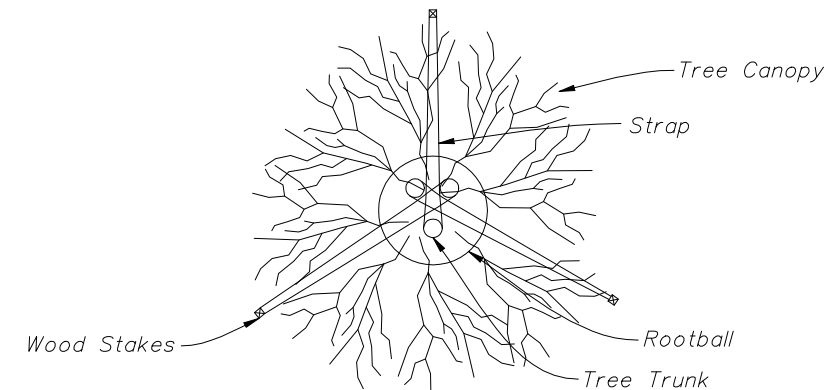

**MULTI-TRUNK TREE PLANTING**

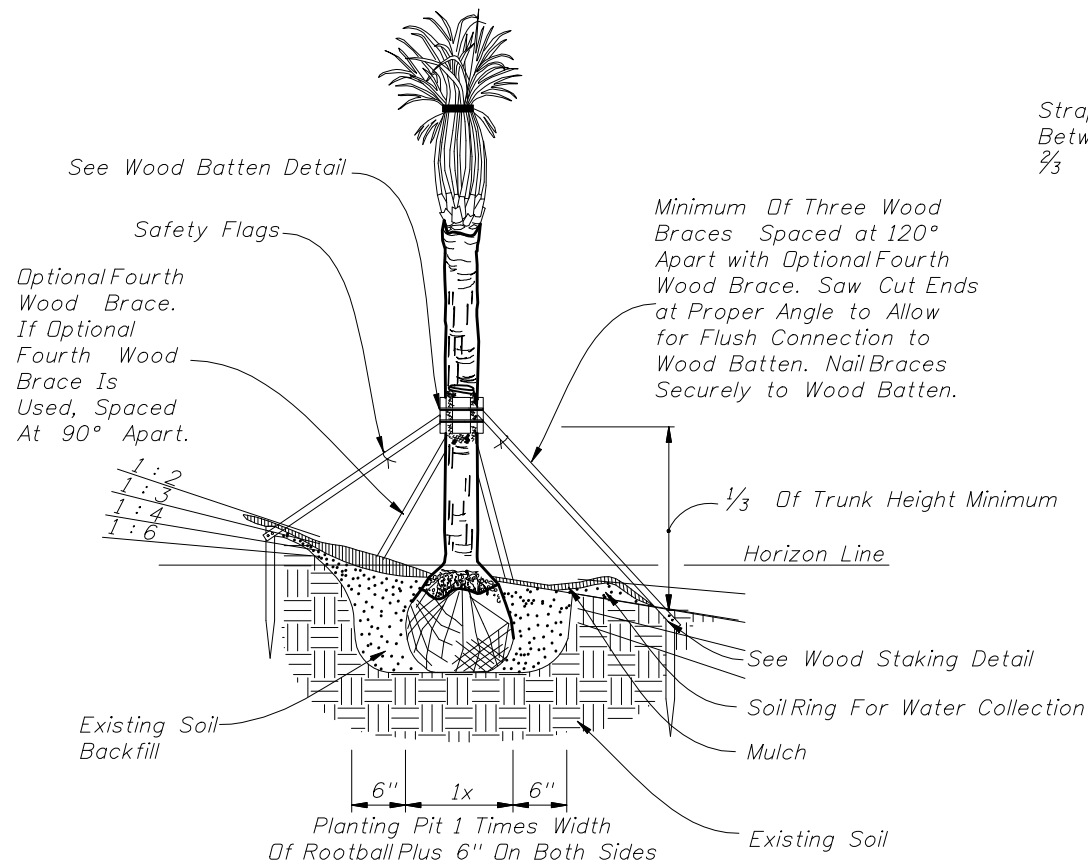

NOTES: Slope Provided As Rise:Run. For All Other Palms, Use Detail Provided By Landscape Architect In Contract Plans.

**CABBAGE PALM PLANTING ON SLOPE FOR UP TO 24' CLEAR TRUNK**

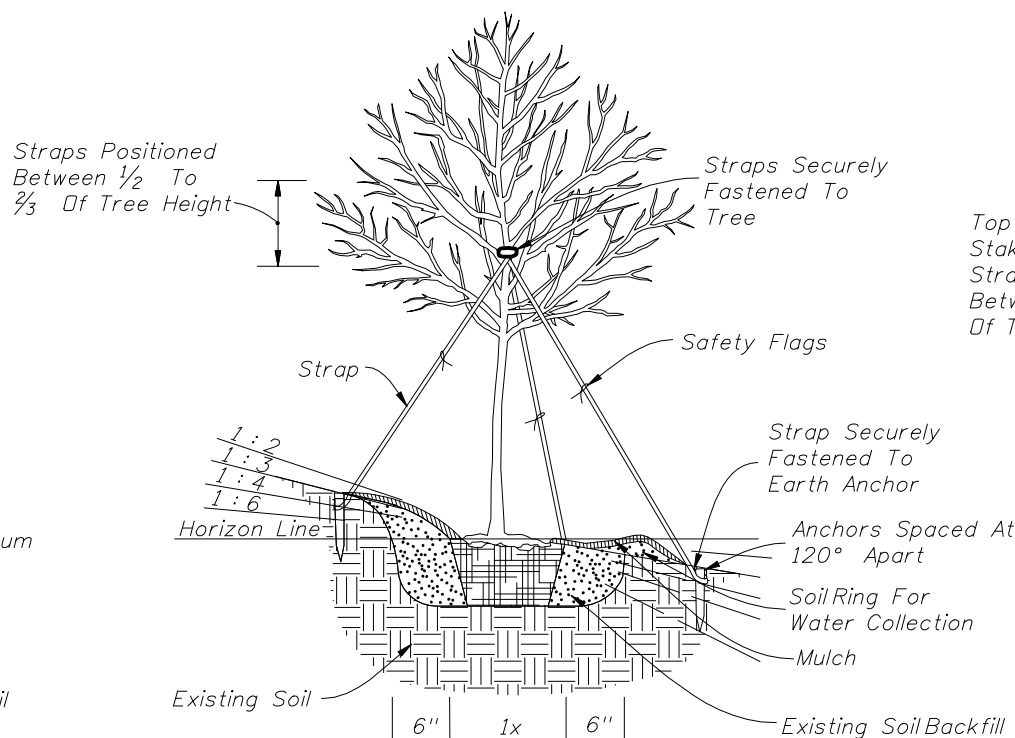

NOTE: Slope Provided As Rise:Run.

**4\"/>**

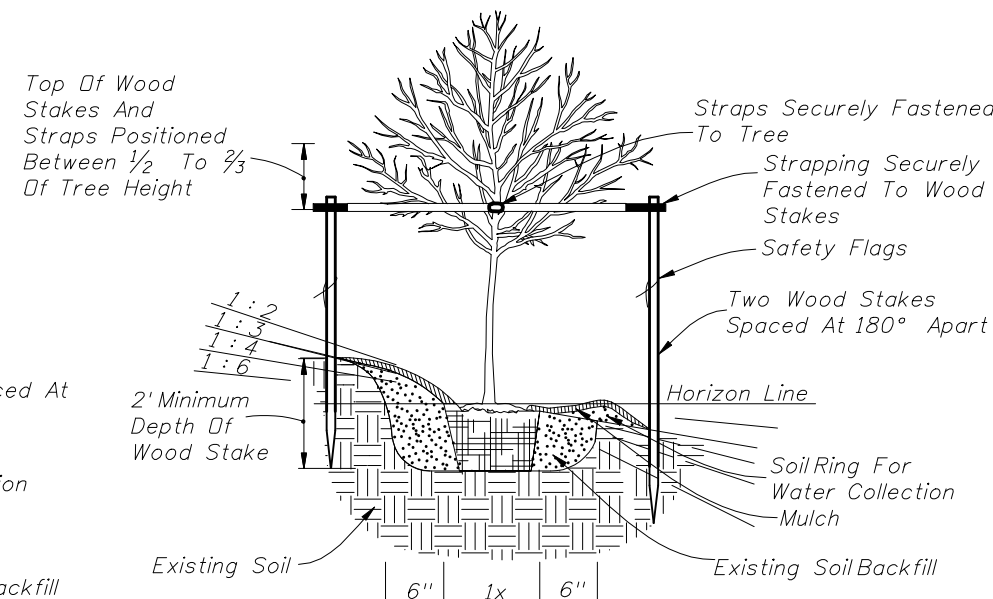

NOTE: Slope Provided As Rise:Run.

**1\"/>**



2010 FDOT Design Standards

**LANDSCAPE INSTALLATION**

Last Revision	Sheet No.
07/01/07	2 of 3
Index No.	
544	

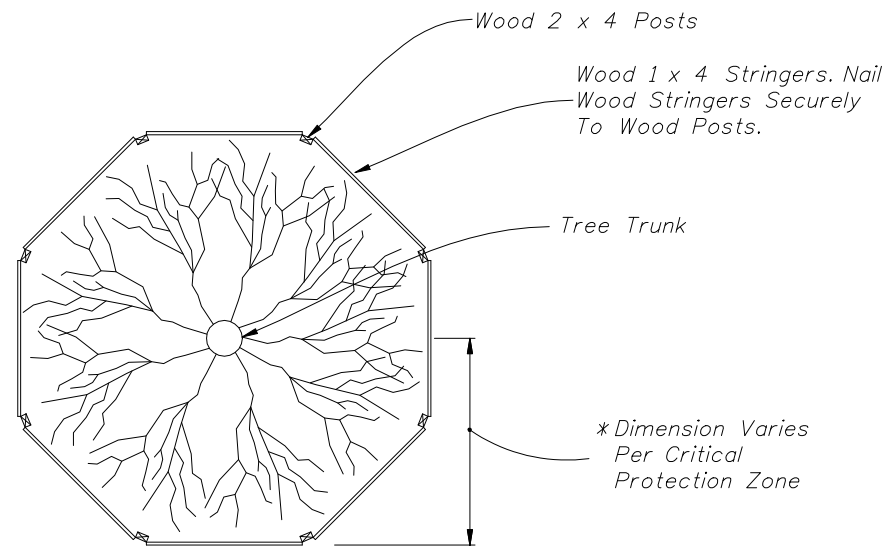

NOTE: For Groups Of Trees, Place Barricades Between Trees And Construction Activity.

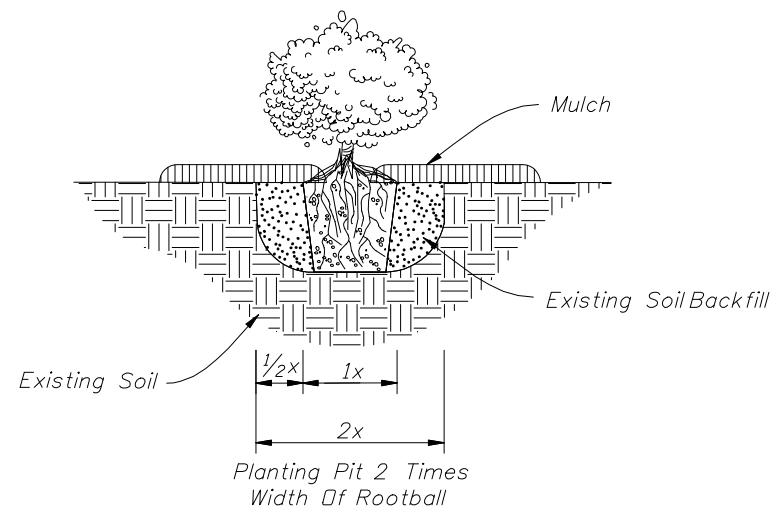

GROUND COVER/SHRUB PLANTING

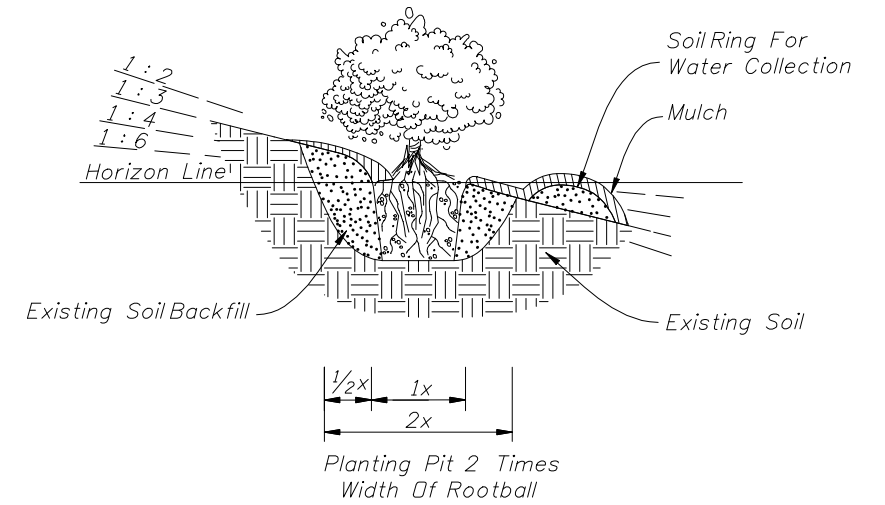

NOTE: Slope Provided As Rise:Run.

GROUND COVER/SHRUB PLANTING ON SLOPE

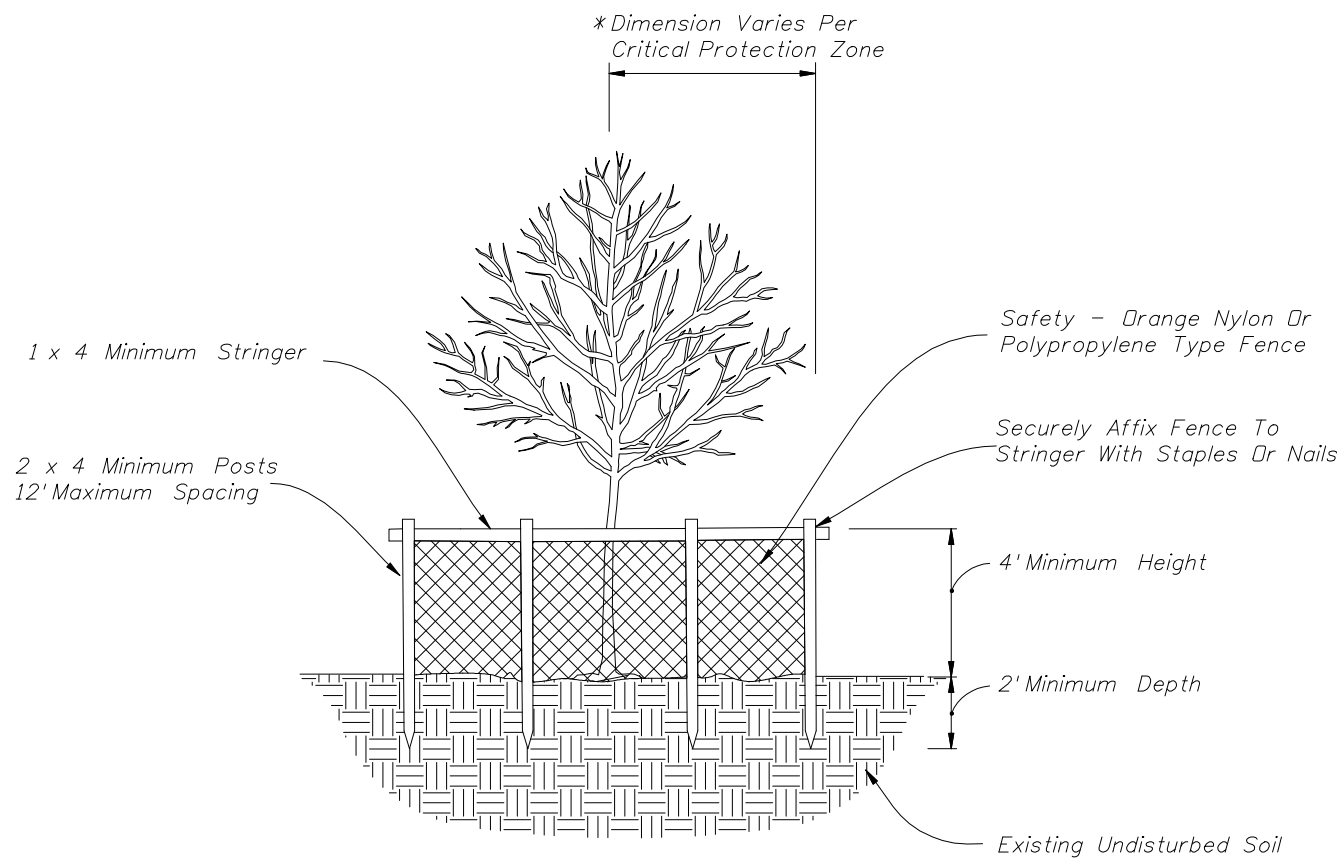

NOTES: Critical Protection Zone: The Area Surrounding A Tree Within A Circle Described By A Radius Of One Foot For Each Inch Of The Tree Trunk Diameter At 54" Above Finished Grade. For Groups Of Trees, Place Barricades Between Trees And Construction Activity.

\* Tree Protection Barricades Shall Be Located To Protect A Minimum Of 75% Of The Critical Protection Zone.

TREE PROTECTION BARRICADE

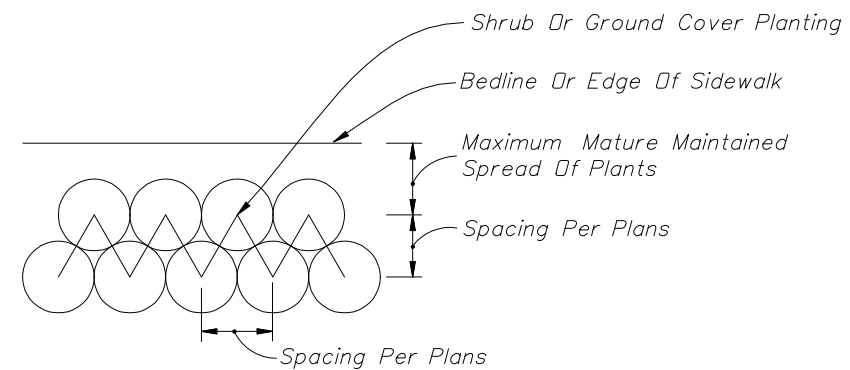

GROUND COVER/SHRUB LAYOUT DETAIL

