

SOP 1

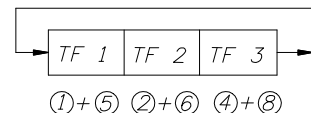

SOP 2

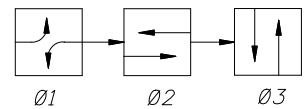
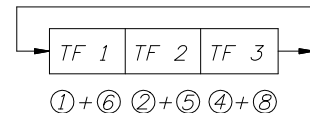
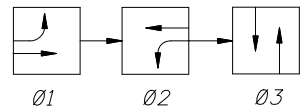

SOP 3

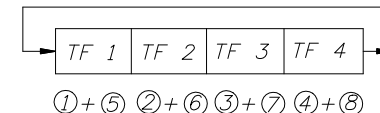
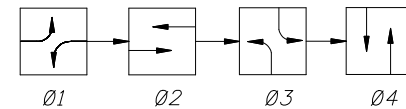

SOP 4

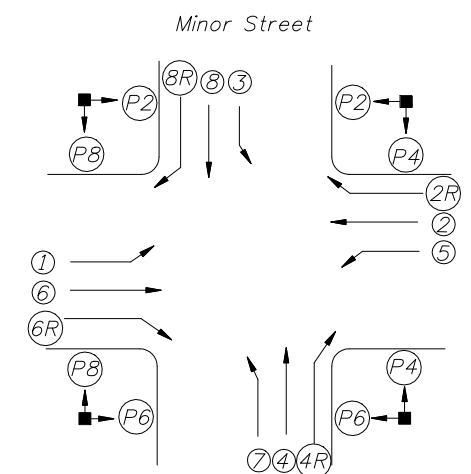

**SIGNALIZED INTERSECTION**

Vehicle movements & signalhead number assignments are not directionally oriented but shall maintain their relative orientation about the intersection (I.E., movements 7 and 4 are always to the right of movements 1 and 6 etc.).

**LEGEND**

- ⊗ Vehicle Movement Number
- ⊗(P) Pedestrian Movement Number
- TF X Timing Function Number
- ØX Phase Number
- ↔ Green Arrow (Left or Right)
- ↔ Red Arrow
- ↔ Yellow Arrow

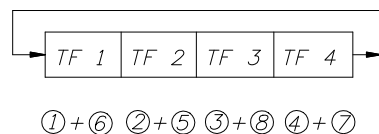
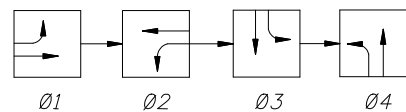

SOP 5

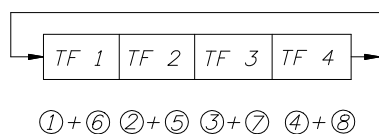
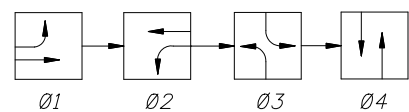

SOP 6

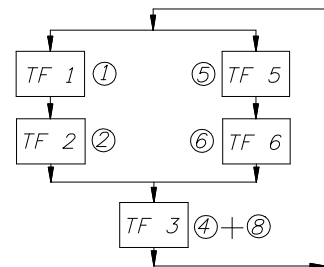
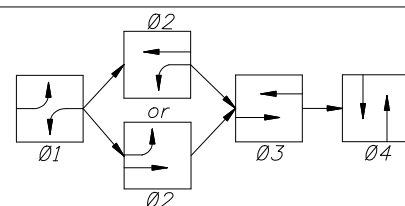

SOP 7

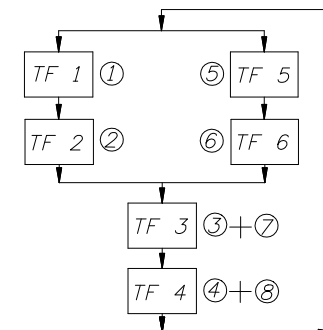
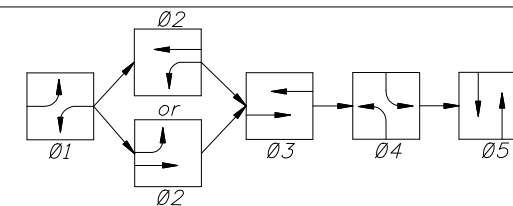

SOP 8

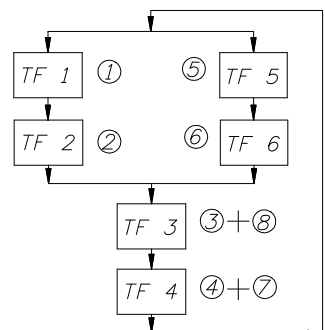
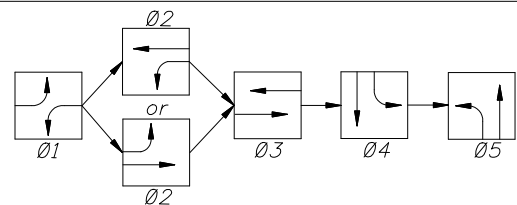

SOP 9

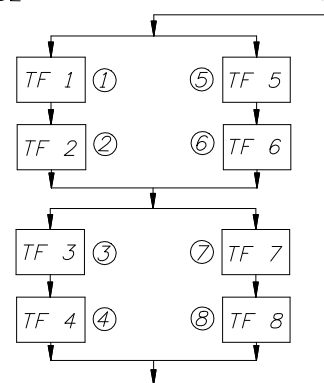
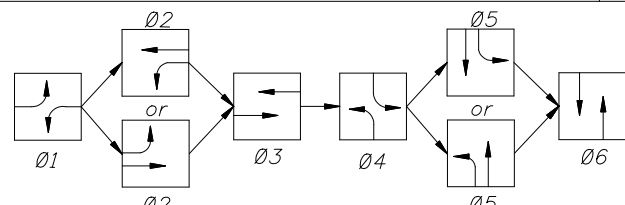

SOP 10

**SIGNAL CLEARANCE TABLE**  
(Blank Indicates No Clearance Required)

From \ To	SIGNAL INDICATIONS						
	R	↔	G	↔	↕	WALK	DONT WALK
R			Y	↔	Y		
↔			Y	↔	Y		
G				↔			
↔							
↕							
WALK							
DONT WALK						Flash	DONT WALK



2008 FDOT Design Standards

**STANDARD SIGNAL OPERATING PLANS**

Last Revision: 07/01/05  
Sheet No.: 1 of 2  
Index No.: 17870

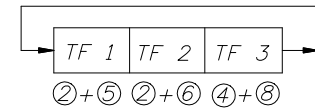
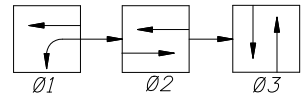

SOP 11

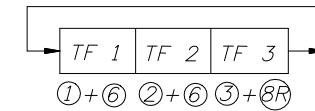
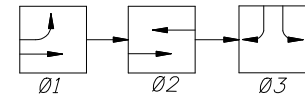

SOP 12

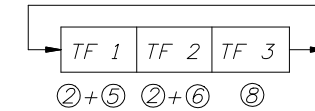
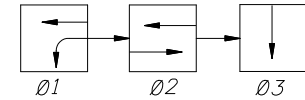

(ONE-WAY STREET INTERSECTION) SOP 13

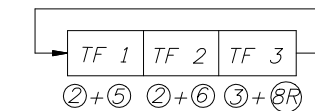
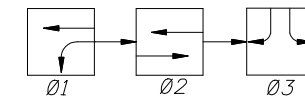

(DIAMOND INTERCHANGE OPERATION) SOP 14

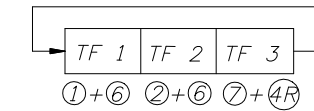
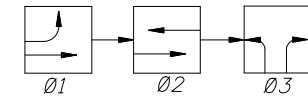

(DIAMOND INTERCHANGE OPERATION) SOP 15

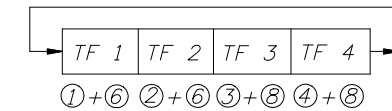
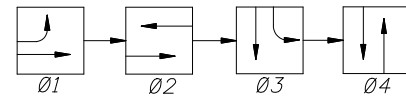

SOP 16

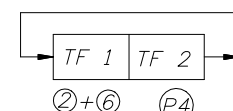
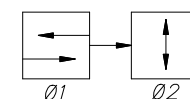

(MIDBLOCK) SOP 17

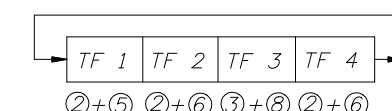
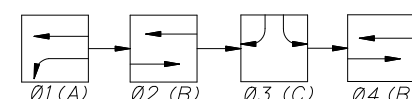

NOTE:  
Only Ø2 Or Ø4 Used, Not Both To Obtain ABC, Or ACB Operation.

(DIAMOND INTERCHANGE OPERATIONS) SOP 18

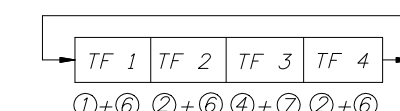
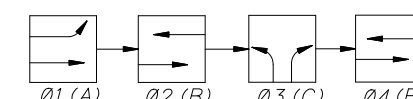

NOTE:  
Only Ø2 Or Ø4 Used, Not Both To Obtain ABC, Or ACB Operation.

(DIAMOND INTERCHANGE OPERATIONS) SOP 19

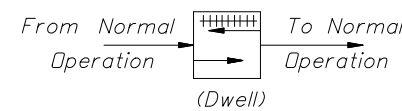

POP 1

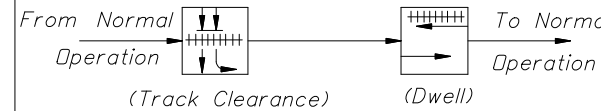

POP 2

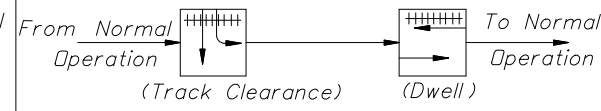

POP 3

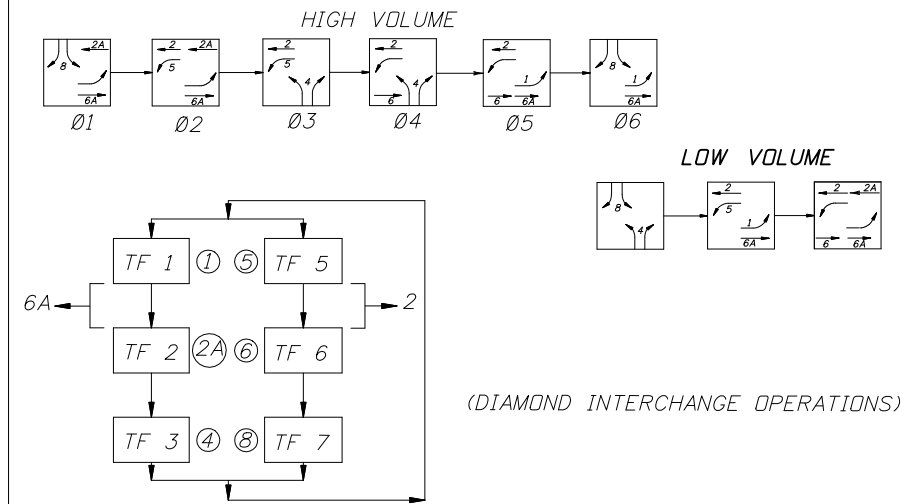

SOP 20

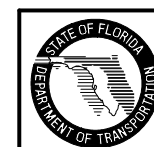

2008 FDOT Design Standards

STANDARD SIGNAL OPERATION PLAN

Last Revision: 07/01/00  
Sheet No.: 2 of 2  
Index No.: 17870