

T & B STRUCTURAL SYSTEMS

GABION WIRE WALL SYSTEM

GENERAL NOTES

DESIGN CRITERIA

1. THE ATTACHED DETAILS ARE BASED ON THE ASSUMPTIONS THAT THE MATERIAL WITHIN THE REINFORCED VOLUME, METHODS OF CONSTRUCTION AND QUALITY OF PREFABRICATED COMPONENTS MEET T&B STRUCTURAL SYSTEMS SPECIFICATION FOR RETAINING WALL SYSTEMS

2. MINIMUM DESIGN PARAMETERS

REFERENCE WALL CONTROL DRAWINGS FOR SOIL CHARACTERISTICS OF FOUNDATION MATERIAL TO BE USED IN THE DESIGN OF THE WALL SYSTEM. THE CONTRACTOR SHALL PROVIDE SOIL DESIGN PARAMETERS FOR BACKFILL MATERIAL BASED ON ACTUAL SOIL CHARACTERISTICS UTILIZED AT THE SITE. THE VALUES OF THE INTERNAL FRICTION ANGLE, ϕ , THE COHESION, c , AND THE UNIT WEIGHT, γ , SHALL BE PROVIDED IN THE SHOP DRAWINGS.

FACTORS OF SAFETY

EXTERNAL STABILITY

OVERTURNING ≥ 2.0
 SLIDING ≥ 1.5
 BEARING PRESSURE ≥ 2.5

OVERALL STABILITY ≥ 1.5

INTERNAL STABILITY

PULLOUT ≥ 1.5
 STEEL YIELD STRESS = $0.48 F_y$

SERVICE LIFE = GREATER OF 3 YEARS OR DURATION OF CONTRACT

LIVE LOAD SURCHARGE = 250 PSF

3. THE MAXIMUM APPLIED BEARING PRESSURE AT THE INTERFACE OF THE FOUNDATION AND SELECT BACKFILL MATERIAL IS SHOWN IN THE CALCULATIONS. THE BEARING PRESSURE SHOWN IS THE MAXIMUM FOR THE GIVEN BASE MAT LENGTH. IT IS THE RESPONSIBILITY OF OTHERS TO DETERMINE THAT THE BEARING PRESSURE IS ALLOWABLE FOR THAT LOCATION.

4. ANY UNSUITABLE FOUNDATION MATERIAL BELOW THE REINFORCED VOLUME AS DETERMINED BY THE ENGINEER SHALL BE EXCAVATED AND REPLACED WITH SUITABLE MATERIAL AS DIRECTED BY THE ENGINEER.

5. THE DESIGN CONTAINED ON THESE DRAWINGS ARE BASED ON INFORMATION PROVIDED BY OTHERS. ON THE BASIS OF THIS INFORMATION, T&B STRUCTURAL SYSTEMS IS RESPONSIBLE FOR THE INTERNAL STABILITY OF THE STRUCTURE ONLY. EXTERNAL STABILITY, INCLUDING FOUNDATION AND SLOPE STABILITY IS THE RESPONSIBILITY OF OTHERS.

WALL CONSTRUCTION

1. WALLS FOUNDED ON CURVES SHALL HAVE THEIR PANELS DIMENSIONED AS A SERIES OF SHORT CORDS (AS DIMENSIONED) IN ORDER TO MATCH THE REQUIRED WALL RADIUS.

2. FOR LOCATION AND ALIGNMENT OF THE MSE STRUCTURES REFERENCE THE RETAINING WALL CONTROL PLANS.

3. IF MANHOLE AND DROP INLETS ARE REQUIRED, THEY SHALL BE LOCATED AS SHOWN ON THE RETAINING WALL ELEVATION DRAWINGS.

4. IF PILES ARE LOCATED WITHIN THE REINFORCED VOLUME THEY SHALL BE DRIVEN PRIOR TO CONSTRUCTION OF THE WALL UNLESS AN ALTERNATE METHOD IS USED TO ISOLATE THE COLUMNS FROM THE REINFORCED VOLUME AS APPROVED BY THE ENGINEER.

5. BACKFILL MATERIAL SHALL BE COMPACTED IN ACCORDANCE WITH SECTION 548. NO SOIL REINFORCEMENT SHALL BE ATTACHED TO ANY PANEL BEFORE THE BACKFILL IS PLACED AT THE REQUIRED ELEVATION AND IS COMPACTED.

6. STRUCTURES GREATER THAN 20 FEET SHALL HAVE THE FINISHED GRADE PLACED AND COMPACTED AT THE FRONT FACE OF THE STRUCTURE BEFORE THE STRUCTURE HEIGHT EXCEEDS 20 FEET. THE FINISH GRADE SHALL BE COMPACTED TO 95 PERCENT OF AASHTO T-180 UNLESS OTHERWISE DIRECTED BY THE ENGINEER.

7. IT IS THE RESPONSIBILITY OF THE CONTRACTOR TO LOCATE ANY GUARDRAIL POSTS PRIOR TO PLACING THE TOP ROW OF SOIL REINFORCEMENT. THE POST SPACING SHALL BE ADJUSTED TO AVOID CONFLICTS WITH THE LONGITUDINAL SOIL REINFORCING WIRE. CUTTING OF THE LONGITUDINAL WIRE SHALL BE ALLOWED ONLY AS DIRECTED BY THE ENGINEER.

8. IF EXISTING OR FUTURE STRUCTURES ARE TO BE PLACED IN THE REINFORCED VOLUME THAT INTERFERE WITH THE PROPER PLACEMENT OF THE SOIL REINFORCEMENT THE CONTRACTOR SHALL NOTIFY THE ENGINEER IMMEDIATELY FOR A COURSE OF ACTION.

9. THE CAP MAT SHALL BE PLACED AS CLOSE TO THE TOP OF WALL LOCATION AS POSSIBLE. THE REMAINING FACE PANEL ABOVE THE CAP MAT MAY BE CUT FREE.

10. FOR OTHER INFORMATION PERTAINING TO THE CONSTRUCTION OF THE TBSS RETAINING WALL PLEASE REFER TO T&B STRUCTURAL SYSTEMS ERECTION MANUAL.

11. IT IS THE RESPONSIBILITY OF THE THE CONTRACTOR TO DEFLECT THE TOP CAP MAT OF THE SOIL REINFORCEMENT DOWNWARD SO AS TO AVOID CONFLICT WITH ROADWAY MIXING OPERATIONS AND/OR ROADWAY CONSTRUCTION OPERATIONS. ANY SOIL REINFORCING MATERIAL THAT IS DAMAGED SHALL BE REPLACED AT THE CONTRACTORS EXPENSE.

CONSTRUCTION NOTES

1. NOMINAL SOIL REINFORCING GRID LENGTH

THE WELDED WIRE MESH IS MANUFACTURED IN LENGTHS CORRESPONDING TO THE DIMENSION "B" AS GIVEN IN THE RETAINING WALL ELEVATIONS. THE ACTUAL LENGTH FROM THE FRONT FACE OF THE PANEL TO THE TAIL OF THE SOIL REINFORCING GRID IS PLUS 2"-4" THE FOUNDATION SHALL BE EXCAVATED TO AN EXTENT OF "B" PLUS 6".

2. THE FOLLOWING MATERIALS ARE SUPPLIED BY T&B STRUCTURAL SYSTEMS INC.

- WELDED WIRE FACING PANEL AND SOIL REINFORCING GRID
- BACKING PANEL
- CAP MATS
- HOG RINGS AND PLIERS
- NONWOVEN GEOTEXTILE FILTER FABRIC

ANY OTHER MATERIAL REQUIRED TO BUILD THE MSE STRUCTURES ACCORDING TO THE GOVERNING SPECIFICATION SHALL BE SUPPLIED BY THE CONTRACTOR.

3. T&B STRUCTURAL SYSTEMS INC. SUPPLIES MECHANICALLY STABILIZED EARTH STRUCTURAL COMPONENTS FOR USE WITH THE TBSS WELDED WIRE WALL SYSTEM FOR THE STRUCTURES DETAILED HEREIN. THE ERECTION MANUAL PROVIDED BY T&B STRUCTURAL SYSTEMS IS A GENERAL GUIDELINE FOR ERECTING THE TBSS WELDED WIRE WALL SYSTEM. ALL QUALITY CONTROL PROCEDURES, STAGING PROCEDURES, MATERIAL HANDLING, AND SAFETY IS THE RESPONSIBILITY OF THE CONTRACTOR. THIS DOES NOT RELIEVE THE CONTRACTOR OF THE OBLIGATION TO CONSTRUCT THE RETAINING WALL ACCORDING TO THE PROJECT PLANS AND SPECIFICATIONS AND ALL LAWS OF THE GOVERNING STATE.

DATE : 01-01-05

T&B STRUCTURAL SYSTEMS, INC
ENGINEERED STRUCTURES
 637 WEST HURST BLVD.
 HURST, TEXAS 76053
 (817) 280-9858 • (FAX) 280-9864

INTERIM STANDARD IN ENGLISH UNITS
 APPLICABLE TO DESIGN STANDARDS
 BOOKLET PUBLISHED IN EITHER ENGLISH
 OR METRIC UNITS.

TBSS CLAIMS ALL PROPRIETARY RIGHTS TO ALL DRAWINGS, SPECIFICATIONS AND METHODOLOGIES CONTAINED HEREIN. THE USE OF THIS INFORMATION IS RESTRICTED TO APPROPRIATE PROJECTS THAT IT WAS PREPARED FOR. NO REPRODUCTION, IN PART, OR IN WHOLE, MAY BE MADE WITHOUT WRITTEN INSTRUCTION FROM TBSS.

STATE OF FLORIDA DEPARTMENT OF TRANSPORTATION

RETAINING WALL SYSTEMS
 T&B STRUCTURAL SYSTEMS, INC.
 GABION WIRE WALL

INTERIM STANDARD

APPROVED BY

William N. Nickas, P.E.

State Structures Design Engineer

Index No. 5130 (Sheets 1-5 of 5 is a supplement to the metric Roadway and Traffic Design Standards Booklet dated January 2000.

Revision No.

Sheet No.

Index No.

04

1 of 5

5110

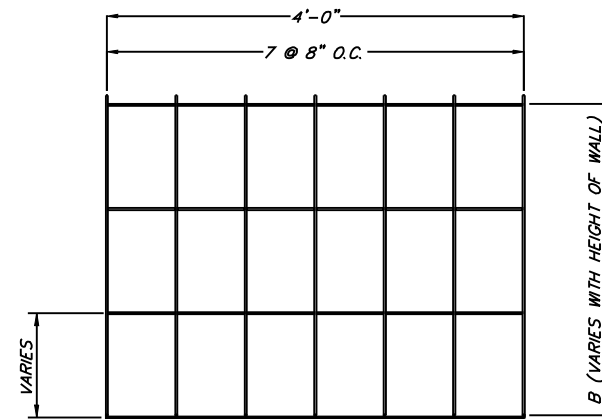

A
2 **PLAN VIEW SOIL REINFORCING**
N.T.S.

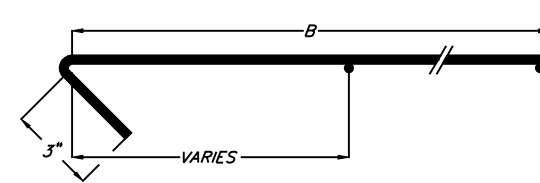

D
2 **SECTION CAP MAT**
N.T.S.

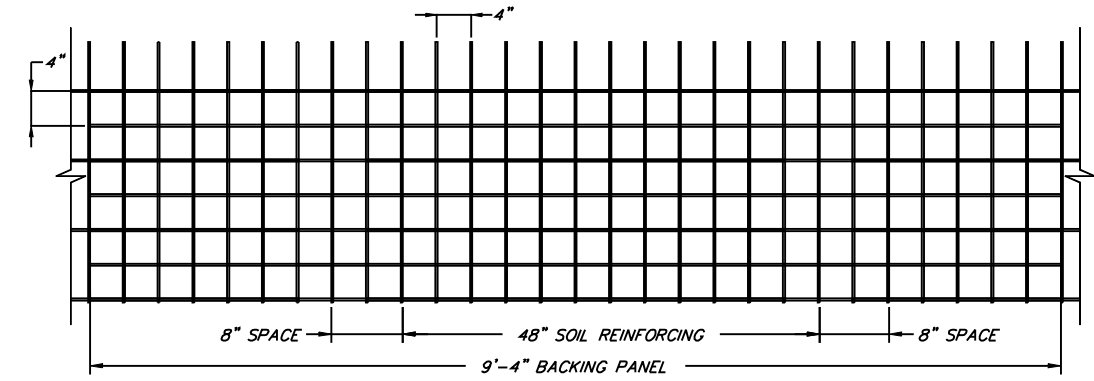

G
2 **ASSEMBLED WALL ELEVATION**
N.T.S.

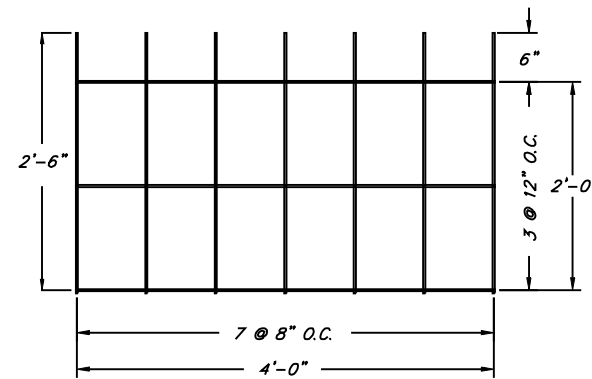

B
2 **ELEVATION SOIL REINFORCING**
N.T.S.

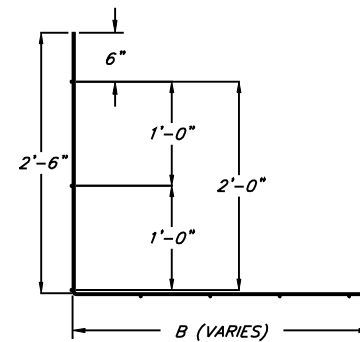

E
2 **SECTION SOIL REINFORCING**
N.T.S.

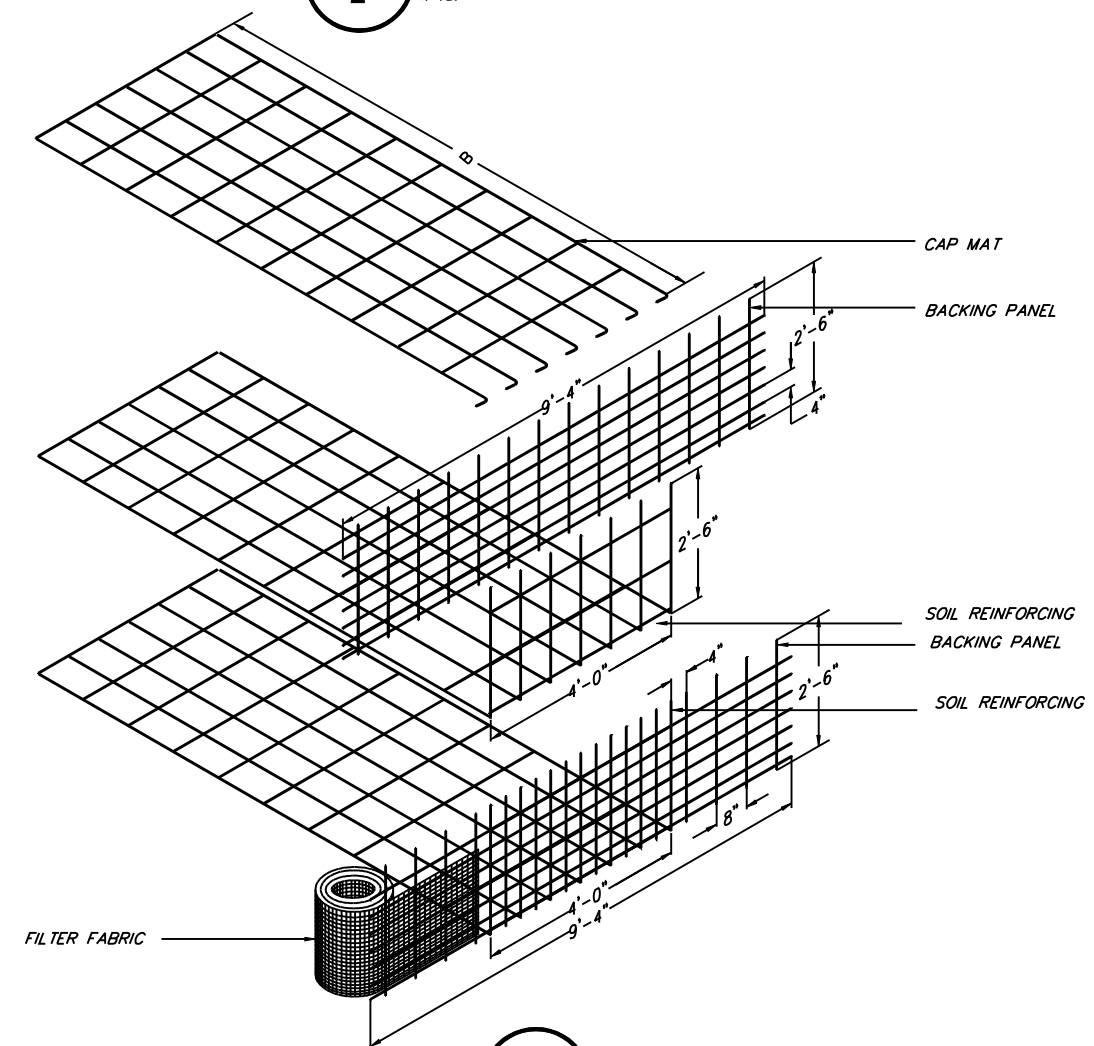

H
2 **COMPONENT ISOMETRIC**
N.T.S.

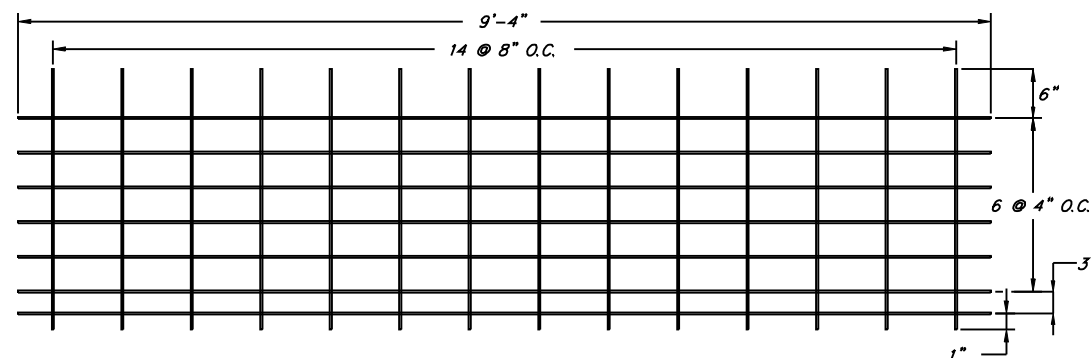

C
2 **ELEVATION BACKING PANEL**
MINIMUM WIRE SIZE IS W4.5 BOTH DIRECTIONS

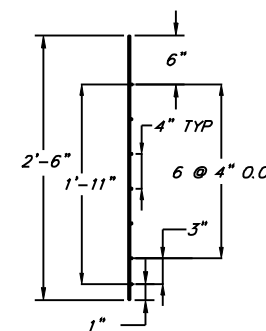

F
2 **SECTION BACKING PANEL**
N.T.S.

T&B STRUCTURAL SYSTEMS, INC
ENGINEERED STRUCTURES
637 WEST HURST BLVD.
HURST, TEXAS 76053
(817) 280-9858 (FAX) 280-9864

DATE : 01-01-05

INTERIM STANDARD IN ENGLISH UNITS
APPLICABLE TO DESIGN STANDARDS
BOOKLET PUBLISHED IN EITHER ENGLISH
OR METRIC UNITS.

STATE OF FLORIDA DEPARTMENT OF TRANSPORTATION			
RETAINING WALL SYSTEMS T&B STRUCTURAL SYSTEMS, INC. GABION WIRE WALL			
INTERIM STANDARD	APPROVED BY William N. Nickas, P.E. State Structures Design Engineer		Index No.
Index No. 5130 (Sheets 1-5 of 5 is a supplement to the metric Roadway and Traffic Design Standards Booklet dated January 2000.)	Revision No.	Sheet No.	5110
	04	2 of 5	

TBSS CLAIMS ALL PROPRIETARY RIGHTS TO ALL DRAWINGS, SPECIFICATIONS AND METHODOLOGIES CONTAINED HEREIN. THE USE OF THIS INFORMATION IS RESTRICTED TO APPROPRIATE PROJECTS THAT IT WAS PREPARED FOR. NO REPRODUCTION, IN PART, OR IN WHOLE, MAY BE MADE WITHOUT WRITTEN INSTRUCTION FROM TBSS.

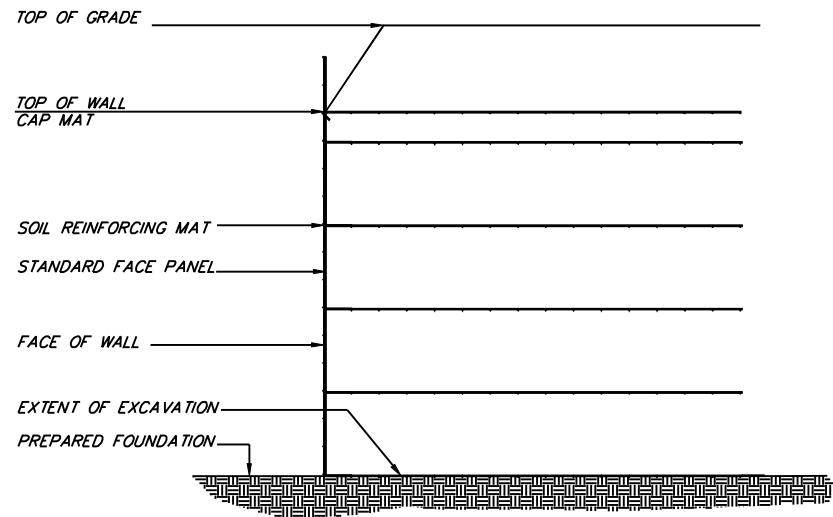

A
3 TYPICAL SECTION WELDED WIRE WALL

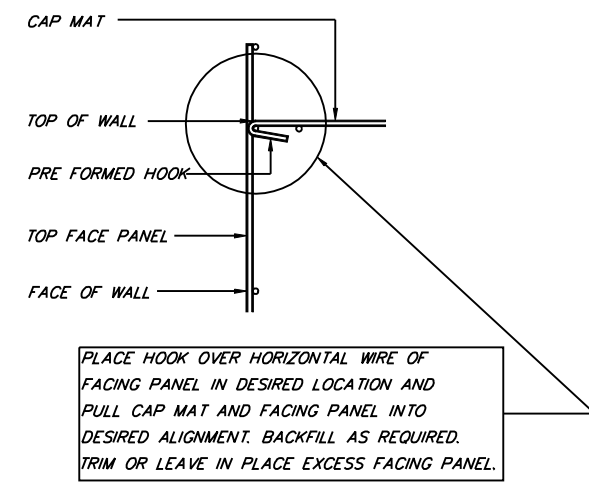

NOTE: PLACE FILTER FABRIC AT DESIRED LOCATION AND SECURE WITH HOG RINGS. TRIM AS IS REQUIRED

C
3 CAP MAT CONNECTION DETAIL

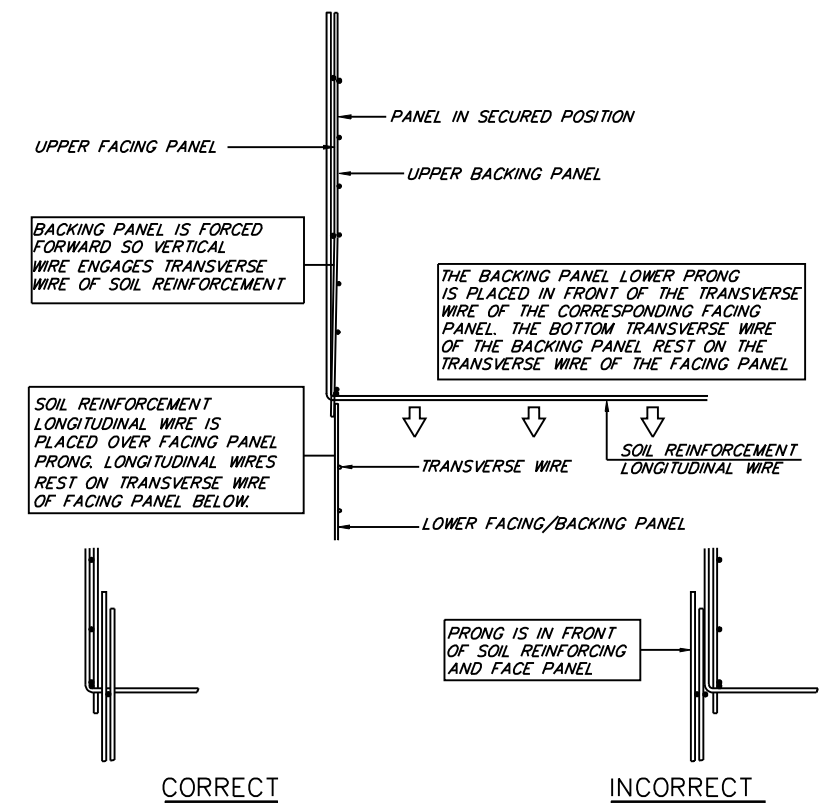

E
3 SOIL REINFORCEMENT CONNECTION SEQUENCE

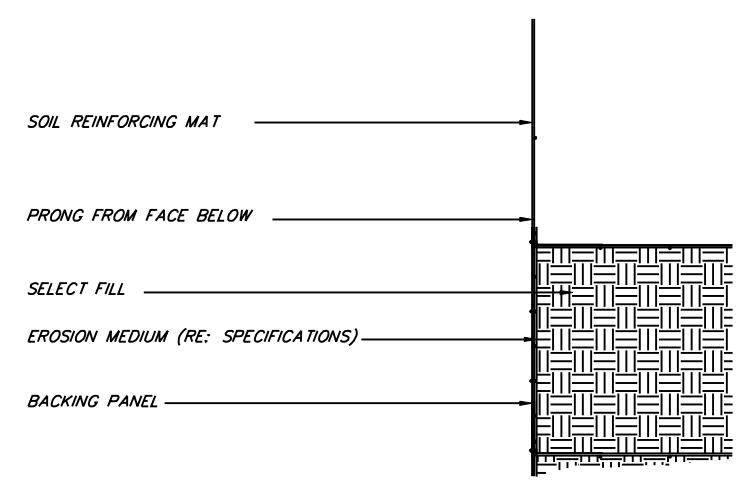

B
3 WELDED WIRE WALL LIFT SECTION

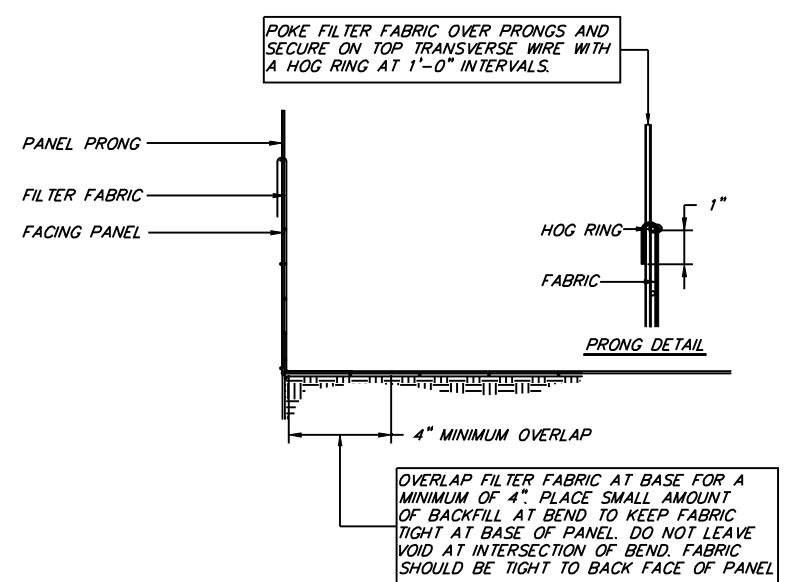

D
3 FILTER FABRIC PLACEMENT

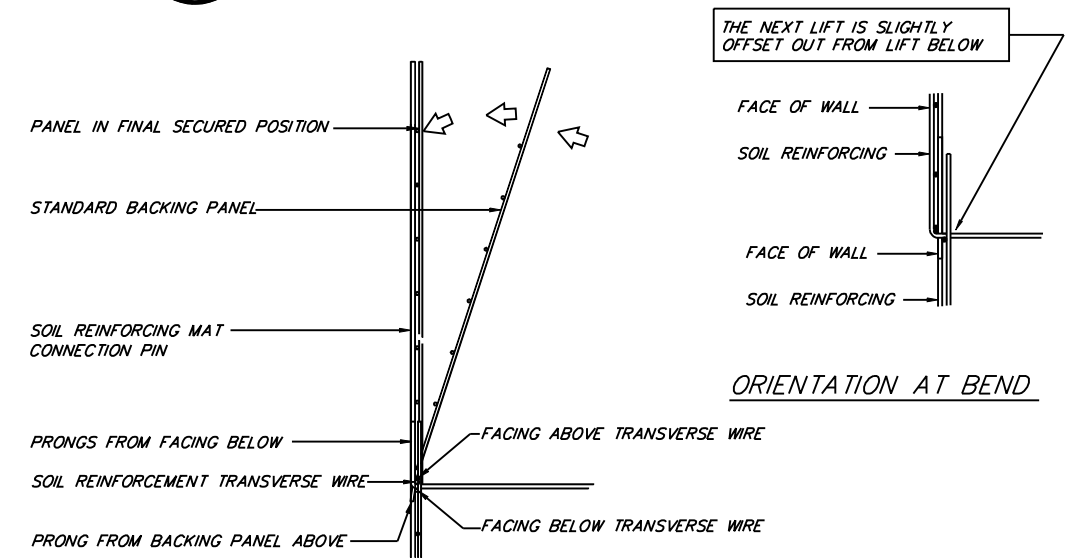

F
3 SOIL REINFORCEMENT CONNECTION SEQUENCE

TBSS CLAIMS ALL PROPRIETARY RIGHTS TO ALL DRAWINGS, SPECIFICATIONS AND METHODOLOGIES CONTAINED HEREIN. THE USE OF THIS INFORMATION IS RESTRICTED TO APPROPRIATE PROJECTS THAT IT WAS PREPARED FOR. NO REPRODUCTION, IN PART, OR IN WHOLE, MAY BE MADE WITHOUT WRITTEN INSTRUCTION FROM TBSS.

T&B STRUCTURAL SYSTEMS, INC
ENGINEERED STRUCTURES
637 WEST HURST BLVD.
HURST, TEXAS 76053
(817) 280-9858 (FAX) 280-9864

DATE : 01-01-05
INTERIM STANDARD IN ENGLISH UNITS APPLICABLE TO DESIGN STANDARDS BOOKLET PUBLISHED IN EITHER ENGLISH OR METRIC UNITS.

STATE OF FLORIDA DEPARTMENT OF TRANSPORTATION

RETAINING WALL SYSTEMS
T&B STRUCTURAL SYSTEMS, INC.
GABION WIRE WALL

INTERIM STANDARD

APPROVED BY
William N. Nickas, P.E.
State Structures Design Engineer

Index No. 5130 (Sheets 1-5 of 5 is a supplement to the metric Roadway and Traffic Design Standards Booklet dated January 2000.)

Revision No.	Sheet No.	Index No.
04	3 of 5	5110

STEP 1 - SOIL REINFORCING PLACEMENT

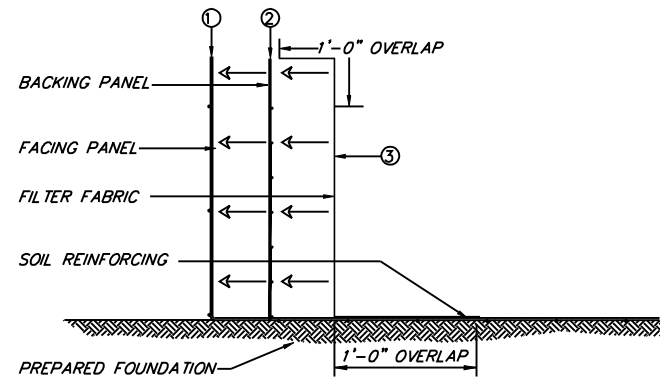

1. PLACE BOTTOM SOIL REINFORCING GRID ON PREPARED FOUNDATION
2. PLACE BACKING PANEL AT BACK FACE OF SOIL REINFORCING FACING PANEL AND SECURE WITH HOG RINGS.
3. PLACE FILTER FABRIC ON BACK FACE OF BACK BACKING PANEL AND SECURE WITH HOG RINGS

STEP 3 - NEXT SOIL REINFORCING LIFT

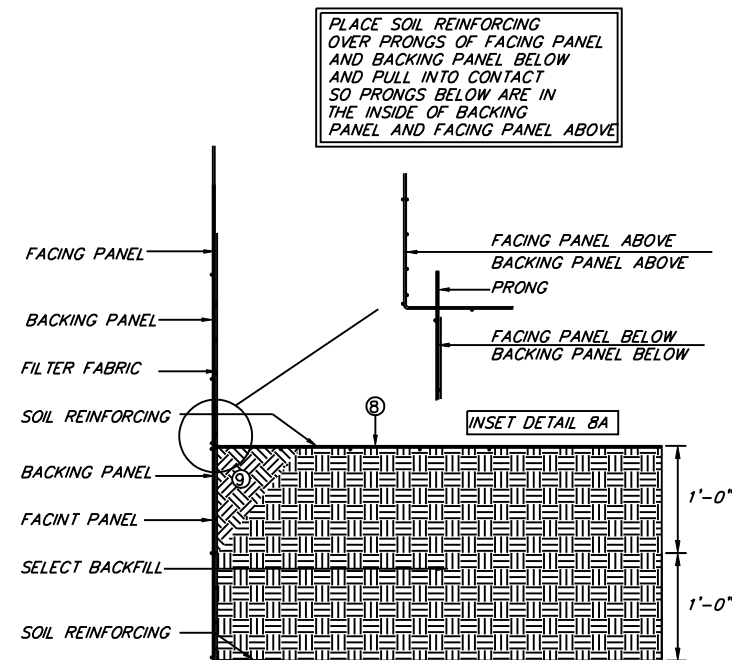

8. PLACE NEXT LAYER OF SOIL REINFORCING GRIDS ON COMPACTED FILL AND SECURE TO FACING PANEL WITH HOG RING. PULL WALL FACE INTO ALIGNMENT. (REFERENCE INSET DETAIL 8A)
9. PLACE BACKFILL IN VOID BELOW. MOUND ON TOP AND COMPACT

A
4 **ERECTION SEQUENCE STEPS**
RECOMMENDED INSTALLATION PROCEDURE

STEP 2 - BACKFILL PLACEMENT

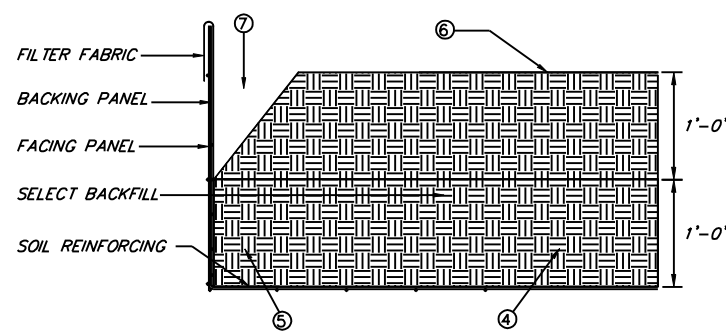

4. PLACE AND COMPACT MAXIMUM OF 1'-0" OF SELECT BACKFILL ON TOP OF SOIL REINFORCING GRID
5. TAKE CARE PLACING MATERIAL AT FACE OF WALL PAYING ATTENTION TO FACING ALIGNMENT.
6. PLACE AND COMPACT 1'-0" OF SELECT BACKFILL TO BRING BACKFILL LEVEL WITH NEXT LIFT ELEVATION
7. LEAVE VOID AT FACE OF WALL UNTIL NEXT SOIL REINFORCING ELEMENT IS PLACED

STEP 4 - CAP MAT

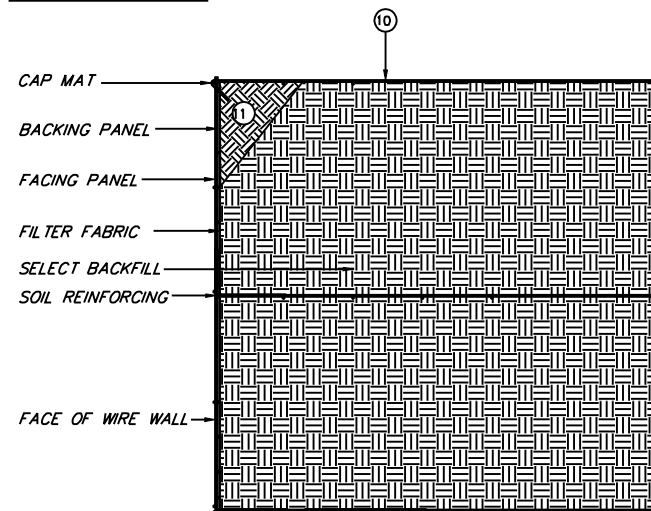

10. PLACE CAP MAT AT TOP OF WALL ELEVATION AND PULL FACE INTO ALIGNMENT
11. PLACE BACKFILL IN VOID BELOW. MOUND ON TOP AND COMPACT

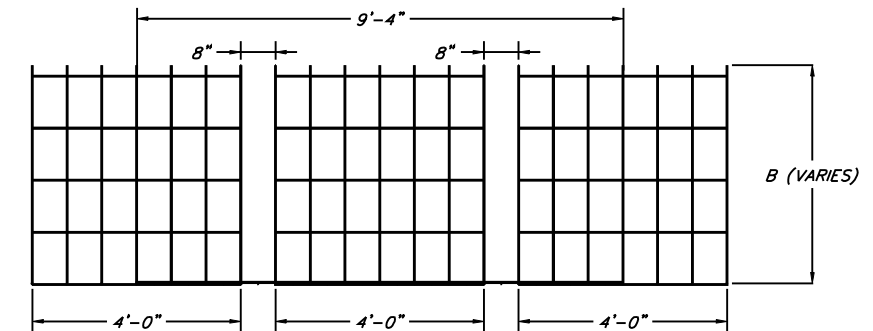

B
4 **PLAN VIEW SOIL REINFORCING**
SOIL REINFORCING LAYOUT

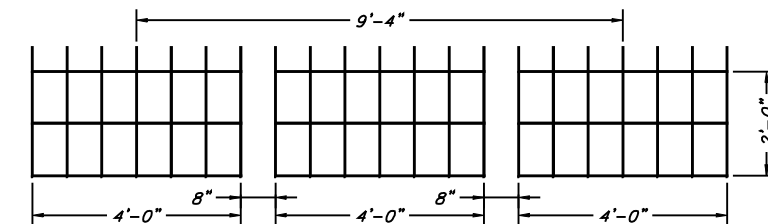

C
4 **ELEVATION FACING PANEL**
SOIL REINFORCING FACING PANEL

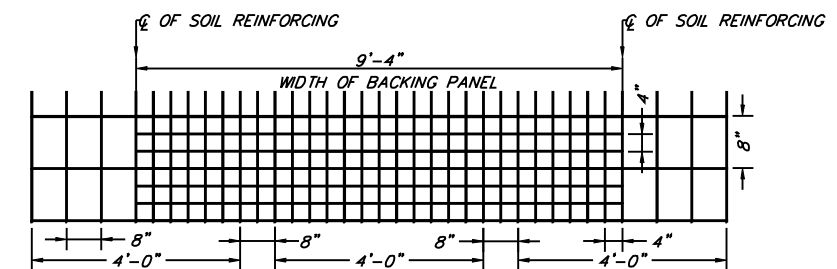

- NOTE:
1. BACKING PANEL SHALL BE PLACED SO IT IS AT THE CENTER LINE OF THE SOIL REINFORCING FACING PANEL.
 2. BACKING PANEL SHALL BE PLACED AT BACK FACE OF SOIL REINFORCING FACING PANEL IN MANNER THAT VERTICAL AND HORIZONTAL PATTERN MAINTAINS A 4" X 4" APPARENT OPENING AS VIEWED FROM FRONT FACE OF STRUCTURE

D
4 **FACING ELEVATION**

T&B STRUCTURAL SYSTEMS, INC
ENGINEERED STRUCTURES
637 WEST HURST BLVD.
HURST, TEXAS 76053
(817) 280-9858 (FAX) 280-9864

DATE : 01-01-05

INTERIM STANDARD IN ENGLISH UNITS
APPLICABLE TO DESIGN STANDARDS
BOOKLET PUBLISHED IN EITHER ENGLISH
OR METRIC UNITS.

TBSS CLAIMS ALL PROPRIETARY RIGHTS TO ALL DRAWINGS, SPECIFICATIONS AND METHODOLOGIES CONTAINED HEREIN. THE USE OF THIS INFORMATION IS RESTRICTED TO APPROPRIATE PROJECTS THAT IT WAS PREPARED FOR. NO REPRODUCTION, IN PART, OR IN WHOLE, MAY BE MADE WITHOUT WRITTEN INSTRUCTION FROM TBSS.

STATE OF FLORIDA DEPARTMENT OF TRANSPORTATION			
RETAINING WALL SYSTEMS T&B STRUCTURAL SYSTEMS, INC. GABION WIRE WALL			
INTERIM STANDARD	APPROVED BY	William N. Nickas, P.E. State Structures Design Engineer	
Index No. 5130 (Sheets 1-5 of 5 is a supplement to the metric Roadway and Traffic Design Standards Booklet dated January 2000.	Revision No.	Sheet No.	Index No.
	04	4 of 5	5110

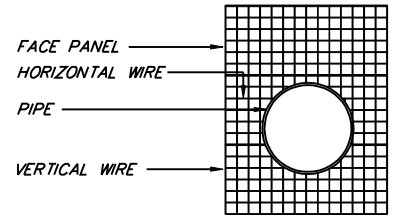

NOTE:
TRIM PROTRUSION AREA FROM FACING PANEL BY CUTTING HORIZONTAL WIRE BETWEEN EACH VERTICAL WIRE. BEND WIRES BACK INTO MSE MASS AND AS CLOSE TO PROTRUSION AS POSSIBLE. APPLY FILTER FABRIC OVER AND AROUND PROTRUSION MAKING SURE FACING PANEL IS COVERED. MAKE SURE THAT ALL GAPS BETWEEN FACE AND PROTRUSION ARE COVERED WITH FILTER FABRIC. IF PROTRUSION INTERFERES WITH SOIL REINFORCING MAT CUT TRANSVERSE WIRES OF MAT AND BEND LONGITUDINAL WIRE TO PASS PROTRUSION AND CONFORM TO THE PROTRUSIONS SHAPE.

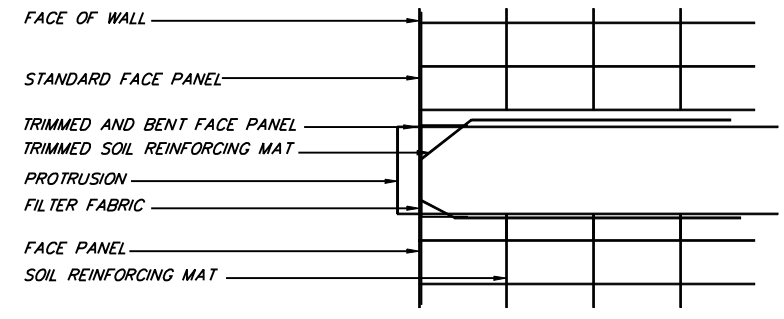

NOTE:
TRIM PROTRUSION AREA FROM FACING PANEL BY CUTTING HORIZONTAL WIRE BETWEEN EACH VERTICAL WIRE. BEND WIRES BACK INTO MSE MASS AND AS CLOSE TO PROTRUSION AS POSSIBLE. APPLY FILTER FABRIC OVER AND AROUND PROTRUSION MAKING SURE FACING PANEL IS COVERED. MAKE SURE THAT ALL GAPS BETWEEN FACE AND PROTRUSION ARE COVERED WITH FILTER FABRIC. IF PROTRUSION INTERFERES WITH SOIL REINFORCING MAT CUT TRANSVERSE WIRES OF MAT AND BEND LONGITUDINAL WIRE TO PASS PROTRUSION AND CONFORM TO THE PROTRUSIONS SHAPE.

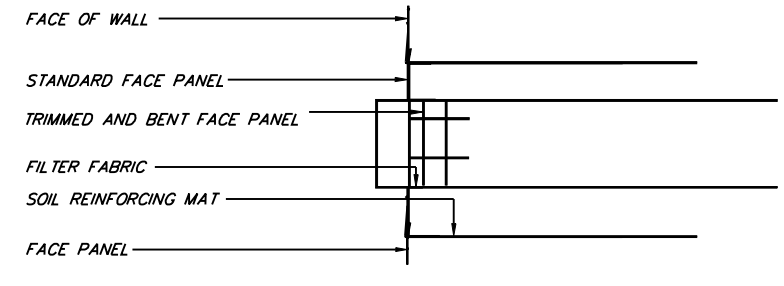

NOTE:
TRIM PROTRUSION AREA FROM FACING PANEL BY CUTTING HORIZONTAL WIRE BETWEEN EACH VERTICAL WIRE. BEND WIRES BACK INTO MSE MASS AND AS CLOSE TO PROTRUSION AS POSSIBLE. APPLY FILTER FABRIC OVER AND AROUND PROTRUSION MAKING SURE FACING PANEL IS COVERED. MAKE SURE THAT ALL GAPS BETWEEN FACE AND PROTRUSION ARE COVERED WITH FILTER FABRIC. IF PROTRUSION INTERFERES WITH SOIL REINFORCING MAT CUT TRANSVERSE WIRES OF MAT AND BEND LONGITUDINAL WIRE TO PASS PROTRUSION AND CONFORM TO THE PROTRUSIONS SHAPE.

A
5 **TYPICAL ELEVATION THROUGH PENETRATION**
RECOMMENDED INSTALLATION PROCEDURE

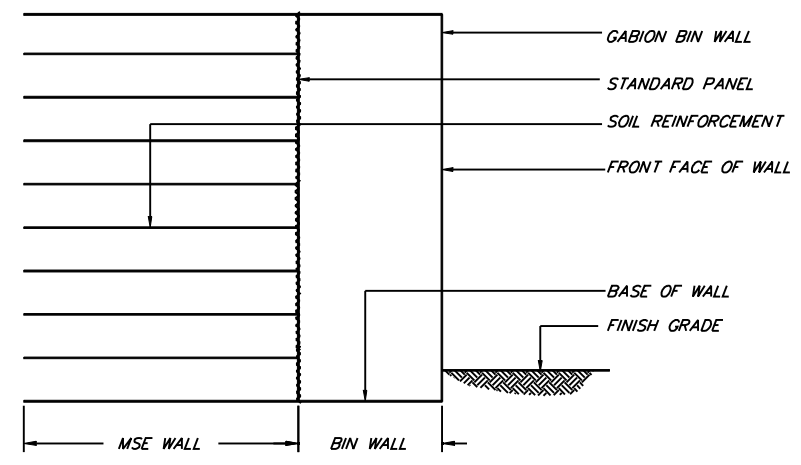

B
5 **TYPICAL SECTION THROUGH BIN**
RECOMMENDED INSTALLATION PROCEDURE

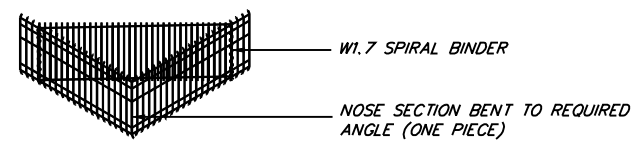

NOTE: 12 GAUGE GALVANIZED STEEL HOG RING MAY BE SUBSTITUTED FOR SPIRAL BINDER. HOG RINGS TO BE ATTACHED AT 3" CENTERS TOP TO BOTTOM.

C
5 **ISOMETRIC OF BIN GABION NOSE SECTION**
RECOMMENDED INSTALLATION PROCEDURE

D
5 **TYPICAL PLAN VIEW THROUGH PENETRATION**
RECOMMENDED INSTALLATION PROCEDURE

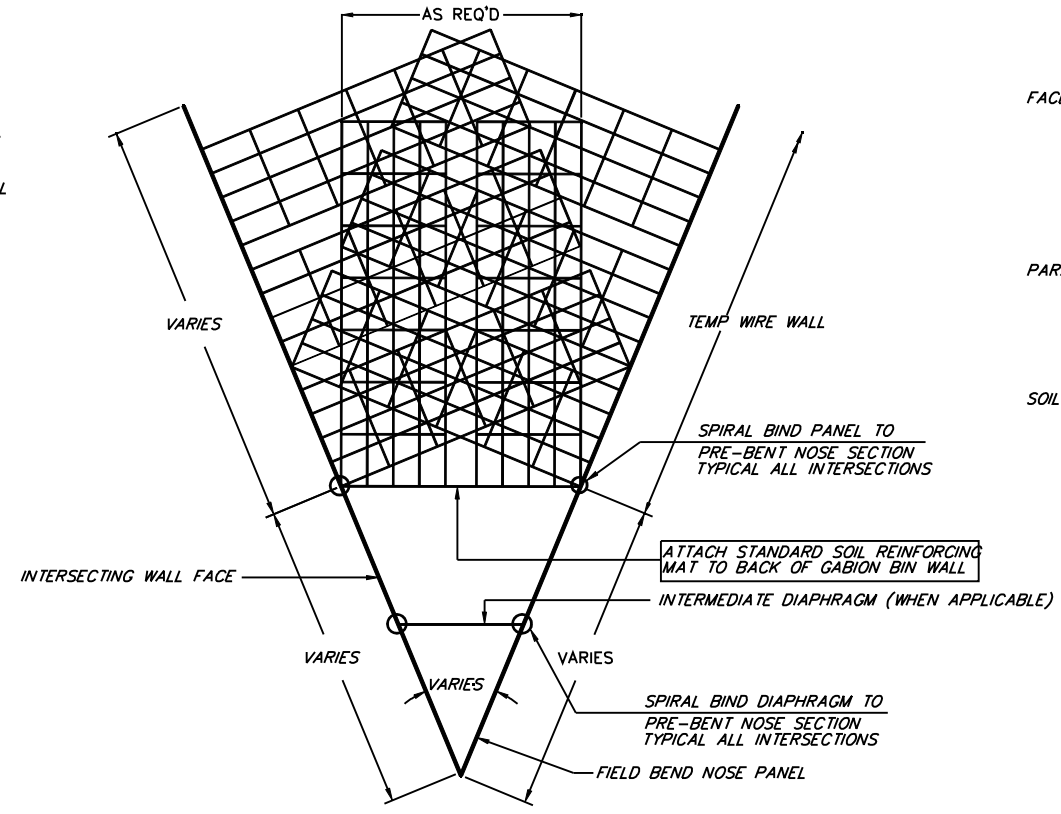

E
5 **TYPICAL PLAN VIEW AT BIN**
RECOMMENDED INSTALLATION PROCEDURE

F
5 **TYPICAL SECTION THROUGH PENETRATION**
RECOMMENDED INSTALLATION PROCEDURE

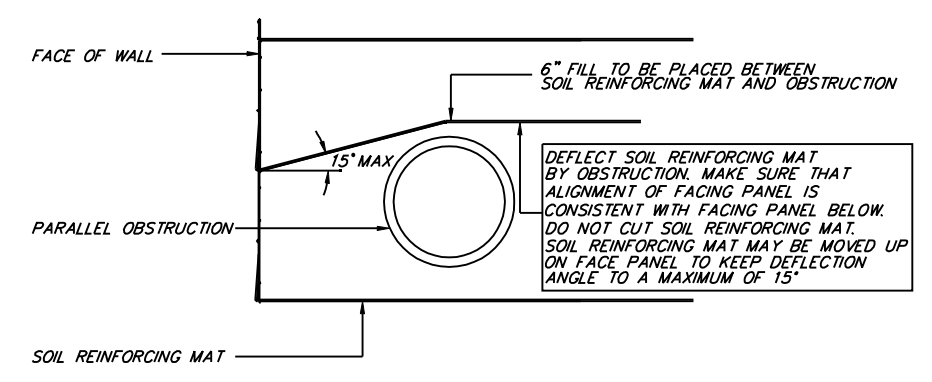

G
5 **TYPICAL SECTION AT PARALLEL OBSTRUCTION**
RECOMMENDED INSTALLATION PROCEDURE

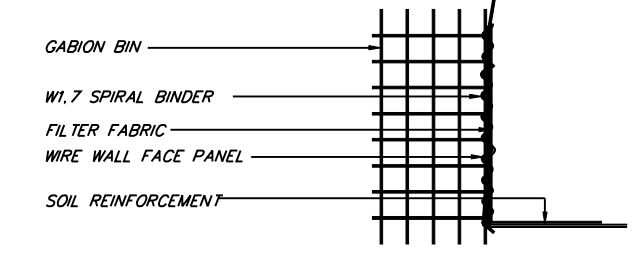

NOTE: 12 GAUGE GALVANIZED STEEL HOG RING MAY BE SUBSTITUTED FOR SPIRAL BINDER. HOG RINGS TO BE ATTACHED AT 3" CENTERS

H
5 **TYPICAL SECTION AT GABION SPIRAL TIE**
RECOMMENDED INSTALLATION PROCEDURE

T&B STRUCTURAL SYSTEMS, INC
ENGINEERED STRUCTURES
637 WEST HURST BLVD.
HURST, TEXAS 76053
(817) 280-9858 (FAX) 280-9864

DATE : 01-01-05

INTERIM STANDARD IN ENGLISH UNITS APPLICABLE TO DESIGN STANDARDS BOOKLET PUBLISHED IN EITHER ENGLISH OR METRIC UNITS.

TBSS CLAIMS ALL PROPRIETARY RIGHTS TO ALL DRAWINGS, SPECIFICATIONS AND METHODOLOGIES CONTAINED HEREIN. THE USE OF THIS INFORMATION IS RESTRICTED TO APPROPRIATE PROJECTS THAT IT WAS PREPARED FOR. NO REPRODUCTION, IN PART, OR IN WHOLE, MAY BE MADE WITHOUT WRITTEN INSTRUCTION FROM TBSS.

STATE OF FLORIDA DEPARTMENT OF TRANSPORTATION

RETAINING WALL SYSTEMS
T&B STRUCTURAL SYSTEMS, INC.
GABION WIRE WALL

INTERIM STANDARD

APPROVED BY
William N. Nickas, P.E.
State Structures Design Engineer

Index No. 5130 (Sheets 1-5 of 5 is a supplement to the metric Roadway and Traffic Design Standards Booklet dated January 2000.)

Revision No.	Sheet No.	Index No.
04	5 of 5	5110