



Florida Department of Transportation

RICK SCOTT
GOVERNOR

605 Suwannee Street
Tallahassee, FL 32399-0450

ANANTH PRASAD
SECRETARY

STRUCTURES DESIGN BULLETIN C11-08

DATE: July 12, 2011

TO: District Directors of Operations, District Directors of Production, District Design Engineers, District Construction Engineers, District Geotechnical Engineers, District Structures Design Engineers

FROM: Robert V. Robertson, P. E., State Structures Design Engineer 

COPIES: Ananth Prasad, Brian Blanchard, David Sadler, Charles Boyd, Rudy Powell, Melissa Hollis, Jeffrey Ger (FHWA)

SUBJECT: Implementation of new Design Standards, Design Guidelines and Construction Specifications for Polymeric Bridge Fender Systems

This bulletin implements new requirements for Bridge Fender Systems.

REQUIREMENTS

1. Design Standards

Design Standards Indexes 21900, 21910, 21920 and 21930 have been removed and replaced in the July 2011 Interims with the drawings as shown in Attachment A as listed below.

Attachment A:

Index 21900 (7 sheets): Fender System – Polymeric Piles

Index 21930 (7 sheets): Fender System – Prestressed Concrete Piles

2. Instructions for Design Standards (IDS)

IDS “Index 21900 Series Fender Systems” has been replaced as part of the July 2011 Interims with the two new IDS as shown in Attachment B as listed below.

Attachment B:

IDS, Index 21900 Fender Systems – Polymeric Piles

IDS, Index 21930 Fender Systems – Prestressed Concrete Piles

3. 2011 Structures Manual, Volume 1: Structures Design Guidelines (SDG)

Remove SDG, Section 3.14 and replace it with the new SDG, Section 3.14 as provided in Attachment C.

4. Standard Specifications for Road and Bridge Construction

Standard Specifications Sections 973 and 471 will be replaced in the January 2012 Workbook with the new sections as provided in Attachment D as listed below.

Attachment D:

Standard Specifications Section 973 – Structural Plastics

Standard Specifications Section 471 – Polymeric Fender Systems

5. Basis of Estimates (BOE) Manual

Section 455-37 of the BOE will be removed and replaced with a new Section 471-2 on January 1, 2012 as provided in Attachment E.

BACKGROUND

Due to the introduction of new piling products which allows for increased competition, the Department has readdressed bridge fender system designs to include polymeric piling products which will be listed on the Qualified Products List (QPL). In general, polymeric materials are being developed for many different structural applications; however, there are currently no national standards in place for the manufacturing processes and materials associated with polymeric piling. Modifications to the Standard Specifications, Structures Design Guidelines and Design Standards are necessary in order to accommodate the use of polymeric piling products on FDOT bridge fender systems.

COMMENTARY

Changes to the Standard Specifications include the removal of the existing material specification for bridge fender system piling in Specification Section 973 and the addition of piling performance requirements to Specification Section 471.

The Structures Design Guidelines (SDG), Section 3.14 has been rewritten to give thorough guidance to both the Engineer of Record and the Supplier's Engineer.

Fender systems are no longer classified as "Light Duty", "Medium Duty" or "Heavy Duty"; therefore, Design Standards Indexes 21910 and 21920 are deleted. Designs will use the basic geometry of the fender system, standard connection details if possible, and limitations for pile spacing and pile clusters that are shown in revised Design Standards Index 21900. Each polymeric piling supplier will develop pile configurations and connection details for fender systems that result in flexible, energy absorbing structures maximizing the efficiency of their proprietary polymeric pile. These pile configurations will be listed on the QPL.

For the time being, Design Standards Index 21930 which utilizes Prestressed Concrete Piles will continue to be available for limited use as before.

IMPLEMENTATION

This policy is effective for all projects let after January 1, 2012 containing bridge fender systems. Projects let prior to January 1, 2012 with current specifications and existing construction projects may incorporate the new requirements under the Cost Savings Initiative Proposal provisions of Supplemental Specifications Section 4-3.9.

CONTACT

Gevin McDaniel, P.E.
Senior Structures Design Engineer
Florida Department of Transportation
605 Suwannee Street, MS 33
Tallahassee, FL 32399-0450
Phone (850)-414-4284
gevin.mcdaniel@dot.state.fl.us

RVR/gjm

Attachments

Attachment A:

Design Standards Index 21900: Fender System – Polymeric Piles

Design Standards Index 21930: Fender System – Prestressed Concrete Piles

ARCHIVED

GENERAL NOTES:

U.S. COAST GUARD NOTIFICATION: Notify the local office of the U.S. Coast Guard at least 30 days prior to beginning of construction of the Fender System.

POLYMERIC PILES – Provide polymeric piles in accordance with Specification Section 471. Installation shall be in accordance with manufacturer's recommendations. All piles shall be plumb.

PLASTIC LUMBER AND STRUCTURAL COMPOSITE LUMBER WALES: Provide only Plastic Lumber and Structural Composite Lumber Wales in accordance with Specification Section 973. Wales shall be continuous and spliced only at locations shown on the plans.

PLASTIC LUMBER DECKING FOR CATWALKS: Provide Plastic Lumber decking for catwalks when called for in the Plans in accordance with Specification Section 973.

Install Plastic Lumber Decking according to manufacturer's recommendations using stainless steel #10 x 3" (minimum) deck screws.

FIBERGLASS OPEN GRATING FOR CATWALKS: Provide Fiberglass Open Grating for catwalks when called for in the Plans. Fiberglass Open Grating shall be a heavy duty design suitable for exterior installations. Maximum gap opening on the walkway surface shall be 1½". Design live loads and deflections shall be a 50 psf uniformly distributed load with a maximum deflection of ⅜" or L/120 at the center of a simple span and a concentrated load of 250 pounds with a maximum deflection of ¼" at the center of a simple span. Color of Fiberglass Open Grating shall be gray or black.

Install Fiberglass Open Grating according to manufacturer's recommendations using stainless steel hardware, screws, bolts, nuts and washers. Attach Fiberglass Open Grating to Wales and Deck Supports at a 2'-0" maximum spacing so as to resist pedestrian live loads and uplift forces from wind, buoyancy and wave action.

CLEARANCE GAUGE AND LIGHT: Clearance Gauge to be furnished by the FDOT and erected by the Contractor. Clearance Gauge width and numeral height is dependant on visibility distance. The required visibility distance shall be determined by the United States Coast Guard District Commander. Provide and install Clearance Gauge Light in accordance with Specification Section 510 and Index No. 21220.

NAVIGATION LIGHTS: Provide and install Navigation Lights in accordance with Specification Section 510, Index No. 21220 and/or project specific details. Provide and maintain Temporary Navigation Lights during construction until permanent Navigation Lights are operational.

BOLTS, THREADED BARS, NUTS, SCREWS AND WASHERS: Furnish stainless steel Bolts in accordance with ASTM F593 Type 316. Furnish stainless steel Threaded Bars in accordance with ASTM A193 Grade B8M. Furnish stainless steel Nuts in accordance with ASTM F594 Type 316. Furnish stainless steel Screws in accordance with ASTM F593 Type 305. Furnish stainless steel Washers compatible with Bolts, Threaded Rods and Nuts under heads and nuts. Torque Nuts on 1" diameter Bolts and Threaded Bars to 150 lb-ft. Keep threads on Bolts, Threaded Bars and Nuts free from dirt, coarse grime and sand to prevent galling and seizing during tightening.

SPLICE PLATES: Furnish Splice Plates in accordance with ASTM A240 Type 316.



GENERAL NOTES

REVISIONS						2010 Interim Design Standard		Interim Date	Sheet No.
DATE	BY	DESCRIPTION	DATE	BY	DESCRIPTION			07/01/11	1 of 7
07/01/11	GJM	Deleted "INSTRUCTION TO DESIGNERS" note; Changed title, piling, wales, and dimensional lumber notes to reflect changes to specifications.				 FENDER SYSTEM - POLYMERIC PILES		Index No.	
								21900	

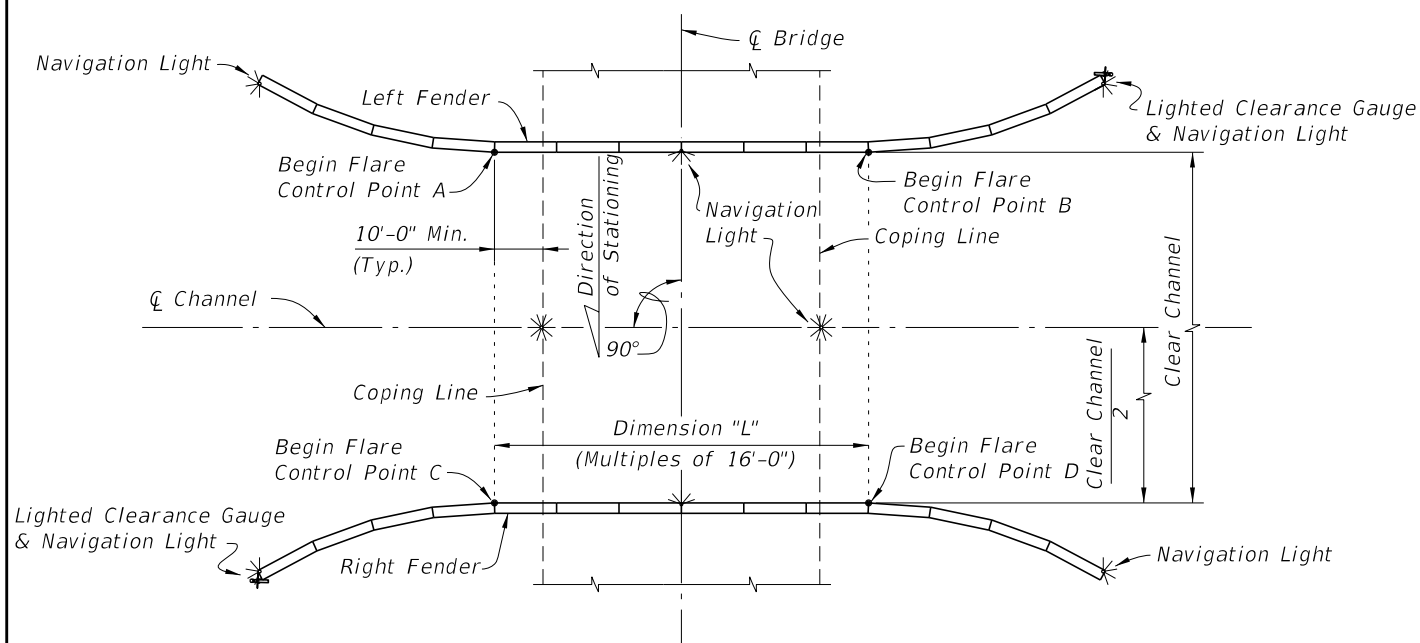

SCHMATIC OF FENDER SYSTEM SHOWING TREATMENT OF SINGLE FIXED BRIDGE WITH NONSKEWED CHANNEL

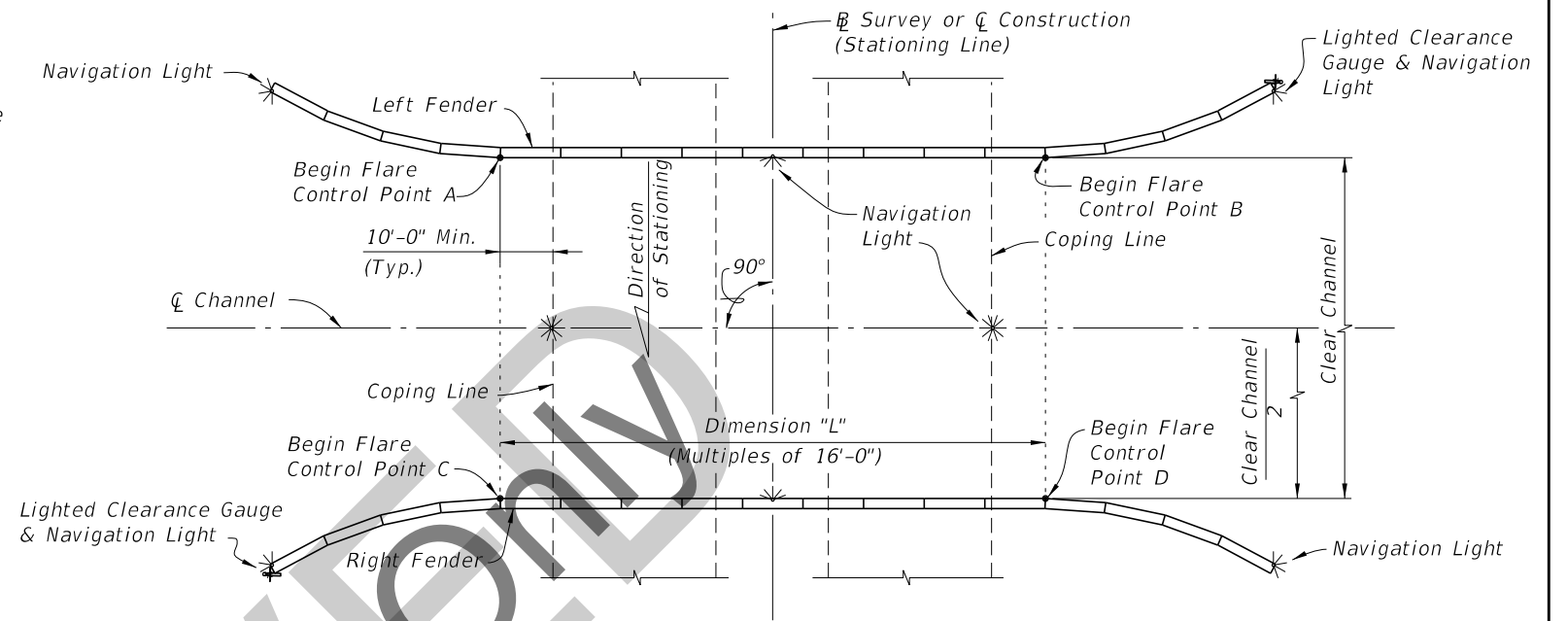

SCHMATIC OF FENDER SYSTEM SHOWING TREATMENT OF DUAL FIXED BRIDGES WITH NONSKEWED CHANNEL (PARALLEL DUAL FIXED BRIDGES SHOWN, NONPARALLEL DUAL FIXED BRIDGES SIMILAR)

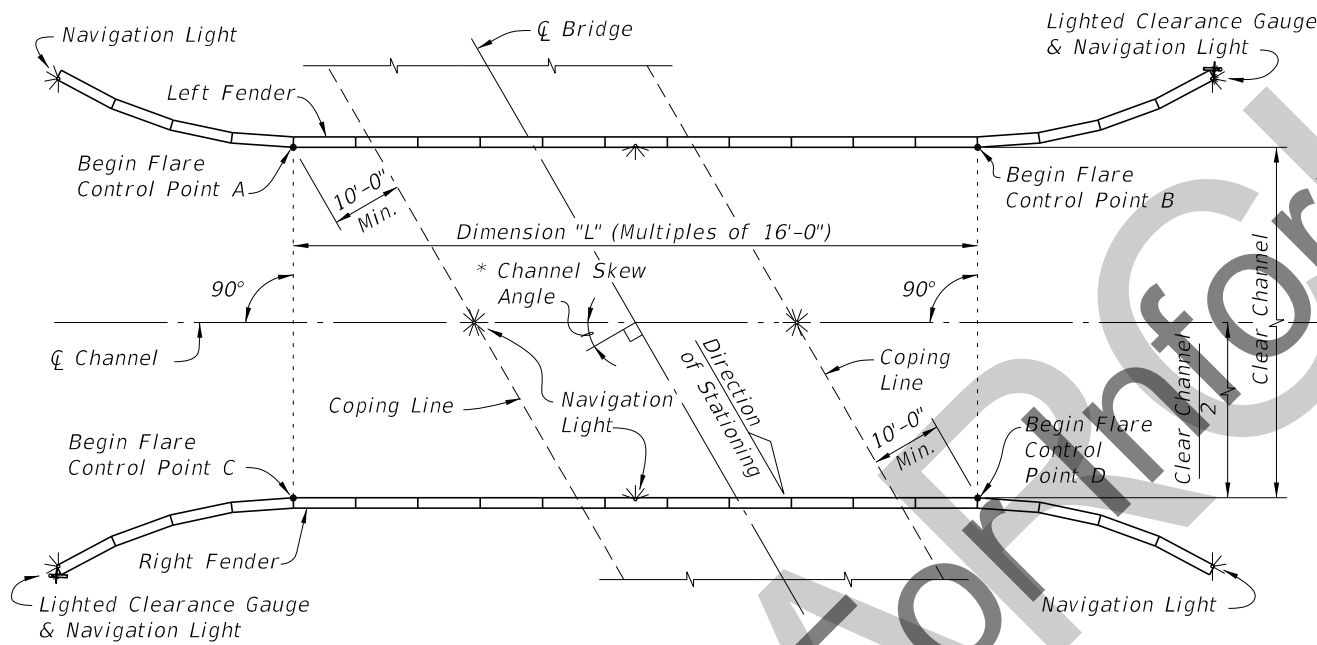

SCHMATIC OF FENDER SYSTEM SHOWING TREATMENT OF SINGLE FIXED BRIDGE WITH SKEWED CHANNEL

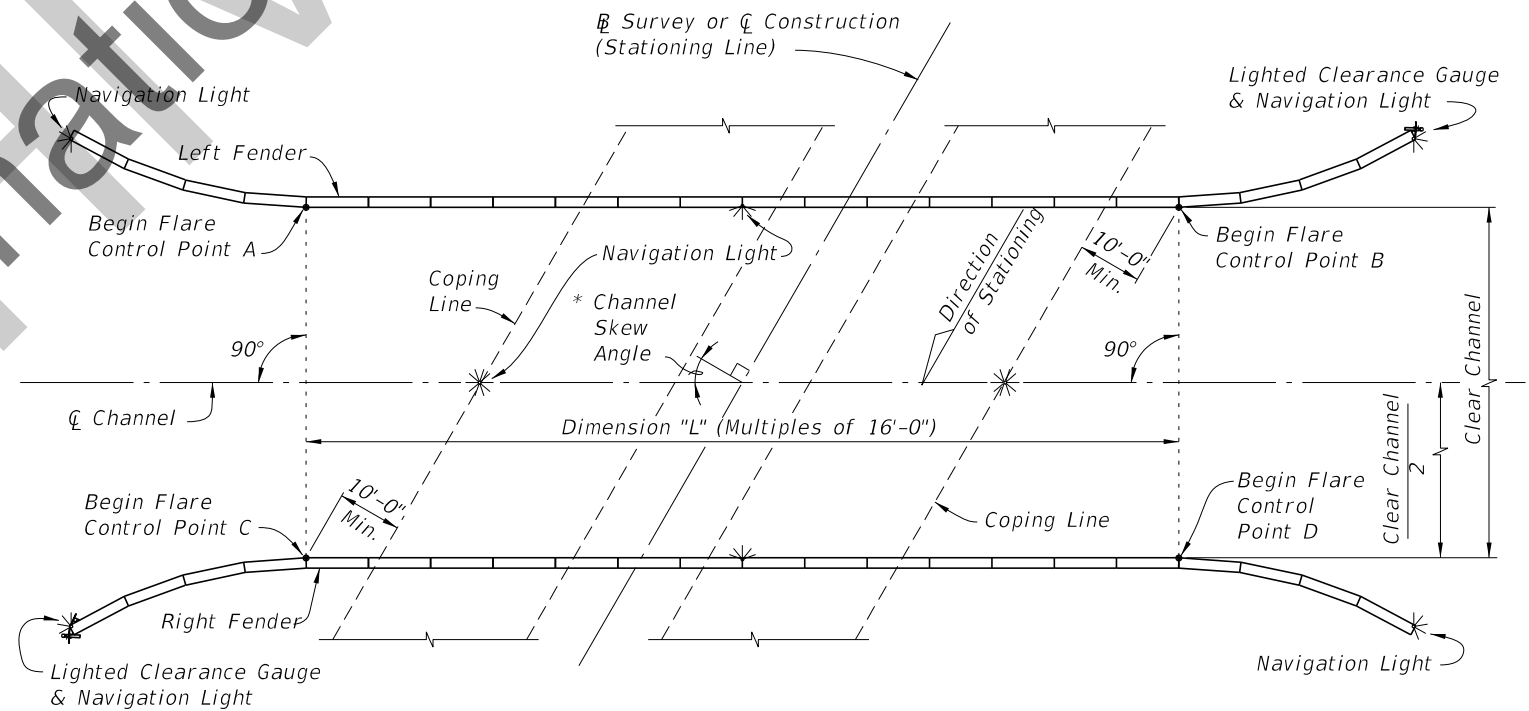

SCHMATIC OF FENDER SYSTEM SHOWING TREATMENT OF DUAL FIXED BRIDGES WITH SKEWED CHANNEL (PARALLEL DUAL FIXED BRIDGES SHOWN, NONPARALLEL DUAL FIXED BRIDGES SIMILAR)

* See Structures Plans, Plan and Elevation and Foundation Layout Sheets for magnitude and orientation of Channel Skew Angle.

CROSS REFERENCES:
 For Stations and Offsets of referenced Control Points A, B, C and D,
 Dimension "L" and Clear Channel Width see Fender System Table
 of Variables in Structures Plans.
 For Navigation Light Details see Design Standards Index 21220.

LAYOUT GEOMETRY

REVISIONS					
DATE	BY	DESCRIPTION	DATE	BY	DESCRIPTION
07/01/11	GJM	Added clarification that this layout geometry is for fixed bridges only; Changed title.			

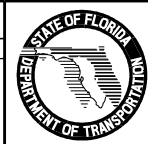

2010 Interim Design Standard

FENDER SYSTEM -
 POLYMERIC PILES

Interim Date	Sheet No.
07/01/11	2 of 7
Index No.	
21900	

CROSS REFERENCES:

For Sections A-A and B-B see Sheet 4.

For View F-F see Sheet 5.

NOTES:

1. Plastic Lumber and Composite Lumber Dimensions shown are based on Nominal Lumber Dimensions and may vary depending on Actual Lumber Dimension.
2. Pile configuration shown is for example only.
3. Three (3) piles per cluster maximum.
4. Two (2) pile per cluster minimum at 16ft. Panel Joints.
5. Two (2) pile cluster shown, one (1) pile or three (3) pile cluster similar.

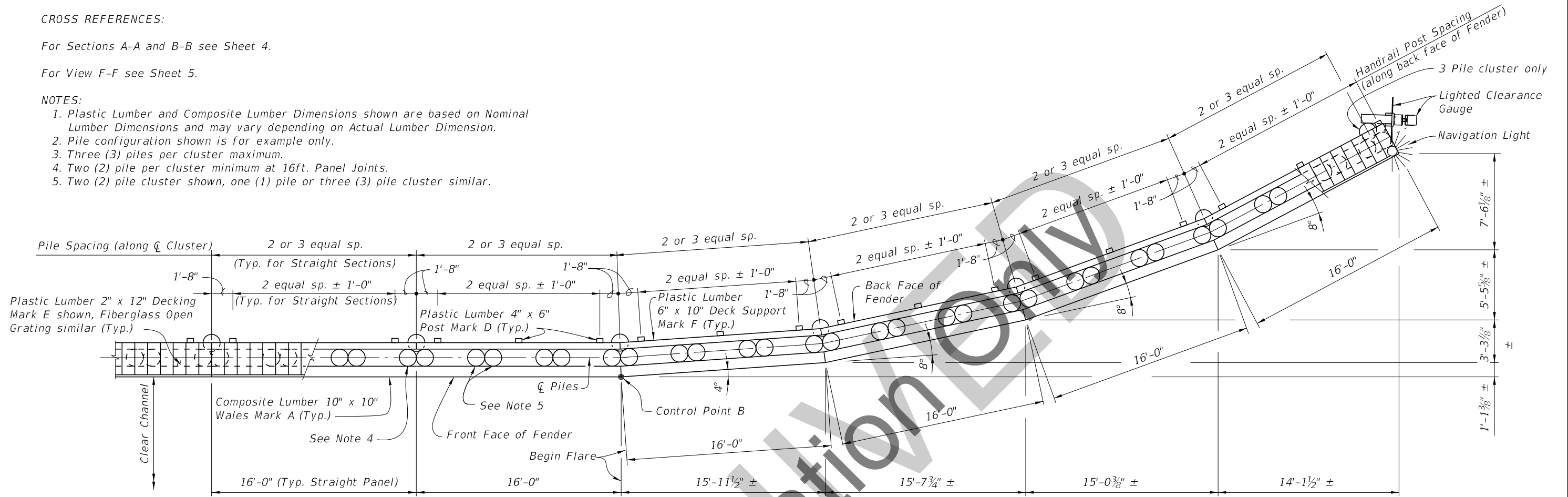

PARTIAL PLAN VIEW (TYPICAL FLARE)
(FLARE AT CONTROL POINT B SHOWN, CONTROL POINTS A, C & D SIMILAR)
(HANDRAIL NOT SHOWN FOR CLARITY)

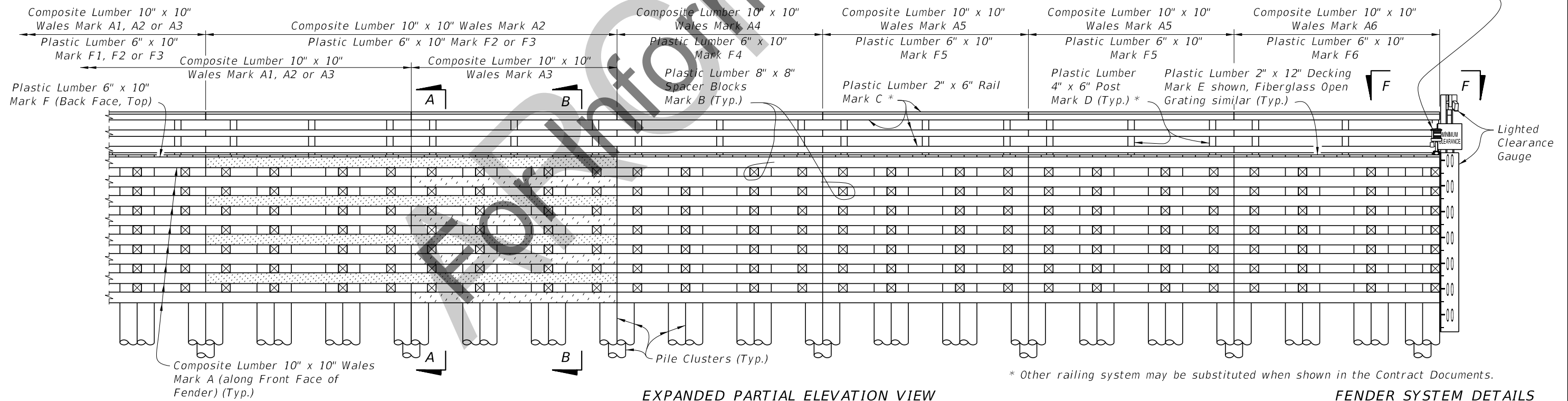

EXPANDED PARTIAL ELEVATION VIEW

FENDER SYSTEM DETAILS

REVISIONS			
DATE	BY	DESCRIPTION	
07/01/11	GJM	New Sheet (Previously Index 21910, Sheet 1); Added piling configuration notes. Removed specific pile spacing dimensions to show allowable number of equal spaces.	

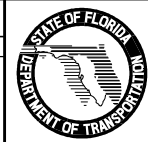

2010 Interim Design Standard

FENDER SYSTEM -
POLYMERIC PILES

Interim Date	Sheet No.
07/01/11	3 of 7
Index No.	
21900	

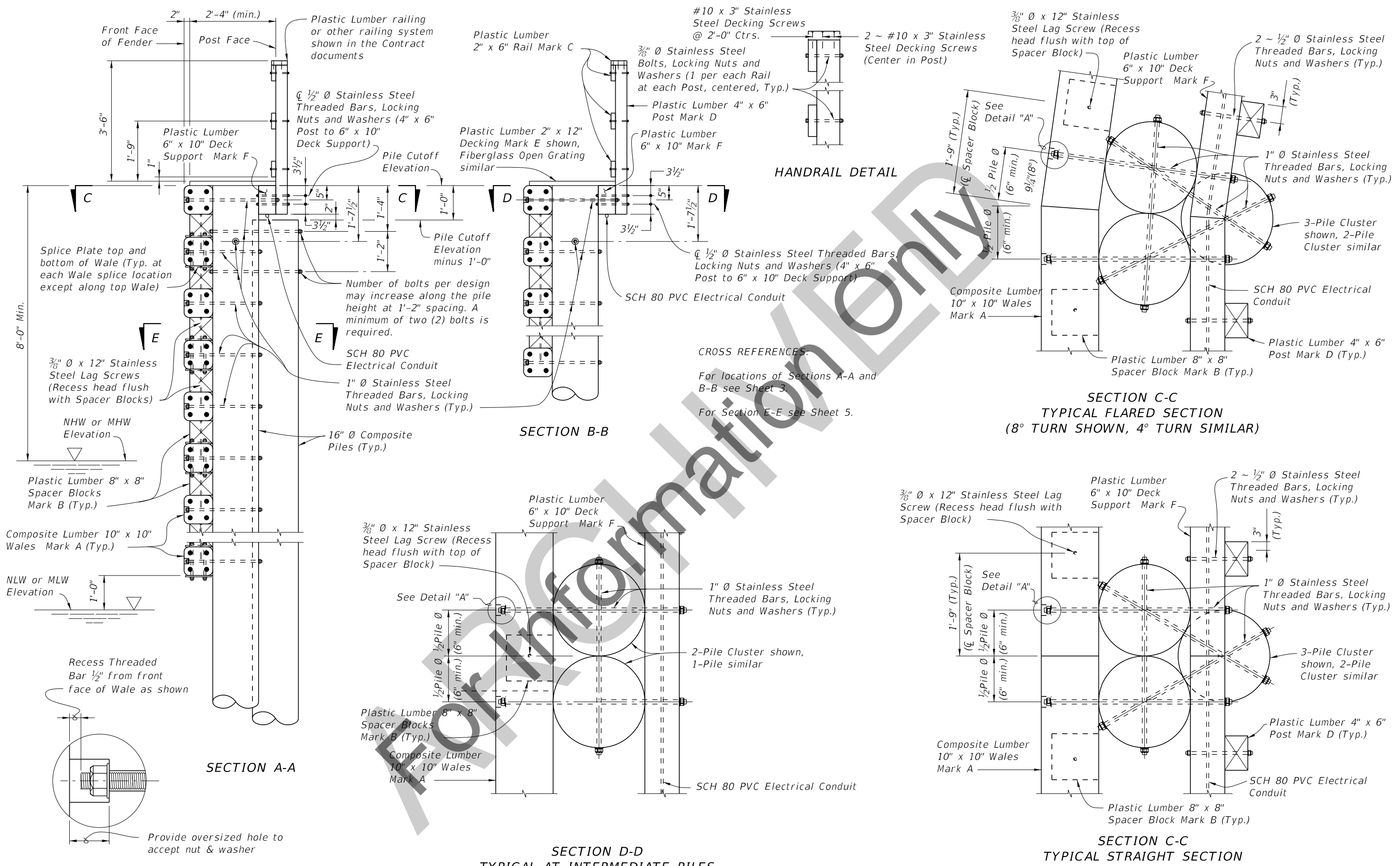

DETAIL "A"

FENDER SYSTEM DETAILS

REVISIONS			
DATE	BY	DESCRIPTION	
07/01/11	GJM	New Sheet (Previously Index 21910, Sheet 2); Modified to allow for various pile types and sizes; Changed bolt configuration for connection of Mark D to Mark F.	

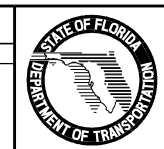

2010 Interim Design Standard

FENDER SYSTEM - POLYMERIC PILES

Interim Date	Sheet No.
07/01/11	4 of 7
Index No.	
21900	

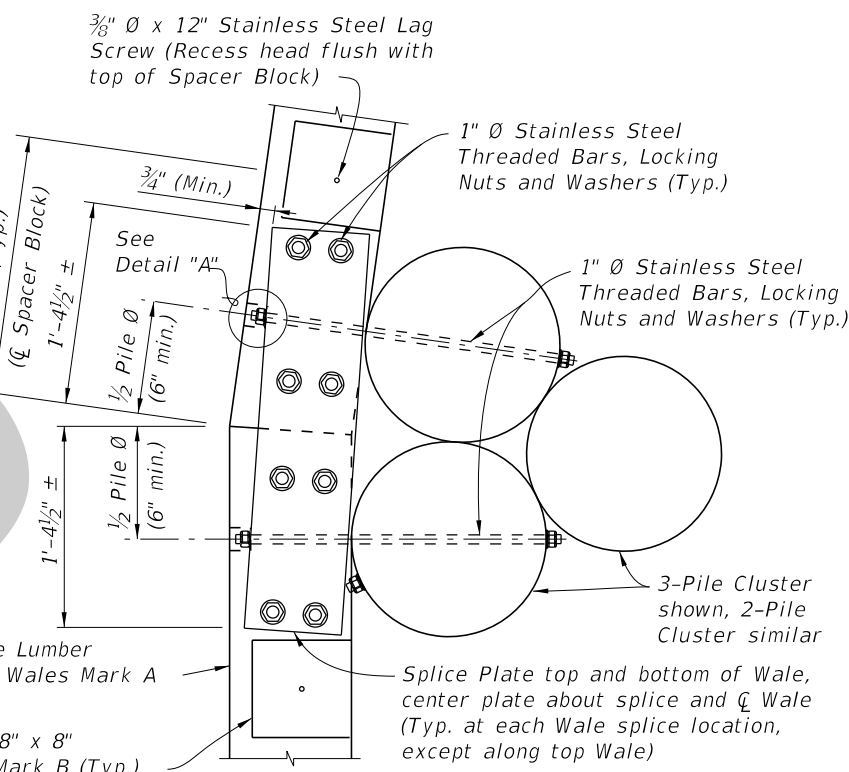
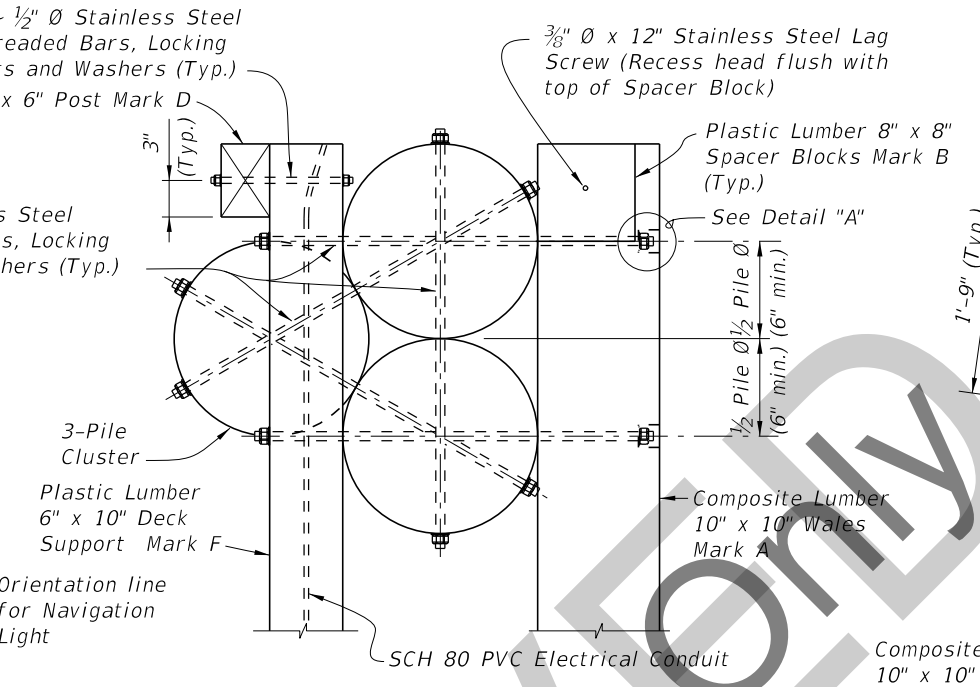
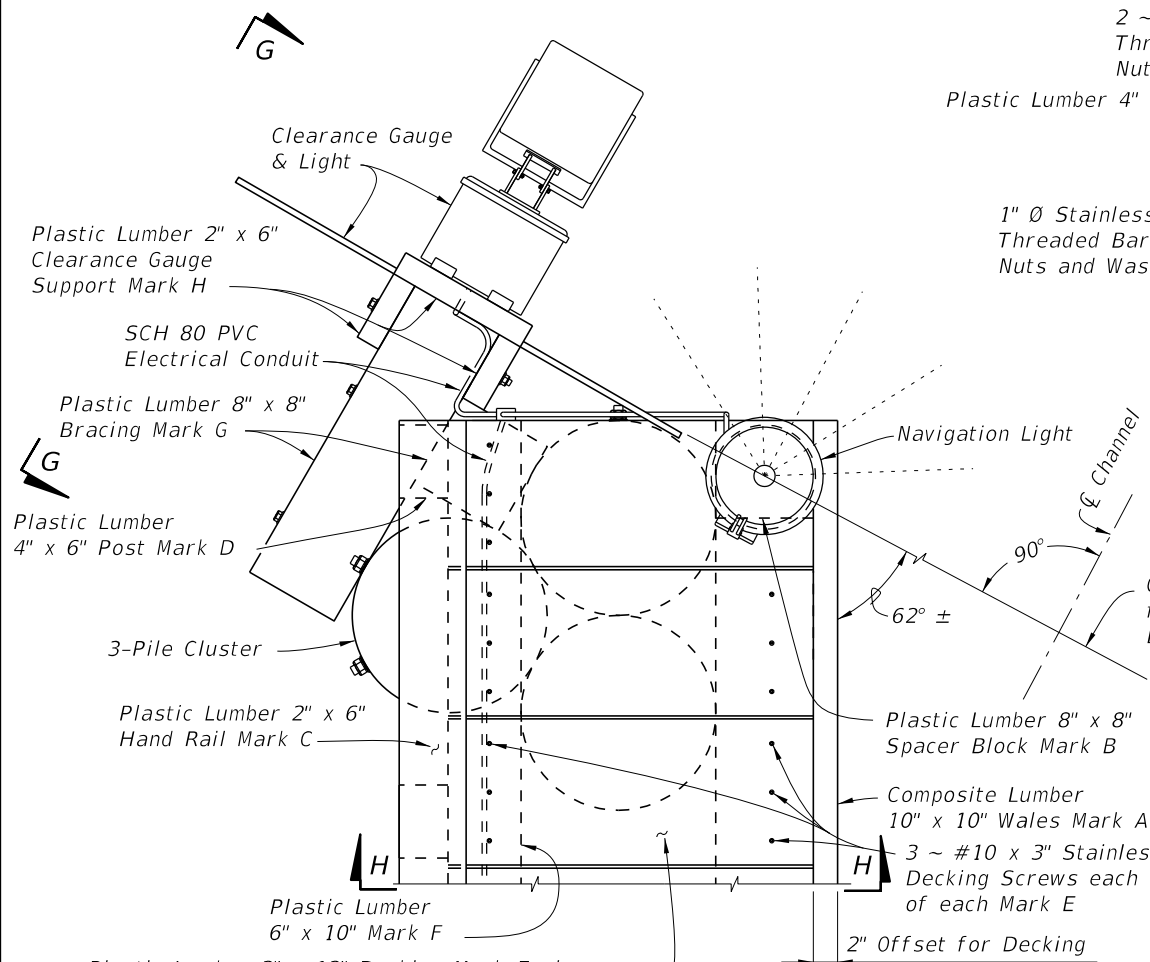

**VIEW F-F
 (SHOWING FENDER END, DECKING, HANDRAIL AND CLEARANCE GAUGE NOT SHOWN FOR CLARITY)**

**SECTION E-E
 TYPICAL FLARED SECTION
 (8° TURN SHOWN, 4° TURN SIMILAR)**

**VIEW F-F
 (SHOWING FENDER END WITH CLEARANCE GAUGE; FENDER END WITHOUT CLEARANCE GAUGE SIMILAR)**

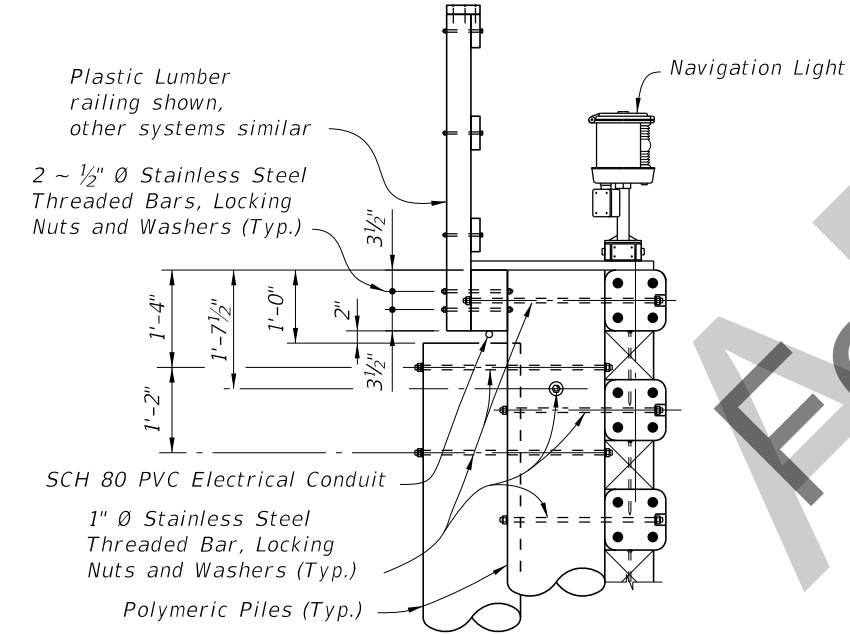

**SECTION H-H
 (CLEARANCE GAUGE NOT SHOWN FOR CLARITY)**

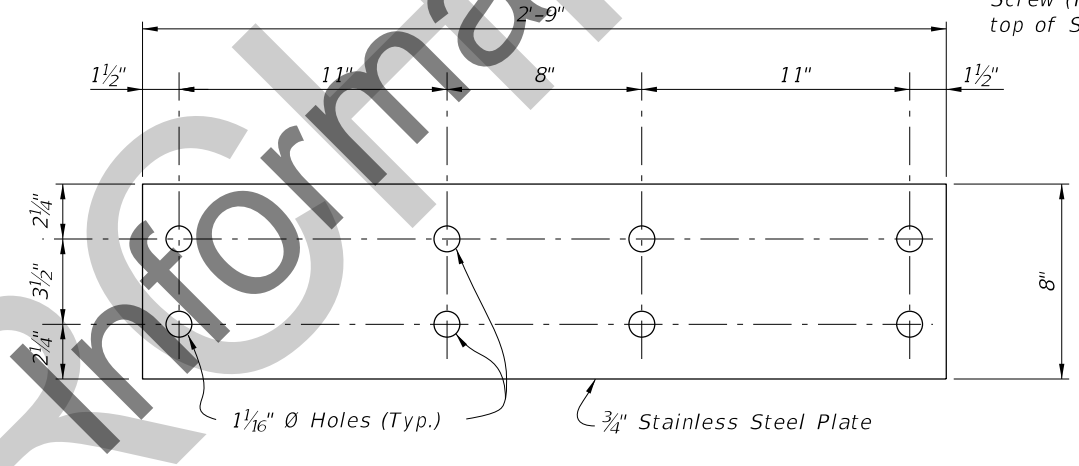

SPLICE PLATE DETAIL

CROSS REFERENCES:
 For Navigation Lights and SCH 80 PVC Electrical Conduit Details see Design Standard Index 21220.
 For Clearance Gauge Details and View G-G see Sheet 6.
 For location of View F-F see Sheet 3.
 For location of Section E-E see Sheet 4.

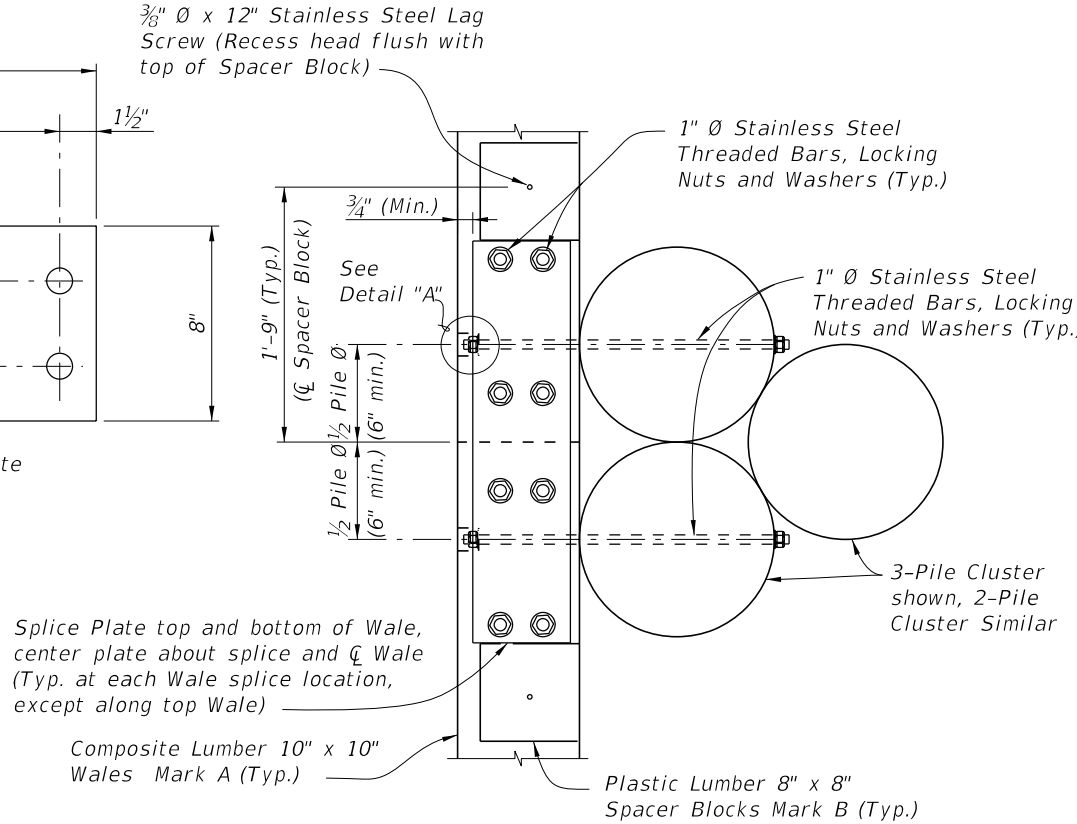

**SECTION E-E
 TYPICAL STRAIGHT SECTION
 FENDER SYSTEM DETAILS**

REVISIONS

DATE	BY	DESCRIPTION	DATE	BY	DESCRIPTION
07/01/11	GJM	New Sheet (Previously Index 21910, Sheet 3); Modified to allow for various pile types and sizes; Changed bolt configurations for connection of Mark D to Mark F. Modified dimensions of splice plate.			

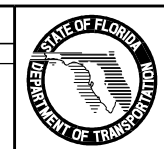

2010 Interim Design Standard
FENDER SYSTEM - POLYMERIC PILES

Interim Date
 07/01/11
 Sheet No.
 5 of 7
 Index No.
21900

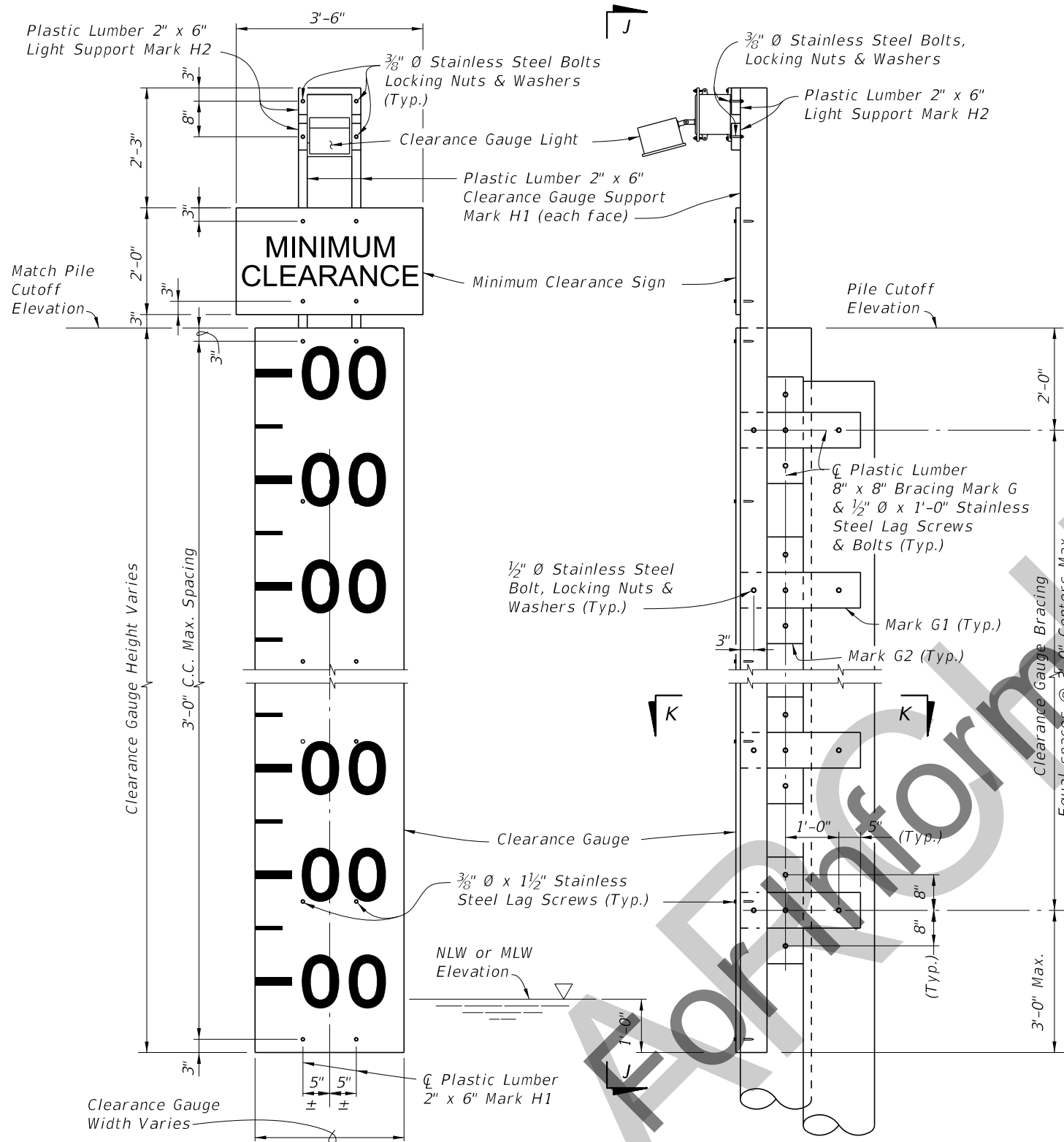

VIEW J-J
(WALES, PILES AND BRACING NOT SHOW FOR CLARITY)

VIEW G-G
(WALES, DECKING AND HANDRAIL NOT SHOWN FOR CLARITY)

CLEARANCE GAUGE DETAILS

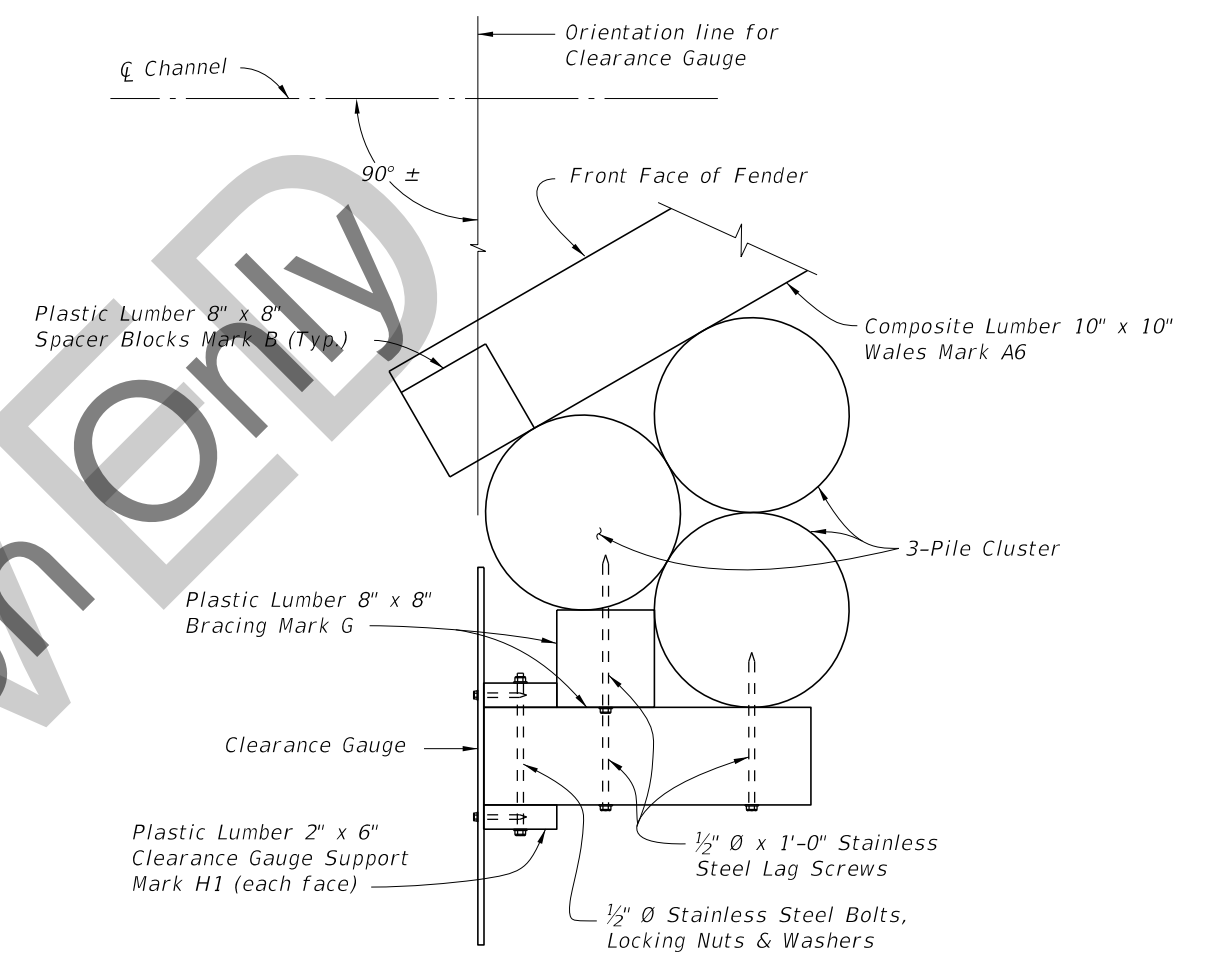

SECTION K-K

CROSS REFERENCES:

For Structural Composite and Plastic Lumber Bill of Materials Quantities and Fender System Table of Variables see Structures Plans.

For location of View G-G see Sheet 5.

FENDER SYSTEM DETAILS

REVISIONS			
DATE	BY	DESCRIPTION	
07/01/11	GJM	New Sheet (Previously Index 21910, Sheet 4); Modified to allow for various pile types and sizes.	

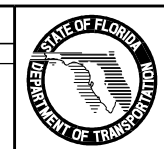

2010 Interim Design Standard

FENDER SYSTEM - POLYMERIC PILES

Interim Date	Sheet No.
07/01/11	6 of 7
Index No.	
21900	

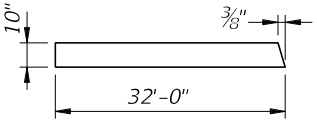
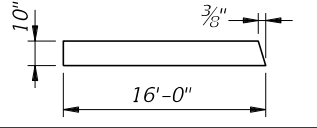
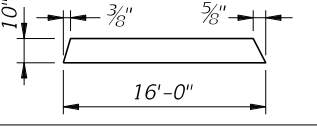
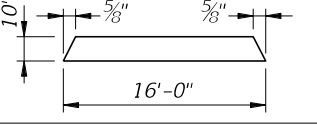
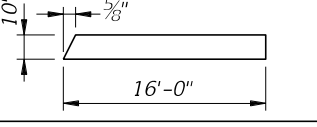
* STRUCTURAL COMPOSITE LUMBER BILL OF MATERIALS					
MARK	SIZE (NOMINAL)	DIMENSIONS	BOARD FT. PER EACH	NO. REQD.	QUANTITY
A1	10" X 10" COMPOSITE LUMBER	32'-0" (STRAIGHT)	266.6	See Estimated Structural Composite and Plastic Lumber Bill of Materials Table in Structures Plans	
A2	10" X 10" COMPOSITE LUMBER		266.6		
A3	10" X 10" COMPOSITE LUMBER		133.3		
A4	10" X 10" COMPOSITE LUMBER		133.3		
A5	10" X 10" COMPOSITE LUMBER		133.3		
A6	10" X 10" COMPOSITE LUMBER		133.3		

* All Plastic Lumber and Composite Lumber Dimensions and Quantities shown are based on Nominal Lumber Dimensions and may vary depending on Actual Lumber Dimension.

** Provide Fiberglass Open Grating in lieu of 2" X 12" Plastic Lumber when called for in the Plans. Mounting hardware shall be Stainless Steel, install per Manufacturer's recommendations. See Structures Plans for Notes and Details.

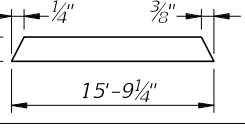
* PLASTIC LUMBER BILL OF MATERIALS					
MARK	SIZE (NOMINAL)	DIMENSIONS	BOARD FT. PER EACH	NO. REQD.	QUANTITY
B	8" X 8" PLASTIC LUMBER	8" (STRAIGHT)	3.6	See Estimated Structural Composite and Plastic Lumber Bill of Materials Table in Structures Plans	
C	2" X 6" PLASTIC LUMBER	16'-0" (STRAIGHT) (Trim & Miter Ends as required)	16.0		
D	4" X 6" PLASTIC LUMBER	4'-4" (STRAIGHT)	8.7		
** E	2" X 12" PLASTIC LUMBER	2'-6" (STRAIGHT) (Miter as required)	5.0		
F1	6" X 10" PLASTIC LUMBER	32'-0" (STRAIGHT)	160.0		
F2	6" X 10" PLASTIC LUMBER		159.6		
F3	6" X 10" PLASTIC LUMBER		79.6		
F4	6" X 10" PLASTIC LUMBER		78.8		
F5	6" X 10" PLASTIC LUMBER		78.4		
F6	6" X 10" PLASTIC LUMBER		79.2		
G1	8" X 8" PLASTIC LUMBER	2'-3" (STRAIGHT)	12.0		
G2	8" X 8" PLASTIC LUMBER	2'-0" (STRAIGHT)	10.7		
H1	2" X 6" PLASTIC LUMBER	PILE CUTOFF ELEV. MINUS NLW OR MLW ELEV. PLUS 5'-6" (STRAIGHT)	1.0 PER LF EACH		
H2	2" X 6" PLASTIC LUMBER	1'-0" (STRAIGHT)	1.0		

REVISIONS

DATE	BY	DESCRIPTION	DATE	BY	DESCRIPTION
07/01/11	GJM	New Sheet (Previously Index 21910, Sheet 5); Removed reference to "Index 21900".			

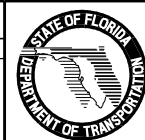

2010 Interim Design Standard

FENDER SYSTEM -
POLYMERIC PILES

Interim Date	Sheet No.
07/01/11	7 of 7
Index No.	
21900	

GENERAL NOTES:

U.S. COAST GUARD NOTIFICATION: Notify the local office of the U.S. Coast Guard at least 30 days prior to beginning of construction of the Fender System.

14" SQUARE PRESTRESSED CONCRETE PILES - Provide 14" Square Prestressed Concrete Piles of sufficient length to achieve a minimum embedment of 20' into soil having a blow count greater than or equal to 6 ($N \geq 6$). Pile splices and build-ups are not permitted. Use only 14" Square Prestressed Concrete Piles with 8 - 1/2" diameter Low Relaxation Strands fabricated in accordance with Index No. 20614.

PLASTIC LUMBER AND STRUCTURAL COMPOSITE LUMBER WALES: Provide only Plastic Lumber and Structural Composite Lumber Wales in accordance with Specification Section 973. Wales shall be continuous and spliced only at locations shown on the plans.

PLASTIC LUMBER DECKING FOR CATWALKS: Provide Plastic Lumber decking for catwalks when called for in the Plans in accordance with Specification Section 973.

Install Plastic Lumber Decking according to manufacturer's recommendations using stainless steel #10 x 3" (minimum) deck screws.

FIBERGLASS OPEN GRATING FOR CATWALKS: Provide Fiberglass Open Grating for catwalks when called for in the Plans. Fiberglass Open Grating shall be a heavy duty design suitable for exterior installations. Maximum gap opening on the walkway surface shall be 1 1/2". Design live loads and deflections shall be a 50 psf uniformly distributed load with a maximum deflection of 3/8" or L/120 at the center of a simple span and a concentrated load of 250 pounds with a maximum deflection of 1/4" at the center of a simple span. Color of Fiberglass Open Grating shall be gray or black.

Install Fiberglass Open Grating according to manufacturer's recommendations using stainless steel hardware, screws, bolts, nuts and washers. Attach Fiberglass Open Grating to Wales and Deck Supports at a 2'-0" maximum spacing so as to resist pedestrian live loads and uplift forces from wind, buoyancy and wave action.

CLEARANCE GAUGE AND LIGHT: Clearance Gauge to be furnished by the FDOT and erected by the Contractor. Clearance Gauge width and numeral height is dependant on visibility distance. The required visibility distance shall be determined by the United States Coast Guard District Commander. Provide and install Clearance Gauge Light in accordance with Specification Section 510 and Index No. 21220.

NAVIGATION LIGHTS: Provide and install Navigation Lights in accordance with Specification Section 510, Index No. 21220 and/or project specific details. Provide and maintain Temporary Navigation Lights during construction until permanent Navigation Lights are operational.

BOLTS, THREADED BARS, NUTS, SCREWS AND WASHERS: Furnish stainless steel Bolts in accordance with ASTM F593 Type 316. Furnish stainless steel Threaded Bars in accordance with ASTM A193 Grade B8M. Furnish stainless steel Nuts in accordance with ASTM F594 Type 316. Furnish stainless steel Screws in accordance with ASTM F593 Type 305. Furnish stainless steel Washers compatible with Bolts, Threaded Rods and Nuts under heads and nuts. Torque Nuts on 1" diameter Bolts and Threaded Bars to 150 lb-ft. Keep threads on Bolts, Threaded Bars and Nuts free from dirt, coarse grime and sand to prevent galling and seizing during tightening.

SPLICE PLATES: Furnish Splice Plates in accordance with ASTM A240 Type 316.

WIRE ROPE: Provide wire rope meeting one of the following requirements:

1. 1/2" diameter 6x19, 6x25 or 6x37 class IWRC Type 316 stainless steel wire rope with a minimum breaking strength of 18,000 lbs.
2. 1/2" diameter 6x19 galvanized wire rope with ultraviolet ray resistant polypropylene impregnation having an outside diameter of 5/8" with a minimum breaking strength of 22,000 lbs. Protect all ends with heat shrinkable end caps compatible with the rope's polypropylene that provide an effective water-tight seal.

FENDER SYSTEM ENERGY CAPACITY:
Energy Capacity = 38 ft-k

GENERAL NOTES

REVISIONS						2010 Interim Design Standard		Interim Date	Sheet No.
DATE	BY	DESCRIPTION	DATE	BY	DESCRIPTION	FENDER SYSTEM - PRESTRESSED CONCRETE PILES		07/01/11	1 of 7
07/01/11	GJM	New Sheet; Added General Notes to separate this Index from polymeric piling fenders.							
								Index No.	21930



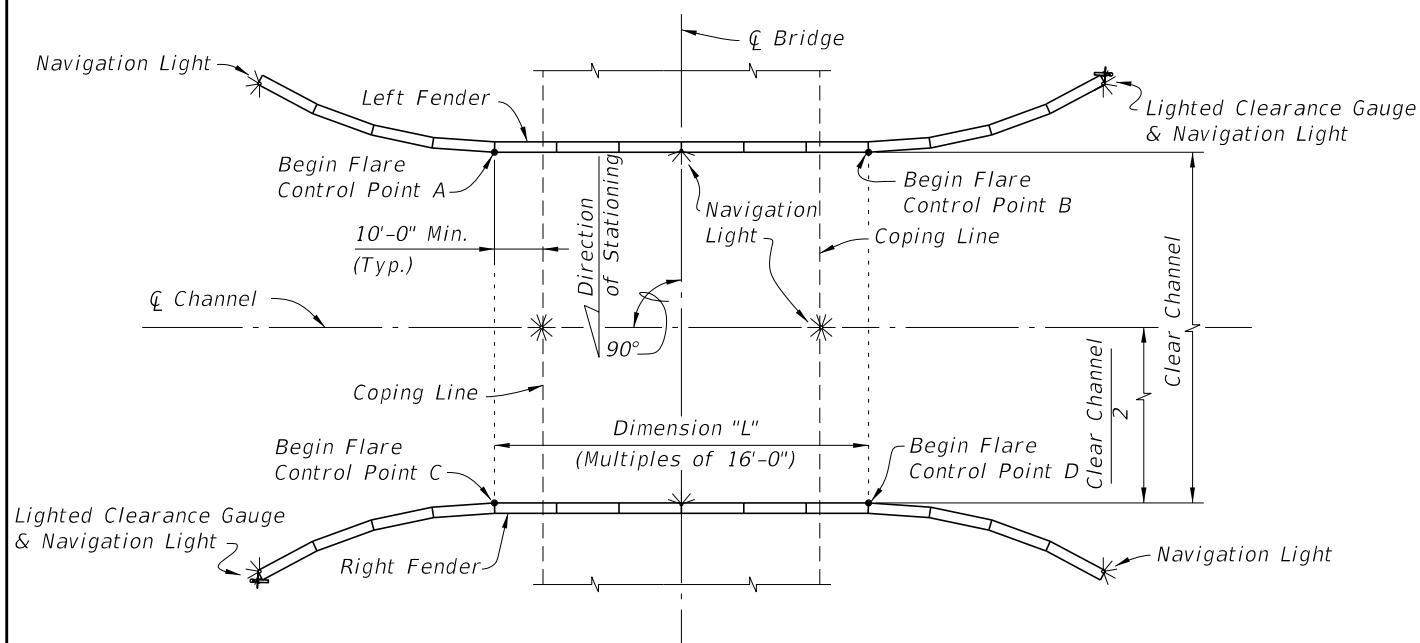

SCHMATIC OF FENDER SYSTEM SHOWING TREATMENT OF SINGLE FIXED BRIDGE WITH NONSKEWED CHANNEL

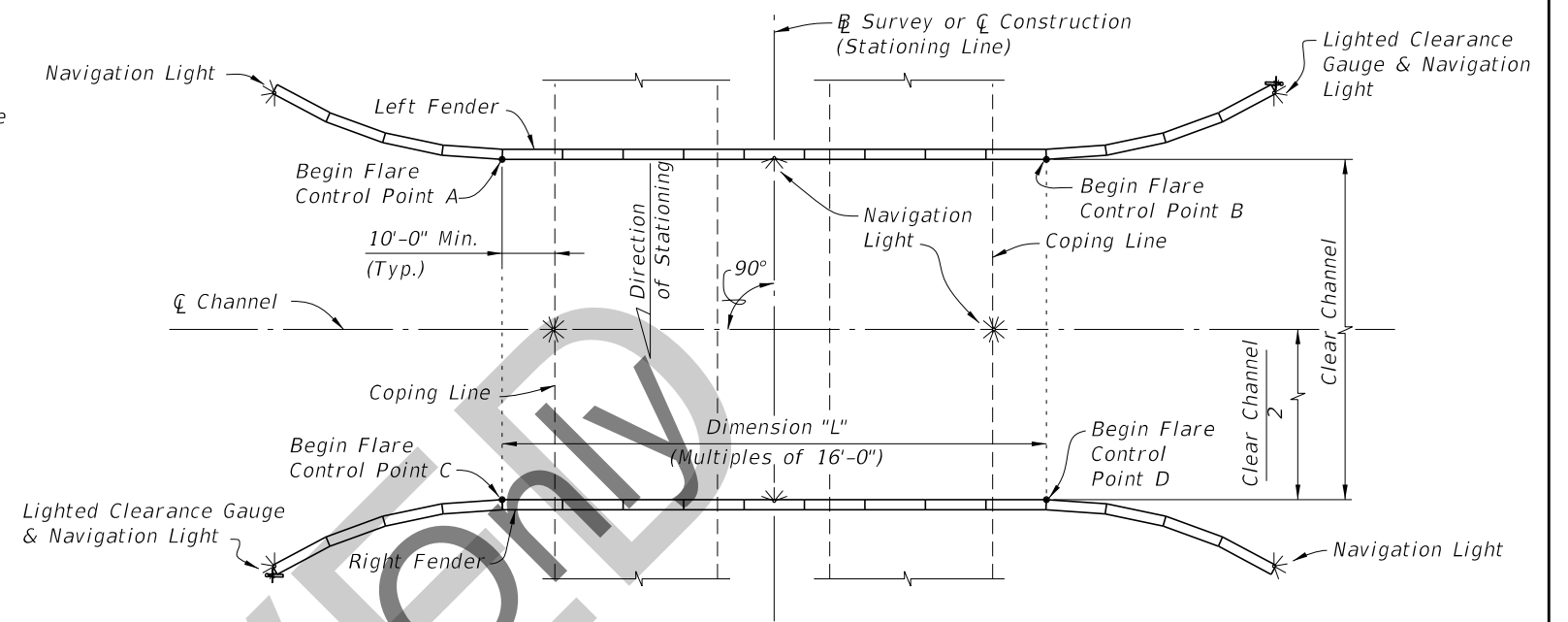

SCHMATIC OF FENDER SYSTEM SHOWING TREATMENT OF DUAL FIXED BRIDGES WITH NONSKEWED CHANNEL (PARALLEL DUAL FIXED BRIDGES SHOWN, NONPARALLEL DUAL FIXED BRIDGES SIMILAR)

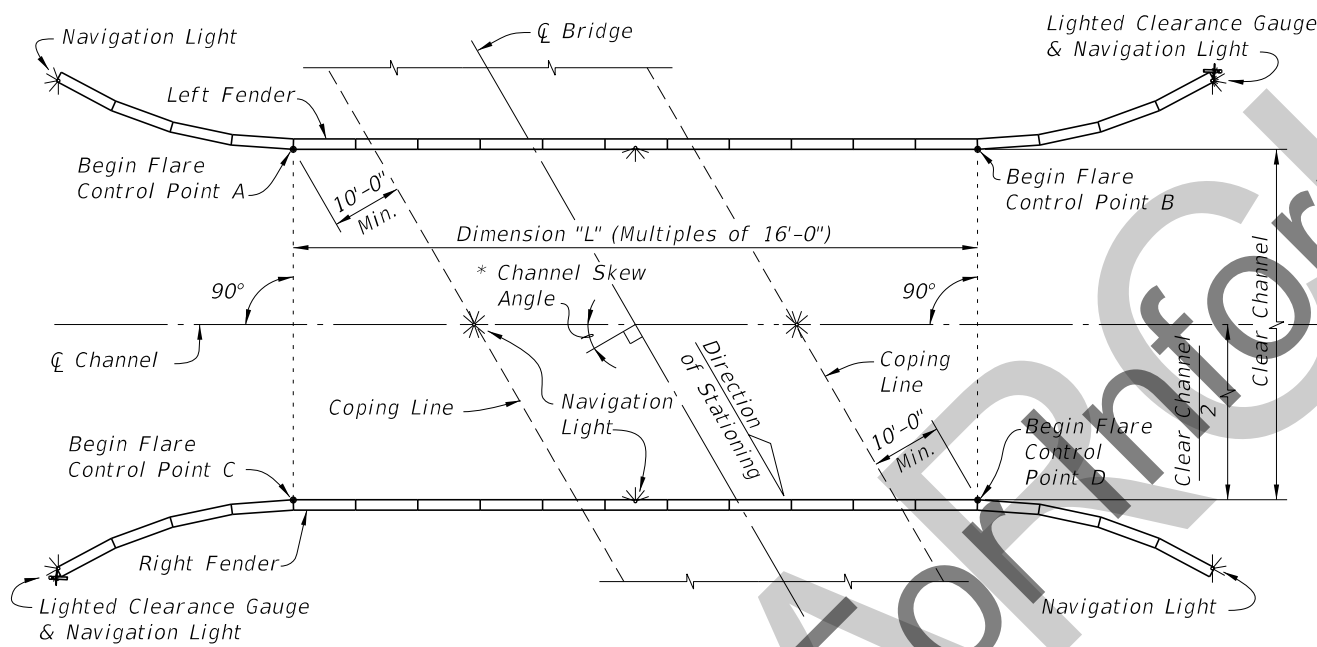

SCHMATIC OF FENDER SYSTEM SHOWING TREATMENT OF SINGLE FIXED BRIDGE WITH SKEWED CHANNEL

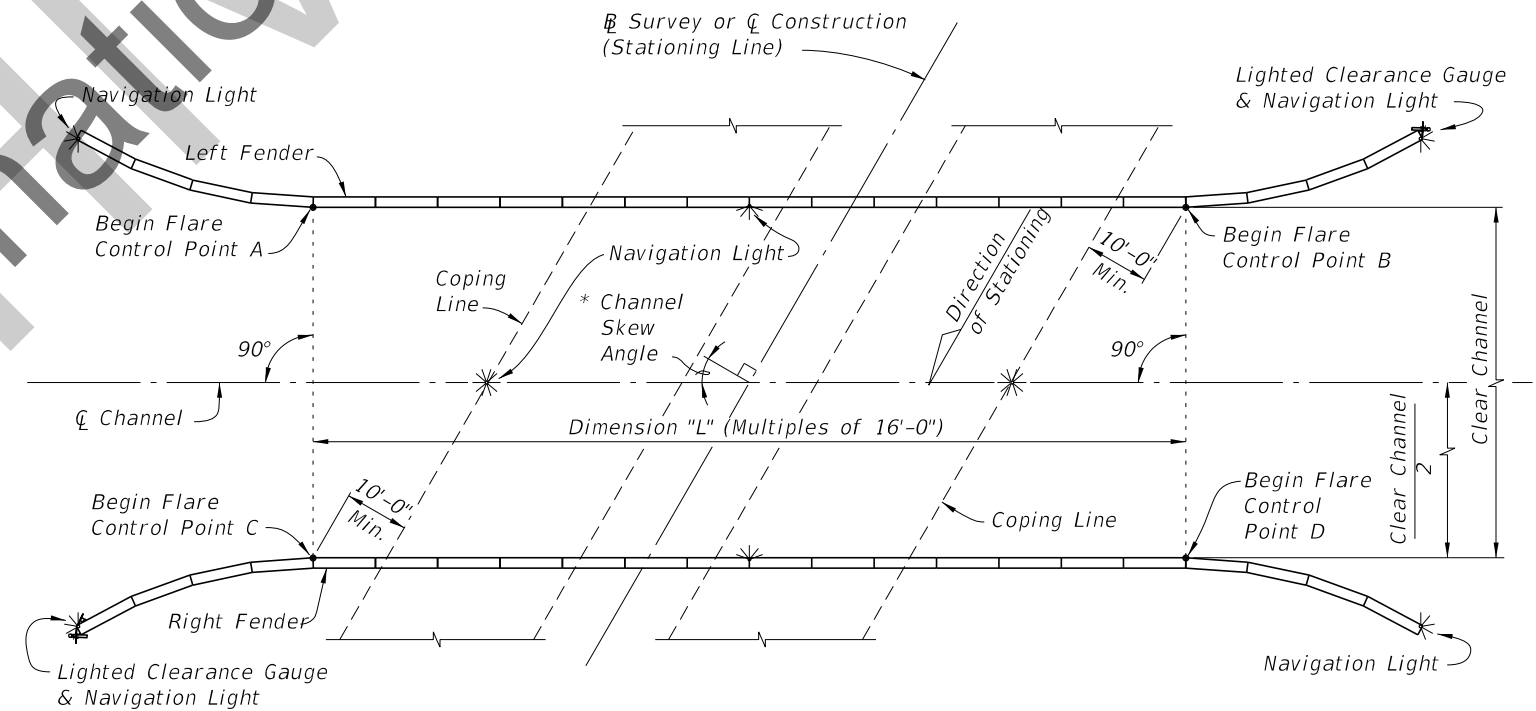

SCHMATIC OF FENDER SYSTEM SHOWING TREATMENT OF DUAL FIXED BRIDGES WITH SKEWED CHANNEL (PARALLEL DUAL FIXED BRIDGES SHOWN, NONPARALLEL DUAL FIXED BRIDGES SIMILAR)

* See Structures Plans, Plan and Elevation and Foundation Layout Sheets for magnitude and orientation of Channel Skew Angle.

CROSS REFERENCES:
 For Stations and Offsets of referenced Control Points A, B, C and D,
 Dimension "L" and Clear Channel Width see Fender System Table
 of Variables in Structures Plans.
 For Navigation Light Details see Design Standards Index 21220.

LAYOUT GEOMETRY

REVISIONS			
DATE	BY	DESCRIPTION	
07/01/11	GJM	New Sheet; Added Schematic details to separate this Index from polymeric piling fenders.	

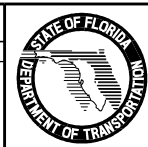

2010 Interim Design Standard
**FENDER SYSTEM -
 PRESTRESSED CONCRETE PILES**

Interim Date: 07/01/11
 Sheet No.: 2 of 7
 Index No.: **21930**

CROSS REFERENCES:

For Sections A-A and B-B see Sheet 4.

For View F-F see Sheet 5.

NOTE:

Plastic Lumber and Composite Lumber Dimensions shown are based on Nominal Lumber Dimensions and may vary depending on Actual Lumber Dimension.

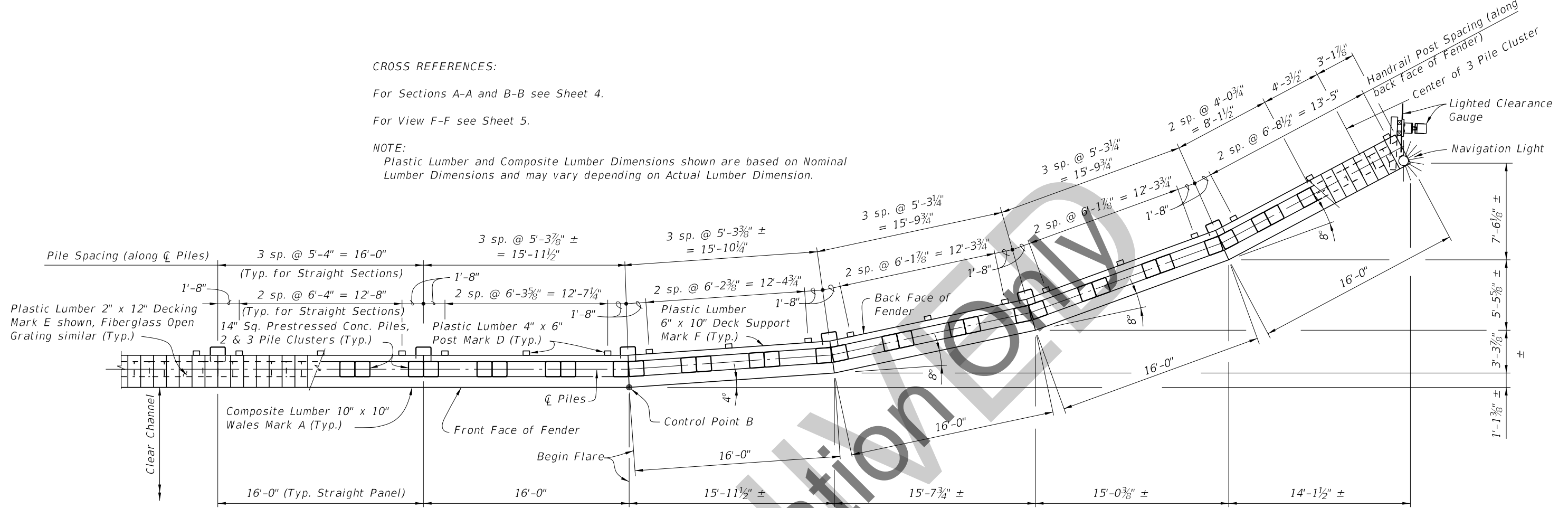

PARTIAL PLAN VIEW (TYPICAL FLARE)
 (FLARE AT CONTROL POINT B SHOWN, CONTROL POINTS A, C & D SIMILAR)
 (HANDRAIL NOT SHOWN FOR CLARITY)

Navigation Light (See Design Standards Index 21220 for locations & Details)

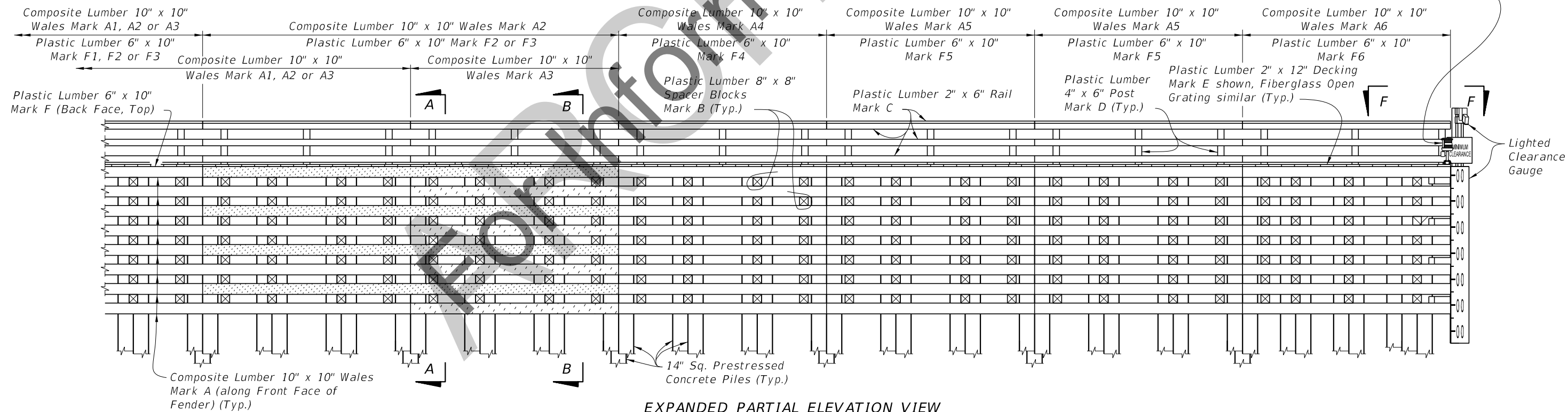

EXPANDED PARTIAL ELEVATION VIEW

REVISIONS					
DATE	BY	DESCRIPTION	DATE	BY	DESCRIPTION
07/01/11	GJM	Changed Title and Cross References.			

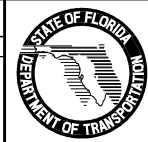

2010 Interim Design Standard
**FENDER SYSTEM -
 PRESTRESSED CONCRETE PILES**

Interim Date: 07/01/11
 Sheet No.: 3 of 7
 Index No.: **21930**

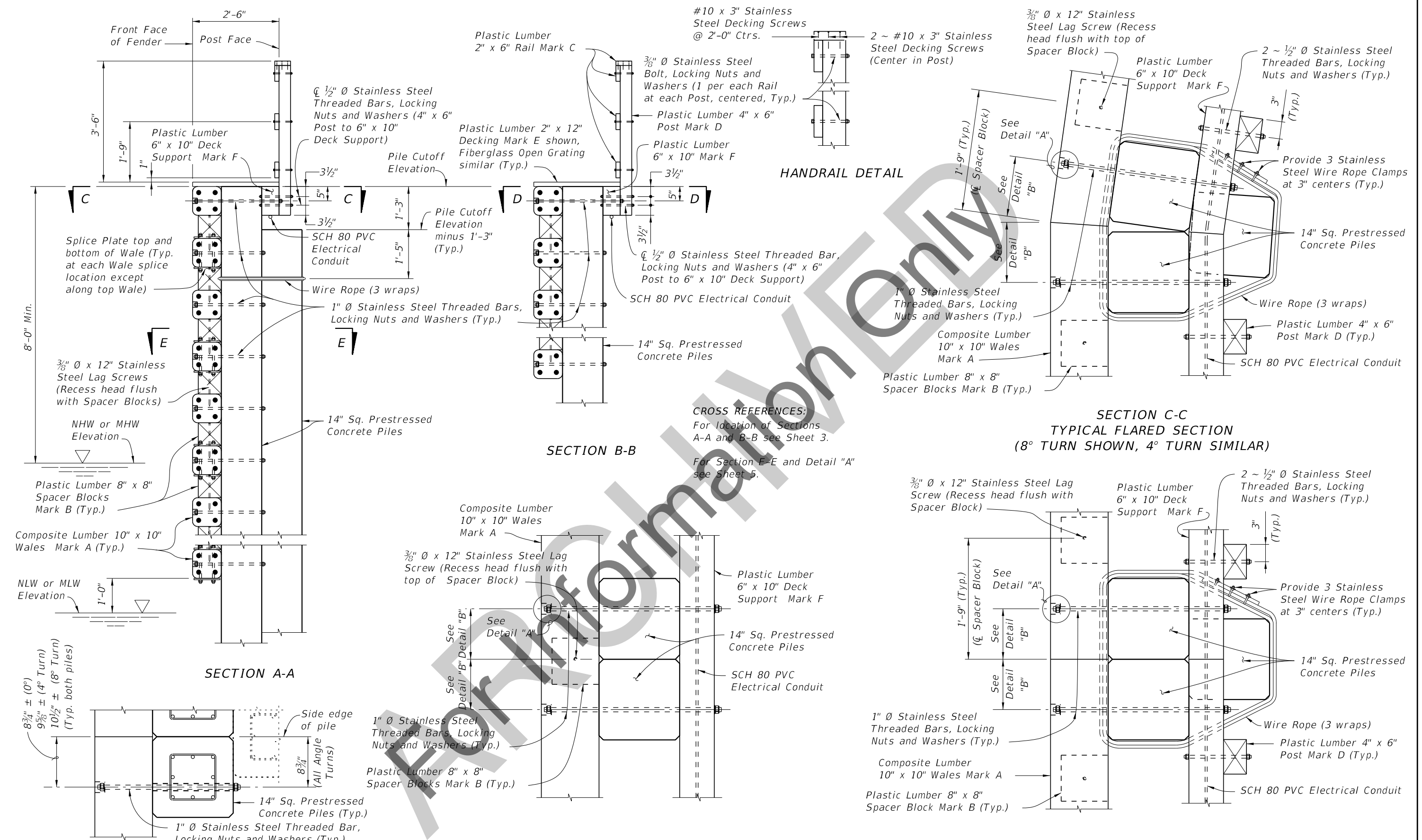

REVISIONS			
DATE	BY	DESCRIPTION	
07/01/11	GJM	Changed Title and Cross References; Changed bolt configuration for connection of Mark D to Mark F.	

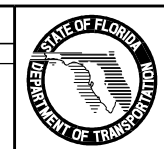

2010 Interim Design Standard
**FENDER SYSTEM -
 PRESTRESSED CONCRETE PILES**

Interim Date: 07/01/11
 Sheet No.: 4 of 7
 Index No.: **21930**

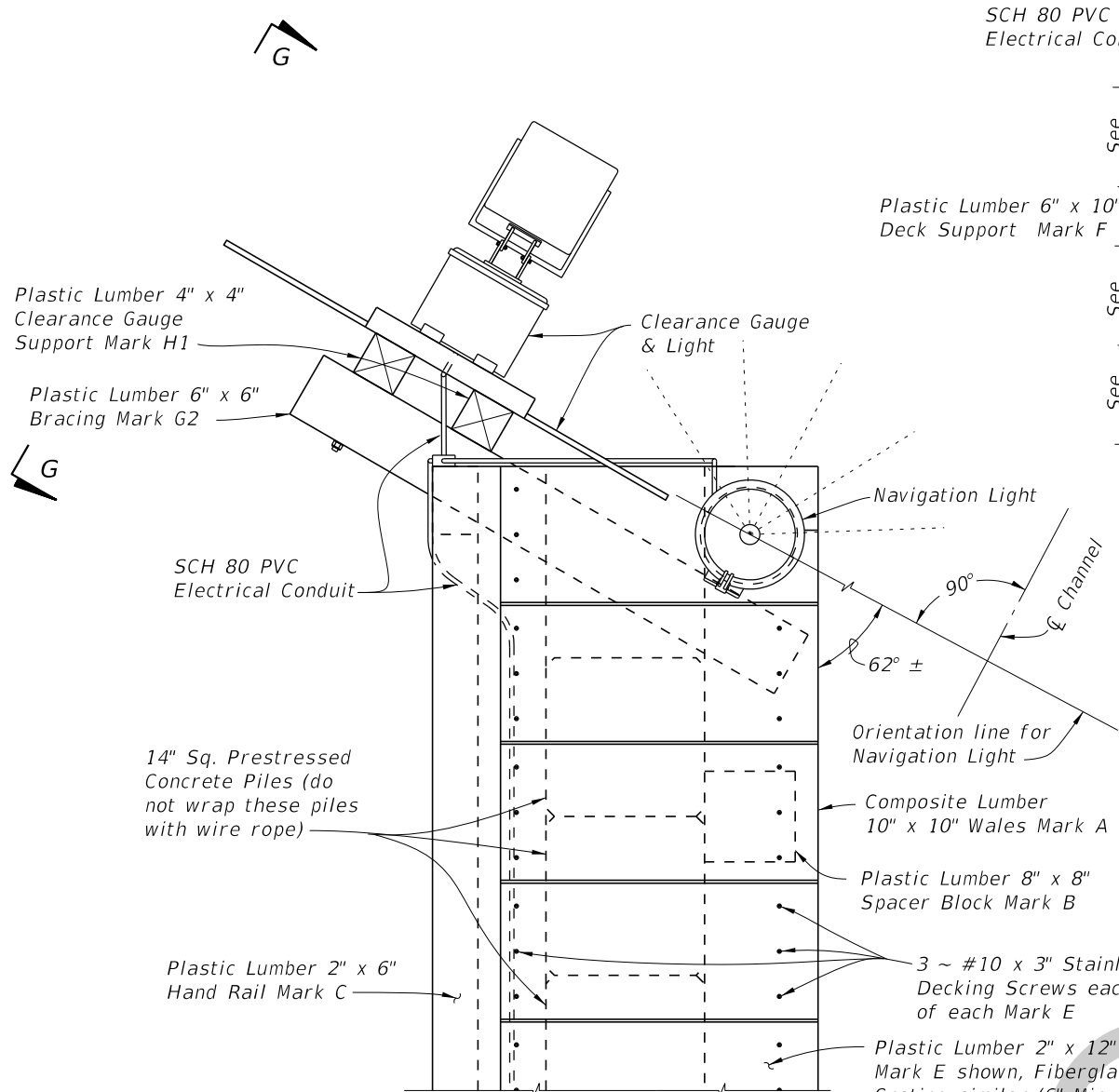

**VIEW F-F
(SHOWING FENDER END WITH CLEARANCE GAUGE)**

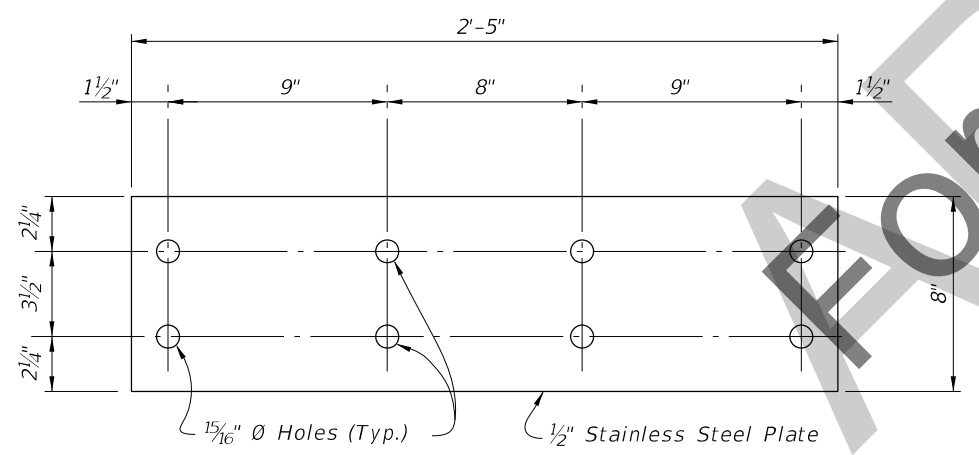

SPLICE PLATE DETAIL

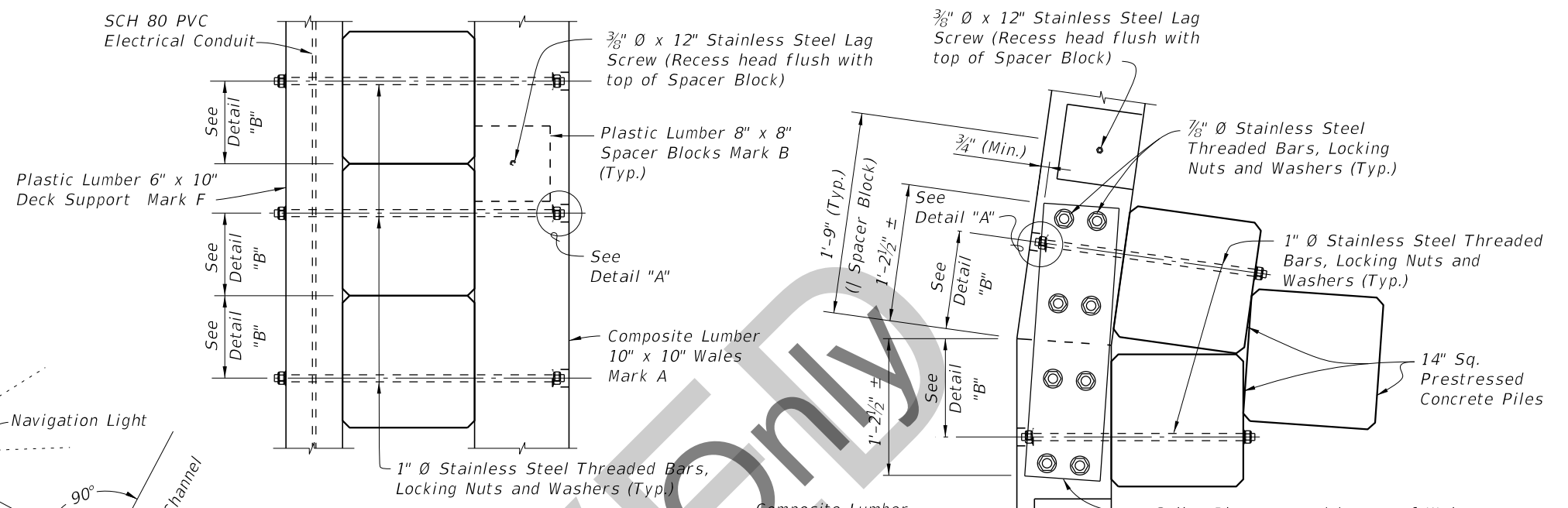

**PARTIAL VIEW F-F
(SHOWING FENDER END; DECKING
AND HANDRAIL NOT SHOWN
FOR CLARITY)**

**SECTION E-E
TYPICAL FLARED SECTION
(8° TURN SHOWN, 4° TURN SIMILAR)**

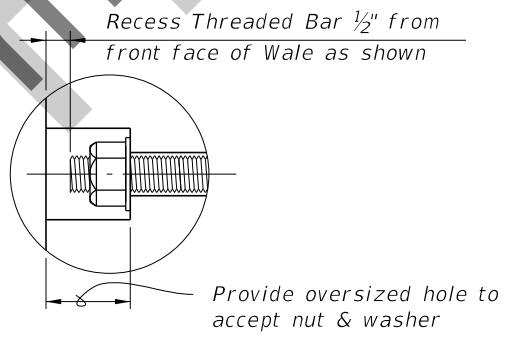

DETAIL "A"

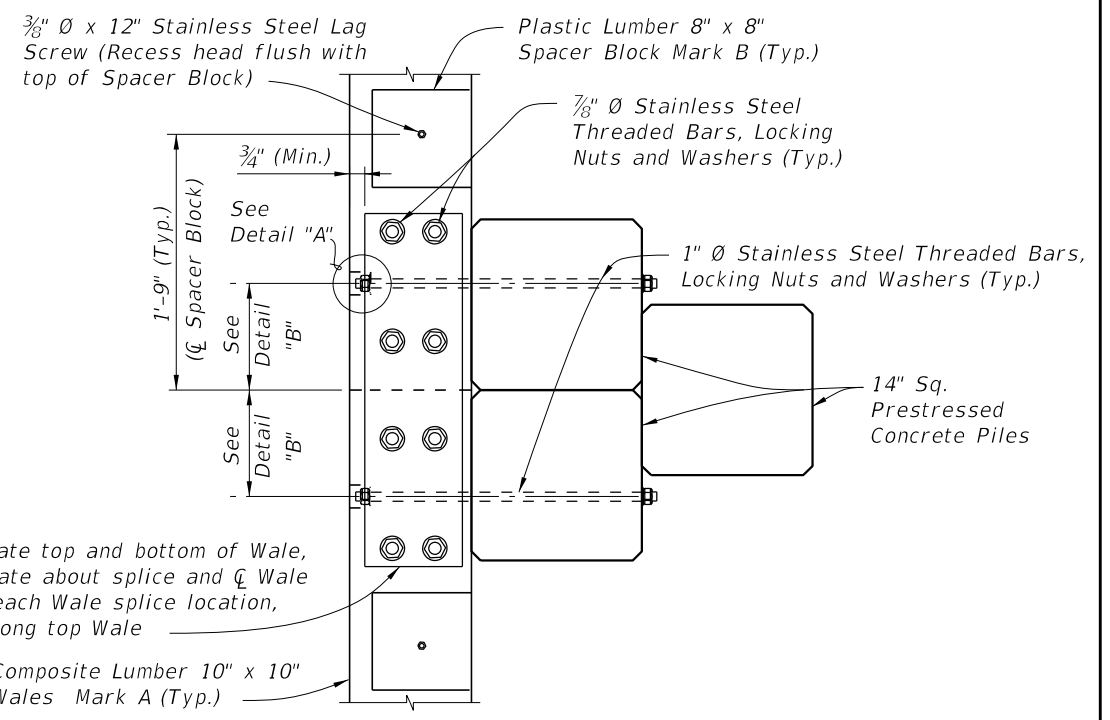

**SECTION E-E
TYPICAL STRAIGHT SECTION**

CROSS REFERENCES:
 For Navigation Lights and SCH 80 PVC Electrical Conduit Details see Design Standard Index 21220.
 For View G-G and Clearance Gauge Details see Sheet 4.
 For Detail "B" and location of Section E-E see Sheet 2.
 For location of View F-F see Sheet 1.

REVISIONS					
DATE	BY	DESCRIPTION	DATE	BY	DESCRIPTION
07/01/11	GJM	Changed Title and Cross References; Changed splice plate dimensions.			

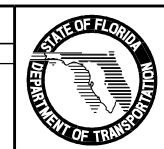

2010 Interim Design Standard
**FENDER SYSTEM -
 PRESTRESSED CONCRETE PILES**

Interim Date: 07/01/11
 Sheet No.: 5 of 7
 Index No.: **21930**

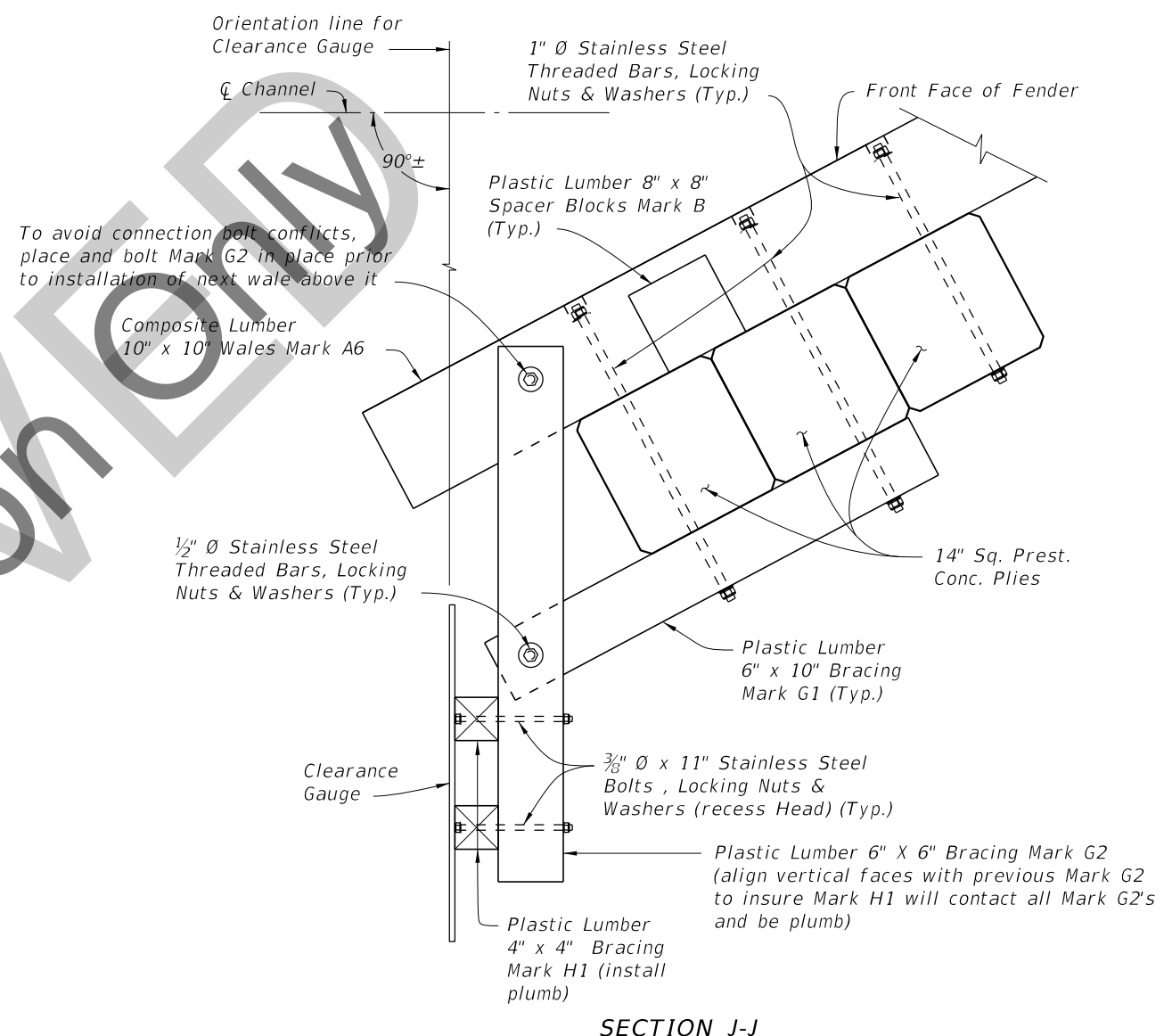
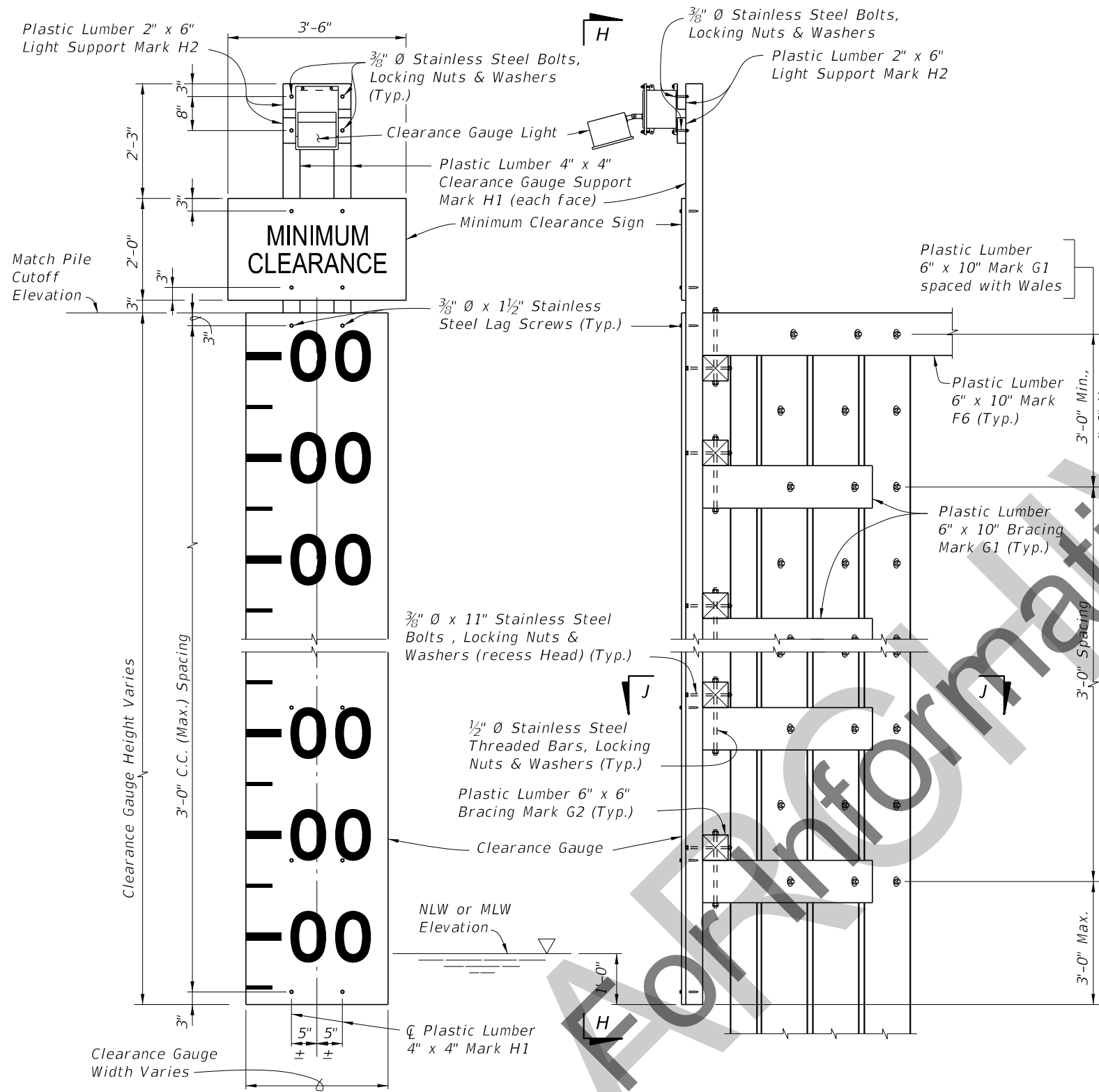

CROSS REFERENCES:

For Estimated Structural Composite and Plastic Lumber Bill of Materials Quantities and Fender System Table of Variables see Structures Plans.

For location of View G-G see Sheet 5.

REVISIONS					
DATE	BY	DESCRIPTION	DATE	BY	DESCRIPTION
07/01/11	GJM	Changed Title and Cross References.			

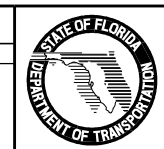

2010 Interim Design Standard

**FENDER SYSTEM -
PRESTRESSED CONCRETE PILES**

Interim Date	Sheet No.
07/01/11	6 of 7
Index No.	
21930	

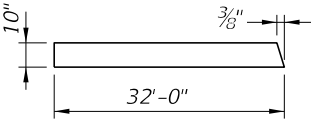
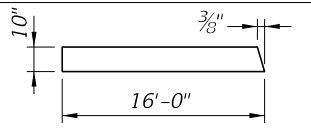
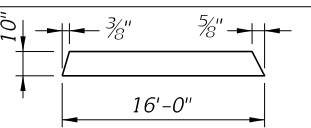
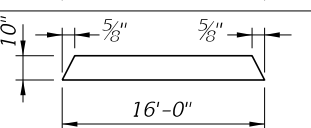
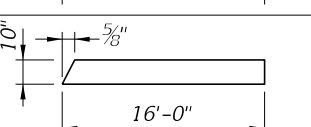
* STRUCTURAL COMPOSITE LUMBER BILL OF MATERIALS					
MARK	SIZE (NOMINAL)	DIMENSIONS	BOARD FT. PER EACH	NO. REQD.	QUANTITY
A1	10" X 10" COMPOSITE LUMBER	32'-0" (STRAIGHT)	266.6	See Estimated Structural Composite and Plastic Lumber Bill of Materials Table in Structures Plans	
A2	10" X 10" COMPOSITE LUMBER		266.6		
A3	10" X 10" COMPOSITE LUMBER		133.3		
A4	10" X 10" COMPOSITE LUMBER		133.3		
A5	10" X 10" COMPOSITE LUMBER		133.3		
A6	10" X 10" COMPOSITE LUMBER		133.3		

* All Plastic Lumber and Composite Lumber Dimensions and Quantities shown are based on Nominal Lumber Dimensions and may vary depending on Actual Lumber Dimension.

** Provide Fiberglass Open Grating in lieu of 2" X 12" Plastic Lumber when called for in the Plans. Mounting hardware shall be Stainless Steel, install per Manufacturer's recommendations. See Structures Plans for Notes and Details.

* PLASTIC LUMBER BILL OF MATERIALS					
MARK	SIZE (NOMINAL)	DIMENSIONS	BOARD FT. PER EACH	NO. REQD.	QUANTITY
B	8" X 8" PLASTIC LUMBER	8" (STRAIGHT)	3.6	See Estimated Structural Composite and Plastic Lumber Bill of Materials Table in Structures Plans	
C	2" X 6" PLASTIC LUMBER	16'-0" (STRAIGHT) (Trim & Miter Ends as required)	16.0		
D	4" X 6" PLASTIC LUMBER	4'-4" (STRAIGHT)	8.7		
** E	2" X 12" PLASTIC LUMBER	2'-6" (STRAIGHT) (Miter as required, 6" min. width)	5.0		
F1	6" X 10" PLASTIC LUMBER	32'-0" (STRAIGHT)	160.0		
F2	6" X 10" PLASTIC LUMBER		159.6		
F3	6" X 10" PLASTIC LUMBER		79.6		
F4	6" X 10" PLASTIC LUMBER		78.8		
F5	6" X 10" PLASTIC LUMBER		78.4		
F6	6" X 10" PLASTIC LUMBER		79.3		
G1	6" X 10" PLASTIC LUMBER	3'-8" (STRAIGHT)	18.3		
G2	6" X 6" PLASTIC LUMBER	4'-1" (STRAIGHT)	12.3		
H1	4" X 4" PLASTIC LUMBER	PILE CUTOFF ELEV. MINUS NLW OR MLW ELEV. PLUS 5'-6" (STRAIGHT)	1.3 PER LF EACH		
H2	2" X 6" PLASTIC LUMBER	1'-2" (STRAIGHT)	1.2		

REVISIONS

DATE	BY	DESCRIPTION	DATE	BY	DESCRIPTION
07/01/11	GJM	Changed Title and Cross References.			

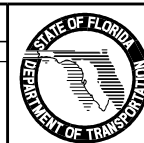

2010 Interim Design Standard

FENDER SYSTEM - PRESTRESSED CONCRETE PILES

Interim Date	Sheet No.
07/01/11	7 of 7
Index No.	
21930	

Attachment B:

IDS, Index 21900 Fender Systems – Polymeric Piles

IDS, Index 21930 Fender Systems – Prestressed Concrete Piles

ARCHIVED

Index 21900 Fender System - Polymeric Piles (Rev. 07/11)

Design Criteria

Structures Design Guidelines (SDG) 3.14

Design Assumptions and Limitations

Design Standards Index 21900 includes standard geometry and details for Polymeric Fender Systems.

Refer to **SDG** 3.14 for Fender System design criteria, assumptions and limitations.

Use this standard with Index 21220.

Plan Content Requirements

In the Structures Plans:

Prepare and include in the plans supplemental project specific designs and details for the following items:

- Electrical service for navigation lights including conduit path from bridge to fender system and identification of service point. Coordinate design with Index 21220 and **Specification** Section 510.
- Access ladders and catwalks from bridge to fender system are optional and may be included at the discretion of the District.

Designate in the plans the type of decking material to be used for catwalks: 2" x 12" Plastic Lumber or Fiberglass Open Grating. Catwalk decking material shall be determined by the District.

Complete the following "Data Tables" and include them in the plans. One "Estimated Bill of Materials Table", one "Fender System Table of Variables" and one "Estimated Quantities Block" are required for each Fender System location within a project. For projects with multiple fender systems or configurations, clearly note which Fender System the Tables and Blocks are applicable to. Place the value for "Required Energy" of each Fender System in the note provided. The Contractor will use this "Required Energy" value to select the appropriate fender system from the QPL. See [Introduction I.3](#) for more information regarding use of Data Tables.

Table for use with Index 21900 Fender System - Polymeric Piles:

ESTIMATED BILL OF MATERIALS FENDER SYSTEM - POLYMERIC PILES DESIGN STANDARDS INDEX NO. 21900				Table Date 07-01-11
MARK	NO. REQ'D.	UNIT	QUANTITY	
A1		MB		
A2		MB		
A3		MB		
A4		MB		
A5		MB		
A6		MB		
B		MB		
C		MB		
D		MB		
* E		MB		
F1		MB		
F2		MB		
F3		MB		
F4		MB		
F5		MB		
F6		MB		
G1		MB		
G2		MB		
H1		MB		
H2		MB		

NOTE: For Member Marks, Sizes and Dimensions see Design Standards Index No. 21900, Sheet 7.

Bill of Materials Table above is for an entire fender system (left and right fenders).

* Provide 2'-6" wide Fiberglass Open Grating for full length of fender in lieu of 2" X 12" Plastic Lumber when called for in Plans. Provide Stainless Steel Mounting Hardware and install per Manufacturer's recommendations. See Index 21900 for notes. Include the cost of Fiberglass Open Grating and miscellaneous items required to install the grating in the price for Plastic Marine Lumber (Non-Reinforced).

ESTIMATED QUANTITIES, INDEX NO. 21900			Table Date 07-01-11
MARK	UNIT	QUANTITY	
Plastic Marine Lumber (Reinforced)	MB		
Plastic Marine Lumber (Non-Reinforced)	MB		
Polymeric Piles	LS		

NOTE: Estimated Quantities are for one entire fender system (left and right fenders).

FENDER SYSTEM TABLE OF VARIABLES INDEX NO. 21900			Table Date 07-01-11
CONTROL POINTS	STATION	OFFSET Lt. or Rt.	
A			
B			
C			
D			
DIMENSION "L"			
CLEAR CHANNEL WIDTH			
CHANNEL SKEW ANGLE			
MHW or NHW ELEVATION			
MLW or NLW ELEVATION			
PILE CUTOFF ELEVATION			
MINIMUM PILE TIP ELEVATION LEFT FENDER		**	
PILE LENGTH LEFT FENDER		**	
MINIMUM PILE TIP ELEVATION RIGHT FENDER		**	
PILE LENGTH RIGHT FENDER		**	
NUMBER OF WALE ROWS			

NOTE: Work this Table with Design Standards Index 21900.

** See QPL drawings for required pile embedment lengths to determine pile tip elevations and pile lengths.

See the Qualified Products List for approved fender system pile configurations. Select a pile configuration having an Energy Capacity greater than the following Required Energy: Fender System Required Energy = _____ ft-k

Payment

Include quantity for Composite Marine Lumber 10" X 10" Wales Mark A under Pay Item for Plastic Marine Lumber (Reinforced). Include quantity for all other Plastic Lumber under Pay Item for Plastic Marine Lumber (Non-Reinforced).

Item number	Item description	Unit Measure
471-1-1	Fender System, Plastic Marine Lumber, Reinforced	MB
471-1-2	Fender System, Plastic Marine Lumber, Non- Reinforced	MB
471-2	Fender System, Polymeric Piles	LS

ARCHIVED
For Information Only

Index 21930 Fender Systems - Prestressed Concrete Piles (Rev. 07/11)

Design Criteria

Structures Design Guidelines (SDG) 3.14

Design Assumptions and Limitations

Do not use this fender system unless approved by the District for use on the specific project.

Design Standards Index 21930 includes a fully designed Fender System with 14" square prestressed concrete piling having an **"Energy Capacity" of 38 ft-kip.**

Refer to **SDG** 3.14 for additional Fender System design criteria, assumptions and limitations.

Use this standard with Index 21220.

Plan Content Requirements

In the Structures Plans:

Include both Indexes 21900 and 21930 as alternates. The Contractor will select which fender system to construct. See also the IDS for Index 21900 plan requirements.

Prepare and include in the plans supplemental project specific designs and details for the following items:

- Electrical service for navigation lights including conduit path from bridge to fender system and identification of service point. Coordinate design with Index 21220 and **Specification** Section 510.
- Access ladders and catwalks from bridge to fender system are optional and may be included at the discretion of the District.

Designate in the plans the type of decking material to be used for catwalks: 2" x 12" Plastic Lumber or Fiberglass Open Grating. Catwalk decking material shall be determined by the District.

Complete the following "Data Tables" and include them in the plans. One "Estimated Bill of Materials Table", one "Fender System Table of Variables" and one "Estimated Quantities Block" are required for each Fender System location within a project. For projects with multiple fender systems or configurations, clearly note which Fender System the Tables and Blocks are applicable to. See **Introduction I.3** for more information regarding use of Data Tables.

Base the Minimum Pile Tip Elevations on the minimum embedment of 20 feet for the 14" square prestressed concrete piles into soil having a blow count (N) greater than 6.

Table for use with Index 21930 Fender Systems - Prestressed Concrete Piles:

ESTIMATED BILL OF MATERIALS FENDER SYSTEM - PRESTRESSED CONCRETE PILES DESIGN STANDARDS INDEX NO. 21930				Table Date 07-01-11
MARK	NO. REQ'D.	UNIT	QUANTITY	
A1		MB		
A2		MB		
A3		MB		
A4		MB		
A5		MB		
A6		MB		
B		MB		
C		MB		
D		MB		
* E		MB		
F1		MB		
F2		MB		
F3		MB		
F4		MB		
F5		MB		
F6		MB		
G1		MB		
G2		MB		
H1		MB		
H2		MB		

NOTE: For Member Marks, Sizes and Dimensions see Design Standards Index No. 21930, Sheet 7.

Bill of Materials Table above is for an entire fender system (left and right fenders).

* Provide 2'-6" wide Fiberglass Open Grating for full length of fender in lieu of 2" X 12" Plastic Lumber when called for in Plans. Provide Stainless Steel Mounting Hardware and install per Manufacturer's recommendations. See Index 21930 for notes. Include the cost of Fiberglass Open Grating and miscellaneous items required to install the grating in the price for Plastic Marine Lumber (Non-Reinforced).

FENDER SYSTEM TABLE OF VARIABLES INDEX NO. 21930			Table Date 07-01-11
CONTROL POINTS	STATION	OFFSET Lt. or Rt.	
A			
B			
C			
D			
DIMENSION "L"			
CLEAR CHANNEL WIDTH			
CHANNEL SKEW ANGLE			
MHW or NHW ELEVATION			
MLW or NLW ELEVATION			
PILE CUTOFF ELEVATION			
MINIMUM PILE TIP ELEVATION LEFT FENDER			
PILE LENGTH LEFT FENDER			
MINIMUM PILE TIP ELEVATION RIGHT FENDER			
PILE LENGTH RIGHT FENDER			
NUMBER OF WALE ROWS			

NOTE: Work this Table with Design Standards Index 21930.

ESTIMATED QUANTITIES, INDEX NO. 21930			Table Date 07-01-11
MARK	UNIT	QUANTITY	
Plastic Marine Lumber (Reinforced)	MB		
Plastic Marine Lumber (Non-Reinforced)	MB		
14" Sq. Prestressed Concrete piles	LF		

NOTE: Estimated Quantities are for one entire fender system (left and right fenders).

Payment

Include quantity for Composite Marine Lumber 10" X 10" Wales Mark A under Pay Item for Plastic Marine Lumber (Reinforced). Include quantity for all other Plastic Lumber under Pay Item for Plastic Marine Lumber (Non-Reinforced).

In TRNS*PORT, include estimated quantities for both Index 21900 and Index 21930 fender systems as alternates.

Item number	Item description	Unit Measure
471-1-1	Fender System, Plastic Marine Lumber, Reinforced	MB
471-1-2	Fender System, Plastic Marine Lumber, Non- Reinforced	MB
455-34-2	Prestressed Concrete Piling, 14" Sq.	LF

For Information Only

Attachment C:

Structures Design Guidelines, Section 3.14

ARCHIVED

3 SUBSTRUCTURE AND RETAINING WALLS

3.14 FENDER SYSTEMS

3.14.1 General

- A. Bridge fender systems serve primarily as navigation aids to vessel traffic by delineating the shipping channel beneath bridges. Fender systems must be robust enough to survive a multitude of bumps and scrapes from barge traffic, while being sufficiently flexible to absorb kinetic energy when redirecting an errant barge or other vessel. It is expected that this type of design will minimize the potential for damage to vessels and fenders during a minor collision while being able to redirect some vessel impacts that would otherwise destroy a more rigid style fender system
- B. The Department determines when fender systems or other protective features are required and requests U.S. Coast Guard (USCG) concurrence with plan details and locations. Coordination with the Army Corps of Engineers and local government agencies is also encouraged as they may have plans that could affect the channel alignment/depth and/or type/volume of vessel traffic.
- C. A fender system will be required for the majority of bridges over navigable waterways in Florida under the jurisdiction of the USCG. In some cases, circumstances such as deep water, poor soil conditions and /or heavy vessel traffic will lead to long span designs of bridges. If the bridge span is approximately 2.5 times the required navigation channel and the navigation channel is centered on the span, omit a fender system unless required by the USCG. Each bridge site is unique and the USCG will evaluate the Department's plans based on local characteristics such as accident history, water velocities and cross currents, geometry of the channel, etc. If a fender system is omitted, a conservative approach should be taken with respect to the minimum pier strength requirements as developed with the Vessel Collision Risk Analysis.
- D. Acceptable fender systems include:
 1. Design Standard Index 21900 with associated QPL listed pile configurations for use at locations with or without steel hulled commercial barge traffic.
 2. If allowed by the District, Design Standard Index 21930 for use only at locations where steel hulled commercial barge traffic is non-existent.
 3. A custom designed fender system based on Design Standard Index 21900. A custom design will be required where:
 - a. The channel depth and/or in situ soil properties are outside of the design assumptions listed below.
 - b. The standard geometry shown on Design Standard Index 21900 cannot be used.

- E. Dolphins and islands can be used to protect existing bridge substructures that were not designed to resist vessel collision loads and in some cases are used to protect the substructures of bridges located at port facilities. Typically the use of dolphins and islands is discouraged as they also represent a hazard to vessels, aggravate scour and increase water flow velocities. The use of dolphins and islands will require customized designs and usually will include extensive hydraulic and geotechnical evaluations.

3.14.2 EOR's Design Procedure

- A. Use the following procedure for determining the fender system type and associated "Required Energy" (required energy absorption capacity), as defined below, that are to be shown in the plans.
- B. Determine if steel hulled barge traffic is present using the Past Point map link below: <http://www.dot.state.fl.us/structures/pastpointmaps/vppm.shtm>
If there is a Past Point at the fender location, steel hulled commercial barge traffic is present.
- C. Fender system design and energy absorption requirements where steel hulled commercial barge traffic exists:
 - 1. Use fender systems with polymeric piles. These fender systems must resist the "Required Energy" which is defined as the "Minimum Energy" (minimum energy absorption capacity) obtained from [Table 3.14.2-1](#) plus any "Additional Energy" (additional energy absorption capacity) at the discretion of the District Structures Design Engineer or District Structures Maintenance Engineer. The "Minimum Energy" is based on the fender system location and the 90th percentile of barge traffic at that location. When determining the need for "Additional Energy" requirements, consider site conditions, past accident history, maintenance records, volume and size of vessel traffic and bridge main span length relative to channel width. Contact the SDO for assistance in determining the magnitude of "Additional Energy" and/or if the 100th percentile of barge traffic is desired.
 - 2. Determine the Past Point of the fender system using the Past Point map link provided above.
 - 3. Using the Past Point of the fender system obtained from the appropriate Past Point map, enter [Table 3.14.2-1](#) to determine the "Minimum Energy".
 - 4. Verify that the combination of project specific required freestanding pile height and soil properties are within the design assumptions listed in [3.14.3.E.1](#) and the fender height requirements shown on Design Standards Index 21900, and that a QPL listed pile configuration is available that provides the necessary "Required Energy". Where "Required Energy" values exceed the "Energy Capacity" (energy absorption capacity) of the QPL listed polymeric pile configurations, configurations having the highest "Energy Capacity" of all approved polymeric pile configurations may be used at the discretion of the District. Otherwise use a custom fender system design. Include half of the scour depth determined for the 100-yr storm when determining required freestanding pile height.

5. Use Design Standards Index 21900 unless a custom design is required. See the Instructions for Design Standards (IDS) Index 21900 for more information and plan content requirements.
6. Establish fender location so as to provide the required horizontal navigation clearance and where economically feasible also provide an offset of 10 feet between the back of the fender and the near face of the adjacent pier or footing.

Table 3.14.2-1 Table of Past Points and associated Minimum Energies

Past Point	Minimum Energy (k-ft)	Past Point	Minimum Energy (k-ft)	Past Point	Minimum Energy (k-ft)	Past Point	Minimum Energy (k-ft)
1	466	14	201	27	455	40	273
2	437	15	445	28	199	41	248
3	205	16	557	29	199	42	179
4	233	17	571	30	233	43	179
5	213	18	434	31	423	44	190
6	218	19	2426	32	206	45	190
7	218	20	244	33	218	46	199
8	492	21	237	34	188	47	261
9	179	22	179	35	218	48	261
10	54	23	412	36	221	49	206
11	54	24	199	37	273	50	209
12	54	25	458	38	1387	51	208
13	254	26	479	39	2426	52	208

Commentary: The “Minimum Energy” for each Past Point shown in Table 3.14-1 has been determined by following the procedure as outlined in the commentary of the AASHTO “Guide Specification and Commentary for Vessel Collision Design of Highway Bridges”, Second Edition, 2009, Section C3.8. Assumptions made in determining the “Minimum Energy” are as follows:

$$\mu = 0.15$$

$$\alpha = 15 \text{ degrees}$$

$$V = 6.4 \text{ fps}$$

W = as determined by the maximum barge weight plus the tug weight specific to each Past Point (If needed, contact the SDO for more information).

- D. At locations where barge traffic is nonexistent, use fender systems with either polymeric piles or prestressed concrete piles at the discretion of the District Structures Design Engineer or District Structures Maintenance Engineer. The “Required Energy” for these fender systems with polymeric piles is 38 (k-ft) which is

equal to the “Energy Capacity” of the fender system shown in Index 21930. See the Instructions for Design Standards (IDS) Index 21900 or 21930, as applicable, for more information and plan content requirements.

- E. When a custom fender system design is required due to the condition(s) listed in [3.14.1.D.3.a](#) and the use of polymeric piles is preferred by the District, fully detail the custom fender system geometry in the plans but do not show mandatory pile configurations. Utilize the standard geometry, wales and dimensional lumber shown on Design Standards Index 21900 as applicable. Include custom Data Tables in the plans based on those used for Design Standards Index 21900 and place the “Required Energy” in the Data Table Notes. Delete from the Data Table Notes the note requiring that a QPL listed fender system configuration be used. List the soil properties including unit weight, angle of internal friction (ϕ) and subgrade modulus and the distance from the top of the fender to the top of the soil layer having an N value greater than or equal to 6. Include the following associated Plan Notes:
1. This information is to be used by the Supplier's EOR to complete the custom fender system design utilizing piles of the same type and materials as shown on a QPL listed pile configuration.
 2. Submit shop drawings and associated calculations to the Engineer for approval.

See also the Instructions for Design Standards (IDS) Index 21900 for examples of applicable information and plan content requirements. Develop and include in the plans package a Modified Special Provision for Specification 471 that deletes the requirements for using QPL listed pile configurations.

Commentary: In this scenario, the Supplier's EOR develops a custom fender system design and pile configurations using QPL listed pile products, and the fender system geometry and soils information shown in the plans. The custom fender system design is submitted to the Engineer for approval using the shop drawing process.

- F. When a custom fender system design is required due to the condition(s) listed in [3.14.1.D.3.a](#) and the use of other pile types or materials is preferred by the District, fully detail the custom fender system in the plans utilizing the selected pile type. Utilize the standard geometry, wales and dimensional lumber shown on Design Standards Index 21900 as applicable. Include custom Data Tables in the plans based on those used for Design Standards Index 21900 and place the “Required Energy” in the Data Table Notes. Delete from the Data Table Notes the note requiring that a QPL listed fender system configuration be used. See also the Instructions for Design Standards (IDS) Index 21900 for examples of applicable information and plan content requirements. Develop and include in the plans package a Modified Special Provision for Specification 471 that deletes the requirements for using polymeric piles. Develop and include in the plans package a Modified Special Provision for the piles as required.

Commentary: In this scenario, the EOR develops a custom fender system design and pile configurations using piles other than polymeric piles and includes the complete design in the plans.

- G. When a custom fender system design is required due to geometric constraints as specified in 3.14.1.D.3.b, fully detail the custom fender system geometry and list the “Required Energy” in the plans. Minimum length of a custom fender system is 32 feet. Utilize the standard geometry to the maximum extent possible, and the standard piles, wales and dimensional lumber shown on Design Standards Index 21900 or 21930 as appropriate. Include the Data Tables in the plans based on those used for Design Standards Index 21900 or 21930 as appropriate. See the Instructions for Design Standards (IDS) Index 21900 or 21930, as appropriate, for applicable information and plan content requirements. If the fender system length is less than 32 feet and/or the angle breaks between adjacent panels exceed 8 degrees, follow the custom fender system design procedures described in the preceding sections as directed by the District.
- H. Miscellaneous Considerations:
1. The fenders should flare at the same points directly opposite each other measured perpendicular to the centerline of the navigation channel. The minimum distance from the superstructure coping to the beginning of the fender flare is 10 feet.
 2. At the discretion of the District, alternate materials may be used for piles or wales when determined by life cycle cost analysis to be more feasible. The use of alternate materials will necessitate a custom design.
 3. A Pile Installation Constructability Review must be performed by the Geotechnical Engineer to verify that the pile tips shown in the plans can be reasonably obtained by the Contractor, and the use of any penetration aids (jetting, preforming, etc.) will not jeopardize adjacent structures.
 4. Investigate and resolve conflicts between the proposed fender system and existing utilities or structures.
 5. Prestressed concrete fender piles generally have a short life expectancy, are considered sacrificial, and no corrosion protection is required beyond the use of concrete class as shown in Table 1.4.3-1.

3.14.3 Polymeric Pile Supplier Engineer's Development Procedure

- A. Use the following procedure and the requirements in Specification 471 for developing individual pile configurations for each “Energy Capacity” level intended for listing on the QPL.
- B. Develop pile configurations and connection details for fender systems that result in flexible, energy absorbing structures maximizing the efficiency of the proprietary polymeric pile. Use the basic geometry of the fender system, standard connection details if possible, and limitations for pile spacing and pile clusters as shown in Design Standards Index 21900. The minimum designed clear spacing between pile clusters is 30 inches. Include capacities of, and interaction between, the wales and piles in the analysis.

- C. Pile configuration drawings submitted for listing on the QPL shall be based on the design methodology listed below and shall include but not be limited to the following:
- Energy Capacity” of the fender system with the applicable pile configuration
 - Pile configuration and layout based on and compatible with the standard geometry shown on Design Standards Index 21900
 - General notes
 - Minimum pile embedment into soils having an N value greater than or equal to 6
 - Pile material properties including fill material used for hollow piles and required admixtures
 - Pile physical properties, e.g., modulus of elasticity, yield strength, moment of inertia, etc.
 - Pile-to-wale and pile-to-pile connection details for pile sections remaining hollow under service conditions and/or if different from those shown on Design Standards Index 21900
 - Any supplier required limitations regarding pile installation techniques or other typical construction practices permitted by FDOT construction specifications, e.g., full length pile driving versus jetting/driving combination
 - A note for each pile configuration stating: “The pile configuration shown is to be used with Design Standards Index 21900 or the project specific geometry shown in the plans.”
- D. Resistance Factors: For piles having a non-ductile failure mode, reduce the flexural resistance of the pile determined in accordance with Specification 471 by 20%. A non-ductile pile is one that has a ductility factor less than 1.25. The ductility factor is defined as the ratio of the ultimate displacement to the yield displacement.
- E. Use the following design methodology as:
1. Use the following assumptions in the design of the pile configurations:
 - a. Vertical distance of 30 feet from top of fender system pile to top of soil
 - b. Soil properties are to be a weak submerged sand with $\phi = 30$ degrees and a subgrade modulus of 20 pounds per cubic inch. These values correspond to a soil having a blow count, N, of approximately 6.
 - c. Limit fender system deflection to where the uppermost wale remains above the high water elevation.
 - d. Length of fender system = 32 ft. (two 16 ft. sections with no angle break between them)
 - e. Use eight 10" x 10" wales separated by 8" x 8" spacer blocks
 - f. Use a three-pile terminal cluster at one end of the model

2. Design a trial fender system using the assumptions listed above. Use a computer program that allows non-linear modeling of cantilevered piles embedded in weak soil while incorporating soil strengths using P-Y curves and that allows modeling of pile-to-wale interaction, e.g., FB-MultiPier. Consider both wale and pile moment capacities to determine magnitude(s) and location(s) of the critical load(s). Create multiple load cases applying incrementally increasing lateral static load(s) located between and directly at the pile clusters. These loads may be equally distributed between the two uppermost wales. Develop a force versus displacement diagram from the analysis, then compute the energy based on the area under the curve. This area represents the fender system's potential energy available to redirect or possibly bring an errant vessel to rest. Report the minimum calculated "Energy Capacity" from the multiple load cases as the "Energy Capacity" for the subject pile configuration.
3. Determine the pile tip elevation by maintaining a minimum Safe Embedment (E_f) of ten feet.

Determine the Safe Embedment (E_f) as follows:

To verify stability, use a computer program that allows non-linear modeling of a single cantilever pile embedded in weak soil ($N=6$) while incorporating soil strengths using P-Y curves, e.g., FB-MultiPier, LPILE. Load the top of the pile with a transverse load that generates the pile design moment. Raise the pile tip elevation until pile deflections, especially at the pile tip, become unreasonable or the program does not converge. Assume the unstable embedment (E_o) is one foot greater than the embedment that causes unreasonable deflections. Add an additional embedment of 5 feet or 20% of the unstable embedment (E_o), whichever is greater, to E_o to determine the safe embedment (E_f).

4. Perform a constructability review including manufacturing, transportation and installation.

3.14.4 Ladders and Platforms

- A. Contact the District Structures Maintenance Engineer for ladder, platform and catwalk requirements.
- B. Generally, where fender lighting maintenance access is not provided or possible by boat, provide ladders and platforms from the bridge to the fender catwalk.
- C. Design ladders and platforms per OSHA and the Code of Federal Regulations (CFR) Title 29, Part 1910, Section 27. The clearance between rungs and obstructions should be 12-inches but not less than 7-inches (OSHA minimum.)

3.14.5 Navigation Lighting Details

- A. Bridges over waterways with no significant nighttime navigation may be exempted from lighting requirements by the proper authorities; however, most bridges over navigable waterways will require some type of lighting. Refer to [*Code of Federal Regulations \(CFR\) Title 33 Part 118*](#).
- B. For navigation lighting requirements, see the [*USCG Bridge Lighting and Other Signals Manual*](#).

ARCHIVED

Attachment D:

Standard Specifications Section 973 – Structural Plastics

Standard Specifications Section 471 – Polymeric Fender Systems

ARCHIVED

EXPECTED IMPLEMENTATION JANUARY 2012

973 STRUCTURAL PLASTICS. (REV 5-10-11) (FA 5-19-11) (1-12)

SECTION 973 (Pages 939 - 944) is deleted and the following substituted:

SECTION 973 STRUCTURAL PLASTICS

973-1 Description.

This work covers structural plastic components including fiberglass structurally reinforced composite lumber (SCL) and smaller dimensional fiberglass fiber reinforced composite lumber (FFRCL).

973-2 Product Acceptance.

Use only products listed on the Department's Qualified Products List (QPL). Manufacturers seeking evaluation of products must submit an application in accordance with Section 6 and include independently certified test reports that the material meets the requirements of this Section.

In accordance with Section 6, provide manufacturer's certification that the material meets the requirements of this section.

973-3 Materials.

Use polyethylene made from recycled post consumer or post industrial thermoplastics. Mix the plastic with appropriate colorants, UV inhibitors, hindered amine light stabilizers and antioxidants so that the resulting product meets the material property requirements specified in Tables 1 and 2. Structural plastic must not corrode, rot, warp, splinter or crack. The skin must be smooth and black in color unless otherwise specified in the Contract Documents. Skin is the surface material exposed to the atmosphere. Core is the material that surrounds and bonds to the fiberglass reinforcing rods. The use of separate materials for skin and core is at the discretion of each manufacturer; however, if a single material is used, that material must meet the requirements for both skin and core.

Manufacture structural plastic as one continuous piece with no joints or splices to the dimensions and tolerances in accordance with Table 3. Interior voids shall not exceed $\frac{3}{4}$ inch in diameter. Structural plastic members shall be free of twist and curvature.

Reinforce 10" x 10" fiberglass structurally reinforced composite lumber with a minimum of four 1-1/2 inch fiberglass reinforcing rods placed in the corners of the section.

Reinforcing rods must be continuous and offer a minimum flexural strength of 70.0 ksi when tested in accordance with ASTM D 4476 and a minimum compressive strength of 40.0 ksi when tested in accordance with ASTM D 695. Steel reinforcing rods are not permitted.

Reject any sections of structural plastic containing cracks or splits. Also, inspect the ends of the reinforcing rods and reject any sections containing reinforcing rods with voids or cracks.

Add a minimum of 15% (by weight) chopped fiberglass reinforcement to the polyethylene used for fiberglass structurally reinforced composite lumber and a minimum of 15% (by weight) chopped fiberglass reinforcement for smaller dimensional fiberglass fiber reinforced composite lumber. The fiberglass reinforcement may be reduced when other means of controlling cracking are specified with test results which show long term cracking is nonexistent.

EXPECTED IMPLEMENTATION JANUARY 2012

Fiberglass structurally reinforced composite lumber must meet the minimum structural properties listed in Table 4.

Smaller dimensional fiberglass fiber reinforced composite lumber must meet the minimum physical properties listed in Table 5.

Density	ASTM D792	Skin	55-63 pcf
Density	ASTM D792	Core	48-63 pcf
Water Absorption	ASTM D570	Skin	2 hrs:<1.0% weight increase 24 hrs:<3.0% weight increase
Brittleness	ASTM D746	Skin	Brittleness temperature to be less than -40 deg. C
Impact Resistance	ASTM D256 Method A (Izod)	Skin	Greater than 0.55 ft-lbs/in
Hardness	ASTM D2240	Skin	44-75 (Shore D)
Ultraviolet	ASTM D4329 UVA	Skin	500 hours<10% change in Shore D Durometer Hardness
Abrasion	ASTM D4060	Skin	Weight Loss: <0.03 oz Cycles=10,000 Wheel=CS17 Load = -2.2 lb
Chemical Resistance	ASTM D756 or ASTM D543	Skin/Core Sea Water Gasoline No. 2 Diesel	<1.5% weight increase < 9.5% weight increase <6.0% weight increase
Tensile Properties	ASTM D638	Core	Minimum 2200 psi at break
Compressive Modulus	ASTM D695	Core	Minimum 40 ksi
Static Coefficient of Friction	ASTM D1894	Skin	Maximum 0.25, wet
Nail Withdrawal or Screw Withdrawal	ASTM D 6117	Skin/Core	Minimum 60 lb (nail) Minimum 400 lb (screw)

Density	ASTM D 792	50-65 pcf
Impact Resistance	ASTM D256 Method A (Izod)	Greater than 2.0 ft-lbs/in
Hardness	ASTM D2240	44-75 (Shore D)
Ultraviolet	ASTM D4329 (UVA)	500 hours <10% change in Shore D Durometer Hardness
Abrasion	ASTM D4060	Weight Loss: <0.03 oz Cycles = 10,000 Wheel = CS17 Load = -2.2 lb
Chemical Resistance	ASTM D756 or ASTM D543	

D

R

A

F

T

EXPECTED IMPLEMENTATION JANUARY 2012

Table 2 Plastic Material Properties FFRCL		
	Sea Water Gasoline No. 2 Diesel	<1.5% weight increase <7.5% weight increase <6.0% weight increase
Tensile Properties	ASTM D638	Minimum 3000 psi at break
Static Coefficient of Friction	ASTM D2394	Minimum 0.25, wet or dry
Nail Withdrawal or Screw Withdrawal	ASTM D 6117	Minimum 250 lb (nail) Minimum 400 lb (screw)

Table 3 Dimensions and Tolerances		
Structural Plastic	Dimension	Tolerance
Length	Per order (80 ft Maximum)	0/+6 inch
Width – SCL	See Contract Plans	±1/2 inch
Width – FFRCL		±1/4 inch
Height – SCL	See Contract Plans	±1/2 inch
Width – FFRCL		±1/4 inch
Skin Thickness	3/16 inch minimum	n/a
Distance from outer surface to center rebar elements (SCL)	2 inches	±1/2 inch
Straightness (gap, bend or inside while lying on a flat surface)		<1 1/2 inches per 10 feet

Table 4 Structural Properties for SCL		
Member Size		10 inches x 10 inches
Modulus of Elasticity	ASTM D 6109	521 ksi
Stiffness, E.I.	ASTM D 6109	4.05E+08 lb-inch ²
Yield Stress in Bending	ASTM D 6109	5.3 ksi
Weight		30-37 lb/ft

Table 5 Properties for FFRCL		
Modulus of Elasticity	ASTM D 6109	300,000 psi
Flexural Strength	ASTM D 6109	2,500 psi
Compressive Strength	ASTM D 6108	2,200 psi
Compressive Strength Perpendicular to grain	ASTM D 6108	700 psi

The values stated in these tables are the required minimums.

EXPECTED IMPLEMENTATION JANUARY 2012

471 POLYMERIC FENDER SYSTEMS. (REV 5-10-11) (FA 5-19-11) (1-12)

SECTION 471 (Pages 633-634) is deleted and the following substituted:

SECTION 471 POLYMERIC FENDER SYSTEMS

471-1 Description.

Construct fender systems using components in accordance with this Section, the Plans, Design Standards and the Qualified Products List (QPL) Drawings.

471-2 Materials.

Meet the following requirements:

Fiberglass fiber reinforced lumber (Dimensional Lumber)Section 973
Fiberglass structurally reinforced composite lumber (Wales)Section 973
Concrete used to fill hollow pilesSection 347

471-3 Polymeric Pile Product Acceptance.

Use polymeric pile configurations listed on the Department's QPL.

Manufacturers seeking evaluation of products for inclusion on the QPL must submit an application in accordance with Section 6, independently certified test reports, written certification that the piling configuration meets the requirements of this Section, and the following:

1. Design:

- a. Design fender piling configurations and connections in accordance with the latest edition of the FDOT Structures Design Guidelines and applicable Structures Design Bulletins based on the desired energy capacity rating.
- b. All design calculations and design details must be signed and sealed by a Professional Engineer licensed in the State of Florida.

2. Submittals:

- a. Signed and sealed design calculations. Design calculations may be either by hand or by a computer program with hand calculations verifying the program output.
- b. Report from an independent lab verifying the flexural properties of the piling as derived from ASTM D 6109 with the following modification. Supports shall be located to provide a minimum span to depth ratio of 20:1.
- c. For pile sections remaining hollow under service conditions, a report from an independent lab verifying a minimum bolt pull-through and crushing resistance of 10 kip when equipped with manufacturer's detailed connection hardware at a maximum distance of two feet from the end of a pile with a minimum length of four feet.
- d. Signed and sealed pile configuration drawings in 11" x 17" PDF format depicting information required by the latest edition of the FDOT Structures Design Guidelines and applicable Structures Design Bulletins.

EXPECTED IMPLEMENTATION JANUARY 2012

D e. Detailed material specifications showing material type, quality, certifications, acceptance and rejection criteria and placement procedures.

f. Other information pertinent to the design and performance of the pile configuration as necessary.

g. A field construction manual describing in detail, with illustrations, construction requirements and the step-by-step construction sequence for the pile handling and installation. Submit manual in 8.5" x 11" in PDF format.

471-4 Construction Details.

R Unless otherwise shown in the manufacturer's approved field construction manual, use the following construction details.

Protect materials at all times against exposure to extreme heat or impact. Transport products in a manner that will minimize scratching or damage to the outer surfaces, stack on dunnage above ground so that it may be easily inspected and store in a manner that will avoid damage. Handle and lift products with nylon slings. Do not use sharp instruments in handling the product. Products damaged in shipping or handling will be rejected.

Products containing cracks in the reinforcing rods or cracks, partial or full depth, across the section or splits will be rejected.

A Cut, bevel, drill, countersink and otherwise install products in accordance with the manufacturer's recommendations. Set all material accurately to required levels and lines, with members plumb and true and accurately cut and fitted. Securely attach all materials to substrate by anchoring and fastening as shown on the plans. Perform all cutting and drilling in a manner that allows for the collection of all debris and dispose of properly.

Install piles in accordance with Section 455.

471-5 Method of Measurement.

The quantity of dimensional fiberglass fiber reinforced lumber and fiberglass structurally reinforced composite lumber to be paid for will be the plan quantity, in feet board measure, computed based upon the dimensions shown in the Plans.

The quantity of polymeric piles to be paid will be lump sum.

471-6 Basis of Payment.

F Price and payment for plastic marine lumber will be full compensation for the work specified in this Section including all material, storage costs, disposal of unused material and waste, transportation costs, labor, equipment, fasteners and other necessary items required for completing the work. No separate payment will be made for plates, bolts, screws or other hardware necessary to complete the work.

Price and payment for polymeric piles will be full compensation for all labor, equipment and materials required to furnish and install the piles to the pile cut-off elevations shown in the Plans.

T Payment will be made under:

Item No. 471-1	Fender System, Plastic Marine Lumber – MB.
Item No. 471-2	Fender System, Polymeric Piles - LS

Attachment E:

Basis of Estimates Manual, Item 471-2

ARCHIVED

471- 2- FENDER SYSTEM, POLYMERIC PILES

Unit LS/LS **Accuracy** Lump Sum **PlanQuantity?** yes

Notes **Effective January 2012 lettings, and later. Refer to Structures Design Bulletin.**

Details This pay items is to be used for Fender Systems, in accordance with the Instructions for Design Standards, Index 21900.

Note from Structures Design Bulletin: Fender systems are no longer classified as "Light Duty", "Medium Duty" or "Heavy Duty"; therefore, Design Standards Indexes 21910 and 21920 are deleted. Designs will use the basic geometry of the fender system, standard connection details if possible, and limitations for pile spacing and pile clusters that are shown in revised Design Standards Index 21900. Each polymeric piling supplier will develop pile configurations and connection details for fender systems that result in flexible, energy absorbing structures maximizing the efficiency of their proprietary polymeric pile. These pile configurations will be listed on the QPL.

Related Items **Required** 471- 1- **Recommended**

Design Forms and Documentation COMP 700-050-05: Lump Sum Quantities
 Use a quantity of 1, but calculations and computation book documentation must be to the second unit of measure. Locate or define the scope of work involved on the plans.

Construction Forms and Documentation No additional form required; use plans summary or comp book
 Final pay quantity will be PLAN QUANTITY with proper consideration for Specification tolerances.

References **PPM Chapter**
Trns-port
Other SDG 3.14
Standards Index 21900 and 21930
Specifications [Section 471](#)
Prep & Doc Manual Chapter(s)

*TRNS*PORT Category (DRAFT FIELD):*

Struct. 471- 2- **FENDER SYSTEM, POLYMERIC PILES** **LS/LS**

Notes

The following items were open, as of the publication date. Refer to the Master Pay Item list for current items.