

215 Roadside Safety

215.1 General

This Chapter contains roadside safety design criteria for new construction, reconstruction, and Resurfacing, Restoration and Rehabilitation (RRR) projects. New Construction criteria must be met for new and reconstruction projects, and for improvements included with RRR projects.

The design criteria contained in **FDM 210** and **FDM 211** has been developed to minimize the probability that a vehicle will depart the roadway. Design elements that affect roadside safety include: horizontal alignment, superelevation, vertical alignment, drainage design, sight distance, lane widths, pavement, pavement markings, cross slopes, median widths, shoulders, and lighting.

The evaluation of Roadside Safety design elements is necessary to address the occasional errant vehicle that does depart the roadway. These design elements include roadside geometries, lateral offsets to potential hazards, and the use of shielding.

The **AASHTO Roadside Design Guide (AASHTO RDG)** provides the foundation for the development of specific criteria contained in this Chapter and the [Standard Plans](#).

215.1.1 RRR Criteria

Criteria for RRR projects provided in this chapter are the minimum values allowed for roadside elements to remain on arterials and collectors without obtaining a Design Exception or Design Variation (see **FDM 122**).

Criteria for RRR projects provided in this chapter may be used for establishing the minimum requirements for adding auxiliary lanes, keyhole lanes, or providing minor intersection improvements with the understanding that when existing right of way (R/W) is adequate, new construction criteria will be used to the maximum extent feasible.

Do not apply RRR criteria in this chapter to resurfacing projects on Limited Access (LA) Facilities.

215.2 Roadside Features

215.2.1 Roadside Geometry

Roadside geometry refers to the terrain features (slopes) that a vehicle will encounter when departing a roadway. The components of roadside geometry include front slopes, back slopes, and transverse slopes.

215.2.2 Roadside Slope Classification

Roadside Slopes include areas located beyond the edge of the traffic lane as shown in **Figures 215.2.2** and **215.2.3**. These areas are divided into the following classifications:

- (1) Traversable Slope – Smooth terrain, unobstructed by fixed objects:
 - (a) Recoverable Traversable Slope, 1:4 or flatter
 - (b) Non-Recoverable Traversable Slope, steeper than 1:4 and flatter than 1:3
- (2) Non-Traversable Slope – Rough terrain, obstructed, or slopes steeper than 1:3

215.2.3 Clear Zone Criteria

Providing a sufficient amount of Recoverable Slope adjacent to the roadway provides an opportunity for an errant vehicle to safely recover. The amount of recoverable area provided beyond the traveled way is defined as the clear zone, and includes shoulders and bike lanes. The clear zone must be free of roadside hazards, as defined in **FDM 215.3**.

Traversable Back Slopes 1:3 or flatter may be located within the clear zone.

A clear zone width must be provided so that the sum of all Recoverable Slopes is equal to or greater than the required clear zone width obtained from **Table 215.2.1**. Clear zone widths may be widened based on crash history and horizontal curvature; see **AASHTO RDG, Section 3.1**. Clear zone concepts are illustrated in **Figure 215.2.1** and **Figure 215.2.2**. For Roadside Slope Criteria, see **FDM 215.2.6**.

Figure 215.2.1 Clear Zone Plan View

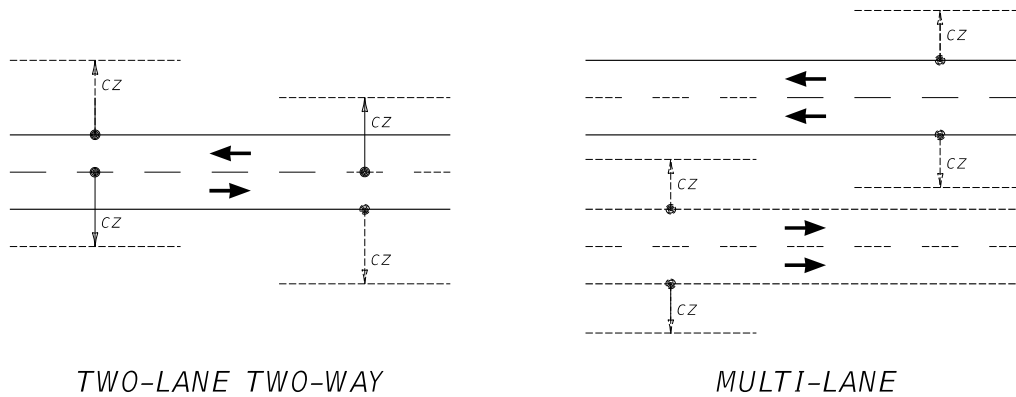
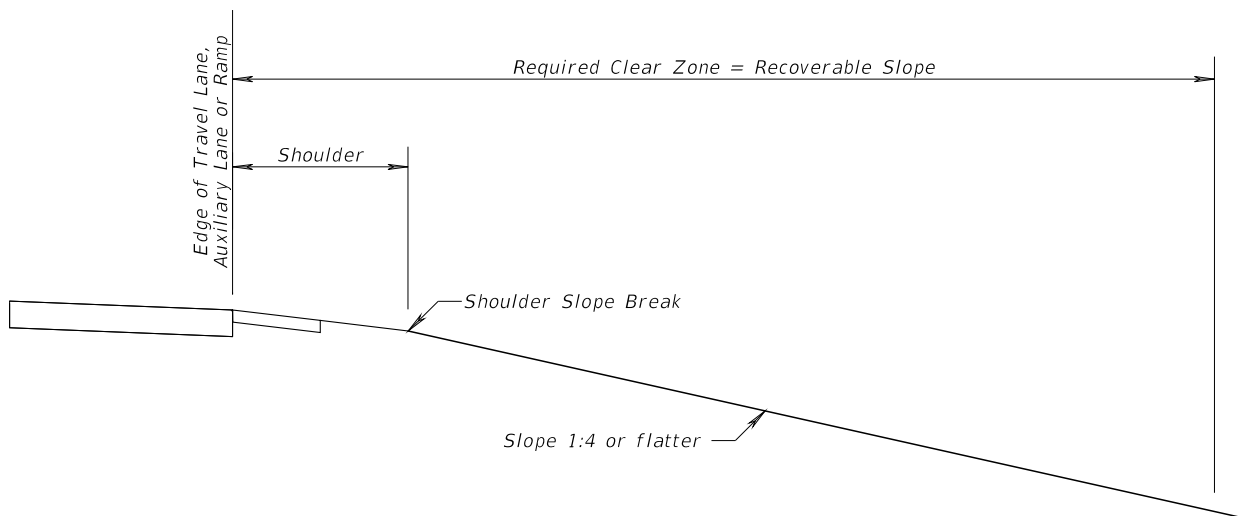

Figure 215.2.2 Clear Zone Concept



When a Traversable Non-Recoverable Slope is present within the clear zone, extend the clear zone width until the amount of Recoverable Slope equals the required clear zone width obtained from **Table 215.2.1**. The additional width provided beyond the Traversable Non-Recoverable Slope is known as the Clear Run-out Area and is illustrated in **Figure 215.2.3**. The Clear Run-out Area should be a minimum of 10 feet wide when R/W is adequate.

Figure 215.2.3 Adjusted Clear Zone Concept

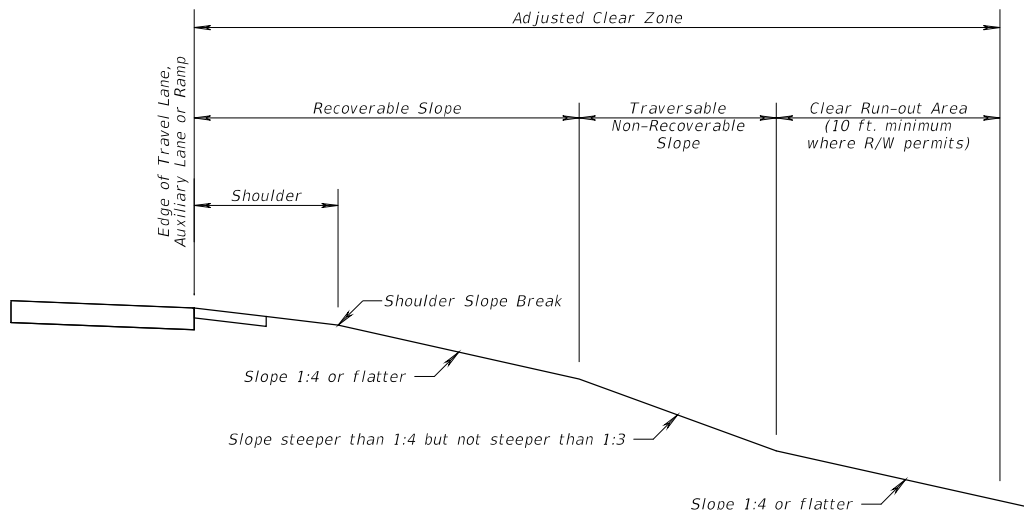

Table 215.2.1 Clear Zone Width Requirements

	Design Speed (mph)						
	≤ 30	35	40	45	50	55	≥ 60
Clear Zone Width for New Construction							
Travel Lanes & Multilane Ramps	12 feet	14 feet	18 feet	24 feet	24 feet	30 feet	36 feet
Auxiliary Lanes & Single Lane Ramps	10 feet	10 feet	10 feet	14 feet	14 feet	18 feet	24 feet
Clear Zone Width for RRR Projects							
Travel Lanes & Multilane Ramps	6 feet	6 feet	6 feet	14 feet	18 feet	18 feet	18 feet
Auxiliary Lanes & Single Lane Ramps	6 feet	6 feet	6 feet	8 feet	8 feet	8 feet	8 feet

Clear zone widths for work zones are provided in [Standard Plans, Index 102-600](#).

215.2.4 Lateral Offset

Lateral offset is the distance from a specified point on the roadway to a roadside hazard. Lateral offset to the roadside hazard is measured as follows:

- **Curbed roadways:** from face of curb.
- **Flush shoulder and high-speed curbed roadways:** from outside edge of traveled way.

Lateral offsets apply to all roadways and are determined based on the following:

- Type of facility; i.e., flush shoulder or curbed roadway,
- Design speed
- Design Element
- Project Type; i.e. New Construction, RRR

Flush shoulder roadways typically have sufficient R/W, to provide the required clear zone widths. Therefore, minimum lateral offset for these roadways is based on maintaining a clear roadside for errant vehicles to recover (i.e., maintaining clear zone width provided in **Table 215.2.1**).

Lateral offsets for curbed roadways should be based on clear zone criteria; however, curbed roadways typically do not have sufficient R/W to provide the required clear zone widths. Therefore, minimum lateral offset on these roadways is based on offset needed for normal operation of the roadway.

At times it may be necessary to place poles (e.g., signal, light, sign) within the sidewalk. Refer to **FDM 222.2** for minimum unobstructed sidewalk width requirements.

Table 215.2.2 provides minimum lateral offset criteria for roadside features and roadside hazards typically encountered and considered functionally necessary for normal operation of the roadway; e.g., signing, lighting, utilities. For crashworthy objects, meet or exceed the minimum lateral offset criteria provided in **Table 215.2.2**. Locate objects that are not crashworthy as close to the R/W line as practical and no closer than the minimum lateral offset criteria provided.

When a roadside hazard is placed behind a barrier that is justified for other reasons, the minimum lateral offset to the object equals the setback requirements (deflection distance) of the barrier, see **FDM 215.4.6**. Refer to **FDM 215.5** for permissible attachments to barriers.

When determining minimum lateral offset for bridge piers and abutments, coordinate with vertical clearance requirements found in **FDM 210.10.3**. When shielding is used, refer to setbacks to barriers in **FDM 215.4.6** and **FDM 210.10.3**.

Table 215.2.2 Minimum Lateral Offset Criteria

Design Element		Curbed Roadways				High Speed Curbed and Flush Shoulder Roadway
		New Construction		RRR		
		Design Speed				
		25-35 mph	40-45 mph	25-35 mph	40-45 mph	
Light Poles	Conventional	Do not locate in Medians, except in conjunction with barriers that are justified for other reasons. See FDM 215.2.9 .				
		1.5 feet	4.0 feet	1.5 feet	1.5 feet	20 feet from Travel Lane, 14 feet from Auxiliary Lane, or Clear Zone width, whichever is less
	High Mast	Outside Clear Zone				
Signal Poles and Controller Cabinets		Do not locate in Medians. See FDM 215.2.9 .				
		1.5 feet	4.0 feet	1.5 feet	1.5 feet	Outside Clear Zone
Traffic Infraction Detectors		For placement and installation specifications, refer to the State Traffic Engineering and Operations Office web page: http://www.fdot.gov/traffic/				
ITS Poles and Related Items	Pole & Other Aboveground Fixed Objects	Do not locate in Medians, except in conjunction with barriers that are justified for other reasons. See FDM 215.2.9 .				
		1.5 feet	4.0 feet	1.5 feet	4.0 feet	Outside Clear Zone
	Equipment Shelters and Towers	Do not locate within the limited-access right of way, except as allowed by Policy No. 000-625-025 , Telecommunications Facilities on Limited Access Rights of Way .				
	Breakaway Objects	1.5 feet	4.0 feet	1.5 feet	4.0 feet	As Close to R/W As Possible
Traffic Control Signs	Single and Multi-Column	Locate in accordance with Standard Plans.				
	Overhead Sign Structures	Outside Clear Zone				
Trees	Where the diameter is or is expected to be > 4 inches measured 6 inches above the ground	1.5 feet	4.0 feet	1.5 feet	1.5 feet	Outside Clear Zone
		RRR Projects: (1) Meet New Construction criteria for new plantings.				

Table 215.2.2 Minimum Lateral Offset Criteria (cont.)

Design Element		Curbed Roadways				High Speed Curbed and Flush Shoulder Roadway
		New Construction		RRR		
		Design Speed				
		25-35 mph	40-45 mph	25-35 mph	40-45 mph	
Aboveground Utilities (See <i>FDM 215.2.8</i>)	Existing Utilities	1.5 feet	4.0 feet	1.5 feet	4.0 feet	Outside Clear Zone
	New or Relocated Utilities	4.0 feet				Outside Clear Zone
	RRR Projects: Existing aboveground utilities are not required to be relocated unless one of the following applies:	<ul style="list-style-type: none"> The edge of traveled way is being moved closer to the aboveground utility; e.g., addition of an auxiliary lane, or They have been hit 3 times in 5 years. 				
Railroad Grade Crossing Traffic Control Device		Locate in accordance with Standard Plans, Index 509-100 and Index 509-070				
Roadways Overpassing Railroads		For Horizontal Clearances where roadways overpass railroads refer to <i>FDM 220</i> .				
Canal and Drop-off Hazards		See <i>FDM 215.3</i>				
Bridge Piers and Abutments		The greater of the following: 16 feet from Edge of Travel Lane; or Outside: 4 feet from Face of Curb Median: 6 feet from Edge of Traffic Lane (See <i>FDM 215.4.5.4</i> for Pier Protection criteria and <i>Figures 210.12.3 & 210.12.4</i>)			Outside Clear Zone	
Drainage Structures (e.g., wingwalls, endwalls, flared end sections)		Refer to the FDOT Drainage Manual				
Mailboxes		Locate in accordance with Standard Plans, Index 110-200				
Bus Benches and Transit Shelters		Locate in accordance with <i>Rule Chapter 14-20.003, Florida Administrative Code (F.A.C.)</i> . Transit bus benches must be located in accordance with <i>Rule Chapter 14-20.0032, F.A.C.</i>				
Pedestrian Railing		4.0 feet			Outside Clear Zone	

215.2.5 Control Zones for RRR Projects

Control Zones apply only to RRR projects and do not include aboveground utilities.

Control Zones are high-risk areas where roadway departures occur with greater frequency resulting in increased risk of impact with roadside hazards. To address this condition, lateral offset and clear zone width requirements in Control Zones are to be based on New Construction criteria. A Control Zone violation is when RRR lateral offset requirements are met, but New Construction criteria is not. Process a Design Variation for Control Zone violations.

Control Zones include the following locations:

- (1) A location where an aboveground object has been hit 3 times or more in the last 5 years.
- (2) Intersection Radii – Within the New Construction lateral offset of the return radii of an intersecting street from begin point of tangent (PT) to end point of tangent (PT), see **Figure 215.2.4**.

Figure 215.2.4 Intersection Radii

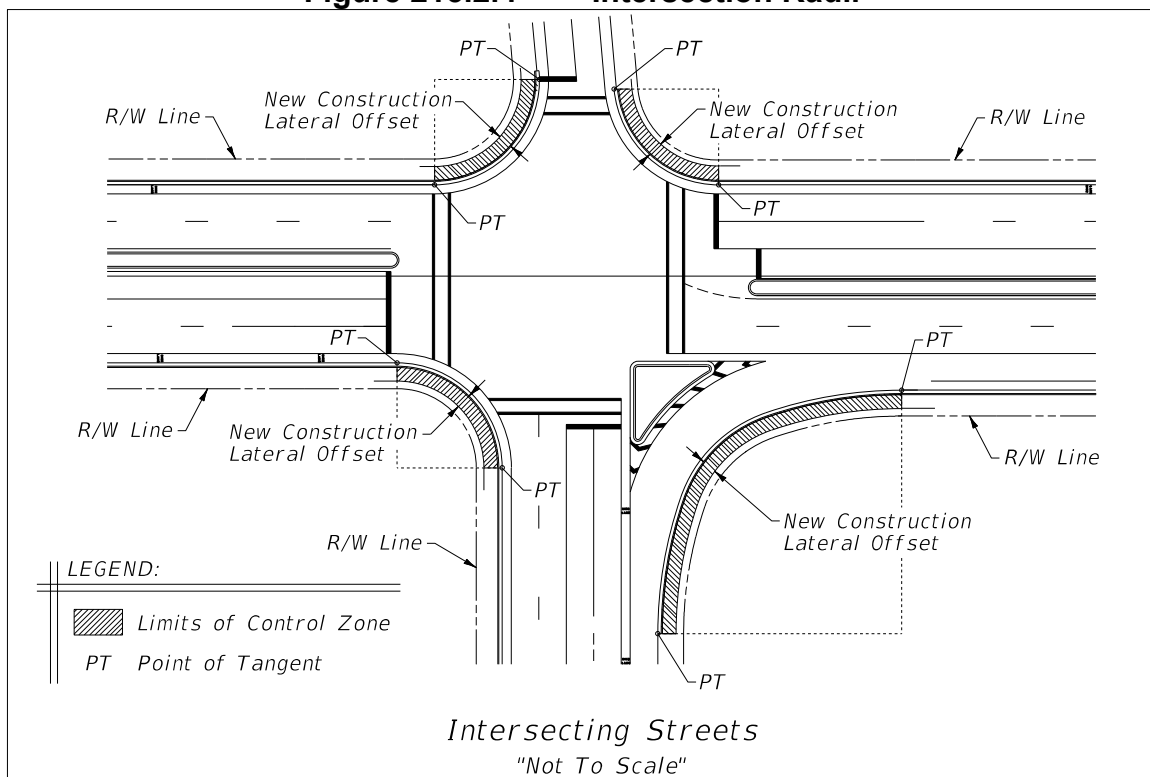

- (3) 'T' Intersection – On the non-intersection side of 'T' intersections within the area directly across and between each radii return point of tangent (PT) extended to the New Construction lateral offset, see **Figure 215.2.5**.

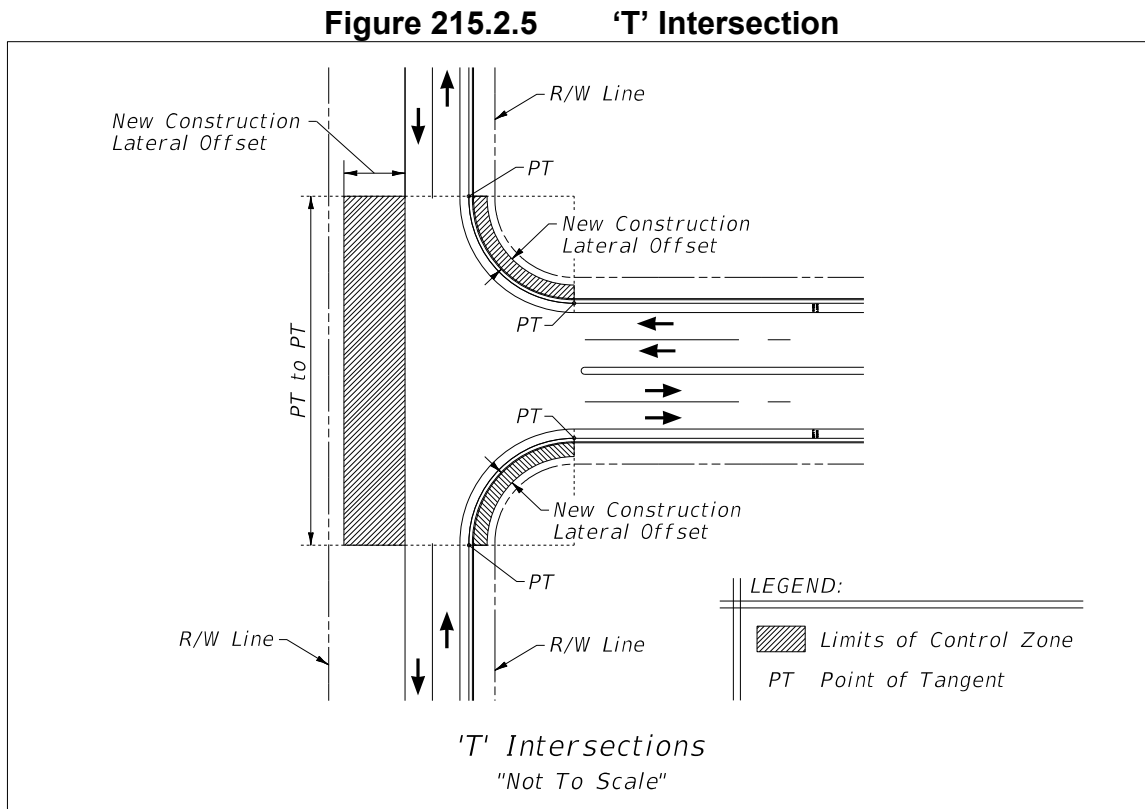

- (4) Right Turn Deceleration – Within the New Construction lateral offset for a length of 100 feet measured downstream from the beginning of the full width lane, see **Figure 215.2.6** for right turn deceleration lane on a tangent. For right turn deceleration lane constructed with a reverse curve the beginning of the Control Zone starts at the point of intersection (PI), see **Figure 215.2.7**.
- (5) Merge Section – Within the New Construction lateral offset for a length of 100 feet measured downstream from the beginning of the taper of a skewed merge section. See **Figure 215.2.8** for merge section constructed on a tangent. For merge section constructed with a reverse curve the beginning of the Control Zone starts at the point of intersection (PI), see **Figure 215.2.9**.
- (6) Service Facility (i.e. alley way or easement) Driveway – For a distance of 3 feet from a driveway flare within the new construction lateral offset distance at the intersection of a dedicated intersecting service facility, see **Figure 215.2.10**.

Figure 215.2.6 Right Turn Deceleration with Tangent

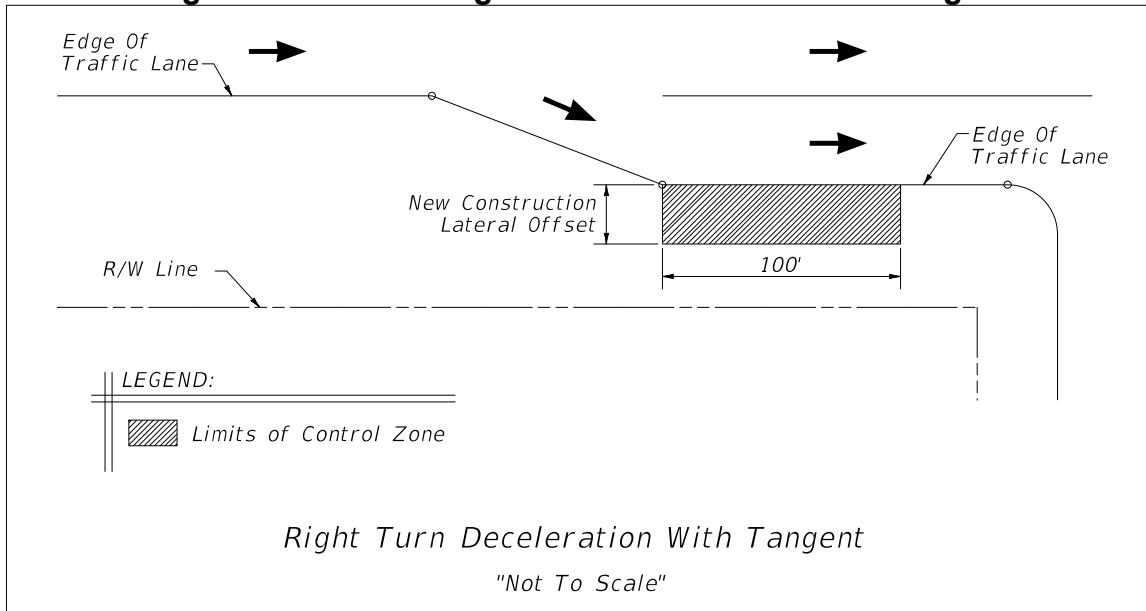

Figure 215.2.7 Right Turn Deceleration with Reverse Curve

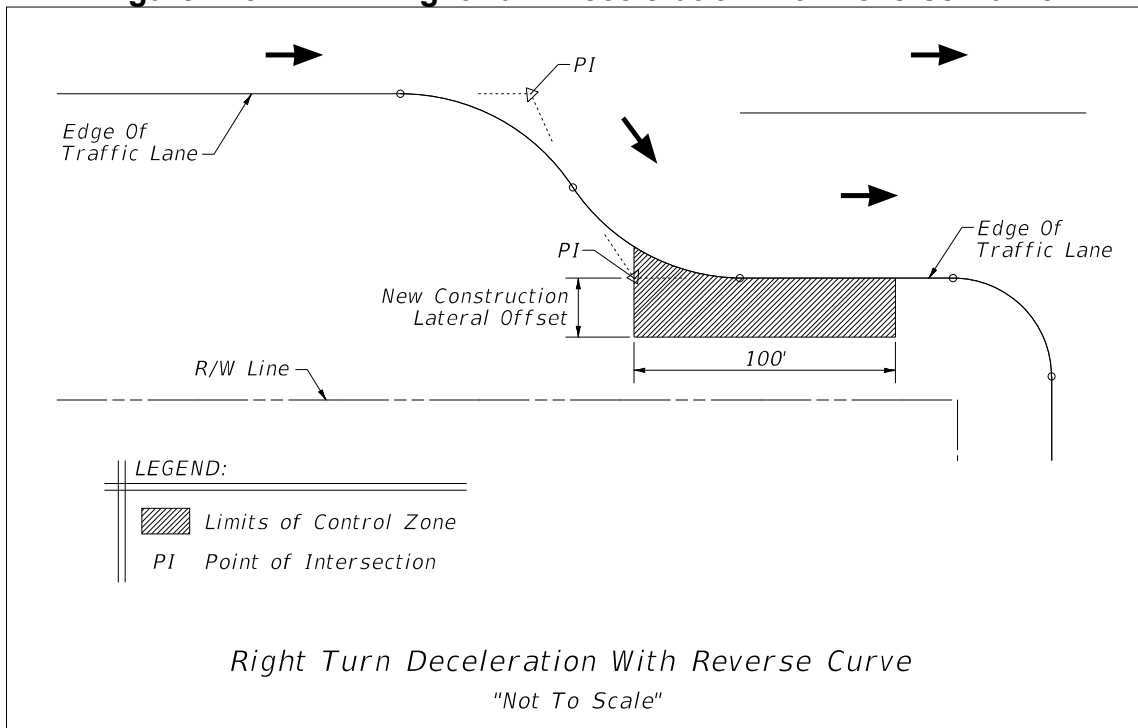

Figure 215.2.8 Merge Section with Tangent

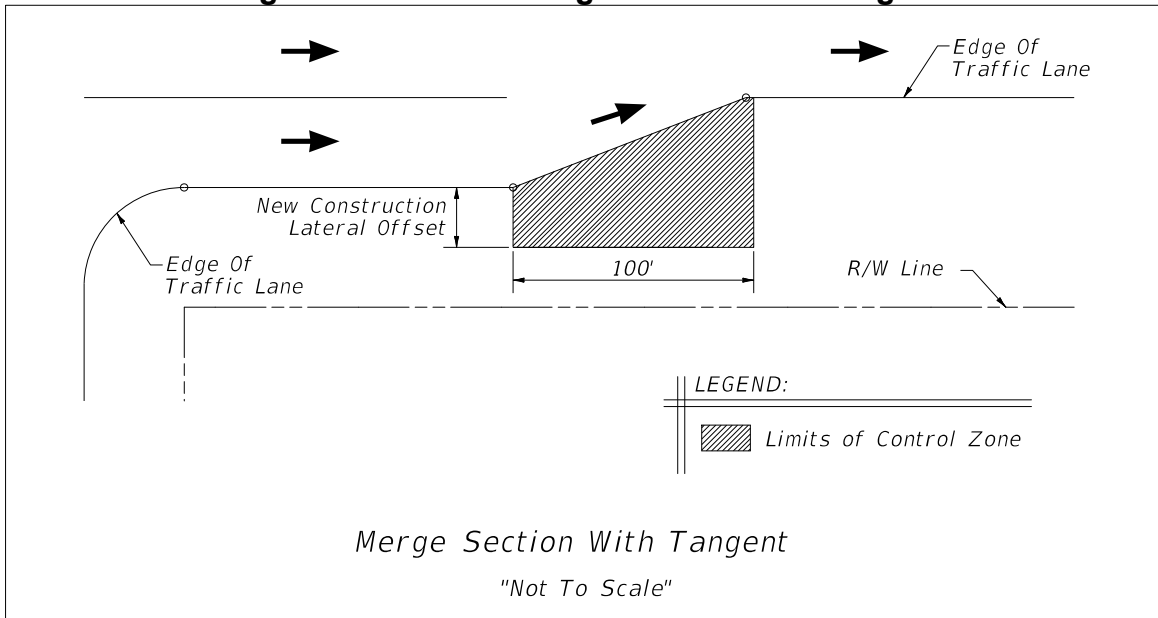

Figure 215.2.9 Merge Section with Reverse Curve

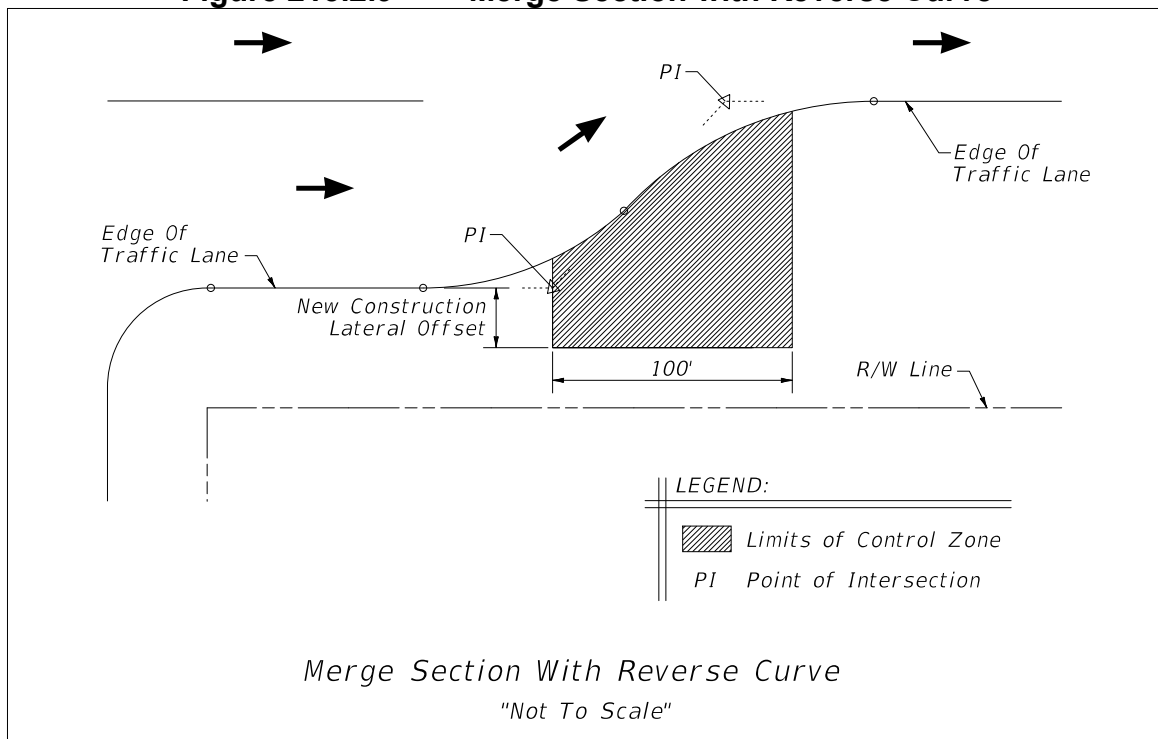
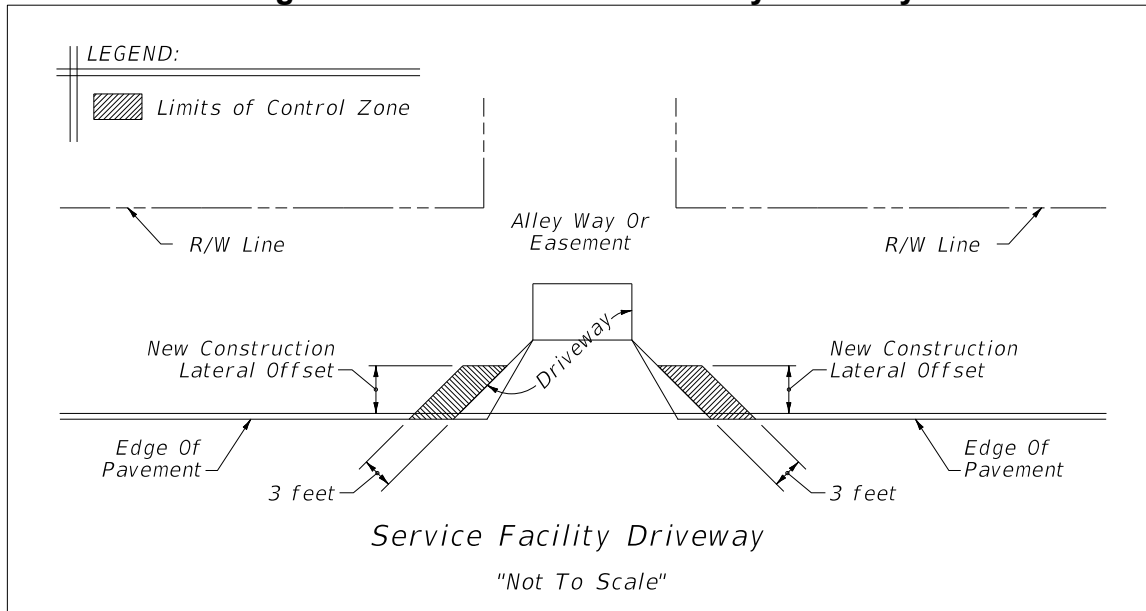
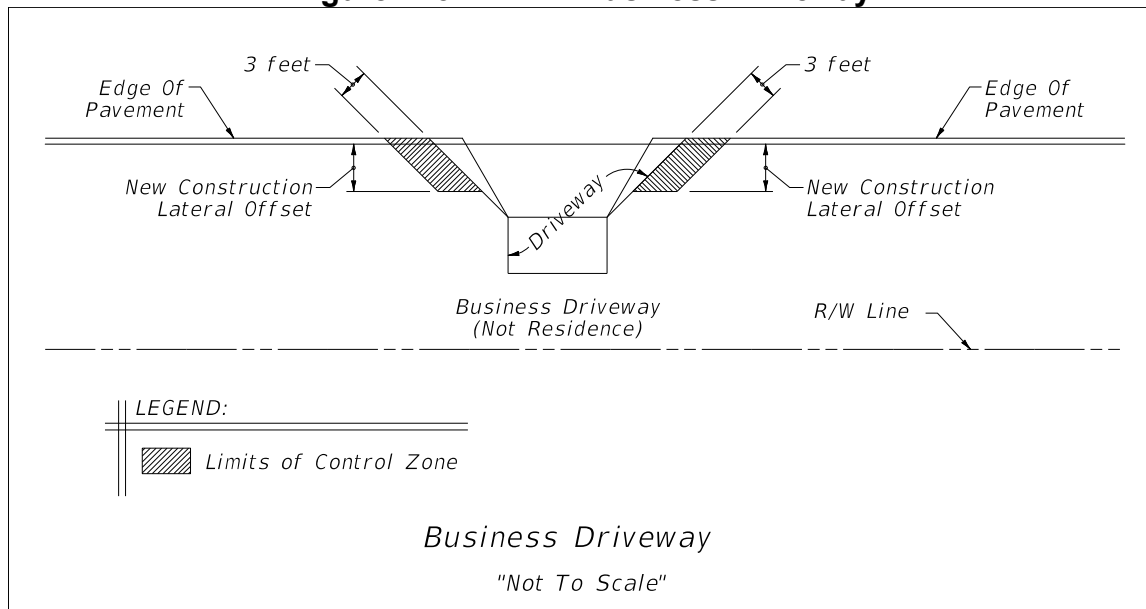

Figure 215.2.10 Service Facility Driveway



- (7) Business (i.e. non-residential) Driveway – For a distance of 3 feet from a driveway flare within the new construction lateral offset distance at the entrance turnout for use other than a private residence, see **Figure 215.2.11**.

Figure 215.2.11 Business Driveway



- (8) Horizontal Curves – Within the New Construction lateral offset in the outside area of a curve when the posted speed is greater than 35 mph and the curve radius is 3000 feet or less, see **Figure 215.2.12**.

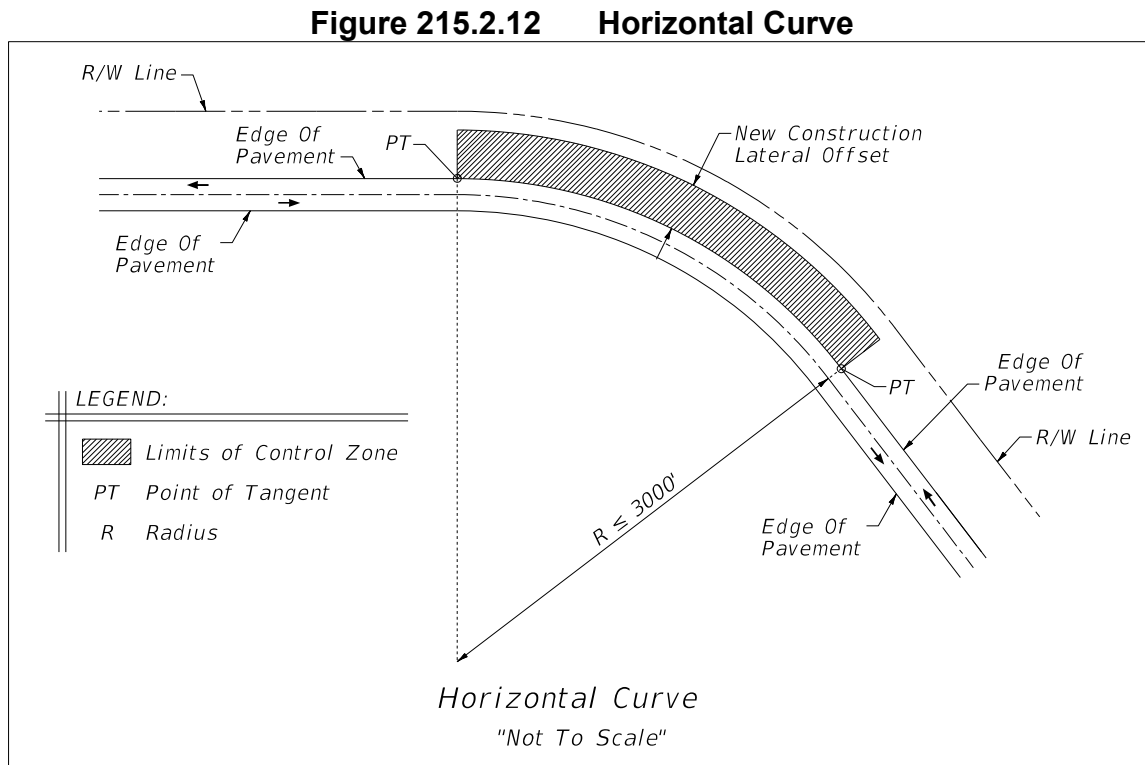

- (9) Roadway Deflection without Curves – Within the New Construction lateral offset of roadway alignments with a deflection (kink) of more than 5 degrees for a distance of 100 feet from the point of intersection of the deflection, see **Figure 215.2.13**.

Figure 215.2.13 Roadway Deflection without Curve

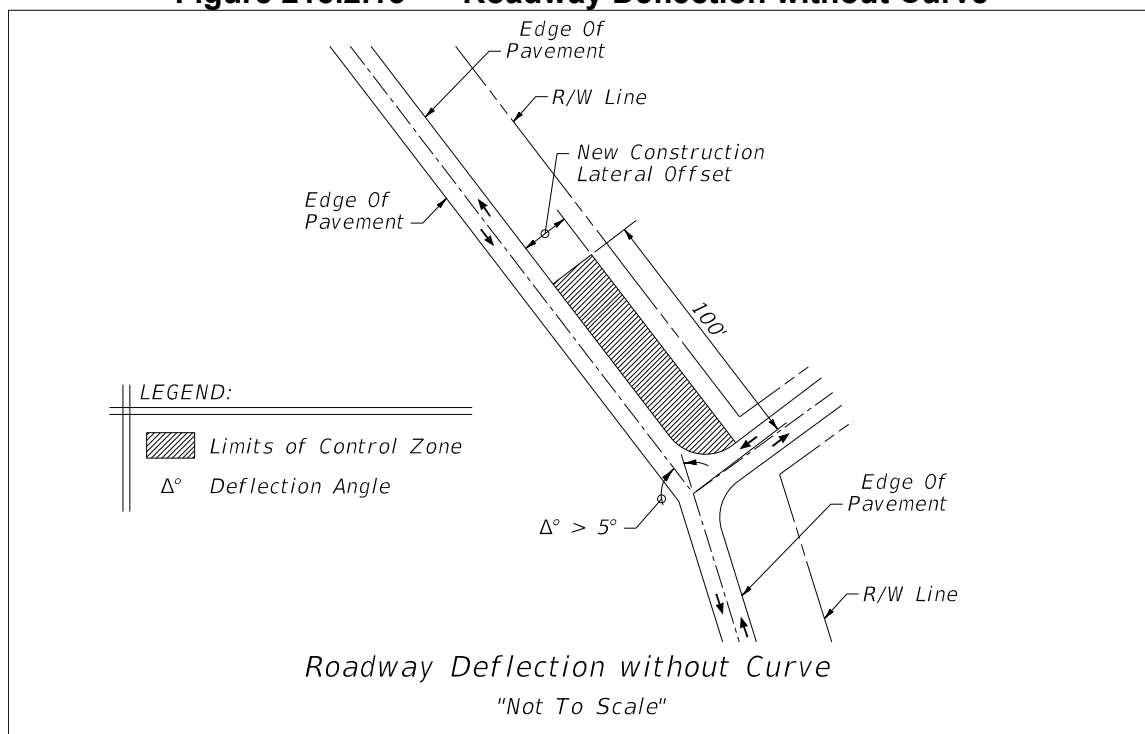

215.2.6 Roadside Slope Criteria

Roadside slopes consist of front slopes, back slopes, and transverse slopes. Roadside slope criteria is provided in **Table 215.2.3**.

For sod or turf slopes steeper than 1:3:

- Consider the associated long term erosion control and maintenance costs.
- Slopes higher than 20 feet, provide a 10-foot wide maintenance berm (1:10 or flatter) at the top and toe.
- Slopes higher than 35 feet, provide a 10-foot wide maintenance berm (1:10 or flatter) at the top and toe. Include intermediate berm(s) so that the spacing between berms does not exceed 35 feet. Coordinate with the District Drainage, Maintenance, and Landscape Architect's Offices.

Coordinate with the District Geotechnical Office for slopes steeper than 1:2.

Modification for Non-Conventional Projects:

Delete the last two sentences above and see RFP for requirements.

For retaining walls greater than 5 feet in height, provide a 10-foot maintenance area (1:10 or flatter) in front of the wall face with suitable access for maintenance vehicles. See **Structures Design Guidelines (SDG), Section 3.12** for information regarding partial height walls.

215.2.6.1 RRR Evaluation of Existing Roadside Slope

Existing roadside slope, and new slopes included with a RRR project, must meet the criteria provided in **Table 215.2.3**, except for the following:

(1) Front Slopes:

- (a) For constrained conditions, new slopes at 1:4 may be constructed within the clear zone. New slopes steeper than 1:4 require a Design Variation.
- (b) Existing 1:3 or flatter slopes within the clear zone may remain.
- (c) Flattening slopes of 1:3 or steeper at locations where run-off-the-road type crashes are likely to occur (e.g., on the outsides of horizontal curves) should be evaluated.
- (d) Existing front slopes steeper than 1:3 within the clear zone should be evaluated for shielding.

(2) Back Slopes:

- (a) For constrained conditions, new slopes at 1:3 may be constructed within the clear zone. New slopes steeper than 1:3 require a Design Variation.
- (b) Existing 1:2 or flatter slopes may remain.
- (c) Existing back slopes steeper than 1:3 within the clear zone should be evaluated for shielding.

RRR lateral offset and clear zone requirements must be met when the above criteria is applied.

Modification for Non-Conventional Projects:

Delete **FDM 215.2.6.1** and see RFP for requirements.

Table 215.2.3 Roadside Slope Criteria

Type of Slope	Flush Shoulder and High Speed Curbed		Curbed	
	Height of Fill (feet)	Rate	Height of Fill (feet)	Rate
Front Slope	0 – 5	1:6	All	1:2 or to suit property owner, not flatter than 1:6.
	5 – 10	1:6 to edge of Clear Zone, then 1:4		
	10 – 20	1:6 to edge of Clear Zone, then 1:3		
	> 20	1:2 with guardrail		
Back Slope	All	1:4 or 1:3 with a standard width trapezoidal ditch and 1:6 front slope	All	1:2 or to suit property owner. Not flatter than 1:6.
Transverse Slope	All	1:10 or flatter (freeway & Interstate) 1:4 (others)	All	1:4
Notes:				
(1) Height of fill is the vertical distance from the edge of the outside travel lane to the toe of front slope.				

215.2.7 Drainage Features

Drainage features in close proximity to travel lanes is often necessary. These features include ditches, curbs, and drainage structures; e.g., transverse/parallel pipes, culverts, endwalls, wingwalls, and inlets. Evaluate the placement of these features as part of roadside safety design. Refer to the [Drainage Manual](#) for information regarding hydraulic design.

Consider the future maintenance of the facility when evaluating the design of roadside topography and drainage features. Routine maintenance, or repairs necessary for the continued function of the drainage feature may lead to long-term expenses and disruption to traffic flow.

215.2.7.1 Roadside Ditches

Acceptable cross section slope criteria for roadside ditches within the clear zone is provided in **Figures 215.2.14** and **215.2.15**. These roadside ditch configurations are considered traversable, as described in the **AASHTO RDG**. Adjusted clear zone widths may be required for Non-Recoverable Slopes located within the clear zone (i.e. slopes steeper than 1:4 but flatter than 1:3, see **FDM 215.2.3**). The application of the ditch cross section slopes must be coordinated with Roadside Slope Criteria included in **FDM 215.2.6**.

The [Drainage Manual](#), **Chapter 2** requires a minimum ditch bottom width of 5 feet to accommodate mitered end sections and maintenance mowers. Refer to the [Drainage Manual](#) for V-bottom ditch limitations. When a ditch bottom width of less than 5 feet is approved by the District Drainage Engineer the slope criteria provided in **Figures 215.2.14** and **215.2.15** may be used.

Figure 215.2.14 Roadside Ditches – Bottom Width 0 to < 4 feet

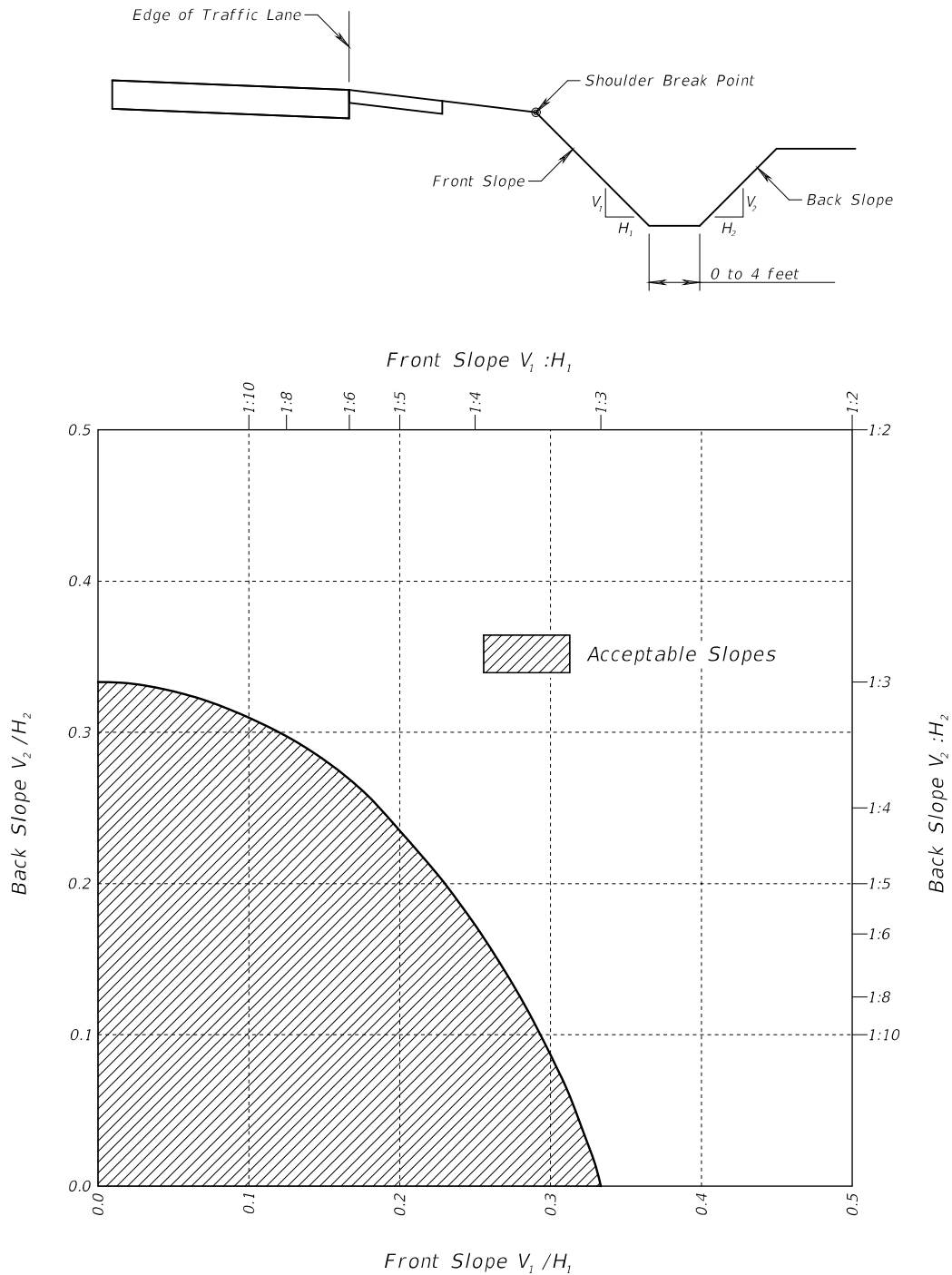

Ref: Figure 3-6, 2011 AASHTO Roadside Design Guide, 4th Edition

Figure 215.2.15 Roadside Ditches – Bottom Width \geq 4 feet

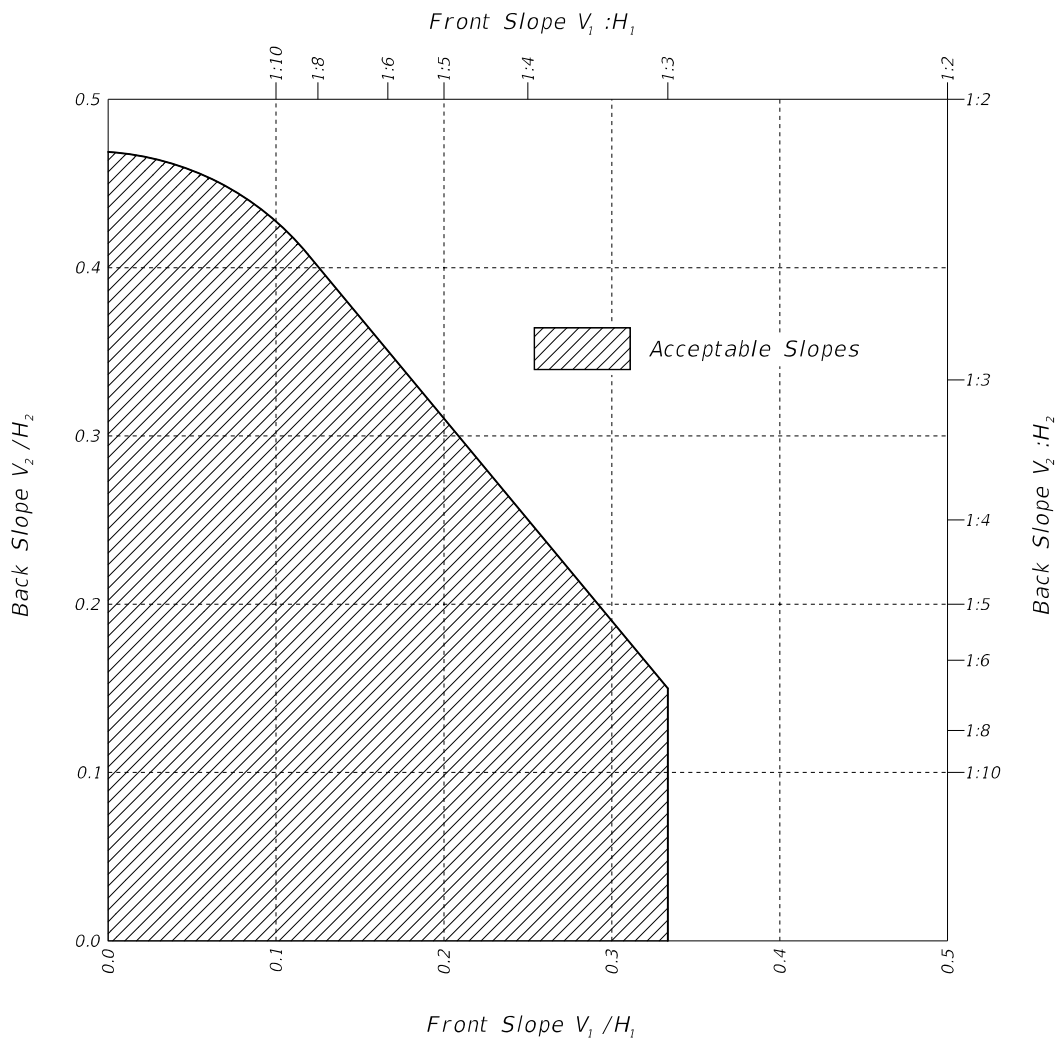
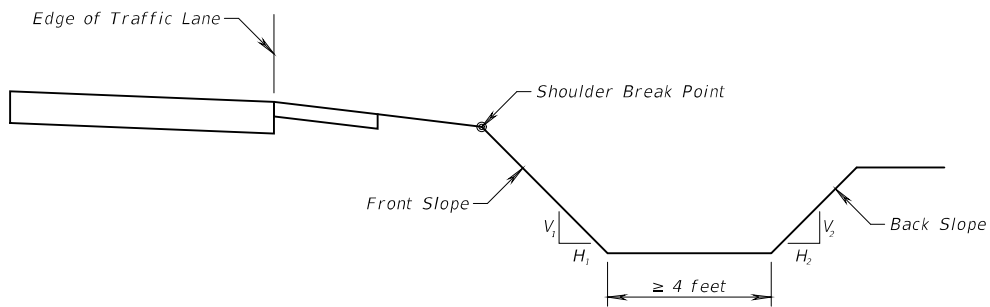

Ref: Figure 3-6, 2011 AASHTO Roadside Design Guide, 4th Edition

215.2.7.2 Curbs and Traffic Separators

See **FDM 210.5** for information concerning curbed roadways.

Curb has no redirection capability; therefore do not use curb to mitigate clear zone violations.

Traffic separators are used to:

- provide delineation of narrow roadway medians
- manage access points and turning movements
- provide for drainage
- offer pedestrian refuge areas

Refer to the **FDM 212.2.11** and [Standard Plans, Index 520-020](#) for additional information concerning traffic separators.

A bridge mounted traffic separator is to match geometrically with adjacent roadway traffic separator or the face of curb. Design separators in accordance with the [Structures Design Guidelines](#), and [Standard Plans, Index 520-020](#).

Shoulder Gutter is frequently used along roadway fill sections and bridge approaches to prevent excessive runoff down embankment slopes. Refer to the Drainage Manual for Shoulder Gutter requirements.

215.2.7.3 Drainage Structures

Drainage structures located along the roadside must provide a traversable design or be located outside the required clear zone. Drainage designs typically contain curb inlets, ditch bottom inlets, endwalls, wingwalls, headwalls, flared end sections or mitered end sections. If not adequately designed or properly located, these features may create hazardous conditions for vehicles. For detailed background information concerning traversable designs, refer to the **AASHTO RDG**.

Details for drainage structures and end treatments are provided in [Standard Plans Index 425 and 430 Series](#). These drainage features have the potential for conflict with a vehicle either departing the roadway or within a commonly traversed section of a roadway. Refer to the [Drainage Manual](#) for standard drainage structures which are permitted within the clear zone.

215.2.7.4 RRR Evaluation of Existing Drainage Features

Evaluate existing drainage structures and end treatments located within the clear zone to determine if they present a hazardous condition and if modification or relocation is necessary. Based on a review of the crash history, modify or relocate any drainage structures impacted three times in five years.

New drainage features included with a RRR projects must provide a traversable design or be located outside the required clear zone.

215.2.8 Aboveground Utilities

Utility Agency/Owners (UAOs) are cities, counties, utility companies, homeowner associations, private citizens, or businesses organized under the laws of Florida with permission and/or rights to have their aboveground utilities within the Department's R/W. Where aboveground utilities are more than 4 inches above the grade and are not accepted by FDOT as crashworthy they are considered roadside hazards. The below criteria are designed to minimize conflicts between roadside safety requirements and the privilege and rights the UAOs may have. Consult with the District Utilities Office to determine any limitations to the Department's authority to effect the below requirements.

New and existing aboveground utilities are to meet the following requirements:

- (1) Not within the median,
- (2) Outside the new construction lateral offsets in **Table 215.2.2**, and
- (3) As close to the R/W as practical. Aboveground utilities are considered to be as close to the right of way as practical when the location does not cause the utility to do any of the following:
 - encroach onto private property
 - violate National Electrical Safety Codes
 - violate State or Federal codes/regulations
 - conflict with other existing overhead or underground facilities
 - require encroachments onto private property to trim trees
 - requires the utility to remove trees
 - takes individual poles out of alignment with existing pole lines

When the requirements above cannot be met, aboveground utilities may be placed behind Department-approved barriers, allowing for barrier deflection.

215.2.9 Signing, Lighting, Traffic Signals, Intelligent Transportation Systems (ITS), and Other Similar Roadside Features

Locate devices in accordance with the minimum lateral offset criteria provided in **Table 215.2.2** and the following:

- Signing – **FDM 230**
- Lighting – **FDM 231**
- Traffic Signals – **FDM 232**
- ITS – **FDM 233**

These features are not required to meet minimum lateral offset criteria when installed behind a traffic barrier, provided:

- (1) The barrier was justified for other reasons, and
- (2) The device is located within the barrier's Length of Need (See **FDM 215.4.6**).

Post-mounted sign supports and conventional light poles must be breakaway as defined in the **AASHTO LRFD Specifications for Structural Supports for Highway Signs, Luminaires, and Traffic Signals** and the **AASHTO RDG**. Post-mounted supports must be of an acceptable and crashworthy design as detailed in the [Standard Plans](#).

Avoid placing light poles or signals in the median where, when struck, may become a hazardous flying object to vehicles in an opposing lane. Do not place overhead sign structure (cantilever or truss) supports, conventional light poles, or mast arm supports in the median, except in conjunction with barriers that are justified for other reasons. See **FDM 231.1** for additional limitations on placing lighting in the median.

Do not locate high mast lighting poles in gore areas within the runout length as defined in the **AASHTO RDG, Section 5.6.4**.

215.2.10 Roadside Flashing Beacon Assemblies

Roadside flashing beacon assemblies installed in accordance with [Standard Plans, Index 700-120](#) are considered crashworthy and are permitted within the clear zone. Locate in accordance with the lateral offset criteria provided in **Index 700-101**. Other ground mounted flashing beacon assemblies located within clear zone must be either

crash tested or located behind a barrier that has been justified for other reasons. Flashing beacon assemblies that are mounted on mast arms are exempt from this requirement.

215.2.11 Breakaway Devices

The criteria for breakaway supports is covered in the *AASHTO RDG, Chapter 4*. Department-approved breakaway devices are covered in the [Standard Plans](#) and included on the Approved Products List ([APL](#)).

Breakaway devices are designed to be impacted at normal bumper heights with vehicles traveling along relatively flat level ground. If impacted at a significantly higher point the breakaway mechanism may not function as designed resulting in non-activation or improper fracturing of the device. For this reason do not locate breakaway supports in ditches or along slopes steeper than 1:6.

215.3 Roadside Hazards

215.3.1 Aboveground Hazards

An aboveground hazard is anything within the clear zone that is greater than 4 inches in height and is firm and unyielding or doesn't meet breakaway criteria. Evaluate the location of temporary and permanent aboveground hazards and ensure that their placement is in accordance with the lateral offset and clear zone requirements of **FDM 215.2**.

Curbs are not an aboveground hazard when utilized in accordance with **FDM 210.5**.

215.3.1.1 Work Zone Aboveground Hazards

Aboveground hazards in work zones are considered part of the “work area” and treated with appropriate work zone traffic procedures included in the [Standard Plans, Index 102 Series](#). During non-working hours, place aboveground hazards (e.g., objects, materials, equipment) outside clear zone widths for work zones, or behind a barrier.

215.3.2 Canal Hazards

A canal hazard is defined as an open ditch parallel to the roadway for a minimum distance of 1000 feet and with a seasonal water depth in excess of 3 feet for extended periods of time (i.e., 24 hours or more).

Minimal lateral offset for canal hazards exceed standard clear zone width criteria. Canal hazard lateral offsets are measured from the edge of travel lane, auxiliary lane or ramp to the top of the canal side slope nearest the road. Minimum required distances are illustrated in **Figures 215.3.1** and **215.3.2** and summarized as follows:

- Not less than 60 feet for flush shoulder and curbed roadways with design speeds of 50 mph or greater.
- Not less than 50 feet for flush shoulder roadways with design speeds of 45 mph or less.
- Not less than 40 feet for curbed roadways with design speeds of 45 mph or less.

When new canal or roadway alignment is required, provide distances greater than those above to accommodate future widening of the roadway.

On fill sections, provide a flat berm (1:10 or flatter slope) no less than 20 feet in width between the toe of the roadway front slope and the top of the canal side slope nearest the roadway.

When the slope between the roadway and the "extended period of time" water surface is 1:6 or flatter, the minimum distance can be measured from the edge of the travel lane, auxiliary lane, or ramp to the "extended period of time" water surface and a berm is not required.

In sections with ditch cuts, provide a minimum of 20 feet between the toe of the front slope and the top of the canal side slope nearest the roadway.

Shield the canal hazard with an approved roadside barrier when the required minimum lateral offset cannot be met using the following criteria:

- Locate the barrier as far from the traveled way as practical and outside of the clear zone where possible.
- Locate guardrail no closer than 6 feet from the canal front slope.
- Locate High Tension Cable Barrier no closer than 15 feet from the canal front slope.

Figure 215.3.1 Lateral Offset Criteria for Canal Hazards on Flush Shoulder and High Speed Curbed Roadways

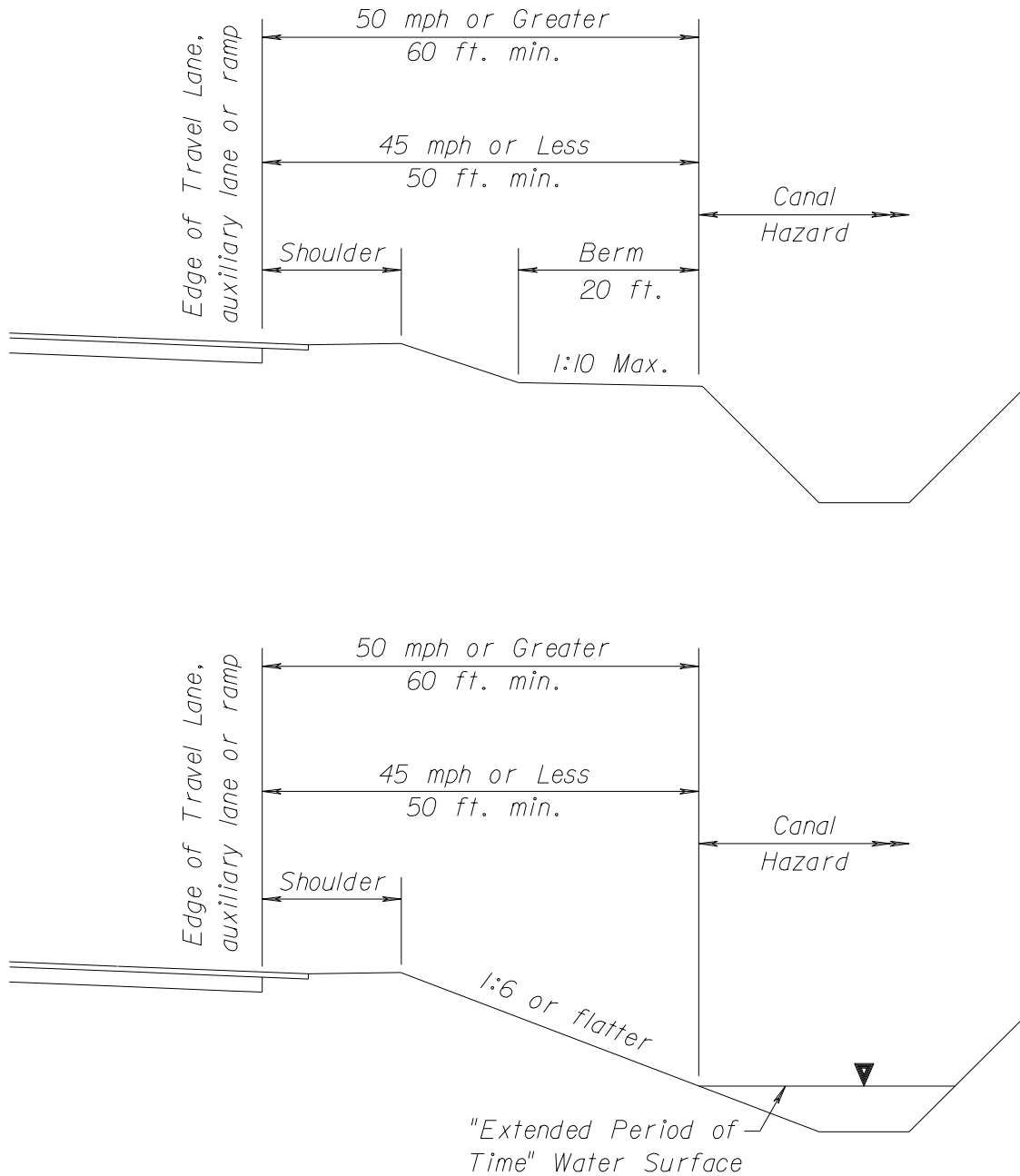
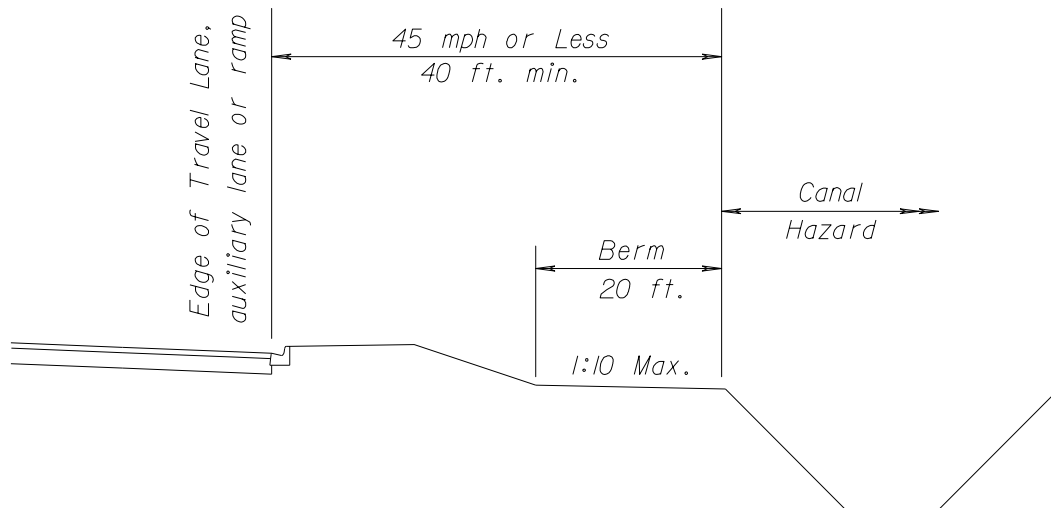

Figure 215.3.2 Lateral Offset Criteria for Canal Hazards on Low Speed Curbed Roadways



215.3.3 Drop-off Hazard

Drop-off hazards are defined as steep or abrupt downward slopes that can be perilous to vehicle occupants, pedestrians and cyclists. Shield any drop-off determined to be a hazard using the following guidelines:

- (1) Any vertical faced structure (e.g., retaining wall, wing-wall) located within the clear zone.
- (2) A drop-off of 6 feet or more with a slope steeper than 1:3 located within the clear zone.
- (3) For low speed curbed roadways, a drop-off of 6 feet or greater with a slope steeper than 1:3 located within 22 feet of the traveled way (See **Figure 215.3.3**).
- (4) A drop-off that has had 3 crashes within a 5 year period. Five years of crash data for a particular site can be obtained from the Safety Office.

For drop-off hazards for pedestrians, see **FDM 222.4**.

Figure 215.3.3 Drop-off Hazard on Curbed Roadways

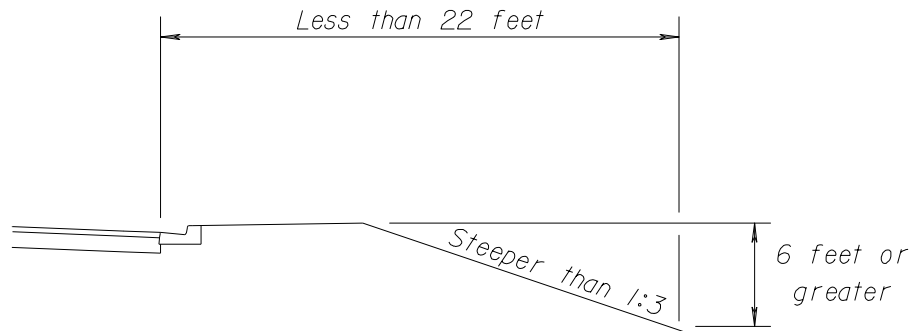

215.3.3.1 Work Zone Drop-offs

For drop-off criteria in work zones see [Standard Plans, Index 102-600](#). Anticipate drop-offs that are likely to occur during construction and provide the appropriate shielding. In locations where shielding is not practical, such as areas with numerous driveways, add a plan note requiring a return to acceptable conditions by the end of each day's construction period.

215.3.4 Additional Hazard Considerations

Engineering judgment should be used when evaluating hazardous conditions, and should consider; roadway geometry, proximity to facility or building, level of activity, and traffic conditions and operations. These conditions may include:

- (1) Bridge piers that are not designed for vehicle impact loads,
- (2) Bicycle and pedestrian facilities,
- (3) Residential buildings, schools, businesses, and
- (4) The presence of personnel in work zones.

Requirements for Bridge Pier Protection are provided in **FDM 215.4.5.4**.

Considerations regarding Positive Protection in Work Zones are provided in **FDM 215.4.9**

215.4 Longitudinal Barriers, Barrier Transitions, End Treatments & Crash Cushions

Roadside barriers, transitions, end treatments (trailing anchorages and approach terminals), and crash cushions must be full-scale crash tested in accordance with either:

- (1) **NCHRP Report 350: Recommended Procedures for the Safety Performance Evaluation of Highway Features** (NCHRP 350), or
- (2) AASHTO Manual for Assessing Safety Hardware, 2016 (MASH).

Bridge Traffic Railings must be evaluated and designed in accordance with the **Structures Design Guidelines** ([SDG](#)).

The criteria for crash testing specified in **NCHRP 350** and **MASH** provides six Test Levels (TL-1 thru TL-6) for the evaluation of roadside hardware suitability with consideration for vehicle type, mass, speed and impact angle. Each Test Level provides an increasing level of service in ascending numerical order. For additional information regarding appropriate application of Test Levels for Barrier Type Selection refer to **FDM 215.4.5** and the **AASHTO RDG**.

Barriers, transitions, and end treatments consist of both proprietary and non-proprietary devices. Non-proprietary/Standardized devices are detailed in the [Standard Plans](#). Proprietary products are included on the [APL](#). These device address the majority of roadside needs on the State Highway System.

Non-standard roadside hardware (i.e. devices not included in either the [Standard Plans](#) or the [APL](#) may sometimes be needed to address unique situations, but are not permitted without prior approval by the Structures Design Office (SDO) for traffic railings (e.g., bridges, noise walls, wall copings), or the Roadway Design Office (RDO) for other roadside hardware. For additional information on the use of Non-Standard Roadside Safety Hardware refer to **FDM 215.8**.

215.4.1 Longitudinal Barriers

215.4.1.1 Flexible Barrier

Flexible Barrier systems provide the least severe impact conditions with the greatest deflections. The only Department-approved flexible barrier system is High Tension Cable Barrier (HTCB) and is currently available for implementation through the Departments **Developmental Standard Plans** process. Detailed information on the usage

requirements and design criteria of HTCB can be found on the Departments Website (<http://www.fdot.gov/design/standardplans/>), which includes the following:

- Developmental Standard Plans Instructions, D540-001
- Developmental Standard Plans, Index D540-001
- Developmental Specification, Dev540

When considering the use of a **Developmental Standard Plans Index**, review the **Developmental Standard Plans Usage Process** included in **FDM 115**.

215.4.1.2 Semi-Rigid Barrier

Semi-Rigid Barriers include the following:

- (1) W-Beam Guardrail – [Standard Plans](#), **Index 536-001**
 - (a) General, TL-3 Guardrail – Post spacing at 6'-3" (TL-3, MASH)
 - (b) Low-Speed, TL-2 Guardrail – Post spacing at 12'-6" (TL-2, MASH)
- (2) Modified Thrie-Beam Guardrail – [Standard Plans](#), **Index 536-001** (TL-4, NCHRP-350)

W-Beam Guardrail with posts at 6'-3" spacing, rail height of 2'-1" to center of panel and midspan splices, as detailed in [Standard Plans](#), **Index 536-001**, was developed based on the **31" Midwest Guardrail System (MGS)**. Compatible proprietary components may be referred by the 31" height.

TL-3 Guardrail installations may be used for all design speeds; however, installations on roadways with Design Speeds > 45 mph must have a minimum length of 75 feet, unless attached to a permanent rigid barrier.

The use of Low-Speed, TL-2 Guardrail is limited to flush shoulder roadways with Design Speeds ≤ 45 mph.

Installations of W-Beam Guardrail with 8-in offset blocks on wood or steel posts are detailed in [Standard Plans](#), **Index 536-001**. W-Beam guardrail may also be installed at a reduced post spacing (i.e. less than 6'-3") to reduce deflection of the system. Reduced post spacing may be used for all design speeds in accordance with spacing and setback requirements provided in **Table 215.4.2**.

The use of Thrie-Beam Guardrail panels is restricted to Modified Thrie-Beam, Thrie-Beam Retrofits (e.g., Metal Traffic Railings) and Barrier Transitions only.

Although Modified Thrie-Beam has been crash tested to NCHRP 350, TL-4 requirements as a longitudinal barrier, it presents unique challenges due to a lack of proven options for end treatments and transitions. As a result, project specific details are required for Modified Thrie-Beam installations.

215.4.1.3 Rigid Barrier

Rigid Barriers are assumed to exhibit no deflection under impact conditions; however, crash severity will likely be the highest of all barrier options. Rigid barrier includes Concrete Barriers and Traffic Railings. Concrete barriers are included for roadway applications and Traffic Railings are designed for structural applications (e.g., bridges, noise walls, wall copings).

Modifications to Rigid Barriers require approval from Office of Design (SDO or RDO). Modifications may include the following:

- Reinforcement details
- Surface treatments
- Material substitutions
- Geometric discontinuities along the length of the barrier
- Non-standardized attachments that do not meet the requirements of either this manual or [SDG](#)
- Non-standardized and unfilled pockets or blockouts
- End transition details
- Traffic face geometry

Rigid Barriers include the following:

- (1) Single-Slope Concrete Barriers (roadside applications):
 - (a) Median – [Standard Plans](#), [Index 521-001](#) (TL-4, MASH)
 - (b) Shoulder – [Standard Plans](#), [Index 521-001](#) (TL-4, MASH)
 - (c) Curb & Gutter - [Standard Plans](#), [Index 521-001](#) (TL-2, MASH)
 - (d) Pier Protection – [Standard Plans](#), [Index 521-002](#) (TL-5, MASH)

- (2) Traffic Railings (bridges, noise walls, and wall copings):
- (a) Bridges – [Standard Plans](#), **Index 521-422 thru 521-427** (TL-4, MASH) and **Index 428** (TL-5, MASH)
 - (b) Thrie-Beam Retrofits – [Standard Plans](#), **Index 460-470 thru 460-476** (TL-3, MASH) and **Index 460-477** (TL-2, MASH)
 - (c) Vertical Face Retrofits – [Standard Plans](#), **Index 521-480 thru 521-484** (TL-3, MASH)
Note: Use Tapered End Transition, [Standard Plans](#), **Index 521-484**, for Design Speed \leq 40 mph only. Not permitted within the clear zone of approaching traffic unless site-specific justification is provided and approved by the District Design Engineer.
 - (d) Noise Wall – [Standard Plans](#), **Index 521-509 thru 521-515** (TL-4, MASH) (TL-5 option available from Structures Design Office)
 - (e) Wall Coping – [Standard Plans](#), **Index 521-610 and 521-612** (36" Single-Slope and 42" Vertical, TL-4, MASH) (42" Single-Slope, TL-5, MASH)

Design bridge railings in accordance with the [SDG](#). On projects where an existing bridge is to remain, the bridge railings must be replaced or upgraded unless the railing meets criteria for new railings. Superseded FDOT Standard New Jersey Shape and F-Shape Traffic Railings conforming to the designs shown in **Standard Plans Instructions for Index 536-002**, "A Historical Compilation of Superseded Florida Department of Transportation 'Structures Standard Drawings' for 'F' and 'New Jersey' Shape Structure Mounted Traffic Railings", are both structurally and functionally adequate for TL-3 MASH.

For information regarding existing traffic railings, see **FDM 215.7.4**.

Details and typical applications of standard bridge railings are provided in **Figures 215.4.1 – 215.4.10**. Refer to **FDM 222.4** for details of pedestrian/bicycle railings and fencing.

Figure 215.4.1 Bridge Traffic Railings – F-Shapes

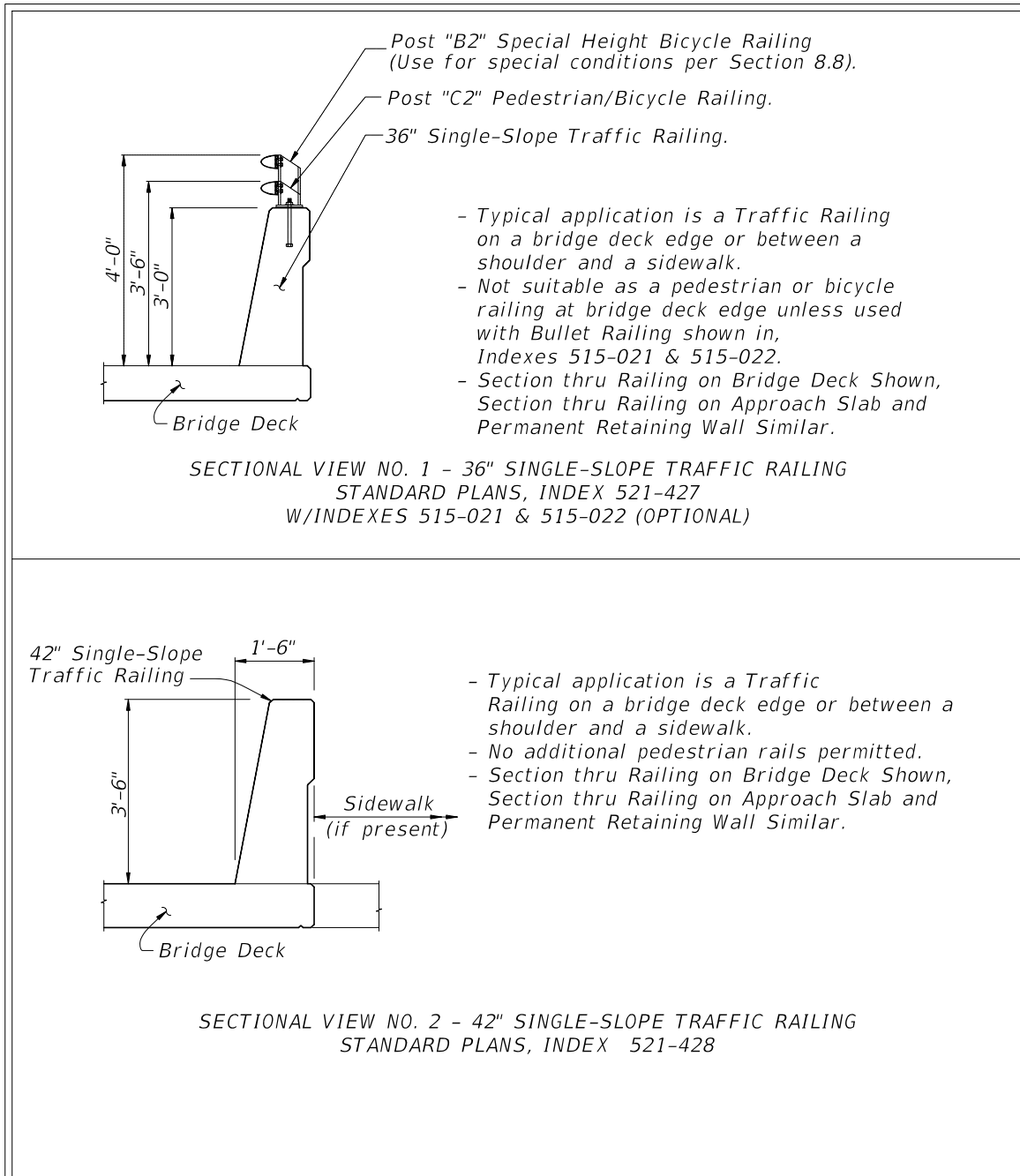

Figure 215.4.2 Bridge Traffic Railings – Vertical Shapes

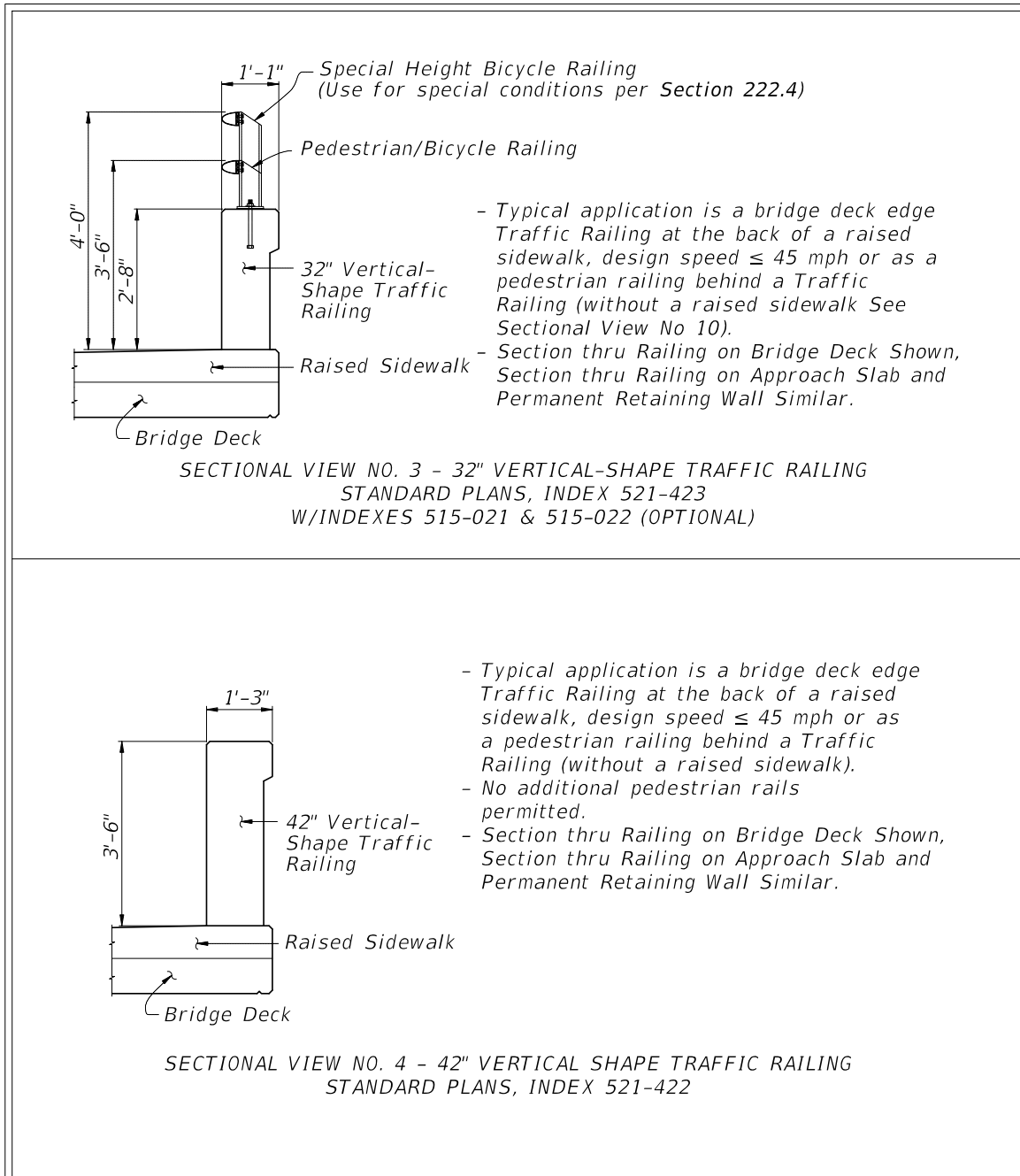

Figure 215.4.3 Bridge Traffic Railings – Other Shapes

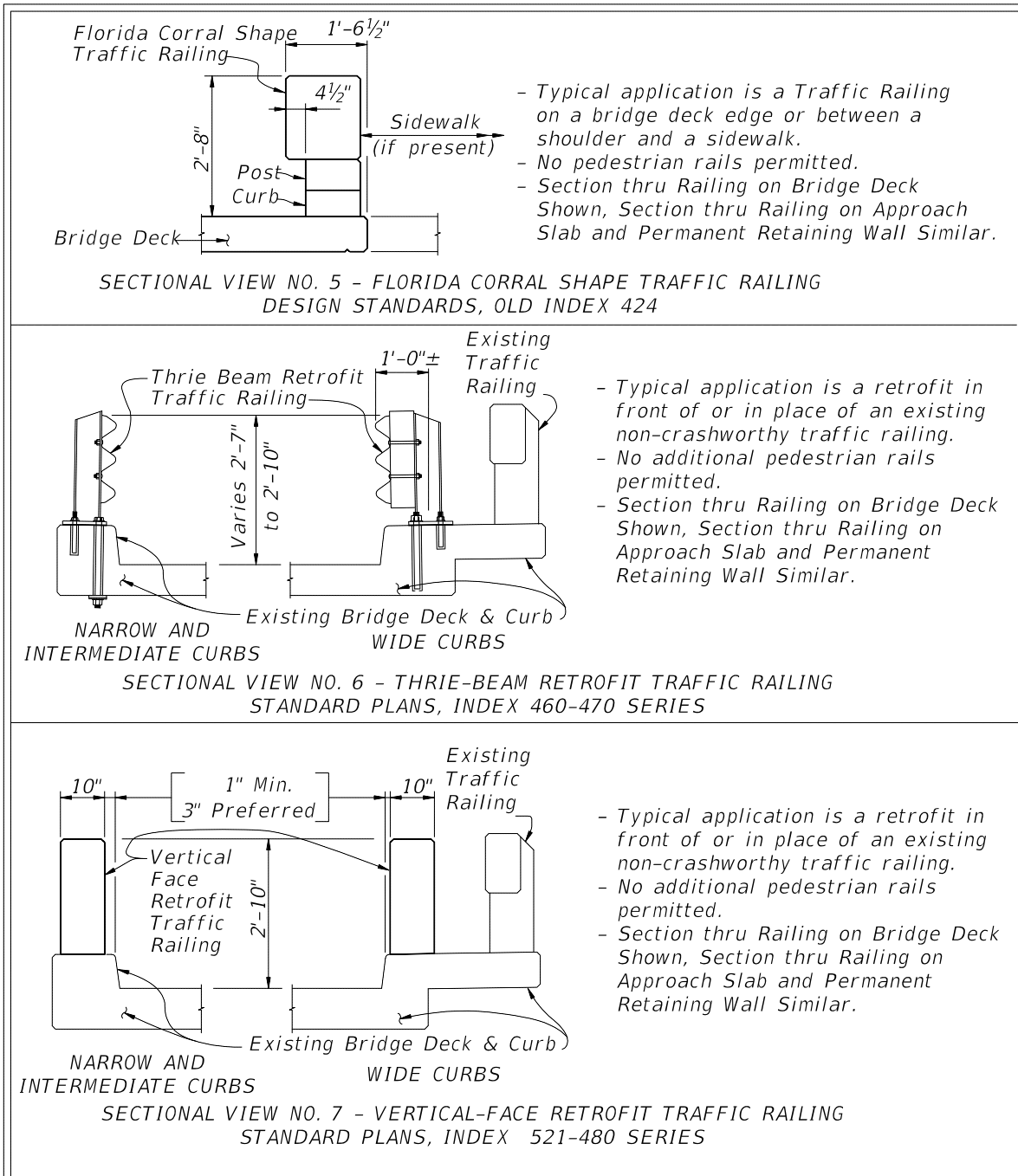
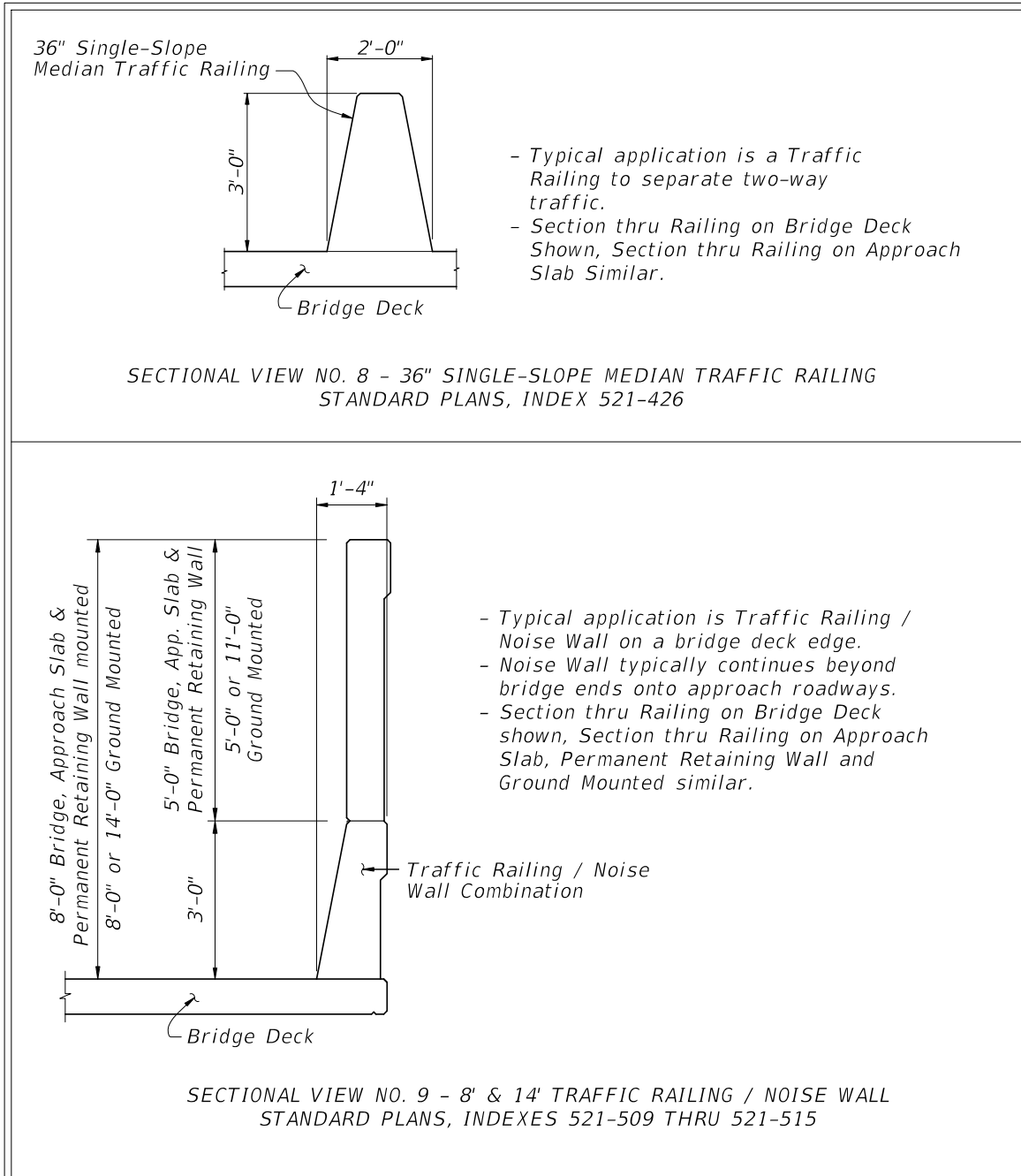

Figure 215.4.4 Bridge Traffic Railings – Median Traffic Railing and Traffic Railing/Noise Wall Combination



215.4.1.4 Temporary Barriers

Temporary Barriers are used in work zones to protect motorists and as Positive Protection to safeguard construction workers while construction activities are taking place. General information about the application of Temporary Barriers can be found in [Standard Plans](#), **Index 102-100**.

Temporary Barriers are installed in either 'Anchored' or 'Free-standing' conditions based on the barrier type and needed setback distance. See the Installation Data table provided in [Standard Plans](#), **Index 102-100** for the lateral offset and setback distance requirements.

Temporary Barriers include the following:

- (1) Low Profile Barrier – [Standard Plans](#), **Index 102-120** (TL-2, NCHRP 350)
- (2) Type K Barrier – [Standard Plans](#), **Index 102-110** (TL-3, NCHRP 350)
- (3) Proprietary Temporary Barrier – See **APL** (TL-3, NCHRP 350 and MASH)

Low Profile Barriers are required for Work Zone Speeds of ≤ 45 mph where temporary barrier is needed within 100 feet of an intersection, residential driveway or business entrance. Use of other barriers is not permitted at these locations due to sight distance limitations. Low Profile Barrier can be used on bridges where no drop-off is present. Transitions from Low Profile Barrier to other temporary barriers within a run of barrier (i.e. from begin length of need to end length of need) is not permitted.

Type K Barrier is a portable concrete barrier which has the capability of being anchored (i.e. staked or bolted) to limit deflections or installed in a free-standing configuration. See [Standard Plans](#), **Index 102-110** for specific requirements for the use of Type K Temporary Concrete Barrier Refer to [Standard Plans](#), **Index 102-110** for details on transitioning between the Type K Temporary Concrete Barrier on bridges and other concrete barrier systems on the adjoining roadway.

Proprietary Steel Barriers (anchored only), Water Filled Barriers (free-standing only) and portable concrete barriers (free-standing or anchored) must be used in accordance with the Vendor drawings on the [APL](#). To allow for the use of [APL](#) devices refer to temporary barrier the Plans as either 'Anchored' or 'Free-standing', unless specific limitations are required. Proprietary steel barriers listed on the [APL](#) are anchored to limit deflections; however, barrier heights and drainage performance may limit some systems.

Anchored (bolted) temporary barriers are not permitted on bridge superstructures that contain post-tensioned tendons within the concrete deck (top flange of concrete box

girders) or on bridge superstructures consisting of longitudinally prestressed, transversely post-tensioned, solid, or voided concrete slab units.

If Flexible (HTCB, **Index D540-001**) or Semi-Rigid (Guardrail, **Index 536-001**) barrier is used in a temporary configuration, or allowed to remain during a portion of the Temporary Traffic Control (TTC) Plan, requirements for the permanent application of barrier must be met; e.g., grading, deflection space, offset from Edge of Traveled Ways.

215.4.2 End Treatments

Non-crashworthy longitudinal barrier ends are hazards for approach direction when terminated within the clear zone. Crashworthy end treatments for each barrier type (flexible, semi-rigid, and rigid) are provided in the [Standard Plans](#).

Flexible barrier end treatments are vendor-specific. For additional information regarding the end treatment of HTCB, refer to [Developmental Standard Plans, Index D540-001](#), as referenced above.

215.4.2.1 Guardrail End Treatments

Guardrail end treatments are necessary to provide crashworthy ends for approaches and anchorage of the guardrail system. For the guardrail to provide adequate redirective capabilities during a vehicle impact, anchorage of the system is needed for tensile (ribbon) strength to develop in the guardrail panels. Approach terminals provide both anchorage of the guardrail system and a crashworthy approach. End treatments for guardrail are categorized as follows:

- (1) Approach Terminals – required for guardrail ends within the clear zone of approaching traffic. Guardrail approach terminals must be a proprietary device listed on the [APL](#). Approach terminals are classified by Test Level (TL-2 for Design Speeds ≤ 45 mph or TL-3, which is acceptable for all design speeds) and as follows:
 - (a) Flared – preferred terminal for locations where sufficient space is available to offset barrier end from approaching traffic.
 - (b) Parallel – use only when sufficient space is not available for a flared terminal.
 - (c) Double Face – preferred end treatment for double faced guardrail installations.
- (2) Crash Cushion – See **FDM 215.4.3**.

- (3) Trailing End Anchorages (Type II) – required for anchoring of the trailing ends of guardrail. Trailing end anchorages are non-crashworthy as an approach end treatment, and are not permitted as a guardrail end treatments on the approach end within the clear zone, unless shielded by another run of barrier. The Type II Trailing End Anchorage, is detailed in the [Standard Plans, Index 536-001](#).

215.4.2.2 Rigid Barrier End Treatments

Terminate rigid barrier by either transitioning into another barrier system (e.g., guardrail), or by shielding with a crash cushion. Details and requirements are provided in the [Standard Plans](#).

Sloped concrete end treatment using a vertical height transition, detailed in [Standard Plans, Index 521-001](#), are not permitted within the clear zone of approaching traffic lanes. With sufficient justification the District Design Engineer may grant approval for use of this end treatment within clear zone for design speeds 35 mph and less, and only when no other more crashworthy solution is available.

Treatment of the trailing end of rigid barriers is not required unless additional hazards exist beyond the rigid barrier or the barrier is within the clear zone of opposing traffic.

215.4.2.3 Temporary Barrier End Treatments

The required treatments for exposed ends of temporary barriers are:

- (1) Connecting to an existing barrier (smooth, structural connections are required - Refer to [Standard Plans, Indexes 102-100](#) and [102-110](#), or the [APL](#));
- (2) Shield end with a crash cushion as detailed in the [Standard Plans](#) or [APL](#) for the specific type of temporary barrier (i.e. Temporary Concrete, Steel, or Water Filled); or,
- (3) Flaring outside of the Work Zone clear zone (See [Standard Plans, Index 102-600](#))

No modifications to the end treatments included in the [Standard Plans](#) or [APL](#) are permitted. Special conditions may require end treatments other than those included above. If this occurs, consult the State Roadway Design Office (RDO) and provide special details in the Plans.

215.4.3 Crash Cushions

Crash cushions (impact attenuators) are used to protect motorists from the exposed ends of barriers, fixed objects and other hazards within the clear zone. They are energy absorbing devices that may be redirective non-gating, or non-redirective gating. Crash cushions are classified based on Test Level and design speed, as shown for each system on their respective [APL](#) drawings.

The design of a crash cushion system must not create a hazard to opposing traffic. [APL](#) drawings provide details for transitions for optional barrier types with and without bi-directional traffic.

An impacting vehicle should strike the systems at normal height, with the vehicle's suspension system neither collapsed nor extended. Therefore, the terrain surrounding crash cushions must be flat (1:10 or flatter) in advance of and along the entire design length of the system. Do not locate curbs within the approach area of a crash cushion.

215.4.3.1 Permanent Crash Cushions

Permanent crash cushions must be redirective non-gating. Standard details of systems for typical installations shielding concrete barrier wall ends and guardrail ends can be found on the [APL](#) under **Section 544**. In addition, some of these systems have standard details for shielding wide hazards. For applications not covered in the [APL](#) drawings, crash cushion vendors normally provide design assistance for their systems. Special designs must be detailed in the Plans and based on meeting the performance criteria for the established design speed of the facility (i.e. barrier system Test Level).

215.4.3.2 Temporary Crash Cushions

Two types of temporary crash cushions are permitted;

- Redirective non-gating crash cushions
- Non-redirective gating crash cushions

Redirective crash cushions will shield hazards by redirecting errant vehicles impacting the side of the crash cushion and decelerate errant vehicles from a direct, in-line impact at the terminus of the crash cushion by absorbing the energy.

Gating crash cushions are designed to decelerate errant vehicles from a direct, in-line impact at the terminus of the crash cushion by absorbing the energy, but provide no redirective capabilities for side impacts. Use of gating crash cushions require approval

from the State Roadway Design Office (RDO). Gating cushions may be appropriate on low speed facilities and in work zones with higher speeds where only low impact angle hits are expected. An adequate clear runout area must be provided beyond a gating crash cushion (between the departure line and the clear zone). Plan details for site specific design are required.

Approved temporary crash cushions for use on Department contracts are listed on the [APL](#) under **Section 102**. Sand barrel gating systems are not permitted.

Anchored (bolted) temporary crash cushions are not permitted on bridge superstructures that contain post-tensioned tendons within the concrete deck (top flange of concrete box girders) or on bridge superstructures consisting of longitudinally prestressed, transversely post-tensioned, solid, or voided concrete slab units.

215.4.4 Barrier Transitions

Guardrail transitions are necessary, whenever standard W-Beam guardrail converges with rigid barriers. Guardrail transitions must include sound structural connections, nested panels and additional posts for increased stiffness. Use the guardrail transitions included in the [Standard Plans](#) as follows:

- (1) General, Guardrail Approach Transition to Rigid Barrier – **Index 536-001** (Single or Double Face Guardrail, TL-3, MASH), Approved for all Design Speeds.
- (2) Low Speed, Guardrail Approach Transition to Rigid Barrier – **Index 536-001** (Single Face Guardrail only, TL-2, MASH), Approved for Design Speeds ≤ 45 mph only with Flush Shoulder or Curb.
- (3) Trailing End Transition Connection – **Index 536-001** (Test Level N/A), Approved for all Design Speeds.

Various other barrier transitions are detailed throughout the [Standard Plans](#) and [APL](#) drawings for transitions from temporary barriers to permanent rigid barriers and transitions from variable height/shape rigid barriers.

215.4.5 Barrier Type Selection

Consider the following factors when determining the appropriate barrier type:

- (1) Barrier Placement requirements (see **FDM 215.4.6**)
- (2) Traffic characteristics (e.g., volume, percent trucks)

- (3) Site characteristics (e.g., terrain, alignment, geometry, access facility type, access locations, design speed)
- (4) Expected frequency of impacts
- (5) Initial and replacement/repair costs
- (6) Ease of maintenance
- (7) Exposure of workers when conducting repairs/maintenance
- (8) Aesthetics

For additional information about considerations for barrier selections refer to the **AASHTO RDG**. Document barrier type selection decisions and warrants.

215.4.5.1 Longitudinal Barrier Selection



There are four options for longitudinal barrier; HTCB, W-Beam Guardrail, Modified Thrie-Beam Guardrail, and Rigid Barriers. **Table 215.4.1** provides guidance regarding roadway barrier type selection.

Specific requirements for the selection of HTCB are provided in the **Standard Plans Instructions** for **Index D540-001**.

Based on the limitations noted in **FDM 215.4.1.2**, the use of Modified Thrie-Beam Guardrail should be restricted to locations where site specific conditions warrant a more robust guardrail system but not the added cost of rigid barrier system.

Refer to the [SDG](#) for barrier type and test level selection of Traffic Railings.

Table 215.4.1 Roadway Barrier Type Selection

Barrier Type	Deflection Space Requirement	Order of Bias			Test Level	Design Vehicles			
		Initial Cost	Vehicle Impact Severity	Maintenance Cost					
	(feet)								
HTCB	12	LOW	LOW	HIGH	TL-4 (NCHRP 350)	Passenger Car, Pickup Truck, & Single-Unit Truck			
W-Beam Guardrail	5				TL-2 & TL-3 (MASH)	Passenger Car & Pickup Truck			
Modified Thrie-Beam Guardrail	3				TL-4 (NCHRP 350)	Passenger Car, Pickup Truck, & Single-Unit Truck			
Rigid Barrier	0				HIGH	HIGH	LOW	TL-3, TL-4 & TL-5 (MASH)	Passenger Car, Pickup Truck, Single-Unit Truck & Tractor-Van Trailer

215.4.5.2 End Treatment Selection

Select end treatments in accordance with **FDM 215.4.2**, the [Standard Plans](#) and the **Standard Plans Instructions** for each applicable barrier type.

215.4.5.3 Crash Cushion Selection

Various types of energy absorbing devices eligible for use on Department projects as crash cushions can be found on the [APL](#). Detailed information about these systems is provided in the [Standard Plans](#), [APL](#), and in each manufacturer's publications. Each system has unique physical and functional characteristics.

For permanent crash cushion applications, indicate in the Plans the requirements for each given location in accordance with [Standard Plans](#), [Index 544-001](#), and [FDM 307](#), including the:

- (1) Location (station and side),
- (2) Barrier system (concrete barrier wall or guardrail),
- (3) Design length,
- (4) Design speed,
- (5) Crash test level, and
- (6) Hazard width and length restriction.

Site characteristics and economics dominate crash cushion selection considerations. Some crash cushion systems are relatively low in initial cost, but usually must be completely replaced when struck, so are more appropriate in locations with a low likelihood of collision. There are a number of other systems that have higher initial costs but can be repaired after collisions relatively quickly and inexpensively, so are more appropriate where frequent collisions are anticipated. The ability of maintenance forces to perform routine maintenance and to place a crashed system back into service quickly should be a major consideration. Do not use crash cushions that require stocking unusual and expensive parts or those that are complex to replace.

215.4.5.4 Pier Protection

In addition to shielding bridge piers to protect motorists from a hazard within the clear zone, bridge piers may need shielding for protection from damage due to design limitations (i.e. piers not designed for vehicular collision forces). Coordination with the Structural Engineer of Record is required to determine if pier protection is warranted.

The requirements for Pier Protection are outlined in the [SDG, Section 2.6](#). The process for determining the appropriate level of Pier Protection for New Construction projects is presented in [Figure 215.4.5](#) (Pier Protection Selection Flowchart). For RRR and railroad requirements, refer to the [SDG](#). Detail Pier Protection barrier in accordance with [Standard Plans, Index 521-002](#).

Figure 215.4.5 Pier Protection Selection Flowchart (New Construction)

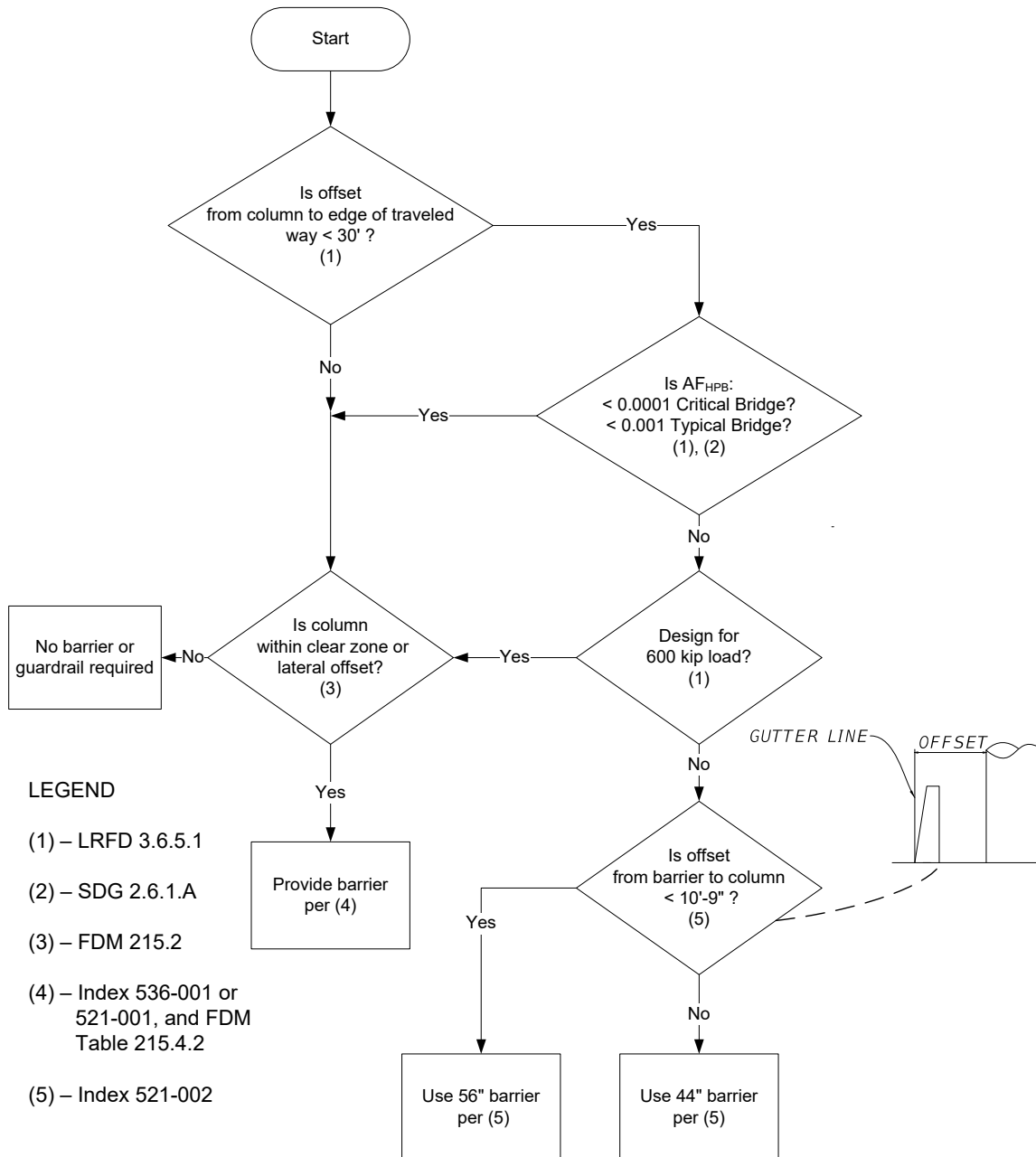

215.4.6 Barrier Placement

The primary design factors associated with barrier placement are:

- (1) Lateral Offset from the Edge of Traveled Way,
- (2) Deflection Space Tolerance,
- (3) Terrain Effects,
- (4) Length of Need,
- (5) Space for End Treatments, and
- (6) Outside Shoulder or Median Application

215.4.6.1 Barrier Offset

Offset roadside barriers as far from the travel lanes as practical with consideration for maintaining the proper performance of the barrier. See ***Developmental Standard Plans Instructions*** for ***Index D540-001*** for the barrier placement requirements for HTCB.

Requirements for guardrail offsets are illustrated in ***Figure 215.4.6***.

For flush shoulder roadways the standard offset for W-Beam Guardrail from the Edge of Traveled Way is the shoulder width plus 2 feet, not to exceed 12 feet. The 12 feet maximum offset for guardrail is established to reduce the potential for impacts where the vehicle is behaving significantly different than the crash tested conditions (i.e. non-tracking, fish-tailing, excessive approach angle, etc.). Guardrail offsets greater than 12 feet require site-specific justification in accordance with ***FDM 215.4.7***, unless location is based on the requirements of ***FDM 215.4.6.4, Median Barrier*** or ***FDM 215.3.2, Canal Hazards***.

When curb is present, the preferred configuration is to place the face of the guardrail panel 5 inches from the face of curb. For design speeds ≤ 45 mph, the face of the guardrail panel may also be placed between 4 feet and 12 feet from the face of curb.

Rigid Barrier is typically used when there are barrier deflection or right-of-way limitations. Rigid Barrier offsets should be based on site-specific conditions, but as far from the traveled way as possible.

Rigid Barrier, with the exception of F-Shape or Single-Slope barriers with a height less than 42", may be used in combination with curbs, and provide an acceptable alternative to the areas excluded for guardrail use in ***Figure 215.4.6***.

Figure 215.4.6 Lateral Offset to Guardrail

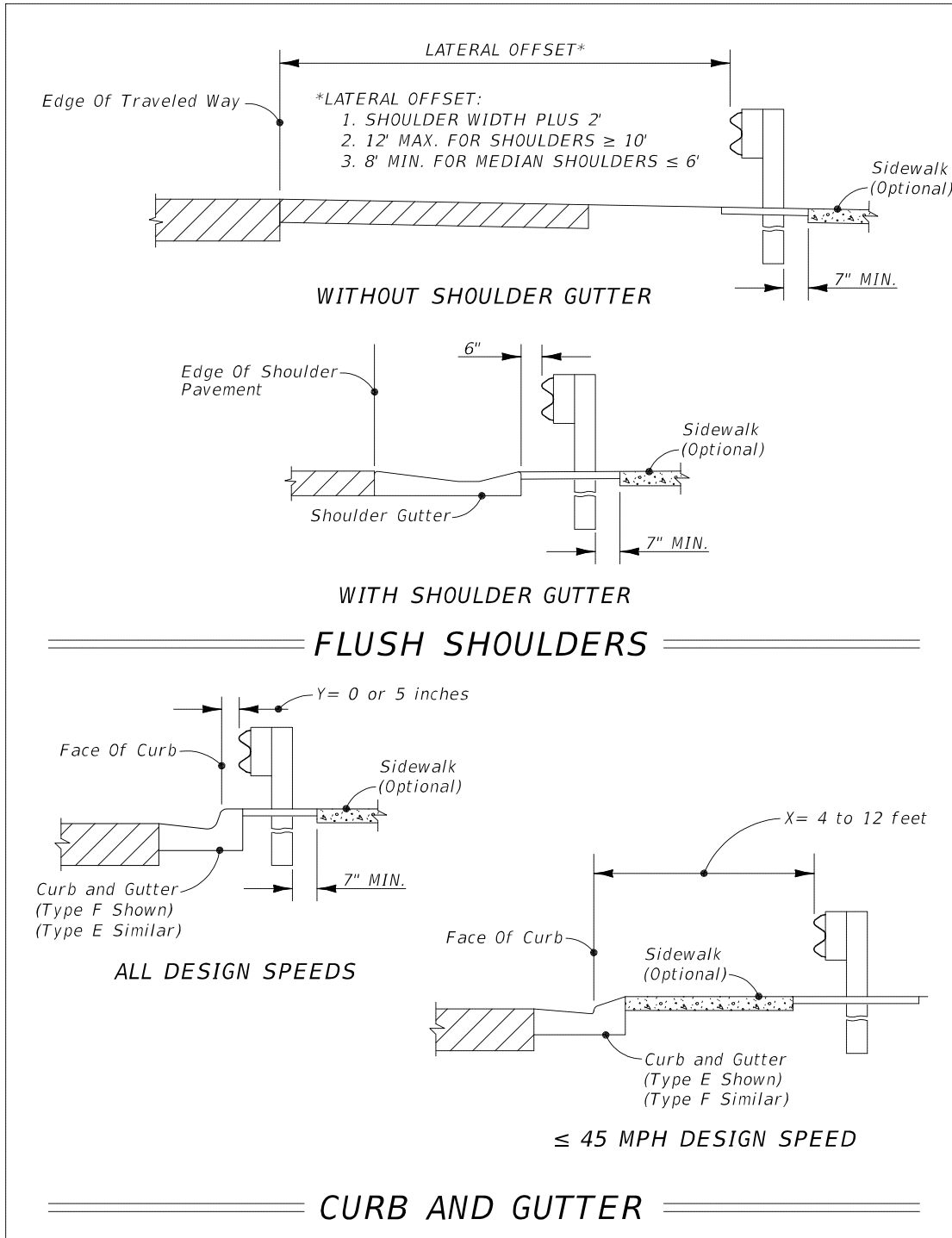

In addition to travel lane lateral offset considerations, an adequate setback must be provided behind the barrier to ensure proper function. For flexible and semi-rigid barriers the setback is based on deflection tolerances and is required to prevent the barrier from contacting aboveground hazards.

For rigid barriers the setback is required to keep the area above and behind the barrier face free of obstructions that could penetrate or damage the vehicle compartment. This requirement is based on the “Zone of Intrusion” concept as described in the **AASHTO RDG. Table 215.4.2** provides the Setback requirements for FDOT standard barriers. Additionally, **Figure 215.4.7** includes setback distances to rigid barriers for discontinuous elements. These requirements do not apply to devices detailed in the [Standard Plans](#) as attachments to rigid barriers (e.g., pedestrian/bicycle bullet railing, bridge fencing, traffic railing/noise wall combinations).

**Table 215.4.2 Minimum Barrier Setback
 (Measured from the face of the barrier)**

Barrier Type	Setback Distance
Flexible Barrier	
High Tension Cable Barrier (HTCB)	12 feet, 0 inches
Semi-Rigid Barrier	
W-Beam with Post Spacing @ 6 feet, 3 inches (TL-3)	5 feet, 0 inches
W-Beam with Post Spacing @ 12 feet, 6 inches (TL-2)	5 feet, 0 inches
W-Beam with Post Spacing @ 3 feet, 1.5 inches (½ Spacing)	3 feet, 10 inches
W-Beam with Post Spacing @ 1 foot, 6.75 inches (¼ Spacing)	3 feet, 2 inches
Nested W-Beams with Post Spacing @ 3 feet, 1.5 inches (½ Spacing)	3 feet, 0 inches
Nested W-Beams with Post Spacing @ 1 foot, 6.75 inches (¼ Spacing)	2 feet, 8 inches
Deep Post W-Beam installed on 1:2 Slope Break with Post Spacing @ 6 feet, 3 inches (TL-3)	5 feet, 6 inches
Modified Thrie-Beam with Post Spacing @ 6'-3"	3 feet, 0 inches
Rigid-Barrier	
Concrete Barrier < 40" Height (Design Speeds ≤ 45 MPH)	0 feet, 0 inches
Concrete Barrier < 40" Height (Design Speeds > 45 MPH) Non-crash Tested Continuous or Discontinuous Items	1 foot, 6 inches
Concrete Barrier ≥ 40" Height	0 feet, 0 inches
Bridge Traffic Railing < 40" Height Non-crash Tested Continuous Items Non-crash Tested Discontinuous Items	5 feet, 0 inches See Figure 215.4.7
Temporary Barriers	
See "Setback Distance" of applicable Standard Plans , Index or APL drawing.	

Figure 215.4.7 Setback Distances for Discontinuous Elements

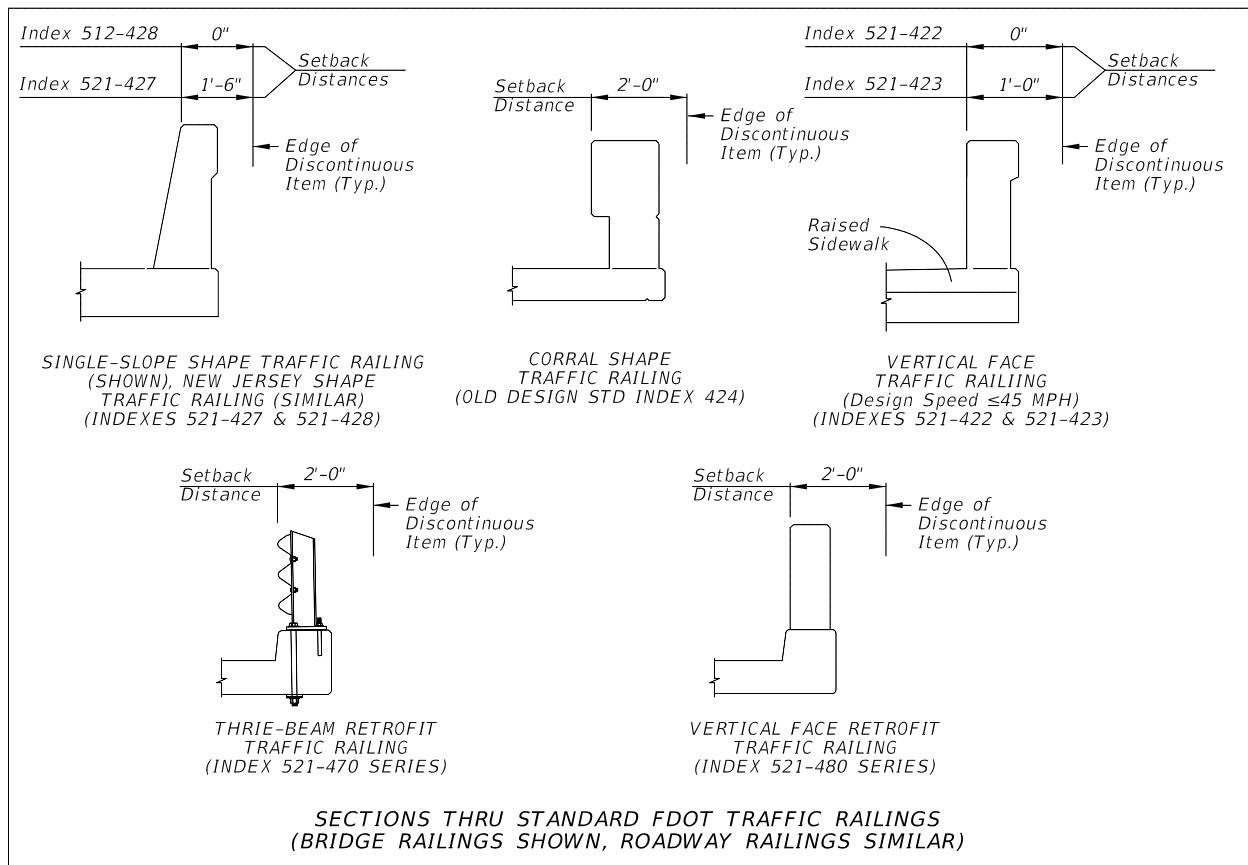

Noise Wall/Traffic Railing combinations located within the setback distance must be crash tested to or accepted as TL-4 under **MASH**. Other continuous items (e.g., glare screens and fences) located within this setback distance must be crash tested to or accepted as TL-3 under **NCHRP 350** or **MASH**.

See **FDM 215.5** for additional information regarding discontinuous attachments to rigid barriers.

215.4.6.2 Grading Requirement

The terrain effects between the traveled way and a barrier can have a significant impact on whether or not a barrier will perform as intended. Proper grading around a barrier will ensure that as a vehicle approaches a barrier its suspension is not dramatically affected, causing the vehicle to underide or override a barrier.

Install barriers on slopes 1:10 or flatter. Continue the 1:10 slope a minimum 2 feet beyond the barrier (i.e. from either the guardrail post or rigid barrier) before providing a slope break.

With approval of the District Design Engineer and where conditions are constrained, the Deep Post guardrail option may be used in lieu of providing a 2-foot setback to the slope break point. Coordinate the use of the Deep Post guardrail option with the District Drainage Engineer and District Maintenance Engineer. See Deep Post details in [Standard Plans](#), **Index 536-001** "Slope Break Condition".

Modification for Non-Conventional Projects:

Delete the last paragraph and see RFP for requirements.

Proper grading around crashworthy end treatments is essential to assure the device performs as intended. Grading requirements are shown in the [Standard Plans](#).

For superelevated roadway sections, a maximum 7% algebraic difference is permitted between the travel lanes and shoulder in advance of barriers. See **FDM 215.4.6.5** for temporary barrier requirements in superelevated roadway sections.

215.4.6.3 Length of Need

Length of need is dependent on:

- (1) Barrier type
- (2) Design speed
- (3) Offset distance to the face of the barrier
- (4) The lesser distance to either the back of the hazard or to the clear zone

Use the requirements provided in the [Standard Plans Instructions](#) or the [Standard Plans](#) to establish length of need for each barrier type.

215.4.6.4 Continuous Median Barriers

Continuous median barriers are used to mitigate median crossover crashes (i.e., reduce the number of vehicles that might enter opposing lanes of traffic after traversing a median).

Locate continuous median barrier in accordance with guidelines included in the **AASHTO RDG, Section 6.6** and in accordance the [Standard Plans](#).

In locations where a continuous median barrier is present, the length of a barrier opening should be minimized to the extent practical. As shown in **FDM Exhibit 211-3**, the barrier ends on each side of the opening should be offset. Provide crashworthy end treatments or crash cushions to shield the barrier ends when the ends are within the clear zone and fall within the departure angle used to set length of need. Provide crashworthy end treatments or crash cushions when the angle between barrier ends is less than 30 degrees measured from the direction of mainline travel.

The preferred barrier option for continuous median barrier is High Tension Cable Barrier (HTCB), provided the requirements of the **Developmental Standard Plans Instructions** for **Index D540-001** can be met. Evaluate other barrier options when the deflection and placement requirements for HTCB cannot be met.

Include Rub Rail on double faced w-beam guardrail installations as shown in [Standard Plans, Index 536-001](#). Based on the shoulder width and as shown in **Figure 215.4.6**, locate double faced w-beam guardrail at a lateral offset of between 8 feet and 12 feet from the edge of traveled way. For medians with cross slopes of 1:6 or flatter, locate the barrier closest to the traveled way with the most likelihood or history of lane departure (e.g., outside of horizontal curves and sections with outside merge lanes). If median cross slopes greater than 1:6 exist, and HTCB is not feasible, install w-beam guardrail along both sides of the median or consider a grade separated (bifurcated) median with a concrete barrier.

Use concrete median barrier when the barrier offset requirements for flexible or semi-rigid barrier cannot be met or a higher test level barrier is justified. Implement concrete median barrier in accordance with [Standard Plans, Index 521-001](#).

215.4.6.5 Requirements for Culverts

Roadside barriers placed at a culvert (i.e., box culvert, bridge culvert, or three-sided culvert) should be either W-Beam Guardrail or Bridge Traffic Railing. See **Chapter 6** of the [Structures Design Guidelines](#) for more information regarding bridge traffic railings.

W-Beam Guardrail is the preferred barrier option, provided the grading, post embedment and length of need requirements can be met. A minimum of 4 feet of fill must be provided over the culvert for adequate post embedment and performance. If there is less than 4 feet of fill over the culvert, utilize one of the following options:

- (1) Culverts with total overall widths ≤ 5 feet: use W-Beam Guardrail with a post layout that straddles the outside of the culvert using standard post spacing of 6'-3".
- (2) Culverts with total overall width between 5 feet and 20 feet: use shortened W-Beam guardrail posts (e.g., Encased Post for Shallow Mount). See Design Standards, Index 400.
- (3) Culverts with total overall width > 20 feet: use a project specific designed metal traffic railing similar to the Thrie-Beam Retrofit barriers (i.e. thrie-beam railing attached directly to the culvert headwall), see the ***Standard Plans, Index 460 Series***. Designers should note that the locations of the first and last posts are critical. Headwalls must be a minimum of 18 inches wide and the base plate must be located so that it is located at least 12 inches away from any construction joint or free end of the concrete headwall.

Placement of base plates and bolts in the top slab of the culvert barrel should be avoided because they are difficult to repair and maintain, the necessary anchor embedment lengths are problematic to obtain, and they are potentially damaging to the top of the culvert barrel.

Concrete rigid barrier or bridge traffic railing is typically not used due to the short length of culverts, unless continued along the roadway for other reasons.

215.4.6.6 Temporary Barriers

Installation instructions and flare rates are given in [Standard Plans, Indexes 102-100, 102-110, 102-120](#) and [102-600](#).

A temporary or permanent pavement surface with a maximum cross slope of 1:10 is required when a temporary barrier is used. Refer to [Standard Plans, Index 102-100](#) for setback distance and asphalt pad requirements.

Show or note the location of temporary barriers in the Temporary Traffic Control (TTC) Plans. Also provide a Work Area Access Plan for projects with work zones shielded with a barrier. For additional information regarding TTC Plans, refer to ***FDM 240***.

The presence of barriers on both shoulders may eliminate any effective shoulder width or refuge area. The effective shoulder width is required to ensure an area is available for

both disabled vehicles during normal traffic conditions and access for emergency responders during stopped conditions. Therefore, on interstate, freeway, and expressway projects requiring barriers on both sides of the work zone traveled way, a minimum 10-foot lateral offset from the edge of the traveled way to the barrier is required on at least one side of the roadway. Bridge construction and associated roadway approaches are exempt from this requirement. Providing this 10-foot lateral offset on arterials and collectors should be considered. For all other applications, provide the minimum lateral offset required per [Standard Plans, Index 102-100](#).

When using existing barrier during a temporary traffic control operation or when 2-way traffic is placed on a facility that is normally one-way, the existing permanent or temporary barriers must be modified as necessary to ensure their proper crashworthiness during the temporary situation. This will include eliminating non-crashworthy end treatments, snag points or other protrusions normally angled away or hidden from approaching vehicles.

Existing permanent barriers used during temporary traffic control operations must meet grading, offset, and setback (i.e. deflection space) requirements for the permanent installation.

Temporary barriers, as defined in **FDM 215.4.1.4**, located in superelevated roadway sections must be installed on the same roadway cross slope as the travel lanes (i.e. no slope break in advance of the barrier).

215.4.7 Warrants for Roadside Barriers

The installation of roadside barriers presents a hazard in and of itself, and as such, requires an analysis for whether or not the installation of a barrier presents a greater risk than the feature it is intended to shield. The analysis should be completed using the **Roadside Safety Analysis Program (RSAP)** or in accordance with the **AASHTO Highway Safety Manual (HSM)**. Refer to **FDM 122.6** for guidance on evaluating the benefits of shielding using **RSAP** or the **HSM**.

Roadside barriers are recommended when hazards exist within the clear zone, hazards cannot be cost effectively eliminated or corrected, and collisions with the hazards are more serious than collisions with the barriers.

The following conditions within the clear zone are considered more hazardous than a roadside barrier:

- (1) Drop-off Hazards, as defined in **FDM 215.3.3**.
- (2) Bridge piers, abutments and railing ends.

- (3) Non-traversable culverts, pipes and headwalls.
- (4) Non-traversable parallel or perpendicular ditches and canals.
- (5) Canals, ponds and other bodies of water.
- (6) Parallel retaining walls with protrusions or other potential snagging features.
- (7) Retaining walls at an approach angle with the edge of pavement larger than 7 degrees (1:8).
- (8) Non-breakaway sign or luminaire supports.
- (9) Trees greater than 4 inches in diameter measured 6 inches above the ground.
- (10) Utility poles.
- (11) Weaving Sections, as defined in **FDM 211.12.1**.

215.4.7.1 Treatment of Roadside Hazards

If a hazard, including slopes steeper than 1:3, is present within the clear zone, eliminate or shield the hazard, except when any of the following apply:

- Longitudinal barrier or crash cushion would be a greater hazard than the hazard to be shielded
- The likelihood of striking the hazard is negligible
- The expense of shielding the hazard outweighs the benefits in terms of crash reduction as determined through the use of **RSAP** or **HSM** analyses.

If crash data or safety reports indicate that treatment of the hazard will result in fewer or less severe crashes, implement one of the following treatments, in order of priority:

- (1) Eliminate the hazard.
 - (a) Remove the hazard.
 - (b) Relocate the hazard outside the clear zone.
 - (c) Make the hazard traversable or crashworthy.
- (2) Shield the hazard with a longitudinal barrier or crash cushion.

215.4.8 Warrants for Median Barrier

Provide a median barrier on LA Facilities when:

- (1) Reconstruction reduces the median width to less than what is required for the facility. Deviation from this criteria is not permitted. An **RSAP** or **HSM** analysis may be used to evaluate barrier alternatives and supplement the following requirements.
- (2) One or more crossover crashes have occurred in the most recent 5-year period within the limits of 1 mile in advance of the exit ramp gore to 1 mile beyond the entrance ramp gore. The District may require shielding outside these areas after reviewing the most recent 5-year crash history.

On divided arterial and collector projects with design speed greater than 45 mph, review the most recent 5-year crash history for crossover crashes to determine if shielding with a median barrier is warranted. Consider alignment, sight distance, median width and frequency of median openings when evaluating the facility.

215.4.9 Positive Protection in Work Zones

For locations where work zone traffic barriers are required, refer to [Standard Plans, Index 102-600](#). Work zone traffic barriers are positive protection devices and temporary barriers that can be easily relocated. They have four specific functions:

- (1) Protect traffic from entering work areas (e.g., excavations or material storage sites).
- (2) Provide positive protection for workers.
- (3) Separate two-way traffic.
- (4) Protect construction such as false work for bridges and other exposed objects.

Anticipate when and where barriers will be needed and include this information and the quantities on the Plans. Consider positive protection devices in work zone situations that place workers at increased risk from vehicular traffic, and where positive protection devices offer the highest potential for increased safety for workers and road users, such as:

- (1) Work zones that provide workers no means of escape from vehicular traffic (e.g., tunnels, bridges).
- (2) Long duration work zones (two weeks or more at the same location) resulting in substantial worker exposure to vehicular traffic.

- (3) Projects with anticipated Work Zone speeds greater than 45 mph, especially when combined with high traffic volumes.
- (4) Work operations that place workers close to travel lanes open to traffic.
- (5) Roadside hazards (e.g., drop-offs, unfinished bridge decks) that will remain in place overnight or longer.

Modification for Non-Conventional Projects:

Delete the first sentence of the above paragraph and see RFP for requirements.

215.5 Attachments to Barriers

Allowable attachments to flexible or semi-rigid barriers (discontinuous or continuous) are detailed in the [Standard Plans](#).

Use [Standard Plans](#), **Index 700-012** for signs attached to rigid barrier. [Standard Plans](#), **Index 700-013** can only be used to mount permanent signs to non-median rigid barriers when there is insufficient space for [Standard Plans](#), **Index 700-012** and the sign is critical to safety.

Design and detail attachments to rigid barriers in accordance with [SDG 1.9](#). Provide setback distances as shown in **Table 215.4.2** and **Figure 215.4.13** to non-crash tested discontinuous items (e.g., light poles, sign supports, traffic signal controller boxes, flood gauges) that are attached to or behind rigid barriers located along the outside shoulder. Discontinuous items located within these setback distances must be crash tested to or accepted as TL-3, at a minimum, under **NCHRP 350** or **MASH** as attachments to traffic railings.

For continuous items attached to rigid barriers, refer to the requirements of **FDM 215.4.6.1**.

Fender access ladders are exempt from these requirements. Sign panels may be placed within the given setback distances, however the setback to the sign support must be increased to assure sign panels do not extend past the top inside face of the traffic railing.

215.5.1 Median Barrier Attachments

Use [Standard Plans](#), **Index 715-002** for light poles installed in conjunction with concrete median barriers or traffic railings. Overhead sign supports may be located on rigid barriers within the median to reduce span or cantilever lengths and provide more cost

effective designs. When placing overhead sign supports on rigid barriers within the median, project specific details that supplement [Standard Plans, Index 521-001](#) (e.g., foundation and reinforcement details) are required to be shown in the Plans.

Single column sign supports mounted on rigid barriers within the median are permitted only when requirements for sign visibility cannot be met by placing the sign supports on the outside of the shoulder barrier or beyond the shoulder. If single column sign supports must be mounted on a median traffic railing, utilize [Standard Plans, Index 700-013](#). The signs listed in **FDM 230.2.5** are the only permanent signs that may be used with [Standard Plans, Index 700-013](#).

These requirements also apply to attachments made to back-to-back outside shoulder rigid barriers that are located so close together that the required setback distances cannot be provided for both barriers. The bridge traffic railings and supporting decks shown in **Figure 215.4.13** that are located back-to-back are exempt from these requirements.

215.5.2 Existing Attachments to Barriers and Traffic Railings

Evaluate existing rigid barrier attachments on a case-by-case basis to ensure they are installed in accordance with the **FDM** and [Standard Plans, Indexes 700-012, 700-013, or 715-002](#). Remove existing attachments not meeting these requirements.

215.5.3 Temporary Attachments to Barriers

[Standard Plans, Index 700-013](#) may be used for temporary work zone signs when the application of [Standard Plans, Index 102-600](#) cannot be achieved.

For additional information on the design of temporary lighting in combination with temporary barrier, refer to **FDM 240.4.2.13**.

215.6 Surface Finishes

Class 5 coatings, tints or stains may be applied to roadway concrete barriers in order to be compatible with the treatment of bridge or retaining wall mounted traffic railings or for corridor uniformity. The follow approvals are required for use of Class 5 coatings:

- (1) District Design Engineer approval when applied on the outside of concrete barriers.
- (2) Chief Engineer approval when applied to median barriers and the inside and top surfaces of concrete barriers.

Abrupt changes of aesthetic treatment of barriers, railings or parapets from a bridge to a roadway should be avoided. See [SDG](#), **Section 1.4.5** for the policy on bridge, noise wall and retaining wall surface finishes.

The Department will cover the cost for coating, tints or stains on roadway concrete barriers only as described above. If a Local Maintaining Agency desires a roadway concrete barrier with coatings, tints or stains and the concrete barrier does not qualify for such treatment as determined by the Department, the barrier may be treated with approval by the District Secretary. The Local Maintaining Agency must provide the additional construction funding for the coatings, tints, or stains and must commit to cover the associated maintenance costs for the service life of the barrier.

Modification for Non-Conventional Projects:

Delete **FDM 215.6** and see RFP for requirements.

215.7 Existing Barrier Systems

When barrier systems are present on a project for which reconstruction of the roadside is not required, the existing barrier should be evaluated to determine if the barrier meets current structural, functional and crashworthy requirements. Remove or replace any barrier installation which is found to be non-crashworthy or crash tested prior to **NCHRP 350** test criteria. The evaluation should consider the following:

- (1) Warrants for the barrier. See **FDM 215.4.4**.
- (2) Length of need.
- (3) Guardrail panel height.
- (4) Offset at terminal end.

- (5) Clear deflection distance between the barrier and the shielded object.
- (6) Placement with respect to the traveled way, or face of curb.
- (7) Placement on the proper slope.
- (8) Clear recovery area behind gating end terminals.
- (9) Overall condition of the barrier system.
- (10) Post type and spacing.

In addition to the above evaluation requirements, existing roadside safety hardware must comply with the requirements of the following Sections.

215.7.1 Resetting Guardrail

For installations of guardrail where the barrier is determined to be deficient or requires relocating due to other work, but otherwise determined to consist of panels in good condition, the guardrail may be reset. If the guardrail system is determined to be non-reusable, remove and replace with new guardrail. Refer to [Standard Specification 538](#) for additional information on reusable and non-reusable guardrail components.

When resetting existing guardrail, the guardrail will be reinstalled as **31" Guardrail** reusing existing guardrail panels and posts (steel only) as shown in the current [Standard Plans, Index 536-001](#). This resetting requires panels be reinstalled with the panel splices located at the midspan; therefore, consideration must be given to the effect this will have on the overall system length and if adjustments to the Begin/End Guardrail Station are needed.

Rigid-barrier approach transitions, approach end terminals and trailing anchorages must be replaced with new hardware, panels, and posts when resetting guardrail.

215.7.2 Existing Longitudinal Roadway Barriers

Existing longitudinal guardrail sections that do not conform to **31" Guardrail** must be upgraded or replaced, with the following exceptions:

- (1) **27" Guardrail** – Existing W-Beam guardrail installations installed to a 1'-9" mounting height (27" top height), meeting the requirements of the **2013 Design Standards** with regards to delineation, height, deflection distance, grading, mounting hardware, and consisting of crashworthy end treatments tested to at least **NCHRP 350**, is acceptable and allowed to remain in place.

- (2) **Thrie-Beam Guardrail** – Existing Thrie-Beam guardrail meeting the installation requirements of **2013 Design Standards**, and consisting of crashworthy end treatments tested to at least **NCHRP 350**, is acceptable and allowed to remain in place.
- (3) **Steel Blocks** – Existing **27" Guardrail** constructed with steel blocks, which is not being evaluated for upgrading according to the criteria above, may remain in place for projects with Design Speeds ≤ 45 mph.

Replacing or resetting existing **27" Guardrail** to meet the **31" Guardrail** mounting height requirement is at the discretion of the District. Typically, if 50% or more of an existing run of **27" Guardrail** is affected or if the existing installation is extended by 50% or more, the entire run should be replaced or reset with **31" Guardrail**. The required clear deflection distances for **31" Guardrail** are greater than the requirements for **27" Guardrail** and should be considered when resetting guardrail to the new height.

Modification for Non-Conventional Projects:

Delete the last paragraph and see RFP for requirements.

Existing concrete barriers conforming to the current [Standard Plans](#), **Index 521-001**, F-Shape, New Jersey shape barriers, and approved vertical faced concrete barriers may remain in place. Other concrete barrier shapes must be replaced.

Replacements and new installations must conform to the current [Standard Plans](#).

See **FDM 215.4.5.4** and [SDG, Section 2.6](#), for barrier requirements for Pier Protection.

215.7.3 Existing End Treatments & Crash Cushions

Evaluate concrete barrier end treatments to ensure adequate length of need is provided and meet crashworthiness requirements. Remove or replace end treatments and crash cushions which are found to be non-crashworthy or crash tested prior to **NCHRP 350** test criteria. Existing guardrail end treatments must be upgraded or replaced unless they conform to one of the systems identified on the [APL](#), the current [Standard Plans](#), or the **2013 Design Standards**.

Replacements and new installations must conform to the current [Standard Plans](#).

215.7.4 Existing Bridge Traffic Railing

Evaluate bridge traffic and pedestrian railings for conformance to current **FDM** criteria and **Standard Plans** whenever improvements are made to a bridge or its approach roadway. For non-compliant bridge railings:

- (1) Retrofit bridge railing to bring them up to current standards, or
- (2) Replace bridge railing, or
- (3) Process a Design Variation, provided that a subsequent project that will remedy this condition is scheduled within a reasonable time.

See **SDG** 6.7 for traffic railing requirements, and **SDG** 6.8 and the following for pedestrian railing requirements.

Remove existing fences that are not in compliance with **Standard Plans, Indexes 515-010** or **515-012**, and existing pedestrian railings that are mounted on existing traffic railings located between the shoulder and the sidewalk (a.k.a. "inboard" traffic railings). Replace or retrofit the existing pedestrian railing or fence rather than completely removing it if there is a documented issue of traffic incidents involving pedestrians (at the site before installation of the existing pedestrian railing or fence on the inboard traffic railing) that would likely reoccur if the existing installation were to be removed. Use **Standard Plans, Indexes 515-010** or **515-012**, or another crashworthy pedestrian railing or fence that is compatible with the traffic railing, as appropriate. Retrofit existing bullet-type railings that are to remain on inboard traffic railings and that do not have the bullet railing member(s) oriented towards the traffic side of the railing to match **Standard Plans, Index 515-021**.

Retrofit existing installations of **Standard Plans, Index 515-021**, and other similar bullet-type railings, to include rail splice assemblies and tapered end transitions as shown on **Standard Plans, Index 515-022** if they are not present. Retrofit the ends of other existing crashworthy traffic railing mounted pedestrian railings to include a similar tapered end transition, or other appropriate approach end transition, if one is not present.

215.7.5 Existing Guardrail to Bridge Railing Transitions

Existing guardrail to bridge traffic railing approach and trailing end transitions must be upgraded or replaced unless they conform to one of the following systems:

- (1) For approach ends of existing standard New Jersey Shape, F-Shape, and Single-Slope bridge traffic railings:

- (a) The nested Thrie-Beam approach transition shown as in the current [Standard Plans](#) or the **2013 Design Standards, Index 400**.
 - (b) For retrofitted installations, the appropriate nested Thrie-Beam transition shown in the current **Standard Plans** or the **2013 Design Standards, Index 402**.
 - (c) For a design speed ≤ 45 mph the nested w-beam approach transition shown as **Detail J** in the **1998 Roadway and Traffic Design Standards, Index 400**, Sheet 7 of 21. This detail is also shown in the **2000 Roadway and Traffic Design Standards, Index 401**, Sheet 1 of 9.
- (2) For approach ends of existing bridge traffic railing retrofits constructed in accordance with the **1987 through 2000 Roadway and Traffic Design Standards, Index 401, Schemes 1 and 19, "Concrete Safety Barrier"**:
- (a) The appropriate nested Thrie-Beam transition shown in **Standard Plans, Index 536-002**.
 - (b) For design speeds ≤ 45 mph the w-beam approach transition shown as **Detail J** in the **1987 Roadway and Traffic Design Standards, Index 400**, Sheet 9 of 13, upgraded as shown in the **2013 Design Standards, Index 403** by the installation of a nested section of W-beam guardrail, additional guardrail posts and offset blocks and a transition block if a curb is not present beyond the bridge end.
 - (c) For design speeds ≤ 45 mph the nested W-beam approach transition shown as **Detail J** in the **1998 Roadway and Traffic Design Standards** Sheet 7 of 21, upgraded as shown in the **2013 Design Standards, Index 403** by the installation of a transition block if a curb is not present beyond the bridge end.
- (3) For trailing ends of existing bridge traffic railing retrofits constructed in accordance with the **1987 through 2000 Roadway and Traffic Design Standards, Index 401, Schemes 1 and 19, "Concrete Safety Barrier"**:
- (a) In the absence of additional hazards on the trailing end, no end treatment is required.
 - (b) When additional hazards are present on the trailing end, a w-beam trailing end treatment as shown in [Standard Plans, Index 536-001](#).
- (4) For approach ends of existing structurally continuous Post and Beam bridge traffic railings that are not being retrofitted per **FDM 215.7.4**:
- (a) A custom designed nested Thrie-Beam approach transition based on the current [Standard Plans, Index 536-001](#).
 - (b) A nested Thrie-Beam approach transition based on the current [Standard Plans, Indexes 536-002, 521-404 or 521-405](#).

- (c) A custom designed nested Thrie-Beam approach transition based on the **1987 through 2000 Roadway and Traffic Design Standards, Index 401, Scheme 29.**
- (5) For trailing ends of existing structurally continuous Post and Beam bridge traffic railings that are not being retrofitted, per **FDM 215.7.4:**
 - (a) In the absence of additional hazards on the trailing end, no end treatment is required.
 - (b) When additional hazards are present on the trailing end, a w-beam trailing end treatment as shown in the current [Standard Plans, Index 536-001](#) or the **1987 through 2000 Roadway and Traffic Design Standards, Index 401.**
 - (c) When additional hazards are present on the trailing end, a custom designed nested Thrie-Beam approach transition based on any design listed in No. 4 above.

Guardrail replacements and new installations connecting to standard New Jersey Shape F-Shape, and Single-Slope bridge traffic railings must conform to the current [Standard Plans, Index 536-001](#). For guardrail retrofits connecting to existing bridge traffic railings, see the current [Standard Plans, Indexes 536-002 or 460-477](#) and their associated **Standard Plans Instructions.**

Guardrail replacements, retrofits and new installations connecting to structurally continuous post and beam bridge traffic railings must conform to **Design Standards, Indexes 404 or 405** and their **IDS**. See the **IDS** for details of structurally continuous post and beam traffic railings.

215.8 Non-Standard Roadside Safety Hardware

The [APL](#) includes proprietary devices and products that have been evaluated for compliance with FDOT [Standard Specifications](#) and the [Standard Plans](#). The majority of proprietary roadside safety hardware eligible for use on the State Highway System are identified on the [APL](#). However, the devices included on the [APL](#) may not cover every roadside safety application. Unique situations will sometimes require unique devices. Examples of available devices that are not covered by the [APL](#) include but are not limited to barrier wall gates, aesthetic guardrail, temporary steel barriers, and crashworthy stop gates. When the need arises for a unique crashworthy device not included on the [APL](#), carefully investigate the applicability of the device for the situation, as well as the crash performance characteristics of the device. For some of these devices, the State Roadway Design Office (RDO) may have information and be of assistance in establishing the appropriateness of the device for a given situation.

Provide the following documentation when requesting the approval of a device not included on the [APL](#):

- (1) FHWA, Federal-Aid Reimbursement Eligibility Letter
- (2) Crash Test Reports, including review of test results. Performance characteristics must be reviewed, including post impact vehicle behavior and post impact test article deflection, and debris scatter.
- (3) Compatibility with adjacent and/or connecting standard roadside safety devices.
- (4) Maintenance requirements and characteristics, including coordination with the District Maintenance Office.
- (5) For devices such as barrier gates, operational plans and training as appropriate.

The use of Non-Standard Roadside Safety Hardware must be approved by the State Roadway Design Office (RDO).

Project specific plan details, technical special provisions (TSP), and method of payment will be required and must be coordinated with the appropriate Department Offices.

Other barrier designs may be required by specific site conditions. Site specific conditions are identified and detailed in the plans.