

Chapter 8

Pedestrian, Bicycle and Public Transit Facilities

8.1	General	8-1
8.1.1	Pedestrians and Bicyclists.....	8-1
8.1.2	Transit.....	8-3
8.2	References.....	8-4
8.3	Pedestrian Facilities	8-5
8.3.1	Sidewalks.....	8-5
8.3.2	Accessibility Considerations	8-6
8.3.3	Crosswalks.....	8-7
8.3.3.1	Crosswalks at Intersections.....	8-8
8.3.3.2	Midblock Crosswalks.....	8-8
8.4	Bicycle Facilities.....	8-10
8.4.1	Bicycle Lanes	8-10
8.4.2	Bicycle Lane Between Through Lane and Right Turn Lane, Bus Bay or Parking Lane (Keyhole)	8-11
8.4.2.1	Keyhole Locations	8-11
8.4.2.2	Green Color Bicycle Lanes.....	8-12
8.4.3	Paved Shoulders.....	8-19
8.4.4	Wide Curb Lanes	8-19
8.4.5	Shared Lane Markings (Sharrows).....	8-19
8.4.6	Bicycle Route Systems.....	8-20
8.4.6.1	United States Bicycle Routes	8-20
8.5	Drainage and Utility Considerations	8-23
8.6	Shared Use Paths	8-23
8.6.1	Considerations	8-23

8.6.2	Widths	8-24
8.6.3	Cross Slopes	8-24
8.6.4	Grades	8-24
8.6.5	Horizontal Clearance	8-25
8.6.6	Vertical Clearance	8-25
8.6.7	Design Speed	8-25
8.6.8	Horizontal Alignment	8-26
	8.6.8.1 Minimum Radii	8-26
	8.6.8.2 Stopping Sight Distance	8-27
8.6.9	Vertical Alignment	8-28
8.6.10	Separation between Shared Use Path and Roadway	8-28
8.6.11	Path Railings	8-28
8.6.12	Lighting	8-28
8.6.13	Signing, Pavement Marking, and Signalization	8-28
8.7	Bridges, Overpasses, and Underpasses	8-29
8.7.1	Design Criteria	8-29
8.7.2	Prefabricated Steel Truss Bridges on FDOT Projects	8-32
	8.7.2.1 Qualification of Prefabricated Steel Truss Pedestrian Bridge Producers	8-33
	8.7.2.2 Design and Detailing Responsibilities	8-33
	8.7.2.3 Plans Development	8-34
8.8	Drop-off Hazards for Pedestrians and Bicyclists	8-39
8.9	Strategic Intermodal System Highway Component Standards and Criteria	8-42
8.10	Public Transit Facilities	8-43
	8.10.1 Curb-Side Facilities	8-43
	8.10.2 Street-Side Facilities	8-46

Tables

Table 8.1.1	Bicycle Facilities	8-2
Table 8.4.1	U. S. Bicycle Route Criteria	8-22
Table 8.6.1	Maximum Grade Lengths	8-25
Table 8.6.2	Minimum Radii for Shared Use Paths.....	8-26
Table 8.6.3	Minimum Stopping Sight Distances	8-27

Figures

Figure 8.4.1	Bike Lane with Separate Right Turn Lane	8-14
Figure 8.4.2	Bike Lane with Right Turn Drop Lane.....	8-15
Figure 8.4.3	Bike Lane with Channelized Right Turn Lane.....	8-16
Figure 8.4.4	Bike Lane with Free Flow Channelized Right Turn Lane.....	8-17
Figure 8.4.5	Bike Lane with Bus Bay.....	8-18
Figure 8.7.1	Pedestrian/Shared Use Path Bridge Typical Section	8-31
Figure 8.7.2	Prefabricated Pedestrian Bridge Standard Truss Configurations	8-37
Figure 8.7.3	Prefabricated Pedestrian Bridge Standard Truss Member Shapes	8-37
Figure 8.7.4	Prefabricated Pedestrian Standard Bridge Cross-Sections.....	8-38
Figure 8.8.1	Drop-Off Hazards for Pedestrians and Bicyclists	8-41
Figure 8.10.1	Accessible Boarding and Alighting Area for Flush Shoulder Roadways with Connection to Roadway ...	8-44
Figure 8.10.2	Accessible Boarding and Alighting Area for Flush Shoulder Roadways with Connection to Sidewalk	8-45

Figure 8.10.3 Bus Stop and Bus Bay Categories8-47

Exhibits

EXHIBIT 8-A Steel Truss Pedestrian Bridge Plans8-48

Chapter 8

Pedestrian, Bicycle and Public Transit Facilities

8.1 General

8.1.1 Pedestrians and Bicyclists

It is the goal of the Department and in accordance with **Section 335.065, Florida Statutes, Bicycle and pedestrian ways along state roads and transportation facilities:**

- “(1)(a) Bicycle and pedestrian ways shall be given full consideration in the planning and development of transportation facilities, including the incorporation of such ways into state, regional, and local transportation plans and programs. Bicycle and pedestrian ways shall be established in conjunction with the construction, reconstruction, or other change of any state transportation facility, and special emphasis shall be given to projects in or within 1 mile of an urban area.
- (b) Notwithstanding the provisions of paragraph (a), bicycle and pedestrian ways are not required to be established:
1. Where their establishment would be contrary to public safety;
 2. When the cost would be excessively disproportionate to the need or probable use;
 3. Where other available means or factors indicate an absence of need.”

Projects that comply with the design criteria contained within the PPM are considered to meet the requirements of the statute. If the design criteria contained within the PPM for pedestrian and bicycle facilities are not met, a Design Variation is required. The documentation shall reference which of the three conditions under **Section 335.065 (1)(b), Florida Statutes** support not providing a bicycle or pedestrian facility.

Sidewalks and shared use paths are appropriate pedestrian facilities for all types of projects and locations. Beyond one mile of an urban area where only occasional pedestrian traffic is expected, a shoulder (paved and unpaved) would meet the need for a pedestrian way. **Table 8.1.1** identifies appropriate bicycle facilities for various types of projects. The [Urban Area 1-Mile Buffer Maps](#) are posted in conjunction with the PPM.

Table 8.1.1 Bicycle Facilities

Location	Condition	Type of Work		
		New Construction, Reconstruction	Resurfacing, Restoration, Rehabilitation (RRR) ^{1, 2, 3}	Traffic Operations, Intersection Improvements
In or within one mile of an urban area	All	Bicycle Lane	Bicycle Lane or Wide Curb Lane	Bicycle Lane or Wide Curb Lane
Beyond one mile of an urban area	Curb and Gutter	Bicycle Lane	Bicycle Lane or Wide Curb Lane	Bicycle Lane or Wide Curb Lane
	Flush Shoulder	Bicycle Lane or Paved Shoulder	Bicycle Lane or Paved Shoulder	Bicycle Lane or Paved Shoulder
<p>1. Widening of existing curbed sections for the project length to provide bicycle facilities may disproportionately affect the scope and cost of a RRR project, especially if reconstruction of the curb, sidewalk, and/or drainage system is required, additional right of way is needed, or utilities are impacted. No Design Variation is necessary, however, a statement similar to the following shall be included in the project file:</p> <p style="padding-left: 40px;">“Bicycle facilities have been considered for this project but will not be provided, due to insufficient width between existing curb lines to provide bicycle facilities without substantial reconstruction of the roadway, drainage system and sidewalk (and/or requires additional right of way). Reconstruction (and/or right of way acquisition) is outside the scope of this project.”</p> <p>2. Substantial widening of an existing curbed section is outside the scope of a RRR project and is considered reconstruction.</p> <p>3. See Section 25.4.19 for options that shall be considered on RRR projects with existing roadways where no widening is planned.</p>				

Bicyclists and pedestrians should be expected on all of Florida's state roadways except where restricted on limited access facilities and interstate highways (**Section 316.091 Florida Statutes**).

Decisions on appropriate pedestrian and bicycle facilities shall be determined with input from the District Pedestrian/Bicycle Coordinator, throughout the project development and implementation process. Further coordination may also be necessary with the District Americans with Disabilities Act (ADA) Coordinator.

When considering other available means, the alternate route or facility should include accommodation for cyclists and pedestrians which meet the design criteria for bicycle and pedestrian facilities on state roadways, and provide access to the same services, origination and destination sites, and transit connections as the project corridor. The alternate route shall not result in a significant increase in travel time or trip length, exposure to motorized traffic or substantial elevation changes. If the alternate route requires the pedestrian or bicyclist to cross limited access, arterial or collector roadways, or rail corridors, appropriate crossing locations shall be provided.

8.1.2 Transit

For projects within the operational limits of a local transit agency service area, connectivity of pedestrian and bicycle facilities with transit stops is required.

Where transit service is provided or planned to be established, the designer shall coordinate with the District Pedestrian and Bicycle Coordinator, District Modal Development Office Coordinator, District Americans with Disabilities Act (ADA) Coordinator, District Public Transportation staff and the local public transit provider(s) so that access to transit services by pedestrians and bicyclists is provided. Coordination will be required to determine the optimum location of boarding and alighting areas, transit shelters and bus bays.

Modification for Non-Conventional Projects:

Delete **PPM** 8.1.2 and see the RFP for requirements.

8.2 References

1. [*FDOT Design Standards*](#)
2. [*FDOT Structures Manual, Current Edition*](#)
3. [*FDOT Traffic Engineering Manual*](#)
4. [*FDOT Manual on Uniform Traffic Studies \(MUTS\)*](#)
5. [*Accessing Transit, Design Handbook for Florida Bus Passenger Facilities, Version 2, 2008*](#)
6. [*Manual on Uniform Traffic Control Devices \(MUTCD\)*](#)
7. [*Shared Use Path Level of Service Calculator, A User's Guide \(FHWA\)*](#)
8. [*NCHRP Report 672 Roundabouts: An Informational Guide, Second Edition*](#)
9. [*AASHTO Guide for the Development of Bicycle Facilities*](#)
10. [*AASHTO Guide for the Planning, Design, and Operation of Pedestrian Facilities*](#)
11. [*Highway Capacity Manual 2010*](#)
12. [*AASHTO LRFD Bridge Design Specifications, Current Edition*](#)
13. ***Transportation Research Board (TRB) Guidelines for the Location and Design of Bus Stops adapted from TCRP Report 19. Washington D.C.: National Academy Press***

8.3 Pedestrian Facilities

All roadways and bridges in or within one mile of the urban area where pedestrian travel is allowed shall have separate walking areas such as sidewalks or shared use paths. Refer to **Section 8.6** for shared use paths.

8.3.1 Sidewalks

Sidewalks are walkways parallel to the roadway and designed for use by pedestrians. Sidewalks should be provided along both sides of roadways that are in or within one mile of an urban area. If sidewalks are constructed on the approaches to bridges, they should be continued across the structure. If continuous sidewalks are constructed on only one side of the street, pedestrians should be provided access to facilities and services located on the opposite side of the street.

Modification for Non-Conventional Projects:

Delete the second sentence of the above paragraph and see RFP for additional requirements.

The minimum width of a sidewalk shall be 5 feet on both curb and gutter and flush shoulder roadways. The minimum separation for a 5-foot sidewalk from the back of curb is 2 feet. If the sidewalk is located adjacent to the curb, the minimum width of sidewalk is 6 feet.

Grades on sidewalks shall not exceed 5% when not adjacent to a travel way unless accessible ramps are provided. There should be enough sidewalk cross slope to allow for adequate drainage, however the maximum shall be no more than 2% to comply with ADA requirements. A clear 1-foot wide graded area with a maximum 1:6 slope should be provided adjacent to the sidewalk. Edge drop-offs should be avoided. When drop-offs cannot be avoided, they should be shielded as discussed in **Section 8.8**.

A 5-foot wide (minimum) sidewalk that connects a transit stop or facility with an existing sidewalk or shared use path shall be included to comply with ADA accessibility standards.

Particular attention shall be given to pedestrian accommodations at the termini of each project. If full accommodations cannot be provided due to the limited scope or an existing sidewalk is not present at the termini, the designer shall extend the sidewalk to the next

appropriate pedestrian crossing or access point. If pedestrian facilities are provided, they shall be connected with facilities on the adjoining projects. In all cases, the District Pedestrian/Bicycle Coordinator shall be contacted for input on making a determination regarding continuous passage.

New sidewalks shall be placed as far from the roadway as practical in the following sequence of desirability:

1. As near the right of way line as possible.
2. Outside of the clear zone.
3. Five feet from the shoulder point on flush shoulder roadways.
4. At the shoulder point.

Sidewalks shall not be constructed contiguous to the roadway pavement. Nearing intersections, the sidewalk should be transitioned as necessary to provide a more functional crossing location that also meets driver expectation. Further guidance on the placement of stop or yield lines and crosswalks is provided in the [MUTCD, Part 3](#) and the *Design Standards, Indexes 17344* and *17346*.

8.3.2 Accessibility Considerations

Sidewalks and shared use paths must be designed in accordance with ADA. Refer to the *Design Standards* for additional details.

Pull boxes, manholes (and other utility covers), and other types of existing surface features in the location of a proposed curb ramp or detectable warning should be relocated when feasible. When relocation is not feasible, the feature shall be adjusted to meet the ADA requirements for surfaces (including the provision of a nonslip top surface, and adjustment to be flush with and at the same slope as the adjacent surface).

The detectable warning systems on the QPL are designed to work with concrete surfaces. In areas where the pedestrian facility has an asphalt surface, such as a shared use path, the engineer must specify an appropriate detectable warning system. In these cases, consider including a short section of concrete that will accommodate any system.

To assist pedestrians who are visually or mobility impaired, curb ramps should be parallel to the crossing. By providing ramps parallel to the crossing, the pedestrian is directed into the crossing. At intersections where more than one road is crossed, each crossing

should have a separate curb ramp. Under no circumstance shall a curb ramp be installed allowing a pedestrian or bicyclist to enter a crossing without providing a curb cut (or at grade sidewalk if no curb is present) on the opposite side of the crossing. Crossings shall also meet the same grade and cross slope requirements as sidewalks where the grade should not exceed 5%, and the maximum cross slope shall be no more than 2%.

Project design shall include an evaluation of existing driveways to determine if it is feasible to upgrade nonconforming driveway turnouts to meet the criteria in ***Design Standards, Indexes 304, 310 and 515***. Nonconforming driveways are not required to be upgraded if it is not feasible within the scope of the project.

8.3.3 Crosswalks

Crosswalks occur at all intersections, whether or not they are marked and on any portion of a roadway distinctly indicated for pedestrian crossing by lines or other markings on the surface. Crossings should be convenient and minimize the pedestrian's exposure in the roadway. Crosswalks are defined in ***Florida Statutes 316.003(6)***.

There are a number of treatments that may be used to help pedestrians safely across the street, whether crossing at an intersection or midblock. A marked crosswalk is one of these tools. Marking of crosswalks helps drivers better identify the intersection, guides the pedestrian to the best crossing location and provides guidance for people with low vision.

The criteria provided in this section do not apply to school crossings.

Additional guidance on marked crosswalks can be found in the [***AASHTO Guide for the Planning, Design, and Operation of Pedestrian Facilities***](#) and [***FHWA's Safety Effects of Marked vs. Unmarked Crosswalks at Uncontrolled Locations: Executive Summary and Recommended Guidelines***](#).

8.3.3.1 Crosswalks at Intersections

Marked crosswalks shall be provided at all side streets where a pedestrian facility meets the roadway. As roadway volumes, speeds and number of travel lanes increase, marked crosswalks are best used in conjunction with other treatments (including signals, signs, beacons, curb extensions, raised medians, refuge islands, and enhanced overhead lighting).

When separated right turn lanes are used, place crosswalks so that an approaching motorist has a clear view of the pedestrian, and the crossing distance is minimized.

New marked crosswalks at uncontrolled intersection locations (without signals, stop or yield signs) shall be coordinated with the District Traffic Operations Office. Marked crosswalks on an uncontrolled leg of an intersection shall be supplemented with other treatments (which may include beacons, curb extensions, raised medians, raised traffic islands, or enhanced overhead lighting) when any of the following conditions exist:

1. Where posted speeds are greater than 40 mph.
2. On a roadway with 4 or more lanes without a raised median or raised traffic island that has an ADT of 12,000 or greater.
3. On a roadway with 4 or more lanes with a raised median or raised traffic island that has or is projected to have (within 5 years) an ADT of 15,000 or greater.

Roundabouts present a unique challenge for the design of pedestrian crossings. In a roundabout, the crosswalk markings should comply with the *MUTCD, Part 3*, [*NCHRP Report 672 Roundabouts: An Informational Guide, Second Edition*](#) and the *FDOT Traffic Engineering Manual*.

8.3.3.2 Midblock Crosswalks

Midblock crosswalks can be used to supplement the pedestrian crossing needs in an area between intersections. This can provide pedestrians with a more direct route to their destination. Midblock crosswalks should be illuminated, marked and signed in accordance with the *MUTCD, Traffic Engineering Manual, (Section 3.8)* and *Design Standards, Index 17346*. Pedestrian-activated, signalized midblock crosswalks may be appropriate at some locations, but the locations must meet the warrants established in the *MUTCD*.

In addition to the requirements in **Section 8.3.3.1**, the following conditions also apply:

1. Midblock crosswalks should not be located where the spacing between adjacent intersections is less than 660 feet
2. Midblock crosswalks should not be located where the distance from the crosswalk to the nearest intersection (or crossing location) is less than 300 feet
3. Midblock crosswalks shall not be provided where the crossing distance exceeds 60 feet (unless a median or a crossing island is provided)
4. Midblock crosswalks shall not be provided where the sight distance for both the pedestrian and motorist is not adequate (stopping sight distance per **Table 2.7.1**)
5. Midblock crosswalks shall not be located where the ADA cross slope and grade criteria along the crosswalk cannot be met (per **Section 8.3.2**).

An engineering study is required before a marked midblock crosswalk is installed at an uncontrolled location. This study shall examine such factors as sight distance for pedestrians and vehicles (stopping sight distance), traffic volume, turning volumes near proposed crosswalk location, roadway width, presence of a median, lighting, landscaping, drainage, traffic speed, adjacent land use (pedestrian generators / destinations), pedestrian volume and existing crossing patterns. Midblock crosswalks should only be used in areas where the need truly exists, and the engineering study will help to determine if an uncontrolled midblock crosswalk is a viable option. Refer to the Department's [Manual on Uniform Traffic Studies \(MUTS\)](#).

If any problem areas are identified that would preclude the placement of a justified midblock crosswalk, additional features must be included in the design to remedy those problem areas before a midblock crosswalk can be placed at that location. Features like overhead signing can help alert motorists and be used to light the crossing. Curb extensions or bulb-outs can improve sight distance and decrease the crossing distance. Adjustment of the profile on the roadway crossing may be required to improve the cross slope of the crosswalk.

8.4 Bicycle Facilities

Appropriately designed and located bicycle facilities play an important role in supporting safe bicycle travel. Bicycle facilities include bicycle lanes, paved shoulders, wide curb lanes, shared use paths, traffic control devices, and bicycle parking facilities.

Measures that can considerably enhance a corridor's safety and capacity for bicycle travel are:

1. Providing bicycle facilities.
2. Maintaining a smooth, clean riding surface, free of obstructions. This includes ensuring drainage inlets and utility covers that cannot be moved out of the travel way are flush with grade, well seated, and use bicycle-compatible inlets, grates and covers.
3. Responsive and appropriate traffic control devices, consistent with guidance in the *MUTCD*, including providing bicycle oriented directional signage.

8.4.1 Bicycle Lanes

Where required by **Table 8.1.1**, a bicycle lane shall be provided for each direction of travel on the roadway. On flush shoulder roadways, the paved shoulder described in **Section 8.4.3** shall be marked as a bicycle lane in or within 1 mile of an urban area. Bicycle lanes shall be marked in accordance with **Design Standards, Index 17347** and the *MUTCD*. Shared use paths do not meet the requirement for bicycle lanes.

On curb and gutter roadways, a 4-foot minimum bicycle lane width measured from the lip of the gutter is required. The width from the lip of gutter to the face of curb or barrier, although not considered to be part of the rideable surface area, provides useable clearance to the curb face. When a guardrail or other barrier exists and the roadway pavement is continuous to the face of the barrier, a 5-foot minimum bike lane is required. When the bike lane is adjacent to a right-turn lane, bus bay, or parking lane refer to **Section 8.4.2** of this chapter. On high speed urban and suburban arterial highways with design speeds of 50 mph or more and curb and gutter on the outside, a 6.5-foot bicycle lane adjacent to the curb and gutter is required. See **Volume 1, Section 2.16** for further information.

Bicycle lanes shall be one-way facilities and carry bicycle traffic in the same direction as adjacent motor vehicle traffic. On one-way streets, bicycle lanes should generally be placed on the right side of the street. A bicycle lane on the left side of the street can be

considered if it will substantially reduce the number of potential conflicts, such as those caused by frequent bus traffic, heavy right-turn movements, high-turnover parking lanes, or if there is a significant number of left-turning bicyclists.

8.4.2 Bicycle Lane Between Through Lane and Right Turn Lane, Bus Bay or Parking Lane (Keyhole)

8.4.2.1 Keyhole Locations

In new construction, reconstruction and traffic operations projects, at locations with right turn lanes, bus bays or parking lanes, a 5-foot bicycle lane shall be provided between the through lane and the right turn lane, bus bay or parking lane. For bicycle lanes adjacent to parking lanes, if the parking volume is substantial or the turnover is high, an additional 1 to 2 feet of width should be provided for the bicycle lane if right of way is adequate.

When a RRR project includes the addition or modification of a right turn lane, bus bay or parking lane, a 5-foot bicycle lane shall be provided between the through lane and the right turn lane, bus bay or parking lane, if existing right of way is adequate. On RRR flush shoulder projects where the approaching paved shoulder is 4 feet wide, a minimum width of 4 feet is acceptable for a bicycle lane between the through lane and right turn lane.

When a RRR project has an existing right turn lane without a bicycle lane between the through lane and right turn lane, bus bay or parking lane, a bicycle lane should be provided. Factors to be considered include the opportunity to provide a continuous alignment, reduce the potential for conflicts with turning vehicles, and availability of right of way.

8.4.2.2 Green Color Bicycle Lanes

The Federal Highway Administration (FHWA) has issued an Interim Approval for the use of green colored pavement in marked bicycle lanes and in extensions of bicycle lanes through intersections and other traffic conflict areas. In accordance with the conditions of the interim approval, FDOT has requested and received permission from FHWA for locations on the State Highway System. The Interim Approval may be found at the following website:

http://mutcd.fhwa.dot.gov/res-interim_approvals.htm

The effectiveness of green colored pavement may be maximized if the treatment is used only where the path of bicyclists crosses the path of other road users and where road users should yield to bicyclists. Because colored pavements are addressed in the [2009 MUTCD](#), they are by definition a traffic control device whose need must be demonstrated before they are used. The following requirements apply to projects on the State Highway System.

Green color in a bicycle lane will be permitted on the State Highway System when both of the following conditions exist:

1. A traffic conflict area (“keyhole”) exists at one of the following locations:
 - a. The bike lane crosses a right turn lane,
 - b. Traffic in a channelized right turn lane crosses a bike lane, or
 - c. The bike lane is adjacent to a dedicated bus bay.
2. A need for this treatment is demonstrated by either of the following:
 - a. A history of 3 or more motor vehicle-bicycle crashes exists at or adjacent to the traffic conflict area over the most recent three-year period, or
 - b. A government agency has observed and documented conflicts (failure of the motor vehicle to yield to the bicyclist) between cyclists and motor vehicles at an average rate of two per peak hour. The documentation for conflicts shall include observations from a minimum of two separate data collection periods, conducted on different days in a one month period, and include at least one weekday and one weekend count period during peak bicycle travel times. Each period should be at least 2 hours in duration. Peak times vary by region and surrounding land use, but are typically:

Weekday, 11:00 AM to 1:00 PM
Weekday, 5:00 PM to 7:00 PM
Saturday, 8:00 AM to 2:00 PM

Colored pavements shall not replace or be used in lieu of required markings for bike lanes as defined in this **Chapter** and the **MUTCD**, but shall only supplement such markings. When used in conjunction with white skip lines, such as when extending a bike lane across a right turn lane or access to a bus bay, the transverse colored marking shall match the 2'-4' white skip line pattern of the bike lane extension. The green colored pavement shall begin as a solid pattern 50 feet in advance of the skip striping, match the 2' 4' skip through the conflict area, and then resume the solid color for 50' after the conflict area, unless such an extent is interrupted by a stop bar, an intersection curb radius or bike lane marking. Details of each installation and associated pavement markings shall be shown in the plans. **Figures 8.4.1 – 8.4.5** illustrate how the green portion of the bike lane may be marked. See **FDOT's Design Standards, Indexes 17346** and **17347** for details on pavement markings.

Materials permitted to color the bike lane green shall be non-reflective, meet [FDOT Specification 523, Patterned Pavement](#), and fall within the color parameters defined by FHWA in their interim approval. During the first three years of the installation, the District shall review annually the crash reports in the conflict area to assess if the colored pavement is improving the safety of the bike lane. These assessments shall be reported to the State Roadway Design Engineer.

Approval for site specific installations of green colored bicycle lanes must be signed by the District Design Engineer, and a copy provided to the State Roadway Design Engineer. The addition of green colored pavement to bicycle lanes does not require a local agency maintenance agreement. FDOT may fund the assessment of need, but shall be responsible for the design, construction and maintenance of the green colored pavement if its need has been demonstrated in accordance with the requirements above.

Modification for Non-Conventional Projects:

Delete the last sentence in the above paragraph and see RFP for requirements.

Figure 8.4.1 Bike Lane with Separate Right Turn Lane

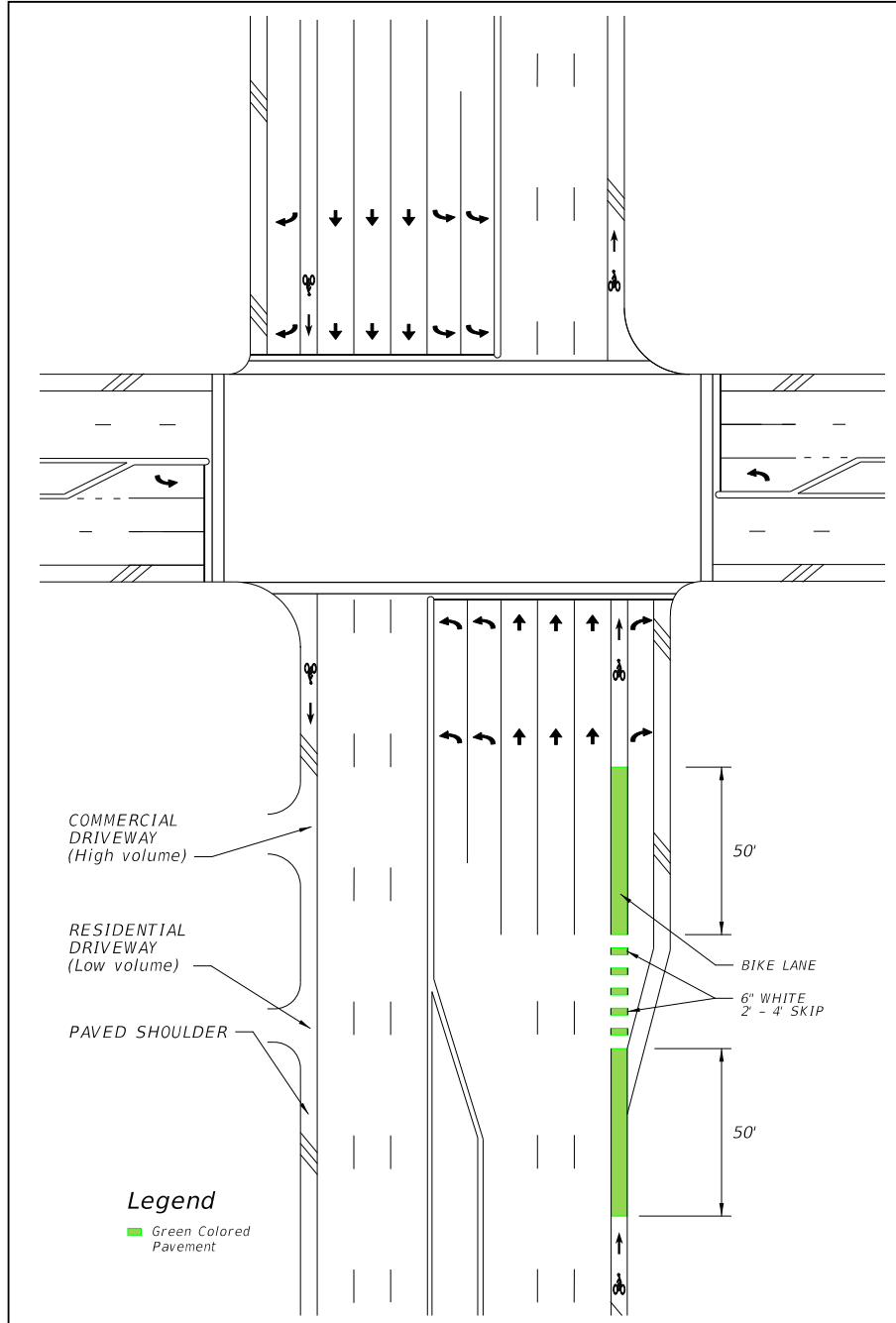

Figure 8.4.2 Bike Lane with Right Turn Drop Lane

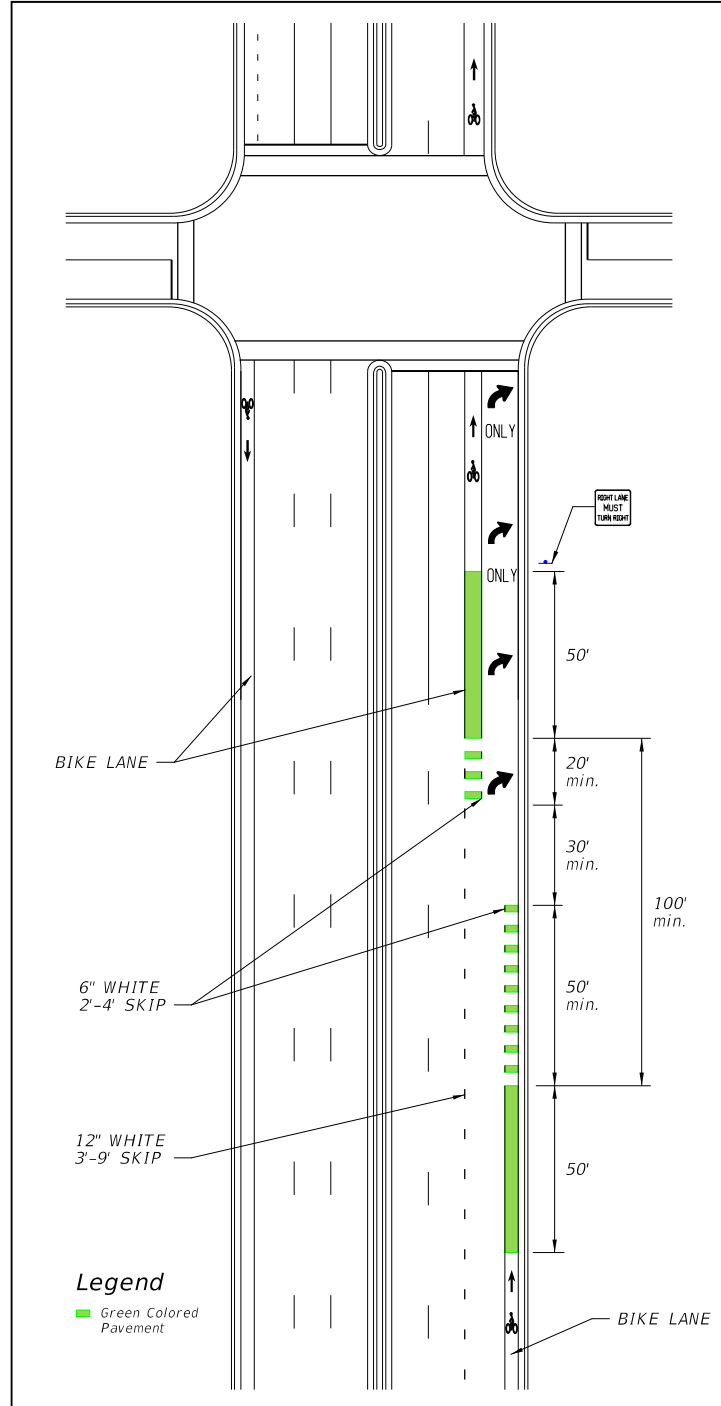

Figure 8.4.3 Bike Lane with Channelized Right Turn Lane

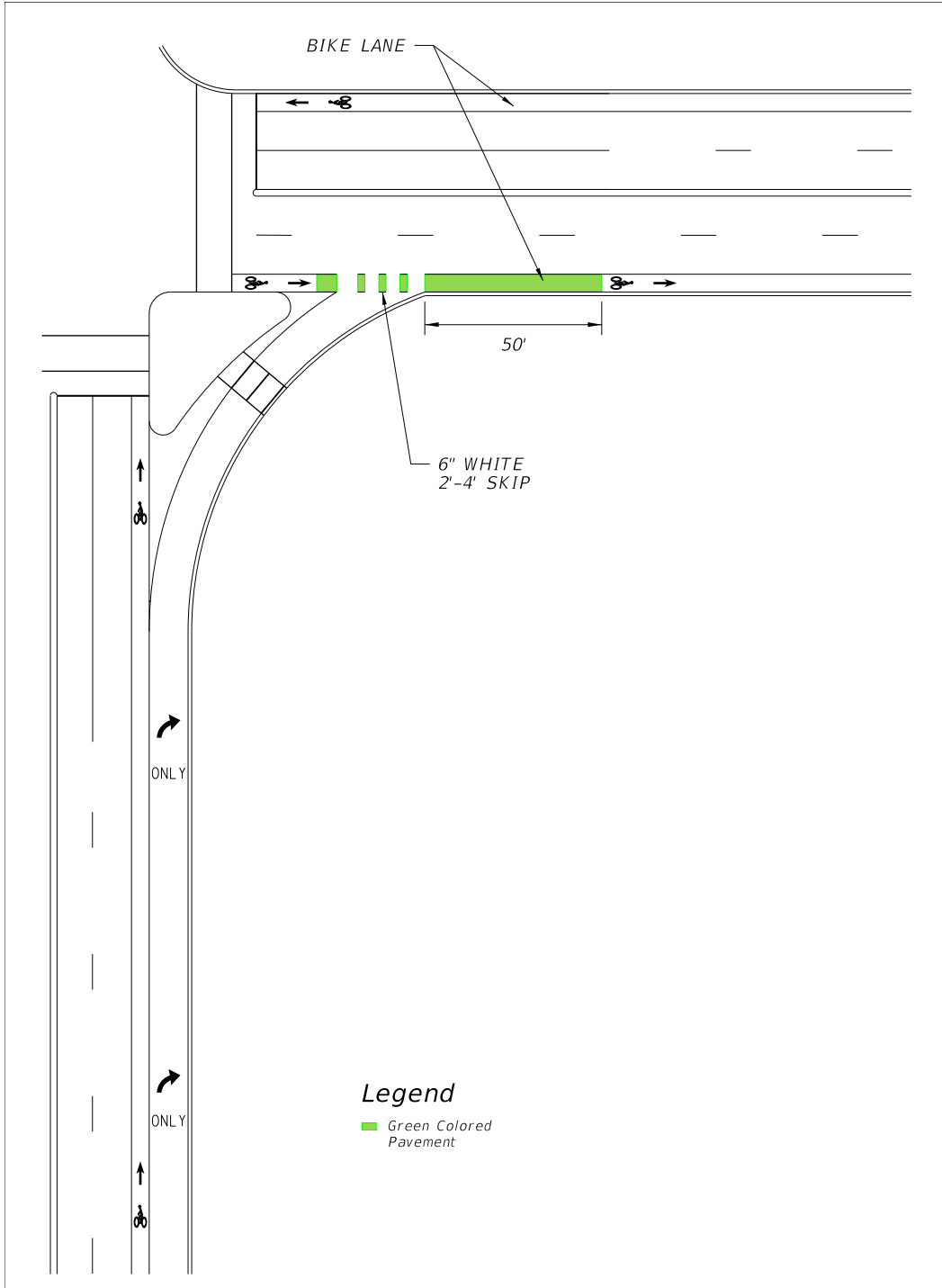

Figure 8.4.4 Bike Lane with Free Flow Channelized Right Turn Lane

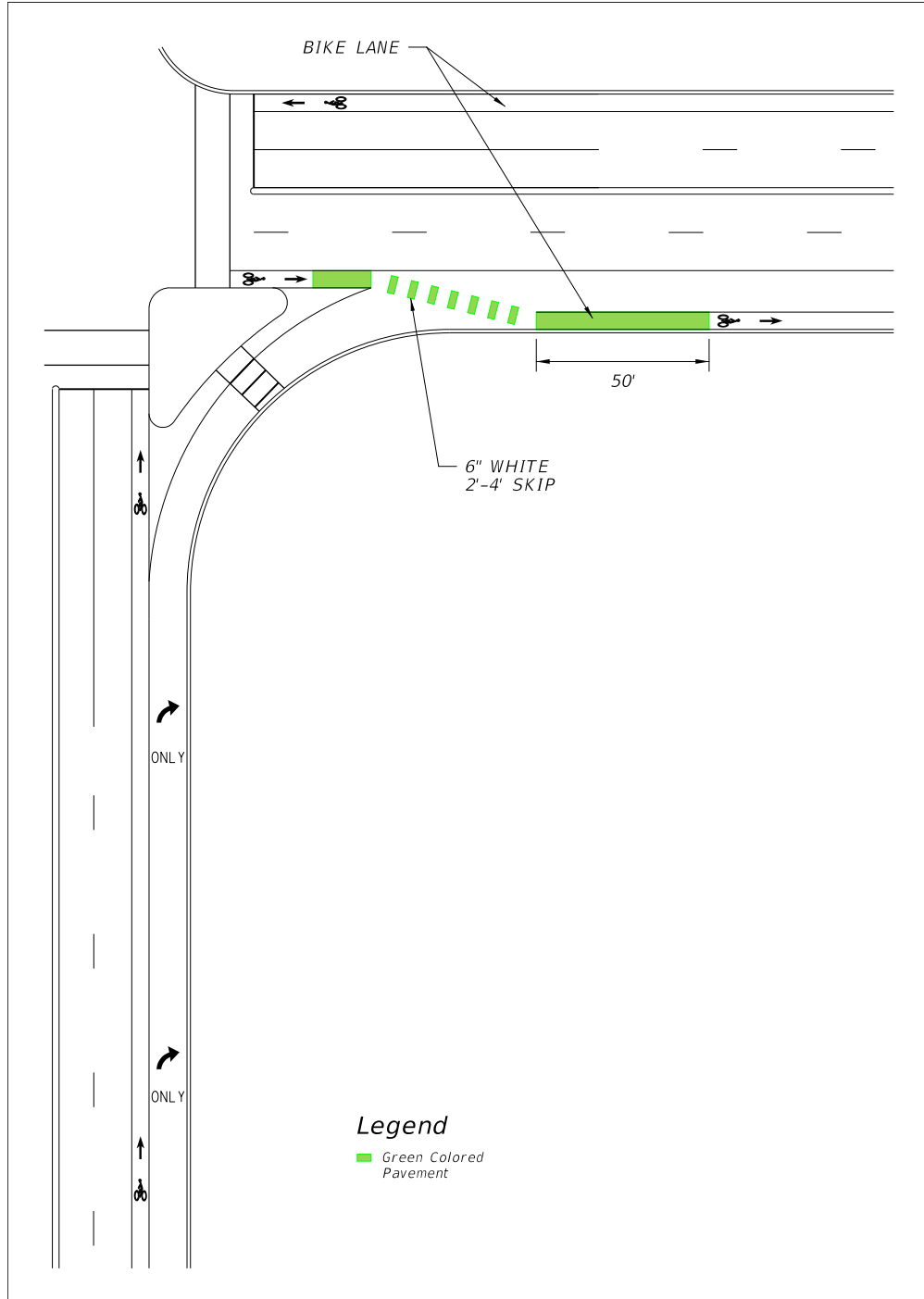
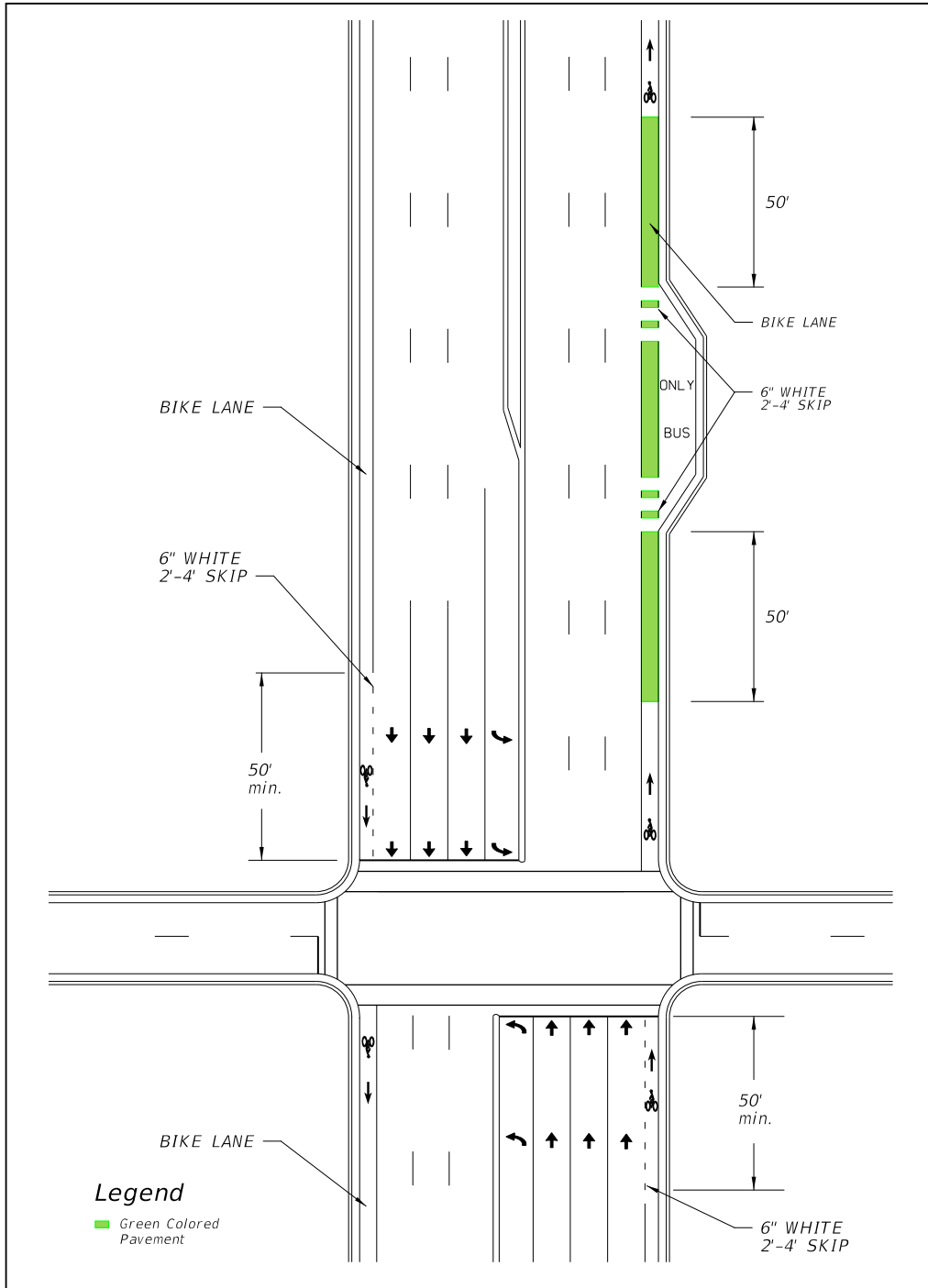

Figure 8.4.5 Bike Lane with Bus Bay



8.4.3 Paved Shoulders

A paved shoulder is a portion of a roadway which has been delineated by edge line striping, and may include bicycle lane pavement markings or signing. In or within 1 mile of an urban area, the paved shoulder shall be marked as a bicycle lane. Paved shoulders shall be 5 feet in width for new construction, reconstruction and RRR projects; however existing 4-foot paved shoulders on RRR projects may be retained. A paved shoulder of at least 4 feet in width is considered to be a bicycle facility; however a minimum 5-foot clear width between the traveled way and the face of curb, guardrail or other roadside barrier is required.

8.4.4 Wide Curb Lanes

Wide curb lanes are through lanes which provide a minimum of 14 feet in width. This width allows most motor vehicles to pass cyclists within the travel lane, which is not possible in more typical 10-foot to 12-foot wide travel lanes. Wide curb lanes do not meet Department requirements for bicycle facilities on new construction or reconstruction projects. However, in some conditions, such as RRR projects, they may be the only practical option for a bicycle facility.

8.4.5 Shared Lane Markings (Sharrows)

The shared lane marking is an optional pavement marking for shared lane roadways. It may be used to assist bicyclists on a roadway open to bicycle travel where no bicycle lane or paved shoulder exists or is feasible. Shared lane markings should be limited to roadways with a posted speed of 35 mph or less. They are not intended to be placed on every roadway without bicycle facilities or on shared use paths. Shared lane markings provide guidance to cyclists in their lateral positioning, especially on roadways with on-street parking or lanes that are too narrow to share side by side with a motor vehicle. They also help to discourage wrong way riding and encourage safer passing of bicyclists by motorists. Shared lane markings may be used to identify an alternate route as part of an approved temporary traffic control plan.

Modification for Non-Conventional Projects:

Delete the third sentence of the above paragraph and replace with the following:

Shared lane markings shall be limited to roadways with a posted speed of 35 mph or less.

Following are conditions where shared lane markings should be considered on the State Highway System:

- In conjunction with on-street parking
- Where forward sight distance is limited due to horizontal or vertical curvature
- Where gaps exist between bicycle facilities or between an existing bicycle facility and an urban center, school, park, or transit hub
- When the roadway has an average bicycle crash history of 3 or more per mile, over a 3 year period

The installation of shared lane markings shall be in accordance with ***Design Standards, Index 17347*** and the ***MUTCD***.

8.4.6 Bicycle Route Systems

Bicycle routes include roadways or shared use paths designated through signage, pavement markings or mapping. They provide directional and distance information, and aid bicyclists in wayfinding, especially in complex urban locations or along established long distance bicycle routes. Bicycle routes shall not end at a barrier. Information directing bicyclists around temporary interruptions in a route shall be consistent with the ***MUTCD, Part 9***.

The decision whether to provide bicycle route systems should be based on the suitability of the particular roadway or shared use path for bicycle travel and the need for wayfinding information. Evaluations of suitability should include roadway width, volume, speed, and types of traffic, parking conditions, grade, sight distance, and connectivity to services, significant destinations, and local transit or regional transportation hubs. Other considerations include location and condition of drainage grates, railroad crossings, pavement surface, signals responsive to bicycles, and maintenance schedules. Further guidance on signing bicycle route systems is provided in the ***MUTCD, Part 9***.

8.4.6.1 United States Bicycle Routes

The U.S. Bicycle Route System is a network of bicycle routes that span multiple states and are of national or regional significance. These routes are nominated for national designation by State Departments of Transportation (DOTs), and designated and catalogued by the [***American Association of State Highway and Transportation Officials \(AASHTO\)***](#).

Florida has adopted a policy entitled [**U.S. Numbered Bicycle Routes, Topic No. 000-525-060-a**](#) in support of the national route system.

Table 8.4.1 identifies criteria to use when selecting a route within a USBR corridor. These criteria provide an objective process for evaluating route options, but should be followed by a subjective review of the highest scored candidates to establish the final route. Reflecting on the specific purpose of the corridor can help to narrow final route selection. Route options are scored on a scale from 3 = Fulfills selection criteria to 0 = Does not contribute to meeting selection criteria. NA may be used when the criteria does not apply.

Table 8.4.1 U. S. Bicycle Route Criteria

Macro Criteria	3	2	1	0	NA
Within USBR corridor, with an emphasis on intrinsic scenic and cultural qualities of the corridor itself.					
Provides access to scenic, cultural, historical and recreational destinations. (May not be directly on route but are nearby.)					
Links major metropolitan areas to connect cyclists to transportation hubs or major attractions.					
Provides reasonably direct route in connecting cities or attractions along the corridor.					
Supports natural connections between adjoining states, Canada, or Mexico.					
Includes or intersects major existing and planned bicycle routes (interstate, cross-state, or intrastate) that are suitable for travel by touring bicycles.					
Micro Criteria	3	2	1	0	NA
Meets established state or local design criteria for on-road facilities and shared use paths. (Low volume or low speed roads without specific accommodation can be appropriate. High traffic roads may be necessary as short links.)					
Utilizes already established and successful routes or paths when possible.					
Easy to follow with limited turns; is well marked or has easily identified permanent landmarks to enable navigation.					
Connects to at least one neighboring state's USBR or another country's suitable roadway, bicycle route, or trail system.					
Provides access to services and amenities. Daily needs include food, water and overnight accommodations (including camping) at appropriate intervals (40-60 miles). Amenities and services not required daily include restaurants, libraries, and bicycle shops.					
Ferry or shuttle crossings of water bodies or other barriers have regularly scheduled service available to cyclists. An alternate route should be identified for when ferries or shuttles are out of service (seasonal) or when scheduled service is infrequent.					
Considers difficulty of the region's topography, avoiding extreme climbs. Topography considerations should be balanced against scenic values, points of interest, access to services, and route directness.					
Total					

8.5 Drainage and Utility Considerations

Drainage inlets, grates and utility covers are potential problems for bicyclists. When a new roadway is designed, all such grates and covers should be kept out of the bicyclists' expected path. For RRR projects refer to **Chapter 25.4.19.2** of this volume. Refer to **Figure 3-11, Curb Inlet and Gutter Inlet Application Guidelines**, and **Figure 3-12, Ditch Bottom and Median Inlet Application Guidelines**, of the [Storm Drain Handbook](#), and **Design Standards** for further information in selecting appropriate grates and inlet tops.

See **Chapter 2** of this volume for horizontal clearances for light poles.

8.6 Shared Use Paths

Shared use paths are paved facilities physically separated from motorized vehicular traffic by an open space or barrier and either within the highway right of way or an independent right of way. Shared use paths are used by bicyclists, pedestrians, skaters, runners and others. The bicycle's operating characteristics will govern the design of shared use paths, as well as the requirements of the **2006 ADA Standards for Transportation Facilities**. The term *path* as used in this section refers to these paved shared use paths. An example typical design is provided for guidance in **Volume 2, Exhibit TYP-19**.

8.6.1 Considerations

Shared use paths adjacent to a roadway may be considered if the following conditions are met:

1. The path will be separated from the roadway.
2. There will be few access points or roadways crossing the path.
3. There will be adequate access to local streets and other facilities along the path.
4. There is a commitment to provide path continuity with other bikeways throughout the corridor.

Shared use paths are not replacements for on-street bicycle lanes. Within a roadway right of way, bicycle lanes are the safest, most efficient bicycle facility. When paths are located immediately adjacent to roadways, some operational problems are likely to occur:

1. Paths require one direction of bicycle traffic to ride against motor vehicle traffic, which is contrary to the normal Rules of the Road. Motorists are not in the habit of scanning for traffic from that direction.
2. At path ends, bicyclists riding against traffic will tend to continue to travel on the wrong side of the street, as do bicyclists getting on to a path. Wrong-way travel by bicyclists is a major cause of bicycle/automobile crashes and should be discouraged.
3. Many bicyclists will use the roadway instead of the path because they have found the roadway to be safer, less congested, more convenient, or better maintained.

8.6.2 Widths

The appropriate paved width for a shared use path is dependent upon context, volume and mix of users. Typically, widths range from 10-14 feet, with the wider values applicable to areas with high use and/or a wider variety of users (bicyclists, pedestrians, joggers, and skaters). The need to provide for larger emergency or maintenance vehicles or manage steep grades can also affect appropriate width. The minimum width for a two-directional shared use path is 10 feet. [FHWA's Shared Use Path Level of Service Calculator](#) may be used as a guide in determining when a width greater than the minimum might be needed.

Curb ramps shall be the same width as the path. At locations where the path narrows from the typical width warning signs or pavement markings in conformance with the MUTCD should be used.

8.6.3 Cross Slopes

Since pedestrian use is expected on shared use paths, ADA requirements shall be met. Therefore, the maximum cross-slope shall be 2%.

8.6.4 Grades

To meet ADA the maximum grade is 5%. Grades greater than 5% should be considered ramps and designed accordingly. Maximum ramp slopes are 8.33% and can have a maximum rise of 30 inches, with a level landing at least 60 inches in length.

To accommodate bicycles exclusively, grades should not exceed 5%, since steeper grades cause difficulties for many bicyclists. If the terrain makes it necessary to use steeper grades on short sections, the following restrictions are recommended:

Table 8.6.1 Maximum Grade Lengths

Grade (%)	Maximum Length
6%	For up to 800 feet
7%	For up to 400 feet
8%	For up to 300 feet
9%	For up to 200 feet
10%	For up to 100 feet
11+%	For up to 50 feet

NOTE: When using a longer grade, 4 to 6 feet of additional width should be added to the path to allow some bicyclists to dismount and walk their bikes. Additional clear distances should be provided and sight distances must be modified to accommodate longer grades.

Refer to **Section 8.6.9** for controls on grade changes.

8.6.5 Horizontal Clearance

A 4-foot horizontal clearance to lateral obstructions shall be maintained on both sides of a shared use path. A 2-foot wide graded area with a maximum 1:6 slope shall be maintained adjacent to both sides of the path.

Edge drop-offs should be avoided. When drop-offs cannot be avoided they should be shielded as discussed in **Section 8.8**.

8.6.6 Vertical Clearance

The vertical clearance to obstructions should be a minimum of 8 feet. However, vertical clearance may need to be greater to permit passage of maintenance and emergency vehicles. In underpasses and tunnels, 10 feet is desirable. Where equestrians may be sharing the path, a vertical clearance of 10 feet is desirable.

8.6.7 Design Speed

For paths in relatively flat areas (grades less than or equal to 4%), a design speed of 18 mph shall be used. When a downgrade exceeds 4 percent, a design speed of 30 mph should be used.

8.6.8 Horizontal Alignment

8.6.8.1 Minimum Radii

The minimum radius of curvature based upon superelevation for a shared use path is calculated based upon the following formula:

$$R = [V^2/15*(e/100 \pm f)] \text{ where:}$$

R = Minimum radius of curvature (feet)

V = Design speed (mph)

e = rate of bikeway super elevation (percent)

f = coefficient of friction

The effective superelevation is usually limited to the existing 2% cross slope and may be positive or negative. If a transition is needed, then a minimum 75-foot transition should be used. See **Table 8.6.2** for minimum radii for shared use paths. Further information on calculating the minimum radii may be found in the [AASHTO Guide for the Development of Bicycle Facilities, 2012](#).

Table 8.6.2 Minimum Radii for Horizontal Curves on Shared Use Paths

Design Speed	Superelevation	Friction Factor	Minimum Radius (ft.)
18	2%	0.27	74
18	-2%	0.27	86
30	2%	0.21	261
30	-2%	0.21	316

8.6.8.2 Stopping Sight Distance

The minimum stopping sight distances for a shared use path are calculated based upon the following formula:

$$S = \left[\frac{V^2}{(30 \times (f \pm G))} \right] + 3.67V$$

Where:

S = Stopping sight distance (feet)

V = Velocity (mph)

f = coefficient of friction (use 0.16 for typical bike)

G = grade (feet/feet)

The minimum stopping sight distance for a cyclist travelling 18 mph on a level shared use path is 134 feet. Additional values are given in **Table 8.6.3**. For a shared use path the object height is assumed 0.0 feet and the eye height is 4.5 feet. Further information on calculating the minimum stopping sight distances may be found in the **AASHTO Guide for the Development of Bicycle Facilities, 2012**.

Table 8.6.3 Minimum Stopping Sight Distances

MINIMUM STOPPING SIGHT DISTANCE (FEET)														
Design Speed	GRADES													
	-9%	-8%	-7%	-6%	-5%	-4%	-3%	3%	4%	5%	6%	7%	8%	9%
18 MPH	Use 30 MPH Values					156	149	123	120	118	115	113	111	109
30 MPH	539	485	444	410	383	Use 18 MPH Values								

8.6.9 Vertical Alignment

The minimum length of vertical curve necessary to provide minimum stopping sight distance at various speeds on crest vertical curves is selected by using the formula listed below:

When $S > L$:	$L = 2S - (900 / A)$	L = Min. Length of Vertical Curve (ft.)
		A = Algebraic Grade Difference (%)
When $S < L$:	$L = AS^2 / 900$	S = Stopping Sight Distance (ft.)

8.6.10 Separation between Shared Use Path and Roadway

When shared use paths are located adjacent to a roadway, a separation shall be provided. This demonstrates to both path users and motorists that the shared use path is a separate facility.

On roadways with flush shoulders, this separation is 5 feet measured from the outside edge of shoulder to the inside edge of the path. On roadways with curbs, the separation is 4 feet measured from the back of curb to the inside edge of the path, with consideration of other roadside obstructions (signs, light poles, etc.).

8.6.11 Path Railings

Railings or fences shall be provided as indicated in **Section 8.8**.

8.6.12 Lighting

Lighting for shared use paths is important and should be considered where riding at night is expected, such as paths serving college students or commuters, and at roadway intersections. Lighting should also be considered through underpasses or tunnels. Lighting standards are provided in **Table 7.3.1** of this volume.

8.6.13 Signing, Pavement Marking, and Signalization

The **Design Standards** and **MUTCD** shall be consulted for all signage, pavement markings and signals, especially on path/roadway intersections.

8.7 Bridges, Overpasses, and Underpasses

A bridge, an overpass, or an underpass may be necessary to provide pedestrian/bicycle continuity to sidewalks, bicycle lanes and shared use paths. Bicyclists should be accommodated at all pedestrian bridges (e.g., provide an alternative to stairs).

8.7.1 Design Criteria

The overpass or bridge design shall be in accordance with the criteria established below:

1. ***FDOT Structures Design Guidelines – Chapter 10.***
2. ***Section 8.2*** of this volume.
3. The minimum clear width for new FDOT pedestrian bridges is:
 - a. On a pedestrian structure - 8 feet.
 - b. On a shared use path structure - 12 feet.
 - c. If the approach sidewalk or path is wider than these minimums, the clear width of the structure should match the approach width. The desirable clear width should include an additional 2-foot wide clear area on each side.
4. Vertical clearance criteria shall be as per ***Chapter 2, Table 2.10.1*** of this volume. Horizontal clearances shall take into affect future widening plans of the roadway below.
5. Ramps
 - a. Comply with ADA requirements. See the [*Production Support Office - Accessibility Issues \(ADA\) Website*](#)
 - b. Ramps (routes with grades > 5%) should be provided at all pedestrian separation structures. When possible, stairways should be provided in addition to ramps.
 - c. Design ramps with the least possible grade, but in no case more than 8.33% and with 5 feet long, intermediate level platforms at a maximum 30-inch rise. Provide level platforms 5 feet long at the top of the ramp and 6 feet long at the bottom.
 - d. Provide full-length pedestrian ADA handrails on both sides of pedestrian ramps.
6. Fencing/Railing
 - a. Provide fencing/railing options in accordance with the [*SDG Chapter 10.*](#)
 - b. Provide full or partial screening on pedestrian bridges crossing FDOT right

of way in order to reduce the likelihood of objects being dropped or thrown onto the roadway below. See **Figure 8.7.1** for example of full screening.

- c. Pedestrian bridges on FDOT right of way but not crossing FDOT right of way are not required to be screened.
- d. Check with local authorities for guidance on screening for FDOT pedestrian bridges crossing local rights of way.
- e. The use of chain link fence on ramps of the pedestrian bridges will be determined on a project-by-project basis.

See **Chapter 26** for review requirements based on pedestrian bridge structure category.

Pedestrian underpasses are generally undesirable; however, if one is provided, the geometrics and lighting requirements should be discussed with the Department Project Manager and the District Pedestrian/Bicycle Coordinator. Local law enforcement personnel may need to be consulted to assure public safety, emergency accessibility and other desirable features.

Figure 8.7.1 Pedestrian/Shared Use Path Bridge Typical Section

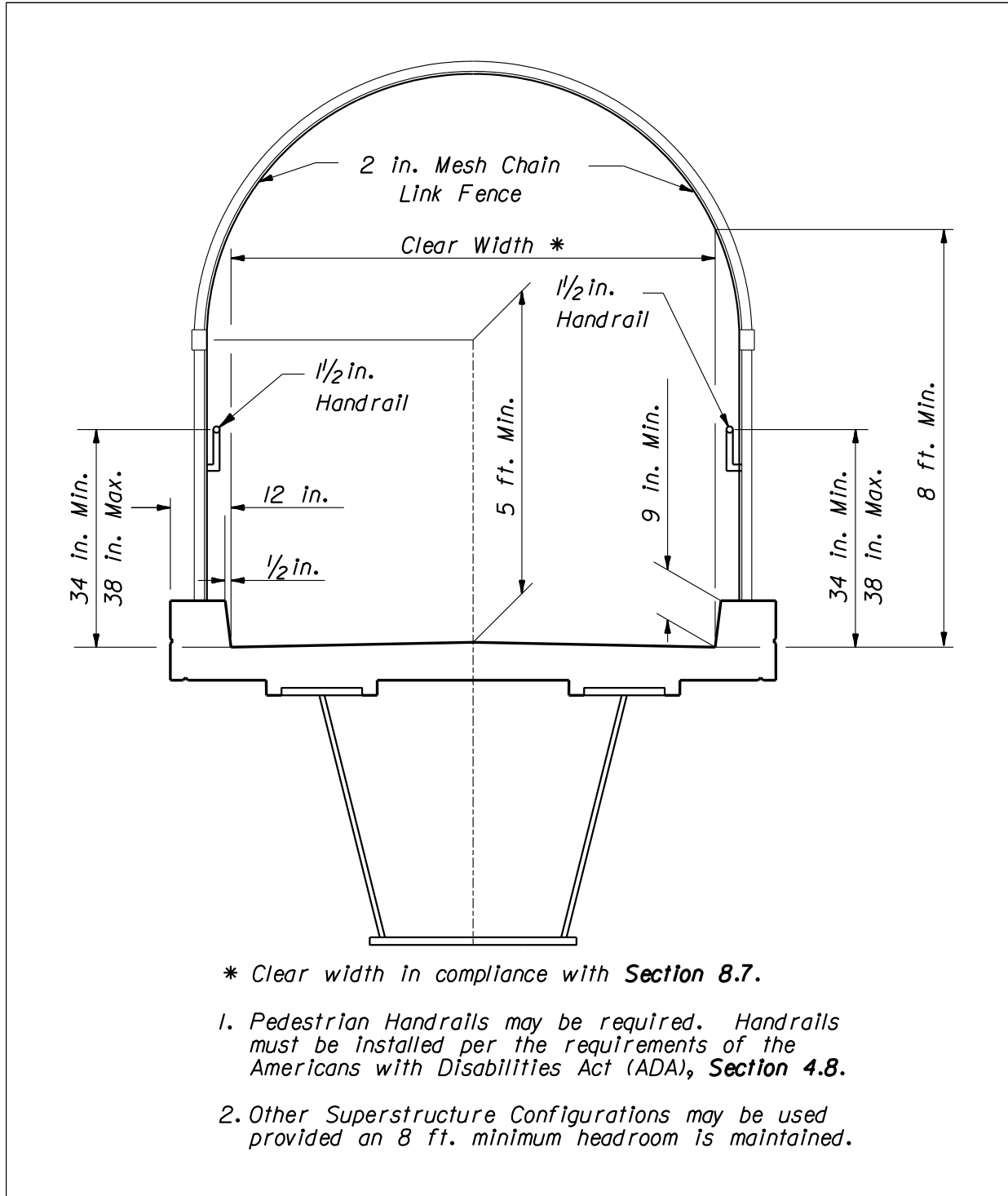

8.7.2 Prefabricated Steel Truss Bridges on FDOT Projects

In many situations it makes good engineering and economic sense to utilize prefabricated steel truss bridges for pedestrian crossings. These bridges can be stand-alone structures or a hybrid structure with adjoining spans of other types (FIB, deck slab, steel I-girder, etc.). The provisions of this article apply only to the spans on a bridge that are comprised of prefabricated steel trusses. The term steel truss bridge as applied in this article refers only to stand-alone steel truss structures or to the steel truss spans of a hybrid bridge structure.

The Department may elect to use prefabricated truss bridges on FDOT projects if the following conditions are met:

1. The steel truss span lies within a tangent horizontal alignment.
2. The maximum length of the steel truss span does not exceed 200 feet.
3. The width of the steel truss span is constant.
4. The steel truss span supports have a skew angle not to exceed 20°.

When these criteria are not met provide a complete set of bridge details in the plans.

Modification for Non-Conventional Projects:

Delete *PPM* 8.7.2 and replace with the following:

8.7.2 Prefabricated Steel Truss Bridges on FDOT Projects

Prefabricated steel truss bridges can be stand-alone structures or a hybrid structure with adjoining spans of other types (FIB, deck slab, steel I-girder, etc.). The provisions of this article apply only to the spans on a bridge that are comprised of prefabricated steel trusses. The term steel truss bridge as applied in this article refers only to stand-alone steel truss structures or to the steel truss spans of a hybrid bridge structure.

See RFP for requirements.

8.7.2.1 Qualification of Prefabricated Steel Truss Pedestrian Bridge Producers

All prefabricated steel truss pedestrian bridge producers wanting to participate on FDOT projects must be on the Department's List of Qualified Metal Fabrication Facilities. For information on the facility qualification process see **Articles 11.1.5** and **11.1.6** of the [FDOT Materials Manual](#).

8.7.2.2 Design and Detailing Responsibilities

The project Engineer of Record (EOR) will be responsible for design and detailing of the steel truss bridge substructure and foundation including end bents, piers, pile foundations, and/or spread footings. The project EOR will also be responsible for design and detailing of all approach structures (non-steel truss bridge spans, walls, ramps, steps, approach slabs, etc.).

The Contractor's EOR will be responsible for the design and detailing of the steel truss bridge superstructure including trusses, deck, bridge railing, floor beams, bridge joints, bearing assemblies and anchor bolts.

Modification for Non-Conventional Projects:

Delete **PPM** 8.7.2.2 and replace with the following:

8.7.2.2 Design and Detailing Responsibilities

The Engineer of Record (EOR) will be responsible for design and detailing of the steel truss bridge foundation, substructure and superstructure. The EOR will also be responsible for design and detailing of all approach structures (non-steel truss bridge spans, walls, ramps, steps, approach slabs, etc.). The steel truss bridge superstructure including trusses, deck, bridge railing, floor beams, bridge joints, bearing assemblies and anchor bolts shall be included as part of the superstructure component submittal.

8.7.2.3 Plans Development

To allow equal opportunity for all qualified pedestrian bridge producers to participate, the pedestrian bridge plans shall have the flexibility to accommodate multiple alternate superstructure designs. When a prefabricated steel truss pedestrian bridge is warranted, the following procedure shall be followed by the project EOR when developing the plans:

1. Using **Figures 8.7.2, 8.7.3, and 8.7.4**, coordinate with the District Project Manager to select all allowable truss configurations, truss member shapes, and bridge cross sections. Note that for spans greater than 150 feet a box truss bridge cross-section is required.

If project specific aesthetic requirements warrant the use of truss configurations not included in **Figure 8.7.2** the project EOR can specify additional truss configurations. However, a minimum of two steel truss pedestrian bridge producers shall be capable of satisfying the aesthetic requirements.

2. Develop a Plan and Elevation sheet and Bridge Typical Section to be submitted with the BDR/30% plans.
3. After the BDR/30% plans have been approved send out a Prefabricated Pedestrian Bridge Invitation to Participate (ITP) to all prefabricated pedestrian steel truss bridge producers on the Department's List of Qualified Fabrication Facilities. The ITP shall be sent through registered mail with return receipt to confirm delivery. Contact information for all qualified producers can be found at the following web address:

<ftp://ftp.dot.state.fl.us/fdot/smo/website/sources/metalsource.pdf>

The ITP is intended to solicit qualified producers for information required to design the foundation and substructure of the steel truss pedestrian bridge. The ITP cover letter should contain the following elements with links to websites as appropriate and applicable:

- Introduction with brief project description
- Project Requirements
 - Design Specifications Requirements
 - Construction Specifications Requirements
 - Design Standards Requirements
 - Bridge Typical Section
 - Allowable Truss Options
 - Painting Requirements
 - Pedestrian Fence/Railing Requirements

- Vehicular Loading Requirements
- Project Specific Aesthetic Requirements (if applicable)
- Project Geometry including Vertical Clearance Requirements for Each Span
- Participation Requirements
- Submittal Requirements

Include the following items in the ITP package:

- Hard copy:
 - Invitation to Participate Cover Letter
 - Project Location Map
 - Plan and Elevation
 - Bridge Typical Section and Pedestrian Fence Concept
 - Pedestrian Bridge Data Sheet
- Electronic files:
 - PDF file with all of the above
 - Pedestrian Bridge Data Sheet in CADD format

For a sample Prefabricated Pedestrian Bridge ITP complete with all hard copy attachments see **Exhibit 8-A**. To aid plan development CADD cells for the Pedestrian Bridge Data Sheet and Plan and Elevation sheet (2 of 2) are available in the FDOT Structures Cell Library. For the current FDOT CADD Software downloads follow the link below:

[\[http://www.dot.state.fl.us/ecso/downloads/software/software.shtm\]](http://www.dot.state.fl.us/ecso/downloads/software/software.shtm)

4. Upon delivery the pedestrian bridge producers shall acknowledge receipt of the ITP package.
5. In order to be eligible to participate in the project the pedestrian bridge producers must provide a completed Pedestrian Bridge Data Sheet as outlined in the ITP on or before the specified due date (prior to 60% plans submittal). The completed Data Sheets shall be electronically signed and sealed by the Contractor's EOR for inclusion in the final plan set.

The project EOR shall assign a unique sheet number to each data sheet. The sheet numbers will be identified with the prefix BP (e.g., BP-1, BP-2, BP-#) and the data sheets will be placed at the end of the numbered sequence of the bridge plans. This will allow the Pedestrian Bridge Data Sheets to have constant (unchanging) sheet numbers as plan development progresses.

6. After all ITP responses are received the project EOR shall design and detail the

foundation and substructure to accommodate the superstructure designs of all eligible pedestrian bridge producers. Design shall envelope the most extreme loading conditions and geometry of all alternates.

7. Include the following notes in the plans:

- Eligible Steel Truss Pedestrian Bridge Producers

Included in this plan set are Pedestrian Bridge Data Sheets submitted by bridge producers eligible to participate in this project. Producers who failed to submit a data sheet are excluded from participation. No Cost Savings Initiative Proposal shall be accepted for the truss superstructure portion of the project. Contact information for the eligible producers is included in the data sheet.

- Shop Drawing Submittal

Prior to fabrication the Contractor's EOR shall submit signed and sealed superstructure shop drawings, technical specifications, and design calculations to the Engineer for review and approval.

8. Include the following Pay Item note in the plans:

- Prefabricated Steel Truss Pedestrian Bridge Span

Prefabricated Steel Truss Pedestrian Bridge Span shall be paid for at the contract unit price per square foot of deck area under Pay Item No. 460-7 Prefabricated Steel Truss Pedestrian Bridge, SF. This pay item includes furnishing and installing the prefabricated steel truss pedestrian bridge superstructure including steel trusses, floor system, deck, bearing assemblies, deck joints, and bridge railing/fencing. Payment for this pay item shall be based on the plan quantity. Portions of pedestrian bridge outside the limits of the steel truss span shall be paid for under individual pay items.

Figure 8.7.2 Prefabricated Pedestrian Bridge Standard Truss Configurations

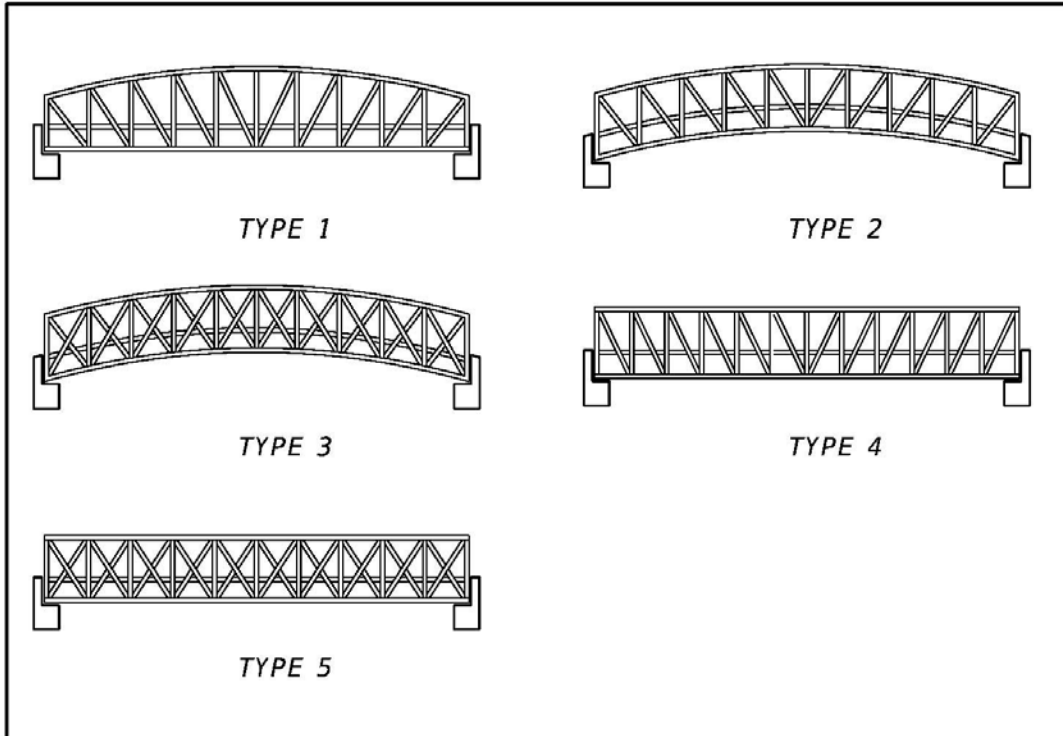

Figure 8.7.3 Prefabricated Pedestrian Bridge Standard Truss Member Shapes

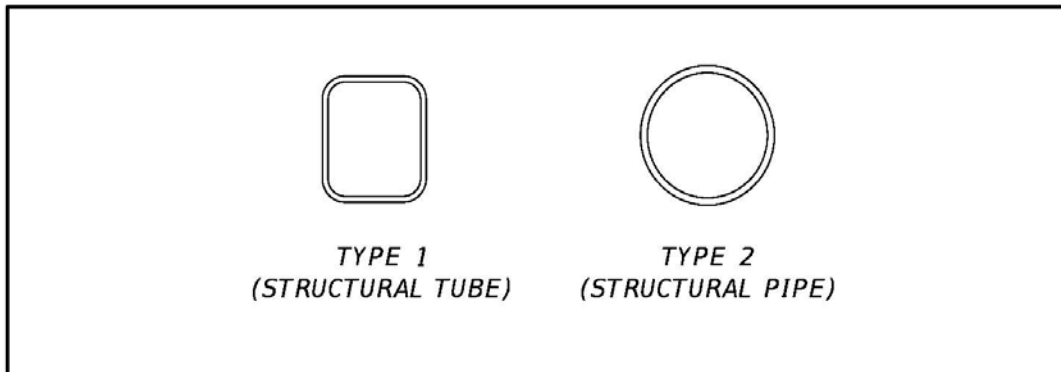
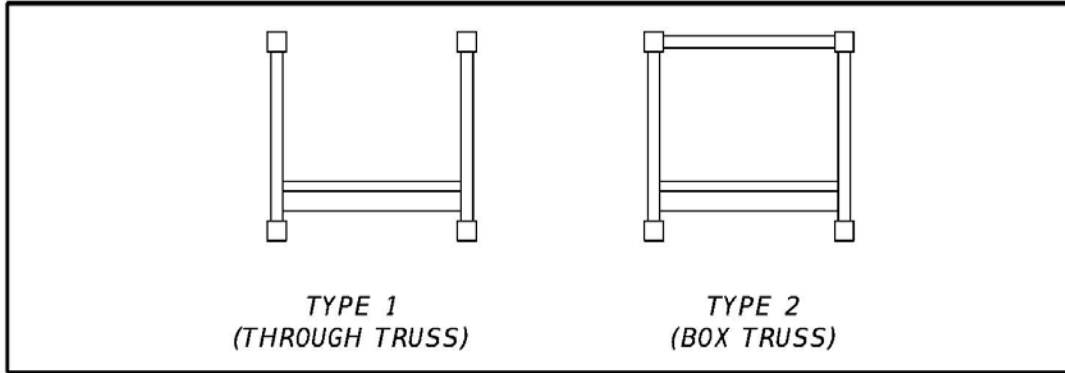

Figure 8.7.4 Prefabricated Pedestrian Standard Bridge Cross-Sections



Modification for Non-Conventional Projects:

Delete **PPM** 8.7.2.3 and see RFP for requirements.

8.8 Drop-off Hazards for Pedestrians and Bicyclists

Drop-off hazards are defined as steep or abrupt downward slopes that can be perilous to pedestrians and bicyclists. The Engineer should consider shielding any drop-off determined to be a hazard. Railings or fences should be provided for vertical drop-off hazards or where shielding is required as described in this section. Note that the Pedestrian/Bicycle Picket Railings (**Design Standards Index 850 or 860 Series**) and the Pipe Guiderail (**Index 870 and 880 Series**) have not been crash tested, and shall not be placed within the horizontal clearance of the roadway.

The following guidelines will be useful in standardizing the identification and treatment of drop-off hazards for pedestrians and bicyclists.

There are two cases that require shielding. As shown in **Figure 8.8.1 (Case 1)**, a drop-off greater than 10 inches that is closer than 2 feet from the pedestrians' or bicyclists' pathway or edge of sidewalk is considered a hazard and shall be shielded. Also, as shown in **Figure 8.8.1 (Case 2)**, a slope steeper than 1:2 (as called for in the plans) that begins closer than 2 feet from the pedestrians' or bicyclists' pathway or edge of sidewalk is considered a hazard and shall be shielded when the total drop-off is greater than 60 inches. Also, depending on the depth of the drop-off and severity of the conditions below, shielding may be necessary for cases other than described above.

However, in determining if shielding a drop-off hazard would be feasible for protecting pedestrians and bicyclists, the following should be considered:

1. The engineer should consult the District Bicycle/Pedestrian Coordinator regarding pedestrian and bicyclist traffic and their routes.
2. Installing fencing or railings are two ways to shield the drop-offs. Fencing is generally intended for use in rural areas along paths and trails. Standard railing is generally intended for urbanized areas, locations attaching to bridge rail or along concrete walkways. The Pedestrian/Bicycle Railings* shown on **Index 850 and 860 Series** of the **Design Standards** are adequate for shielding all drop-offs but are generally intended for use on drop-offs greater than 60 inches. The Pipe Guiderail shown on **Index 870 and 880 Series** of the **Design Standards** are adequate for shielding drop-offs which are 60 inches or less.
3. Along continuous sections where the drop-off varies above and below the 60 inch threshold for using **Index 870 or 880**, for uniformity the engineer may consider using only one of the railing types adequate for shielding all drop-offs (**Index 850 or 860 Series**).

4. The height of railings for bicyclists are generally the same as the minimum pedestrian railing height of 42 inches. A minimum 54 inch railing or fence should be considered only on bridges and retaining walls for special circumstances as identified in the commentary of the **AASHTO LRFD Bridge Design Specifications Section 13.9**. Specify the height of the pedestrian/bicycle railing in the contract plans.
5. Care should be taken when using Pedestrian/Bicycle Railings or fencing near intersections or driveways as they could obstruct the driver's line of sight. To reduce the need for railings as a sidewalk or shared use path approaches an intersection, consider extending cross drains and side drains to minimize drop-offs.

Where Pedestrian/Bicycle Railing is used, the Department will only cover the cost for either the standard galvanized steel or standard aluminum railing. If the Local Agency desires a painted railing, they must provide the additional funding and commit to cover the maintenance cost. The Department will also only cover the cost of the standard Infill Panel Types shown in the **Design Standards**. If the Local Agency desires a railing having Custom Infill Panels which increases the cost over standard infill panels, they must provide the additional funding to cover this initial premium cost. In addition, a maintenance agreement will be needed to address the responsibilities associated with maintaining all Custom Infill Panels.

Modification for Non-Conventional Projects:

Delete the above paragraph. See the RFP for requirements.

Figure 8.8.1 Drop-Off Hazards for Pedestrians and Bicyclists

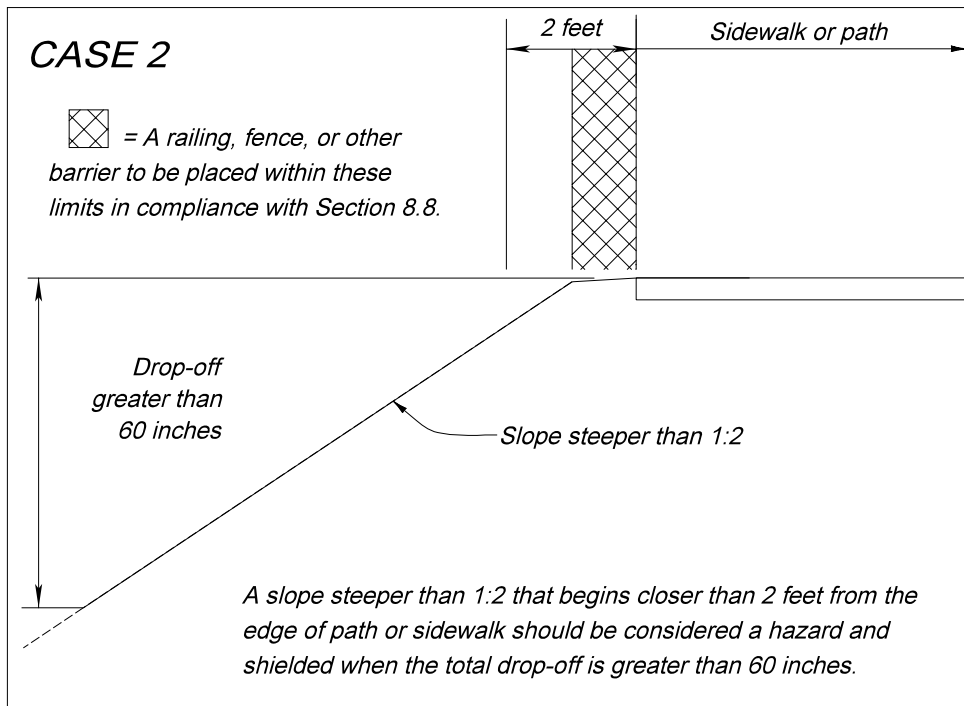
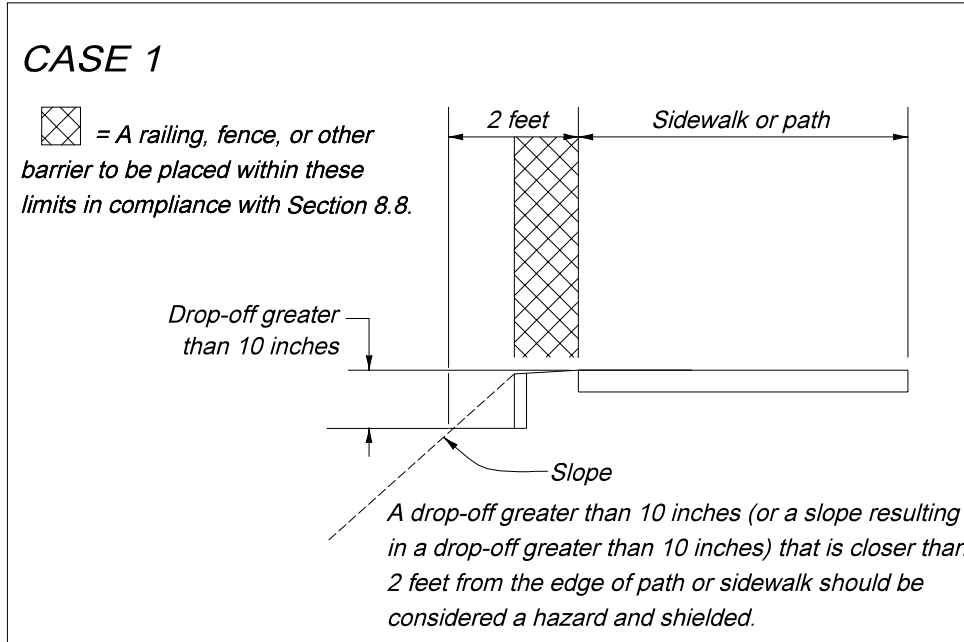

8.9 Strategic Intermodal System Highway Component Standards and Criteria

[Department Procedure No. 525-030-260, Strategic Intermodal System \(SIS\) Highway Component Standards and Criteria](#), relates the SIS Highway Component to the design standards, design criteria, level of service standards, and processes used by the Department. The Procedure provides guidance to Metropolitan Planning Organizations (MPOs) for the development of transportation plans and programs for metropolitan areas that provide for the operation and integrated management of transportation systems and facilities, including bike and pedestrian facilities.

[Florida Statute 316.091](#) provides guidance for travel by bicyclists and pedestrians on limited access facilities. The **Statute** establishes a pilot program to allow travel by bicyclists on certain facilities.

8.10 Public Transit Facilities

When a project includes a public transit route, curb side and street side transit facilities for bus stops should be considered in the roadway design process.

The FDOT [Accessing Transit: Version III, 2013 Design Handbook for Florida Bus Passenger Facilities](#) provides guidance relating to provisions for curb side and street side facilities. Refer to **Table 2.11.9** of this **Volume** for criteria on the placement of shelters and benches. Coordination with the District Modal Development Office and/or local public transit provider(s) is necessary in developing the plans.

8.10.1 Curb-Side Facilities

Curb-side facilities are the most common, simplest and convenient form of facilities at a bus stop. These include bus stop signs, passenger waiting shelters, boarding and alighting areas, curb ramps, benches, leaning rails, and shelter lighting.

On flush shoulder roadways, bus stops with a raised, clear 5-foot by 8-foot boarding and alighting area may be constructed at the shoulder point (or edge of shoulder pavement on roadways with a design speed of 45 mph or less) to create an accessible bus stop, as shown in **Figures 8.10.1** and **8.10.2**. The raised area provides a platform that is compatible with a bus that kneels or extends a ramp with a slope of 1:6 or less. Boarding and alighting areas are not required at bus stops on flush shoulder roadways where only a bus stop sign is provided. Bus stops should be located in close proximity to existing intersections, and with sidewalk access. The boarding and alighting area shall:

1. Use a Type E curb and gutter (5" curb height)
2. Be connected to the sidewalk along the roadway; or to the roadway when no sidewalk is present

A sidewalk and/or ramp provided with the boarding and alighting area shall be a minimum of 5 feet in width; and the ramp shall not exceed a slope of 1:12. A detectable warning is required where a sidewalk associated with a boarding and alighting area connects to the roadway at grade. Except for the area adjacent to the 5" curb, the areas surrounding the boarding and alighting area shall be flush with the adjacent shoulder and side slopes and designed to be traversable by errant vehicles. On the upstream side of the platform, a maximum slope of 1:12 should be provided, and may be grass or a hardened surface. The boarding and alighting area (and ramp and level landing if needed) are to be paid for as 6" thick concrete.

Figure 8.10.1 Accessible Boarding and Alighting Area for Flush Shoulder Roadways with Connection to Roadway

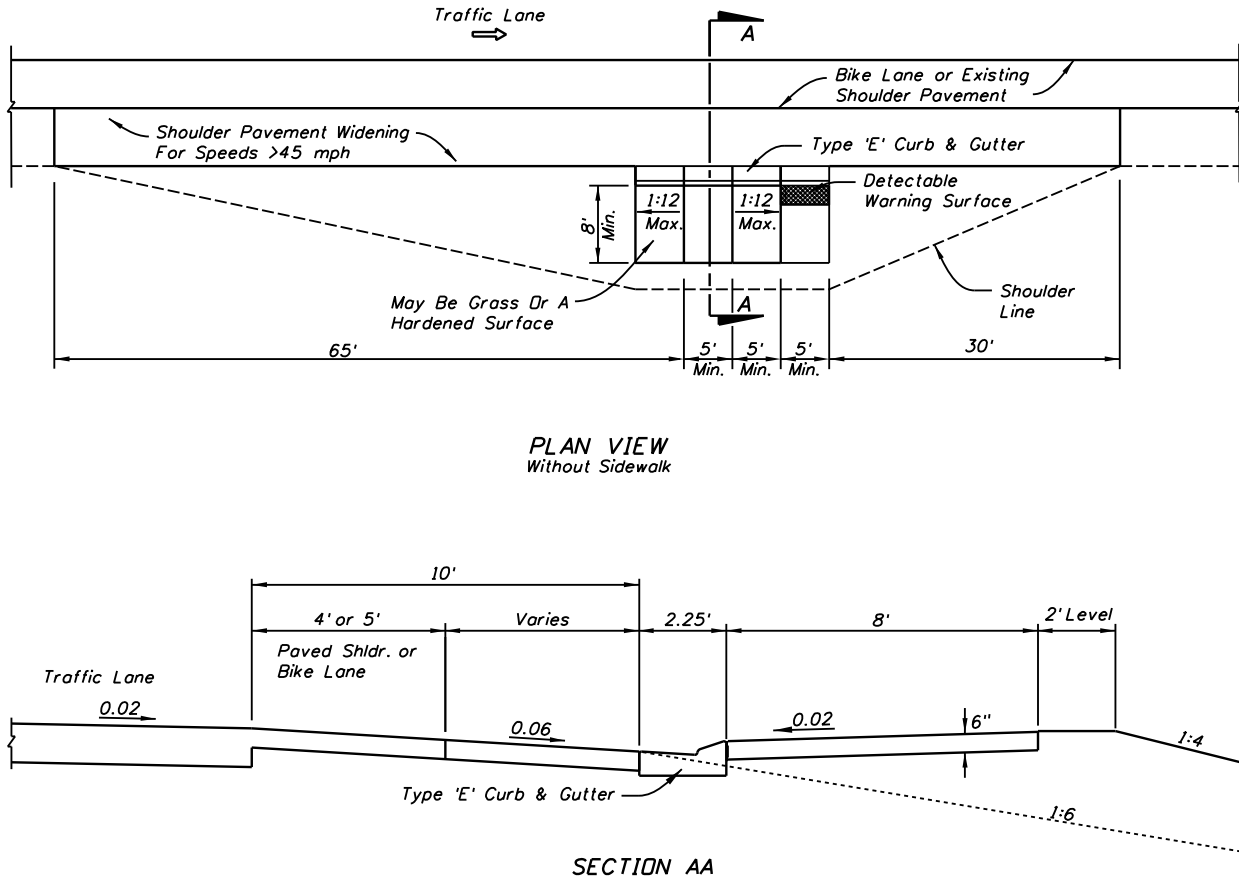
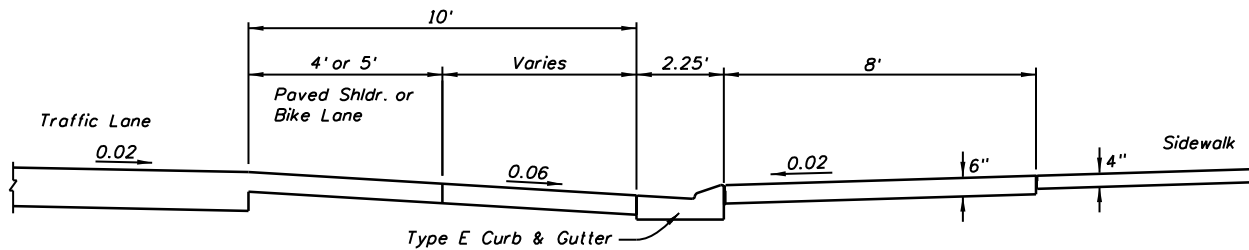
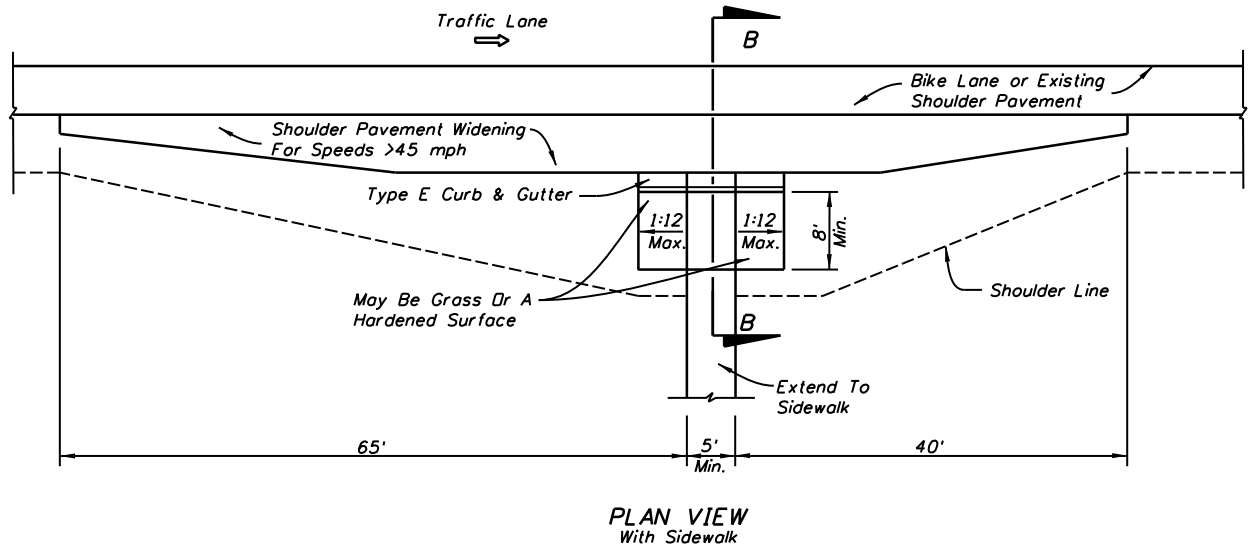

Figure 8.10.2 Accessible Boarding and Alighting Area for Flush Shoulder Roadways with Connection to Sidewalk



SECTION BB

8.10.2 Street-Side Facilities

Bus stop locations can be categorized as far-side, near-side and midblock stops. Bus stops may be designed with a bus bay or pullout to allow buses to pick up and discharge passengers in an area outside of the travel lane. This design feature allows traffic to flow freely without the obstruction of stopped buses. See **Figure 8.10.3** for typical detail for the bus stop and bus bay categories. **Chapter 2** of **Accessing Transit Handbook** provides additional information for each facility. The greater distance placed between waiting passengers and the travel lane increases safety at a stop. Bus bays are encouraged on roadways with high operating speeds, such as roads that are part of the Urban Principal Arterial System. For a particular bus stop, a high frequency of crashes involving buses is a good indicator for the need of a bus bay. Bus bays are classified as closed, open or bulbs. Illustrations for various bus bay configurations are provided in the **Accessing Transit Handbook** on the Public Transit Office website:

<http://www.dot.state.fl.us/transit/Pages/NewTransitFacilitiesDesign.shtm>

At a specific location, a balance must be obtained based on the designer's judgment and input from the applicable transit agencies. In locations where the traffic volumes exceed 1,000 vehicles per hour per lane, it is difficult to maneuver the bus into the bay and back into the travel lane. Incorporating an acceleration distance, signal priority, or a far-side (rather than near-side or midblock) placement, are potential solutions when traffic volumes exceed 1,000 vehicles per hour per lane.

The total length of the bus bay should allow room for an entrance taper, a stopping area, and an exit taper as a minimum. However, in some cases it may be appropriate to consider providing acceleration and deceleration lanes depending on the volume and speed of the through traffic. This decision should be based upon site specific conditions. **Accessing Transit** provides detailed bus bay dimensions for consideration when right of way is unlimited and access points are limited.

Figure 8.10.3 Bus Stop and Bus Bay Categories

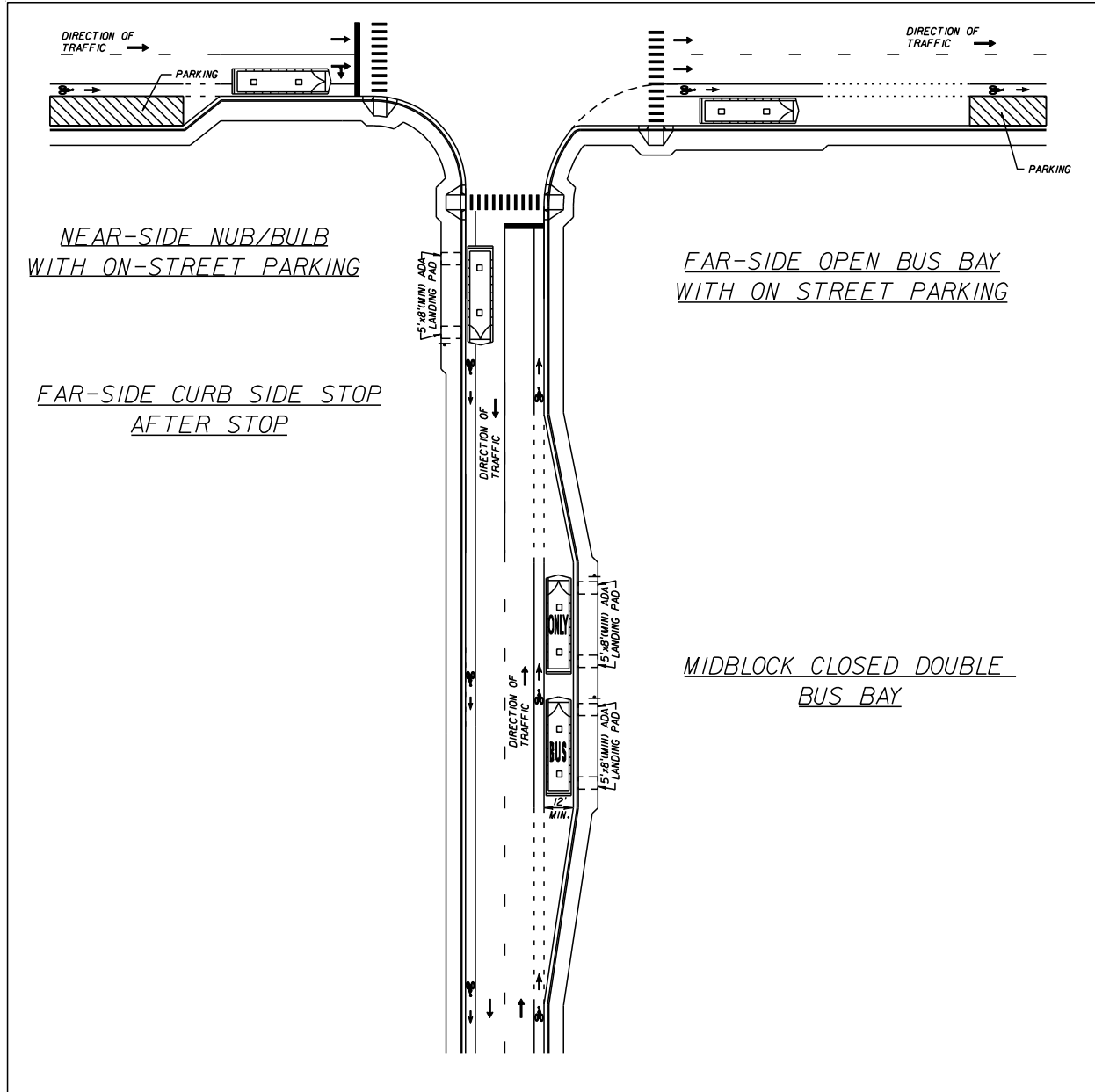

THIS PAGE LEFT BLANK INTENTIONALLY

Exhibit 8-A Sample Steel Truss Pedestrian Bridge Plans, Sheet 1 of 8

(prepare on Department letterhead)

FLORIDA DEPARTMENT OF TRANSPORTATION

DISTRICT 3

PREFABRICATED PEDESTRIAN BRIDGE

INVITATION TO PARTICIPATE

Project: CR 250 over Ruby Creek Pedestrian Bridge

Financial Project Number: 217664-1-52-01

Federal Aid Project Number(s): SF2-349-R

Date: March 15, 2011

Introduction:

The Florida Department of Transportation is currently preparing bid documents for the construction of a steel truss pedestrian bridge adjacent to County Road 250 crossing Ruby Creek in Jefferson County. The superstructure of the proposed bridge is to be provided by a steel truss pedestrian bridge producer who is prequalified to work on FDOT projects. This invitation to participate is being sent to all prequalified producers to solicit information needed by the project EOR to design the foundation and substructure of the proposed bridge. Enclosed are the following materials:

- Hard Copy
 - Project location map
 - Bridge Typical Section and Pedestrian Fence Concept
 - Plan and Elevation (P&E) (2 sheets)
 - Pedestrian Bridge Data Sheet
- Electronic
 - PDF file with all of the above
 - Pedestrian Bridge Data Sheet in CADD format

Exhibit 8-A Sample Steel Truss Pedestrian Bridge Plans, Sheet 2 of 8

Project Requirements:

1. Design Specifications: as specified in *FDOT Structures Design Guidelines (SDG) Article 10.4*.
<http://www.dot.state.fl.us/structures/StructuresManual/CurrentRelease/StructuresManual.shtm>
2. Construction Specifications:
FDOT Standard Specifications for Road and Bridge Construction, current edition.
<http://www.dot.state.fl.us/specificationoffice/Default.shtm>
3. Design Standards:
FDOT Design Standards, current edition.
<http://www.dot.state.fl.us/rddesign/DesignStandards/Standards.shtm>
4. Allowable Truss Options: All allowable Truss options are indicated on P&E sheet 2 of 2 (Attached).
5. Paint: All structural steel shall be painted in accordance with *Sections 560* and *975* of the *Specifications*. All structural steel shall be painted with a high performance top coat system. The color of the finish coat shall conform to Federal Standard No. 595, Color No. 36622.
6. Pedestrian Fence: Bridge Fence consistent with bridge rail concept and *SDG Article 10.12*.
7. Vehicular Loading: Vehicular Loading per *AASHTO LRFD Guide Specifications* for the Design of Pedestrian Bridges is not required.
8. Geometry: For project geometry see attached P&E sheets.

Participation:

To be eligible to participate on this project pedestrian bridge producers must:

- Acknowledge receipt of this ITP
- Be on the FDOT List of Qualified Fabrication Facilities.
- Submit a response to this ITP on or before June 10, 2011 to the project EOR.

Submittal:

Provide completed pedestrian bridge data sheet as follows:

- Bearing Plate Dimensions Table – for each span provide bearing dimensions as shown to the nearest 1/8th inch.

Exhibit 8-A Sample Steel Truss Pedestrian Bridge Plans, Sheet 3 of 8

- Bearing Plate Locations & Bridge Seat Elevations Table – for each substructure unit provide dimensions as shown to the nearest 1/8th inch and bridge seat elevation to the nearest 0.001 feet.
- Bridge Reactions Table – for each span provide loads as indicated to the nearest 0.1 kip.
- Company Contact Information Table – in the contact information block provide company name, address, contact person, phone number, and e-mail address.
- Florida PE Seal and Signature – provide seal and signature of Florida PE responsible for the work.

Submit response to:

John Doe, PE
XYZ Engineers, Inc.
123 East Main Street
Tampa, Florida 33607

By submitting a response to this invitation to participate the pedestrian bridge producer is agreeing to satisfy all project requirements listed above if selected.

Exhibit 8-A Sample Steel Truss Pedestrian Bridge Plans, Sheet 4 of 8

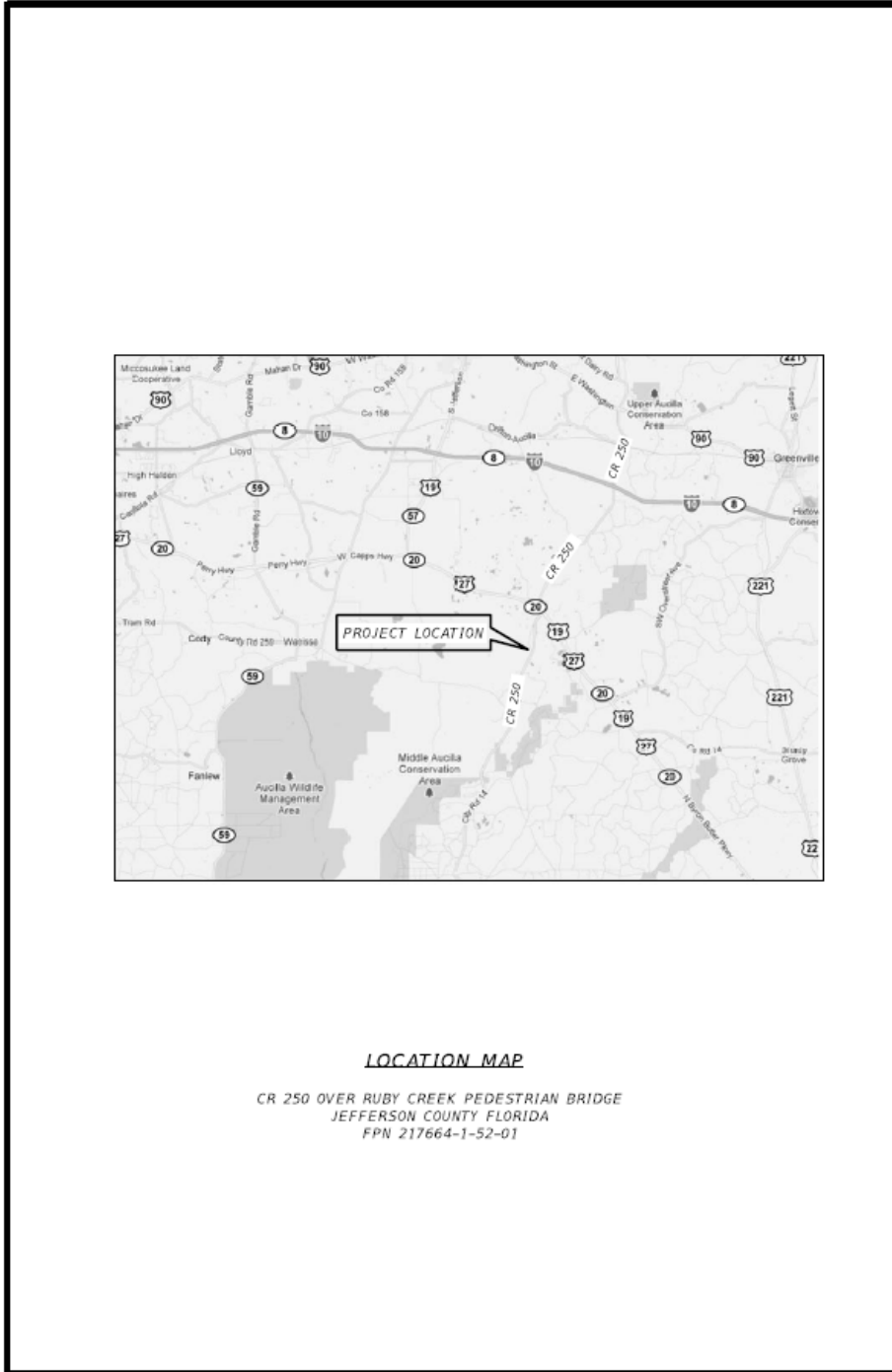

Exhibit 8-A Sample Steel Truss Pedestrian Bridge Plans, Sheet 5 of 8

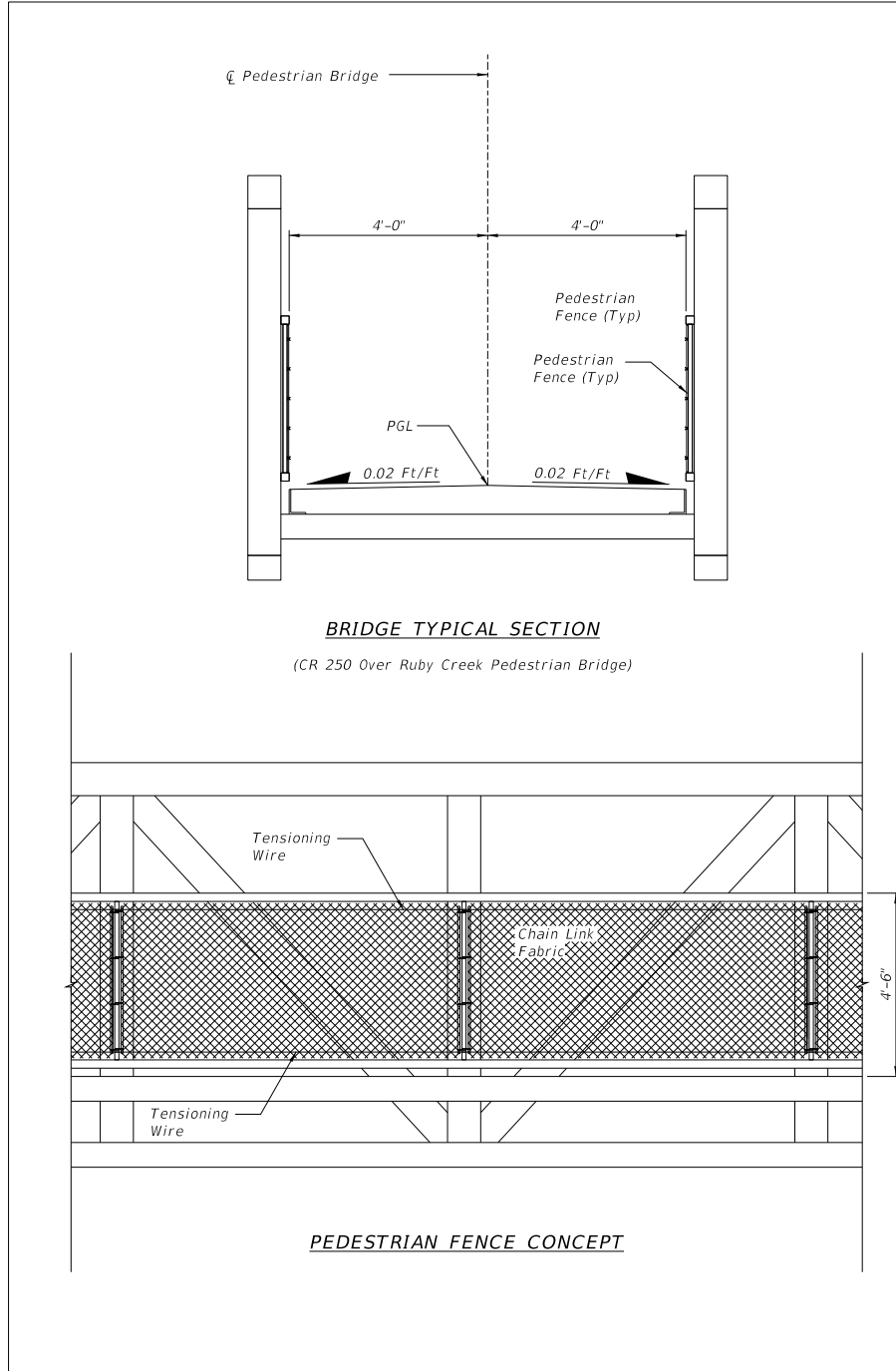

Exhibit 8-A Sample Steel Truss Pedestrian Bridge Plans, Sheet 6 of 8

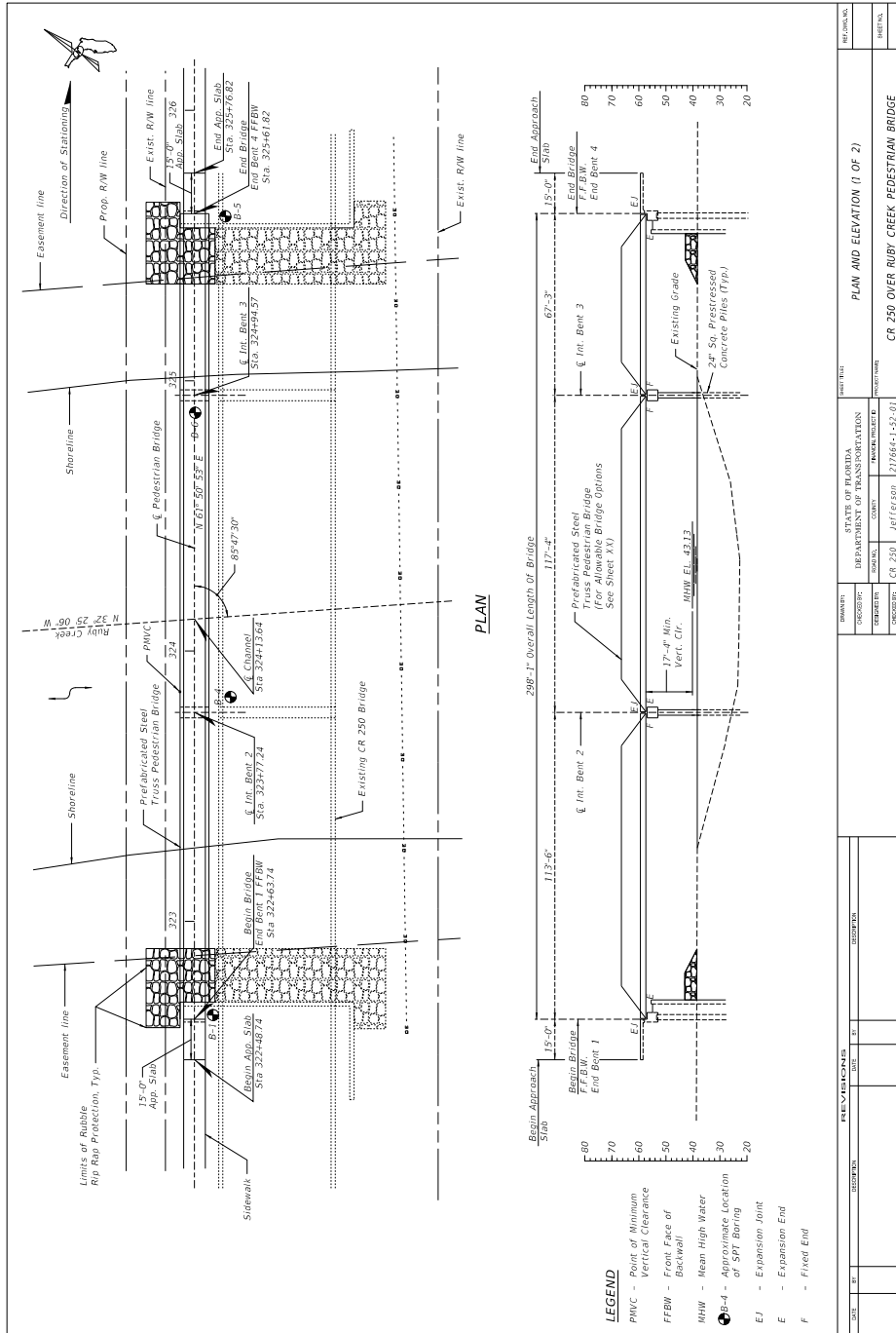

Exhibit 8-A Sample Steel Truss Pedestrian Bridge Plans, Sheet 7 of 8

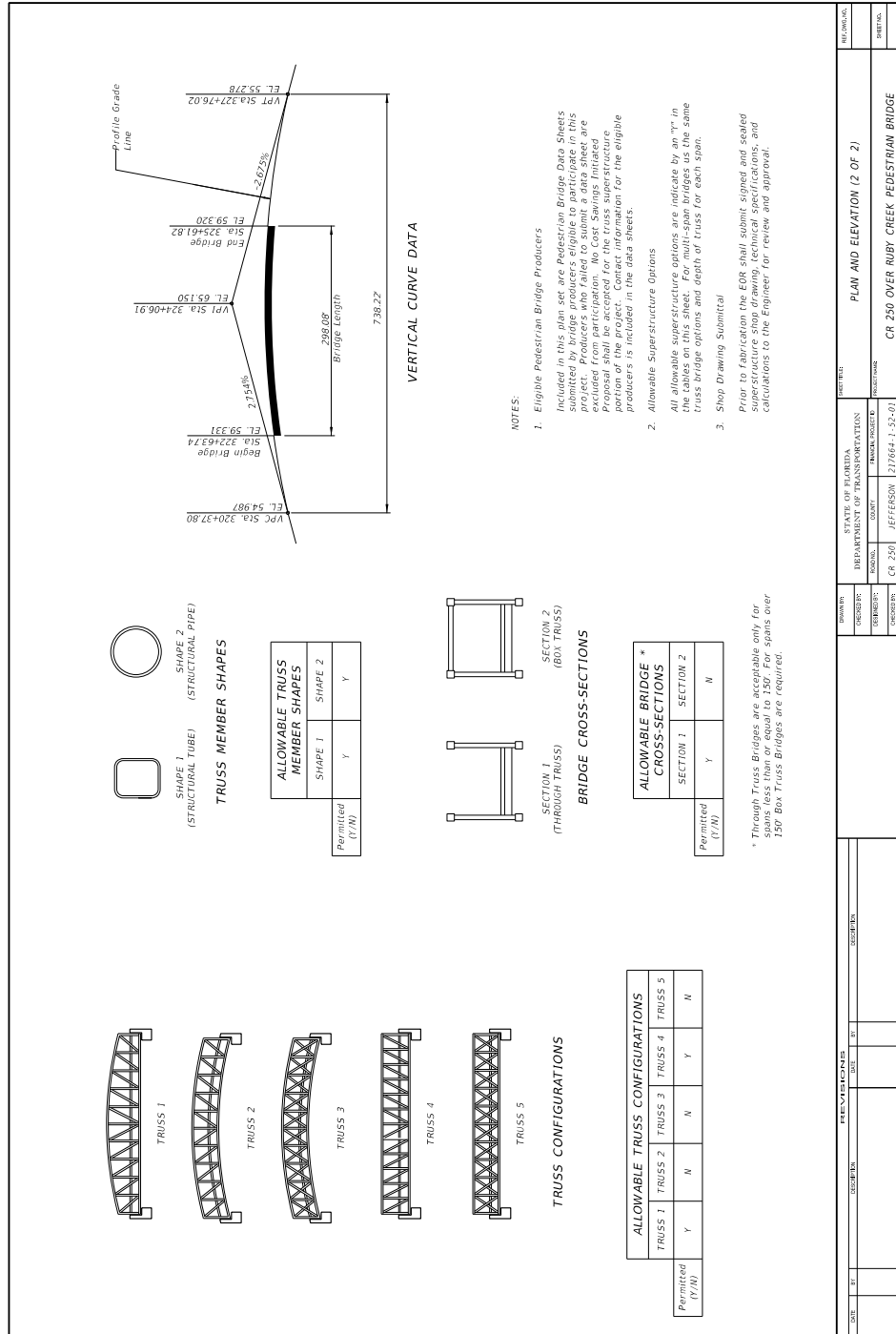

Exhibit 8-A Sample Steel Truss Pedestrian Bridge Plans, Sheet 8 of 8

COMPANY CONTACT INFORMATION

COMPANY	
ADDRESS	
CONTACT	
PHONE	
E-MAIL	

BEARING PLATE DIMENSIONS

SPAN	G	H	J	K
	(ft.)	(in.)	(ft.)	(in.)
1				
2				
3				
4				

BEARING PLATE DETAILS

EXPANSION

FIXED

BRIDGE REACTIONS

	SPAN 1		SPAN 2		SPAN 3		SPAN 4	
	P (KIP)	T (KIP)	P (KIP)	T (KIP)	P (KIP)	T (KIP)	P (KIP)	T (KIP)
DEAD LOAD								
UNIFORM LIVE LOAD								
VEHICLE LOAD								
WIND WINDWARD								
WIND LEEWARD								
UP/LIFT								
TRANSVERSE								
WIND*								
VERTICAL †								
THERMAL								

BEARING LOCATIONS & BRIDGE SEAT ELEVATIONS

BEARING/PIER	A	B	C	D	E	F
	(ft.)	(ft.)	(ft.)	(ft.)	(ft.)	(ft.)
1						
2						
3						
4						
5						

TYPICAL END BENT PARTIAL PLAN

TYPICAL INTERMEDIATE PIER/BENT PARTIAL PLAN

TYPICAL END BENT PARTIAL ELEVATION

TYPICAL INTERMEDIATE PIER/BENT PARTIAL ELEVATION

REVISIONS

DATE	BY	REVISIONS

PEDESTRIAN BRIDGE DATA

STATE OF FLORIDA	DEPARTMENT OF TRANSPORTATION
PROJECT NO.	CR 250
CONTRACT NO.	217664-1-52-01
DESIGNER	JEFFERSON
DATE	12/20/11
PROJECT TITLE	CR 250 OVER RUBY CREEK PEDESTRIAN BRIDGE

NOTES:

1. P – Unfactored Vertical Load each Bearing Plate (4 per Span)
2. T – Unfactored Transverse Load each Bearing Plate (4 per Span)
3. L – Unfactored Longitudinal Load each Bearing Plate (4 per Span)
4. Downward vertical loads are positive (+), upward vertical loads are negative (-).
5. The horizontal wind load acting at the c.g. of the truss creates a transverse shear and a vertical couple at the top of each pier/bearing location.
6. Design Specifications:
 - Structures Manual, current Edition and supplements thereof.
 - American Association of State Highway and Transportation Officials (AASHTO) Load and Resistance Factor (LRFD) Bridge Design Specifications, current Edition.
 - AASHTO LRFD Guide Specifications for the Design of Pedestrian Bridges, current Edition.
 - FDOT Plans Preparation Manual, current Edition.