

FINAL REPORT

**Improvements in Design Scour Depth Prediction
FDOT No.: BD545-34
UF No.: 00051996**

Submitted to

**The Florida Department of Transportation
Research Center
605 Suwannee Street, MS 30
Tallahassee, FL 32399**

c/o Mr. Rick Renna

Submitted by

**D. Max Sheppard
College of Engineering
Department of Civil and Coastal Engineering
University of Florida
365 Weil Hall, PO Box 116580
Gainesville, FL 32611-6580**

December 2006

Rick Renna, P.E., Project Manager

December, 2006

Disclaimer

The opinions, findings, and conclusions expressed in this publication are those of the author and not necessarily those of the State of Florida Department of Transportation.

SI (MODERN METRIC) CONVERSION FACTORS (from FHWA)

APPROXIMATE CONVERSIONS TO SI UNITS

SYMBOL	WHEN YOU KNOW	MULTIPLY BY	TO FIND	SYMBOL
LENGTH				
in	inches	25.4	millimeters	mm
ft	feet	0.305	meters	m
yd	yards	0.914	meters	m
mi	miles	1.61	kilometers	km
SYMBOL	WHEN YOU KNOW	MULTIPLY BY	TO FIND	SYMBOL
AREA				
in ²	squareinches	645.2	square millimeters	mm ²
ft ²	squarefeet	0.093	square meters	m ²
yd ²	square yard	0.836	square meters	m ²
ac	acres	0.405	hectares	ha
mi ²	square miles	2.59	square kilometers	km ²
SYMBOL	WHEN YOU KNOW	MULTIPLY BY	TO FIND	SYMBOL
VOLUME				
fl oz	fluid ounces	29.57	milliliters	mL
gal	gallons	3.785	liters	L
ft ³	cubic feet	0.028	cubic meters	m ³
yd ³	cubic yards	0.765	cubic meters	m ³
NOTE: volumes greater than 1000 L shall be shown in m ³				
SYMBOL	WHEN YOU KNOW	MULTIPLY BY	TO FIND	SYMBOL
MASS				
oz	ounces	28.35	grams	g
lb	pounds	0.454	kilograms	kg
T	short tons (2000 lb)	0.907	megagrams (or "metric ton")	Mg (or "t")
SYMBOL	WHEN YOU KNOW	MULTIPLY BY	TO FIND	SYMBOL
TEMPERATURE (exact degrees)				
°F	Fahrenheit	5 (F-32)/9 or (F-32)/1.8	Celsius	°C
SYMBOL	WHEN YOU KNOW	MULTIPLY BY	TO FIND	SYMBOL
ILLUMINATION				
fc	foot-candles	10.76	lux	lx
fl	foot-Lamberts	3.426	candela/m ²	cd/m ²
SYMBOL	WHEN YOU KNOW	MULTIPLY BY	TO FIND	SYMBOL
FORCE and PRESSURE or STRESS				
lbf	poundforce	4.45	newtons	N
lbf/in ²	poundforce per square inch	6.89	kilopascals	kPa

APPROXIMATE CONVERSIONS TO ENGLISH UNITS

SYMBOL	WHEN YOU KNOW	MULTIPLY BY	TO FIND	SYMBOL
LENGTH				
mm	millimeters	0.039	inches	in
m	meters	3.28	feet	ft
m	meters	1.09	yards	yd
km	kilometers	0.621	miles	mi
SYMBOL	WHEN YOU KNOW	MULTIPLY BY	TO FIND	SYMBOL
AREA				
mm ²	square millimeters	0.0016	square inches	in ²
m ²	square meters	10.764	square feet	ft ²
m ²	square meters	1.195	square yards	yd ²
ha	hectares	2.47	acres	ac
km ²	square kilometers	0.386	square miles	mi ²
SYMBOL	WHEN YOU KNOW	MULTIPLY BY	TO FIND	SYMBOL
VOLUME				
mL	milliliters	0.034	fluid ounces	fl oz
L	liters	0.264	gallons	gal
m ³	cubic meters	35.314	cubic feet	ft ³
m ³	cubic meters	1.307	cubic yards	yd ³
SYMBOL	WHEN YOU KNOW	MULTIPLY BY	TO FIND	SYMBOL
MASS				
g	grams	0.035	ounces	oz
kg	kilograms	2.202	pounds	lb
Mg (or "t")	megagrams (or "metric ton")	1.103	short tons (2000 lb)	T
SYMBOL	WHEN YOU KNOW	MULTIPLY BY	TO FIND	SYMBOL
TEMPERATURE (exact degrees)				
°C	Celsius	1.8C+32	Fahrenheit	°F
SYMBOL	WHEN YOU KNOW	MULTIPLY BY	TO FIND	SYMBOL
ILLUMINATION				
lx	lux	0.0929	foot-candles	fc
cd/m ²	candela/m ²	0.2919	foot-Lamberts	fl
SYMBOL	WHEN YOU KNOW	MULTIPLY BY	TO FIND	SYMBOL
FORCE and PRESSURE or STRESS				
N	newtons	0.225	poundforce	lbf
kPa	kilopascals	0.145	poundforce per square inch	lbf/in ²

*SI is the symbol for the International System of Units. Appropriate rounding should be made to comply with Section 4 of ASTM E380.(Revised March 2003)

Technical Report Documentation Page

1. Report No. BD 545-34		2. Government Accession No.		3. Recipient's Catalog No.	
4. Title and Subtitle IMPROVEMENTS IN DESIGN SCOUR DEPTH PREDICTION				5. Report Date December 2006	
				6. Performing Organization Code UF NO.: 00051996	
7. Author(s) D. Max Sheppard				8. Performing Organization Report No.	
9. Performing Organization Name and Address Department of Civil and Coastal Engineering 365 Weil Hall University of Florida Gainesville, Florida 32611				10. Work Unit No. (TR AIS)	
				11. Contract or Grant No. BC-545, RPWO # 34	
12. Sponsoring Agency Name and Address Florida Department of Transportation 605 Suwannee Street, MS 30 Tallahassee, FL 32399				13. Type of Report and Period Covered Final Report 10/13/2004 – 12/31//2006	
				14. Sponsoring Agency Code	
15. Supplementary Notes					
16. Abstract Local sediment scour experiments were performed and the results analyzed and compared with predictions. It was determined that for partially buried pile caps the effect of the column on the scour produced by the pile cap was significant and had to be included in the predictive equations scour at complex piers. Modification to the predictive equations were made and are included in this report.					
17. Key Word Erosion, laboratory testing, flume				18. Distribution Statement	
19. Security Classif. (of this report)	20. Security Classif. (of this page)	21. No. of Pages 64	22. Price		

TABLE OF CONTENTS

Facilities	2
Instrumentation	4
Experimental Procedure	4
Pre-experiment	4
During experiment	5
Post-experiment	5
Test Structures	5
Scour Test Description	8
Experimental Data	12
Scour Test 1	12
Scour Test 2	18
Scour Test 3	23
Scour Test 4	27
Scour Test 5	30
Scour Test 6	34
Scour Test 7	37
Data analysis	41
Discussion of Model Test Results	49
Existing Complex Pier Scour Equations:	50

LIST OF FIGURES

Figure 1	University of Auckland Engineering Building where the Hydraulics Laboratory and the flume used for the live bed scour experiments are located.	2
Figure 2	Side and top views of the 5 ft wide, 4 ft deep, 148 ft long flume used for the local scour tests	3
Figure 3	Water (left picture) and sediment (right picture) return entrance sections	3
Figure 4	Schematic Diagram of Flume Used to Conduct Local Scour Tests.	4
Figure 5	Diagram of Complex Pier 1.	6
Figure 6	Diagram of Complex Pier 2.	6
Figure 7	Diagram of Complex Pier 3	6
Figure 8	Diagram of Complex Pier 4.	7
Figure 9	Diagram of Complex Pier 5.	7
Figure 10	Plan and Elevation Views of Test 1 Set-Up (Pier 1).	8
Figure 11	Plan and Elevation Views of Test 2 Set-Up (Pier 1).	9
Figure 12	Plan View of Test 3 Set-Up (Pier 2).	9
Figure 13	Plan View of Test 4 Set-Up (Pier 3).	10
Figure 14	Plan View of Test 5 Set-Up (Pier 3).	10
Figure 15	Plan View of Test 6 Set-Up (Pier 4).	11
Figure 16	Plan and Elevation Views of Test 7 Set-Up (Pier 5).	12
Figure 17	Typical Velocity Profile Upstream of Model Structure.	13
Figure 18	Side View of Pier Showing Front Face Transponder Location.	14
Figure 19	Pre Scour Test 1 Photograph Taken from the Down Stream Side.	14
Figure 20	Pre Scour Test 1 Photograph Taken From Upstream.	15
Figure 21	Post Scour Test 1 Photograph Taken From Upstream.	15
Figure 22	Post Scour Test 1 Photograph Taken From the Side.	16
Figure 23	Post Scour Test 1 Photograph Taken From Above and Downstream.	16
Figure 24	Post Scour Test 1 Photograph Taken From Upstream.	17
Figure 25	Time History of Scour Depth during Test 1 (Outer Transponder Data).	17
Figure 26	Pre Scour Test 2 Photograph Taken From Downstream.	18
Figure 27	Pre Scour Test 2 Photograph Taken From the Side of the Pier.	19
Figure 28	Pre Scour Test 2 Photograph Taken From Upstream.	19
Figure 29	Post Scour Test 2 Photograph Taken From Above and Upstream.	20

Figure 30	Post Scour Test 2 Photograph Taken From Above and the Side.	20
Figure 31	Post Scour Test 2 Photograph Taken From Above and Downstream.	21
Figure 32	Post Scour Test 2 Photograph Taken From Above and Upstream.	22
Figure 33	Time History of Scour Depth during Test 2 (Outer Transponder Data).	23
Figure 34	Post Scour Test 3 Photograph Showing Inner and Outer Transponder Locations.	24
Figure 35	Post Scour Test 3 Photograph Taken From Upstream.	24
Figure 36	Post Scour Test 3 Photograph Taken From the Side of the Pier.	25
Figure 37	Post Scour Test 3 Photograph of the Downstream Bed.	25
Figure 38	Post Scour Test 3 Photograph of the Overall Scour Hole.	26
Figure 39	Time History of the Test 3 Scour Depth as Measured by the Inner and Outer Transponders.	26
Figure 40	Pre Scour Test 4 Photograph Showing Inner and Outer Transponder.	27
Figure 41	Post Scour Test 4 Photograph Taken From Upstream.	28
Figure 42	Post Scour Test 4 Photograph Taken From the Side of the Pier.	28
Figure 43	Post Scour Test 4 Photograph Taken of the Downstream Bed.	29
Figure 44	Post Scour Test 4 Photograph of the Overall Scour Hole Taken From Upstream.	29
Figure 45	Time History of the Test 4 Scour Depth as Measured by the Inner and Outer Transponders. Note that sand waves of significant magnitude propagated through the test area during the test.	30
Figure 46	Pre Scour Test 5 Photograph Showing the Leading and Inner Transponder Locations.	31
Figure 47	Pre Scour Test 5 Photograph Taken From Upstream.	31
Figure 48	Post Scour Test 5 Photograph Taken From Upstream.	32
Figure 49	Post Scour Test 5 Photograph Taken From the Side of the Pier..	32
Figure 50	Post Scour Test 5 Photograph Taken From Above.	33
Figure 51	Time History of the Test 5 Scour Depth as Measured by the Leading and Mid Transponders.	33
Figure 52	Pre Scour Test 6 Photograph Showing Leading and Inner Transponder Locations.	34
Figure 53	Post Scour Test 6 Photograph Taken From Upstream.	35
Figure 54	Post Scour Test 6 Photograph Taken From the Side of the Pier.	35
Figure 55	Post Scour Test 6 Photograph Taken From Above.	36
Figure 56	Post Scour Test 6 Photograph Taken From Upstream.	36

Figure 57	Time History of the Test 6 Scour Depth as Measured by the Leading and Mid Transponders.	37
Figure 58	Post Scour Test 7 Photograph Taken From Upstream.	38
Figure 59	Post Scour Test 7 Photograph Taken From Upstream.	38
Figure 60	Post Scour Test 7 Photograph of the Downstream Bed.	39
Figure 61	Post Scour Test 7 Photograph Taken From Above.	39
Figure 62	Time History of the Test 7 Scour Depth as Measured by the Outer and Bottom Transponders.	40
Figure 63	Test 1 Time History of Scour Depth and Curve Fit to Data.	42
Figure 64	Test 2 Time History of Scour Depth and Curve Fit to Data.	42
Figure 65	Test 3 Time History of Scour Depth and Curve Fit to Data.	43
Figure 66	Test 4 Time History of Scour Depth and Curve Fit to Data.	43
Figure 67	Test 5 Time History of Scour Depth and Curve Fit to Data.	44
Figure 68	Test 6 Time History of Scour Depth and Curve Fit to Data. Note the presence of sand wave propagating through the test area. Due to the presence of sand waves the function used to fit the data is not as accurate during the earlier stages of the scour in this case.	44
Figure 69	Test 7 Time History of Scour Depth and Curve Fit to Data.	45
Figure 70	Test 1 Fit Curve Extrapolated to 500 hours.	45
Figure 71	Test 2 Fit Curve Extrapolated to 500 hours.	46
Figure 72	Test 3 Fit Curve Extrapolated to 500 hours.	46
Figure 73	Test 4 Fit Curve Extrapolated to 500 hours.	47
Figure 74	Test 5 Fit Curve Extrapolated to 500 hours.	47
Figure 75	Test 6 Fit Curve Extrapolated to 500 hours.	48
Figure 76	Exp 7 Extrapolated to 1000 hours	48
Figure 77	Predicted Versus Extrapolated Scour Depths	50
Figure 78	Experiments Performed by Sterling Jones at the FHWA Turner-Fairbanks Laboratory. All Experiments Performed with Column and Footer (no piles). Experiments 1, 5 and 10 were with buried footers. Experiment 9 is suspect.	51

LIST OF TABLES

Table 1	Experiment 1 Test Conditions	13
Table 2	Experiment 2 Test Conditions	18
Table 3	Experiment 3 Test Conditions	23
Table 4	Experiment 4 Test Conditions	27
Table 5	Experiment 5 Test Conditions	30
Table 6	Experiment 6 Test Conditions	34
Table 7	Experiment 7 Test Conditions	37
Table 8	Scour Experiment Summary	40
Table 9	Values of Curve Fit Coefficients for the 7 Tests.	49
Table 10	Equilibrium Scour Depths	49
Table 11	Predicted Versus Extrapolated Scour Depths	51

Executive Summary

A series of local sediment scour experiments with model complex bridge pier shapes were performed in the Hydraulics Laboratory at the University of Auckland in Auckland, New Zealand as part of this study. The experiments were designed to fill in voids in existing data for partially and fully buried pile caps and pile groups with different centerline spacings and orientations to the flow. The results from these tests were compared with scour depth predictions using the complex pier scour equations developed at the University of Florida and currently used by the Florida Department of Transportation. In the existing equations the impact of the pile cap on the contribution of the column to the total scour depth is taken into consideration. The effect of the column on the contribution of the pile cap to the total scour depth was not considered. This is thought to be one of the reasons the equations under predict equilibrium scour depths for the partially buried pile cap cases without pile groups. From the limited existing data it also appears that the existence of pile groups reduce the equilibrium scour depth, over what it would be for a column and pile cap (footer) alone. Current design practices in Florida do not allow for spread footers (without piles) at locations with erodable sediment. There are, however, a limited number of existing bridge piers of this configuration and therefore the FDOT complex pier scour equations must be modified to include this situation. Until this issue is resolved predicted scour depths (using the FDOT equations) for piers composed of a column and footer with the footer partially or fully buried should be multiplied by 1.35.

INTRODUCTION

Over the past decade great strides have been made in the ability to accurately predict design scour depths at simple bridge pier structures. Methodologies have also been developed for estimating design scour depths at piers with complex shapes. There are, however, areas where more analysis and more laboratory data are needed. This report addresses one of these areas, namely that associated with local scour at pile groups and buried pile caps. The additional data obtained during this study and its analysis has allowed improvements to be made to the complex pier scour prediction equations.

Many bridge piers are complex in shape, consisting of several components such as a column, pile cap and pile group. The arrangement of the piles in the group and the pile spacing can vary from pier to pier. This makes it difficult to develop scour prediction equations that will cover all situations. The flow field and sediment transport (scour) processes in the neighborhood of pile groups are very complex and thus defy analytical or (computer) computational analysis. Predictive equations must, therefore, rely heavily on laboratory data.

Local scour experiments were performed with pile groups, partially buried pile caps and completely buried pile caps in flumes located in the Hydraulics Laboratory at the University of Auckland in Auckland, New Zealand. This data was analyzed and the results incorporated into the complex pier local scour equations. The experiments are described in the following section followed by a results section. The final section presents the modifications to the complex pier scour equations.

Local Scour Experiments

Facilities

All of the tests were conducted in a 5 ft wide, 4 ft deep, 148 ft long, tilting flume, located in the Hydraulics Laboratory at the University of Auckland in Auckland, New Zealand. The flume has a maximum tilt of 1%. It has two pumps for recirculating the water with a combined capacity of 42 cfs and a sediment pump with adequate capacity. The bed load sediment (sediment moving along the bottom) is trapped and is pumped to the flume entrance with the sediment pump. Suspended sediment is pumped with the water to the entrance with either or both of the water pumps. A photograph of the building in which the flume is located is shown in Figure 1. Photographs of the flume are shown in Figure 2 and Figure 3. A schematic drawing of the flume is presented in Figure 4.



Figure 1 University of Auckland Engineering Building where the Hydraulics Laboratory and the flume used for the live bed scour experiments are located.



Figure 2 Side and top views of the 5 ft wide, 4 ft deep, 148 ft long flume used for the local scour tests



Figure 3 Water (left picture) and sediment (right picture) return entrance sections

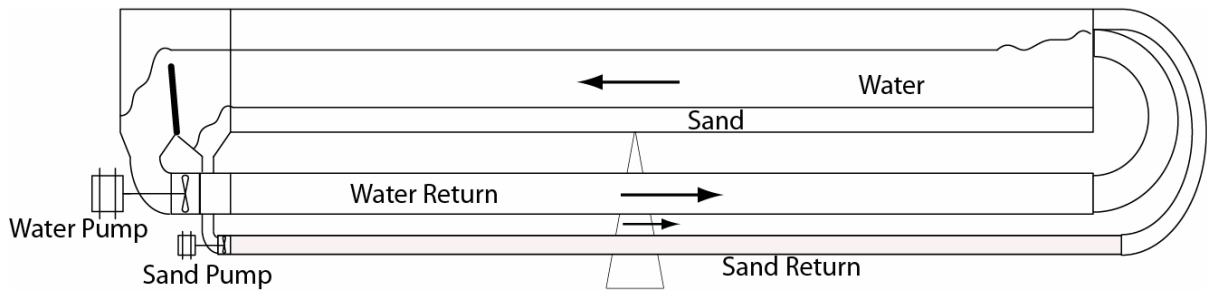

Figure 4 Schematic Diagram of Flume Used to Conduct Local Scour Tests.

Instrumentation

The instrumentation used in this research can be divided into two categories: 1) that which measures the flow parameters, and 2) that which measures scour depth. The flow parameters monitored were flow discharge (indirectly), velocity at specific locations, and water depth. The scour hole depth was monitored with high frequency acoustic transponders.

The scour hole depth was monitored with high frequency acoustic transponders.

Prior to starting the tests numerous vertical velocity profiles were measured and integrated to determine the flow discharge as a function of pump RPM (which can be precisely controlled). The velocity measurements were made with an acoustic Doppler velocimeter. During the tests the sectionally averaged velocity was estimated from the pump RPMs and the water depth at the section. The water depth at the test section was measured using scales attached to the glass walls of the flume.

Experimental Procedure

A summary of the experimental procedure used in performing the local sediment scour experiments is outlined below. The procedure is divided into the tasks performed before, during and after the experimental run.

Pre-experiment

- Compact and level the bed in the flume.
- Fill the flume slowly and allow to stand until the air trapped in the sediment has escaped.
- Take pre-experiment photographs.
- Check all instrumentation.

During experiment

- Measure the scour depth as a function of time with acoustic transponders and video cameras.
- Measure the velocity, water depth, and temperature.
- Monitor bed elevation at flume walls in test section with external video cameras.
- Monitor bed forms during live bed tests.

Post-experiment

- Take post-experiment photographs.
- Observe and note bed condition throughout the flume (presence of bed forms, etc.)
- Survey the scour hole with a point gauge.
- Reduce and analyze the data.

The University of Florida performed 7 clear-water scour experiments at the University of Auckland. The scour experiments were performed with a combination of piers including complex structures and inline pile bents. Local scour at partially and fully buried pile caps were examined. Inline pile bents were also tested with a variety of skew angles and centerline pile spacings. This is followed by a section describing the different piers employed for the scour experiments and a section showing the test setups for the seven experiments. The next section presents photographs of the scour and the measured data. This is followed by a description of how the equilibrium scour depths were obtained from the measured values. Finally, the results are discussed and compared with predicted values using current FDOT complex pier scour equations.

Test Structures

The four different piers tested in the University of Auckland flume and are illustrated in Figures 1-4. Two of the structures tested, Piers 1 and 5, consist of a column and pile cap but no pile group. Piers 2, 3, and 4 are comprised of four 2-inch inline circular piles. The piles are spaced 4 inches apart from their centerline for Pier 2, 6 inches for Pier 3, and 12 inches for Pier 4.

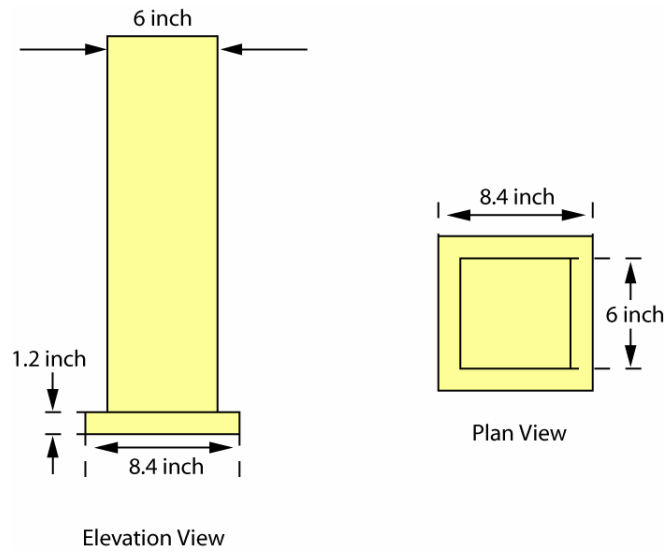

Figure 5 Diagram of Complex Pier 1.

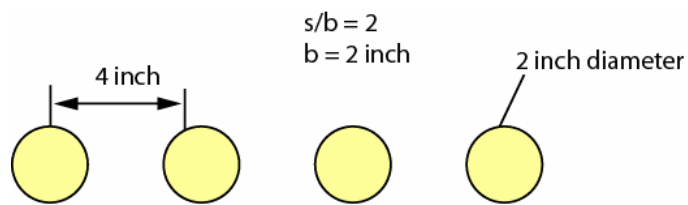

Figure 6 Diagram of Complex Pier 2.

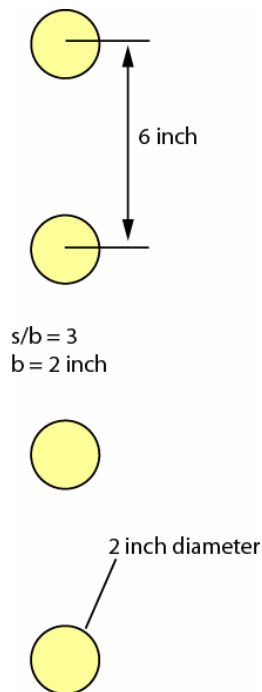
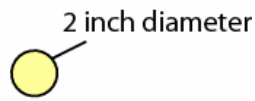
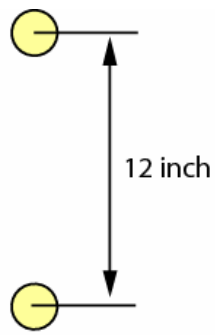

Figure 7 Diagram of Complex Pier 3



$s/b = 6$
 $b = 2$ inch



Figure 8 Diagram of Complex Pier 4.

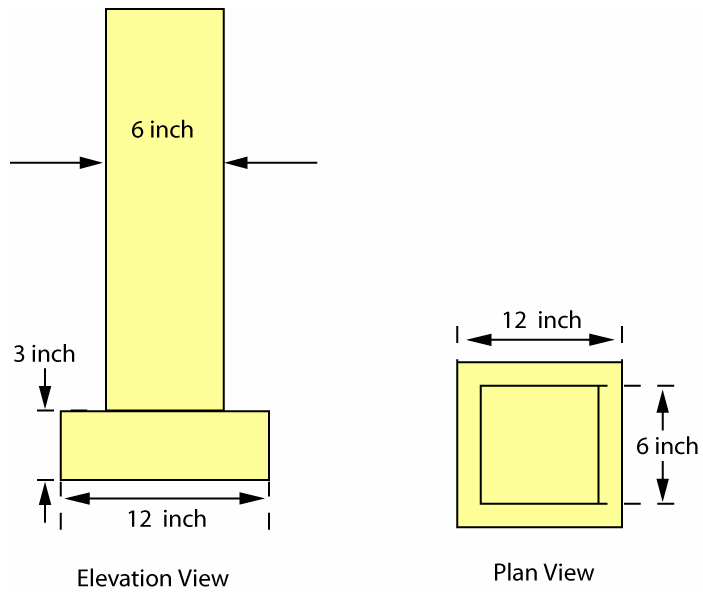

Figure 9 Diagram of Complex Pier 5.

Scour Test Description

Seven different scour experiments were performed for the five different piers discussed in the previous section. All of the scour experiments were performed in the clear-water scour regime. The first two scour tests were performed with Pier 1, as illustrated in Figures 10 and 11. The third scour experiment, Figure 12, employed Pier 2 with no skew angle. The pier was aligned so that it had 4 piles normal to the flow (four by one). The fourth scour experiment was performed with Pier 4 with no skew angle (Figure 13). The fifth scour experiment used Pier 3 at a 20 degree skew angle relative to the flow (Figure 14). The sixth scour test employed Pier 5 at a 20 degree skew angle similar to the fourth scour test (Figure 15). The final scour test, Test 7, employed Pier 5 in a partially buried configuration as illustrated in Figure 16.

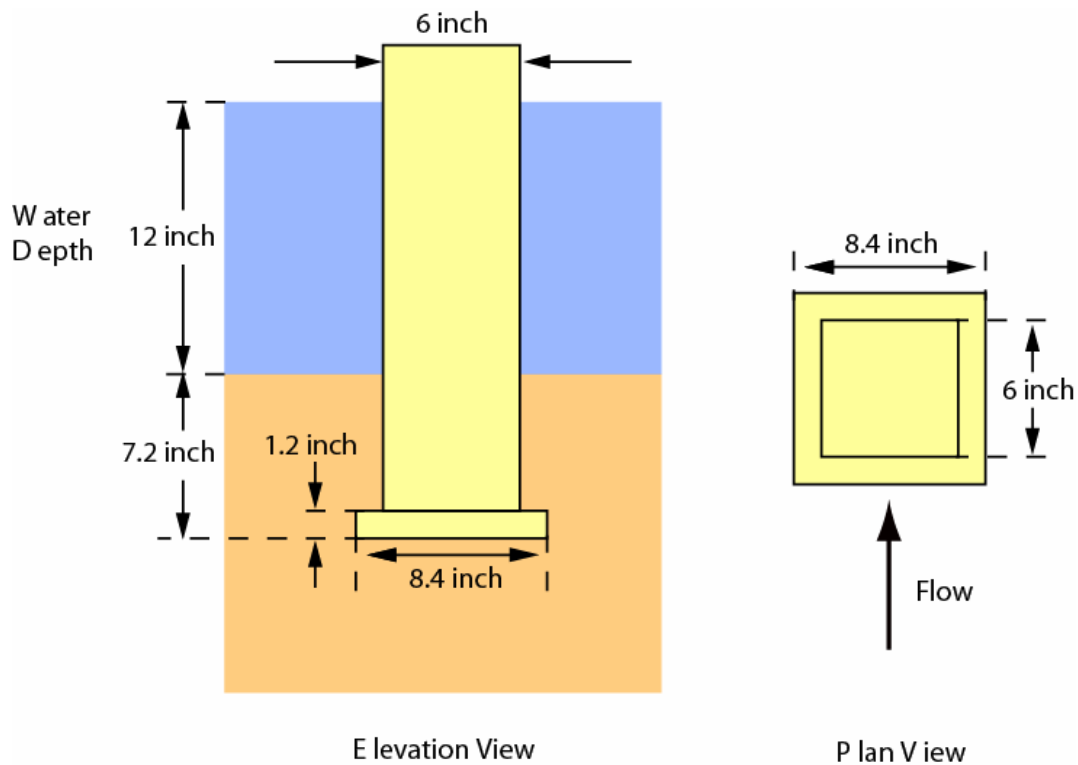

Figure 10 Plan and Elevation Views of Test 1 Set-Up (Pier 1).

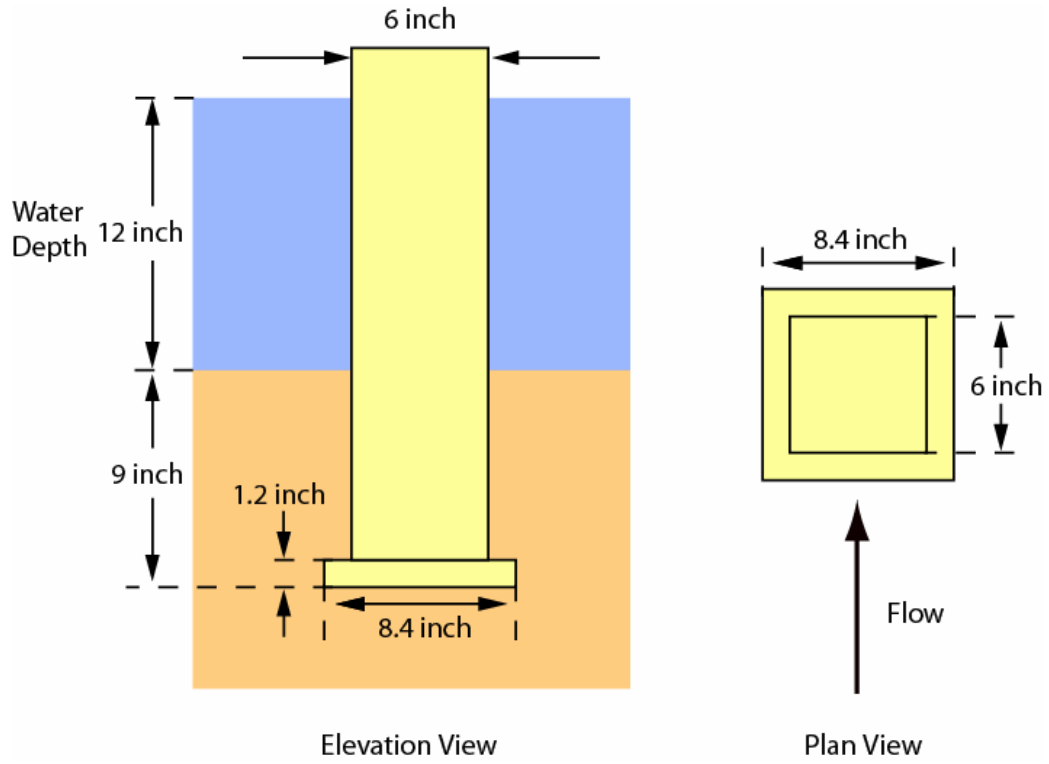

Figure 11 Plan and Elevation Views of Test 2 Set-Up (Pier 1).

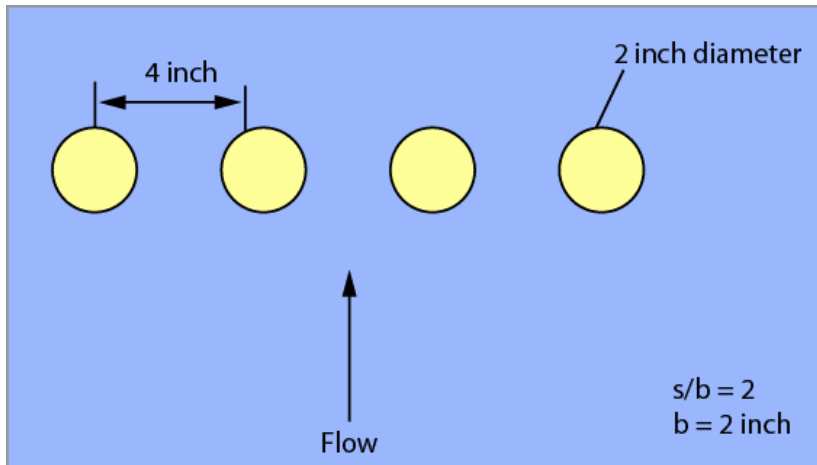

Figure 12 Plan View of Test 3 Set-Up (Pier 2).

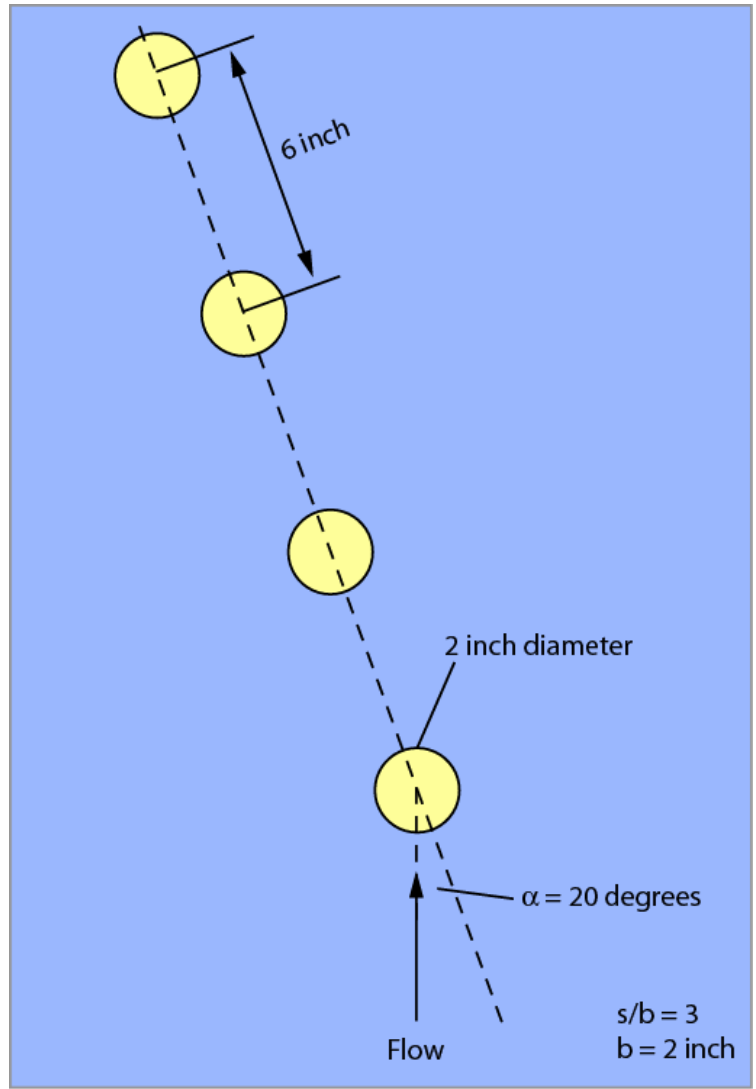

Figure 13 Plan View of Test 4 Set-Up (Pier 3).

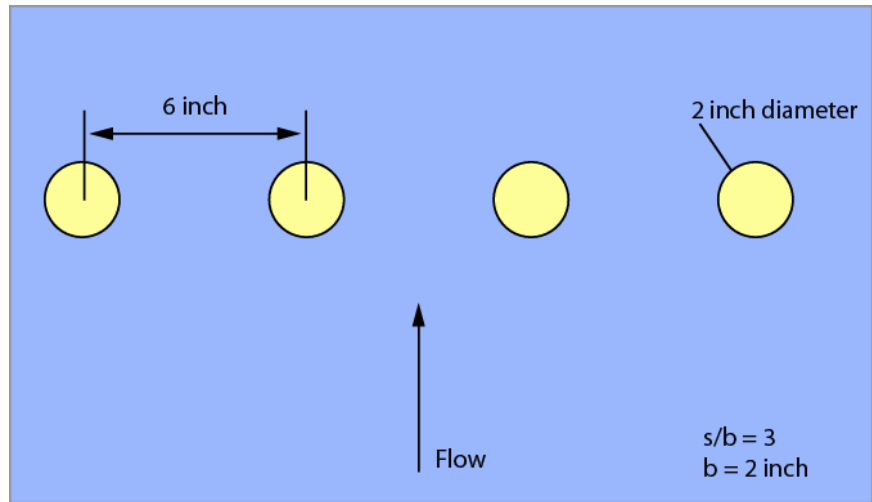

Figure 14 Plan View of Test 5 Set-Up (Pier 3).

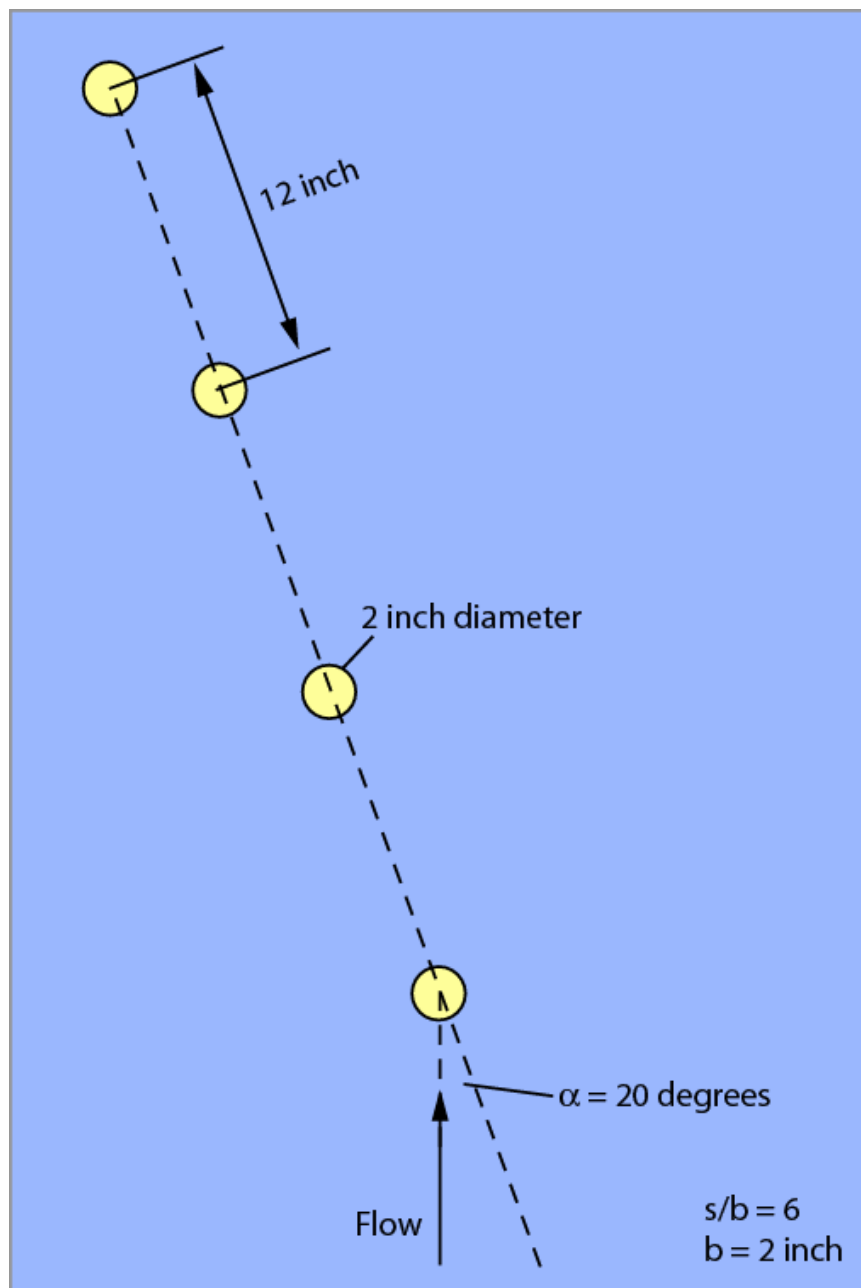

Figure 15 Plan View of Test 6 Set-Up (Pier 4).

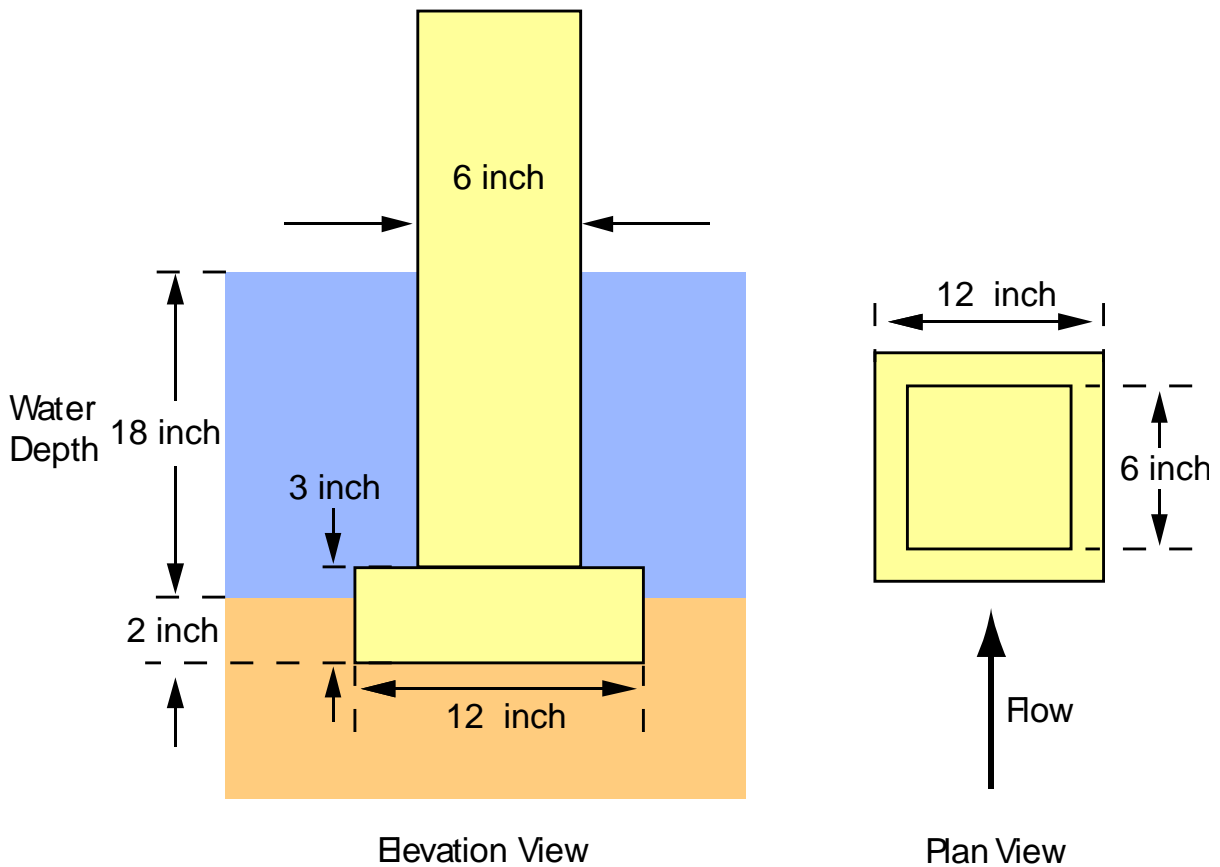

Figure 16 Plan and Elevation Views of Test 7 Set-Up (Pier 5).

Experimental Data

The seven scour experiments are described in this section. Most of the scour experiment descriptions include pre and post photographs of the experimental setup, scour rate plots, velocity measurements, and final scour depths. Each of the scour experiments are discussed in more detail below.

Scour Test 1

The first experiment was performed in a 1-ft water depth with Pier 1. Table 1 lists the experimental conditions during the scour test and the velocity profile measured during the experiment is shown in Figure 17. The bottom of the pile cap was positioned 7.2 inches below the pre-scoured bed and supported from above as illustrated in Figure 10. Scour depths were measured with two acoustic transponders. One was located on the upstream face of the structure as shown in Figure 18 and the other was located inside the pile cap so that once the scour undermined the pile cap, it could measure scour depths below the pile cap.

Figures 18-20 are photographs taken prior to starting the experiment. Figures 21-24 are photographs of the pier after the experiment was concluded. The scour depth as a function of time, measured by the external transponder is shown in Figure 25. The experiment ran for a total of 121.5 hours and the final measured scour depth for this test was 1.09 ft.

Table 1 Experiment 1 Test Conditions

Water Depth (ft)	Velocity (ft/s)	D ₅₀ (mm)	Pier Type	H _{pc} (inch)
1.0	1.05	0.84	1	-7.2

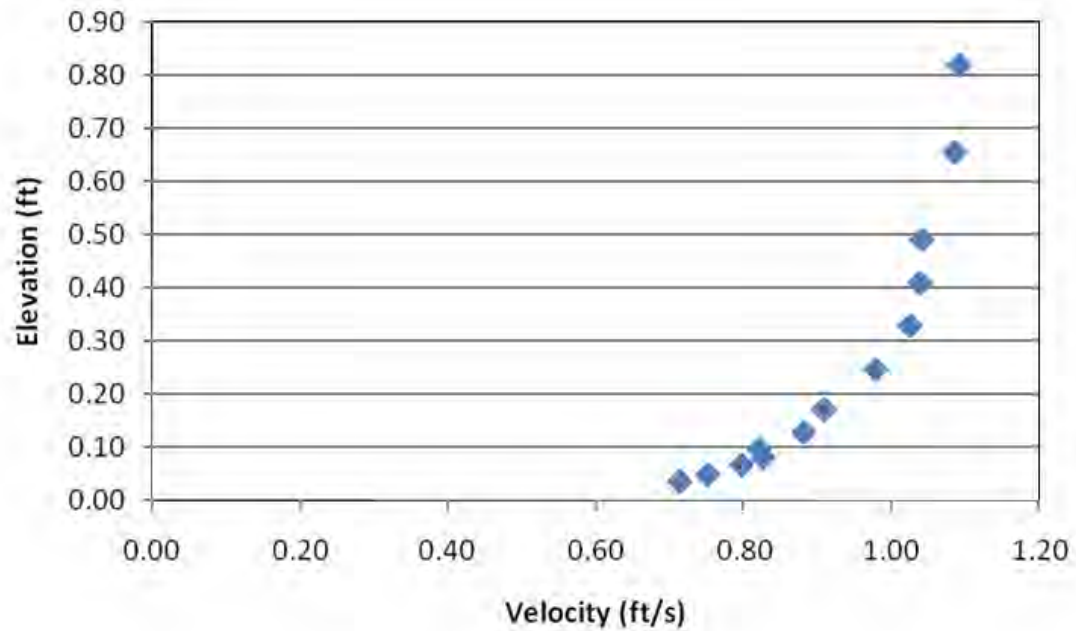

Figure 17 Typical Velocity Profile Upstream of Model Structure.



Figure 18 Side View of Pier Showing Front Face Transponder Location.



Figure 19 Pre Scour Test 1 Photograph Taken from the Down Stream Side.



Figure 20 Pre Scour Test 1 Photograph Taken From Upstream.



Figure 21 Post Scour Test 1 Photograph Taken From Upstream.



Figure 22 Post Scour Test 1 Photograph Taken From the Side.



Figure 23 Post Scour Test 1 Photograph Taken From Above and Downstream.



Figure 24 Post Scour Test 1 Photograph Taken From Upstream.

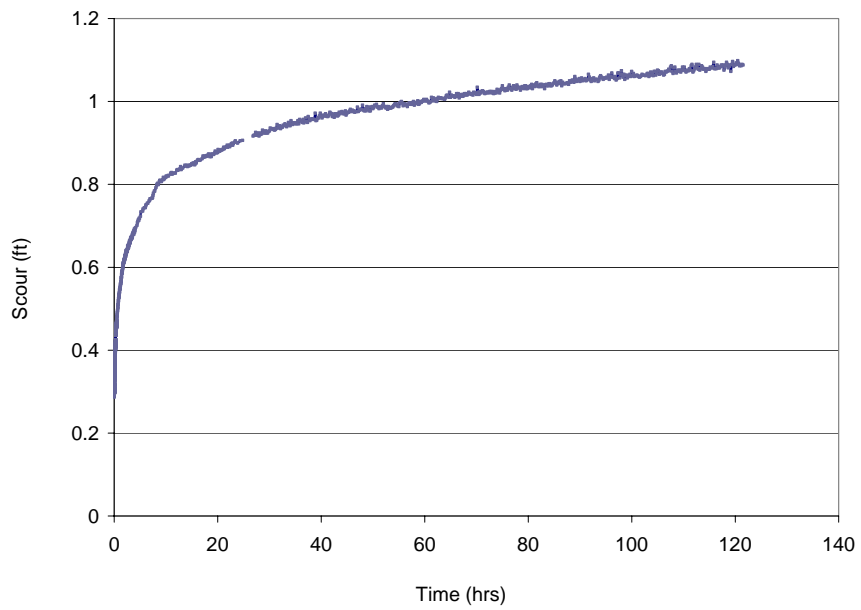

Figure 25 Time History of Scour Depth during Test 1 (Outer Transponder Data).

Scour Test 2

The second experiment was performed with a 1-ft water depth and Pier 1. Table 2 lists the conditions present during the test. The bottom of the pile cap was positioned 9 inches below the pre-scoured bed for this test and again suspended from above as illustrated in Figure 11. Figures 26-28 are photographs taken prior to starting the experiment. Figures 29-32 show the pier and scour hole after the experiment was concluded. Scour depth as a function of time is shown in Figure 33. The duration of the experiment was 160 hours and the final measured scour depth was 0.86 ft.

Table 2 Experiment 2 Test Conditions

Water Depth (ft)	Velocity (ft/s)	D ₅₀ (mm)	Pier Type	Hpc (inch)
1.0	1.00	0.84	1	-9.0



Figure 26 Pre Scour Test 2 Photograph Taken From Downstream.



Figure 27 Pre Scour Test 2 Photograph Taken From the Side of the Pier.



Figure 28 Pre Scour Test 2 Photograph Taken From Upstream.



Figure 29 Post Scour Test 2 Photograph Taken From Above and Upstream.



Figure 30 Post Scour Test 2 Photograph Taken From Above and the Side.



Figure 31 Post Scour Test 2 Photograph Taken From Above and Downstream.

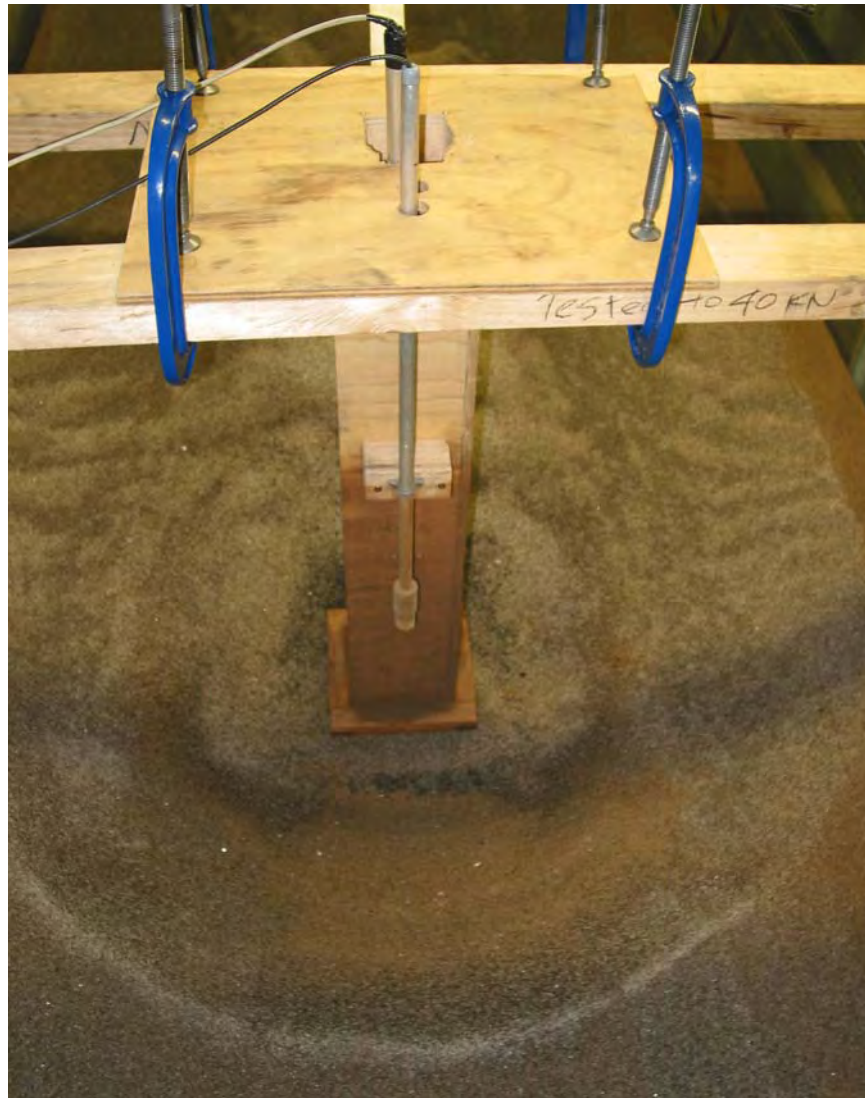

Figure 32 Post Scour Test 2 Photograph Taken From Above and Upstream.

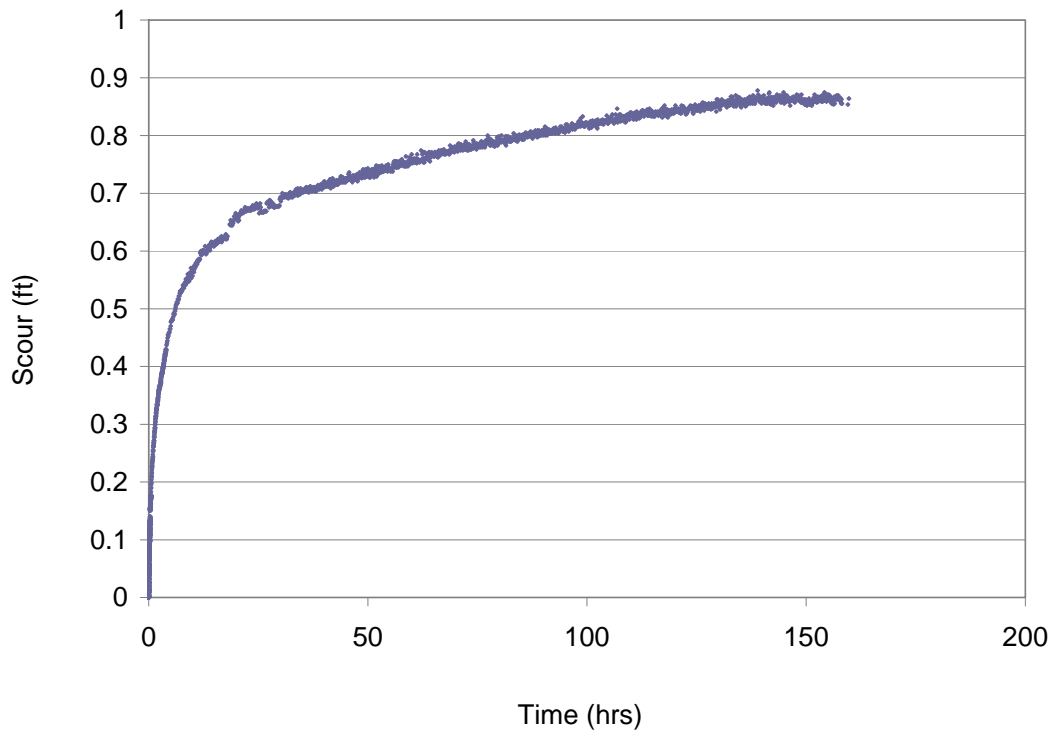

Figure 33 Time History of Scour Depth during Test 2 (Outer Transponder Data).

Scour Test 3

The third experiment was performed with a 1.5-ft water depth and Pier 2. The structure was oriented such that it had four piles normal to the flow as shown in Figure 12. Table 3 lists the conditions present during the test. The pile group was equipped with two acoustic transponders as shown in Figure 34. Figures 34-38 show the pier and surrounding bed after the experiment was concluded. The scour depths as functions of time, measured by the inner and outer transponders, are plotted in Figure 39. The experiment ran for a total of 105.5 hours and the final measured scour depth was 0.27 ft.

Table 3 Experiment 3 Test Conditions

Water Depth (ft)	Velocity (ft/s)	D ₅₀ (mm)	Pier Type
1.5	1.00	0.84	2

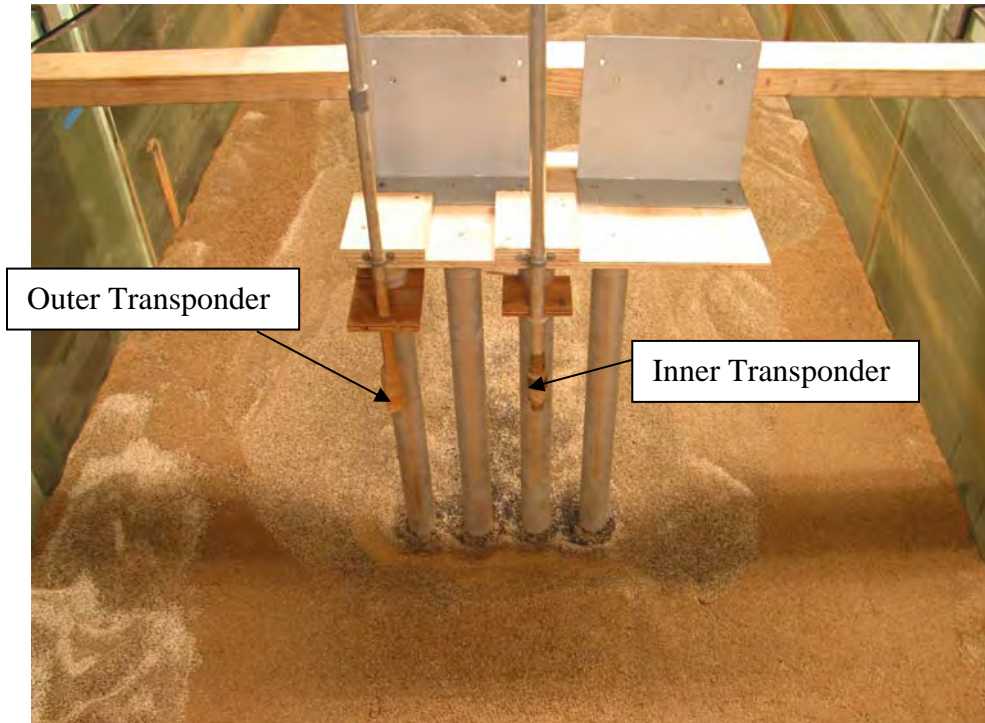

Figure 34 Post Scour Test 3 Photograph Showing Inner and Outer Transponder Locations.



Figure 35 Post Scour Test 3 Photograph Taken From Upstream.



Figure 36 Post Scour Test 3 Photograph Taken From the Side of the Pier.



Figure 37 Post Scour Test 3 Photograph of the Downstream Bed.



Figure 38 Post Scour Test 3 Photograph of the Overall Scour Hole.

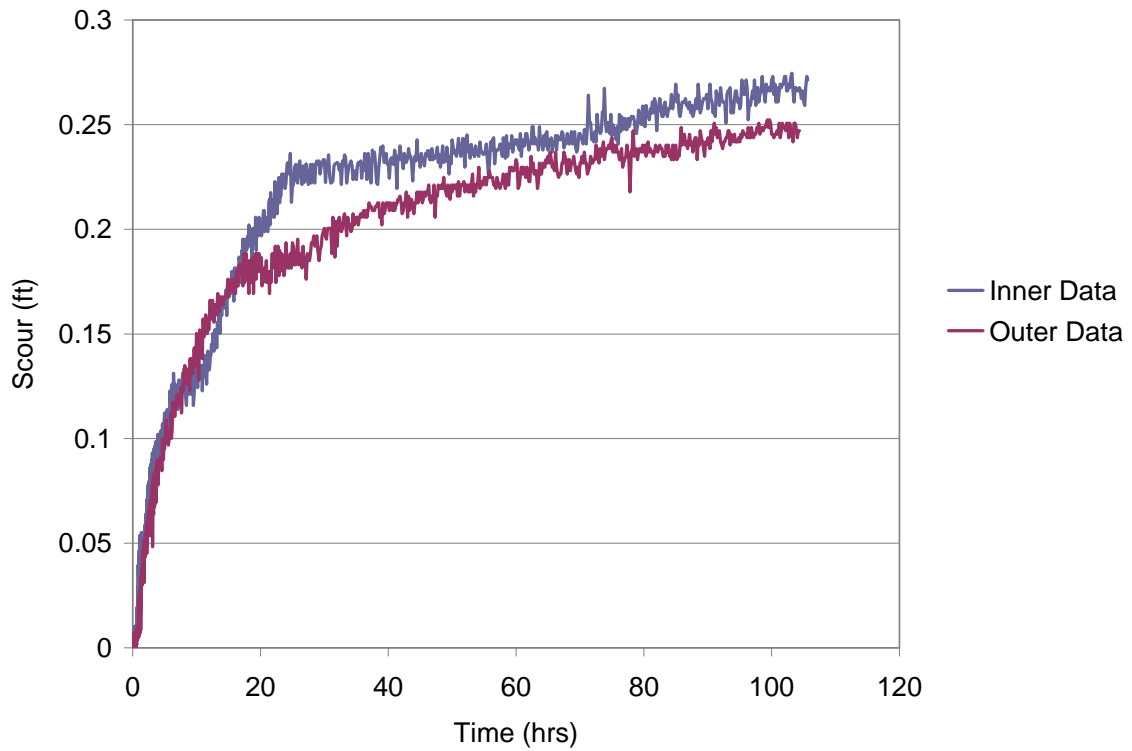

Figure 39 Time History of the Test 3 Scour Depth as Measured by the Inner and Outer Transponders.

Scour Test 4

The fourth experiment was performed with a 1.5-ft water depth and Pier 3. Table 4 lists the conditions present during the test. Test 4 was similar to Test 3 except the centerline spacing to pile diameter was 3 instead of 2 (see Figure 13). The pile group was equipped with two acoustic transponders as shown in Figure 40. Figures 41-44 show the pier and surrounding bed after the experiment was concluded. The scour depths as functions of time, measured by the inner and outer transponders are plotted in Figure 45. The experiment ran for a total of 167 hours and the final measured scour depth was 0.24 ft.

Table 4 Experiment 4 Test Conditions

Water Depth (ft)	Velocity (ft/s)	D ₅₀ (mm)	Pier Type
1.5	1.00	0.84	3

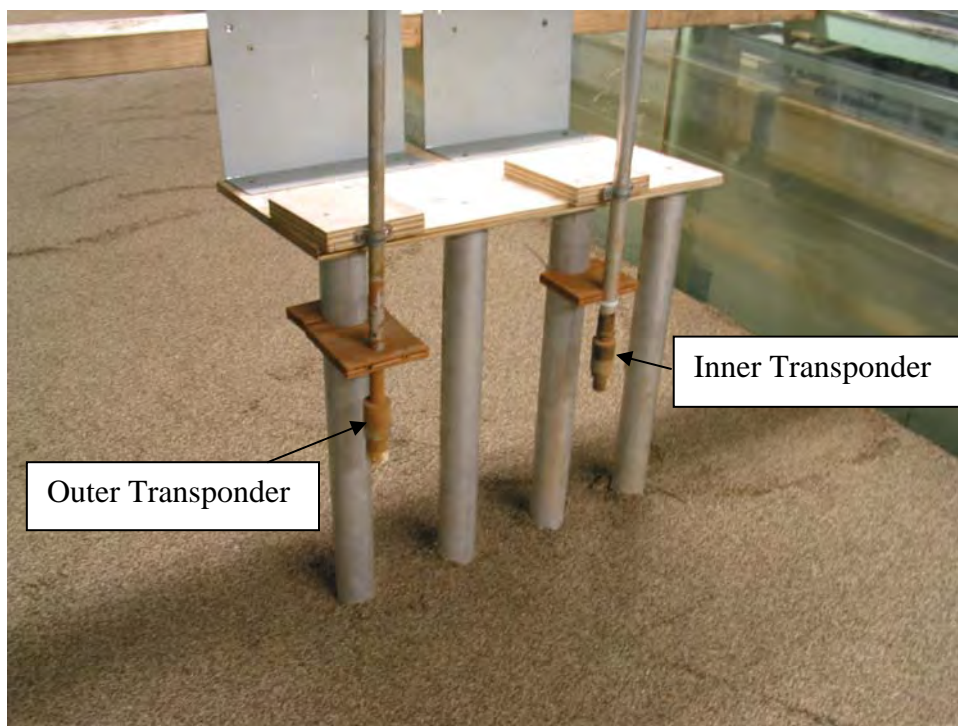

Figure 40 Pre Scour Test 4 Photograph Showing Inner and Outer Transponder.



Figure 41 Post Scour Test 4 Photograph Taken From Upstream.



Figure 42 Post Scour Test 4 Photograph Taken From the Side of the Pier.



Figure 43 Post Scour Test 4 Photograph Taken of the Downstream Bed.



Figure 44 Post Scour Test 4 Photograph of the Overall Scour Hole Taken From Upstream.

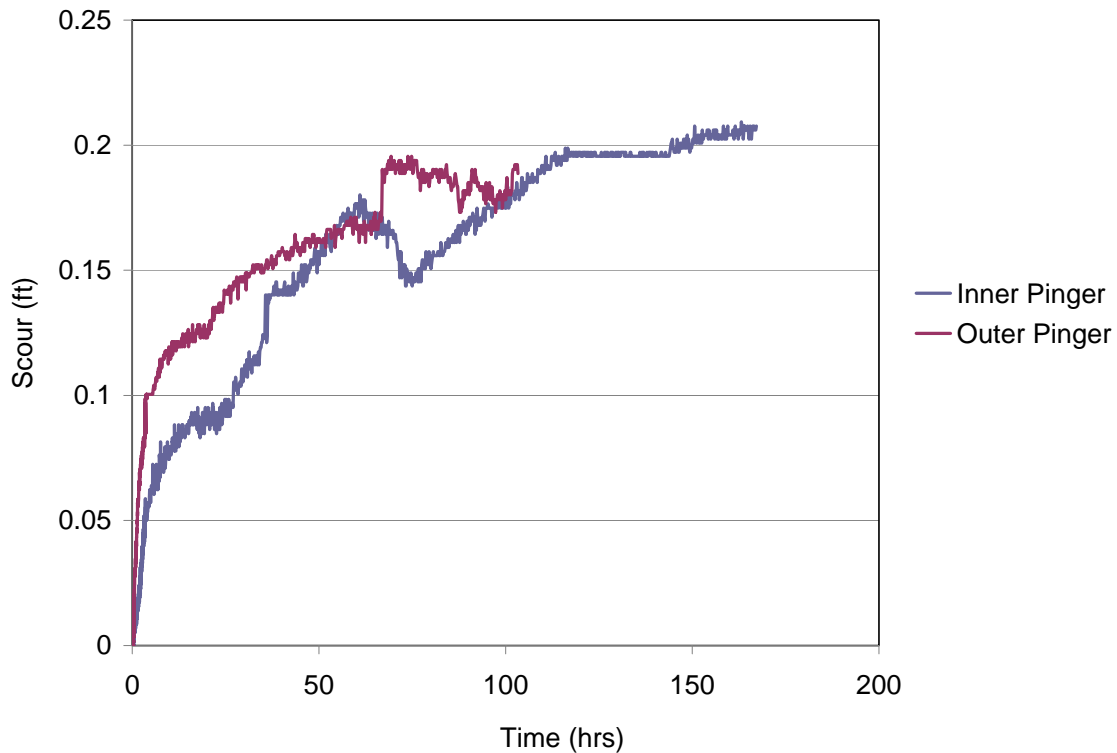

Figure 45 Time History of the Test 4 Scour Depth as Measured by the Inner and Outer Transponders. Note that sand waves of significant magnitude propagated through the test area during the test.

Scour Test 5

The fifth experiment was performed with a 1.5-ft water depth and Pier 4. The structure was oriented at a 20 degree skew angle to the flow as shown in Figure 14. Table 5 lists the conditions present during the test. The pile group was equipped with two acoustic transponders as shown in Figure 46. Figure 47 shows the pier from the front prior to the start of the test. Figures 48-50 show the pier and surrounding bed after the experiment was concluded. Scour depths as functions of time, measured by the leading and inner transponders are given in Figure 51. The experiment ran for a total of 150 hours and the final measured scour depth was 0.28 ft.

Table 5 Experiment 5 Test Conditions

Water Depth (ft)	Velocity (ft/s)	D ₅₀ (mm)	Pier Type
1.5	1.00	0.84	4

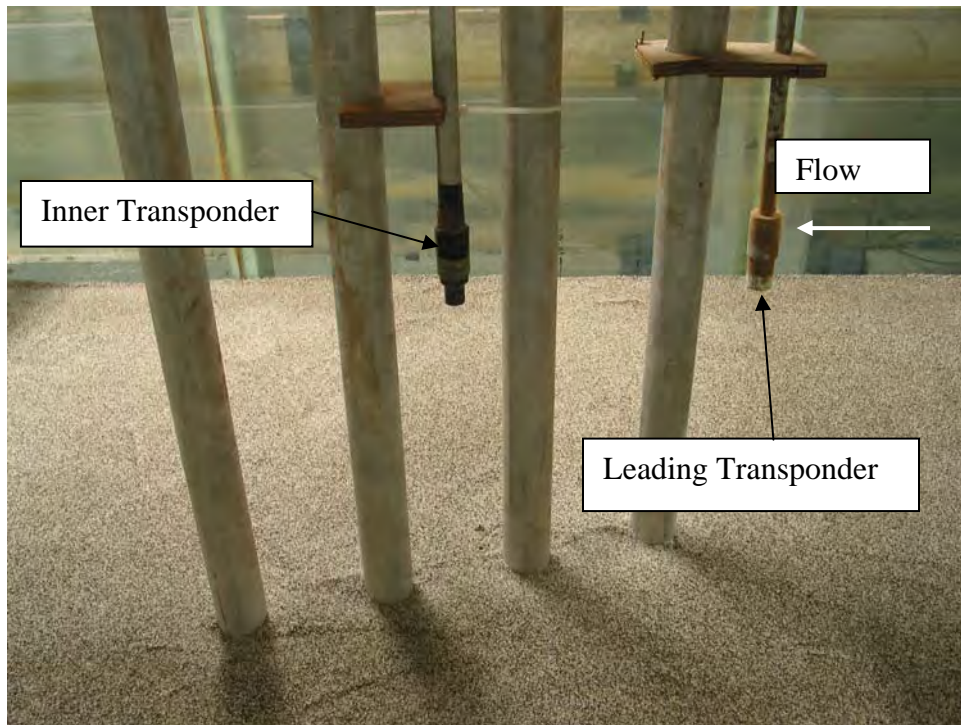

Figure 46 Pre Scour Test 5 Photograph Showing the Leading and Inner Transponder Locations.



Figure 47 Pre Scour Test 5 Photograph Taken From Upstream.



Figure 48 Post Scour Test 5 Photograph Taken From Upstream.



Figure 49 Post Scour Test 5 Photograph Taken From the Side of the Pier..



Figure 50 Post Scour Test 5 Photograph Taken From Above.

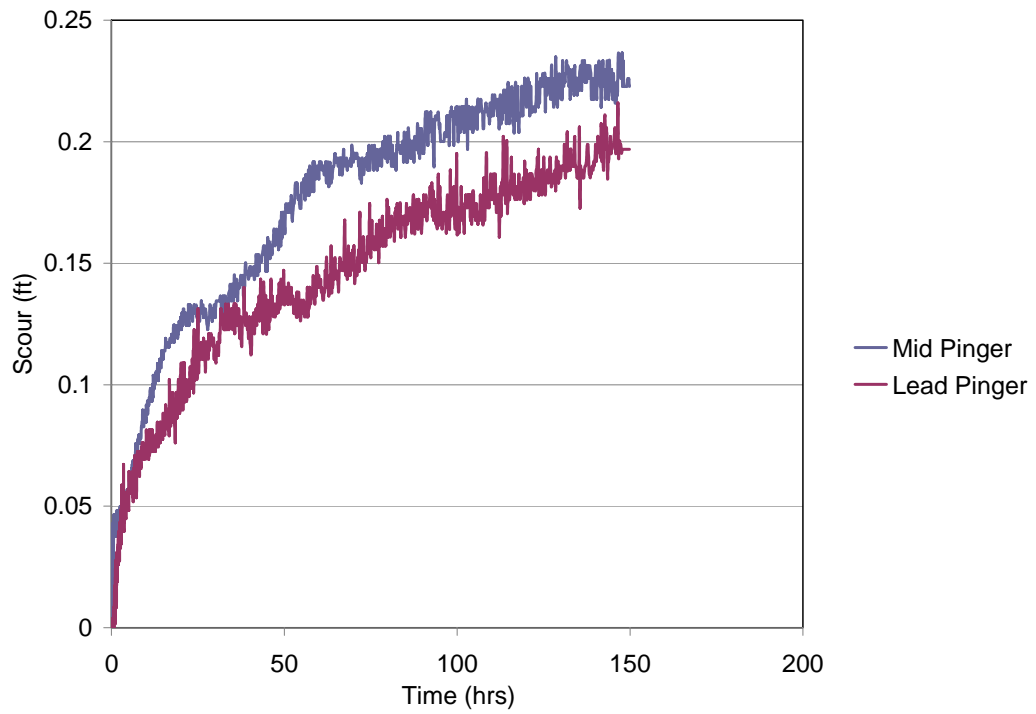

Figure 51 Time History of the Test 5 Scour Depth as Measured by the Leading and Mid Transponders.

Scour Test 6

The sixth experiment was performed with a 1-ft water depth and Pier 4. The structure was skewed 20 degrees to the flow as illustrated in Figure 15. Table 6 lists the conditions present during the test. The pile group was equipped with two acoustic transponders as shown in Figure 52. Figures 53-56 show the pier and surrounding bed after the experiment was concluded. The scour depths as functions of time, measured by the leading and inner transponders, are plotted in Figure 57. The experiment ran for a total of 242 hours and the final measured scour depth was 0.21 ft.

Table 6 Experiment 6 Test Conditions

Water Depth (ft)	Velocity (ft/s)	D ₅₀ (mm)	Pier Type
1.0	1.00	1.0	5

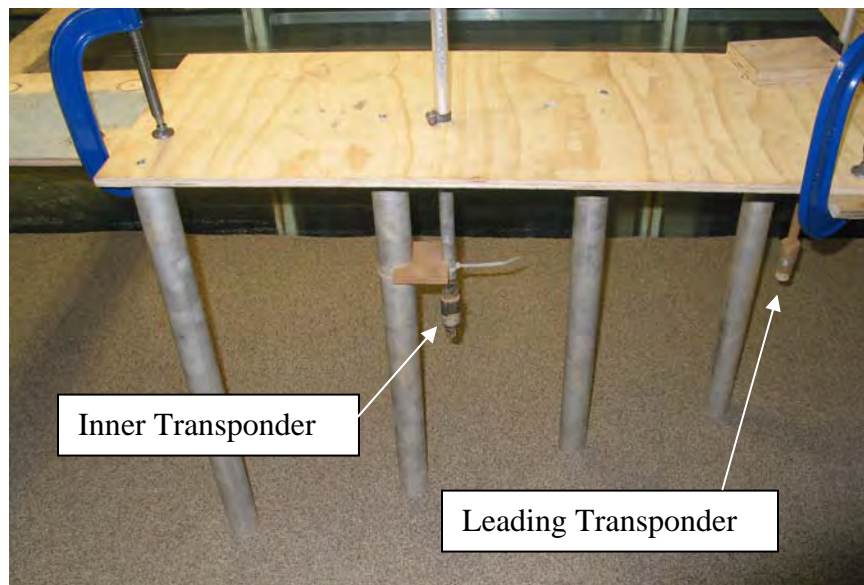

Figure 52 Pre Scour Test 6 Photograph Showing Leading and Inner Transponder Locations.



Figure 53 Post Scour Test 6 Photograph Taken From Upstream.



Figure 54 Post Scour Test 6 Photograph Taken From the Side of the Pier.



Figure 55 Post Scour Test 6 Photograph Taken From Above.



Figure 56 Post Scour Test 6 Photograph Taken From Upstream.

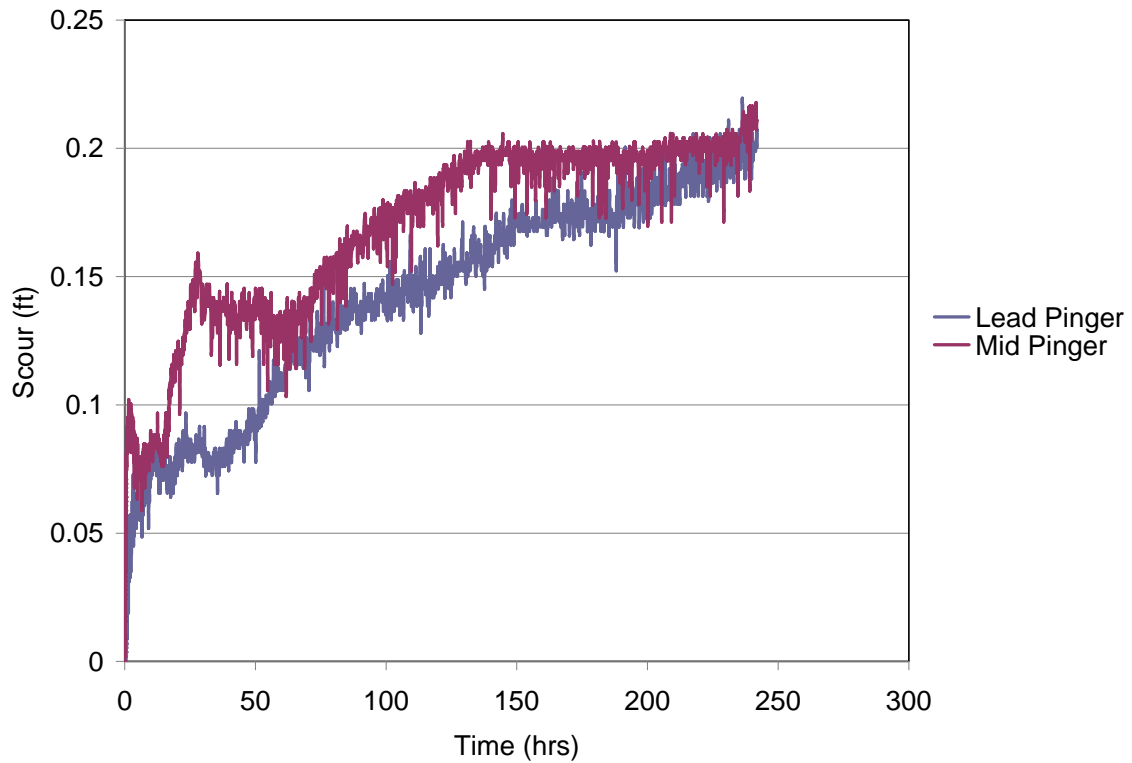

Figure 57 Time History of the Test 6 Scour Depth as Measured by the Leading and Mid Transponders.

Scour Test 7

The seventh experiment was performed in a 1-ft water depth with Pier 5. The bottom of the pile cap was positioned 2 inches below the surface as illustrated in Figure 16. Table 7 lists the conditions present during the test. The complex pier was equipped with two acoustic transponders, one in the front and another under the pile cap. Figures 58-61 show the pier and surrounding bed after the experiment was concluded. Scour depths as functions of time, measured by the inner and outer transponders are shown in Figure 62. The experiment ran for a total of 287 hours and the final measured scour depth for this test was 0.76 ft.

Table 7 Experiment 7 Test Conditions

Water Depth (ft)	Velocity (ft/s)	D ₅₀ (mm)	Pier Type
1.0	1.00	1.0	6



Figure 58 Post Scour Test 7 Photograph Taken From Upstream.



Figure 59 Post Scour Test 7 Photograph Taken From Upstream.



Figure 60 Post Scour Test 7 Photograph of the Downstream Bed.



Figure 61 Post Scour Test 7 Photograph Taken From Above.

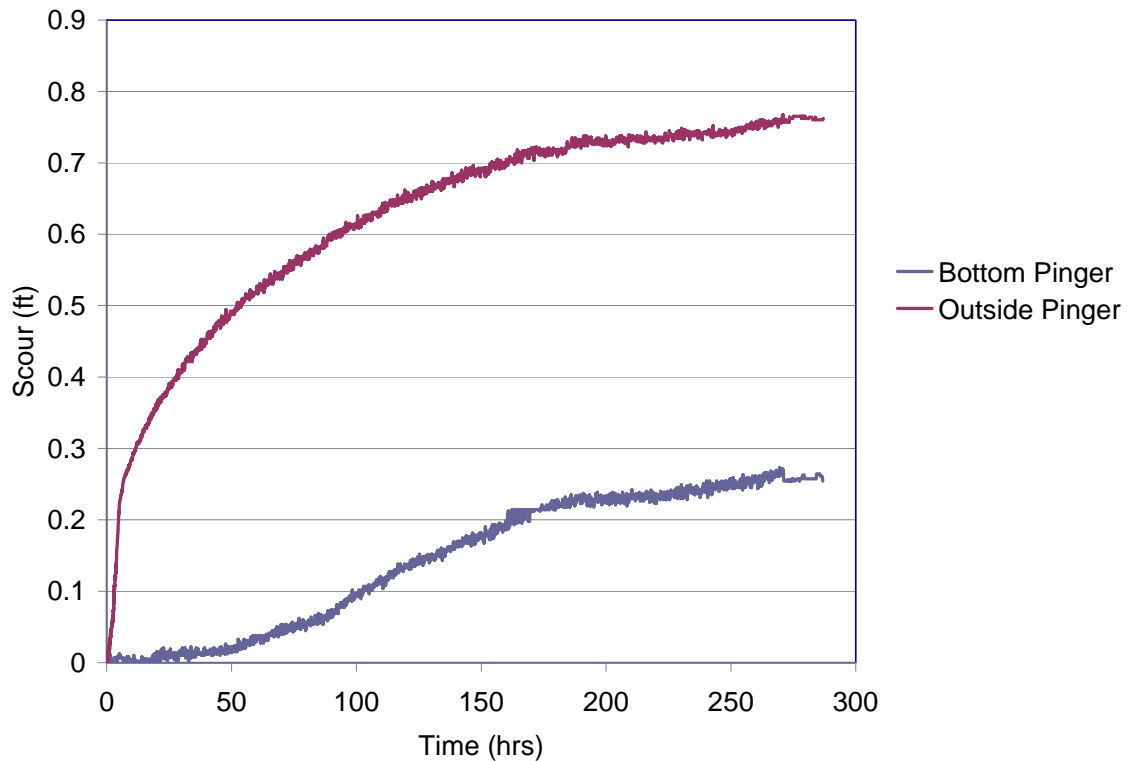

Figure 62 Time History of the Test 7 Scour Depth as Measured by the Outer and Bottom Transponders.

The results for all seven scour experiments are summarized in Table 8. Experiment 1 was performed with a depth averaged flow velocity of 1.05 ft/s. All remaining tests were performed with a depth averaged velocity of 1.0 ft/s. Sand waves appeared upstream of the test structures in Tests 1, 3, 4, 5, and 6. The sand waves appear to have propagated into the scour hole for some of the tests. No sand waves were observed in the vicinity of the structure in Test 7.

Table 8 Scour Experiment Summary

Test #	Duration (hrs)	Depth (ft)	Velocity (ft/s)	Transponder scour (ft)
1	121.5	1.0	1.05	1.09
2	160	1.0	1.00	0.86
3	105.5	1.0	1.00	0.33
4	167	1.0	1.00	0.24
5	150	1.0	1.00	0.28
6	242	1.0	1.00	0.28
7	287	1.0	1.00	0.76

Data analysis

The scour depths presented in Table 8 represent the maximum scour depth measured by one of the transponders. Since clear-water scour progresses at a slow rate the time required to reach an equilibrium depth is longer than the test duration. In order to determine equilibrium depths, the transponder data had to be extrapolated using Equation 1. Both Jones and Sheppard have used Equation 1 to obtain equilibrium depths for limited duration clear-water scour tests.

$$y_s = a \left(1 - \frac{1}{1 + abx} \right) + c \left(1 - \frac{1}{1 + cdx} \right) \quad (1)$$

where,

a, b, c, and d are coefficients used to obtain the best fit to the data.

The results of fitting Equation 1 to the measured transponder data are presented in Figures 63-69. The coefficients employed for the individual fits are listed in Table 9. The plots indicate that the equations fit the measured data well. Note that due to the presence of sand waves early in Test 6 (Figure 64) the curve fit is not as good as for the other tests. A better fit at the earlier stages of this test would result in a less accurate fit as time progresses and an unrealistic extrapolated equilibrium value. Equilibrium scour depths were determined by extrapolating the curves out to time equal infinity. Figures 70-75 show extrapolations to 500 hours and Figure 76 an extrapolation to 1000 hours. The estimated equilibrium scour depths are given in Table 10 along maximum measured scour depths, and the percent difference between the two. The difference between the measured scour depths and the extrapolated scour depths range from 5% for experiment 2 and 3 up to 24% for experiment 6.

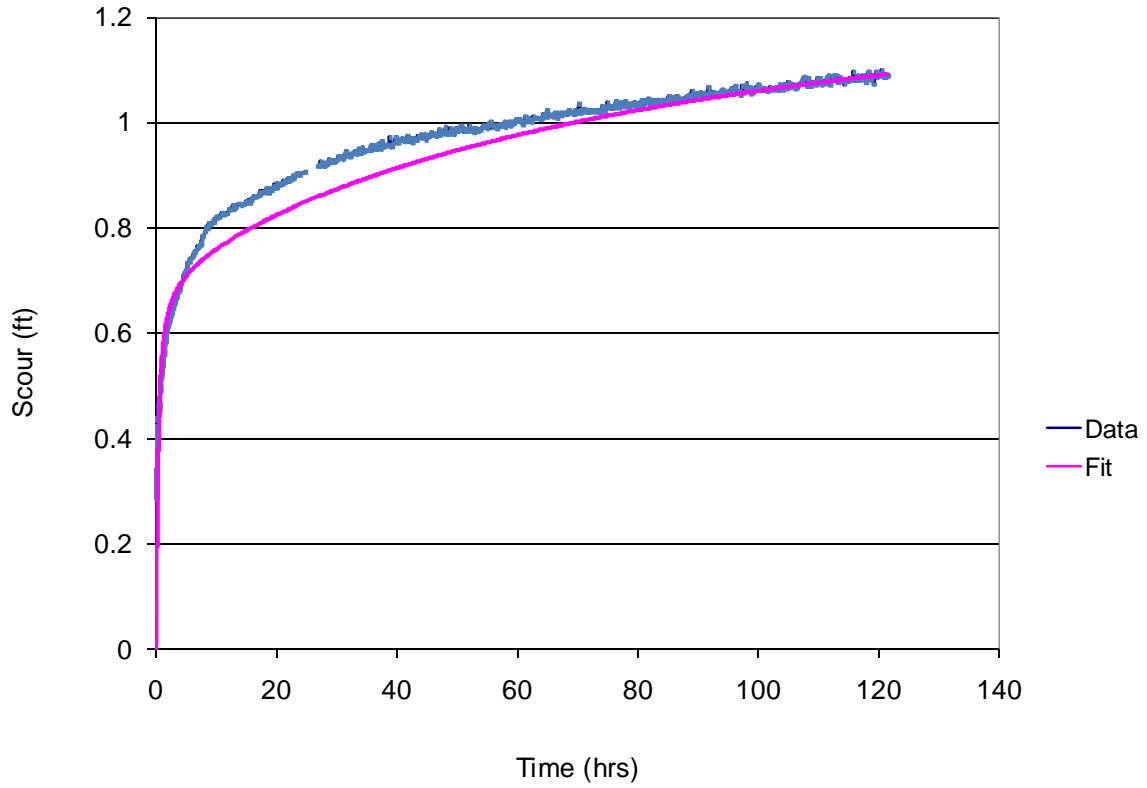

Figure 63 Test 1 Time History of Scour Depth and Curve Fit to Data.

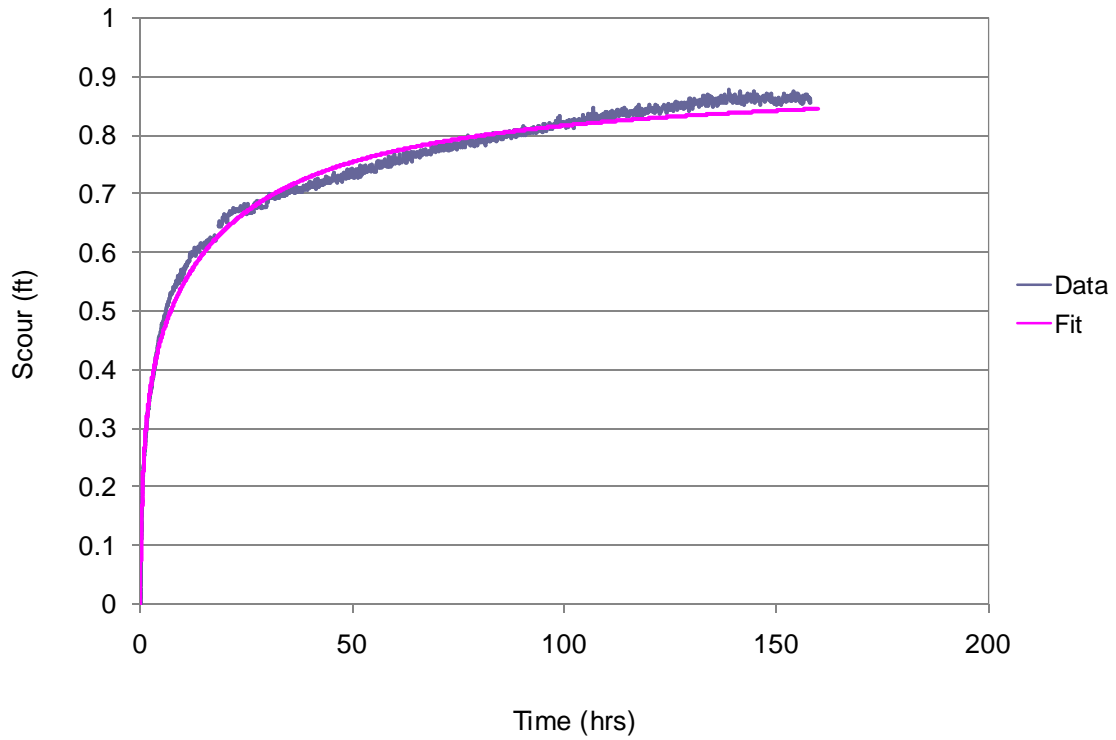

Figure 64 Test 2 Time History of Scour Depth and Curve Fit to Data.

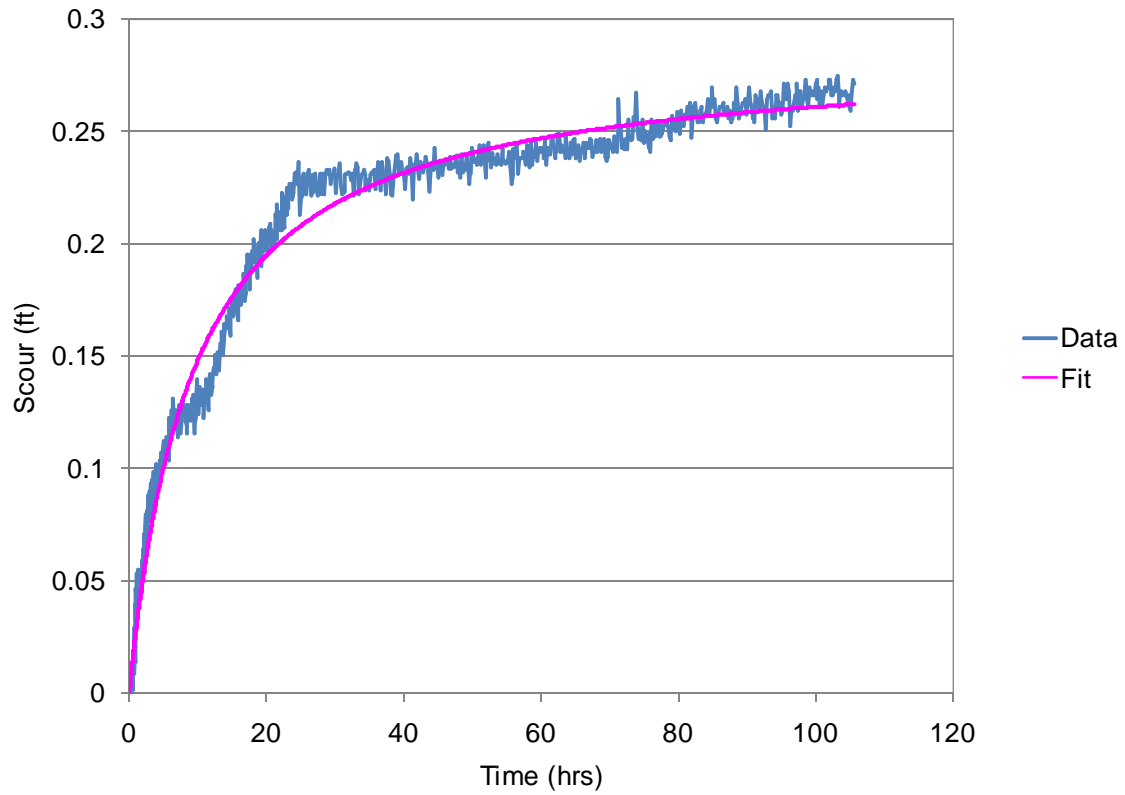

Figure 65 Test 3 Time History of Scour Depth and Curve Fit to Data.

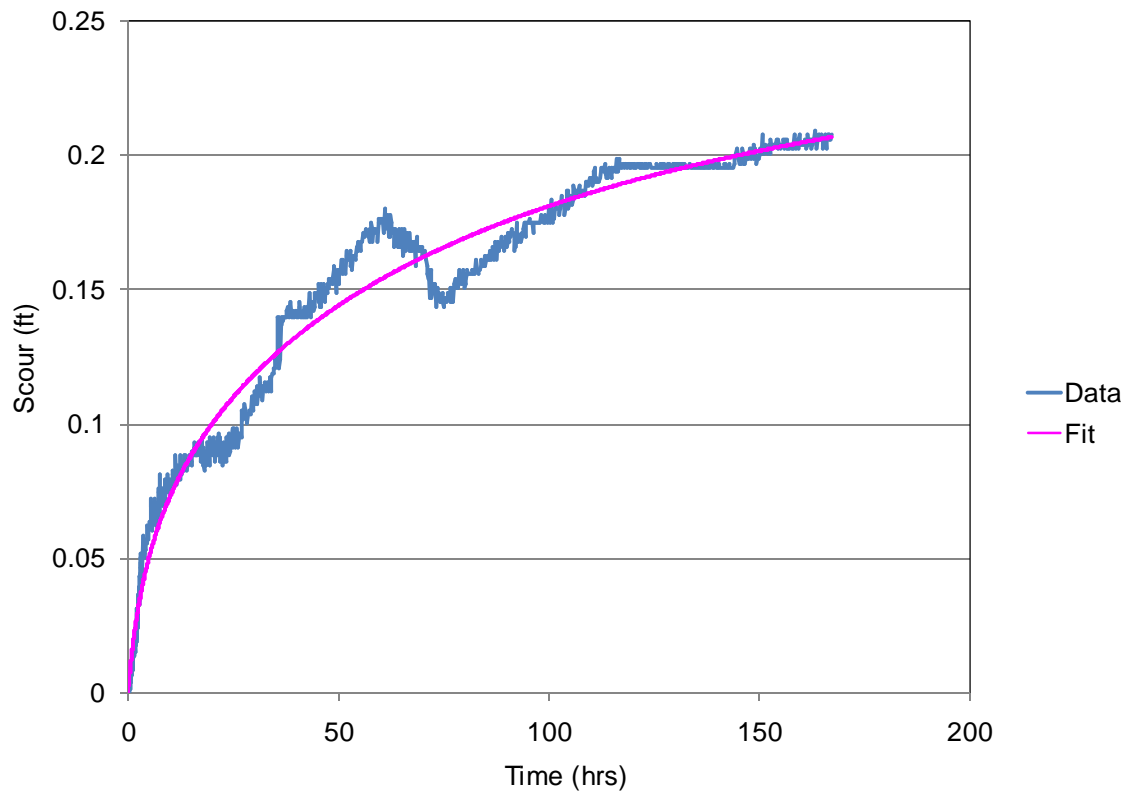

Figure 66 Test 4 Time History of Scour Depth and Curve Fit to Data.

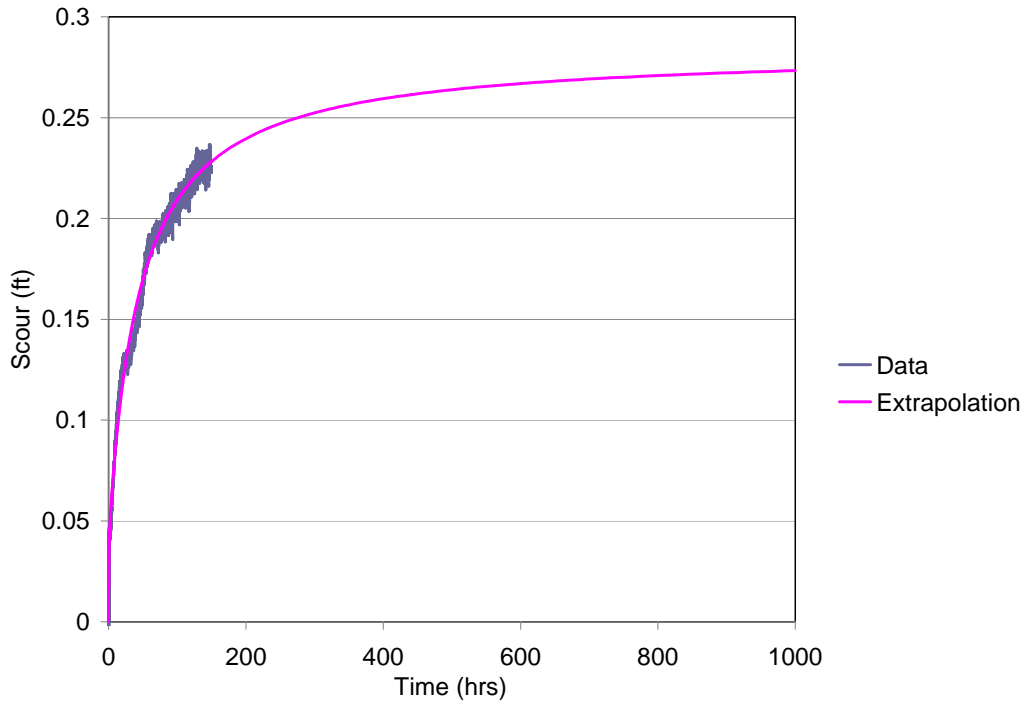

Figure 67 Test 5 Time History of Scour Depth and Curve Fit to Data.

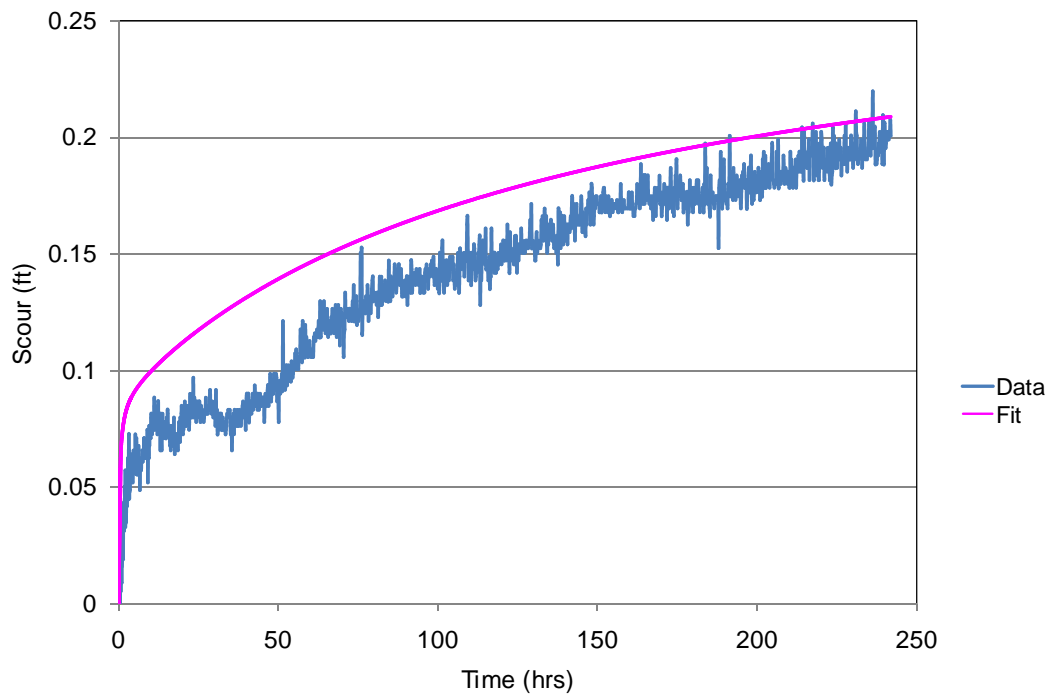

Figure 68 Test 6 Time History of Scour Depth and Curve Fit to Data. Note the presence of sand wave propagating through the test area. Due to the presence of sand waves the function used to fit the data is not as accurate during the earlier stages of the scour in this case.

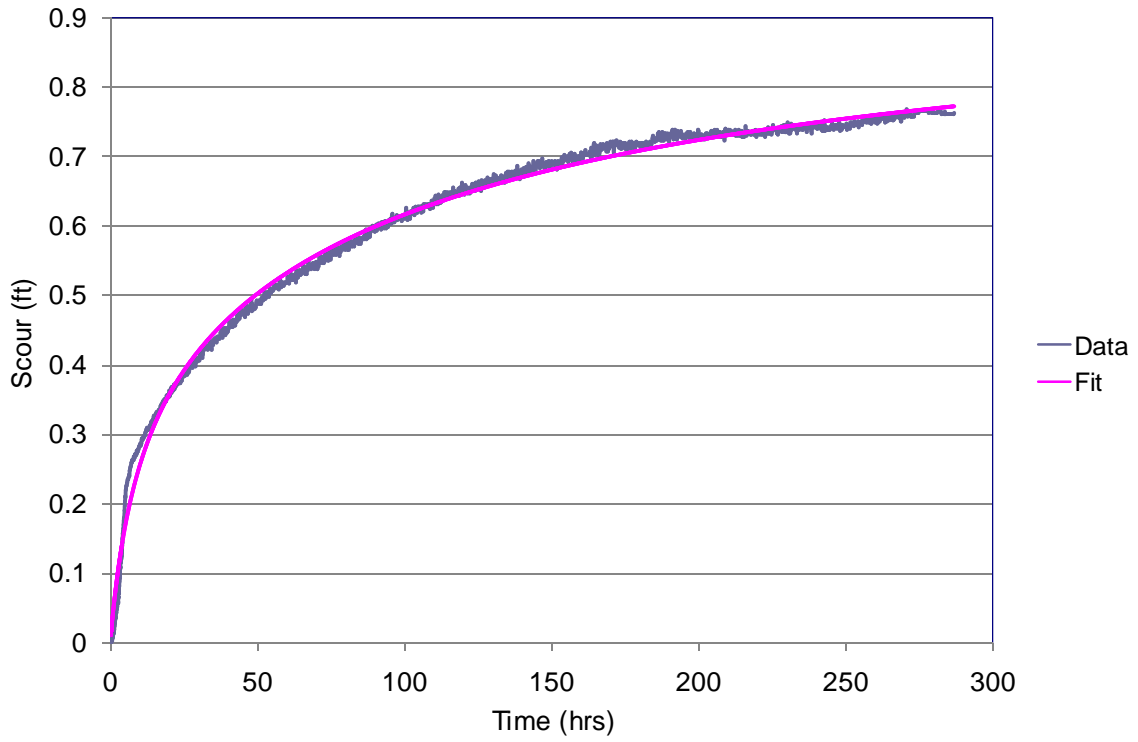

Figure 69 Test 7 Time History of Scour Depth and Curve Fit to Data.

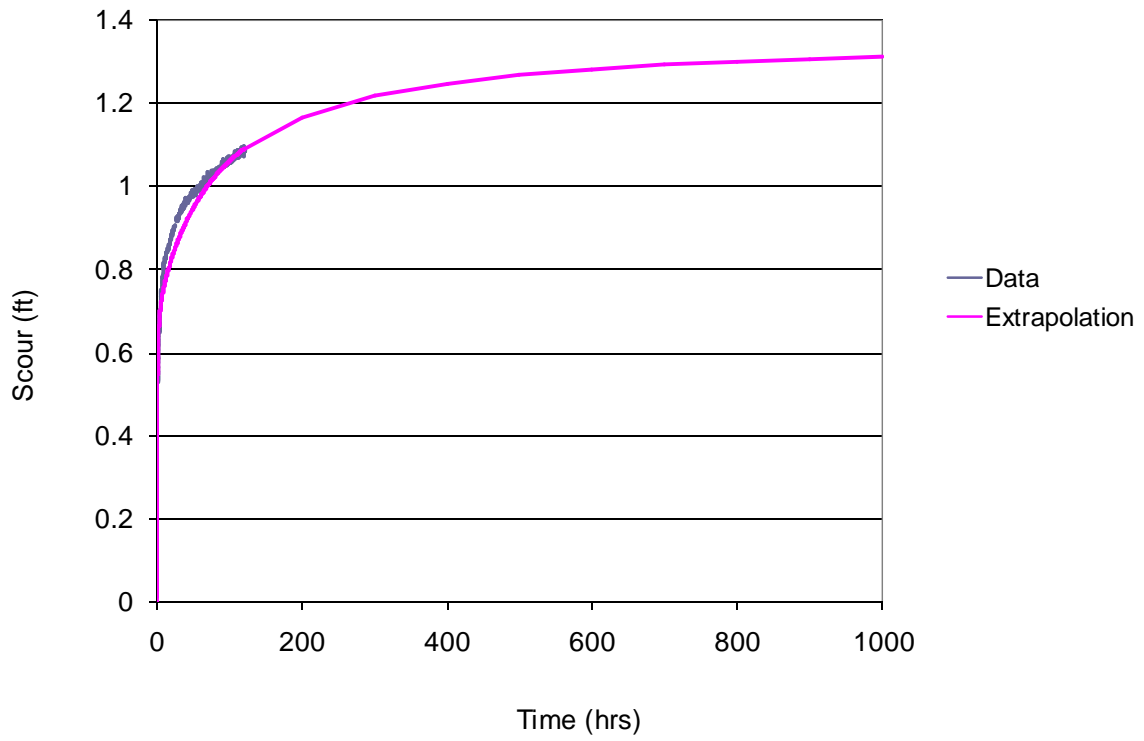

Figure 70 Test 1 Fit Curve Extrapolated to 500 hours.

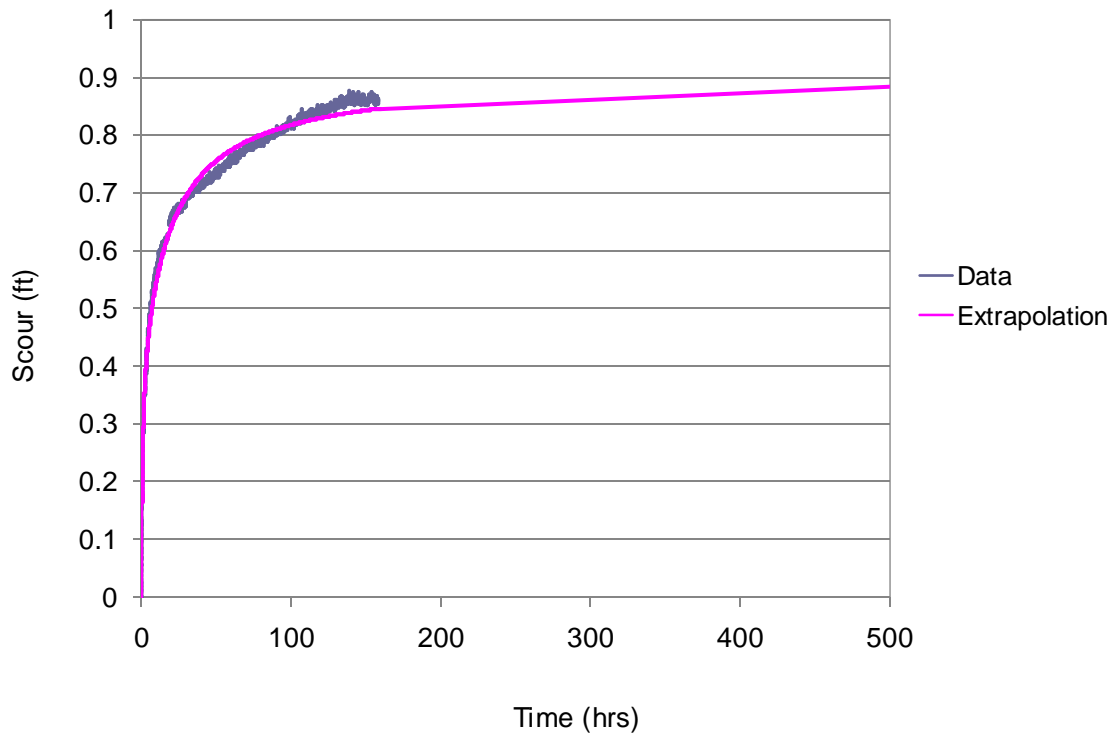

Figure 71 Test 2 Fit Curve Extrapolated to 500 hours.

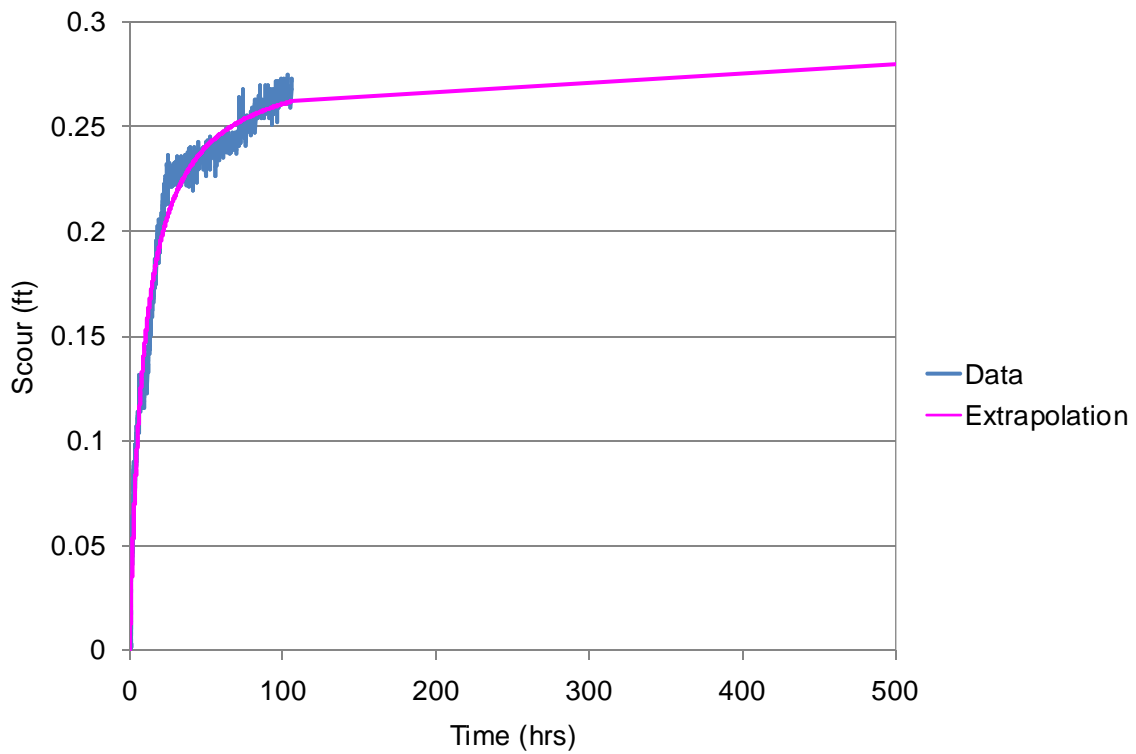

Figure 72 Test 3 Fit Curve Extrapolated to 500 hours.

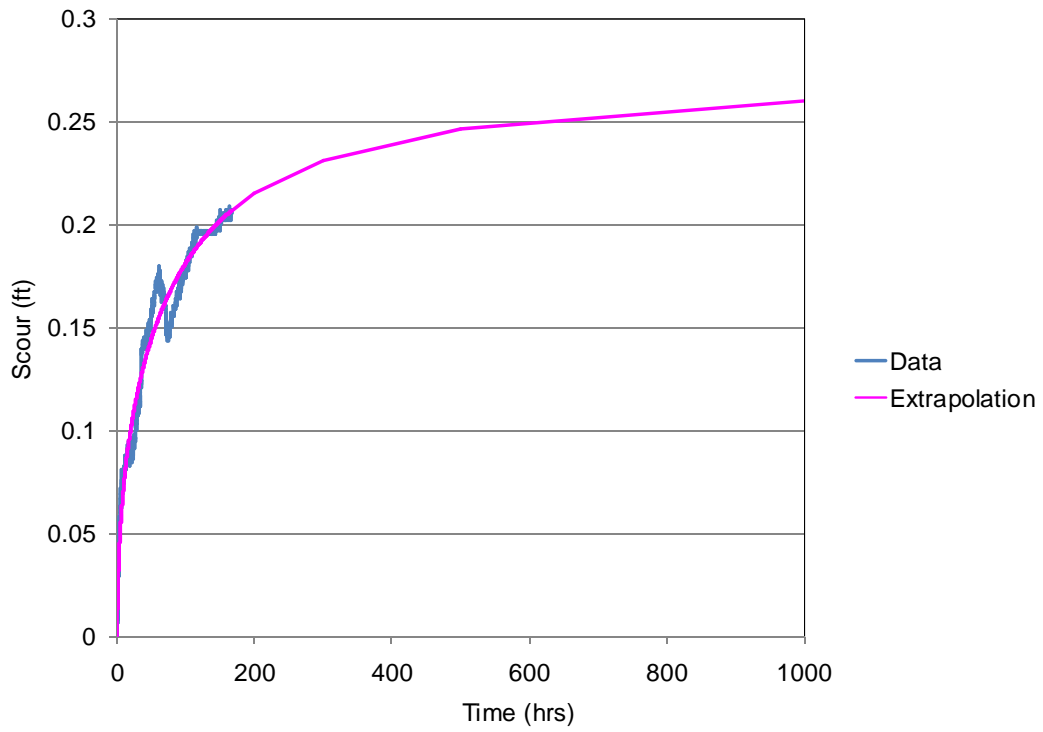

Figure 73 Test 4 Fit Curve Extrapolated to 500 hours.

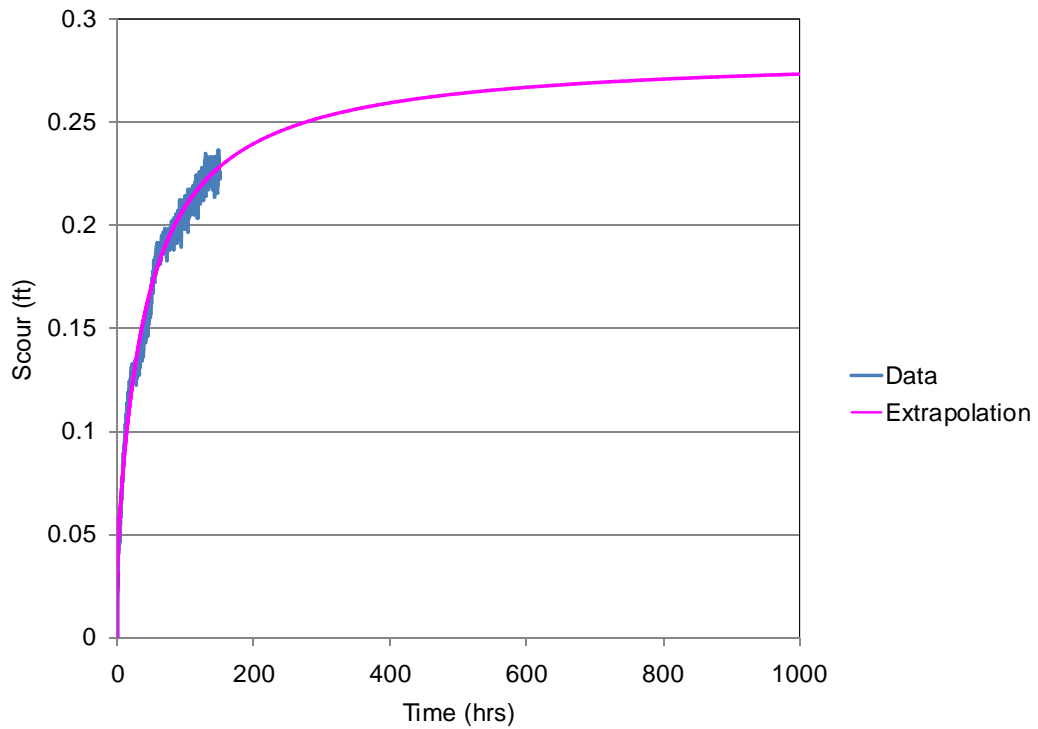

Figure 74 Test 5 Fit Curve Extrapolated to 500 hours.

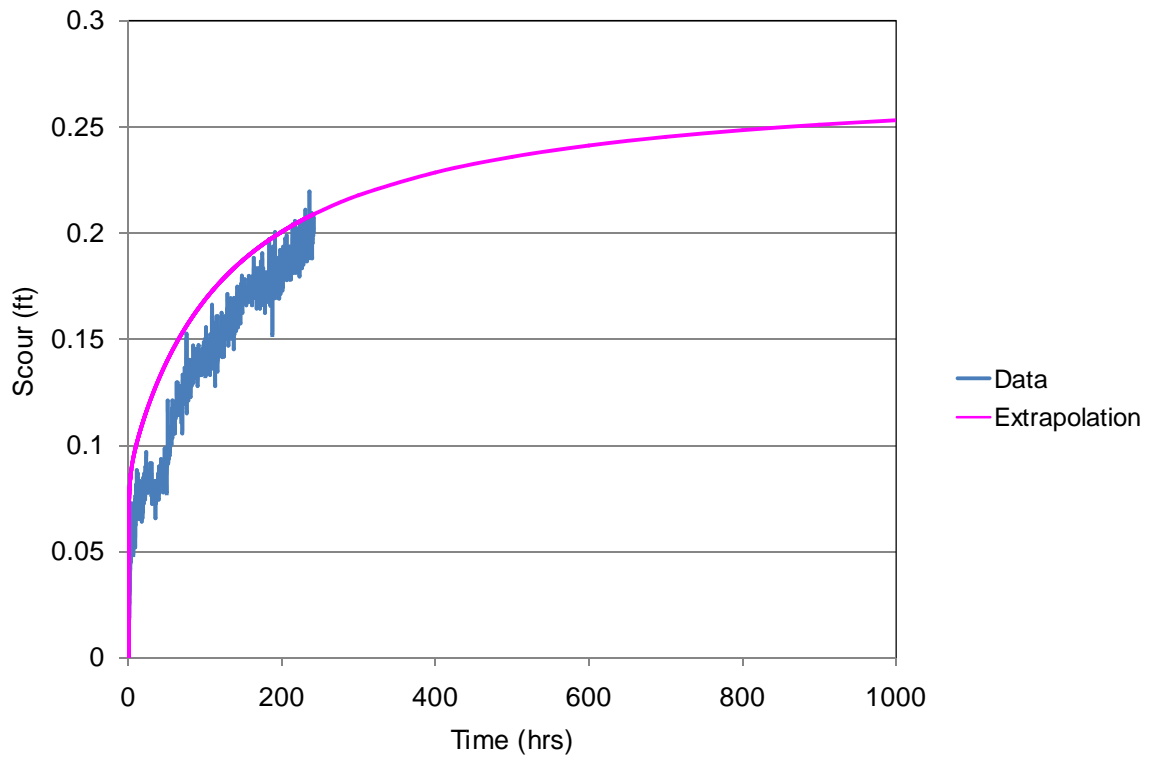

Figure 75 Test 6 Fit Curve Extrapolated to 500 hours.

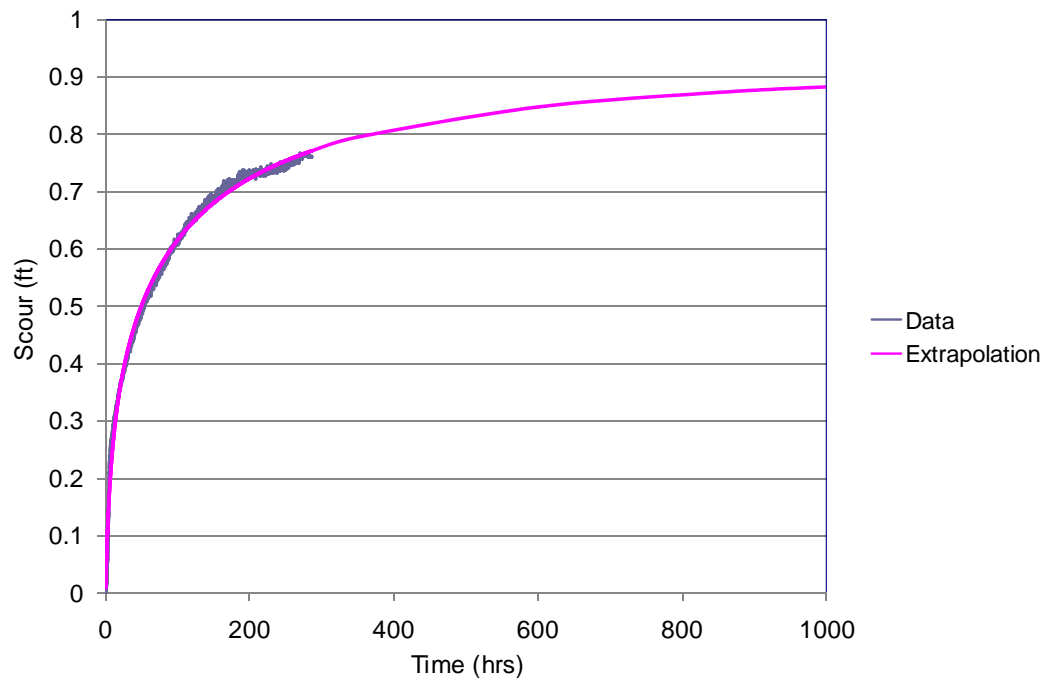

Figure 76 Exp 7 Extrapolated to 1000 hours

Table 9 Values of Curve Fit Coefficients for the 7 Tests.

Test	a	b	c	d
1	0.667	0.696	0.515	39.600
2	0.499	0.100	0.405	3.470
3	0.268	0.402	0.017	6.490
4	0.198	0.059	0.078	2.610
5	0.241	0.093	0.043	99.300
6	0.186	0.041	0.089	40.700
7	0.528	0.015	0.418	0.253

Table 10 Equilibrium Scour Depths

Test #	Equilibrium Scour Depth (ft)	Maximum Measured Transponder Scour (ft)	Percent Difference (%)
1	1.18	1.09	8%
2	0.904	0.86	5%
3	0.285	0.27	5%
4	0.276	0.24	13%
5	0.284	0.28	1%
6	0.276	0.21	24%
7	0.946	0.762	19%

Discussion of Model Test Results

It is difficult to conduct local scour experiments for a variety of reasons. When working with flows that are close to the critical value (near the velocities and shear stresses that initiate sediment motion) in the test region, the critical shear stress is exceeded at locations upstream of the model. This causes the formation of sand ripples/waves upstream which, in time, propagate into the test area. This not only impacts the local scour, but its measurement as well. This is particularly true for small structures and relatively large sediment grain sizes. One way to reduce this problem is to lower the test velocities (and shear stresses). This, however, reduces the rate of scour and therefore requires a longer duration test. If the test is not of sufficient duration then the accuracy of the data extrapolation to an equilibrium value is significantly reduced.

Another problem commonly encountered in local scour tests with small structures is armoring of the bed near the structure during the test caused by a wider distribution sediment sizes than desired. When the sediment in the flume contains a range of sediment diameters

the smaller diameter particles are removed near the structure thus changing the median diameter (D_{50}) of the sediment in the vicinity of the structure as the test progresses. This changes the ratios of V/V_c (velocity over critical velocity) and D^*/D_{50} (structure effective diameter over median sediment diameter) and thus the equilibrium scour depth.

The scour tests with the pile groups appear to have experienced all of the above problems. Note that even though the pile configurations were different in Tests 3-6 the extrapolated scour depths are approximately the same. The existence of armoring can be seen in the post experiment photographs (e.g. Figures 36, 37, 39, 42). Bed forms can be seen in several of the post test photographs (e.g. Figures 45, 49, 57).

Existing Complex Pier Scour Equations:

As discussed above the primary purpose for performing the scour experiments was to provide data missing in the literature for partially and fully buried pile caps and for pile groups with different centerline spacings and orientations to the flow. The equations were evaluated for the conditions of the tests and the results compared with the extrapolated equilibrium scour depths. Figure 77 shows the comparison between the predicted and extrapolated values. The comparison is also presented in Table 11.

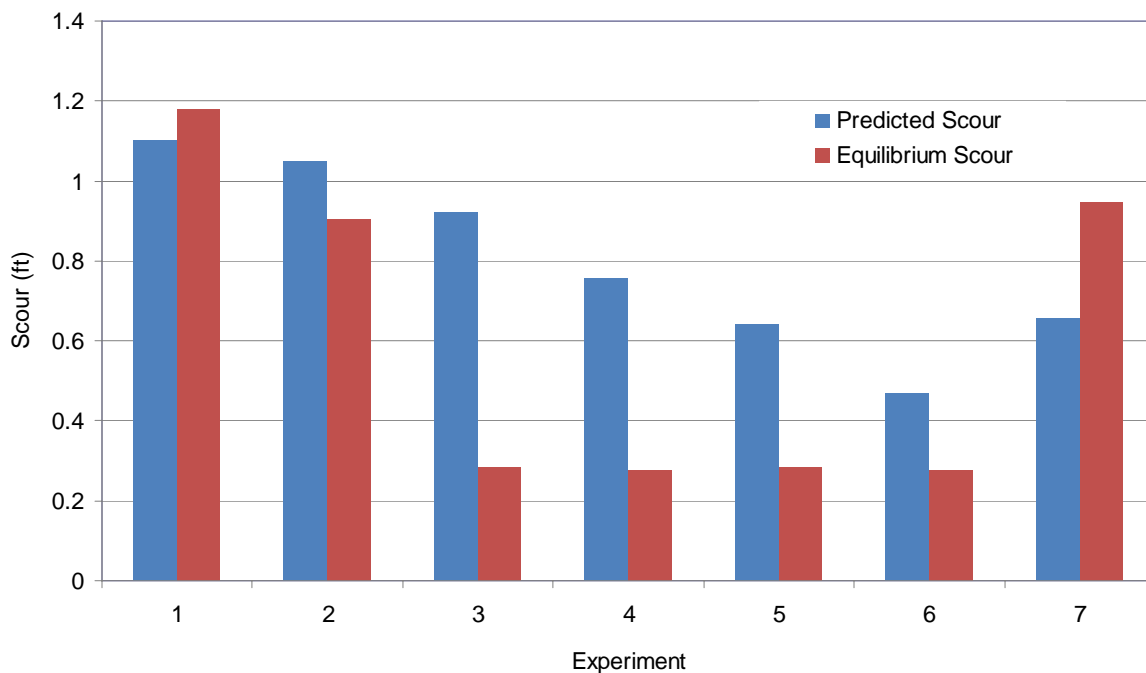

Figure 77 Predicted Versus Extrapolated Scour Depths

Table 11 Predicted Versus Extrapolated Scour Depths

Experiment	FDOT Scour (ft)	Extrapolated Scour (ft)
1	0.90	1.18
2	0.96	0.90
3	0.92	0.29
4	0.76	0.28
5	0.64	0.28
6	0.47	0.28
7	0.66	0.95

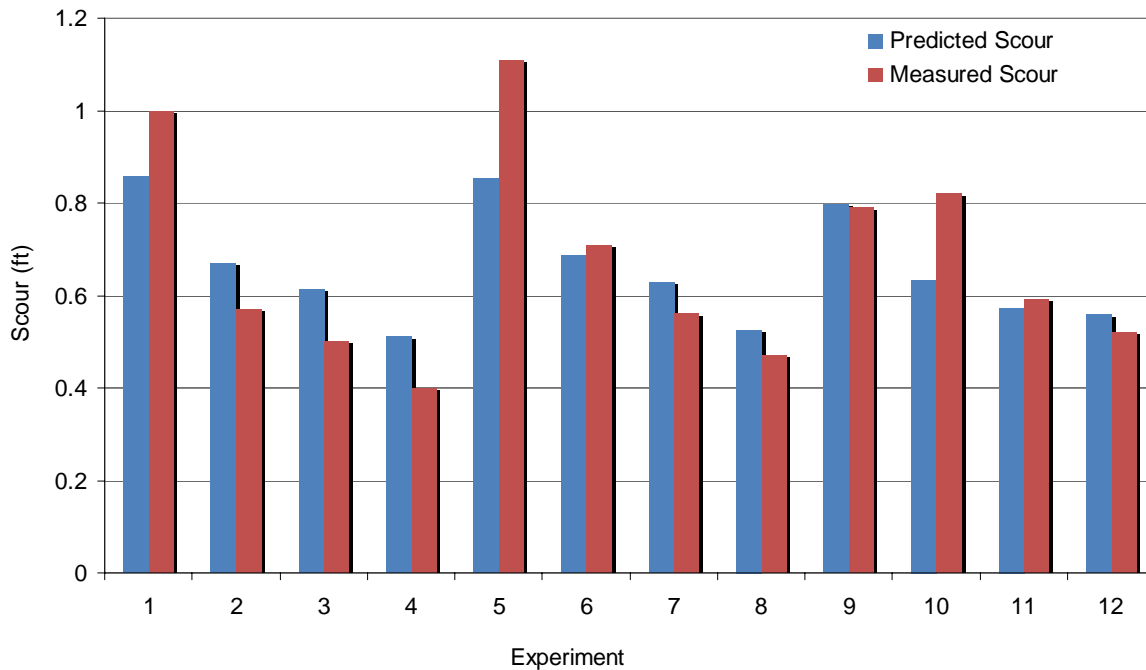

Figure 78 Experiments Performed by Sterling Jones at the FHWA Turner-Fairbanks Laboratory. All Experiments Performed with Column and Footer (no piles). Experiments 1, 5 and 10 were with buried footers. Experiment 9 is suspect.

The equations under predict the extrapolated scour depths in the New Zealand tests with partially and fully buried pile caps (Tests 1 and 7) and over predict the depths for the pile group tests (Tests 2-6). It should be pointed out that only limited data existed for scour at partially and fully buried pile caps when the complex pier scour equations were developed. The premise on which these equations were developed is that a complex pier consisting of up to three components (column, pile cap and pile group) can be replaced by a single circular

pile of diameter, D^* , (effective diameter) for the purpose of local equilibrium scour depth calculations. The effective diameter, D^* , is computed by dividing the complex pier into its components, computing an effective diameter for each component then summing to obtain the overall effective diameter. The effective diameter for each component was determined through experiments with that individual component and found to be dependent on the component dimensions, location in the water column, flow and sediment parameters, etc. This linear superposition approach implies little or no non-linear interaction between the components which, of course, is not true. The existing equations do account for the effect of the pile cap on the effective diameter of the column but not vice versa. That is they do not account for the presence of the column on the effective diameter of the pile cap. This appears to be part of the reason for the discrepancy between prediction and measurement in Tests 1 and 7 (partially and fully buried pile caps with columns present). Based on the limited data that exists for partially and fully buried pile cap scour it also appears that the existence of piles beneath the pile cap (footer) actually reduces the scour depth (over what it would be if the piles were not there). Apparently the piles in the scour hole retard the flow beneath the pile cap thus reducing the shear stress and equilibrium scour depth. This will have to be addressed in the complex pier scour equations. Current design practice in Florida does not allow spread footers (without piles) in erodable sediments. Never-the-less there are existing bridge piers with this configuration and thus the predictive equations must address this situation. More buried and partially buried pile cap data is needed with and without pile groups before this phenomena can be properly quantified.

The existing equations accurately predict scour depths at complex piers consisting of a column, pile cap and a pile group with partially and fully buried pile caps. They also accurately predict scour depths for a column and footer as long as the footer is above the bed (see Figure 78, Jones' Experiments 2, 3, 4, 6, 7, 8, 10, 11 and 12). However, the equations underpredict scour depths for piers with only columns and footers when the footer is partially or fully buried (see New Zealand Tests 1 and 7 and Jones's Experiments 1, 5 and 10). **Until this issue has been resolved it is recommended that the following procedure be used for computing design local scour depths at piers composed of a column and footer with no piles:**

1. Compute the equilibrium scour using the existing equations in the Florida Scour Manual,

2. If the bottom of the pile cap/footer is not uncovered then use the computed scour for design,
3. If the pile cap/footer is uncovered (i.e. if the computed scour depth is greater than the distance from the bed to the bottom of the pile cap/footer then multiply the computed scour depth by 1.35 to account for the increased scour due to the absence of piles.