

SHEET NO.	CONTENTS
1	Preface Manual On Uniform Traffic Control Devices Abbreviations Symbols
2	Definitions Temporary Traffic Control Devices Pedestrian and Bicyclist Overhead Work Railroads Sight Distance Above Ground Hazard
3	Clear Zone Widths For Work Zones Superelevation Length Of Lane Closures Overweight/Oversize Vehicles Lane Widths High-Visibility Safety Apparel Regulatory Speeds In Work Zones
4	Flagger Control Survey Work Zones Signs
5	Work Zone Sign Supports
6	Project Information Sign
7	Commonly Used Warning and Regulatory Signs In Work Zones
8	Manholes/Crosswalks/Joints Truck Mounted Attenuators Removing Pavement Markings Signals Channelizing Devices Channelizing Devices Consistency Portable Changeable (Variable) Message Signs (PCMS) Advanced Warning Arrow Boards
9	Drop-Offs In Work Zones
10	Business Entrance Temporary Asphalt Separator
11	Identifications-Channelizing Devices
12	Pavement Markings

### PREFACE

All projects and works on highways, roads and streets shall have a traffic control plan. All work shall be executed under the established plan and Department-approved procedures. This index contains information specific to the Federal and State guidelines and standards for the preparation of traffic control plans and for the execution of traffic control in work zones, for construction and maintenance operations and utility work on highways, roads and streets on the State Highway System. Certain requirements in this Index are based on the high volume nature of State Highways. For highways, roads and streets off the State Highway System, the local agency (City/County) having jurisdiction may adopt requirements based on the minimum requirements provided in the MUTCD.

Index No. 600 provides Department policy and standards. Changes are only to be made thru Department-approved procedures. Index Nos. 601 thru 670 provide typical applications for various situations. Modification can be made to these Indexes as long as the changes comply with the MUTCD and Department Design Standards.

The sign spacing shown on the Indexes are typical (recommended) distances. These distances may be increased or decreased based on field conditions, in order to avoid conflicts or to improve site specific traffic controls.





















Except for emergencies, any road closure on State Highway System shall comply with Section 335.15, F.S.

### MANUAL ON UNIFORM TRAFFIC CONTROL DEVICES

The Florida Department of Transportation has adopted the "Manual On Uniform Traffic Control Devices For Streets And Highways" (MUTCD) and subsequent revisions and addendums, as published by the U.S. Department of Transportation, Federal Highway Administration, for mandatory use on the State Maintained Highway System whenever there exists the need for construction, maintenance operations or utility work.

### SYMBOLS

The symbols shown are found in the FDOT site menu under Traffic Control cell library on the CADD system. Symbols assigned to the 600 series Design Standards and applicable to traffic control plans, unless otherwise identified in the plans, are as follows:

-  Work Area, Hazard Or Work Phase (Any pattern within a boundary)
-  Channelizing Device
-  Pedestrian Longitudinal Channelizing Device (LCD)
-  Type III Barricade
-  Work Zone Sign
-  Flagger
-  Automated Flagger Assistance Device (AFAD)
-  Traffic Signal
-  Advance Warning Arrow Board
-  Portable Signal
-  Crash Cushion
-  Stop Bar
-  Work Vehicle With Flashing Beacon
-  Shadow (S) Or Advance Warning (AW) Vehicle With Advance Warning Arrow Board And Warning Sign
-  Truck/Trailer Mounted Attenuator (TMA)
-  Law Enforcement Officer
-  Portable Regulatory Sign
-  Radar Speed Display Unit
-  Portable Changeable (Variable) Message Sign
-  Lane Identification + Direction Of Traffic
-  Traffic Control Officer

12/3/2015 11:36:12 AM

LAST REVISION 07/01/15	REVISION	DESCRIPTION:	 <b>FY 2016-17 DESIGN STANDARDS</b>	<b>GENERAL INFORMATION FOR TRAFFIC CONTROL THROUGH WORK ZONES</b>	INDEX NO. <b>600</b>	SHEET NO. <b>1 of 12</b>
---------------------------	----------	--------------	--	---	-------------------------	-----------------------------

## DEFINITIONS

### Regulatory Speed (In Work Zones)

The maximum permitted travel speed posted for the work zone is indicated by the regulatory speed limit signs. The work zone speed must be shown or noted in the plans. This speed should be used as the minimum design speed to determine runoff lengths, departure rates, flare rates, lengths of need, clear zone widths, taper lengths, crash cushion requirements, marker spacings, superelevation and other similar features.

### Advisory Speed

The maximum recommended travel speed through a curve or a hazardous area.

### Travel Way

The portion of the roadway for the movement of vehicles. For traffic control through work zones, travel way may include the temporary use of shoulders and any other permanent or temporary surface intended for use as a lane for the movement of vehicular traffic.

- a. **Travel Lane:** The designated widths of roadway pavement marked to carry through traffic and to separate it from opposing traffic or traffic occupying other traffic lanes.
- b. **Auxiliary Lane:** The designated widths of roadway pavement marked to separate speed change, turning, passing and climbing maneuvers from through traffic.

### Detour, Lane Shift, and Diversion

A detour is the redirection of traffic onto another roadway to bypass the temporary traffic control zone. A lane shift is the redirection of traffic onto a different section of the permanent pavement. A diversion is the redirection of traffic onto a temporary roadway, usually adjacent to the permanent roadway and within the limits of the right of way.

### Aboveground Hazard

An aboveground hazard is any object, material or equipment other than traffic control devices that encroaches upon the travel way or that is located within the clear zone which does not meet the Department's safety criteria, i.e., anything that is greater than 4" in height and is firm and unyielding or doesn't meet breakaway requirements.

## TEMPORARY TRAFFIC CONTROL DEVICES

All temporary traffic control devices shall be ON the Department's Approved Products List (APL). Ensure the appropriate APL number is permanently marked on the device in a readily visible location.

All temporary traffic control devices shall be removed as soon as practical when they are no longer needed. When work is suspended for short periods of time, temporary traffic control devices that are no longer appropriate shall be removed or covered.

Arrow Boards, Portable Changeable Message Signs, Radar Speed Display Trailer, Portable Regulatory Signs, and any other trailer mounted device shall be delineated with a temporary traffic control device placed at each corner when in use and shall be moved outside the travel way and clear zone or be shielded by a barrier or crash cushion when not in use.

## PEDESTRIAN AND BICYCLIST

When an existing pedestrian way or bicycle way is located within a traffic control work zone, accommodation must be maintained and provision for the disabled must be provided.

Only approved pedestrian longitudinal channelizing devices may be used to delineate a temporary traffic control zone pedestrian walkway.

Advanced notification of sidewalk closures and marked detours shall be provided by appropriate signs.

## OVERHEAD WORK

Work is only allowed over a traffic lane when one of the following options is used:

### OPTION 1 (OVERHEAD WORK USING A MODIFIED LANE CLOSURE)

Overhead work using a modified lane closure is allowed if all of the following conditions are met:

- a. Work operation is located in a signalized intersection and limited to signals, signs, lighting and utilities.
- b. Work operations are 60 minutes or less.
- c. Speed limit is 45 mph or less.
- d. Aerial lift equipment in the work area has high-intensity, rotating, flashing, oscillating, or strobe lights operating.
- e. Aerial lift equipment is placed directly below the work area to close the lane.
- f. Traffic control devices are placed in advance of the vehicle/equipment closing the lane using a minimum 100 foot taper.
- g. Volume or complexity of the roadway may dictate additional devices, signs, flagmen and/or a traffic control officer.

### OPTION 2 (OVERHEAD WORK ABOVE AN OPEN TRAFFIC LANE)

Overhead work above a open traffic lane is allowed if all of the following conditions are met:

- a. Work operation is located on a utility pole, light pole, signal pole, or their appurtenances.
- b. Work operations are 60 minutes or less.
- c. Speed limit is 45 mph or less.
- d. No encroachment by any part of the work activities and equipment within an area bounded by 2 feet outside the edge of travel way and 18 feet high.
- e. Aerial lift equipment in the work area has high-intensity, rotating, flashing, oscillating, or strobe lights operating.
- f. Volume or complexity of the roadway may dictate additional devices, signs, flagmen and/or a traffic control officer.
- g. Adequate precautions are taken to prevent parts, tools, equipment and other objects from falling into open lanes of traffic.
- h. Other Governmental Agencies, Rail facilities, or Codes may require a greater clearance. The greater clearance required prevails as the rule.

### OPTION 3 (OVERHEAD WORK ADJACENT TO AN OPEN TRAFFIC LANE)

Overhead work adjacent to an open traffic lane is allowed if all of the following conditions are met:

- a. Work operation is located on a utility pole, light pole, signal pole, or their appurtenances.
- b. Work operations are 1 day or less.
- c. Speed limit is 45 mph or less.
- d. No encroachment by any part of the work activities and equipment within 2 foot from the edge of travel way up to 18' height.
  - Above 18' in height, no encroachment by any part of the work activities and equipment over the open traffic lane (except as allowed in Option 2 for work operations of 60 minutes or less).
- e. Aerial lift equipment in the work area has high-intensity, rotating, flashing, oscillating, or strobe lights operating.
- f. Volume or complexity of the roadway may dictate additional devices, signs, flagmen and/or a traffic control officer.
- g. Adequate precautions are taken to prevent parts, tools, equipment and other objects from falling into open lanes of traffic.
- h. Other Governmental Agencies, Rail facilities, or Codes may require a greater clearance. The greater clearance required prevails as the rule.

### OPTION 4 (OVERHEAD WORK MAINTAINING TRAFFIC WITH NO ENCROACHMENT BELOW THE OVERHEAD WORK AREA)

Traffic shall be detoured, shifted, diverted or paced as to not encroach in the area directly below the overhead work operations in accordance with the appropriate standard index drawing or detailed in the plans. This option applies to, but not limited to, the following construction activities:

- a. Beam, girder, segment, and bent/pier cap placement.
- b. Form and falsework placement and removal.
- c. Concrete placement.
- d. Railing construction located at edge of deck.
- e. Structure demolition.

### OPTION 5 (CONDUCTOR/CABLE PULLING ABOVE AN OPEN TRAFFIC LANE)

Overhead cable and/or de-energized conductor installations initial pull to proper tension shall be done in accordance with the appropriate Standard Index or temporary traffic control plan.

Continuous pulling operations of secured cable and/or conductors are allowed over open lane(s) of traffic with no encroachment by any part of the work activities, materials or equipment within the minimal vertical clearance above the travel way. The utility shall take precautions to ensure that pull ropes and conductors/cables at no time fall below the minimum vertical clearance.

On Limited Access facilities, a site specific temporary traffic control plan is required. The temporary traffic control plan shall include:

- a. The temporary traffic control set up for the initial pulling of the pull rope across the roadway.
- b. During pulling operations, advance warning consisting of no less than a Changeable Message Sign upstream of the work area with alternating messages, "Overhead Work Ahead" and "Be Prepared to Stop" followed by a traffic control officer and police vehicle with blue lights flashing during the pulling operation.

## RAILROADS

Railroad crossings affected by a construction project should be evaluated for traffic controls to reduce queuing on the tracks. The evaluation should include as a minimum: traffic volumes, distance from the tracks to the intersections, lane closure or taper locations, signal timing, etc.

## SIGHT DISTANCE

Tapers: Transition tapers should be obvious to drivers. If restricted sight distance is a problem (e.g., a sharp vertical or horizontal curve), the taper should begin well in advance of the view obstruction. The beginning of tapers should not be hidden behind curves.

Intersections: Traffic control devices at intersections must provide sight distances for the road user to perceive potential conflicts and to traverse the intersection safely. Construction equipment and materials shall not restrict intersection sight distance.

## ABOVEGROUND HAZARD

Aboveground hazards (see definitions) are to be considered work areas during working hours and treated with appropriate work zone traffic control procedures. During nonworking hours, all objects, materials and equipment that constitute an aboveground hazard must be stored/placed outside the travel way and clear zone or be shielded by a barrier or crash cushion.

For aboveground hazards within a work zone the clear zone required should be based on the regulatory speed posted during construction.

11:36:13 AM  
12/31/2015

LAST REVISION 07/01/15	REVISION	DESCRIPTION:	 <b>FY 2016-17 DESIGN STANDARDS</b>	<b>GENERAL INFORMATION FOR TRAFFIC CONTROL THROUGH WORK ZONES</b>	INDEX NO. <b>600</b>	SHEET NO. <b>2 of 12</b>
---------------------------	----------	--------------	---	---	-------------------------	-----------------------------

## CLEAR ZONE WIDTHS FOR WORK ZONES

The term 'clear zone' describes the unobstructed relatively flat area, impacted by construction, extending outward from the edge of the traffic lane. The table below gives clear zone widths in work zones for medians and roadside conditions other than for roadside canals; where roadside canals are present, clear zone widths are to conform with the distances to canals as described in the PPM, Volume I, Chapter 4.

CLEAR ZONE WIDTHS FOR WORK ZONES		
WORK ZONE SPEED (MPH)	TRAVEL LANES & MULTILANE RAMPS (feet)	AUXILIARY LANES & SINGLE LANE RAMPS (feet)
60-70	30	18
55	24	14
45-50	18	10
30-40	14	10
ALL SPEEDS CURB & GUTTER	4' BEHIND FACE OF CURB	4' BEHIND FACE OF CURB

## SUPERELEVATION

Horizontal curves constructed in conjunction with work zone traffic control should have the required superelevation applied to the design radii. Under conditions where normal crown controls curvature, the minimum radii that can be applied are listed in the table below.

MINIMUM RADII FOR NORMAL CROWN	
WORK ZONE POSTED SPEED	MINIMUM RADIUS
MPH	feet
65	3130
60	2400
55	1840
50	1390
45	1080
40	820
35	610
30	430
Superelevate When Smaller Radii is Used	

## LENGTH OF LANE CLOSURES

Lane closures shall not exceed 2 miles in total length (taper, buffer space and work space) in any given direction on the Interstate or on state highways with a posted speed of 55 MPH or greater.

## OVERWEIGHT/OVERSIZE VEHICLES

Restrictions to Lane Widths, Heights or Load Capacity can greatly impact the movement of over dimensioned loads. The Contractor shall notify the Engineer who in turn shall notify the State Permits Office, phone no. (850) 410-5777, at least seven calendar days in advance of implementing a maintenance of traffic plan which will impact the flow of overweight/oversized vehicles. Information provided shall include location, type of restriction (height, width or weight) and restriction time frames. When the roadway is restored to normal service the State Permits Office shall be notified immediately.

## LANE WIDTHS

Lane widths of through roadways should be maintained through work zone travel ways wherever practical. The minimum widths for work zone travel lanes shall be as follows: 11' for Interstate with at least one 12' lane provided in each direction, unless formally excepted by the Federal Highway Administration; 11' for freeways; and 10' for all other facilities.

## HIGH-VISIBILITY SAFETY APPAREL

All high-visibility safety apparel shall meet the requirements of the International Safety Equipment Association (ISEA) and the American National Standards Institute (ANSI) for "High-Visibility Safety Apparel", and labeled as ANSI/ISEA 107-2004 or 107-2010. The apparel background (outer) material color shall be either fluorescent orange-red or fluorescent yellow-green as defined by the standard. The retroreflective material shall be orange, yellow, white, silver, yellow-green, or a fluorescent version of these colors, and shall be visible at a minimum distance of 1,000 feet. Class 3 apparel may be substituted for Class 2 apparel. Replace apparel that is not visible at 1,000 feet.

**WORKERS:** All workers within the right-of-way shall wear ANSI/ISEA Class 2 apparel. Workers operating machinery or equipment in which loose clothing could become entangled during operation shall wear fitted high-visibility safety apparel. Workers inside the bucket of a bucket truck are not required to wear high-visibility safety apparel.

**UTILITIES:** When other industry apparel safety standards require utility workers to wear apparel that is inconsistent with FDOT requirements such as NFPA, OSHA, ANSI, etc., the other standards for apparel may prevail.

**FLAGGERS:** For daytime activities, Flaggers shall wear ANSI/ISEA Class 2 apparel. For nighttime activities, Flaggers shall wear ANSI/ISEA Class 3 apparel.

## REGULATORY SPEEDS IN WORK ZONES

Traffic Control Plans (TCP's) for all projects must include specific regulatory speeds for each phase of work. This can either be the posted speed or a reduced speed. The speed shall be noted in the TCPs; this includes indicating the existing speed if no reduction is to be made. Regulatory speeds are to be uniformly established through each phase.

In general, the regulatory speed should be established to route vehicles safely through the work zone as close as to normal highway speed as possible. The regulatory speed should not be reduced more than 10 mph below the posted speed and never below the minimum statutory speed for the class of facility. When a speed reduction greater than 10 mph is imposed, the reduction is to be done in 10 mph per 500' increments.

Temporary regulatory speed signs shall be removed as soon as the conditions requiring the reduced speed no longer exist. Once the work zone regulatory speeds are removed, the regulatory speed existing prior to construction will automatically go back into effect unless new speed limit signing is provided for in the plans.

On projects with interspaced work activities, speed reductions should be located in proximity to those activities which merit a reduced speed, and not "blanketed" for the entire project. At the departure of such activities, the normal highway speed should be posted to give the motorist notice that normal speed can be resumed.

If the existing regulatory speed is to be used, consideration should be given to supplementing the existing signs when the construction work zone is between existing regulatory speed signs. For projects where the reduced speed conditions exist for greater than 1 mile in rural areas (non-interstate) and on rural or urban interstate, additional regulatory speed signs are to be placed at no more than 1 mile intervals. Engineering judgement should be used in placement of the additional signs. Locating these signs beyond ramp entrances and beyond major intersections are examples of proper placement. For urban situations (non-interstate), additional speed signs are to be placed at a maximum of 1000' apart.

When field conditions warrant speed reductions different from those shown in the TCP the contractor may submit to the project engineer for approval by the Department, a signed and sealed study to justify the need for further reducing the posted speed, or, the engineer may request the District Traffic Operations Engineer (DTOE) to investigate the need. It will not be necessary for the DTOE to issue regulations for regulatory speeds in work zones due to the revised provisions of F.S. 316.07451(2) (b). Advisory Speed plates will be used at the option of the field engineer for temporary use while processing a request to change the regulatory speed specified in the plans when deemed necessary. Advisory speed plates cannot be used alone but must be placed below the construction warning sign for which the advisory speed is required.

For additional information, refer to the Plans Preparation Manual, Volume I, Chapter 10.

12/31/2015 11:38:14 AM

LAST REVISION 01/01/16	DESCRIPTION:	 <b>FY 2016-17 DESIGN STANDARDS</b>	<b>GENERAL INFORMATION FOR TRAFFIC CONTROL THROUGH WORK ZONES</b>	INDEX NO. <b>600</b>	SHEET NO. <b>3 of 12</b>
---------------------------	--------------	--	---	-------------------------	-----------------------------

## FLAGGER CONTROL

Where flaggers are used, a FLAGGER symbol or legend sign must replace the WORKERS symbol or legend sign.

The flagger must be clearly visible to approaching traffic for a distance sufficient to permit proper response by the motorist to the flagging instructions, and to permit traffic to reduce speed or to stop as required before entering the work site. Flaggers shall be positioned to maintain maximum color contrast between the flagger's high-visibility safety apparel and equipment and the work area background.

### Hand-Signaling Devices

STOP/SLOW paddles are the primary hand-signaling device. The STOP/SLOW paddle shall have an octagonal shape on a rigid handle. If the STOP/SLOW paddle is placed on a rigid staff, the minimum length of the staff, measured from the bottom of the paddle to the end of the staff that rests on the ground, must not be less than 6 ft. STOP/SLOW paddles shall be at least 24 inches wide with letters at least 6 inches high and should be fabricated from light semirigid material. The background of the STOP face shall be red with white letters and border. The background of the SLOW face shall be orange with black letters and border. When used at night-time, the STOP/SLOW paddle shall be retroreflectorized.

Flag use is limited to immediate emergencies, intersections, and when working on the centerline or shared left turn lanes where two (2) flaggers are required and there is opposing traffic in the adjacent lanes. Flags, when used, shall be a minimum of 24 inches square, made of a good grade of red material, and securely fastened to a staff that is approximately 36 inches in length. When used at nighttime, flags shall be retroreflectorized red.

Flashlight, lantern or other lighted signal that will display a red warning light shall be used at night.

### Flagger Stations

Flagger stations shall be located far enough in advance of the work space so that approaching road users will have sufficient distance to stop before entering the work space. When used at nighttime, the flagger station shall be illuminated.

## SURVEY WORK ZONES

The SURVEY CREW AHEAD symbol or legend sign shall be the principal Advance Warning Sign used for Traffic Control Through Survey Work Zones and may replace the ROAD WORK AHEAD sign when lane closures occur, at the discretion of the Party Chief.

When Traffic Control Through Work Zones is being used for survey purposes only, the END ROAD WORK sign as called for on certain 600 Series Indexes should be omitted.

## Survey Between Active Traffic Lanes or Shared Left Turn Lanes

The following provisions apply to Main Roadway Traffic Control Work Zones. These provisions must be adjusted by the Party Chief to fit roadway and traffic conditions when the Survey Work Zone includes intersections.

- (A) A STAY IN YOUR LANE (MOT-1-06) sign shall be added to the Advance Warning Sign sequence as the second most immediate sign from the work area.
- (B) Elevation Surveys-Cones may be used at the discretion of the Party Chief to protect prism holder and flagger(s). Cones, if used, may be placed at up to 50' intervals along the break line throughout the work zone.
- (C) Horizontal Control-With traffic flow in the same direction, cones shall be used to protect the backsight tripod and/or instrument. Cones shall be placed at the equipment, and up to 50' intervals for at least 200' towards the flow of traffic.
- (D) Horizontal Control-With traffic flow in opposite directions, cones shall be used to protect the backsight tripod and/or instrument. Cones shall be placed at the equipment, and up to 50' intervals for at least 200' in both directions towards the flow of traffic.

## SIGNS

### SIGN MATERIALS

Mesh signs may be used only for Daylight Operations.

Vinyl signs may be used for Day or Night Operations not to exceed 1 day except as noted in the standards.

Rigid or Lightweight sign panels may be used in accordance with the vendor APL drawing for the sign stand to which they are attached.

### INTERSECTING ROAD SIGNING

Signing for the control of traffic entering and leaving work zones by way of intersecting crossroads shall be adequate to make drivers aware of work zone conditions. When Work operations exceed 60 minutes, place the ROAD WORK AHEAD sign on the side street entering the work zone.

### ADJOINING AND/OR OVERLAPPING WORK ZONE SIGNING

Adjoining work zones may not have sufficient spacing for standard placement of signs and other traffic control devices in their advance warning areas or in some cases other areas within their traffic control zones. Where such restraints or conflicts occur or are likely to occur, one of the following methods will be employed to avoid conflicts and prevent conditions that could lead to misunderstanding on the part of the traveling public as to the intended travel way by the traffic control procedure applied:

- (A) For scheduled projects the engineer in responsible charge of project design will resolve anticipated work zone conflicts during the development of the project traffic control plan. This may entail revision of plans on preceding projects and coordination of plans on concurrent projects.
- (B) Unanticipated conflicts arising between adjoining in progress highway construction projects will be resolved by the Resident Engineer for projects under his residency, and, by the District Construction Engineer for in progress projects under adjoining residencies.
- (C) The District Maintenance Engineer will resolve anticipated and occurring conflicts within scheduled maintenance operations.
- (D) The Unit Maintenance Engineer will resolve conflicts that occur within routine maintenance works; between routine maintenance work, unscheduled work and/or permitted work; and, between unit controlled maintenance works and highway construction projects.

## SIGN COVERING AND INTERMITTENT WORK STOPPAGE SIGNING

Existing or temporary traffic control signs that are no longer applicable or are inconsistent with intended travel paths shall be removed or fully covered.

Sign blanks or other available coverings must completely cover the existing sign. Rigid sign coverings shall be the same size as the sign it is covering, and bolted in a manner to prevent movement.

Sign covers are incidental to work operations and are not paid for separately.

### SIGNING FOR DETOURS, LANE SHIFTS AND DIVERSIONS

Detours should be signed clearly over their entire length so that motorists can easily determine how to return to the original roadway. The reverse curve (W1-4) warning sign should be used for the advanced warning for a lane shift. A diversion should be signed as a lane shift.

### EXTENDED DISTANCE ADVANCE WARNING SIGN

Advance Warning Signs shall be used at extended distance of one-half mile or more when limited sight distance or the nature of the obstruction may require a motorist to bring their vehicle to a stop. Extended distance Advanced Warning Signs may be required on any type roadway, but particularly be considered on multilane divided highways where vehicle speed is generally in the higher range (45 MPH or more).

### UTILITY WORK AHEAD SIGN

The UTILITY WORK AHEAD (W21-7) sign may be used as an alternate to the ROAD WORK AHEAD or the ROAD WORK XX FT (W20-1) sign for utility operations on or adjacent to a highway.

### LENGTH OF ROAD WORK SIGN

The length of road work sign (G20-1) bearing the legend ROAD WORK NEXT \_\_\_\_\_ MILES is required for all projects of more than 2 miles in length. The number of miles entered should be rounded up to the nearest mile. The sign shall be located at begin construction points.

### SPEEDING FINES DOUBLED WHEN WORKERS PRESENT SIGN

The SPEEDING FINES DOUBLED WHEN WORKERS PRESENT sign should be installed on all projects, but may be omitted if the work operation is less than 1 day. The placement should be 500 feet beyond the ROAD WORK AHEAD sign or midway to the next sign whichever is less.

### GROOVED PAVEMENT AHEAD SIGN

The GROOVED PAVEMENT AHEAD sign is required 500 feet in advance of a milled or grooved surface open to traffic. The W8-15P placard shall be used in conjunction with the GROOVED PAVEMENT AHEAD sign.

### END ROAD WORK SIGN

The END ROAD WORK sign (G20-2) should be installed on all projects, but may be omitted where the work operation is less than 1 day. The sign should be placed approximately 500 feet beyond the end of a construction or maintenance project unless other distance is called for in the plans. When other Construction or Maintenance Operations occur within 1 mile this sign should be omitted and signing coordinated in accordance with Index No. 600, ADJOINING AND/OR OVERLAPPING WORK ZONE SIGNING.

### PROJECT INFORMATION SIGN

The Project information sign shall be installed when called for in the plans.

12/3/2015 11:38:16 AM

LAST REVISION 07/01/15	REVISION	DESCRIPTION:	 <b>FY 2016-17 DESIGN STANDARDS</b>	<b>GENERAL INFORMATION FOR TRAFFIC CONTROL THROUGH WORK ZONES</b>	INDEX NO. <b>600</b>	SHEET NO. <b>4 of 12</b>
------------------------------	----------	--------------	--	---	----------------------------	--------------------------------

**GENERAL NOTES:**

- All signs shall be post mounted when work operations exceed one day except for:
  - Road closure signs mounted in accordance with the vendor drawing for the Type III Barricade shown on the APL.
  - Pedestrian advanced warning or regulatory signs mounted on sign supports in accordance with the vendor drawing shown on the APL.
  - Median barrier mounted signs per Index 11871.

**TEMPORARY SIGN SUPPORT NOTE:**

- Unless shielded with 5'-0" deflection space or outside of the Clear Zone, signs mounted on temporary supports or barricades, and barricade/sign combination must be crashworthy in accordance with NCHRP 350 requirements and included on the Approved Products List (APL).

**POST MOUNTED SIGN NOTES:**

- Use only approved systems listed on the Department's Approved Products List (APL).
- Manufacturers seeking approval of U-Channel and steel square tube sign support assemblies for inclusion on the Approved Products List (APL) must submit a APL application, design calculations (for square tube only), and detailed drawings showing the product meets all the requirements of this Index.
- Provide 3 lb/ft Steel U-Channel Posts with a minimum section modulus of 0.43 in<sup>3</sup> for 60 ksi steel, a minimum section modulus of 0.37 in<sup>3</sup> for 70 ksi steel, or a minimum section modulus of 0.34 in<sup>3</sup> for 80 ksi steel.
- Provide 4 lb/ft Steel U-Channel Posts with a minimum section modulus of 0.56 in<sup>3</sup> for 60 ksi steel, or a minimum section modulus of 0.47 in<sup>3</sup> for 70 ksi or 80 ksi steel.
- U-channel posts shall conform with ASTM A 499, Grade 60, or ASTM A 576, Grade 1080 (with a minimum yield strength of 60 ksi). Square tube posts shall conform with ASTM A 653, Grade 50, or ASTM A 1011, Grade 50.
- Sign attachment bolts, washers, nuts, and spacers shall conform with ASTM A307 or A 36.
- For diamond warning signs with supplement plaque (up to 5 ft<sup>2</sup> in area), use 4 lb/ft posts for up to 10 ft Clear Height (measure to the bottom of diamond warning sign).
- Install 4 lb/ft Steel U-Channel Posts with approved breakaway splice in accordance with the manufacturer's detail shown on the APL.
- The contractor may install 3 lb/ft Steel U-Channel Posts with approved breakaway splice in accordance with the manufacturer's detail shown on the APL.
- Install all posts plumb.
- The contractor may set posts in preformed holes to the specified depth with suitable backfill tamped securely on all sides, or drive 3 lb/ft sign posts and any size base post in accordance with the manufacturer's detail shown on the APL.

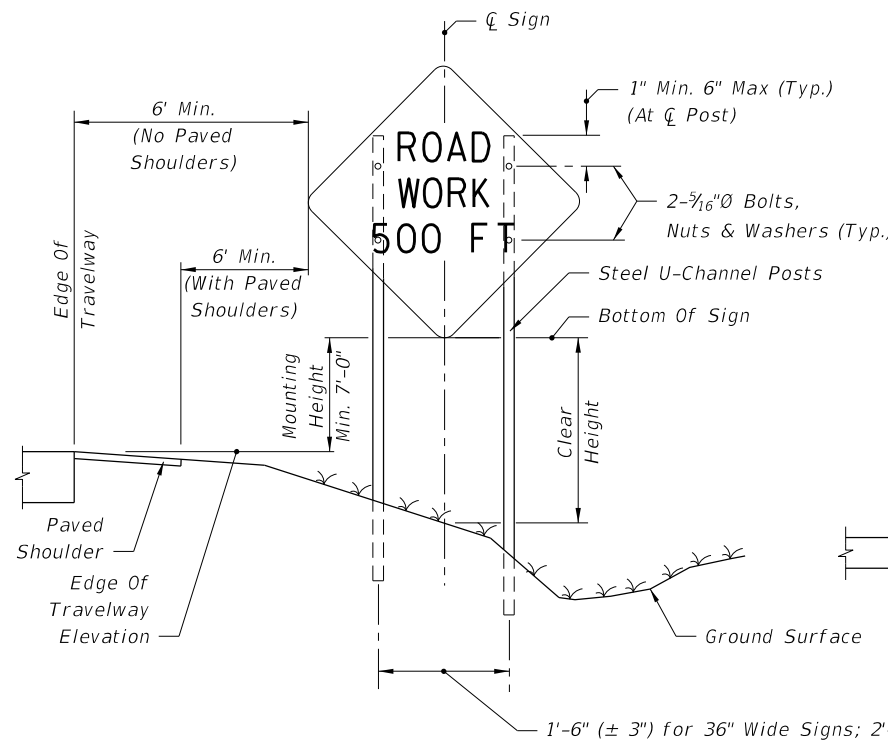

**2 POST SIGN SUPPORT MOUNTING DETAILS  
(SINGLE POST SIMILAR)  
RURAL**

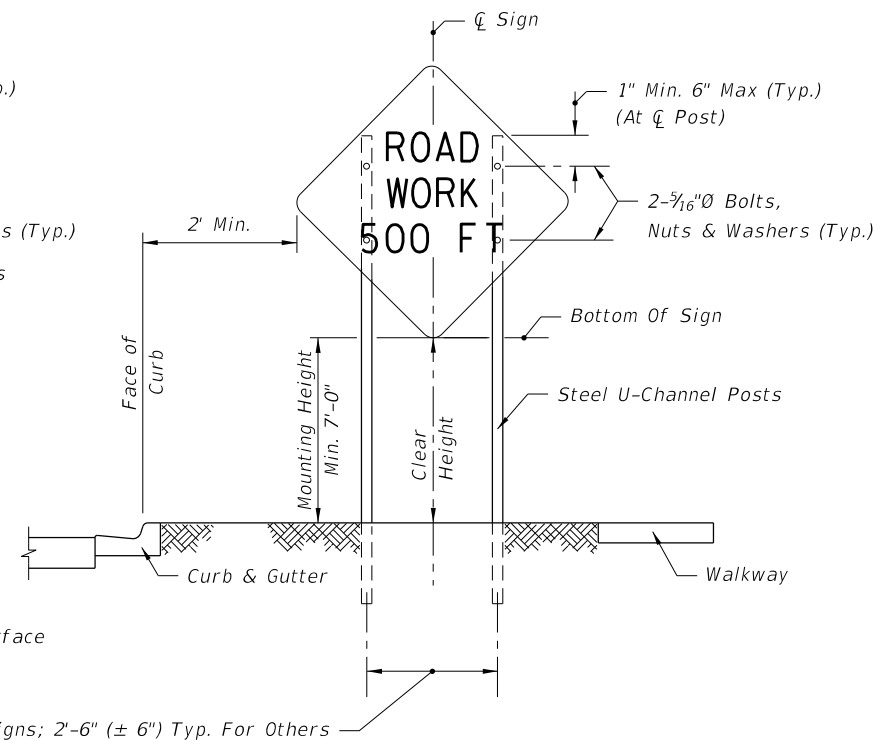

**2 POST SIGN SUPPORT MOUNTING DETAILS  
(SINGLE POST SIMILAR)  
URBAN**

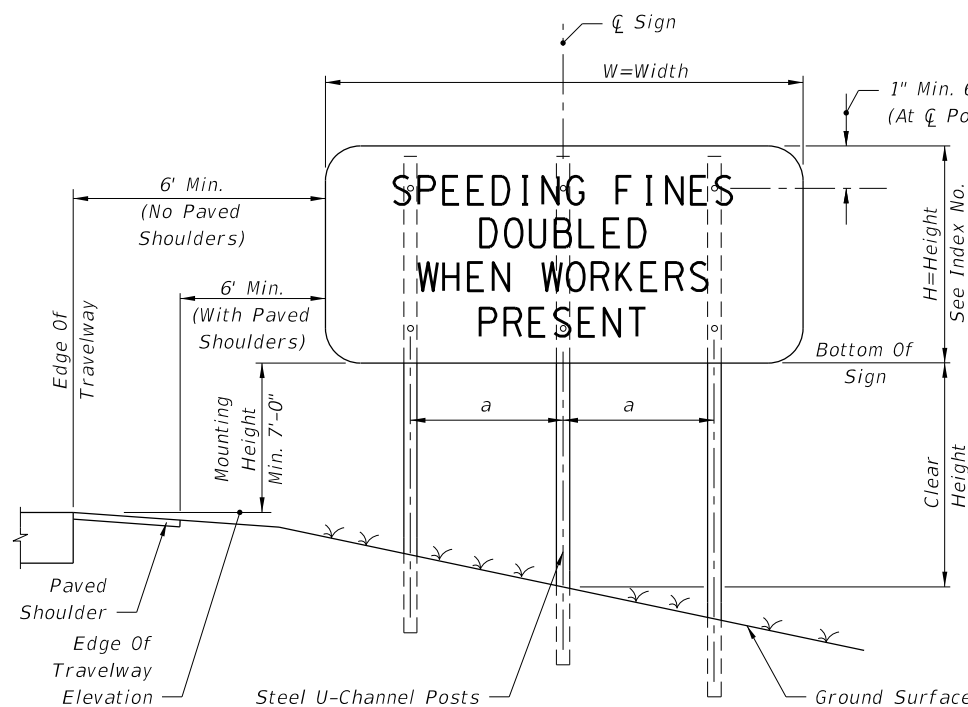

**3 POST SIGN SUPPORT MOUNTING DETAILS**

Where  $W = 48"$ :  $a = 1' - 4\frac{1}{2}" (\pm 1")$   
 $W = 60"$ :  $a = 1' - 9" (\pm 1")$   
 $W = 72"$ :  $a = 2' - 1" (\pm 1")$

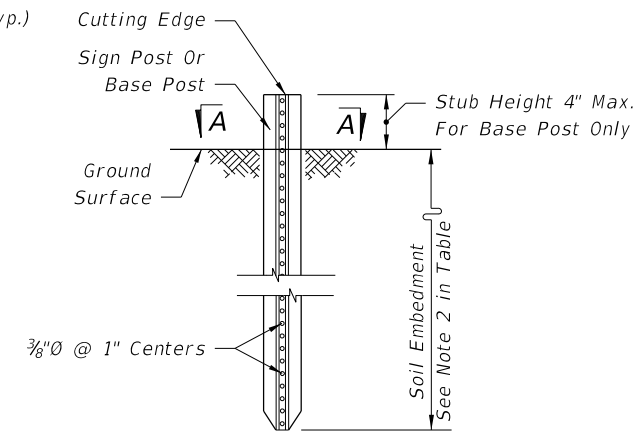

**TYPICAL FOUNDATION DETAIL**

See APL for post, splice and connection details.  
No bolts installed closer than 1" to cutting edge.

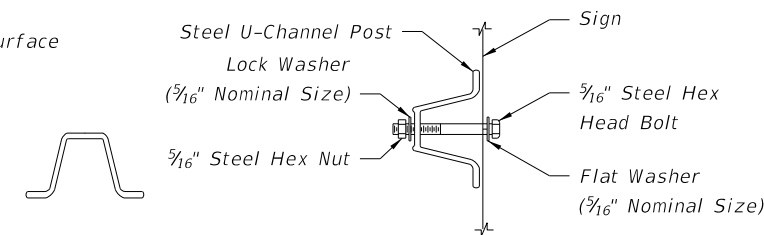

**SECTION A-A  
(SCHEMATIC)**

**SIGN ATTACHMENT DETAIL  
(WITHOUT Z-BRACKET)**

POST AND FOUNDATION TABLE FOR WORK ZONE SIGNS		
SIGN SHAPE	SIGN SIZE (inches)	NUMBER OF STEEL U CHANNEL POSTS
Octagon	30x30	1
	36x36x36	1
	48x48x48	1
Triangle	48x48x48	1
	60x60x60	2
	24x18	1
Rectangle (W x H)	24x30	1
	30x24	1
	36x18	1
	36x24	1
	48x18	1
	48x24	1
	36x48	2
	48x30	2
	48x36	2
	54x36	2
	48x60	3
	60x54	3
	72x48	3
	120x60*	4*
Square	30x30	1
	36x36	2
	48x48	2
Diamond (See Note 7)	48x48	2
Circle	360	2

**Notes For Table:**

- Use 3 lb/ft posts for Clear Height up to 10' and 4 lb/ft posts for Clear Height up to 12'.
- \* Use 4 lb/ft U-channel sign post with a mounting height of 7' min. and 8' max. Attach sign panel using Z-bracket detail on Sheet 6.
- Minimum foundation depth is 4.0' for 3 lb/ft posts and 4.5' for 4 lb/ft posts.
- For both 3 lb/ft and 4 lb/ft base or sign posts installed in rock, a minimum cumulative depth of 2' of rock layer is required.
- The soil plate as shown on the APL vendor drawing is not required for base posts or sign posts installed in existing rock (as defined in Note 3), asphalt roadway, shoulder pavement or soil under sidewalk.

12/3/2015 11:38:17 AM

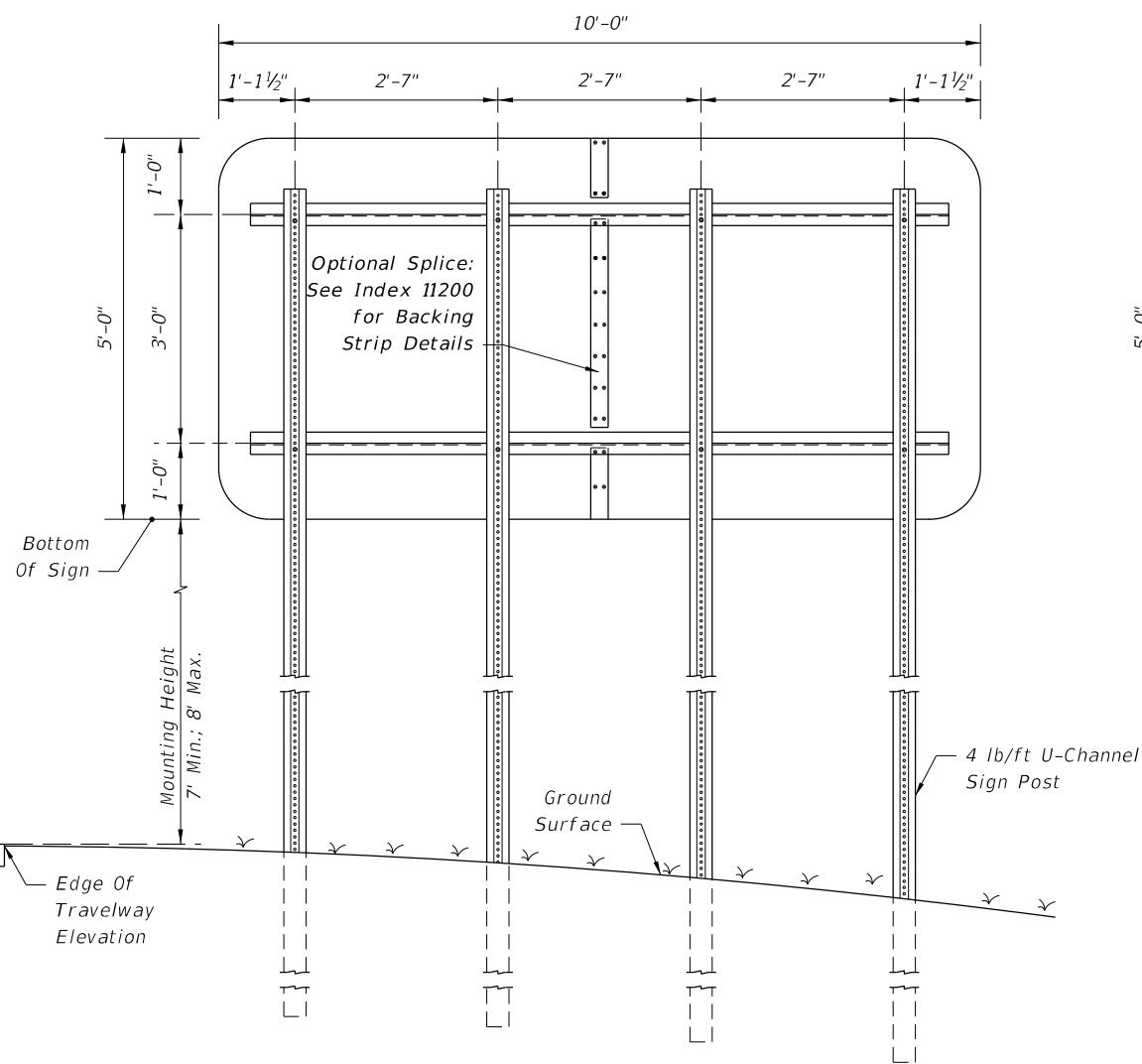

4 POST SIGN SUPPORT MOUNTING DETAIL

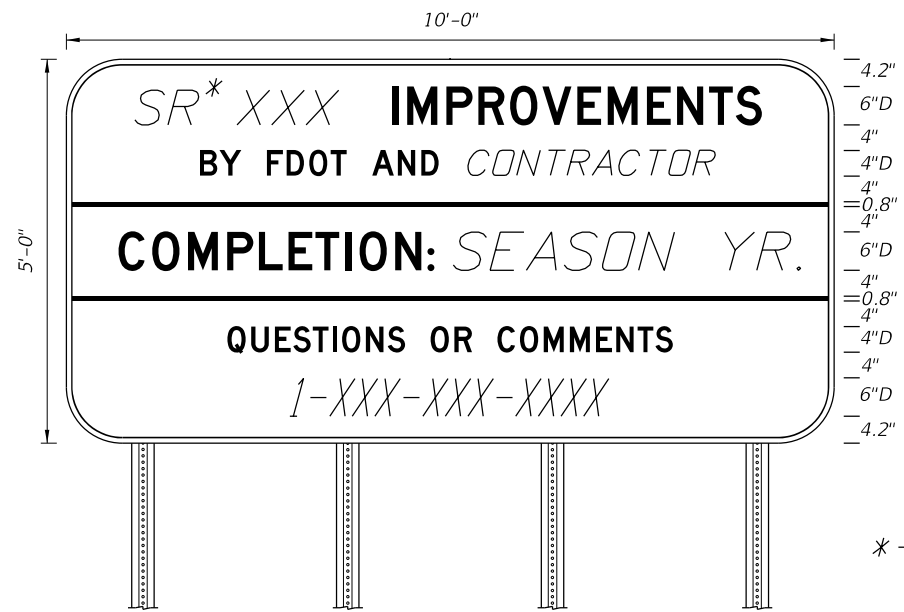

BORDER 10'-0" x 5'-0"  
 R=8" 8" Radii  
 TH=0.25" 4" and 6" series D Legend  
 IN=0.75" Blue Background  
 White Legend and Border

PROJECT INFORMATION SIGN DETAIL  
 50 MPH OR GREATER  
 Use SIGN ATTACHMENT DETAIL  
 (WITH Z-BRACKET).

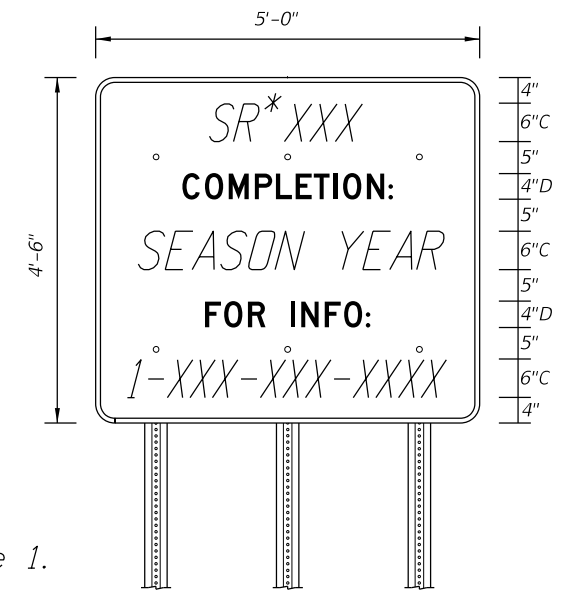

BORDER 5'-0" x 4'-6"  
 R=3" 3" Radii  
 TH=0.25" 4" series D Legend and  
 6" series C Legend  
 IN=0.75" Blue Background  
 White Legend and Border

PROJECT INFORMATION SIGN DETAIL  
 45 MPH OR LESS  
 Use SIGN ATTACHMENT DETAIL  
 (WITHOUT Z-BRACKET)  
 On Sheet 6.

\* - See Note 1.

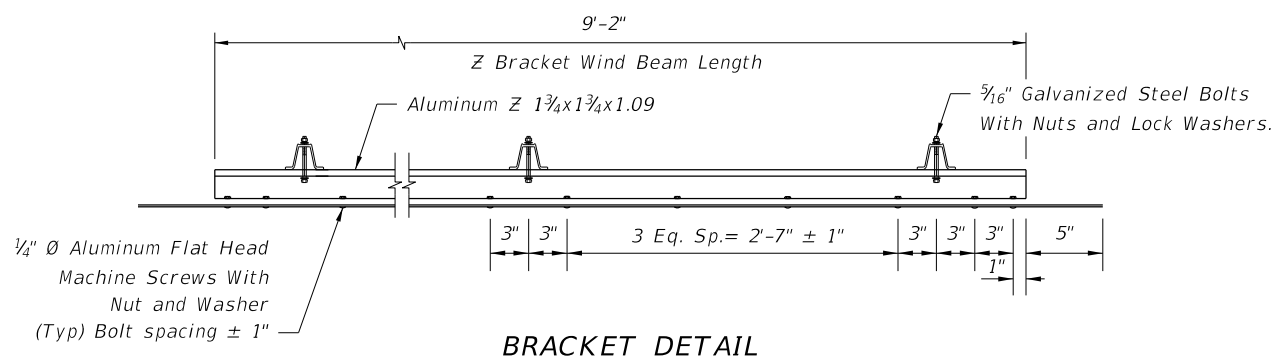

BRACKET DETAIL

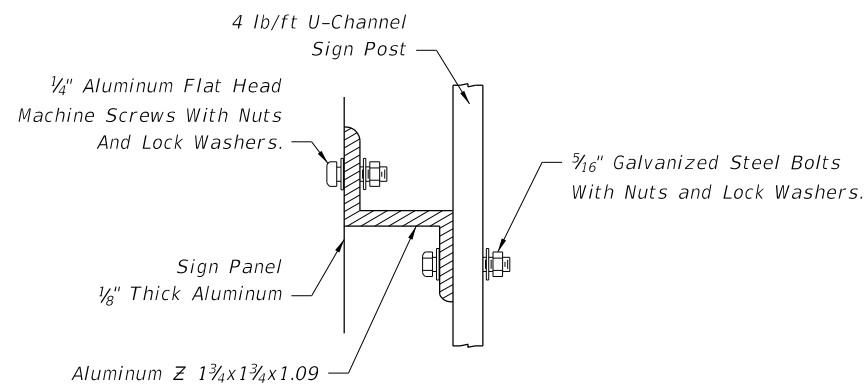

SIGN ATTACHMENT DETAIL  
 (WITH Z-BRACKET)

PROJECT INFORMATION SIGN NOTES:

1. Road designation should be the most common designation (ie. I-Interstate, SR-State Road or US.)
2. Italic text on signs indicate variable information specific to the project.
3. See Sheet 5 for POST AND FOUNDATIONS TABLE FOR WORK ZONE SIGNS.
4. See Sheet 5 for TYPICAL FOUNDATION DETAIL.

PROJECT INFORMATION SIGN

12/3/2015 11:38:18 AM

LAST REVISION 07/01/15	REVISION	DESCRIPTION:	FY 2016-17 DESIGN STANDARDS	GENERAL INFORMATION FOR TRAFFIC CONTROL THROUGH WORK ZONES	INDEX NO. 600	SHEET NO. 6 of 12
---------------------------	----------	--------------	--------------------------------	---	------------------	----------------------

11:38:19 AM  
12/3/2015

E5-2 B/O	E5-2a B/O	G20-1 B/O	G20-2 B/O	G20-4 B/O	M4-8 B/O	M4-8A B/O	M4-9L B/O	M4-9R B/O	M4-10L O/B	M4-10R O/B	OM-3R B/Y	R1-1 W/R	R1-2 RW/R	R2-1 B/W	R4-1 B/W	R4-2 B/W	R4-5 B/W	R4-7 B/W	R4-8 B/W	R4-7AL B/W
R4-7AR B/W	R4-7BL B/W	R4-7BR B/W	R5-1 WR/W	R9-8 B/W	R9-9 B/W	R9-10 B/W	R9-11 B/W	R9-11a B/W	R11-2 B/W	W1-1R B/O	W1-2R B/O	W1-3R B/O	W1-4R B/O	W1-4b B/O	W1-4c B/O	W1-6 B/O	W1-7 B/O	W1-8 B/O	W3-1 RB/O	W3-2 RB/O
W3-3 B(RYG)/O	W3-4 B/O	W3-5 B/O	W4-1 B/O	W4-2 B/O	W5-1 B/O	W5-2 B/O	W5-3 B/O	W6-1 B/O	W6-2 B/O	W6-3 B/O	W8-1 B/O	W8-2 B/O	W8-3 B/O	W8-4 B/O	W8-5 B/O	W8-6 B/O	W8-7 B/O	W8-8 B/O	W8-9 B/O	W8-9a B/O
W8-11 B/O	W9-1L B/O	W9-1R B/O	W9-2L B/O	W9-2R B/O	W10-1 B/Y	W11-2 B/O	W12-1 B/O	W12-2 B/O	W13-1 B/O	W20-1A B/O	W20-1B B/O	W20-1C B/O	W20-1D B/O	W20-1E B/O	W20-1F B/O	W20-2A B/O	W20-2B B/O	W20-2C B/O	W20-2D B/O	W20-2E B/O
W20-3 B/O	W20-4 B/O	W20-5a B/O	W20-5L B/O	W20-5R B/O	W20-5C B/O	W20-7A B/O	W20-7 B/O	W21-1A B/O	W21-1 B/O	W21-5 B/O	W21-5a B/O	W21-6 B/O	W21-7 B/O	W8-15P B/O						
W22-1 B/O	W22-2 B/O	W22-3 B/O																		
																		<p><b>Notes:</b></p> <ol style="list-style-type: none"> <li>The size of diamond shaped Temporary Traffic Control (TTC) warning signs shall be a minimum of 48" X 48".</li> <li>Fluorescent orange shall be used for all orange colored work zone signs.</li> <li>The sign shields, symbols and messages contained on this sheet are provided for ready reference to those signs used in the development of the 600 series Design Standards and are commonly used in the development of traffic control plans. For additional signs and sign detail information refer to the STANDARD HIGHWAY SIGNS MANUAL as specified in the MUTCD. Special signs for traffic control plans will be as approved by the State Traffic Plans Engineer.</li> </ol> <p>The sign codes shown on this sheet are for the purpose of identifying cell names found in the Traffic Control Cell Library (TCZ.Cel).</p> <p>The STANDARD HIGHWAY SIGNS MANUAL should be referenced for the official sign codes for use in the development of traffic control plans.</p> <p>See Index No. 17355 for MOT sign details.</p>		
																		<p><b>COLOR CODES</b> Legend and/or Symbol Background</p> <p>O-Orange (Reflectorized)      R-Red (Reflectorized)        B-Black (Non-Reflectorized)      Y-Yellow (Reflectorized)        W-White (Reflectorized)      G-Green (Reflectorized)</p>		
MOT-1-06 B/O	MOT-4-06 B/O	MOT-5-06 B/O	MOT-7-06 B/O	MOT-8-06 B/O	MOT-9-06 B/O	MOT-10-06 B/O	MOT-11-06 BLUE/W	MOT-12-06R B/W	MOT-12-06L B/W	MOT-13-06 (Limited access facilities)	MOT-14-06 (All other facilities)	MOT-15-06 B/O	MOT-16-06 B/O	MOT-17-06 B/O	MOT-18-10 B/O	W8-15P B/O				

### COMMONLY USED WARNING AND REGULATORY SIGNS IN WORK ZONES

LAST REVISION 12/15/14	REVISION	DESCRIPTION:		FY 2016-17 DESIGN STANDARDS	GENERAL INFORMATION FOR TRAFFIC CONTROL THROUGH WORK ZONES	INDEX NO. 600	SHEET NO. 7 of 12
---------------------------	----------	--------------	--	--------------------------------	--	------------------	----------------------

## MANHOLES/CROSSWALKS/JOINTS

Manholes extending 1" or more above the travel lane and crosswalks having an uneven surface greater than 1/4" shall have a temporary asphalt apron constructed as shown in the diagram below.

All transverse joints that have a difference in elevation of 1" or more shall have a temporary asphalt apron constructed as shown in the diagram below.

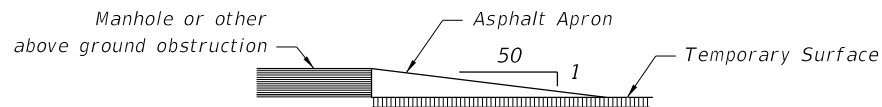

The apron is to be removed prior to constructing the next lift of asphalt. The cost of the temporary asphalt shall be included in the contract unit price for Maintenance of Traffic, LS.

## REMOVING PAVEMENT MARKINGS

Existing pavement markings that conflict with temporary work zone delineation shall be removed by any method approved by the Engineer, where operations exceed one daylight period. Painting over existing pavement markings with black paint or spraying with asphalt shall not be accepted as a substitute for removal or obliteration. Full pavement width overlays of either a structural or friction course are a positive means to achieve obliteration.

## SIGNALS

Existing traffic signal operations that require modification in order to carry out work zone traffic control shall be included in the TCP and be approved by the District Traffic Operations Engineer.

Maintain all existing actuated or traffic responsive mode signal operations for main and side street movements for the duration of the Contract and require restoration of any loss of detection within 12 hours. The contractor shall select only detection technology listed on the Department's Approved Products List (APL) and approved by the Engineer to restore detection capabilities.

## ADVANCE WARNING ARROW BOARDS

An arrow board in the arrow or chevron mode shall be used only for stationary or moving lane closures on multilane roadways.

For shoulder work, blocking the shoulder, for roadside work near the shoulder, or for temporarily closing one lane on a two-lane, two-way roadway, an arrow board shall be used only in the caution mode.

A single arrow board shall not be used to merge traffic laterally more than one lane. When arrow boards are used to close multiple lanes, a single board shall be used at the merging taper for each closed lane.

When Advance Warning Arrow Boards are used at night, the intensity of the flashers shall be reduced during darkness when lower intensities are desirable.

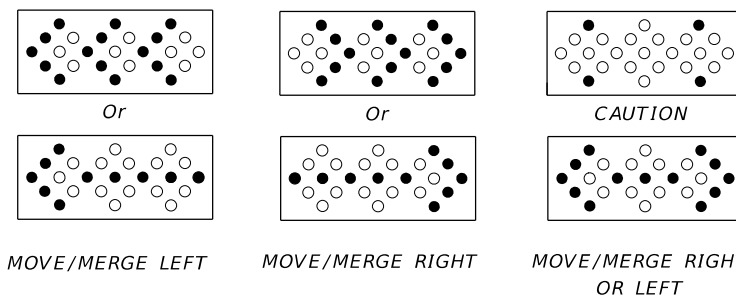

### MODES

## PORTABLE CHANGEABLE MESSAGE SIGNS (PCMS)

The PCMS can be used to:

1. Supplement standard signing in construction or maintenance work zones.
2. Reinforce static advance warning messages.
3. Provide motorists with updated guidance information.

PCMS should be placed approx. 500 to 800 feet in advance of the work zone conflicts or 0.5 to 2 miles in advance of complex traffic control schemes which require new and/or unusual traffic maneuvers.

If PCMS are to be used at night, the intensity of the flashers shall be reduced during darkness when lower intensities are desirable.

For additional information refer to the FDOT Plans Preparation Manual, Volume I, Chapter 10.

## TRUCK/TRAILER-MOUNTED ATTENUATORS

Truck/Trailer-mounted attenuators (TMA) can be used for moving operations and short-term stationary operations. For moving operations, see Index Nos. 607 and 619. For short-term, stationary operations, see Part VI of the MUTCD.

## CHANNELIZING DEVICES

Channelizing devices for work zone traffic control shall be as prescribed in Part VI of the MUTCD, subject to supplemental revisions provided in the contract documents and Index 600 requirements. Lighting Devices must not be used to supplement channelization.

## CHANNELIZING DEVICE CONSISTENCY

Barricades, vertical panels, cones, tubular markers and drums shall not be intermixed within either the lateral transition or within the tangent alignment.

LAST REVISION 07/01/15	REVISION	DESCRIPTION:	 FY 2016-17 DESIGN STANDARDS	GENERAL INFORMATION FOR TRAFFIC CONTROL THROUGH WORK ZONES	INDEX NO. 600	SHEET NO. 8 of 12
---------------------------	----------	--------------	---	---	------------------	----------------------



**DROP-OFF CONDITION NOTES**

1. These conditions and treatments can be applied only in work areas that fall within a properly signed work zone.
2. A drop-off is defined as a drop in elevation, parallel to the adjacent travel lanes, greater than 3" with slope (A:B) steeper than 1:4 and an algebraic difference in slopes greater than 0.25 (See Drop-off Condition Detail). When drop-offs occur within the clear zone due to construction or maintenance activities, protection devices are required (See Table 1).
3. Drop-offs may be mitigated by placement of slopes with optional base material per Specifications Section 285. Slopes shallower than 1:4 may be required to avoid algebraic difference in slopes greater than 0.25. Include the cost for the placement and removal of the material in Maintenance of Traffic, LSD. Use of this treatment in lieu of a barrier is not eligible for CSIP consideration. Conduct daily inspections for deficiencies related to erosion, excessive slopes, rutting or other adverse conditions. Repair any deficiencies immediately.
4. Distance X is to be the maximum practical under project conditions.
5. For Clear Zone widths, see Index No. 600, Sheet 3.
6. For Setback Distance, refer to the Standard Index drawing of the selected barrier for the required deflection space.
7. Distance from the travel lane to the barrier or warning device should be maximum practical for project conditions.
8. For Conditions 1 and 3 provided in Table 1, any drop-off condition that is created and restored within the same work period will not be subject to the use of barriers; however, warning devices will be required.
9. When permanent curb heights are  $\geq 6"$ , no warning device will be required. For curb heights  $< 6"$ , see Table 1.
10. Where a barrier is specified, any of the types below may be used in accordance with the applicable Index:
 

Index No.	Description
400	Guardrail
412	Low Profile Barrier
414	Type K Temporary Concrete Barrier System
415	Temporary Concrete Barrier

For other types of temporary barriers see the APL.
11. Drop-off condition and protection requirements apply to all speeds.

Condition	X (ft)	D (in.)	Device Required
1	0-12	> 3	Barrier (See Note 8)
2	12-CZ	> 3 to $\leq 5$	Warning Device
3	0-CZ	> 5	Barrier (See Note 8)
4	Removal of Bridge or Retaining Wall Barrier		Barrier
5	Removal of portions of Bridge Deck		Barrier

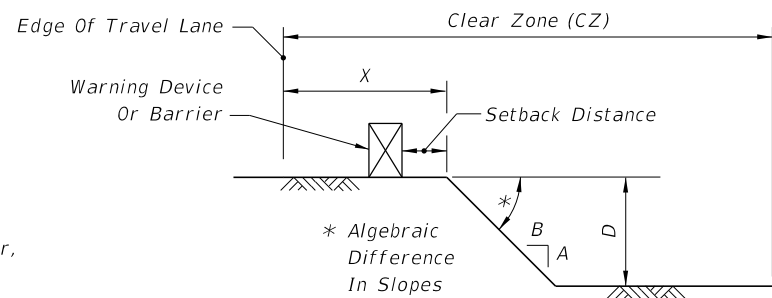

**DROP-OFF CONDITION DETAIL**

**TRAVEL LANE TREATMENT FOR MILLING OR RESURFACING NOTES**

1. This treatment applies to resurfacing or milling operations between adjacent travel lanes.
2. Whenever there is a difference in elevation between adjacent travel lanes, the W8-11 sign with "UNEVEN LANES" is required at intervals of 1/2 mile maximum.
3. If D is 1 1/2" or less, no treatment is required.
4. Treatment allowed only when D is 3" or less.
5. If the slope is steeper than 1:4 (not to be steeper than 1:1), the R4-1 and MOT-1-06 signs shall be used as a supplement to the W8-11; this condition should never exceed 3 miles in length.

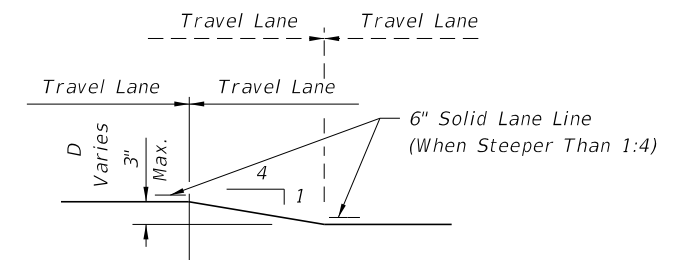

**TRAVEL LANE TREATMENT FOR MILLING OR RESURFACING DETAIL**

**PEDESTRIAN AND/OR BICYCLIST WAY DROP-OFF CONDITION NOTES**

1. A pedestrian and/or bicyclist way drop-off is defined as:
  - a. a drop in elevation greater than 10" that is closer than 2' from the edge of the pedestrian or bicyclist way
  - b. a slope steeper than 1:2 that begins closer than 2' from the edge of the pedestrian or bicyclist way when the total drop-off is greater than 60"
2. Protect any drop-off adjacent to a pedestrian or bicyclist way with warning devices, temporary barrier wall, or approved handrail.

**WARNING DEVICE NOTES**

1. The following are defined as acceptable warning devices:
  - a. Vertical panel
  - b. Type I Or Type II barricades
  - c. Drum
  - d. Cone (where allowed)
  - e. Tubular marker (where allowed)
2. Use the warning device spacing shown in Table 2.

Speed (mph)	Max. Distance Between Devices (ft)			
	Cones or Tubular Markers		Type I or Type II Barricades or Vertical Panels or Drums	
	Taper	Tangent	Taper	Tangent
25	25	50	25	50
30 to 45	25	50	30	50
50 to 70	25	50	50	100

**DROP-OFFS IN WORK ZONES**

12/31/2015 11:38:20 AM

Speed (mph)	Max. Distance Between Devices (ft.)			
	Tubular Markers		Vertical Panels or Opposing Traffic Lane Divider	
	Taper	Tangent	Taper	Tangent
25	25	50	25	50
30 to 45	25	50	30	50
50 to 70	25	50	50	100

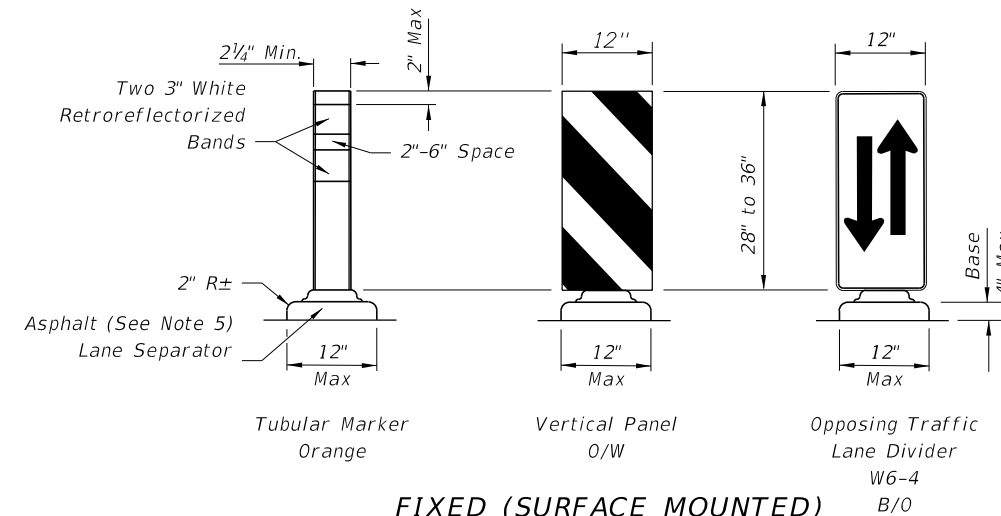
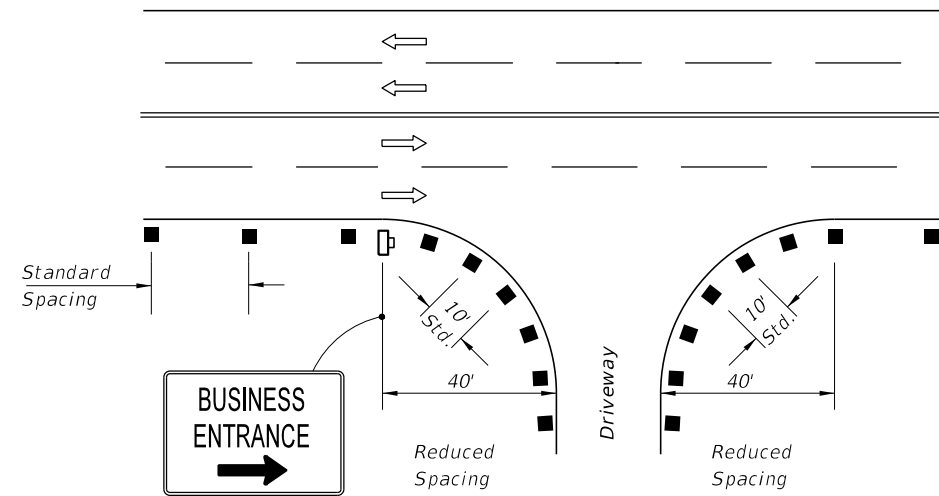
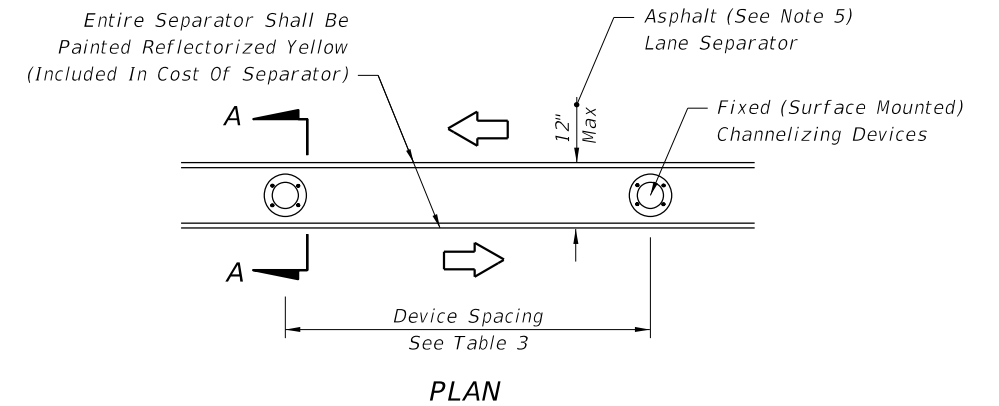

FIXED (SURFACE MOUNTED)  
CHANNELIZING DEVICES

SECTION AA

1. For single business entrances, place one 24" x 36" business sign for each driveway entrance affected. Signs shall show specific business names. Logos may be provided by business owners. Standard BUSINESS ENTRANCE sign in Index 17355 may be used when approved by the Engineer.
2. When several businesses share a common driveway entrance, place one 24" x 36" standard BUSINESS ENTRANCE sign in accordance with Index 17355 at the common driveway entrance.
3. Channelizing devices shall be placed at a reduced spacing on each side of the driveway entrance, but shall not restrict sight distance for the driveway users.
4. Business entrance signs are intended to guide motorist to business entrances moved/modified or disturbed during construction projects. Business entrance signs are not required where there is minimal disruption to business driveways which is often the case with resurfacing type projects.

1. Temporary lane separators shall be supplemented with any of the following approved fixed (surface mounted) channelizing devices: tubular markers, vertical panels, or opposing traffic lane divider panels. Opposing traffic lane divider panels (W6-4) shall only be used as center lane dividers to separate opposing vehicular traffic on a two-lane, two-way operation. Tubular Markers, Vertical Panels and Opposing Traffic Lane Divider panels shall not be intermixed within the limits where the temporary lane separator is used. The connection between the channelizing device and the temporary lane separator curb shall hold the channelizing device in a vertical position.
2. Reflectorized materials shall have a smooth sealed outer surface which will display the same approximate color day and night. Furnish channelizing devices having retroreflective sheeting meeting the requirements of Section 990.
3. 12" openings for drainage shall be constructed in the asphalt and portable temporary lane separator at a maximum spacing of 25' in areas with grades of 1% or less or 50' in areas with grades over 1% as directed by the Engineer.
4. Tapered ends shall be used at the beginning and end of each run of the temporary lane separator to form a gradual increase in height from the pavement level to the top of the temporary lane separator.
5. The Contractor has the option of using portable temporary lane separators containing fixed channelizing devices in lieu of the temporary asphalt separator and channelizing devices detailed on this sheet. The portable temporary lane separator shall come in portable sections that can be connected to maintain continuous alignment between the separate curb sections. Each temporary lane separator section shall be 36 inches to 48 inches in total length. Portable temporary lane separators shall duplicate the color of the pavement marking. Portable temporary lane separators shall be one of those listed on the Approved Products List.
6. Any damage to existing pavement caused by the removal of temporary lane separator shall be satisfactorily repaired and the cost of such repairs are to be included in the cost of Maintenance of Traffic, LS.

PLACEMENT OF BUSINESS ENTRANCE SIGNS AND  
CHANNELIZING DEVICES AT BUSINESS ENTRANCE

TEMPORARY LANE SEPARATOR

12/3/2015 11:38:21 AM

LAST REVISION 07/01/15	DESCRIPTION:		FY 2016-17 DESIGN STANDARDS	GENERAL INFORMATION FOR TRAFFIC CONTROL THROUGH WORK ZONES	INDEX NO. 600	SHEET NO. 10 of 12

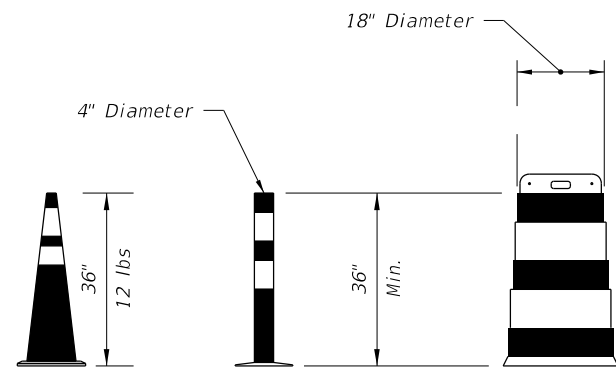

**CONES TUBULAR MARKER PLASTIC DRUMS**

TUBULAR NON-FIXED  
MARKER TO BE USED  
DURING DAYLIGHT ONLY

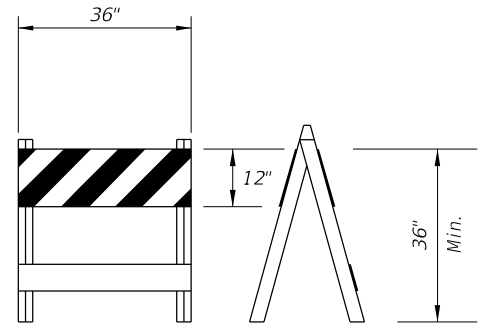

**TYPE I BARRICADE**

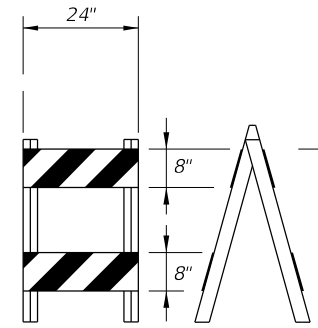

**TYPE II BARRICADE**

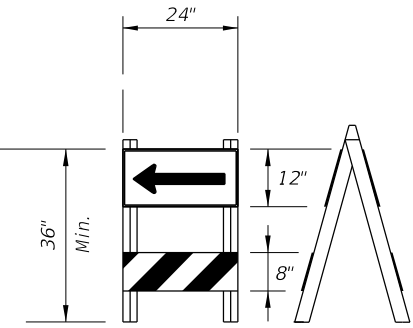

**DIRECTION INDICATOR  
BARRICADE**

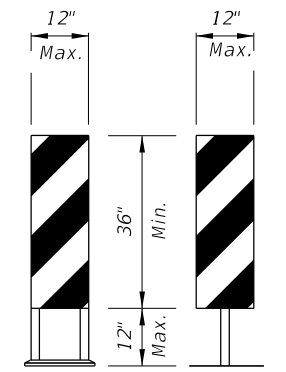

**A-FRAME POST MOUNT  
VERTICAL PANEL**

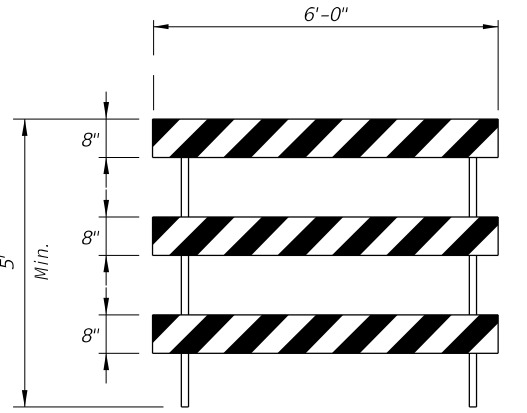

**TYPE III BARRICADE**

**CHANNELIZING DEVICE NOTES**

- The details shown on this sheet are for the following purposes:
  - For ease of identification and
  - To provide information that supplements or supersedes that provided by the MUTCD.
- The Type III Barricade shall have a unit length of 6'-0" only. When barricades of greater lengths are required those lengths shall be in multiples of the 6'-0" unit.
- No sign panel should be mounted on any channelizing device unless the channelizing device/sign combination was found to be crashworthy and the sign panel is mounted in accordance with the vendor drawing for the channelizing device shown on the APL.
- Ballast shall not be placed on top rails or any striped rails or higher than 13" above the driving surface.
- The direction indicator barricade may be used in tapers and transitions where specific directional guidance to drivers is necessary. If used, direction indicator barricades shall be used in series to direct the driver through the transition and into the intended travel lane.
- The splicing of sheeting is not permitted on either channelizing devices or MOT signs.
- For rails less than 3'-0" long, 4" stripes shall be used.
- Cones shall:
  - Be used only in active work zones where workers are present.
  - Not exceed 2 miles in length of use at any one time.
  - Be reflectorized as per the MUTCD with Department-approved reflective collars when used at night.

- Spacing for longitudinal channelizing devices when placed singly shall be the same as Type I or Type II barricades or drums.
- Vehicular longitudinal channelizing devices shall not exceed 36" in height. For vehicular longitudinal channelizing devices (LCDs) less than 32" in height, the LCD shall be supplemented with approved fixed (surface mounted) channelizing devices (tubular markers, vertical panels, etc.) along the run of the LCD, at the ends, at 50' centers on tangents, and 25' centers on radii. The cost of the fixed supplemented channelizing devices shall be included in the cost of the LCD. LCDs less than 32" in height shall not be used for speeds greater than 45 mph.
- For pedestrian longitudinal channelizing devices, the device shall have a minimum of 8" continuous detectable edging above the walkway. A gap not exceeding a height of 2" is allowed to facilitate drainage. The top surface of the device shall be a minimum height of 32" and have smooth connection points between the devices to facilitate hand trailing. The bottom and the top surface of the device shall be in the same vertical plane. If pedestrian drop-off protection is required, the device shall have a footprint or offset of at least 2', otherwise the device must be at least 42" in height above the walkway and be anchored or ballasted to withstand a 200 lb lateral point load at the top of the device.
- For vehicular longitudinal channelizing devices, use Barrier Delineators meeting Specifications Section 993. Place on top of unit so that retroreflective sheeting faces vehicular traffic. Spacing must be a maximum of 50' centers in transitions, 100' centers on curves and 200' centers on tangents. Color must match adjacent longitudinal pavement marking.

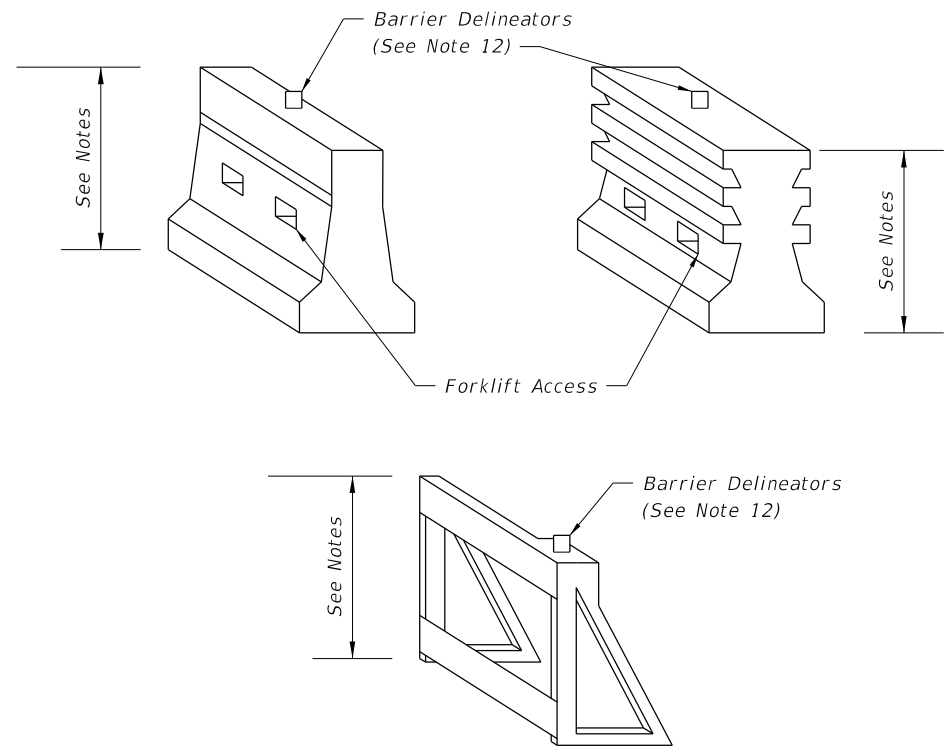

**LONGITUDINAL CHANNELIZING DEVICE**

**IDENTIFICATIONS - CHANNELIZING DEVICES**

12/3/2015 11:38:22 AM

LAST REVISION 07/01/15	DESCRIPTION:	<b>FY 2016-17 DESIGN STANDARDS</b>	<b>GENERAL INFORMATION FOR TRAFFIC CONTROL THROUGH WORK ZONES</b>	INDEX NO. <b>600</b>	SHEET NO. <b>11 of 12</b>
---------------------------	--------------	--	---	-------------------------	------------------------------

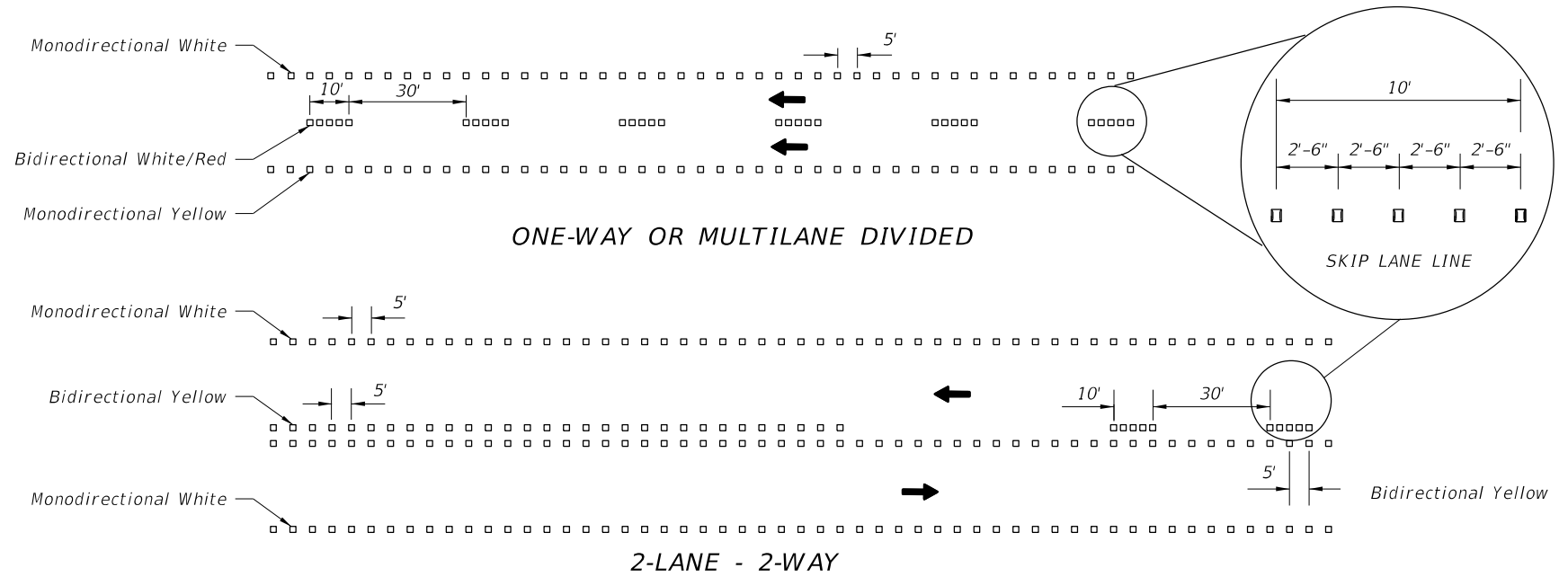

**TEMPORARY SUBSTITUTION OF RPM'S FOR PAINT OR REMOVABLE TAPE**

1. Paint or removable tape are the required work zone markings and shall be placed in accordance with the plans and specifications. If these work zone markings can not be placed due to weather restrictions identified in the appropriate specification, temporary substitution of RPM's for work zone markings will be allowed until the weather condition permits the placement of appropriate work zone marking. Temporary substitution of RPM's for work zone markings will be allowed for equipment malfunction, placement of the appropriate work zone marking shall be made within 3 days, or sooner if possible. When RPM's are used as a temporary substitution for work zone markings the following shall apply:
  - a. Lane widths identified in the plans must be maintained. Placement of RPM's should consider where work zone markings will be placed as soon as conditions allow. If the RPM's can not be placed so that the lane width is maintained after the placement of the work zone markings, the conflicting RPM's must be removed.
  - b. The color of the RPM body and the reflective face shall conform to the color of the marking for which they substitute.
  - c. In work zones, B RPM's must be used to form lane lines, edge lines and temporary gore areas as a temporary substitute for paint or removable tape at the spacing shown above.

**NOTES FOR REFLECTIVE PAVEMENT MARKERS**

1. The color of the raised pavement marker under both day and night conditions shall conform to the color of the marking for which they serve as a positioning guide, or for which they supplement or substitute.
2. To provide contrast on concrete pavement, or light asphalt, the five (5) white RPM's shall be followed by five black RPM's. The spacing between RPM's shall be 2'-6". Black RPM's will not be required for contrast with yellow RPM's.
3. RPM's used to supplement lane lines are to be paid for as Reflective Pavement Marker (Temporary), EA. RPM's used as a temporary substitute for paint or removable tape due to weather restrictions are to be paid for as Reflective Pavement Marker (Temporary), EA. RPM's used as a temporary substitute for paint or removable tape due to equipment malfunction are to be placed at the Contractor's expense.

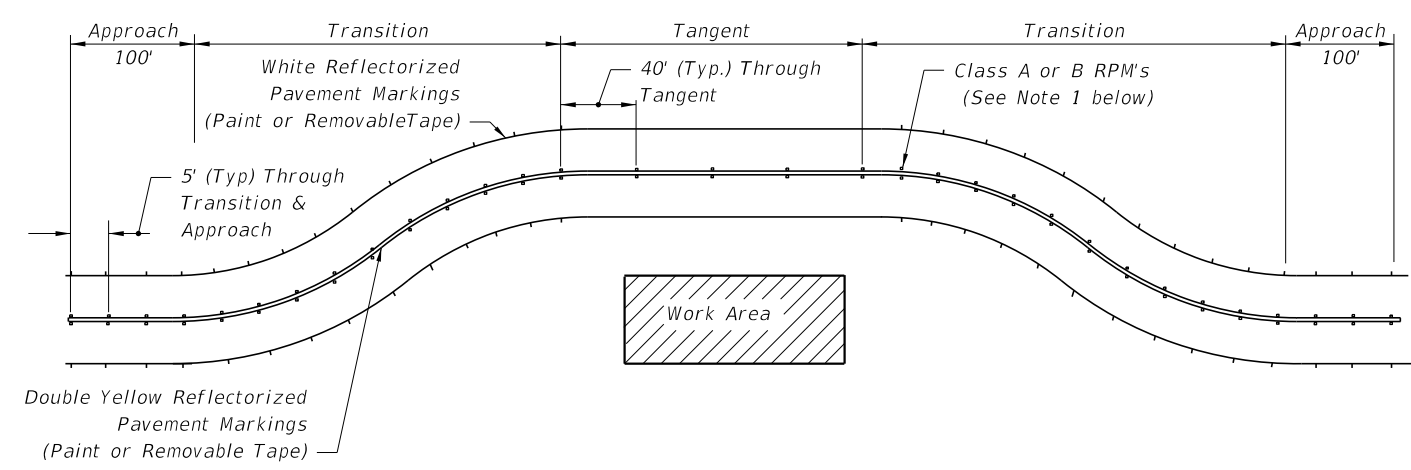

**USE OF RPM'S TO SUPPLEMENT PAINT OR REMOVABLE TAPE IN WORK ZONES**

1. RPM's shall be installed as a supplement to:
  - a. All lane lines.
  - b. Edge lines in transition & approach areas.
  - c. Edge lines of gore areas.
2. Placement of RPM's should be as shown in Index No. 17352 with the following exceptions:
  - RPM's shall be placed at 5 feet center to center in approach and transition areas.

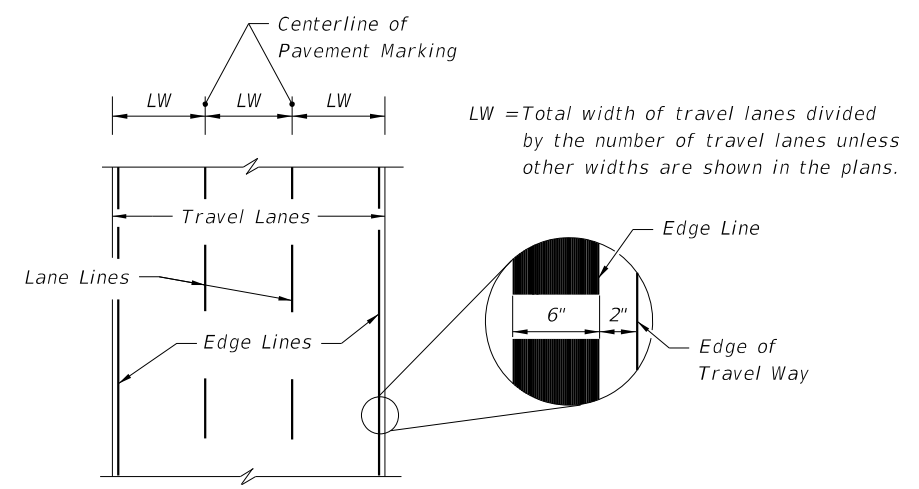

**PLACEMENT OF PAVEMENT MARKINGS**

**PAVEMENT MARKINGS**

12/3/2015 11:38:23 AM

LAST REVISION 01/01/16	REVISION	DESCRIPTION:	 <b>FY 2016-17 DESIGN STANDARDS</b>	<b>GENERAL INFORMATION FOR TRAFFIC CONTROL THROUGH WORK ZONES</b>	INDEX NO. <b>600</b>	SHEET NO. <b>12 of 12</b>
---------------------------	----------	--------------	---	---	-------------------------	------------------------------

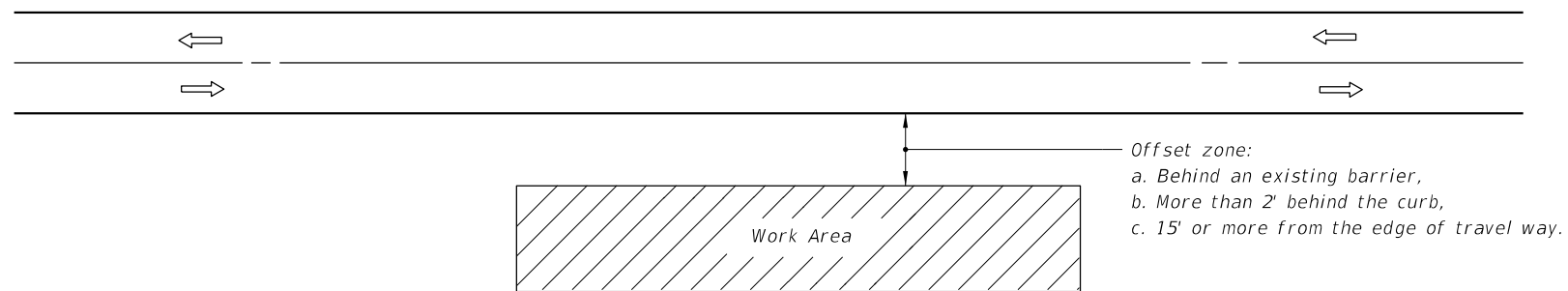

**GENERAL NOTES**

1. If the work operation (excluding establishing and terminating the work area) requires that two or more work vehicles cross the offset zone in any one hour, traffic control will be in conformance with Index No. 602.
2. No special signing is required.
3. When a side road intersects the highway within the work area, additional TTC devices shall be placed in accordance with other applicable TCZ Indexes.
4. When construction activities encroach on a sidewalk refer to Index No. 660.
5. For general TCZ requirements and additional information, refer to Index No. 600.

**CONDITIONS**

WHERE ANY VEHICLE, EQUIPMENT, WORKERS AND THEIR ACTIVITIES ARE BEHIND AN EXISTING BARRIER, MORE THAN 2' BEHIND THE CURB, OR 15' OR MORE FROM THE EDGE OF TRAVEL WAY.

**SYMBOLS**

-  Work Area
-  Lane Identification + Direction of Traffic

12/31/2015 11:38:24 AM

LAST REVISION 07/01/05	REVISION	DESCRIPTION:	 <b>FY 2016-17 DESIGN STANDARDS</b>	<b>TWO-LANE, TWO-WAY, WORK OUTSIDE SHOULDER</b>	INDEX NO. <b>601</b>	SHEET NO. <b>1 of 1</b>
---------------------------	----------	--------------	--	---	-------------------------	----------------------------

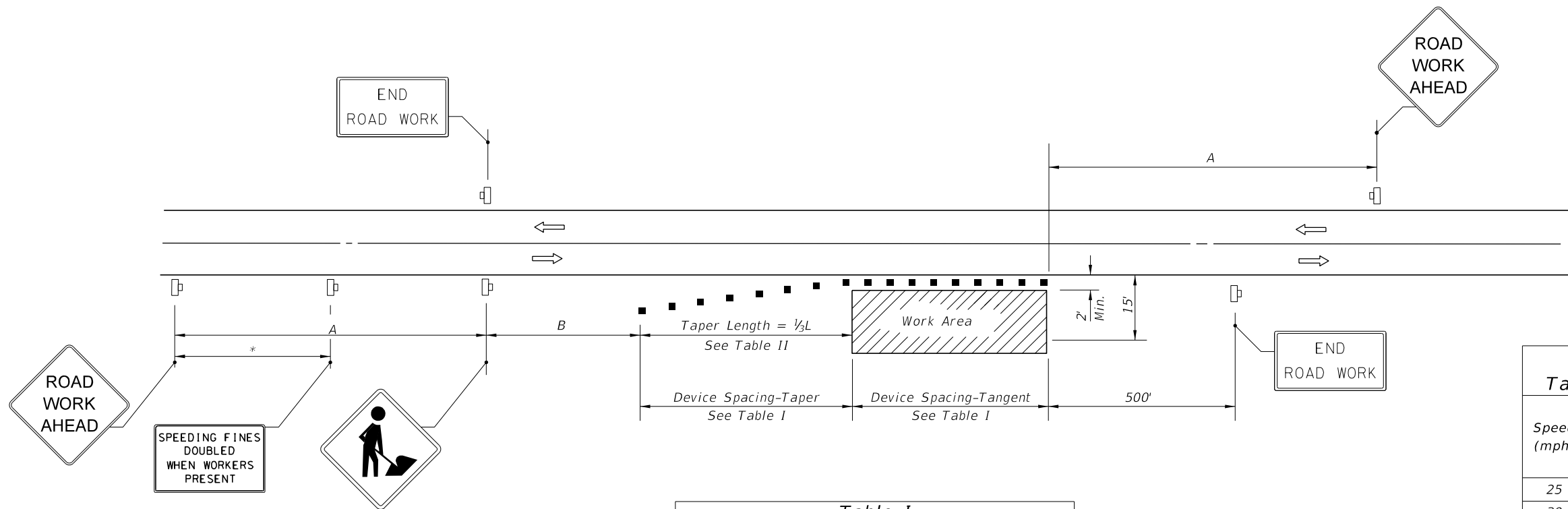

Speed	Spacing (ft.)	
	A	B
40 mph or less	200	200
45 mph	350	350
50 mph or greater	500	500

\*Midway between signs.

Speed (mph)	Max. Distance Between Devices (ft.)			
	Cones or Tubular Markers		Type I or Type II Barricades or Vertical Panels or Drums	
	Taper	Tangent	Taper	Tangent
25	25	50	25	50
30 to 45	25	50	30	50
50 to 70	25	50	50	100

Speed (mph)	1/3 L (ft)			Notes
	8' Shldr.	10' Shldr.	12' Shldr.	
25	28	35	42	$L = \frac{WS^2}{60}$
30	40	50	60	
35	55	68	82	
40	72	90	107	L=WS
45	120	150	180	
50	133	167	200	
55	147	183	220	
60	160	200	240	
65	173	217	260	
70	187	233	280	

8' minimum shoulder width

1/3 L = Length of shoulder taper in feet

W = Width of total shoulder in feet (combined paved and unpaved width)

S = Posted speed limit (mph)

### SYMBOLS

- Work Area
- Channelizing Device (See Index No. 600)
- Work Zone Sign
- Lane Identification + Direction of Traffic

### GENERAL NOTES

- When four or more work vehicles enter the through traffic lanes in a one hour period or less (excluding establishing and terminating the work area), the advanced FLAGGER sign shall be substituted for the WORKERS sign. For location of flaggers and FLAGGER signs, see Index No. 603.
- SHOULDER WORK sign may be used as an alternate to the WORKER symbol sign only on the side where the shoulder work is being performed.
- When a side road intersects the highway within the TTC zone, additional TTC devices shall be placed in accordance with other applicable TCZ Indexes.
- For general TCZ requirements and additional information, refer to Index No. 600.

### DURATION NOTES





- Signs and channelizing devices may be omitted if all of the following conditions are met:
  - Work operations are 60 minutes or less.
  - Vehicles in the work area have high-intensity, rotating, flashing, oscillating, or strobe lights operating.

### CONDITIONS

WHERE ANY VEHICLE, EQUIPMENT, WORKERS OR THEIR ACTIVITIES ENCROACH THE AREA CLOSER THAN 15' BUT NOT CLOSER THAN 2' TO THE EDGE OF TRAVEL WAY.

12/3/2015 11:38:24 AM

**SYMBOLS:**

-  Work Area
-  Channelizing Device (See Index No. 600)
-  Work Zone Sign
-  Flagger
-  Lane Identification + Direction of Traffic

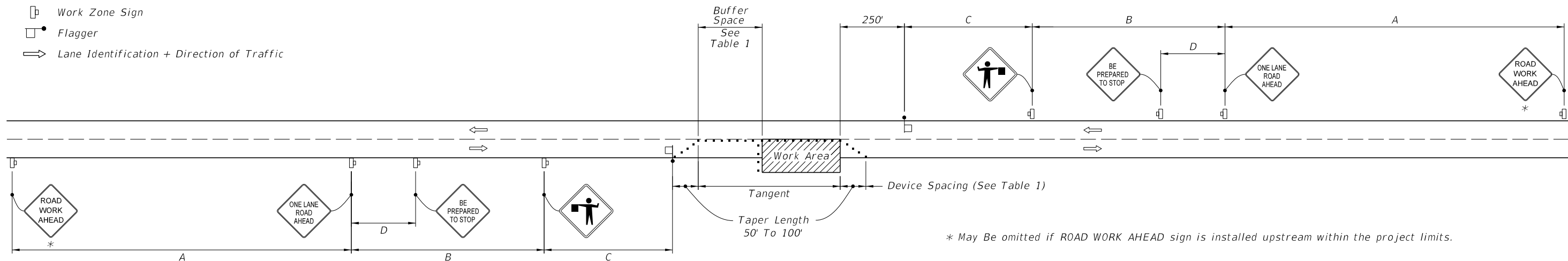

\* May Be omitted if ROAD WORK AHEAD sign is installed upstream within the project limits.

**WITHOUT TEMPORARY RAISED RUMBLE STRIPS**

**GENERAL NOTES:**

1. Special Conditions may be required in accordance with these notes and the following sheets:
  - A. Railroad Crossings:
    - a. If an active railroad crossing is located closer to the Work Area than the queue length plus 300 feet, extend the Buffer Space as shown on Sheet 3.
    - b. If the queuing of vehicles across an active railroad crossing cannot be avoided, provide a uniformed traffic control officer or flagger at the highway-rail grade crossing to prevent vehicles from stopping within the highway-rail grade crossing, even if automatic train warning devices are in place.
  - B. If the Work Area encroaches on the Centerline, use the Layout for Temporary Lane Shift to Shoulder on Sheet 3 only if the Existing Paved Shoulder width is sufficient to provide for an 11' lane between the Work Area and the Edge of Existing Paved Shoulder. Reduce the posted speed when appropriate.
2. Temporary Raised Rumble Strips:
  - A. Use when both of the following conditions are met concurrently:
    - a. Existing Posted Speed is 55 mph or greater;
    - b. Work duration is greater than 60 minutes.
  - B. Use a consistent Strip color throughout the work zone.
  - C. Place each Rumble Strip Set transversely across the lane at locations shown.
  - D. Use Option 1 or Option 2 as shown on Sheet 2. Use only one option throughout work zone.
3. Additional one-way control may be provided by the following means:
  - A. Flag-carrying vehicle;
  - B. Official vehicle;
  - C. Pilot vehicles;
  - D. Traffic signals.

When flaggers are the sole means of one-way control, the flaggers must be in sight of each other or in direct communication at all times.
4. When a side road intersects the highway within the TTC zone, place additional TTC devices in accordance with other applicable TCZ Indexes.
5. The two channelizing devices directly in front of the work area may be omitted provided vehicles in the work area have high-intensity rotating, flashing, oscillating, or strobe lights operating.
6. When Buffer Space cannot be attained due to geometric constraints, use the greatest attainable length, not less than 200 ft, for posted speeds greater than 25 mph.
7. ROAD WORK AHEAD and the BE PREPARED TO STOP signs may be omitted if all of the following conditions are met:
  - A. Work operations are 60 minutes or less.
  - B. Speed limit is 45 mph or less.
  - C. There are no sight obstructions to vehicles approaching the work area for a distance equal to the Buffer Space shown in Table 1.
  - D. Vehicles in the work area have high-intensity, rotating, flashing, oscillating, or strobe lights operating.
  - E. Volume and complexity of the roadway has been considered.
  - F. If a railroad crossing is present, vehicles will not queue across rail tracks.
  - G. AFADs are not in use.
8. See Index 600 for general TCZ requirements and additional information.
9. Automated Flagger Assistance Devices (AFADs) may be used in accordance with Specifications Section 102, 990 and the APL vendor drawings.

TABLE 1									
Posted Speed	DEVICE SPACING				Distance Between Signs				Buffer Space
	Maximum Spacing of Cones or Tubular Markers		Maximum Spacing of Type I or Type II Barricades/Panels/Drums		A	B	C	D	
	On a Taper	On a Tangent	On a Taper	On a Tangent					
25	20'	50'	20'	50'	200'	200'	200'	100'	155'
30	20'	50'	20'	50'	200'	200'	200'	100'	200'
35	20'	50'	20'	50'	200'	200'	200'	100'	250'
40	20'	50'	20'	50'	200'	200'	200'	100'	305'
45	20'	50'	20'	50'	350'	350'	350'	175'	360'
50	20'	50'	20'	100'	500'	500'	500'	250'	425'
55	20'	50'	20'	100'	2640'	1500'	1000'	500'	495'
60	20'	50'	20'	100'	2640'	1500'	1000'	500'	570'
65	20'	50'	20'	100'	2640'	1500'	1000'	500'	645'
70	20'	50'	20'	100'	2640'	1500'	1000'	500'	730'





**CONDITIONS**

WHERE ANY VEHICLE, EQUIPMENT, WORKERS OR THEIR ACTIVITIES ENCROACH THE AREA BETWEEN THE CENTERLINE AND A LINE 2' OUTSIDE THE EDGE OF TRAVEL WAY.

12/31/2015 11:38:26 AM

LAST REVISION 01/01/16	REVISION	DESCRIPTION:	 <b>FY 2016-17 DESIGN STANDARDS</b>	<b>TWO-LANE, TWO-WAY, WORK WITHIN THE TRAVEL WAY</b>	INDEX NO. <b>603</b>	SHEET NO. <b>1 of 3</b>
---------------------------	----------	--------------	---	--	-------------------------	----------------------------

**SYMBOLS:**

-  Work Area
-  Channelizing Device (See Index No. 600)
-  Work Zone Sign
-  Flagger
-  Lane Identification + Direction of Traffic

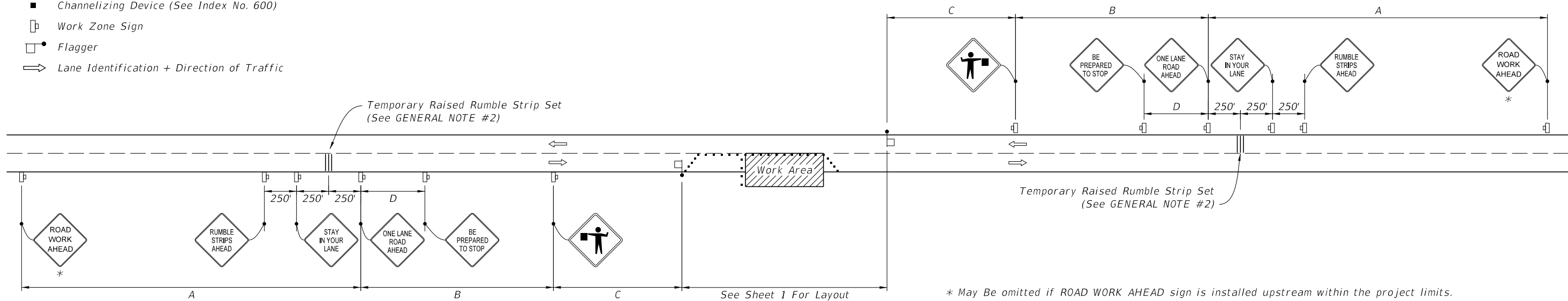

**WITH TEMPORARY RAISED RUMBLE STRIPS**  
(When Required See GENERAL NOTE #2)

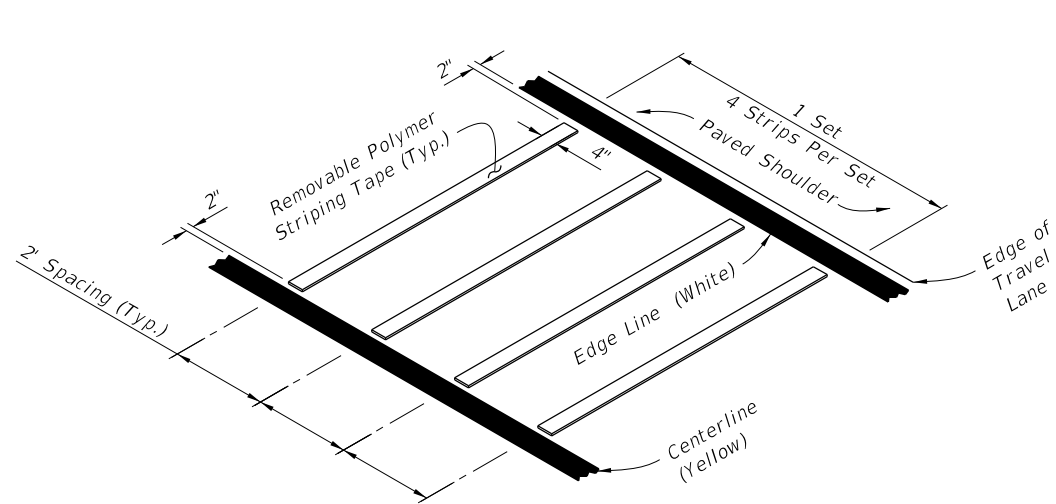

REMOVABLE POLYMER STRIPING TAPE

RUMBLE STRIP SET  
OPTION - 1

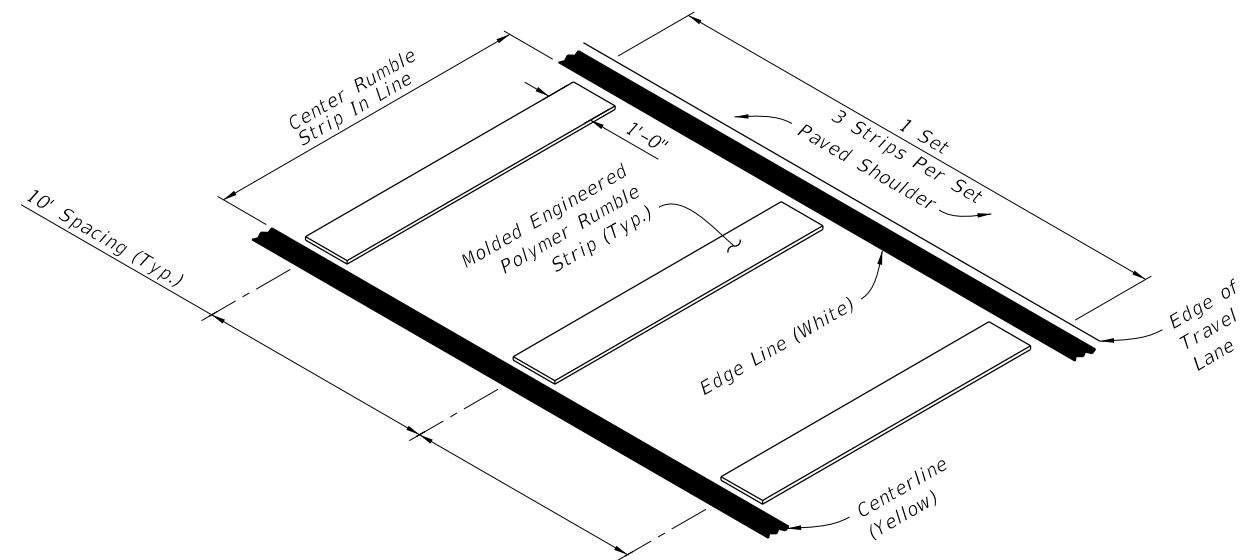

MOLDED ENGINEERED POLYMER SET

RUMBLE STRIP SET  
OPTION - 2





**TEMPORARY RAISED RUMBLE STRIPS**

2/11/2016 1:39:37 PM

LAST REVISION 02/04/16	REVISION	DESCRIPTION:	 <b>FY 2017-18 DESIGN STANDARDS</b>	<b>TWO-LANE, TWO-WAY, WORK WITHIN THE TRAVEL WAY</b>	INDEX NO. <b>603</b>	SHEET NO. <b>2 of 3</b>
---------------------------	----------	--------------	---	--	-------------------------	----------------------------



**SYMBOLS:**

-  Work Area
-  Channelizing Device (See Index No. 600)
-  Work Zone Sign
-  Flagger
-  Lane Identification + Direction of Traffic

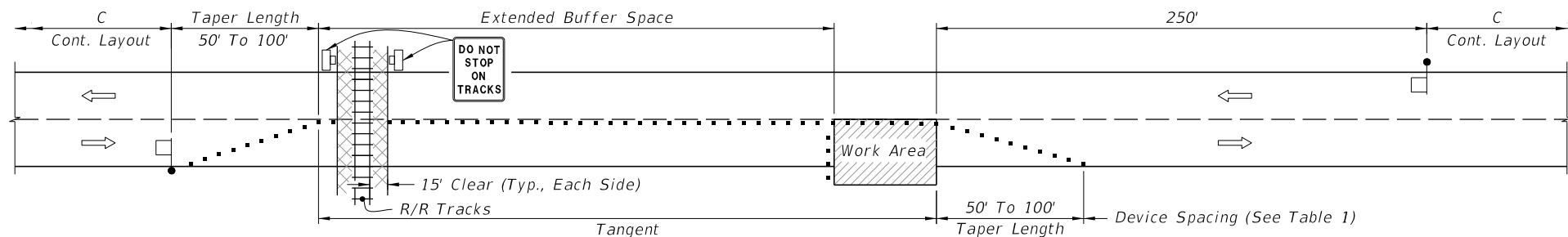

TEMPORARY RAILROAD CROSSING BUFFER SPACE EXTENSION

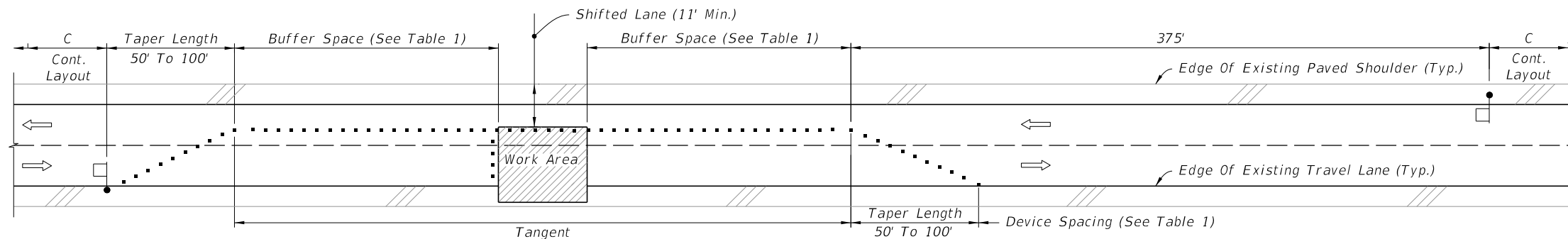

TEMPORARY LANE SHIFT TO SHOULDER WHEN WORK AREA ENCROACHES ON THE CENTERLINE

**SPECIAL CONDITIONS**

Cross Reference:  
1. See General Note #1, Sheet 1 for more information.

12/3/2015 11:38:28 AM

LAST REVISION 01/01/16	REVISION	DESCRIPTION:	 <b>FY 2016-17 DESIGN STANDARDS</b>	<b>TWO-LANE, TWO-WAY, WORK WITHIN THE TRAVEL WAY</b>	INDEX NO. <b>603</b>	SHEET NO. <b>3 of 3</b>
---------------------------	----------	--------------	---	--	-------------------------	----------------------------

**SPECIAL CONDITIONS**

12/3/2015 11:38:28 AM

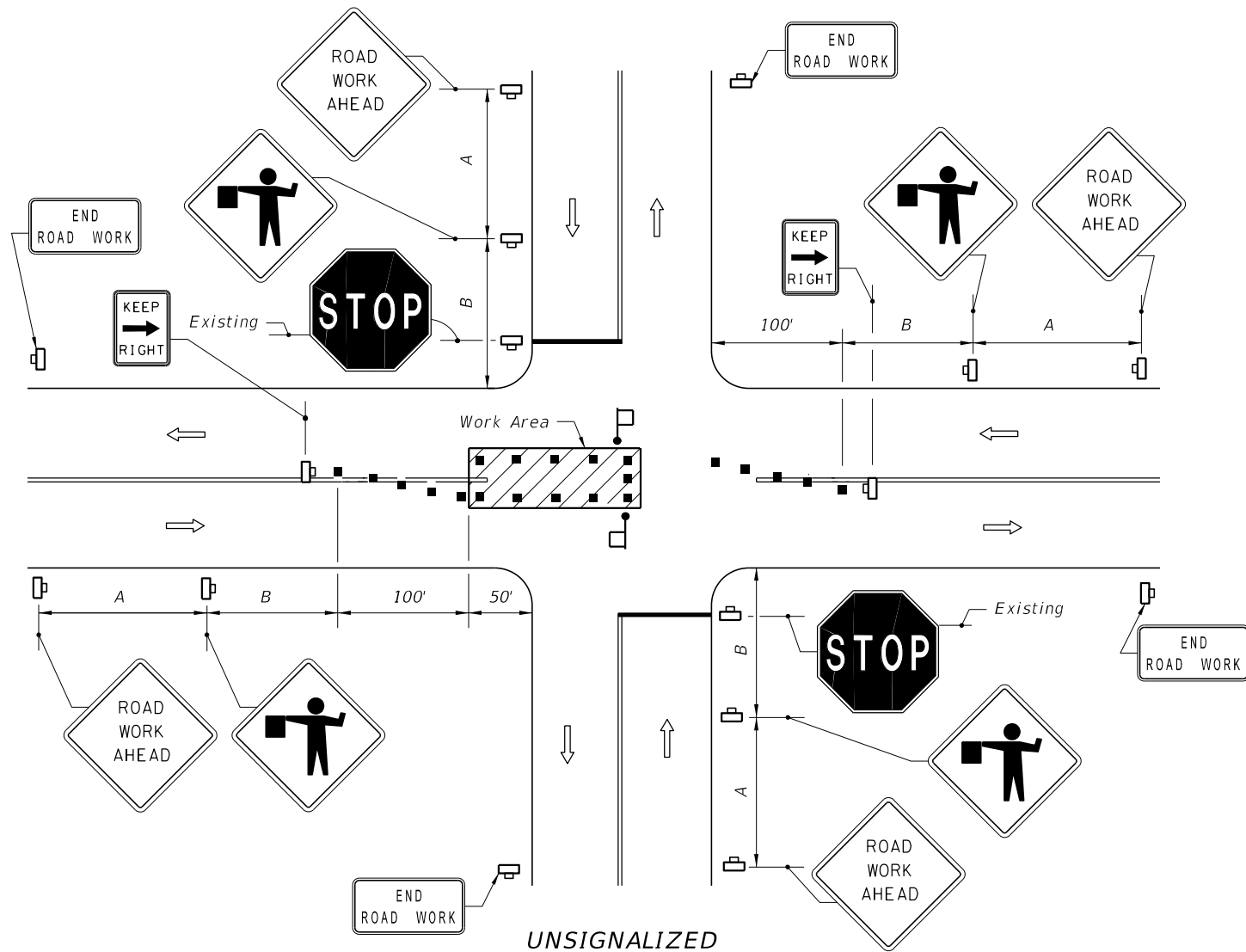

UNSIGNALIZED

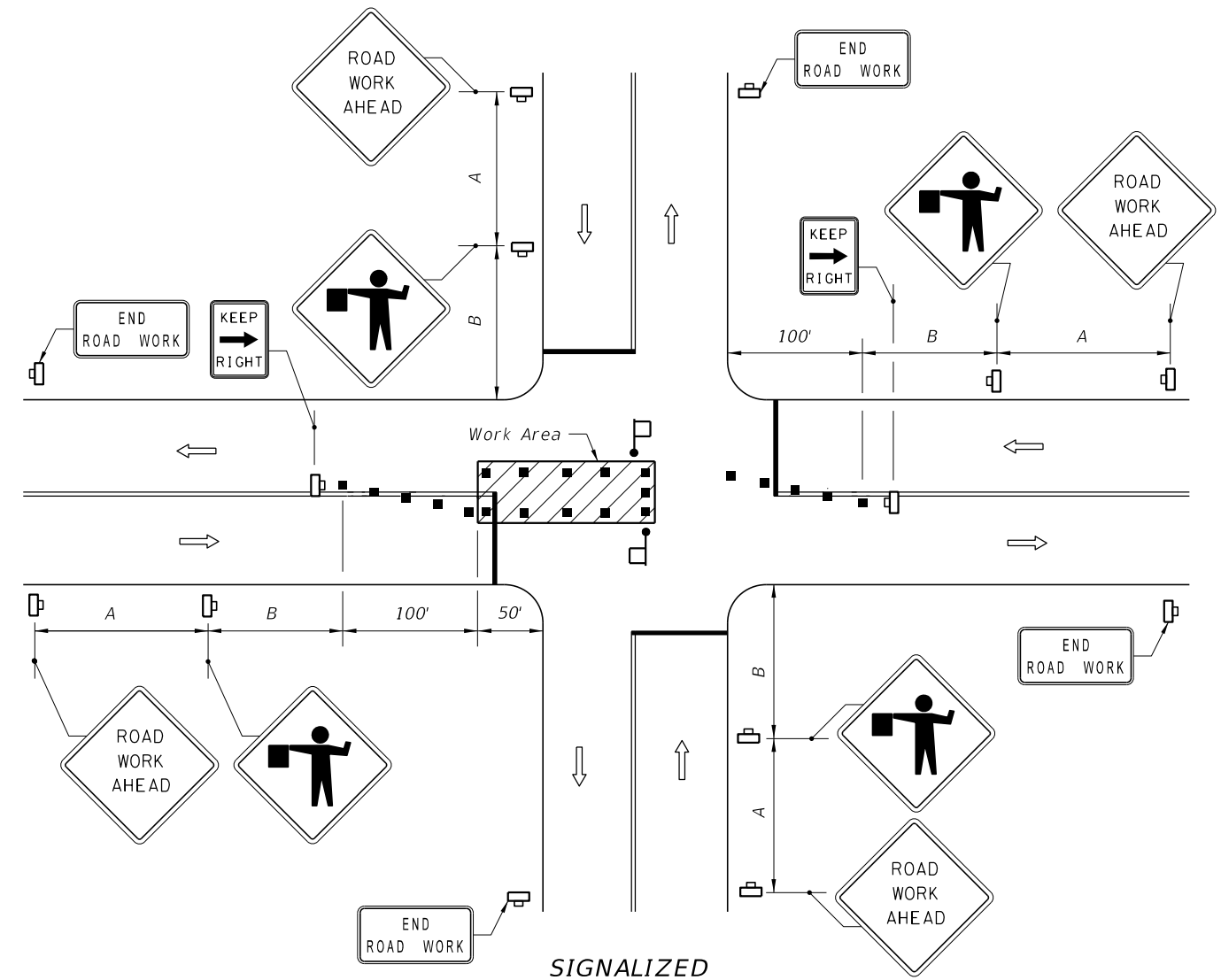

SIGNALIZED

**SYMBOLS**

- Work Area
- Channelizing Device (See Index No. 600)
- Work Zone Sign
- Flagger
- Stop Bar
- Lane Identification + Direction of Traffic

**GENERAL NOTES**

1. The FLAGGER legend sign may be substituted for the symbol sign.
2. When vehicles in a parking zone block the line of sight to TCZ signs, the signs shall be post mounted and located in accordance with Index No. 17302.
3. If the work space extends across a crosswalk, the crosswalk should be closed using the information in Index No. 660.
4. Flaggers shall be located where they can control more than one direction of traffic.  
  
Flaggers shall be in sight of each other or in direct communication at all times.
5. Maximum spacing between channelizing devices shall be not greater than 20'.
6. Temporary signal phasing modifications are to be approved by the District Traffic Operations Engineer prior to the beginning of work.
7. For general TCZ requirements and additional information, refer to Index No. 600.
8. For unsignalized intersections, use Temporary Raised Rumble Strips in accordance with Index 603. Placement of Rumble Strips and additional signs should begin at FLAGGER sign location.

**DURATION NOTES**

1. ROAD WORK AHEAD AND END ROAD WORK sign may be omitted if all of the following conditions are met:
  - a. Work operations are 60 minutes or less.
  - b. Speed is 45 mph or less.
  - c. No sight obstructions to vehicles approaching the work area for a distance equal to A plus B.
  - d. Vehicles in the work area have high-intensity, rotating, flashing, oscillating, or strobe lights operating.
  - e. Volume and complexity of the roadway has been considered.

**DISTANCE BETWEEN SIGNS**

Speed	Spacing (ft.)	
	A	B
40 mph or less	200	200
45 mph	350	350

**CONDITIONS**

WHERE ANY VEHICLE, EQUIPMENT, WORKERS OR THEIR ACTIVITIES ENCROACH ON THE PAVEMENT REQUIRING THE CLOSURE OF A PORTION OF ONE OR MORE TRAFFIC LANES IN AN INTERSECTION.

LAST REVISION  
07/01/15

REVISION  
DESCRIPTION:

FY 2016-17  
DESIGN STANDARDS

TWO-LANE, TWO-WAY, WORK IN INTERSECTION

INDEX NO.  
604

SHEET NO.  
1 of 1

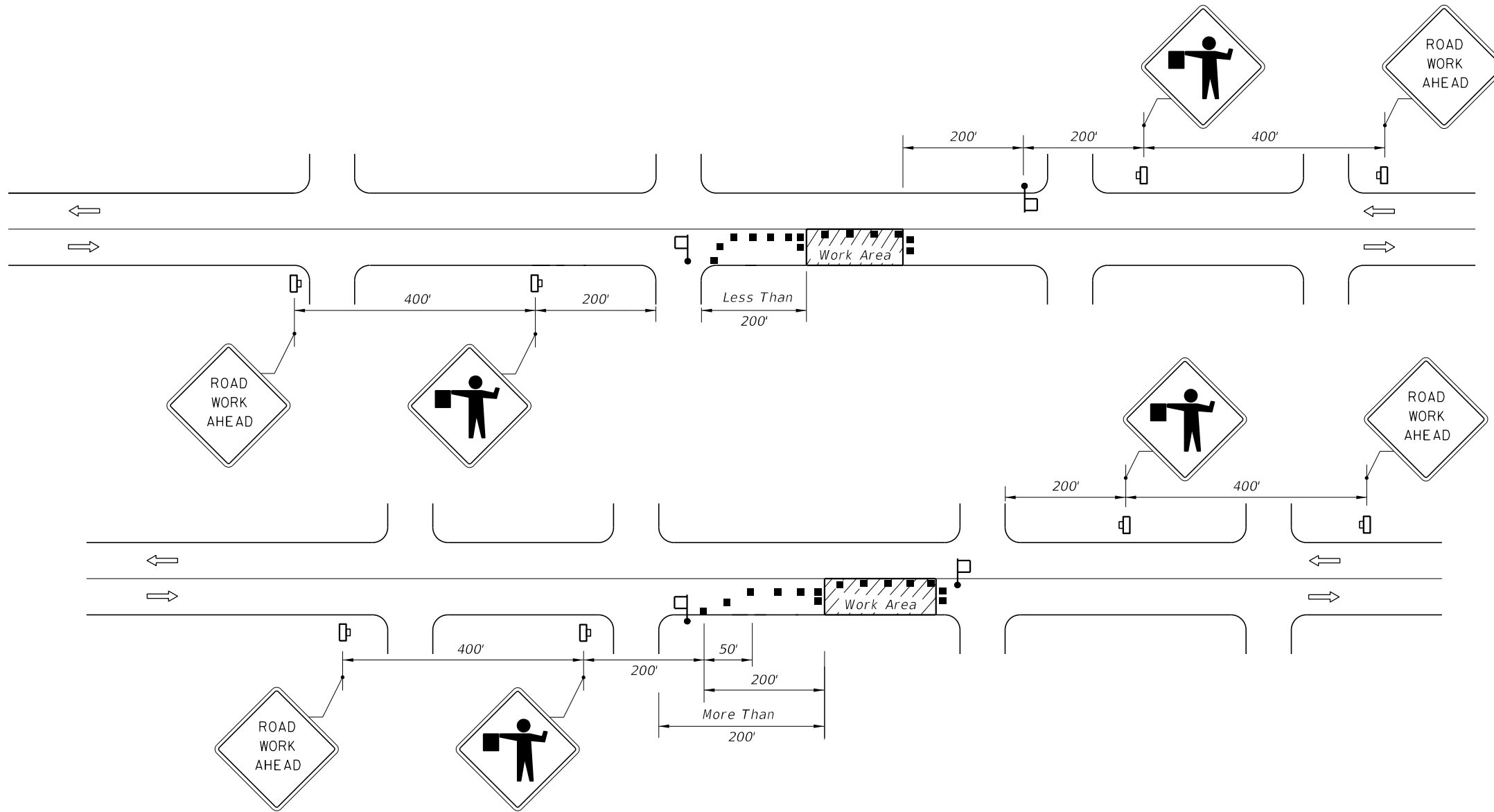

**CONDITIONS**

WHERE ANY VEHICLE, EQUIPMENT, WORKERS OR THEIR ACTIVITIES ENCROACH ON THE PAVEMENT REQUIRING THE CLOSURE OF ONE TRAFFIC LANE, FOR WORK AREAS LESS THAN 200' DOWNSTREAM FROM AN INTERSECTION FOR A PERIOD OF MORE THAN 60 MINUTES.

**CONDITIONS**

WHERE ANY VEHICLE, EQUIPMENT, WORKERS OR THEIR ACTIVITIES ENCROACH ON THE PAVEMENT REQUIRING THE CLOSURE OF ONE TRAFFIC LANE, FOR WORK AREAS 200' OR MORE DOWNSTREAM FROM AN INTERSECTION FOR A PERIOD OF MORE THAN 60 MINUTES.

**DURATION NOTES**

1. ROAD WORK AHEAD sign may be omitted if all of the following conditions are met:
  - a. Work operations are 60 minutes or less.
  - b. Speed is 45 mph or less.
  - c. No sight obstructions to vehicles approaching the work area for a distance of 600 feet.
  - d. Vehicles in the work area have high-intensity, rotating, flashing, oscillating, or strobe lights operating.
  - e. Volume and complexity of the roadway has been considered.

- SYMBOLS**
- Work Area
  - Channelizing Device (See Index No. 600)
  - Work Zone Sign
  - Flagger
  - Lane Identification + Direction of Traffic

**GENERAL NOTES**

1. Work operations shall be confined to one travel lane, leaving the opposing travel lane open to traffic.
2. When vehicles in a parking zone block the line of sight to TCZ signs or when TCZ signs encroach on a normal pedestrian walkway, the signs shall be post mounted and located in accordance with Index No. 17302.
3. If work area is confined to an outside auxiliary lane, the work area shall be barricaded and the FLAGGER signs replaced by ROAD WORK AHEAD signs. Flaggers are not required.
4. Flaggers shall be in sight of each other or in direct communication at all times.
5. The FLAGGER legend sign may be substituted for the symbol sign.
6. The maximum spacing between devices shall be no greater than 25'.
7. For general TCZ requirements and additional information, refer to Index No. 600.
8. The two channelizing devices directly in front and directly at the end of the work area may be omitted provided vehicles in the work area have high-intensity rotating, flashing, oscillating, or strobe lights operating.
9. Use Temporary Raised Rumble Strips in accordance with Index 603. Placement of Rumble Strips and additional signs should begin at FLAGGER sign location.

12/3/2015 11:38:29 AM

LAST REVISION 07/01/15	REVISION	DESCRIPTION:	 FY 2016-17 DESIGN STANDARDS	TWO-LANE, TWO-WAY, WORK NEAR INTERSECTION	INDEX NO. <b>605</b>	SHEET NO. <b>1 of 1</b>
---------------------------	----------	--------------	------------------------------------	---	-------------------------	----------------------------

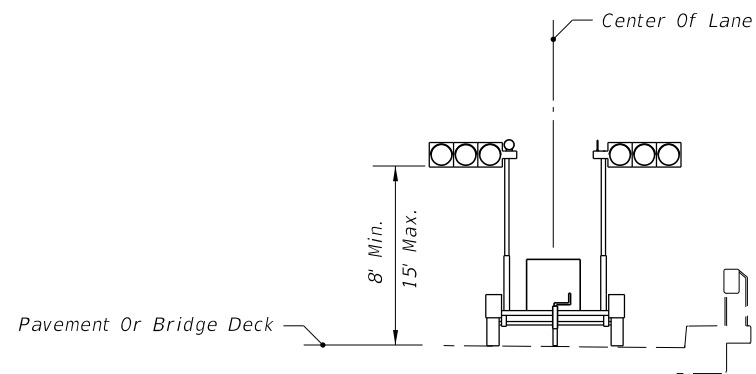



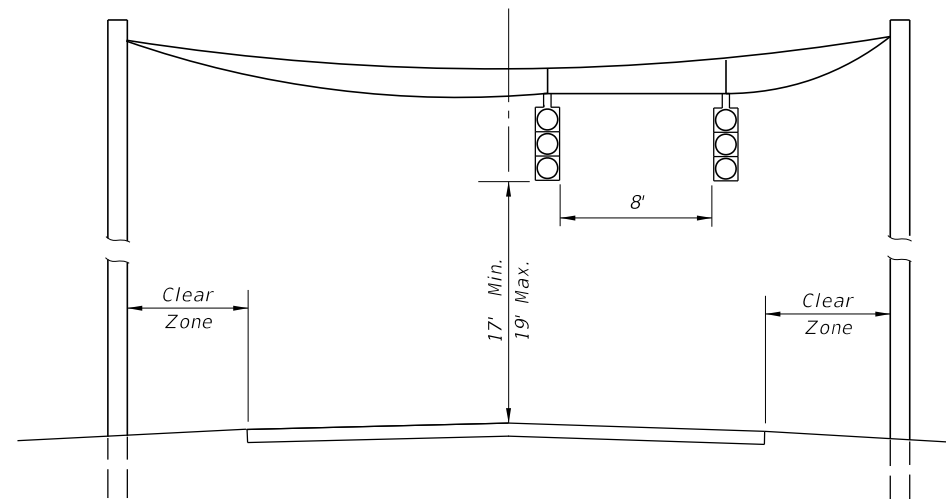





PORTABLE SIGNALS



SPAN WIRE SIGNALS

SIGNAL MOUNT DETAILS

SYMBOLS

-  Work Area
-  Work Zone Sign
-  Traffic Signal
-  Channelizing Device (See Index No. 600)
-  Type III Barricade
-  Stop Bar
-  Flagger
-  Portable Signal
-  Lane Identification + Direction of Traffic

GENERAL NOTES

1. Work operations shall be confined to one traffic lane, except for haul road crossings, leaving the opposite lane open to traffic.
2. The installation and timing of signals shall be approved by the District Traffic Operations Engineer prior to signals being placed in operation.  
  
Where sight distance to the signal is limited, the signals may be mounted on span wire or relocated at the discretion of the Engineer.  
  
Whether the signals are in automatic mode or being controlled manually, in no case will the distance between the portable signals (receiver/controllers) exceed the maximum distance at which both of the portable signals can be positively and safely operated.
3. Additional signals or flaggers may be required to assure safe movements between traffic and operating equipment, as determined by the Engineer.
4. An additional warning sign may be required in advance of the ROAD WORK AHEAD sign, as determined by the Engineer. The distance between successive signs shall be 500'.
5. The SIGNAL AHEAD legend sign may be substituted for the symbol sign.
6. SIGNAL AHEAD and EQUIPMENT CROSSING AHEAD signs are to be removed or fully covered when no work is being performed and the highway is open to two-way traffic. Type III Barricades shall be in place to block haul road access when the haul road is not in operation and a flagger/signal operator is not on duty, except when the haul road is an existing properly marked road.
7. When a side road intersects the highway within the TTC zone, additional TTC devices shall be placed in accordance with other applicable TCZ Indexes.
8. For general TCZ requirements and additional information, refer to Index No. 600.
9. Span wire signals are to be used only in work zones with workers present, where the contractor can monitor signal operation and maintain traffic with flaggers in the event of a power failure.
10. Use Temporary Raised Rumble Strips in accordance with Index 603, General Note #3.

CONDITIONS

WHERE ANY VEHICLE, EQUIPMENT, WORKERS OR THEIR ACTIVITIES WILL ENCROACH ON ONE LANE OR MOMENTARILY ENCROACH ON BOTH LANES OF A TWO-LANE TWO-WAY ROADWAY AND TRAFFIC SIGNALS ARE NEEDED.

12/3/2015 11:38:30 AM

LAST REVISION 07/01/15	REVISION	DESCRIPTION:	 <b>FY 2016-17 DESIGN STANDARDS</b>	<b>TWO-LANE, TWO-WAY, WORK WITHIN THE TRAVEL WAY - SIGNAL CONTROL</b>	INDEX NO. <b>606</b>	SHEET NO. <b>1 of 4</b>
---------------------------	----------	--------------	---	---	-------------------------	----------------------------

12/31/2015 11:38:30 AM

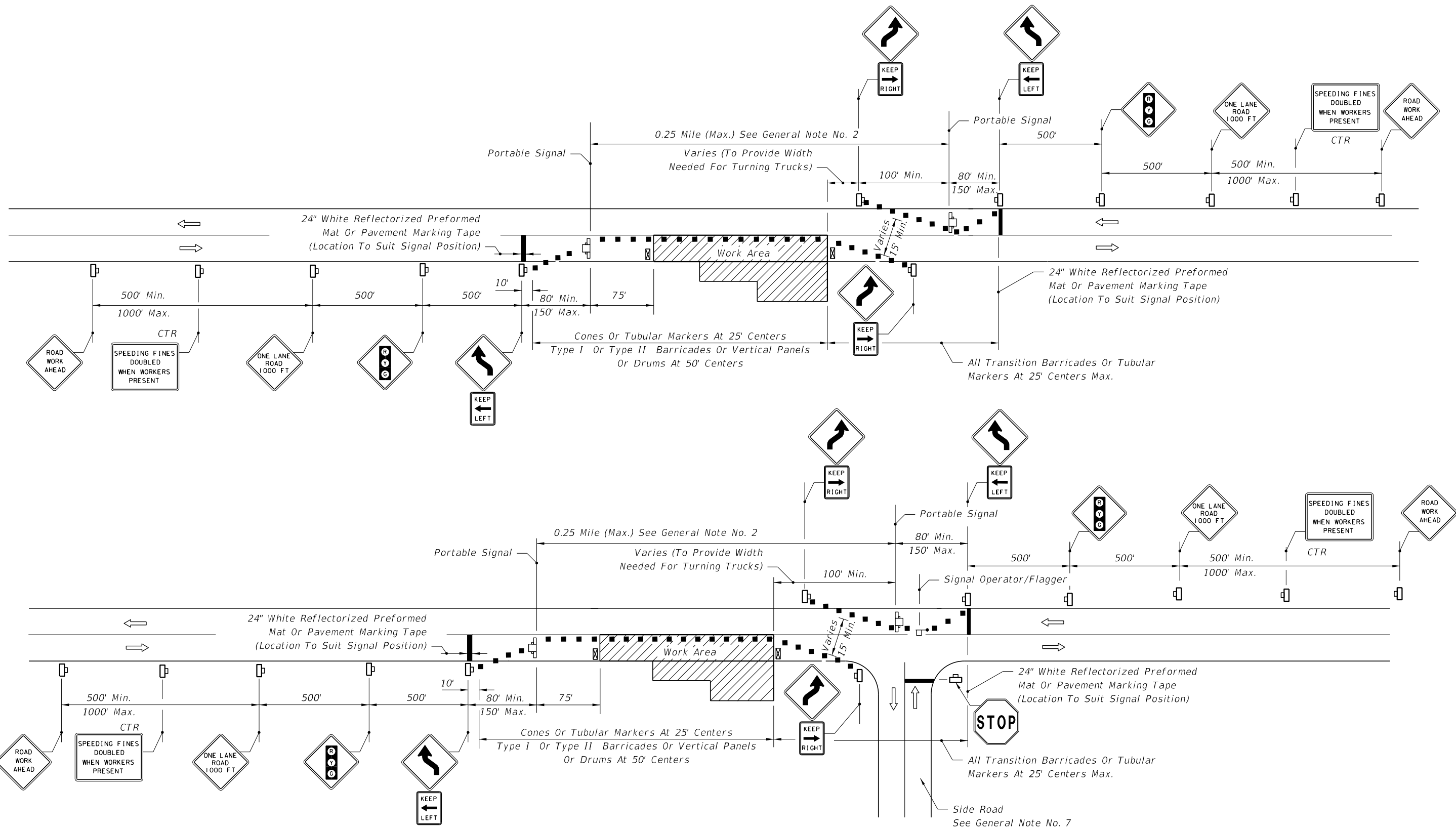

**SINGLE LANE CLOSURE • ROADWAY AND BRIDGES ALL LENGTHS**

LAST REVISION 07/01/15	DESCRIPTION:
---------------------------	--------------

**FDOT** FY 2016-17  
DESIGN STANDARDS

**TWO-LANE, TWO-WAY, WORK WITHIN THE TRAVEL WAY - SIGNAL CONTROL**

INDEX NO.  
**606**

SHEET NO.  
**2 of 4**

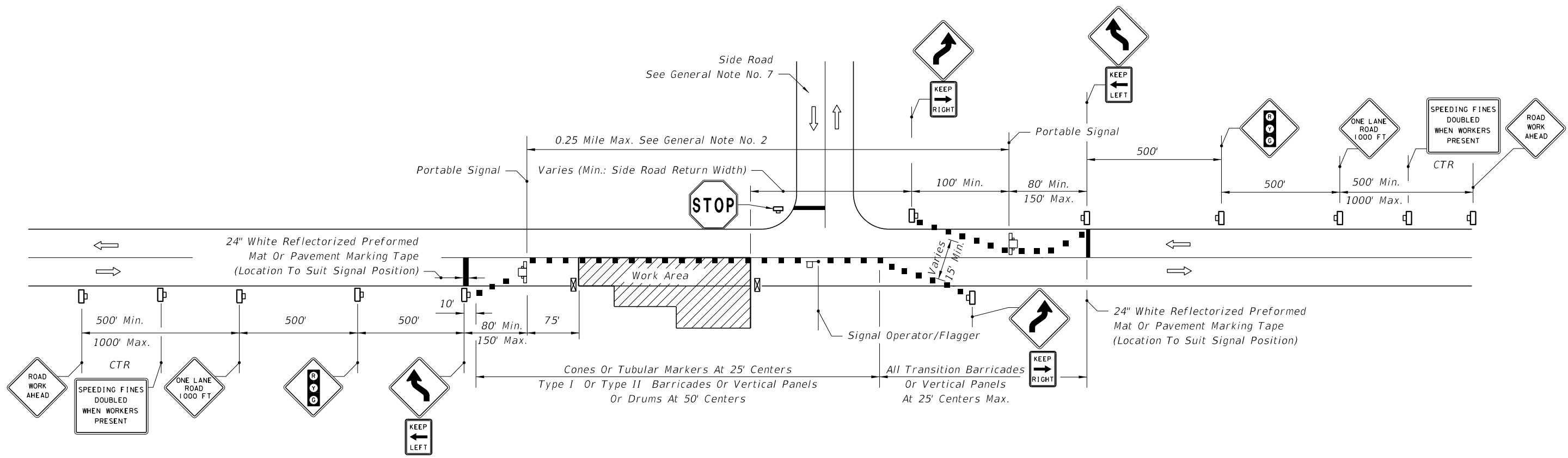

**SINGLE LANE CLOSURE • ROADWAY AND BRIDGES ALL LENGTHS**

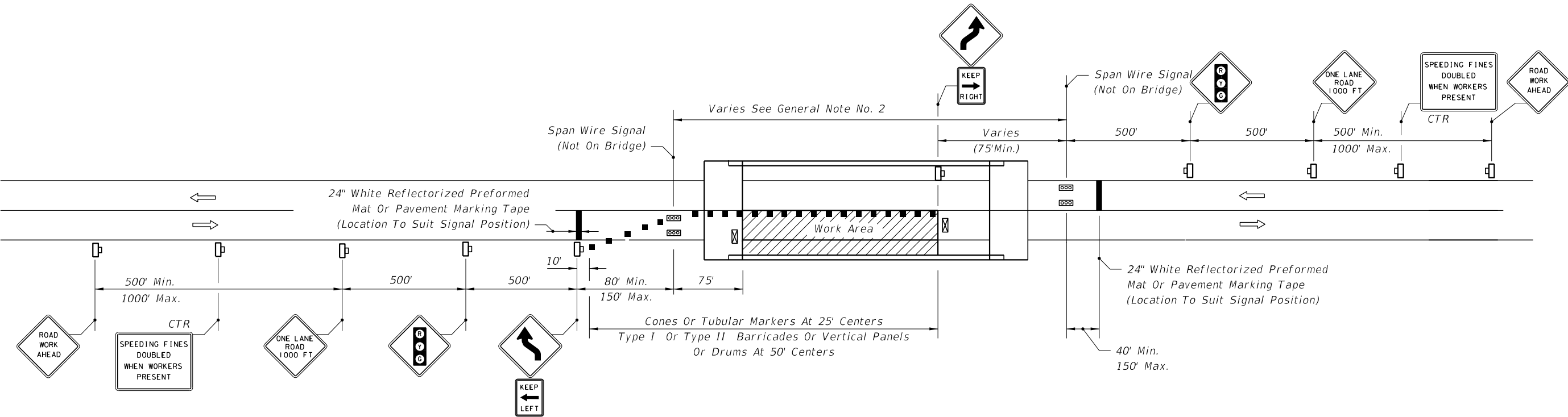

**SINGLE LANE CLOSURE • SHORT BRIDGES**

12/3/2015 11:38:31 AM

LAST REVISION 07/01/15	REVISION	DESCRIPTION:	 FY 2016-17 DESIGN STANDARDS	TWO-LANE, TWO-WAY, WORK WITHIN THE TRAVEL WAY - SIGNAL CONTROL	INDEX NO. 606	SHEET NO. 3 of 4
---------------------------	----------	--------------	---	---	------------------	---------------------

12/3/2015 11:38:32 AM

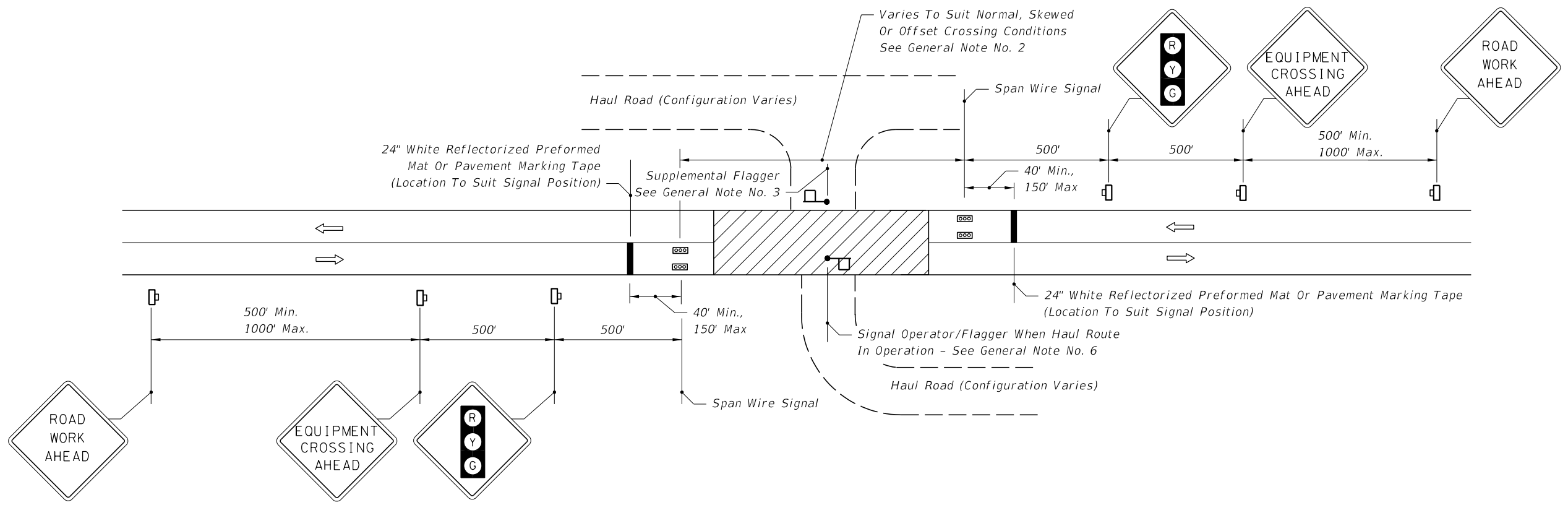

MOMENTARY ROADWAY CLOSURE • HAUL ROUTE CROSSING

LAST REVISION 07/01/15	REVISION	DESCRIPTION:
---------------------------	----------	--------------



TWO-LANE, TWO-WAY, WORK WITHIN THE TRAVEL WAY - SIGNAL CONTROL

INDEX NO. 606	SHEET NO. 4 of 4
------------------	---------------------

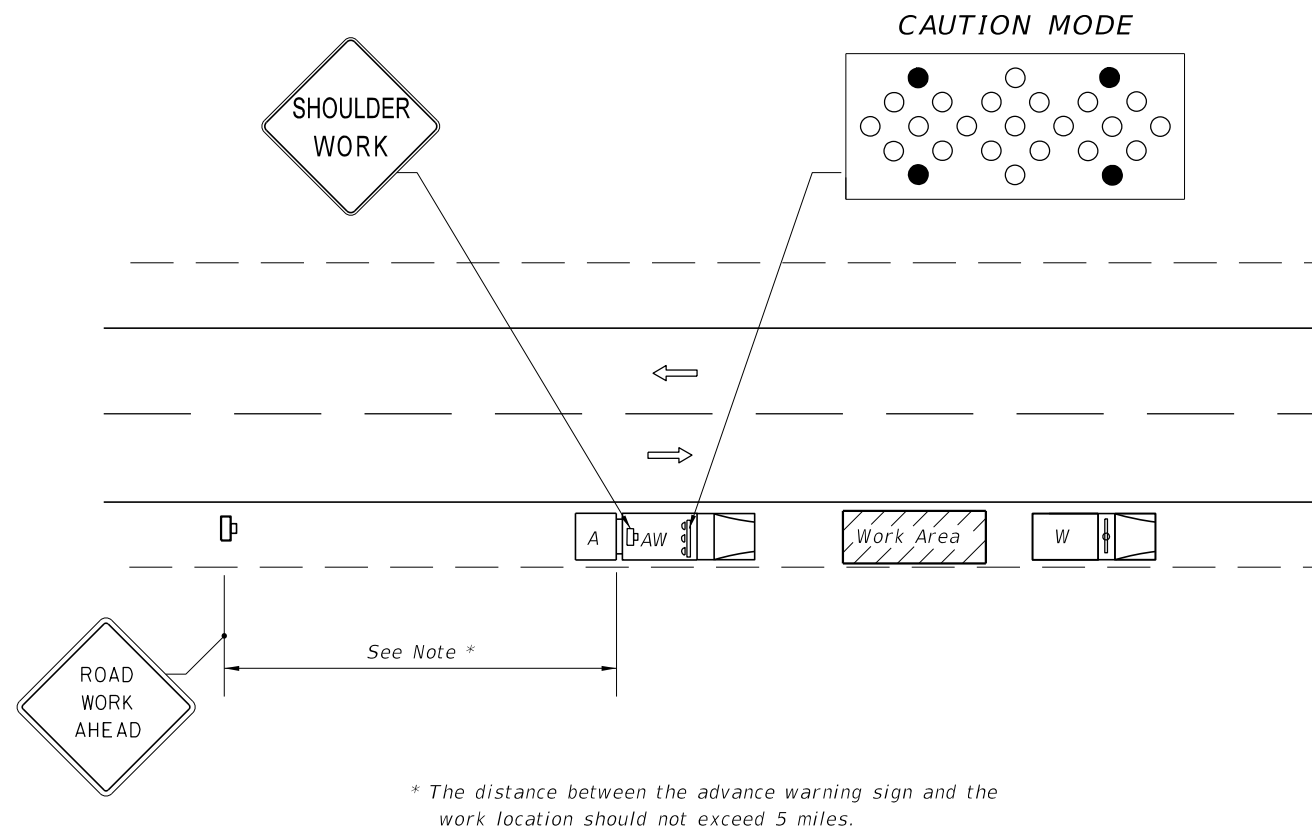

\* The distance between the advance warning sign and the work location should not exceed 5 miles.

**WORK ON SHOULDER**

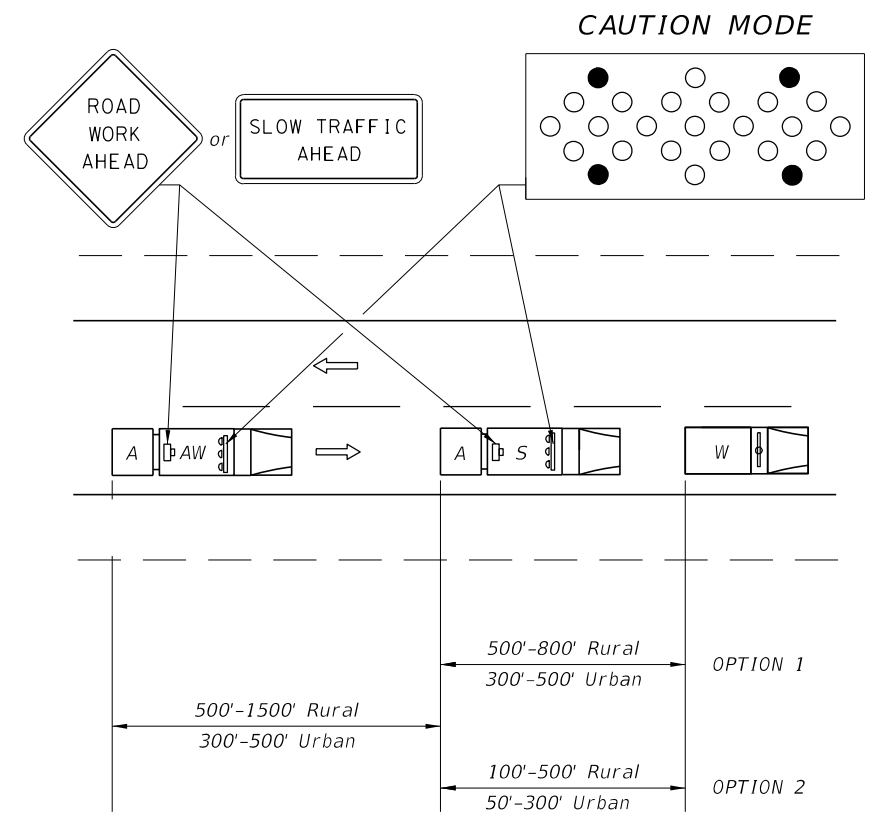

**OPTION 1:** Advanced Warning Vehicle is optional and to be operated on the shoulder when feasible. If an Advance Warning Vehicle is operated in the shoulder, an approved Truck Mounted Attenuator is required on both the Advance Warning and Shadow Vehicles. If an Advance Warning Vehicle is operated in the lane behind the Shadow Vehicle, an approved Truck Mounted Attenuator will be required on the Advance Warning Vehicle, but not required on the Shadow Vehicle. The Advance Warning Arrow Board and Warning Sign is required on both the Advance warning and Shadow Vehicles.

**OPTION 2:** Advanced Warning Vehicle is required and must be operated in the lane behind the shadow vehicle. An approved Truck Mounted Attenuator will be required on the Advanced Warning Vehicle but not required on the Shadow Vehicle. The Advance Warning Arrow Board and Warning Sign is required on both the Advance Warning and Shadow Vehicles.

**WORK IN TRAVEL WAY  
(Option 2 Shown, Option 1 Similar)**

- SYMBOLS**
- Work Area
  - Work Zone Sign
  - Lane Identification + Direction of Traffic
  - Work Vehicle With Rotating/Strobe Lights
  - Shadow (S) Or Advance Warning (AW)
  - Vehicle with Advance Warning Arrow Board and Sign Message
  - Truck/Trailer Mounted Attenuator (TMA)
  - Advanced Warning Arrow Board

**GENERAL NOTES**

1. Where work activities within 2' of the edge of travel way are incidental (i.e., Mowing, Litter Removal), the Engineer may delete requirements for signs and the advance warning vehicle provided vehicles in the work area have high-intensity rotating, flashing, oscillating, or strobe lights operating.
2. If an arrow board is used, the caution mode shall be used.
3. Shadow and Advance Warning Vehicle shall display rotating/strobe lights.
4. For general TCZ requirements and additional information, refer to Index 600.

**CONDITIONS**

WHERE ANY VEHICLE, EQUIPMENT, WORKERS OR THEIR ACTIVITIES REQUIRE AN INTERMITTENT OR CONTINUOUS MOVING OPERATION.

12/31/2015 11:38:32 AM

LAST REVISION 07/01/15	REVISION	DESCRIPTION:	 FY 2016-17 DESIGN STANDARDS	<b>TWO-LANE, TWO-WAY MOBILE OPERATION, WORK ON SHOULDER AND WORK WITHIN THE TRAVEL WAY</b>	INDEX NO. <b>607</b>	SHEET NO. <b>1 of 1</b>
---------------------------	----------	--------------	------------------------------------	--	-------------------------	----------------------------



12/31/2015 11:38:33 AM

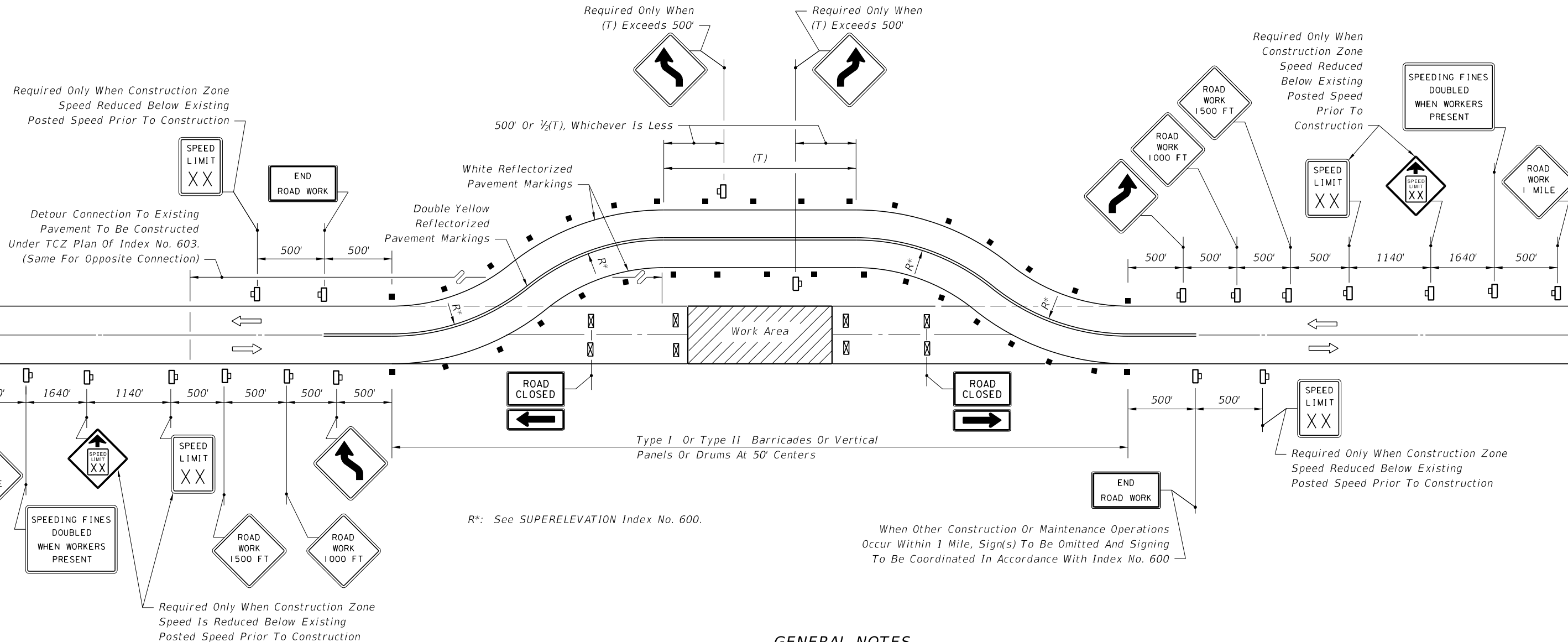

R\*: See SUPERELEVATION Index No. 600.

When Other Construction Or Maintenance Operations Occur Within 1 Mile, Sign(s) To Be Omitted And Signing To Be Coordinated In Accordance With Index No. 600

**GENERAL NOTES**

1. For speed sign applications, see Index No. 600.
2. Where the tangent distance (T) exceeds 600', spacing between cones or tubular markers may be increased to 50' or spacing between Type I or Type II barricades, vertical panels or drums may be increased to 100' within limits of the tangent, or post mounted delineators at 50' centers may be substituted for the barricades, vertical panels or drums.
3. On the existing pavement, all existing markings within the realignment which conflict with the revised traffic pattern are to be removed and removable pavement markings used for marking a new centerline and edge lines.
4. Where the tangent distance (T) exceeds 600' and no passing or stopping sight distance restrictions exist, the yellow reflectORIZED markings used to indicate the centerline of the traveled way may be replaced with yellow reflectORIZED markings in a broken pattern. For raised pavement marker application see Index No. 600 and Index No. 17352.
5. When a side road intersects the highway within the TTC zone, additional TTC devices shall be placed in accordance with other applicable TCZ Indexes.
6. If temporary structures are required on the diversion, traffic control will be in conformance with Index No. 650.
7. For general TCZ requirements and additional information, refer to Index Nos. 600 and 17352.
8. If posted speed for Work Zone is 45 mph or less, use "ROAD WORK 1/2 MILE" and space accordingly.

**SYMBOLS**

- Work Area
- Channelizing Device (See Index No. 600)
- Type III Barricade
- Work Zone Sign
- Lane Identification + Direction of Traffic

**CONDITIONS**

WHERE ANY VEHICLE, EQUIPMENT, WORKERS OR THEIR ACTIVITIES REQUIRE THE CLOSURE OF BOTH LANES AND A TEMPORARY DIVERSION IS CONSTRUCTED.

LAST REVISION 07/01/15	DESCRIPTION:
---------------------------	--------------

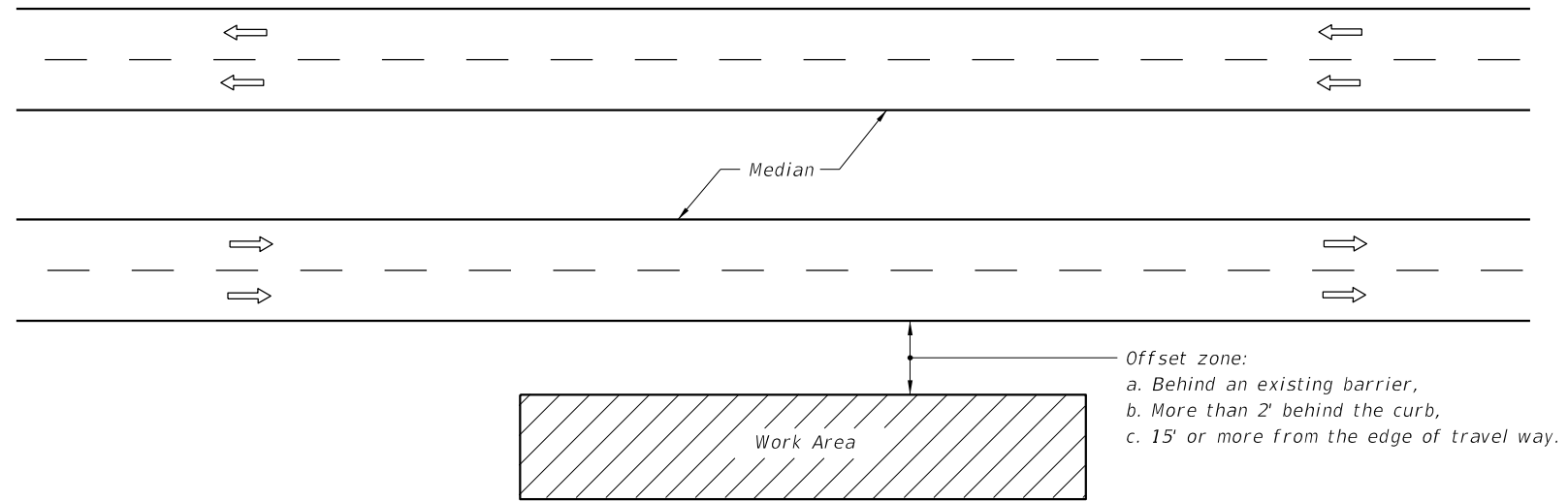

**GENERAL NOTES**

1. If the work operation (excluding establishing and terminating the work area), requires that two or more work vehicles cross the offset zone in any one hour, traffic control will be in accordance with Index No. 612.
2. No special signing is required.
3. This index also applies when work is being performed on a multilane undivided highway.
4. This index also applies to work performed in the median behind an existing barrier or more than 15' from the edge of travel way, both roadways. Work performed in the median behind curb and gutter shall be in accordance with Index No. 612.
5. When a side road intersects the highway within the work area, additional traffic control devices shall be placed in accordance with other applicable TCZ Indexes.
6. When construction activities encroach on a sidewalk, refer to Index No. 660.
7. For general TCZ requirements and additional information, refer to Index No. 600.

**SYMBOLS**

-  Work Area
-  Lane Identification + Direction of Traffic

**CONDITIONS**

WHERE ANY VEHICLE, EQUIPMENT, WORKERS AND THEIR ACTIVITIES ARE BEHIND AN EXISTING BARRIER, MORE THAN 2' BEHIND THE CURB, OR 15' OR MORE FROM THE EDGE OF TRAVEL WAY.

12/3/2015 11:38:34 AM

LAST REVISION 07/01/05	REVISION	DESCRIPTION:	 <b>FY 2016-17 DESIGN STANDARDS</b>	<b>MULTILANE WORK OUTSIDE SHOULDER</b>	INDEX NO. <b>611</b>	SHEET NO. <b>1 of 1</b>
---------------------------	----------	--------------	--	--	-------------------------	----------------------------

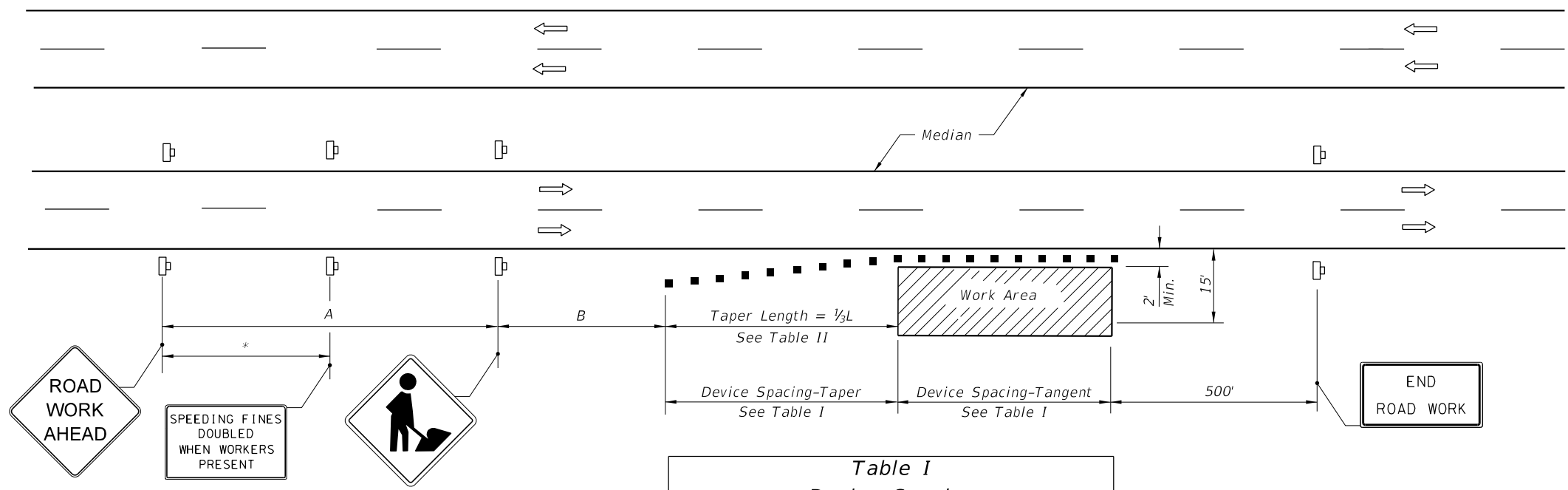

Speed	Spacing (ft.)	
	A	B
40 mph or less	200	200
45 mph	350	350
50 mph or greater	500	500

\* 250' beyond the ROAD WORK AHEAD sign or midway between signs whichever is less.

Speed (mph)	Max. Distance Between Devices (ft.)			
	Cones or Tubular Markers		Type I or Type II Barricades or Vertical Panels or Drums	
	Taper	Tangent	Taper	Tangent
25	25	50	25	50
30 to 45	25	50	30	50
50 to 70	25	50	50	100

Speed (mph)	$\frac{1}{3}L$ (ft.)			Notes
	8' Shldr.	10' Shldr.	12' Shldr.	
25	28	35	42	$L = \frac{WS^2}{60}$
30	40	50	60	
35	55	68	82	
40	72	90	107	
45	120	150	180	$L = WS$
50	133	167	200	
55	147	183	220	
60	160	200	240	
65	173	217	260	
70	187	233	280	

8' minimum shoulder width.  
 $\frac{1}{3}L$  = Length of shoulder taper in feet  
 W = Width of total shoulder in feet (combined paved and unpaved width)  
 S = Posted speed limit (mph)

**GENERAL NOTES**

- When a high volume of work vehicles are entering and leaving the Work Area at speeds slower than 10 MPH below the posted speed, place an MOT-5-06 sign in the ROAD WORK AHEAD sign location and shift the ROAD WORK AHEAD sign upstream 500 ft.
- This TCZ plan also applies to work performed in the median more than 2' but less than 15' from the edge of travelway.
- When work is being performed on a multilane undivided roadway the signs normally mounted in the median (as shown) shall be omitted.
- WORKERS signs to be removed or fully covered when no work is being performed.
- SHOULDER WORK sign may be used as an alternate to the WORKER symbol sign.
- When a side road intersects the highway within the TTC zone, additional TTC devices shall be placed in accordance with other applicable TCZ Indexes.
- For general TCZ requirements and additional information, refer to Index No. 600.

**DURATION NOTES**

- Signs and channelizing devices may be omitted if all of the following conditions are met:
  - Work operations are 60 minutes or less.
  - Vehicles in the work area have high-intensity, rotating, flashing, oscillating, or strobe lights operating.

**CONDITIONS**

WHERE ANY VEHICLE, EQUIPMENT, WORKERS OR THEIR ACTIVITIES ENCROACH THE AREA CLOSER THAN 15' BUT NOT CLOSER THAN 2' TO THE EDGE OF TRAVEL WAY.

**SYMBOLS**

- Work Area
- Channelizing Device (See Index No. 600)
- Work Zone Sign
- Lane Identification + Direction of Traffic

12/3/2015 11:38:34 AM

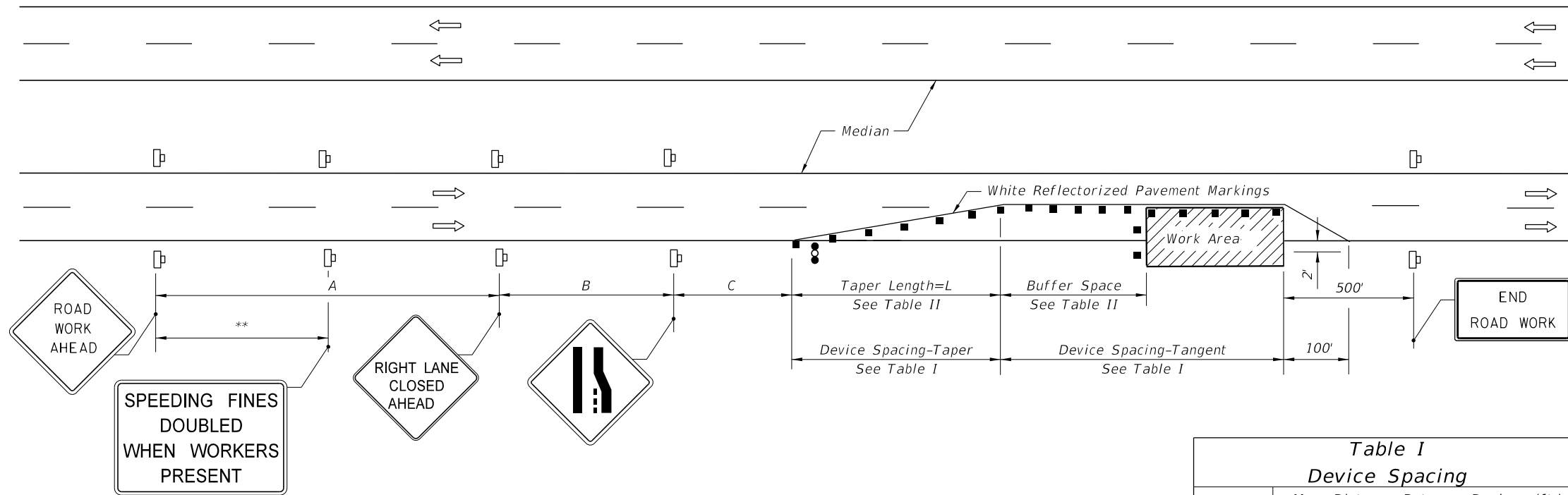

**Table II**  
**Buffer Space and Taper Length**

Speed (mph)	Buffer Space (ft.)	Taper Length (12' Lateral Transition)	
		L (ft.)	Notes (Merge)
25	155	125	$L = \frac{WS^2}{60}$
30	200	180	
35	250	245	
40	305	320	$L = WS$
45	360	540	
50	425	600	
55	495	660	
60	570	720	
65	645	780	
70	730	840	

When Buffer Space cannot be attained due to geometric constraints, the greatest attainable length shall be used, but not less than 200 ft.

For lateral transitions other than 12', use formula for L shown in notes column. Where:

L = Length of taper in feet  
W = Width of lateral transition in feet  
S = Posted speed limit (mph)

**Table I**  
**Device Spacing**

Speed (mph)	Max. Distance Between Devices (ft.)			
	Cones or Tubular Markers		Type I or Type II Barricades or Vertical Panels or Drums	
	Taper	Tangent	Taper	Tangent
25	25	50	25	50
30 to 45	25	50	30	50
50 to 70	25	50	50	100

**DURATION NOTES**

- Temporary white edgeline may be omitted for work operations less than 3 consecutive calendar days.
- For work operations up to approximately 15 minutes, signs, channelizing devices, arrow board, and buffer space may be omitted if all of the following conditions are met:
  - Speed limit is 45 mph or less.
  - No sight obstructions to vehicles approaching the work area for a distance equal to the buffer space and the taper length combined.
  - Volume and complexity of the roadway has been considered.
  - The closed lane is occupied by a class 5 or larger, medium duty truck(s) with a minimum gross weight vehicle rating (GWVR) of 16,001 lb with high-intensity, rotating, flashing, oscillating, or strobe lights mounted above the cab height and operating.
- For work operations up to 60 minutes, arrow board and buffer space may be omitted if conditions a, b, and c in DURATION NOTE 2 are met, and vehicles in the work area have high-intensity, rotating, flashing, oscillating, or strobe lights operating.

**CONDITIONS**

WHERE ANY VEHICLE, EQUIPMENT, WORKERS OR THEIR ACTIVITIES ENCROACH ON THE LANE ADJACENT TO EITHER SHOULDER AND THE AREA 2' OUTSIDE THE EDGE OF TRAVEL WAY.

**DISTANCE BETWEEN SIGNS**

Speed	Spacing (ft.)		
	A	B	C
40 mph or less	200	200	200
45 mph	350	350	350
50 mph	500	500	500
*55 mph or greater	2640	1640	1000

\* The ROAD WORK 1 MILE sign may be used as an alternate to the ROAD WORK AHEAD sign and the RIGHT LANE CLOSED 1/2 MILE sign may be used as an alternate to the RIGHT LANE CLOSED AHEAD sign.

\*\* 500' beyond the ROAD WORK AHEAD sign or midway between signs whichever is less.

**GENERAL NOTES**

- Work operations shall be confined to one traffic lane, leaving the adjacent lane open to traffic.
- On undivided highways the median signs as shown are to be omitted.
- When work is performed in the median lane on divided highways, the channelizing device plan is inverted and left lane closed and lane ends signs substituted for the right lane closed and lane end signs.
 

The same applies to undivided highways with the following exceptions:

  - Work shall be confined within one median lane.
  - Additional barricades, cones, or drums shall be placed along the centerline abutting the work area and across the trailing end of the work area.

When work on undivided highways occurs across the centerline so as to encroach on both median lanes, the inverted plan is applied to the approach of both roadways.
- Signs and traffic control devices are to be modified in accordance with INTERMITTENT WORK STOPPAGE details (sheet 2 of 2) when no work is being performed and the highway is open to traffic.
- The two channelizing devices directly in front of the work area may be omitted provided vehicles in the work area have high-intensity rotating, flashing, oscillating, or strobe lights operating.
- When paved shoulders having a width of 8 ft. or more are closed, channelizing devices shall be used to close the shoulder in advance of the merging taper to direct vehicular traffic to remain within the travel way. See Index No. 612 for shoulder taper formulas.
- When a side road intersects the highway within the TTC zone, additional TTC devices shall be placed in accordance with other applicable TCZ Indexes.
- This TCZ plan does not apply when work is being performed in the middle lane(s) of a six or more lane highway. See Index No. 614.
- For general TCZ requirements and additional information, refer to Index No. 600.

**SYMBOLS**

- Work Area
- Channelizing Device (See Index No. 600)
- Work Zone Sign
- Advance Warning Arrow Board

12/3/2015 11:38:35 AM

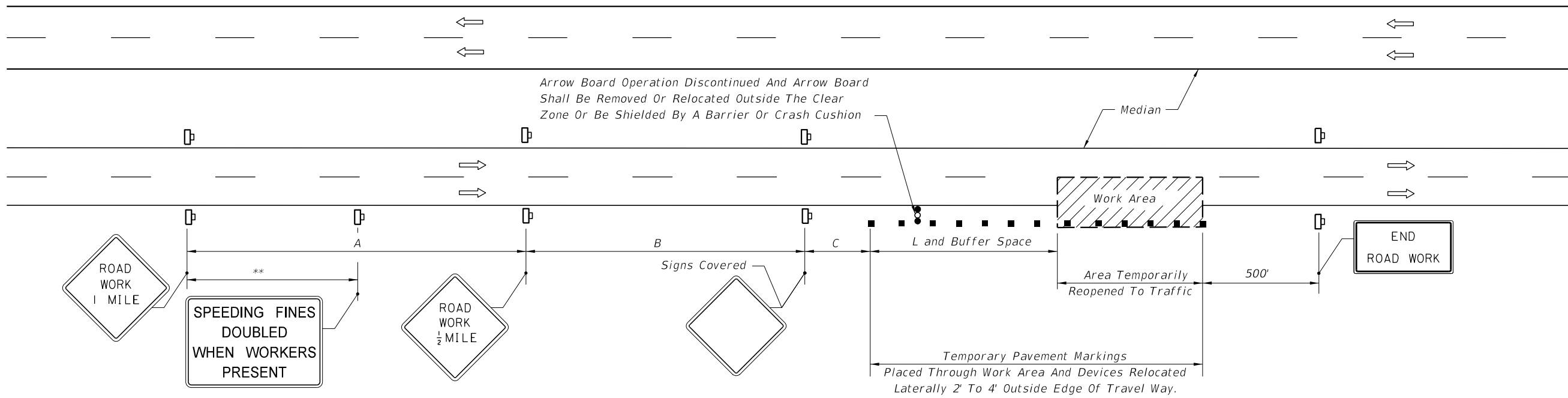

EVEN PAVEMENT

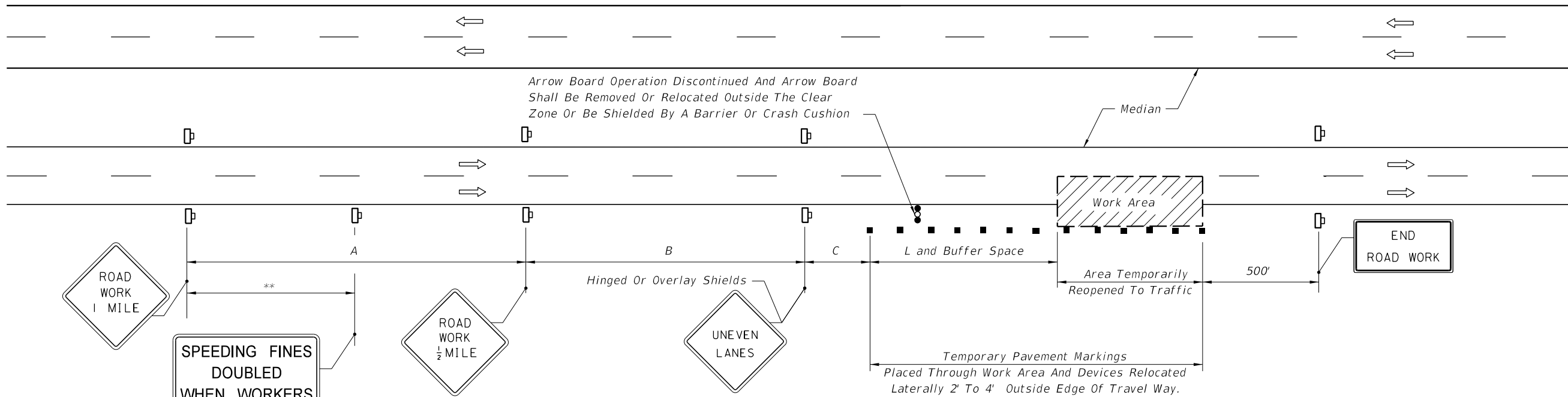

UNEVEN PAVEMENT

INTERMITTENT WORK STOPPAGE - LANE REOPENED TO TRAFFIC

12/31/2015 11:38:36 AM

LAST REVISION 07/01/15	REVISION DESCRIPTION:	 FY 2016-17 DESIGN STANDARDS	MULTILANE, WORK WITHIN TRAVEL WAY MEDIAN OR OUTSIDE LANE	INDEX NO. 613	SHEET NO. 2 of 2
---------------------------	--------------------------	--	---	------------------	---------------------

EXISTING POSTED SPEED	PROPOSED WORK ZONE SPEED	REMARKS
MPH	MPH	The 'Proposed Work Zone Speeds' are recommended speeds for the traffic control plan detailed below; however, where the Engineer deems other speeds are appropriate, the applicable speeds are to be shown on the plans.
65	55	
55	45	
45	35	

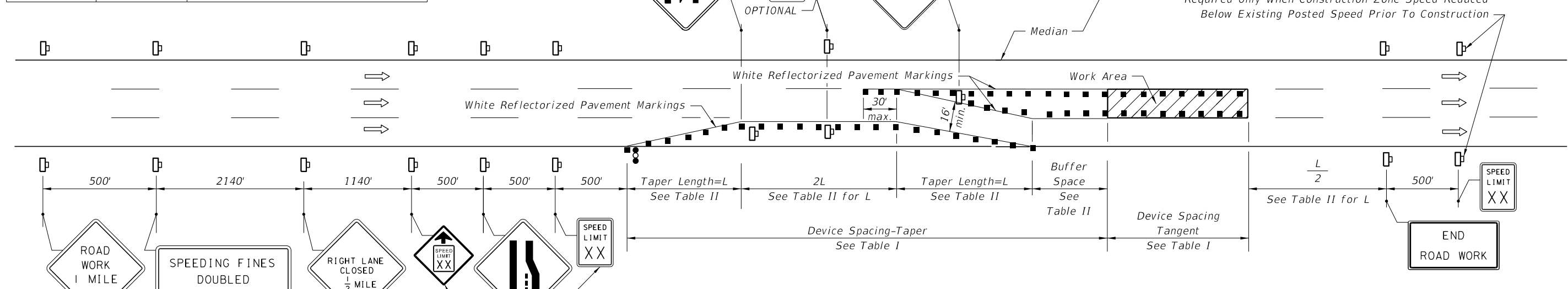

**Table I  
Device Spacing**

Speed (mph)	Max. Distance Between Devices (ft.)			
	Cones or Tubular Markers		Type I or Type II Barricades or Vertical Panels or Drums	
	Taper	Tangent	Taper	Tangent
25	25	50	25	50
30 to 45	25	50	30	50
50 to 70	25	50	50	100

**Table II  
Buffer Space and Taper Length**

Speed (mph)	Buffer Space	Taper Length (12' Lateral Transition)		Notes (Merge)
	Dist. (ft.)	L (ft.)		
25	155	125		$L = \frac{WS^2}{60}$
30	200	180		
35	250	245		
40	305	320		
45	360	540		$L = WS$
50	425	600		
55	495	660		
60	570	720		
65	645	780		
70	730	840		

**CONDITION NOTES**

- The RIGHT LANE CLOSED and lane reduction signs are to be removed or fully covered when no work is being performed and the center lane is opened to traffic.
- For work performed in the median or outside lane, refer to Index No. 613.
- When the lane closure exceeds a continuous 24 hour period, all existing pavement markings within the realignment which conflict with the revised traffic pattern are to be removed and removable pavement marking used for marking new edge lines and centerline.

**GENERAL NOTES**

- When a side road intersects the highway within the TTC zone, additional TTC devices shall be placed in accordance with other applicable TCZ Indexes.
- For general TCZ requirements and additional information, refer to Index No. 600.

**DURATION NOTES**

- Temporary pavement markings may be omitted for work operations less than 3 days.

When Buffer Space cannot be attained due to geometric constraints, the greatest attainable length shall be used, but not less than 200 ft.

For lateral transitions other than 12', use formula for L shown in the notes column. Where:  
 L = Length of taper in feet  
 W = Width of lateral transition in feet  
 S = Posted speed limit (mph)

**CONDITIONS**

WHERE ANY VEHICLE, EQUIPMENT, WORKERS OR THEIR ACTIVITIES ENCROACH ON ANY PORTION OF A CENTER LANE OF A MULTILANE HIGHWAY, AND TWO DRIVING LANES ARE MAINTAINED ON THE TRAVEL WAY.

**SYMBOLS**

- Work Area
- Channelizing Device (See Index No. 600)
- Work Zone Sign
- Advance Warning Arrow Board
- Lane Identification + Direction of Traffic

12/3/2015 11:38:37 AM

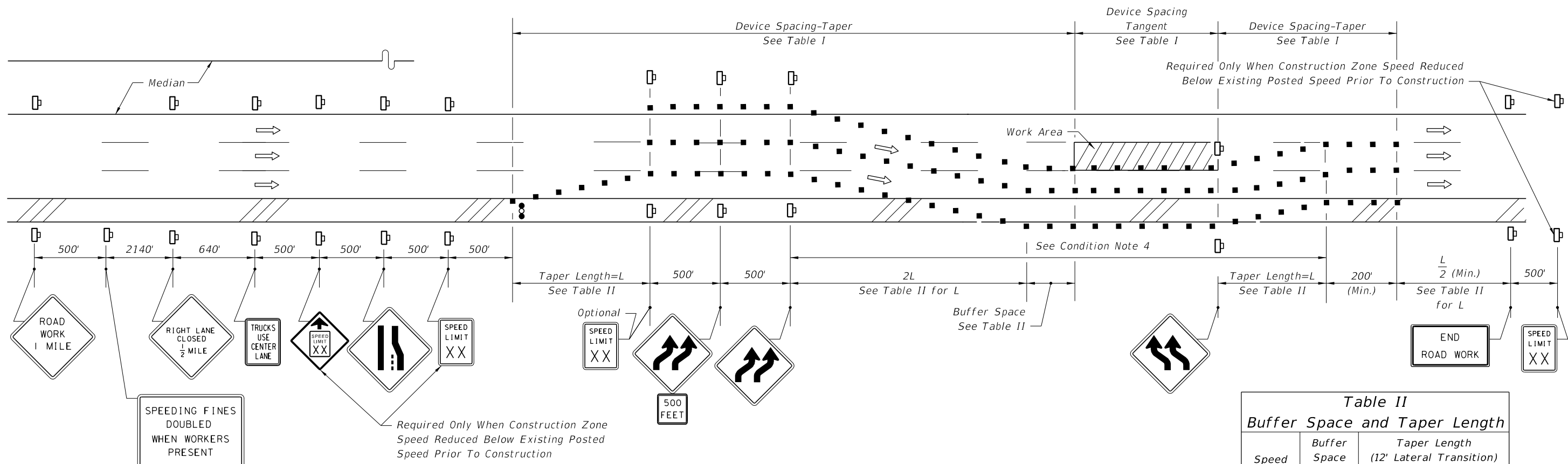

EXISTING POSTED SPEED	PROPOSED WORK ZONE SPEED	REMARKS
MPH	MPH	The 'Proposed Work Zone Speeds' are recommended speeds for the traffic control plan detailed below; however, where the Engineer deems other speeds are appropriate, the applicable speeds.
65	55	
55	45	
45	35	

**Table I  
Device Spacing**

*Max. Distance Between Devices (ft.)*

Speed (mph)	Cones or Tubular Markers		Type I or Type II Barricades or Vertical Panels or Drums	
	Taper	Tangent	Taper	Tangent
	25	25	50	25
30 to 45	25	50	30	50
50 to 70	25	50	50	100

**Table II  
Buffer Space and Taper Length**

Speed (mph)	Buffer Space	Taper Length (12' Lateral Transition)	
	Dist. (ft)	L (ft)	Notes (Merge)
25	155	125	$L = \frac{WS^2}{60}$
30	200	180	
35	250	245	
40	305	320	$L = WS$
45	360	540	
50	425	600	
55	495	660	
60	570	720	
65	645	780	
70	730	840	

**CONDITION NOTES**

1. See General Notes, Sheet 1.
2. Length of time that traffic is using shoulder should be minimized. For example, remove lane closure and lane shift at night (unless performing night work) if practical.
3. The RIGHT LANE CLOSED, lane reduction and reverse curve signs are to be removed or fully covered when no work is being performed and the travel way is open to traffic.
4. When the lane closure exceeds a continuous 24 hour period, all existing pavement markings within the realignment which conflict with the revised traffic pattern are to be removed and removable pavement markings used for marking new edge lines and centerlines.
5. For general TCZ requirements and additional information, refer to Index No. 600.

**SYMBOLS**

- Work Area
- Channelizing Device (See Index No. 600)
- Work Zone Sign
- Advance Warning Arrow Board

When Buffer Space cannot be attained due to geometric constraints, the greatest attainable length shall be used, but not less than 200 ft.

For lateral transitions other than 12', use formula for L shown in the notes column. Where:  
 L = Length of taper in feet  
 W = Width of lateral transition in feet  
 S = Posted speed limit (mph)

**CONDITIONS**

WHERE ANY VEHICLE, EQUIPMENT, WORKERS OR THEIR ACTIVITIES ENCROACH ON ANY PORTION OF A CENTER LANE OF A MULTILANE HIGHWAY, AND TWO DRIVING LANES ARE MAINTAINED, AND, THE OUTSIDE SHOULDER PAVEMENT IS TEMPORARILY USED AS A TRAVEL LANE.

12/3/2015 11:38:37 AM

12/31/2015 11:38:38 AM

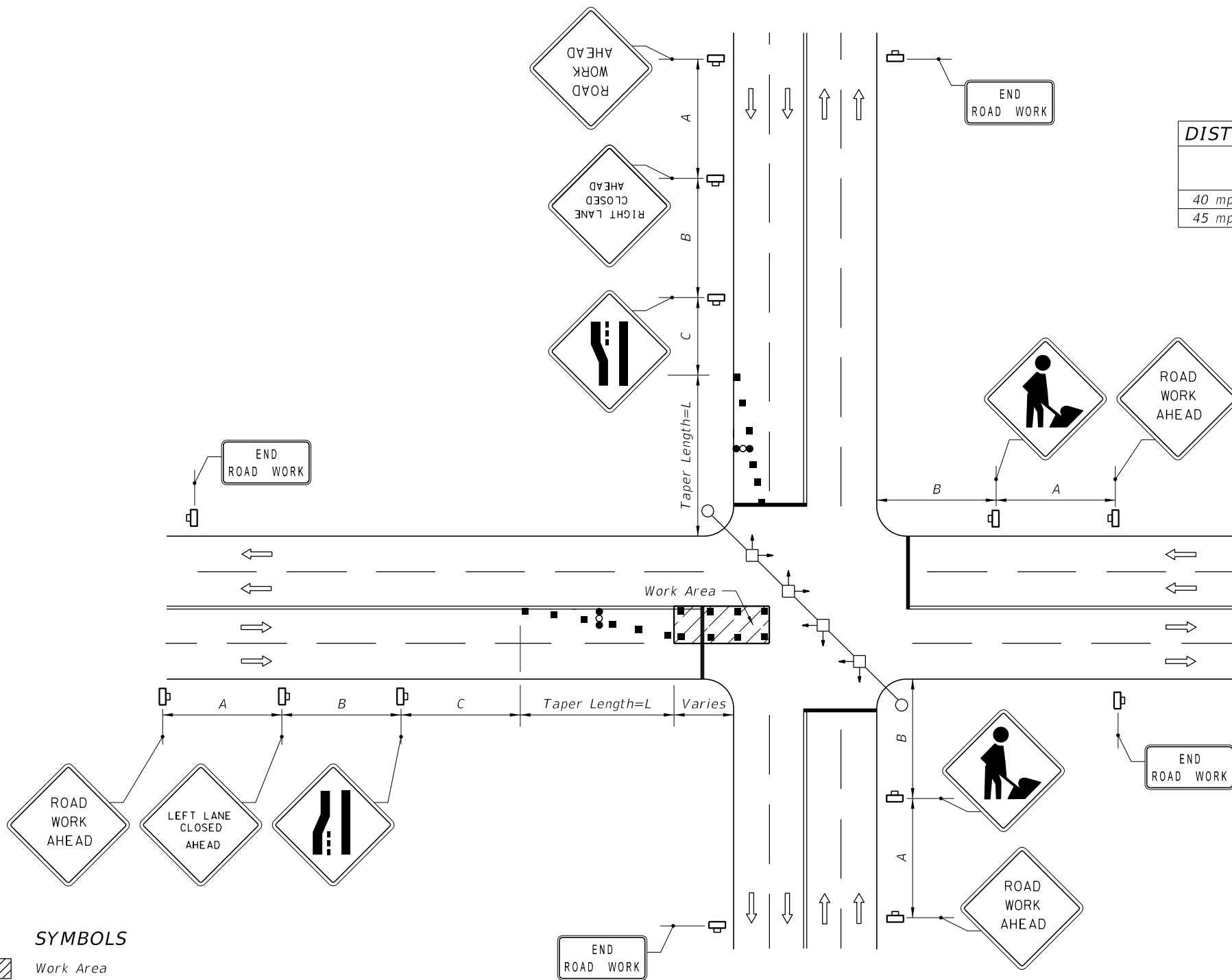

**DISTANCE BETWEEN SIGNS**

Speed	Spacing (ft.)		
	A	B	C
40 mph or less	200	200	200
45 mph	350	350	350

**Table II  
Taper Length - Merge  
(12' Lateral Transition)**

Speed (mph)	L (ft.)	Notes (Merge)
25	125	$L = \frac{WS^2}{60}$
30	180	
35	245	
40	320	L=WS
45	540	

For lateral transitions other than 12', use formula for L shown in the notes column. Where:  
 L = Length of taper in feet  
 W = Width of lateral transition in feet  
 S = Posted speed limit (mph)

**GENERAL NOTES**

1. The WORKERS legend sign may be substituted for the symbol sign.
2. When vehicles in a parking zone block the line of sight to TCZ signs, the signs shall be post mounted and located in accordance with Index No. 17302.
3. If the work space extends across a crosswalk, the crosswalk should be closed using the information in Index No. 660.
4. Dual signs are required for divided roadways.
5. Maximum spacing between barricades, vertical panels, cones, tubular markers and drums shall not be greater than 25'.
6. Temporary signal phasing modifications are to be approved by the District Traffic Operations Engineer prior to the beginning of work.
7. For general TCZ requirements and additional information, refer to Index No. 600.

**DURATION NOTES**

1. Signs and arrow board may be omitted if all of the following conditions are met:
  - a. Work operations are 60 minutes or less.
  - b. Speed is 45 mph or less.
  - c. No sight obstructions to vehicles approaching the work area for a distance equal to twice the taper length.
  - d. Vehicles in the work area have high-intensity, rotating, flashing, oscillating, or strobe lights operating.
  - e. Volume and complexity of the roadway has been considered.

- SYMBOLS**
- Work Area
  - Channelizing Device (See Index No. 600)
  - Work Zone Sign
  - Stop Bar
  - Advance Warning Arrow Board
  - Lane Identification + Direction of Traffic

**SIGNALIZED**

**CONDITIONS**

WHERE ANY VEHICLE, EQUIPMENT, WORKERS OR THEIR ACTIVITIES ENCR OACH ON THE PAVEMENT REQUIRING THE CLOSURE OF AT LEAST ONE MEDIAN TRAFFIC LANE.



**GENERAL NOTES**

1. Work operations shall be confined to either one lane, or lane combinations as follows:
  - a. Outside travel lane;
  - b. Outside auxiliary lane;
  - c. Outside travel lane and adjoining auxiliary lane;
  - d. Inside travel lane  $\Delta$ ;
  - e. Inside auxiliary lane  $\Delta$ ;
  - f. Inside travel lane and adjoining auxiliary lane  $\Delta$



$\Delta$  See Sheet 3

If the work area is confined to an auxiliary lane the work area shall be barricaded and the RIGHT (LEFT) LANE CLOSED AHEAD signs replaced by ROAD WORK AHEAD signs, and the merge symbol signs eliminated.
2. When vehicles in a parking zone block the line of sight to TCZ signs, the signs shall be post mounted and located in accordance with Index No. 17302.
3. If the work space extends across a crosswalk, the crosswalk should be closed using the information in Index No. 660.
4. Signs are required on the median side for divided highways.
5. The two channelizing devices directly in front and directly at the end of the work area may be omitted provided vehicles in the work area have high-intensity rotating, flashing, oscillating, or strobe lights operating.
6. For general TCZ requirements and additional information, refer to Index No. 600.

**DURATION NOTES**

1. For work operations up to approximately 15 minutes, signs, channelizing devices, and arrow board may be omitted if all of the following conditions are met:
  - a. Speed limit is 45 mph or less.
  - b. No sight obstructions to vehicles approaching the work area for a distance equal to twice the taper length.
  - c. Volume and complexity of the roadway has been considered.
  - d. The closed lane is occupied by a class 5 or larger, medium duty truck(s) with a minimum gross weight vehicle rating (GWVR) of 16,001 lb with high-intensity, rotating, flashing, oscillating, or strobe lights mounted above the cab height and operating.
2. For work operations up to 60 minutes, the arrow board may be omitted if conditions a, b, and c in DURATION NOTE 1 are met, and vehicles in the work area have high-intensity, rotating, flashing, oscillating, or strobe lights operating.

**SYMBOLS**

-  Work Area
-  Work Zone Sign
-  Advance Warning Arrow Board
-  Type III Barricade
-  Channelizing Device (See Index No. 600)
-  Lane Identification + Direction of Traffic

12/31/2015 11:38:39 AM

LAST REVISION 07/01/15	REVISION	DESCRIPTION:	 <b>FY 2016-17 DESIGN STANDARDS</b>	<b>MULTILANE, WORK NEAR INTERSECTION MEDIAN OR OUTSIDE LANE</b>	INDEX NO. <b>616</b>	SHEET NO. <b>1 of 3</b>
---------------------------	----------	--------------	---	---	-------------------------	----------------------------

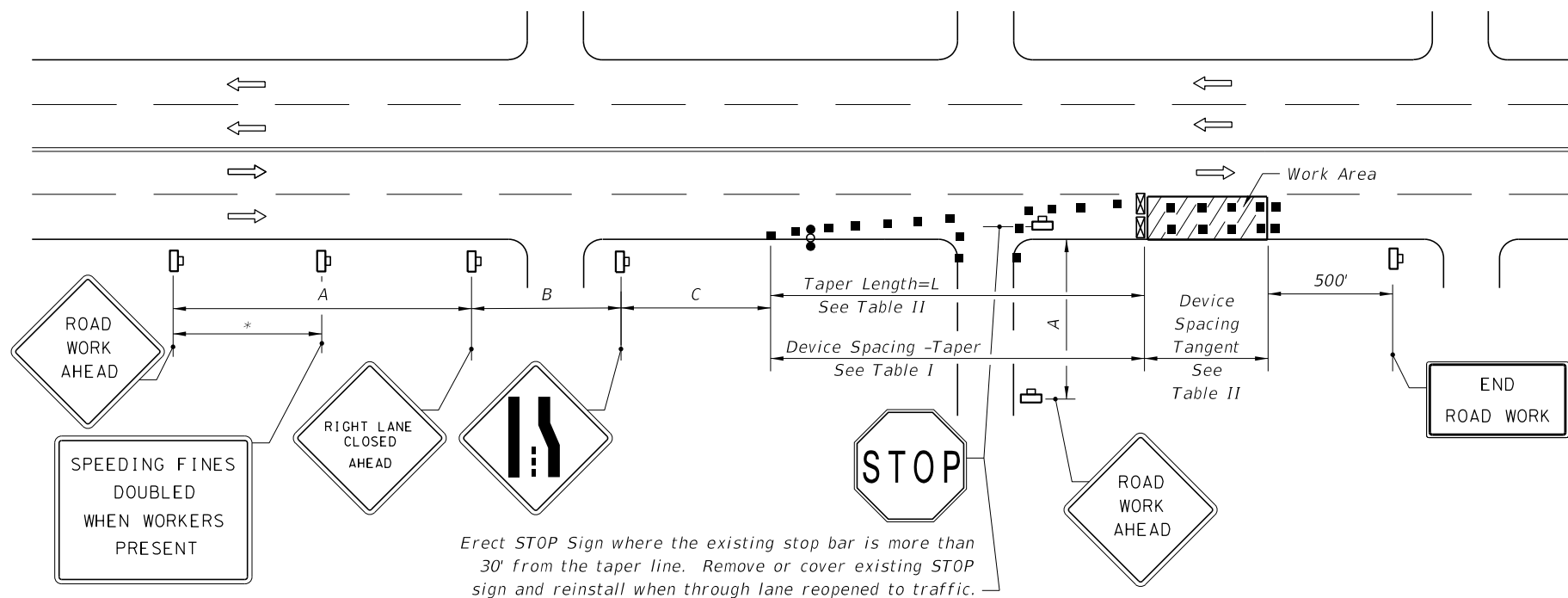

Erect STOP Sign where the existing stop bar is more than 30' from the taper line. Remove or cover existing STOP sign and reinstall when through lane reopened to traffic.

**RIGHT LANE CLOSED ON FAR SIDE OF MINOR SIDESTREET**

Speed	Spacing (ft.)		
	A	B	C
40 mph or less	200	200	200
45 mph	350	350	350

\* 500' beyond the ROAD WORK AHEAD sign or midway between signs whichever is less.

Speed (mph)	Max. Distance Between Devices (ft.)			
	Cones or Tubular Markers		Type I or Type II Barricades or Vertical Panels or Drums	
	Taper	Tangent	Taper	Tangent
25	25	50	25	50
30 to 45	25	50	30	50

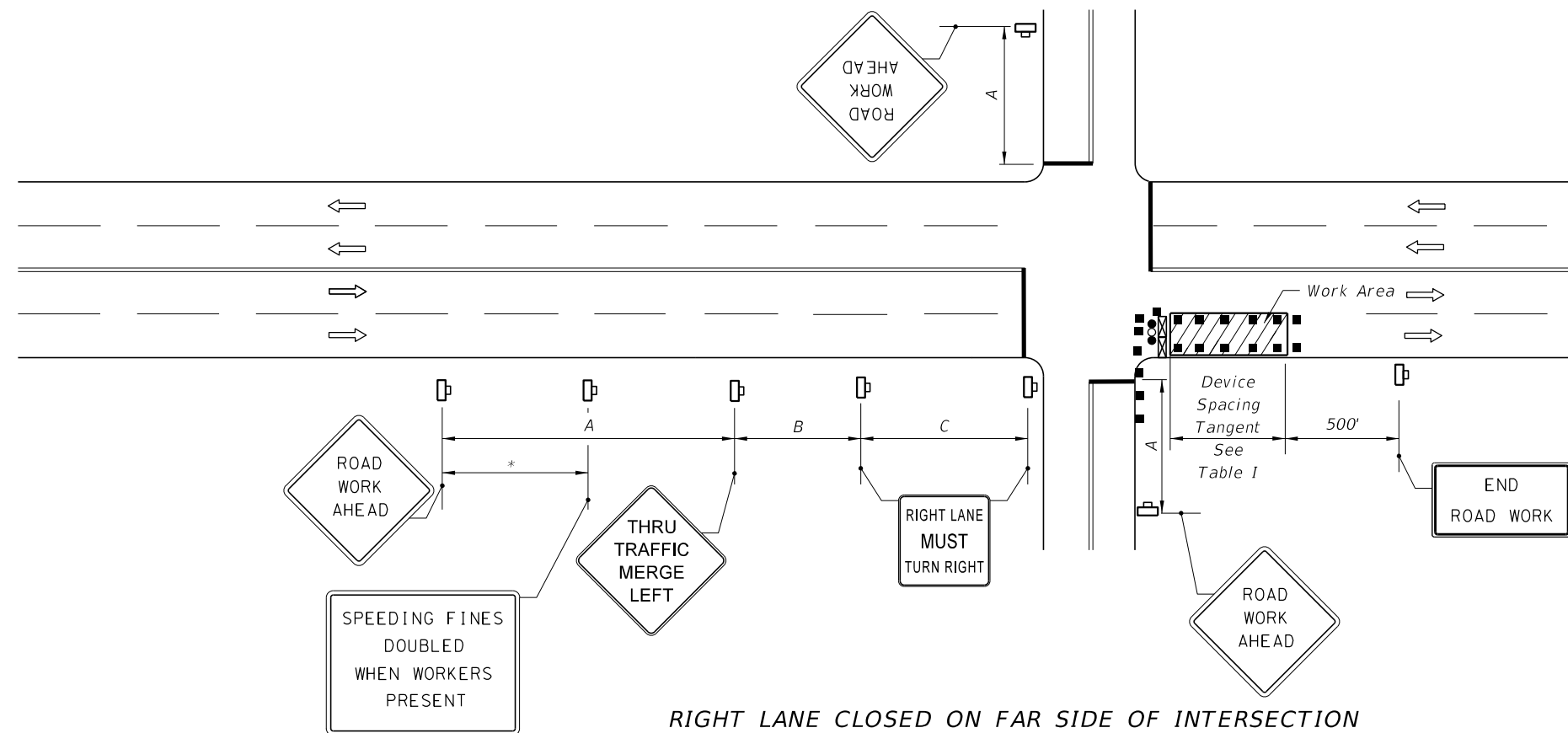

**RIGHT LANE CLOSED ON FAR SIDE OF INTERSECTION WITH SIGNIFICANT RIGHT TURNING MOVEMENTS**

Speed (mph)	L (ft)	Notes (Merge)
25	125	$L = \frac{WS^2}{60}$
30	180	
35	245	
40	320	
45	540	$L=WS$

For lateral transitions other than 12', use formula for L shown in the notes column. Where:

L = Length of taper in feet  
W = Width of lateral transition in feet  
S = Posted speed limit (mph)

1. The normal procedure is to close on the near side of the intersection any lane that is not carried through the intersection. However, when this results in the closure of a right lane having significant right turning movements, then the right lane may be restricted to right turns only as shown in this detail.

2. For intersection approaches reduced to a single lane, left turning movements may be prohibited to maintain capacity for through vehicular traffic.

12/3/2015 11:38:40 AM

12/3/2015 11:38:40 AM

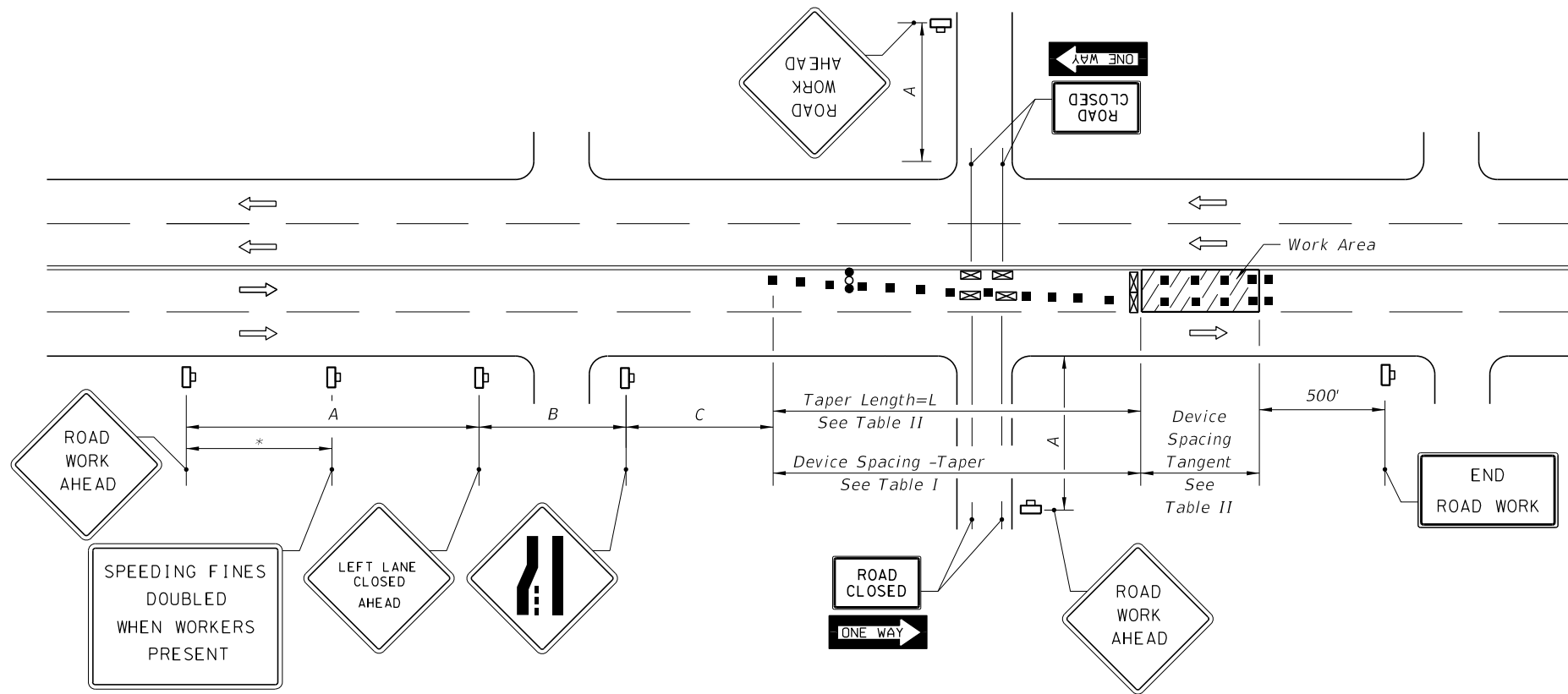

Speed	Spacing (ft.)		
	A	B	C
40 mph or less	200	200	200
45 mph	350	350	350

\* 500' beyond the ROAD WORK AHEAD sign or midway between signs whichever is less.

**Table I  
Device Spacing**

Speed (mph)	Max. Distance Between Devices (ft.)			
	Cones or Tubular Markers		Type I or Type II Barricades or Vertical Panels or Drums	
	Taper	Tangent	Taper	Tangent
25	25	50	25	50
30 to 45	25	50	30	50

**LEFT LANE CLOSED ON FAR SIDE OF MINOR SIDESTREET - RESTRICTED TURNING MOVEMENTS**

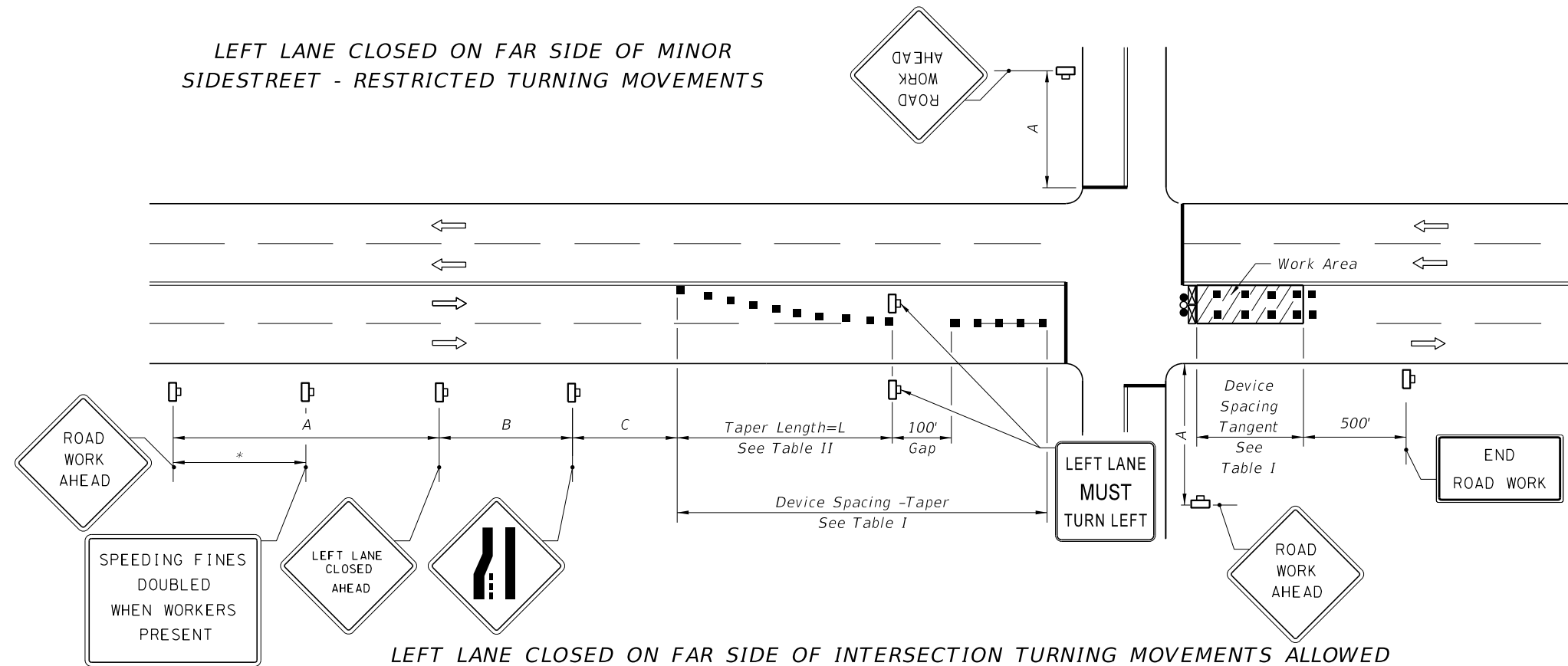

**Table II  
Taper Length - Merge  
(12' Lateral Transition)**

Speed (mph)	L (ft.)	Notes (Merge)
25	125	$L = \frac{WS^2}{60}$
30	180	
35	245	
40	320	
45	540	$L = WS$

For lateral transitions other than 12', use formula for L shown in the notes column. Where:  
 L = Length of taper in feet  
 W = Width of lateral transition in feet  
 S = Posted speed limit (mph)

**LEFT LANE CLOSED ON FAR SIDE OF INTERSECTION TURNING MOVEMENTS ALLOWED**

1. The normal procedure is to close on the near side of the intersection any lane that is not carried through the intersection. However, when this results in the closure of a left lane having significant left turning movements, then the left lane may be reopened as a turn bay for left turns only as show in this detail.

LAST REVISION  
07/01/15

DESCRIPTION:

**FDOT** FY 2016-17  
DESIGN STANDARDS

MULTILANE, WORK NEAR INTERSECTION  
MEDIAN OR OUTSIDE LANE

INDEX NO.  
**616**

SHEET NO.  
**3 of 3**

Speed	Spacing (ft.)	
	A	B
40 mph or less	200	200
45 mph	350	350

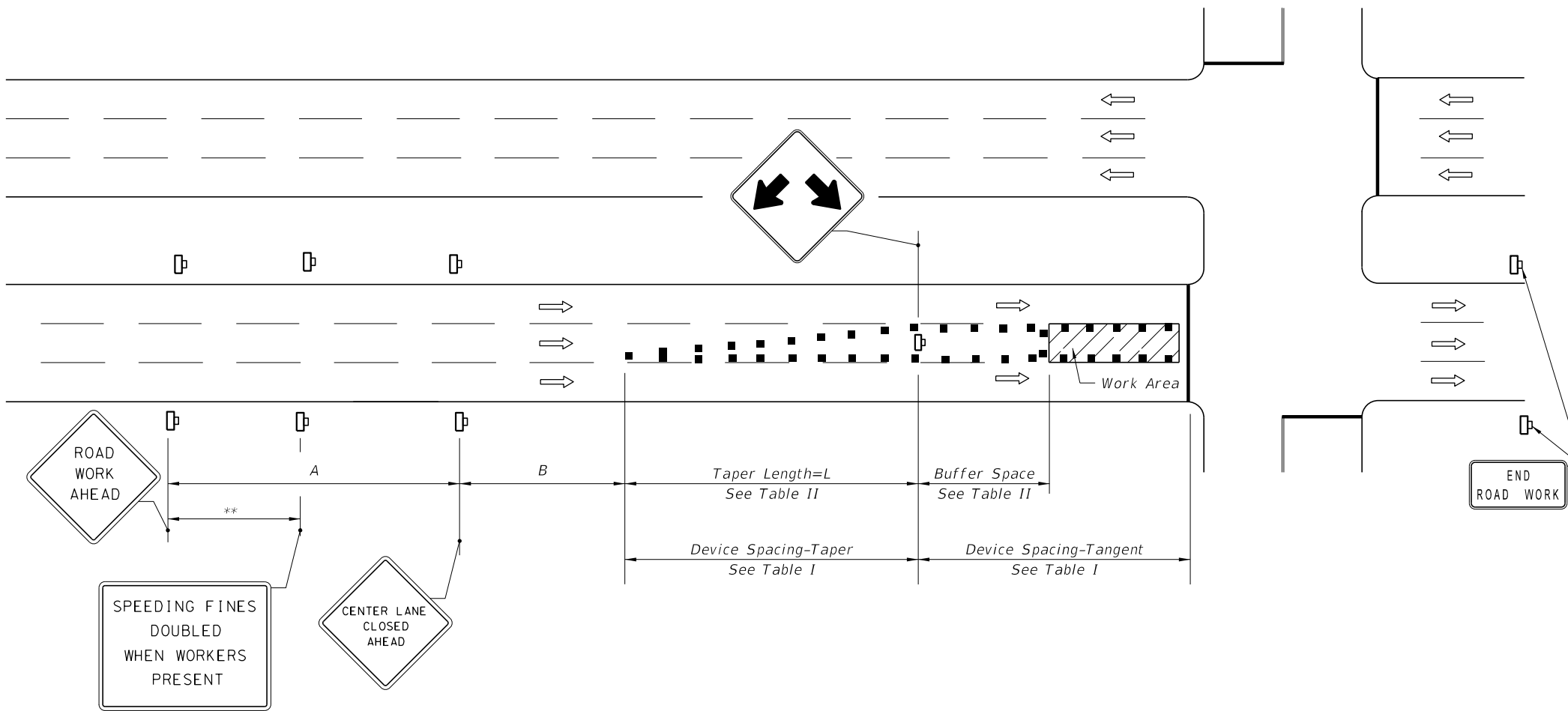

\*\* 500' beyond the ROAD WORK AHEAD sign or midway between signs whichever is less.

Speed (mph)	Max. Distance Between Devices (ft.)			
	Cones or Tubular Markers		Barricades or Vertical Type I or Type II Panels or Drums	
	Taper	Tangent	Taper	Tangent
25	25	50	25	50
30 to 45	25	50	30	50

Speed (mph)	Buffer Space Dist. (ft.)	Taper Length (12' Lateral Transition)	
		L (ft.)	Notes (Merge)
25	155	125	$L = \frac{WS^2}{60}$
30	200	180	
35	250	245	
40	305	320	$L = WS$
45	360	540	

### GENERAL NOTES

1. Work operations shall be confined to one center travel lane, leaving the adjacent travel lanes open to traffic.
2. The merging taper shall direct vehicular traffic into either the right or left lane, but not both.
3. When vehicles in a parking zone block the line of sight to TCZ signs, the signs shall be post mounted and located in accordance with Index No. 17302.
4. If the work space extends across a crosswalk, the crosswalk should be closed using the information in Index No. 660.
5. For general TCZ requirements and additional information, refer to Index No. 600.

### DURATION NOTES

1. Signs and buffer space may be omitted if all of the following conditions are met:
  - a. Work operations are 60 minutes or less.
  - b. Speed limit is 45 mph or less.
  - c. No sight obstructions to vehicles approaching the work area for a distance equal to the buffer space and the taper length combined.
  - d. Vehicles in the work area have high-intensity, rotating, flashing, oscillating, or strobe lights operating.
  - e. Volume and complexity of the roadway has been considered.

When Buffer Space cannot be attained due to geometric constraints, the greatest attainable length shall be used, but not less than 200 ft.

For lateral transitions other than 12', use formula for L shown in the notes column. Where:  
 L = Length of taper in feet  
 W = Width of lateral transition in feet  
 S = Posted speed limit (mph)

### CONDITIONS

WHERE ANY VEHICLE, EQUIPMENT, WORKERS OR THEIR ACTIVITIES ENCROACH ON THE PAVEMENT REQUIRING THE CLOSURE OF THE CENTER LANE NEAR AN INTERSECTION.

### SYMBOLS

- Work Area
- Channelizing Device (See Index No. 600)
- Work Zone Sign
- Advance Warning Arrow Board
- Lane Identification + Direction of Traffic

12/31/2015 11:38:42 AM

Erect STOP Sign And Install Removable Stop Bar Marking. Remove Or Cover Existing STOP Sign And Reinstall When Through Lane Reopened To Traffic.

Erect STOP Sign And Install Removable Stop Bar Marking. Remove Or Cover Existing STOP Sign And Reinstall When Through Lane Reopened To Traffic.

**CONDITIONS**

WHERE ANY VEHICLE, EQUIPMENT, WORKERS OR THEIR ACTIVITIES ENCROACH ON THE PAVEMENT REQUIRING THE CLOSURE OF EITHER THE OUTSIDE AND CENTER TRAVEL LANES OR THE MEDIAN AND CENTER TRAVEL LANES, WITH OR WITHOUT CLOSURE OF ADJOINING AUXILIARY LANES, FOR WORK AREA LESS THAN 200' FROM INTERSECTION, FOR A PERIOD OF MORE THAN 60 MINUTES.

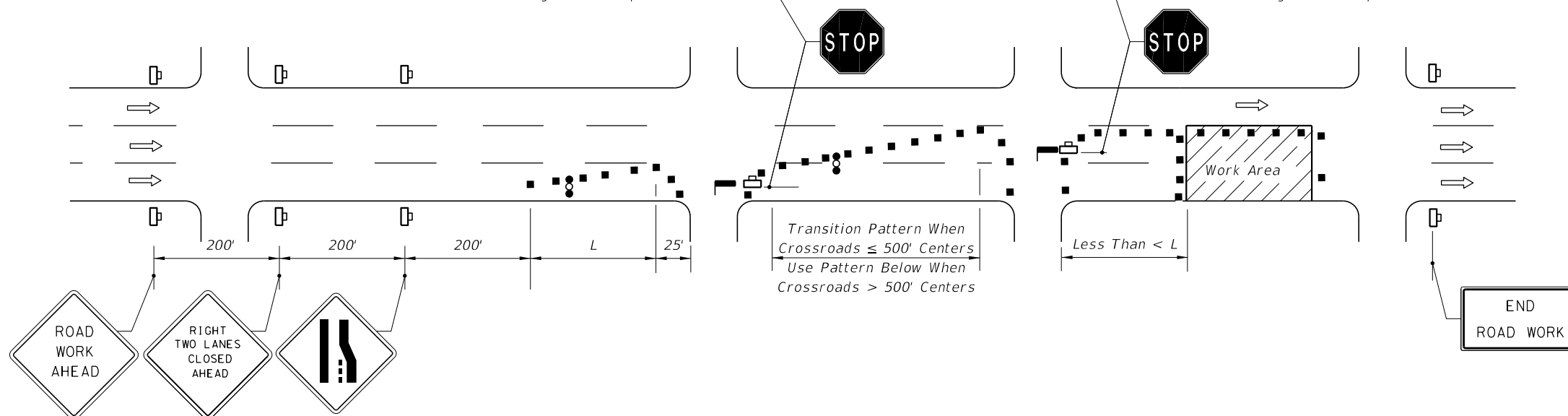

Transition Pattern When Crossroads ≤ 500' Centers  
Use Pattern Below When Crossroads > 500' Centers

Less Than < L

END ROAD WORK

**CONDITIONS**

WHERE ANY VEHICLE, EQUIPMENT, WORKERS OR THEIR ACTIVITIES ENCROACH ON THE PAVEMENT REQUIRING THE CLOSURE OF EITHER THE OUTSIDE AND CENTER TRAVEL LANES OR THE MEDIAN AND CENTER TRAVEL LANES, WITH OR WITHOUT CLOSURE OF ADJOINING AUXILIARY LANES, FOR WORK AREA 200' OR MORE FROM INTERSECTION, FOR A PERIOD OF MORE THAN 60 MINUTES.

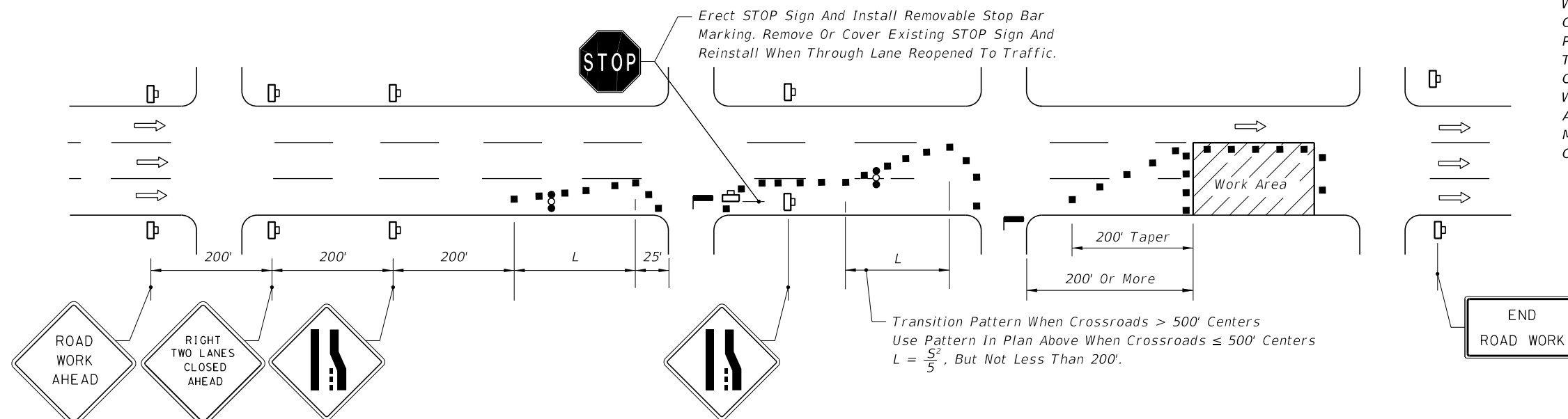

Erect STOP Sign And Install Removable Stop Bar Marking. Remove Or Cover Existing STOP Sign And Reinstall When Through Lane Reopened To Traffic.

Transition Pattern When Crossroads > 500' Centers  
Use Pattern In Plan Above When Crossroads ≤ 500' Centers  
 $L = \frac{S^2}{5}$ , But Not Less Than 200'.

END ROAD WORK

**Table II**  
Taper Length - Merge  
(12' Lateral Transition)

Speed (mph)	L (ft.)	Notes (Merge)
25	125	$L = \frac{WS^2}{60}$
30	180	
35	245	
40	320	$L = WS$
45	540	

For lateral transitions other than 12', use formula for L shown in the notes column. Where:  
L = Length of taper in feet  
W = Width of lateral transition in feet  
S = Posted speed limit (mph)

**GENERAL NOTES**

1. If the work space extends across a crosswalk, the crosswalk should be closed using the information in Index No. 660.
2. Signs are required on the median side for divided highways.
3. The two channelizing devices directly in front and directly at the end of the work area may be omitted provided vehicles in the work area have high-intensity rotating, flashing, oscillating, or strobe lights operating.
4. Within the lateral transitions, the maximum spacing between cones and tubular markers shall be 25'. Maximum spacing between Type I or Type II barricades or vertical panels or drums shall be based on the speed limit as follows: 15' up to 25 MPH; 30' for 30-40 MPH; 50' for 45 MPH.  
  
Spacing for devices parallel to the travel lanes shall be 25' centers for cones or tubular markers and 50' centers for Type I or Type II barricades or vertical panels or drums for 250', thereafter, cones or tubular markers at 50' centers and Type I or Type II barricades or vertical panels or drums at 100' centers.
5. For general TCZ requirements and additional information, refer to Index No. 600.

**SYMBOLS**

- Work Area
- Channelizing Device (See Index No. 600)
- Work Zone Sign
- Advance Warning Arrow Board
- Stop Bar
- Lane Identification + Direction of Traffic

12/31/2015 11:38:43 AM

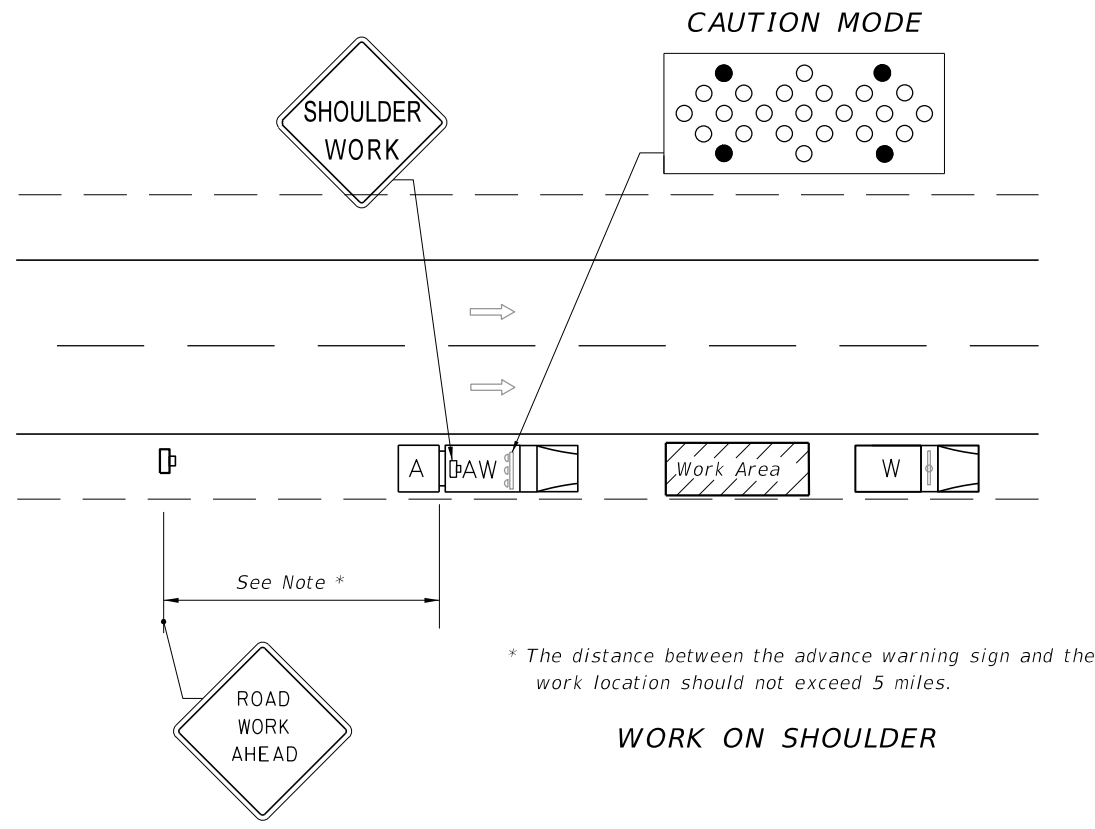

\* The distance between the advance warning sign and the work location should not exceed 5 miles.

**WORK ON SHOULDER**

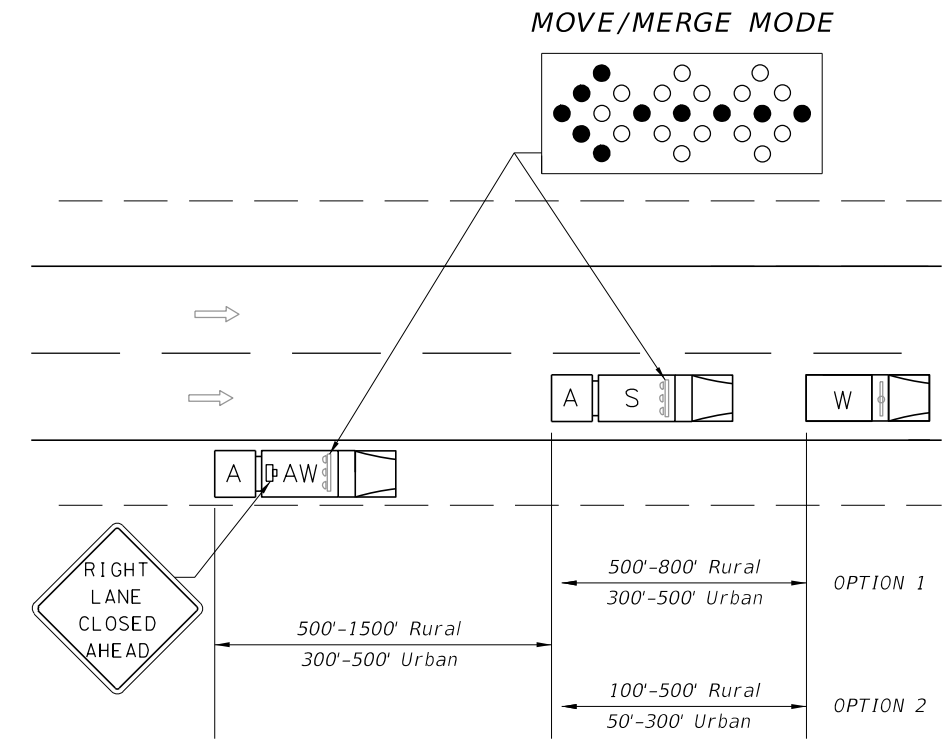

OPTION 1: Advanced Warning Vehicle may be operated in the lane behind the Shadow Vehicle where adequate shoulder width is not available. Approved Truck Mounted Attenuators are required on both the Advance Warning Vehicle and the Shadow Vehicle.

OPTION 2: Advance Warning Vehicle must be operated in the lane behind the Shadow Vehicle. Approved Truck Mounted Attenuators are required on both the Advance Warning Vehicle and the Shadow Vehicle.

**WORK WITHIN TRAVEL LANE  
(Option 1 Shown, Option 2 Similar)**

**GENERAL NOTES**

1. These illustrations are representative of general conditions.
2. The figures illustrate closing the right shoulder or right lanes for various lane configurations. When work is required on left side of roadways, the inverted plan is to be applied. The intent of this index is to allow passing on only one side of the work convoy.
3. Arrow boards shall not be obscured by equipment, supplies, signs, or the enclosure.
4. Vehicle-mounted signs shall be mounted with the bottom of the sign at a minimum height of 48 inches above the pavement. Vehicle mounted changeable message signs may be used in lieu of truck mounted static signs. Changeable message signs shall flash alternately to read "Left or Right Lane" or "Two Left or Two Right Lanes", "Closed Ahead", and the arrow symbol. Arrow boards shall not be used with truck mounted changeable message signs. Sign legends shall be covered or turned from view when work is not in progress.
5. On freeway facilities (interstates, toll roads, and expressways), a traffic control officer is required for all nighttime non-emergency operations for work within the travel lane.
6. If the work vehicle speed exceeds the minimum legal speed limit on limited access facilities and one half the posted speed limit on other facilities, the Engineer may delete requirements for shadow vehicle and attenuator. The work vehicle will be required to have an arrow board and sign message.
7. Where work activities within 2' of the edge of travel way are Incidental (i.e. Mowing, Litter Removal), the Engineer may delete requirements for signs and the advance warning vehicle provided vehicles in the work area have high-intensity rotating, flashing, oscillating, or strobe lights operating.
8. Work, Shadow, and Advance Warning Vehicles shall have high-intensity, rotating, flashing, oscillating, or strobe lights operating.
9. Functional two-way communication is required between all vehicles in the mobile operation convoy.
10. For general TCZ requirements and additional information, refer to Index No. 600.

**SYMBOLS**

- Work Vehicle
- Shadow (S) Vehicle with Arrow Board
- Advance Warning (AW) Vehicle with Arrow Board and Sign Message or Changeable Message Sign
- Truck/Trailer Mounted Attenuator (TMA)
- Lane Identification And Direction Of Traffic
- Arrow Board

12/31/2015 11:38:44 AM

12/3/2015 11:38:44 AM

**MOVE/MERGE MODE**

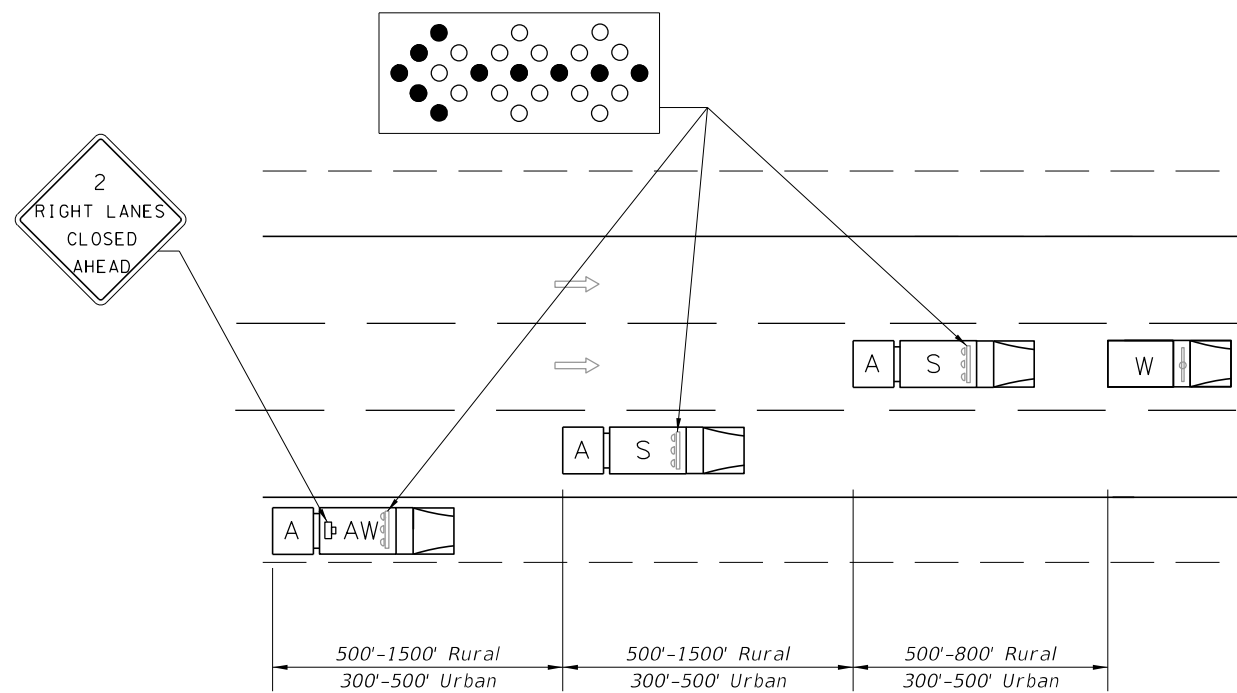

**WORK WITHIN TRAVEL WAY, CENTER LANE OR OUTSIDE CENTERLINE**  
 Where adequate shoulder width is not available, the advance warning vehicle may drive in the lane.

**MOVE/MERGE MODE**

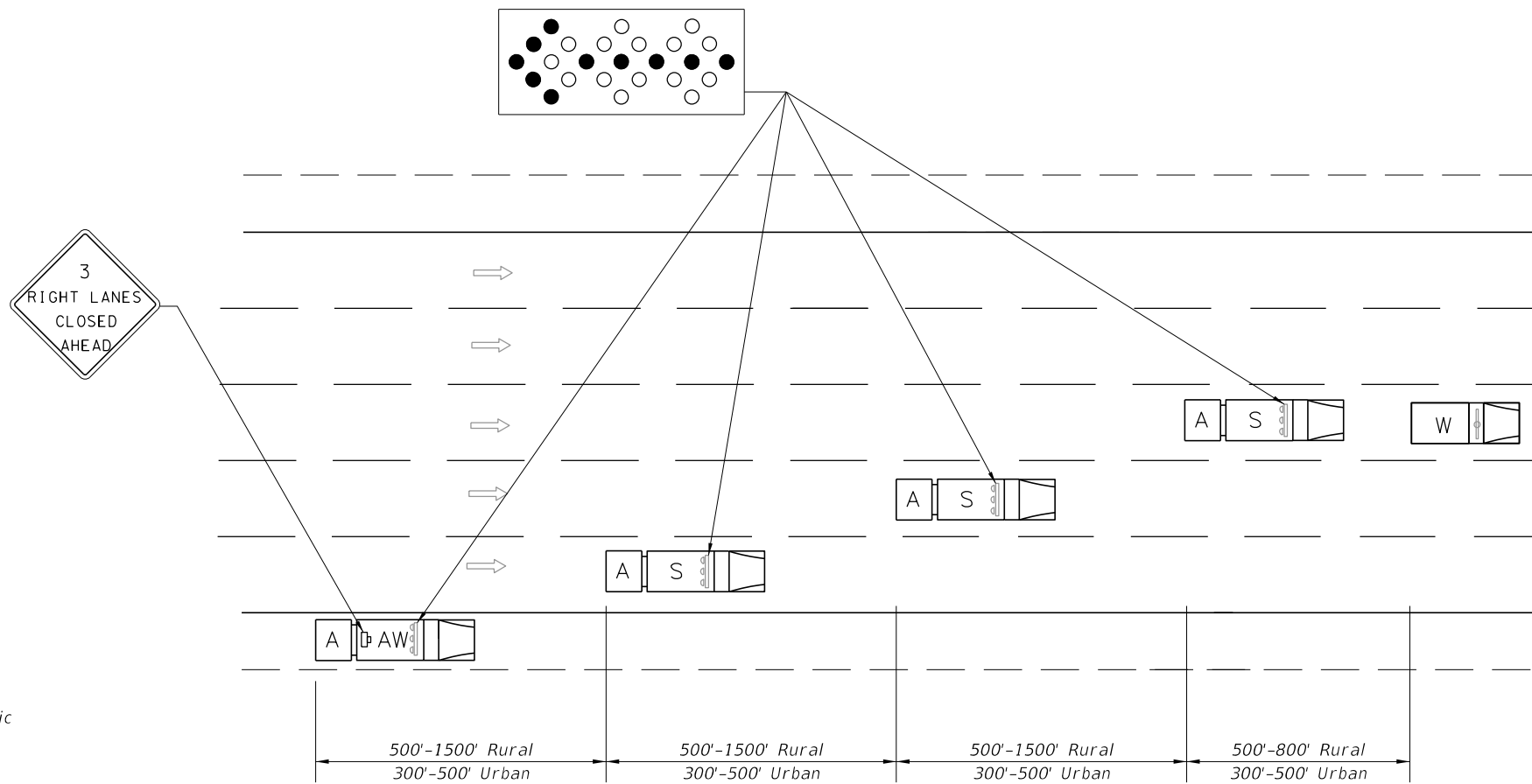

**SYMBOLS**

- Work Vehicle
- Shadow (S) Vehicle with Arrow Board
- Advance Warning (AW) Vehicle with Arrow Board and Sign Message or Changeable Message Sign
- Truck/Trailer Mounted Attenuator (TMA)
- Lane Identification And Direction Of Traffic
- Arrow Board

**WORK WITHIN TRAVEL LANE**

LAST REVISION 07/01/15	DESCRIPTION:
---------------------------	--------------

12/31/2015 11:38:45 AM

### GENERAL NOTES

1. TWO-WAY TRAFFIC sign(s) shall be repeated every 1/4 mile in each direction, throughout the tangent distance (T).
2.  $L$  (min.) =  $WS$  for speeds  $\geq 45$  mph  
 $= \frac{WS^2}{60}$  for speeds  $\leq 40$  mph  
 Where:  
 $W$  = Width of lateral transition in feet.  
 $S$  = Posted speed limit (mph).
3. Where the tangent distance (T) exceeds 250', spacing between Type I or II barricades or vertical panels or drums may be increased to 100' within the limits of the tangent, or post mounted delineators at 50' centers may be substituted for barricades, vertical panels or drums.
4. All existing pavement markings within the realignment which conflict with the revised traffic pattern are to be removed and removable pavement markings used for making new edge lines.
5. When side roads, cross roads or interchanges intersects the highway within the TTC zone, additional TTC devices shall be placed in accordance with other applicable TCZ Indexes.
6. For general TCZ requirements and additional information, refer to Index No. 600.

### SCHEME APPLICATIONS

Scheme 1: Restricted Construction Limits.





Scheme 2: Unrestricted Construction Limits And Light To Moderate Traffic.

Scheme 3: Unrestricted Construction Limits And Moderate To Heavy Traffic.

Where: Construction Limits Are The Outward Beginning Or Ending Of Lane Reductions.

Where: Unless A Specific Scheme Is Called For In The Plans, Scheme Selection Shall Be At The Contractor's Option And As Approved By The Engineer.

### SYMBOLS

-  Work Area
-  Channelizing Device (See Index No. 600)
-  Work Zone Sign
-  Advance Warning Arrow Board
-  Lane Identification + Direction of Traffic

### CONDITIONS

WHERE ANY VEHICLE, EQUIPMENT, WORKERS OR THEIR ACTIVITIES REQUIRE THE CLOSURE OF ONE ROADWAY AND THE OPPOSING ROADWAY IS CONVERTED TO TEMPORARY TWO-WAY TRAVEL BY WAY OF CROSSOVERS.

LAST REVISION 07/01/15	REVISION	DESCRIPTION:	 <b>FY 2016-17 DESIGN STANDARDS</b>	<b>MULTILANE, DIVIDED TEMPORARY DIVERSION CONNECTION</b>	INDEX NO. <b>620</b>	SHEET NO. <b>1 of 2</b>
---------------------------	----------	--------------	---	--	-------------------------	----------------------------



**BUFFER LENGTH (FEET)**

Construction Zone Speed MPH	X (ft)	Z (ft)
60-70	560	630
55	360	510
≤50	180	380

Type I Or Type II Barricades Or Vertical Panels Or Drums At 50' Centers

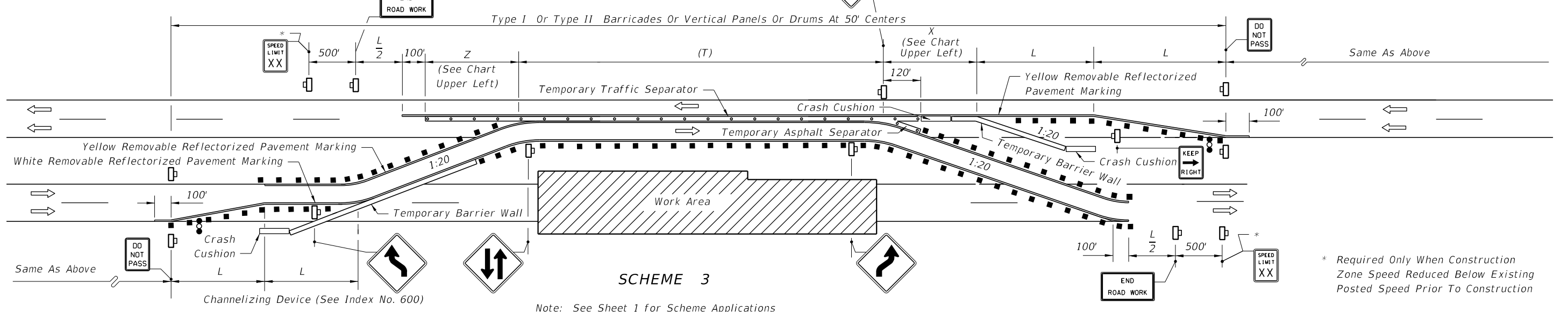
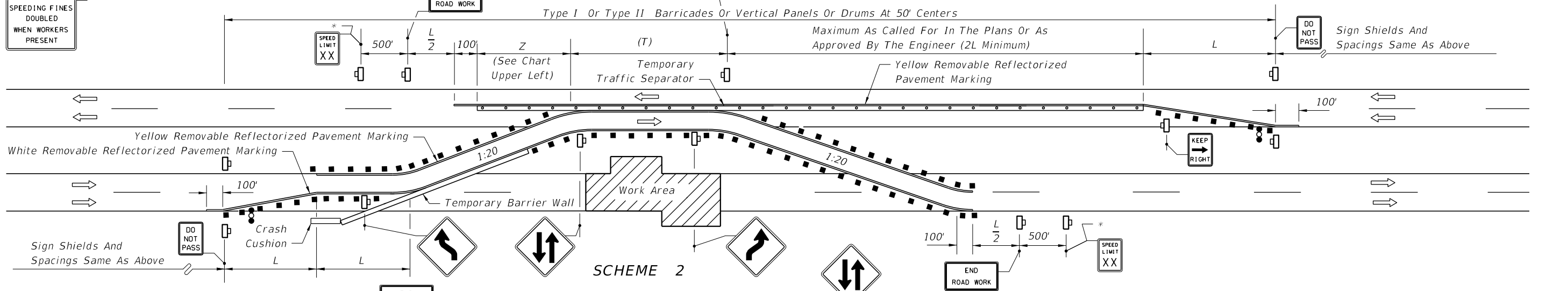
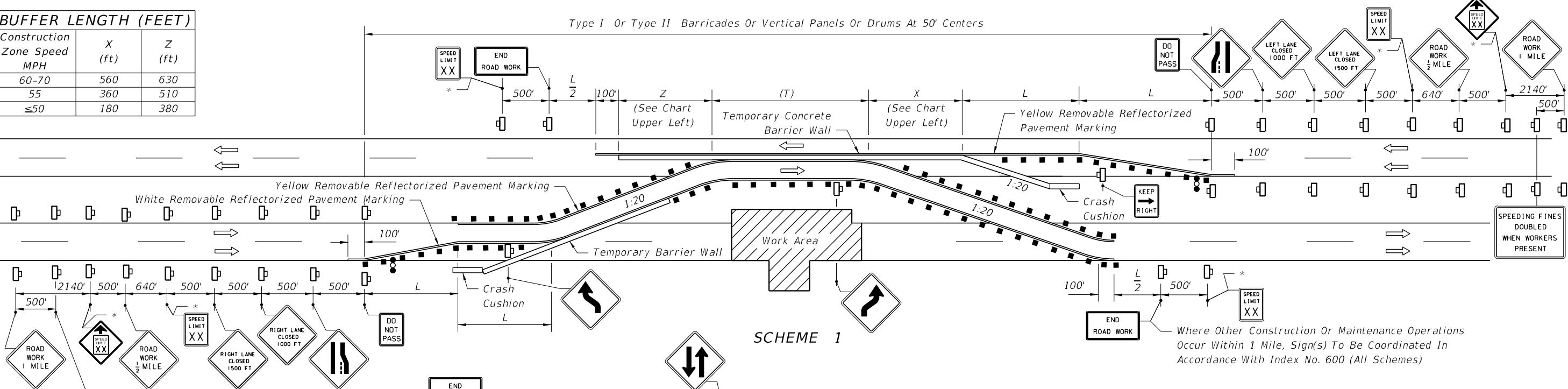

Note: See Sheet 1 for Scheme Applications

\* Required Only When Construction Zone Speed Reduced Below Existing Posted Speed Prior To Construction

12/3/2015 11:38:48 AM

LAST REVISION 07/01/15	REVISION	DESCRIPTION:	<p>FY 2016-17 DESIGN STANDARDS</p>	<p>MULTILANE, DIVIDED TEMPORARY DIVERSION CONNECTION</p>	<p>INDEX NO. 620</p>	<p>SHEET NO. 2 of 2</p>
---------------------------	----------	--------------	--	--	--------------------------	-----------------------------



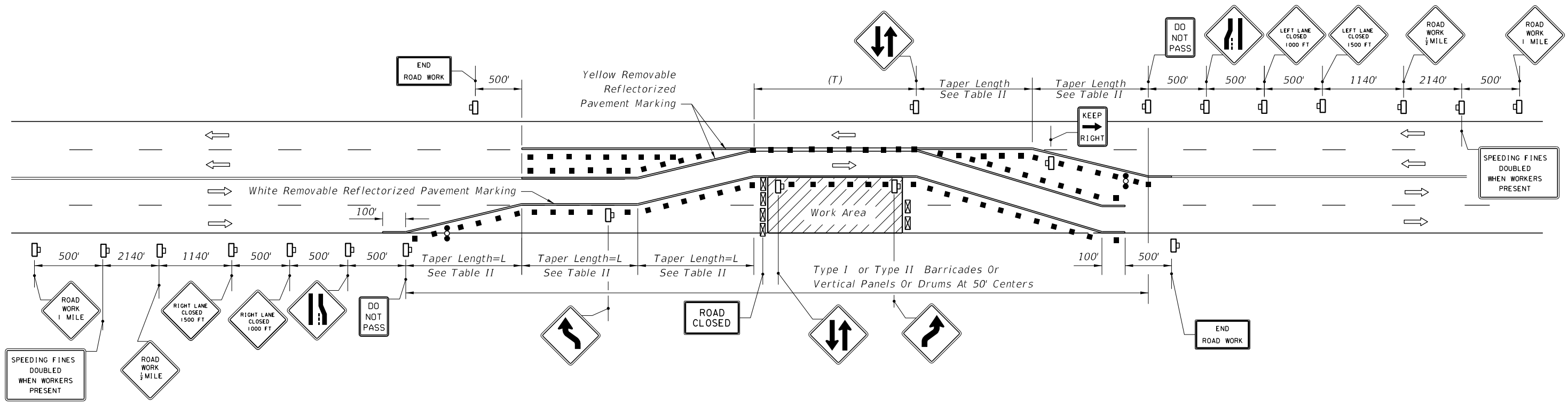



12/31/2015 11:38:48 AM



**GENERAL NOTES**

1. TWO-WAY TRAFFIC signs shall be repeated every 1/4 mile in each direction, through the tangent distance (T).
2. When paved shoulders having a width of 8 ft. or more are closed, channelizing devices shall be used to close the shoulder in advance of the merging taper to direct vehicular traffic to remain within the travel way. See Index No. 612 for shoulder taper formulas.
3. Where the tangent distance (T) exceeds 250', spacing between cones or tubular markers may be increased to 50' or spacing between Type I or Type II barricades or vertical panels or drums may be increased to 100' within the limits of the tangent.
4. This index does not apply when work is being performed in the middle lane(s) of a six or more lane highway. Special maintenance of traffic details will be required.
5. When a side road intersects the highway within the TTC zone, additional TTC devices shall be placed in accordance with other applicable TCZ Indexes.
6. For general TCZ requirements and additional information, refer to Index No. 600.

**SYMBOLS**

-  Work Area
-  Channelizing Device (See Index No. 600)
-  Type III Barricade
-  Work Zone Sign
-  Advance Warning Arrow Board
-  Lane Identification + Direction of Traffic

**Table II  
Taper Length - Merge  
(12' Lateral Transition)**

Speed (mph)	L (ft.)	Notes (Merge)
25	125	$L = \frac{WS^2}{60}$
30	180	
35	245	
40	320	L=WS
45	540	
50	600	
55	660	
60	720	
65	780	
70	840	

For lateral transitions other than 12' use formula for L shown in the notes column. Where:

- L = Length of taper in feet
- W = Width of lateral transition in feet
- S = Posted speed limit (mph)

**CONDITIONS**

WHERE ANY VEHICLE, EQUIPMENT, WORKERS OR THEIR ACTIVITIES REQUIRE THE CLOSURE OF THE LANES IN ONE DIRECTION AND A DIVERSION IS PROVIDED BY UTILIZING ONE LANE OF THE OPPOSING TRAFFIC LANES.

LAST REVISION	DESCRIPTION:
07/01/15	

12/3/2015 11:38:49 AM

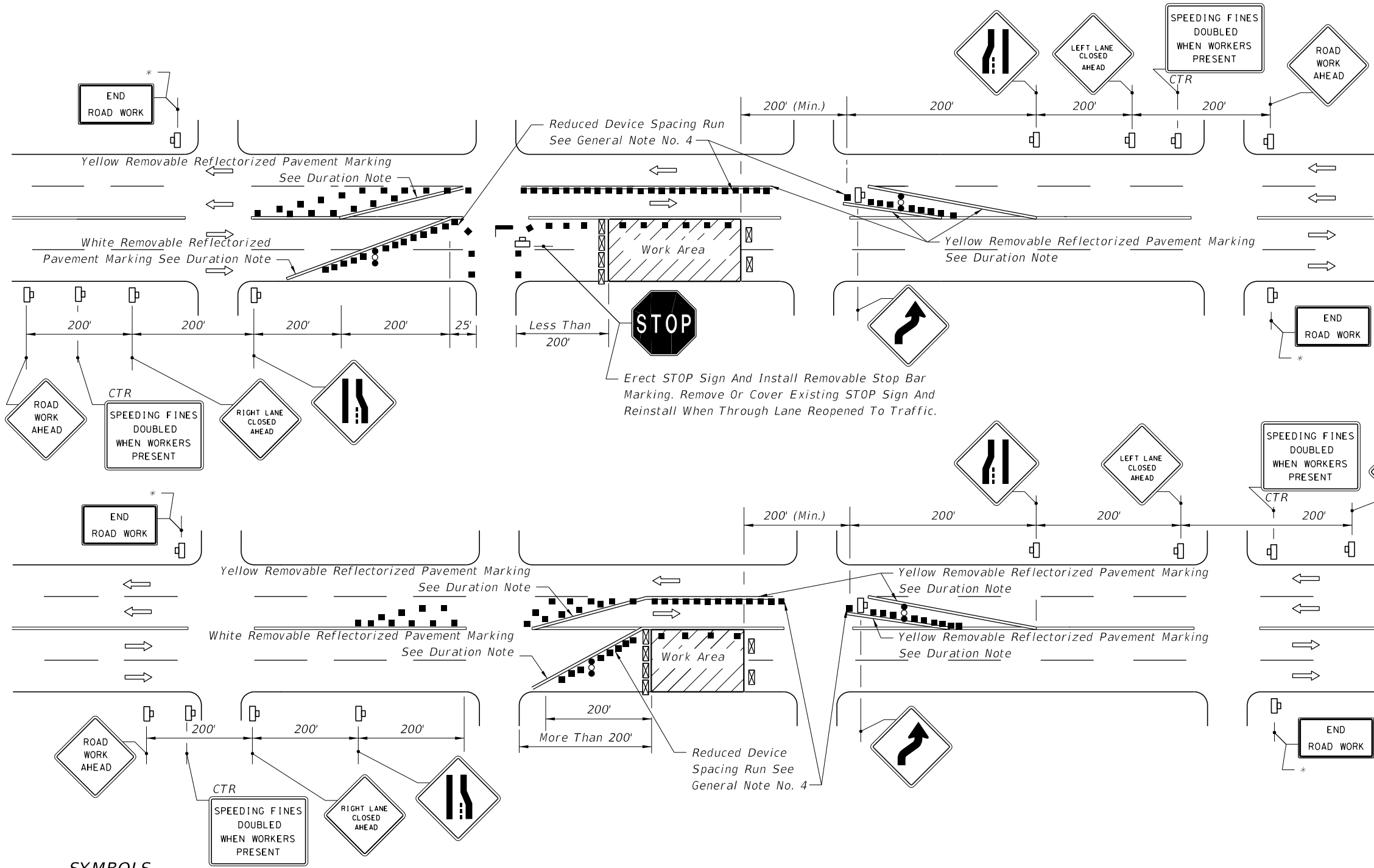

**CONDITIONS**  
 WHERE ANY VEHICLE, EQUIPMENT, WORKERS OR THEIR ACTIVITIES ENCROACH ON THE PAVEMENT REQUIRING THE CLOSURE OF TRAFFIC LANES IN ONE DIRECTION AND THE USE OF ONE OPPOSING TRAFFIC LANE TO MAINTAIN TWO-WAY TRAFFIC, FOR WORK AREA LESS THAN 200' FROM INTERSECTION, FOR A PERIOD OF MORE THAN 60 MINUTES.

**CONDITIONS**  
 WHERE ANY VEHICLE, EQUIPMENT, WORKERS OR THEIR ACTIVITIES ENCROACH ON THE PAVEMENT REQUIRING THE CLOSURE OF TRAFFIC LANES IN ONE DIRECTION AND THE USE OF ONE OPPOSING TRAFFIC LANE TO MAINTAIN TWO-WAY TRAFFIC, FOR WORK AREA 200' OR MORE FROM INTERSECTION, FOR A PERIOD OF MORE THAN 60 MINUTES.

\* When Other Construction Or Maintenance Operations Occur Within 1 Mile, Sign To Be Omitted And Signing To Be Coordinated In Accordance With Index No. 600.

- SYMBOLS**
- Work Area
  - Channelizing Device (See Index No. 600)
  - Type III Barricade
  - Work Zone Sign
  - Advance Warning Arrow Board
  - Stop Bar
  - Lane Identification + Direction of Traffic

- GENERAL NOTES**
1. When vehicles in a parking zone block the line of sight to TCZ signs or when TCZ signs encroach on a normal pedestrian walkway, the signs shall be post mounted and located in accordance with Index No. 17302.
  2. Dual signs are required for divided roadways.
  3. Channelizing devices are to be spaced with Type I or Type II barricades or vertical panels or drums at 30' centers in tapers, 50' centers in tangent sections and 15' centers where reduced device spacing runs are identified in the drawing.
  4. For general TCZ requirements and additional information, refer to Index No. 600.

**DURATION NOTE**  
 Removable reflectorized pavement markings shall be used when closure time exceeds one daylight period.

LAST REVISION 07/01/15	REVISION	DESCRIPTION:	 FY 2016-17 DESIGN STANDARDS	MULTILANE WORK NEAR INTERSECTION-TEMPORARY DIVERSION CONNECTION - 35MPH OR LESS	INDEX NO. 622	SHEET NO. 1 of 1
---------------------------	----------	--------------	------------------------------------	--	------------------	---------------------

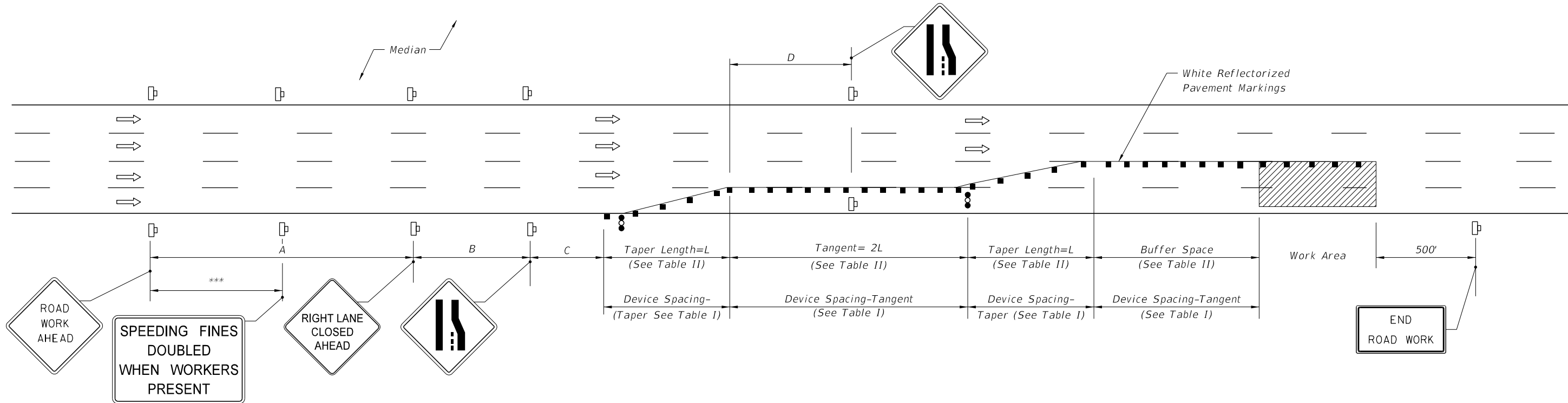

DISTANCE BETWEEN SIGNS				
Speed	Spacing (ft.)			
	A	B	C	D**
40 mph or less	200	200	200	L
45 mph	350	350	350	L
50 mph	500	500	500	L
*55 mph or greater	2640	1640	1000	L

\* The ROAD WORK 1 MILE sign may be used as an alternate to the ROAD WORK AHEAD sign MILE sign may be used as an alternate to the RIGHT LANE CLOSED AHEAD sign.

\*\* See Table II for L

\*\*\* 500' beyond the ROAD WORK AHEAD sign or midway between signs whichever is less.

Table I Device Spacing				
Speed (mph)	Max. Distance Between Devices (ft.)			
	Cones or Tubular Markers		Type I or Type II Barricades or Vertical Panels or Drums	
	Taper	Tangent	Taper	Tangent
25	25	50	25	50
30 to 45	25	50	30	50
50 to 70	25	50	50	100

Table II Buffer Space and Taper Length				
Speed (mph)	Buffer Space	Taper Length (12' Lateral Transition)		Tangent
		Dist. (ft.)	L (ft.) Notes (Merge)	
25	155	125	$L = \frac{WS^2}{60}$	250
30	200	180		360
35	250	245		490
40	305	320	$L = WS$	640
45	360	540		1080
50	425	600		1200
55	495	660		1320
60	570	720		1440
65	645	780		1560
70	730	840	1680	

When Buffer Space cannot be attained due to geometric constraints, the greatest attainable length shall be used, but not less than 200 ft.

For lateral transitions other than 12', use formula for L shown in the notes column.

Where:

L= Length of taper in feet  
W= Width of lateral transition in feet  
S= Posted speed limit (mph)

### GENERAL NOTES

1. Work operations shall be confined to the two outside traffic lanes, leaving the adjacent lane(s) open to traffic.
2. On undivided highways the median signs as shown are to be omitted.
3. When work is performed in the median lane on divided highways, the channelizing device plan is inverted and left lanes closed and lane ends signs substituted for the right lanes closed and lane end signs.
4. When a side road intersects the highway within the TTC zone, additional TTC devices shall be placed in accordance with other applicable TCZ Indexes.
5. For general TCZ requirements and additional information, refer to Index No. 600.
6. When paved shoulders having a width of 8 ft. or more are closed, channelizing devices shall be used to close the shoulder in advance of the merging taper to direct vehicular traffic to remain within the travel way. See Index No. 612 for shoulder taper formulas.

### DURATION

Temporary white edgeline may be omitted for work operations less than three (3) days.

### CONDITIONS

WHERE ANY VEHICLE, EQUIPMENT, WORKERS OR THEIR ACTIVITIES ENCROACH ON THE TWO LANES ADJACENT TO EITHER SHOULDER.

### SYMBOLS

- Work Area
- Channelizing Device (See Index No. 600)
- Work Zone Sign
- Advance Warning Arrow Board

12/3/2015 11:38:50 AM

12/3/2015 11:38:51 AM

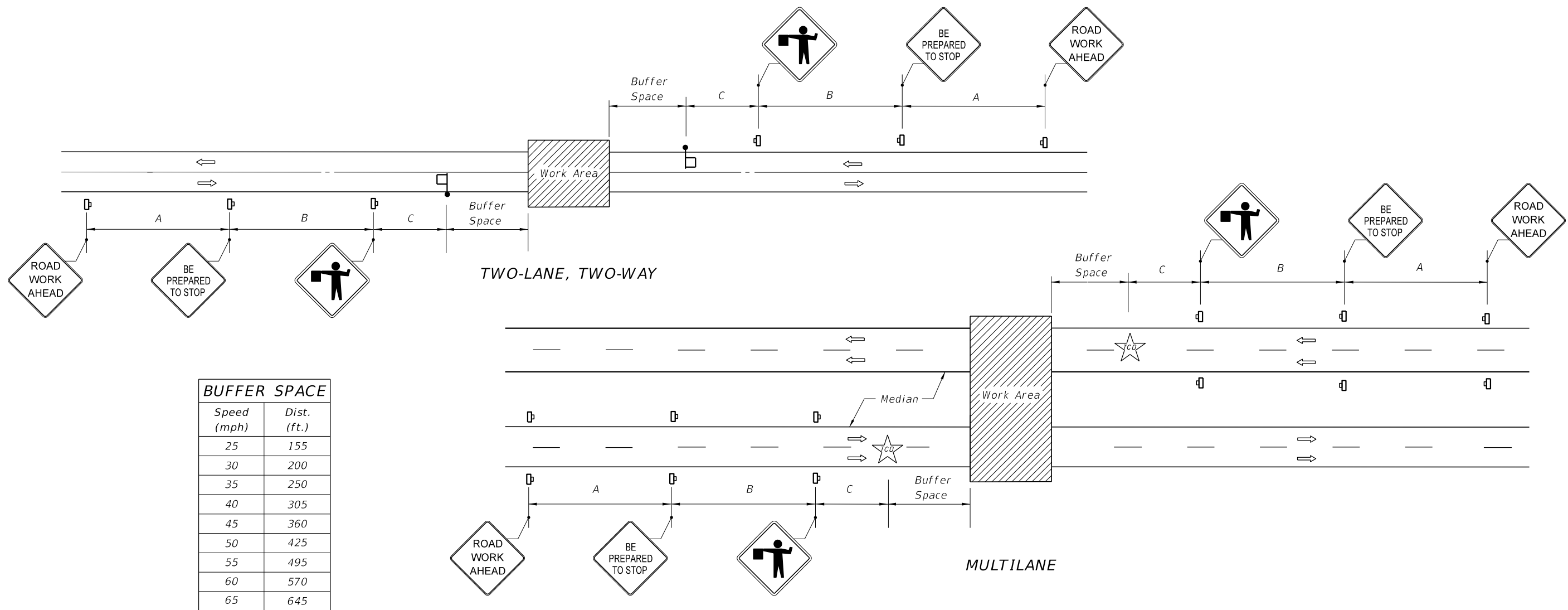

BUFFER SPACE	
Speed (mph)	Dist. (ft.)
25	155
30	200
35	250
40	305
45	360
50	425
55	495
60	570
65	645

DISTANCE BETWEEN SIGNS			
Speed (mph)	Spacing (ft.)		
	A	B	C
40 or less	200	200	200
45	350	350	350
50 or greater	500	500	500

**SYMBOLS**

- Work Area
- Work Zone Sign
- Flagger
- Traffic Control Officer
- Lane Identification + Direction of Traffic

**GENERAL NOTES**

1. This Index does not apply to limited access facilities.
2. When a side road intersects the highway within the TTC zone, additional TTC devices shall be placed in accordance with applicable TCZ Indexes.
3. Traffic volume or complexity of the roadway may dictate additional devices, signs, flagmen and/or a traffic control officer.
4. The buffer space may be omitted if there are no sight obstructions to vehicles approaching the Flagger/Officer for distance equal to the buffer space.
5. A Flagger may be substituted for a Traffic Control Officer and the BE PREPARED TO STOP sign may be omitted, when the following conditions are met:
  - a. Speed limit is 45 mph or less.
  - b. No sight obstructions to vehicles approaching the Flagger/Officer for a distance equal to the buffer space.
  - c. Vehicles in the work area have high-intensity, rotating, flashing, oscillating, or strobe lights operating.
6. On undivided highways the median sign as shown are to be omitted.
7. For general TCZ requirements and additional information refer to FDOT Index No. 600.

**CONDITIONS**

PLANNED CLOSURE NOT EXCEEDING 5 MINUTES.

LAST REVISION 07/01/15	DESCRIPTION:
---------------------------	--------------

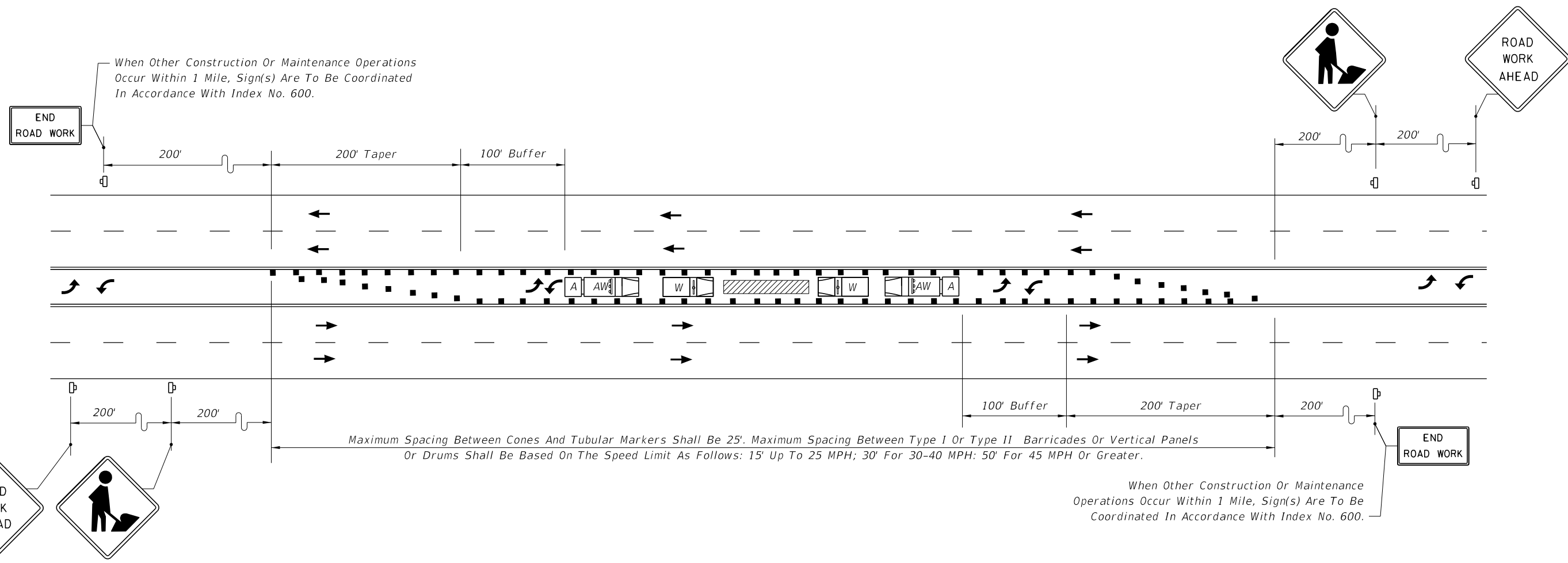

**SYMBOLS**

- Work Area
- Channelizing Device (See Index No. 600)
- Work Zone Sign
- Work Vehicle With Rotating/Strobe Lights
- Shadow (S) Or Advance Warning (AW) Vehicle with Advance Warning Arrow Board and Sign Message
- Truck/Trailer Mounted Attenuator (TMA)

**GENERAL NOTES**

1. Work operations shall be confined to two way left turn lane, leaving the adjacent lanes open to traffic.
2. Advance Warning Vehicle will have an Advanced Warning Arrow Board in the Warning Mode.
3. When a side road intersects the highway within the TTC zone, additional TTC devices shall be placed in accordance with other applicable TCZ Indexes.
4. For general TCZ requirements and additional information, refer to Index No. 600.

**CONDITIONS**

WHERE ANY VEHICLE, EQUIPMENT, WORKERS OR THEIR ACTIVITIES ARE BEING CONDUCTED IN THE TWO WAY LEFT TURN LANE.

12/3/2015 11:38:53 AM

LAST REVISION 07/01/15	REVISION	DESCRIPTION:	 FY 2016-17 DESIGN STANDARDS	TWO WAY LEFT TURN LANE CLOSURE	INDEX NO. 628	SHEET NO. 1 of 1
---------------------------	----------	--------------	------------------------------------	--------------------------------	------------------	---------------------

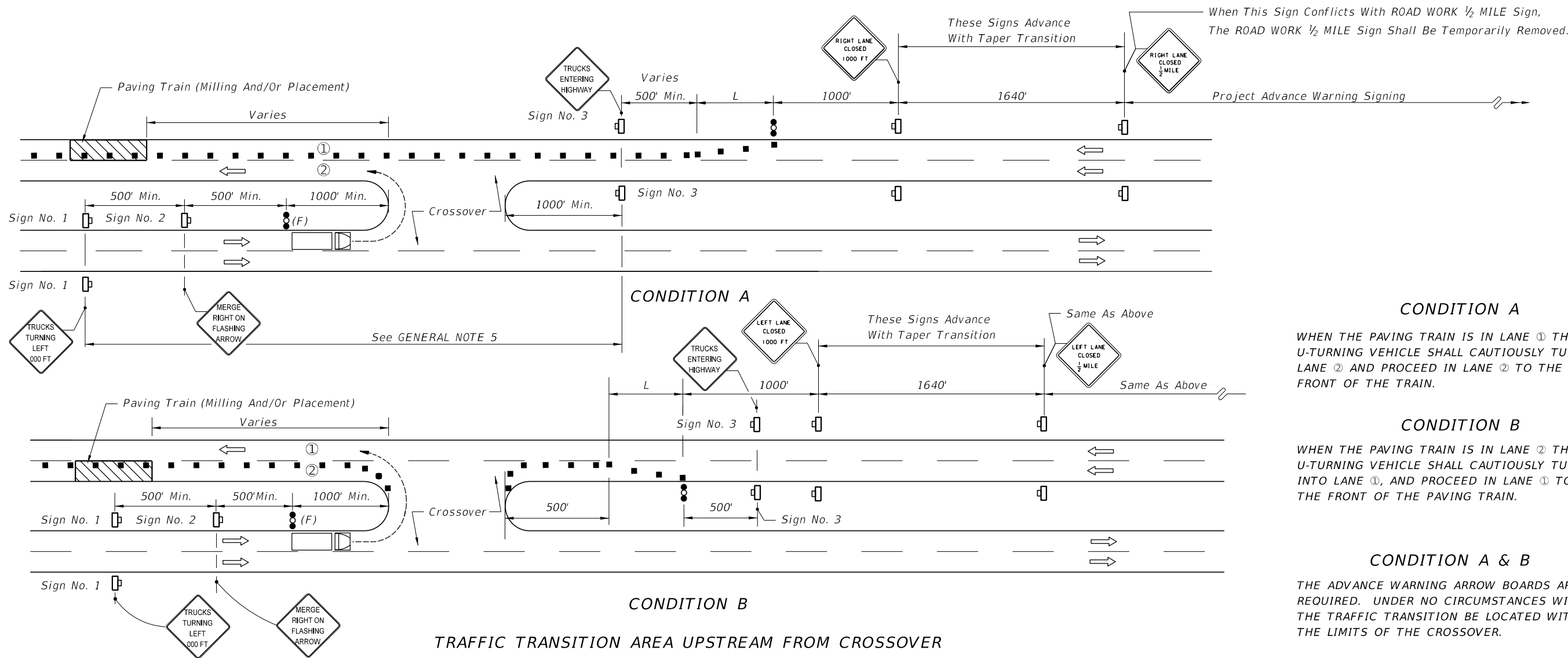

**CONDITION A**  
 WHEN THE PAVING TRAIN IS IN LANE ① THE U-TURNING VEHICLE SHALL CAUTIOUSLY TURN INTO LANE ② AND PROCEED IN LANE ② TO THE FRONT OF THE TRAIN.

**CONDITION B**  
 WHEN THE PAVING TRAIN IS IN LANE ② THE U-TURNING VEHICLE SHALL CAUTIOUSLY TURN INTO LANE ①, AND PROCEED IN LANE ① TO THE FRONT OF THE PAVING TRAIN.

**CONDITION A & B**  
 THE ADVANCE WARNING ARROW BOARDS ARE REQUIRED. UNDER NO CIRCUMSTANCES WILL THE TRAFFIC TRANSITION BE LOCATED WITHIN THE LIMITS OF THE CROSSOVER.

**CONDITION B**  
 TRAFFIC TRANSITION AREA UPSTREAM FROM CROSSOVER

**CASE I**

**GENERAL NOTES**

- This index does not apply to limited access facilities.
- When crossovers do not exist, the contractor will construct temporary crossovers in accordance with Index No. 631.
- $L =$  Length of taper in feet:  
 $= \frac{WS}{60}$  for speeds  $\geq 45$  mph  
 $= \frac{WS^2}{60}$  for speeds  $\leq 40$  mph  
 Where:  
 $W =$  Width of lateral transition in feet.  
 $S =$  Posted speed limit (mph).
- Within the lateral transitions, the maximum spacing between cones and tubular markers shall be 25'. Maximum spacing between Type I or Type II barricades or vertical panels or drums shall be based on the speed limit as follows: 15' up to 25 MPH; 30' for 30-40 MPH; 50' for 45 MPH or greater.  
 Spacing for devices parallel to the travel lanes shall be 25' centers for cones or tubular markers and 50' for Type I or Type II barricades or vertical panels or drums.
- For Case I, Condition A, when the median width is too narrow for trucks to make turns into Lane No. 2, Sign Nos. 1, 2, 3 and the Flagger Actuated Advance Warning Arrow Board shall be moved ahead to a crossover in advance of the paving lane taper. Project advance warning signs (not shown) shall be located in advance of the relocated Sign No. 3.
- For Case II, Conditions A & B, when the median width is too narrow for trucks to make turns into Lane No. 2, Sign Nos. 1, 2, 3 and the Flagger Actuated Advance Warning Arrow Board shall be moved ahead to a crossover in advance of the 'RIGHT LANE CLOSED 1/2 MILE' sign. Project advance warning signs (not shown) shall be located in advance of the relocated Sign No. 3.

- SYMBOLS**
- Work Area
  - Channelizing Device (See Index No. 600)
  - Work Zone Sign
  - Advance Warning Arrow Board - Type C (48"x 96")
  - Advance Warning Arrow Board - Type C (48"x 96")
  - Trailer Mounted And Actuated By Flagger Upon Approach Of The Work Vehicle
  - Work Vehicle
  - Lane Number
  - Lane Identification + Direction of Traffic

12/31/2015 11:38:53 AM

LAST REVISION 07/01/15	REVISION	DESCRIPTION:	FY 2016-17 DESIGN STANDARDS	CROSSOVER FOR PAVING TRAIN OPERATIONS, RURAL	INDEX NO. 630	SHEET NO. 1 of 2
---------------------------	----------	--------------	--------------------------------	---	------------------	---------------------

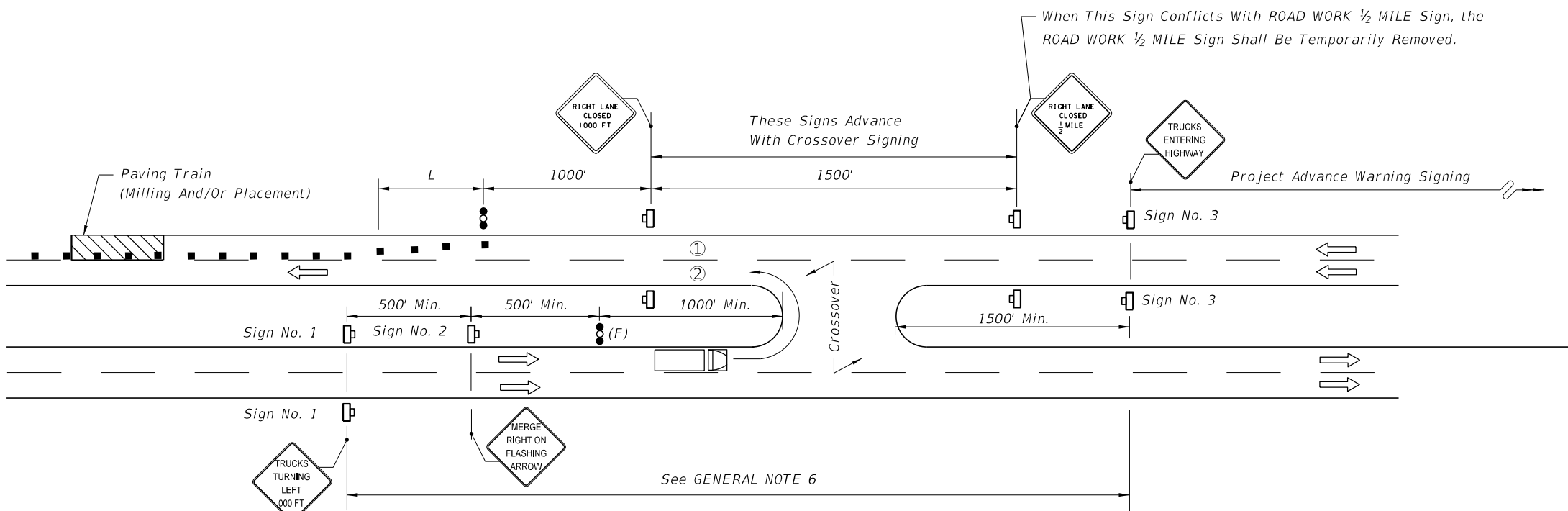

CONDITION A

**CONDITION A**  
 WHEN THE PAVING TRAIN IS IN LANE ① THE U-TURNING VEHICLE SHALL CAUTIOUSLY TURN INTO LANE ② AND PROCEED IN LANE ② TO THE FRONT OF THE TRAIN.

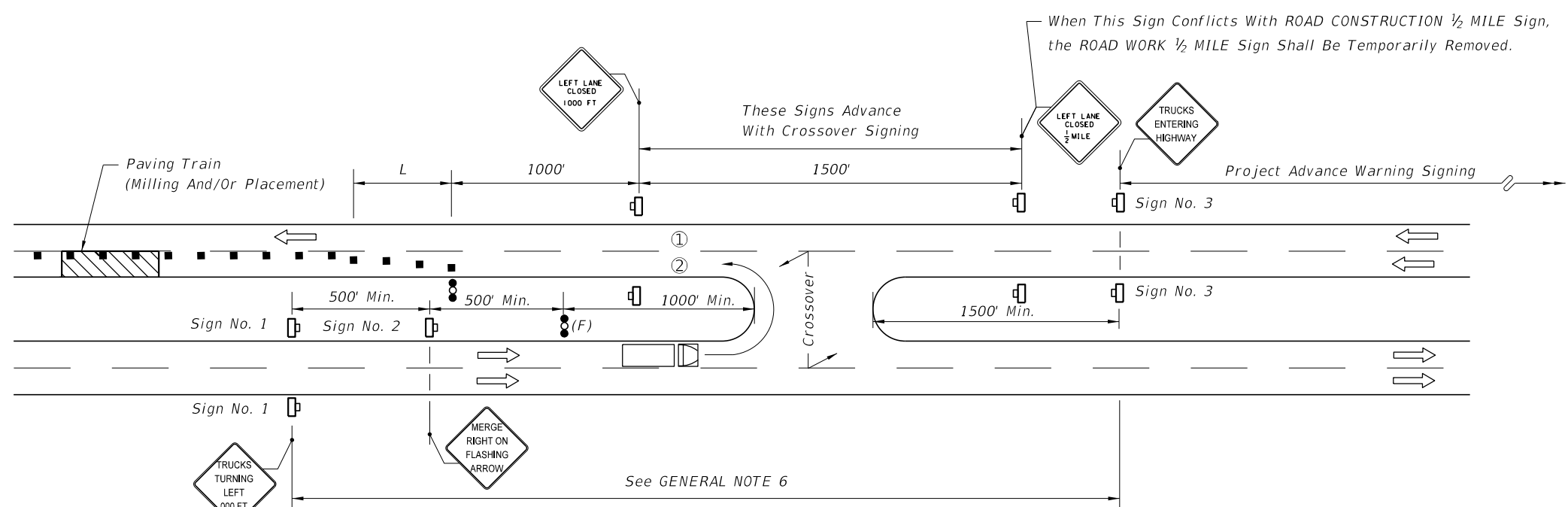

CONDITION B

**CONDITION B**  
 WHEN THE PAVING TRAIN IS IN LANE ② THE U-TURNING VEHICLE SHALL TURN INTO LANE ①, CAUTIOUSLY MERGE INTO LANE ① AND PROCEED TO THE FRONT OF THE PAVING TRAIN.

**CONDITION A & B**  
 THE ADVANCE WARNING ARROW BOARD IS REQUIRED. UNDER NO CIRCUMSTANCES WILL THE TRAFFIC TRANSITION BE LOCATED WITHIN THE LIMITS OF THE CROSSOVER.

TRAFFIC TRANSITION AREA DOWNSTREAM FROM CROSSOVER

CASE II

Note: See Sheet 1 for General Notes.

12/3/2015 11:38:54 AM

LAST REVISION 07/01/15	REVISION	DESCRIPTION:	 FY 2016-17 DESIGN STANDARDS	CROSSOVER FOR PAVING TRAIN OPERATIONS, RURAL	INDEX NO. 630	SHEET NO. 2 of 2
---------------------------	----------	--------------	---	---	------------------	---------------------



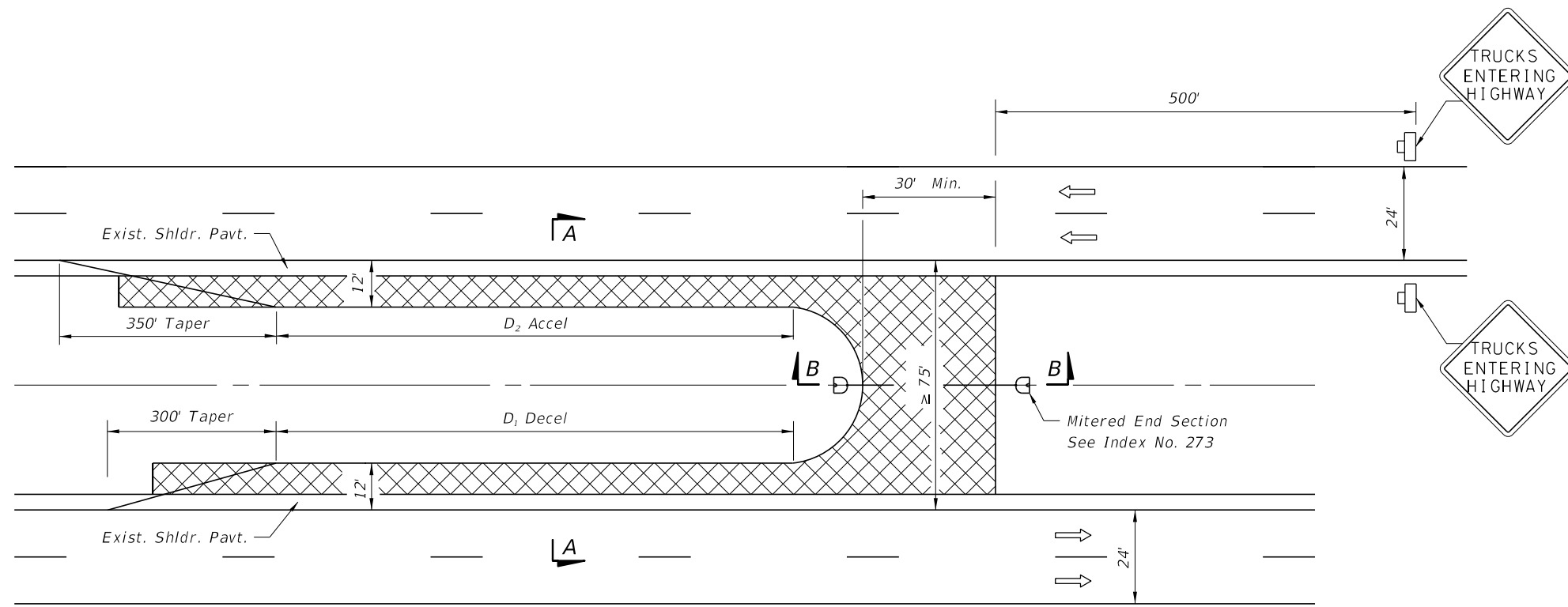

LENGTH OF ACCESS LANES (Ft.)		
Grade	D <sub>1</sub>	D <sub>2</sub>
2% or less	590'	1540'
3 to 4% Upgrade	530'	2310'
3 to 4% Downgrade	710'	925'

PLAN

GENERAL NOTES

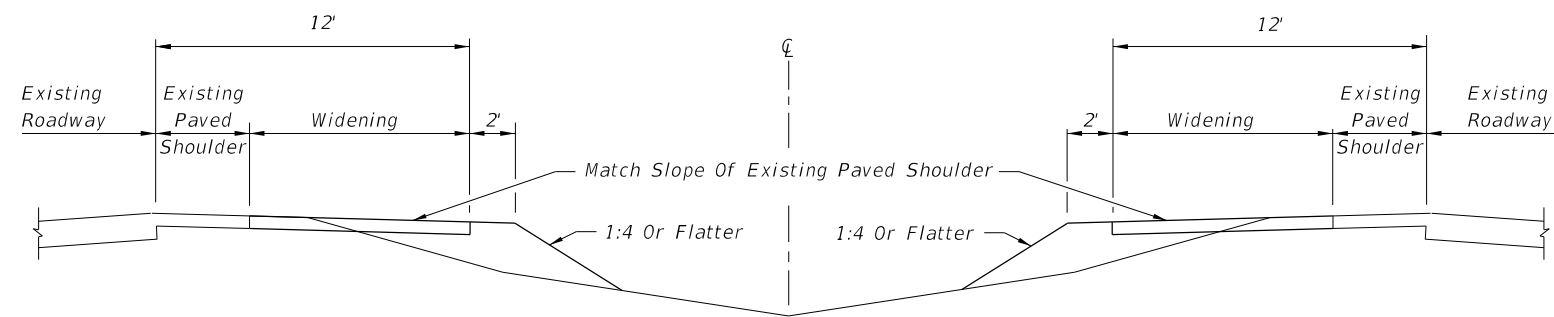

SECTION AA

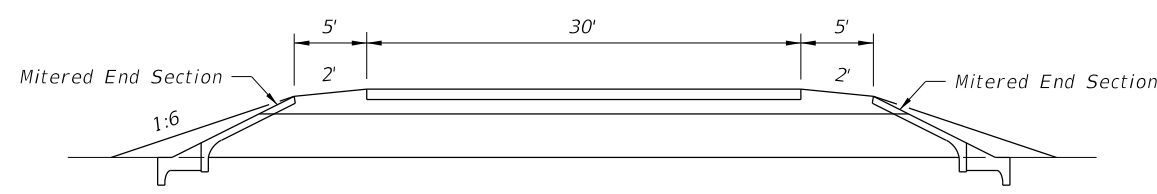

SECTION BB

1. Temporary median crossovers shall be within the project limits and shall not be used for transporting materials to or from any other project. The acceleration-deceleration surfaces shall be paved. RAP material is acceptable for crossing surfacing.
2. Temporary median crossovers shall be located only in areas having adequate sight distance. On limited access facilities temporary median crossovers shall not be located within 1.5 miles of interchanges nor within 2000 ft. of acceleration-deceleration lanes at rest areas, other access openings or other highway service areas.
3. For paving train operations at permanent crossovers, see Index No. 630.
4. All traffic control devices are to be removed when crossover will not be in use for one hour or longer.
5. Trailer mounted advance warning panel may be used in lieu of advance warning vehicle.
6. When a crossover is no longer needed, all temporary construction shall be immediately removed and the area restored to its original condition.
7. Cost of construction, maintenance, removal and restoration work related to temporary crossovers shall be included in the contract unit price for Maintenance of Traffic, LS.
8. Temporary crossovers on limited access right of way and use of this Index are prohibited unless specifically permitted in the Contract Plans or Special Provisions. When permitted in the Contract Plans or Special Provisions and prior to construction of any temporary crossover, the Contractor must submit, in writing, a request identifying specific locations for approval by the Engineer.
9. Pipe and mitered end sections are not required when crossover is located at the high point of a crest vertical curve.

SYMBOLS

- Work Zone Sign
- Lane Identification + Direction of Traffic
- Temporary Pavement

TEMPORARY CROSSOVER FOR MEDIAN WIDTHS ≥ 75'

12/31/2015 11:38:55 AM

LAST REVISION 07/01/13	REVISION	DESCRIPTION:	 FY 2016-17 DESIGN STANDARDS	TEMPORARY CROSSOVER	INDEX NO. 631	SHEET NO. 1 of 2
---------------------------	----------	--------------	------------------------------------	---------------------	------------------	---------------------

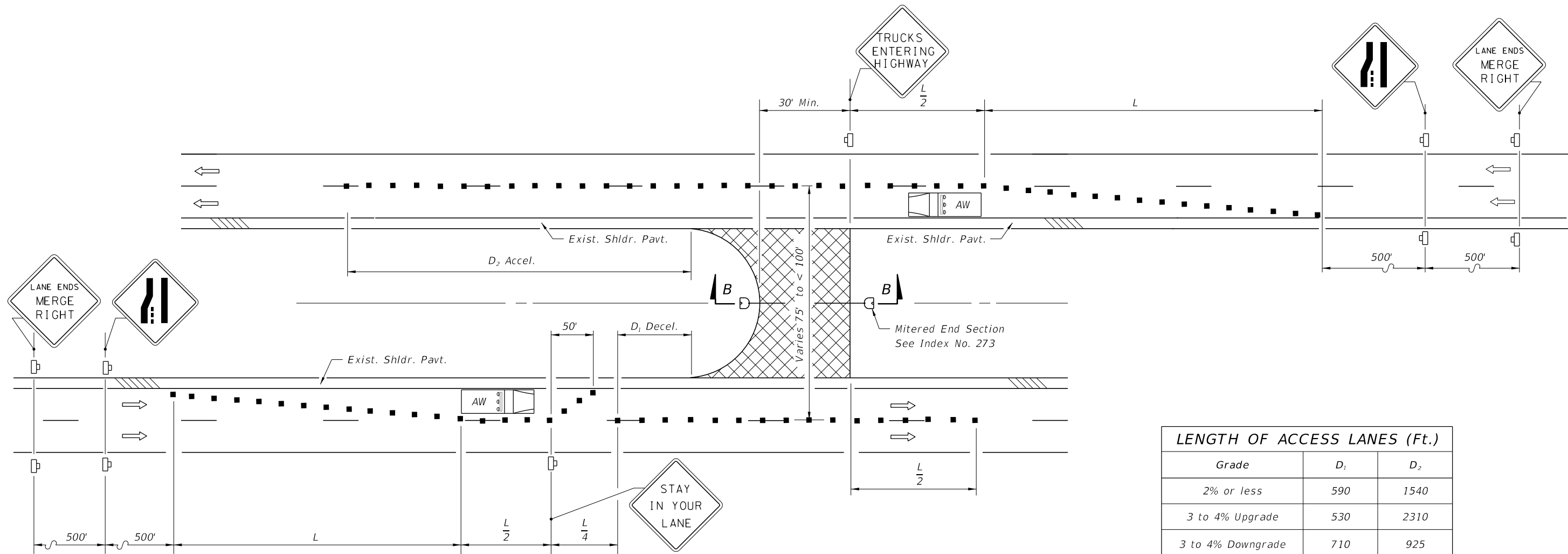

LENGTH OF ACCESS LANES (Ft.)		
Grade	D <sub>1</sub>	D <sub>2</sub>
2% or less	590	1540
3 to 4% Upgrade	530	2310
3 to 4% Downgrade	710	925

NOTE

1. A lane closure analysis will be required to determine the times of day that this crossover can be in operation.

SYMBOLS

- Temporary Pavement
- Work Zone Sign
- Channelizing Device (See Index No. 600)
- Advance Warning Vehicle
- Lane Identification + Direction of Traffic

Maximum Spacing Between Cones And Tubular Markers Shall Be 25'

$L \text{ (Min.)} = WS$

S = Existing Posted Speed (MPH)

TEMPORARY CROSSOVER FOR MEDIAN WIDTHS FROM 50' TO < 75'

12/3/2015 11:38:56 AM

LAST REVISION 07/01/09	REVISION	DESCRIPTION:	 FY 2016-17 DESIGN STANDARDS	TEMPORARY CROSSOVER	INDEX NO. 631	SHEET NO. 2 of 2
---------------------------	----------	--------------	------------------------------------	---------------------	------------------	---------------------

12/31/2015 11:38:58 AM

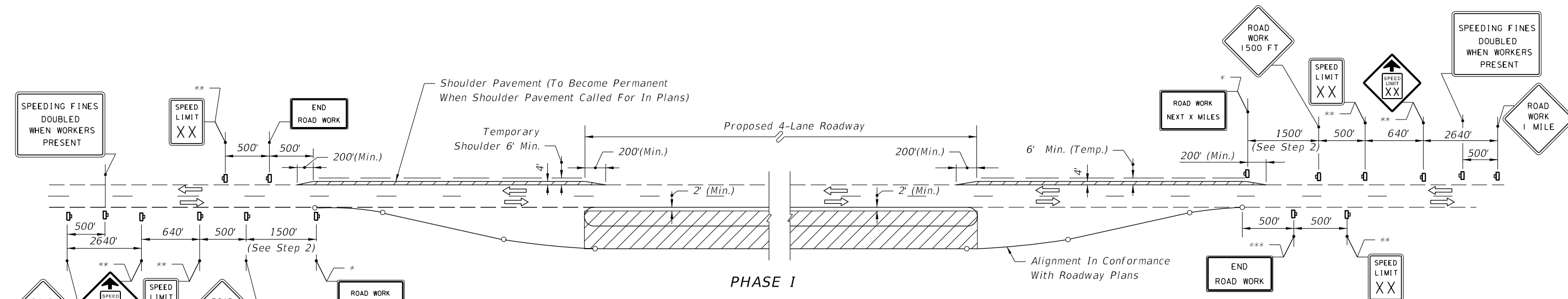

**PHASE I**

1. Maintain two-lane two-way traffic over existing pavement. Construct new roadway within the proposed 4-lane limits, excluding the friction course. Sign as shown if roadway construction area falls within 15' of existing pavement edge. When the construction area falls more than 15' from the existing pavement edge, traffic shall be controlled in accordance with Index No. 601 or 602.
2. Construct shoulder pavement to provide two-lane two-way traffic over shoulder and existing pavement during Phase II roadway construction. For lane width requirements see Index No. 600. Signing as shown, with the near 1500' zone modified in accordance with Index No. 603, to be in place prior to shoulder pavement construction.

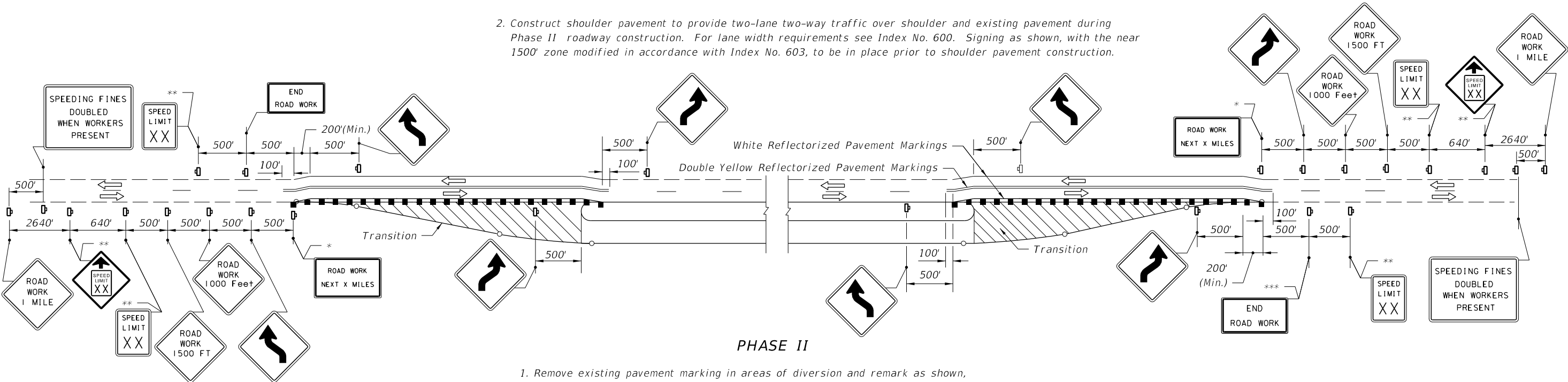

**PHASE II**

1. Remove existing pavement marking in areas of diversion and remark as shown, install warning devices and resign as shown. Traffic to be controlled in accordance with Index No. 607. For lane width requirements see Index No. 600.
2. Route through traffic to temporary and existing pavement.
3. Construct transitions, excluding friction course.

**SYMBOLS**

- Channelizing Device (See Index No. 600)
- Work Zone Sign
- Lane Identification + Direction of Traffic

**LEGEND**

- Phase I Construction
- Phase II Construction
- Phase III Construction

Note: See Sheet 2 for General Notes.

- \* Required For Projects > 2 Miles
- \*\* Required Only When Construction Zone Speed Reduced Below Existing Posted Speed Prior To Construction
- \*\*\* When Other Construction Or Maintenance Operations Occur Within 1 Mile, Sign(s) To Be Omitted And Signing To Be Coordinated In Accordance With Index No. 600.

LAST REVISION 07/01/15	REVISION	DESCRIPTION:		FY 2016-17 DESIGN STANDARDS	CONVERTING TWO LANES TO FOUR LANES DIVIDED, RURAL	INDEX NO. 640	SHEET NO. 1 of 2
---------------------------	----------	--------------	--	--------------------------------	--	------------------	---------------------

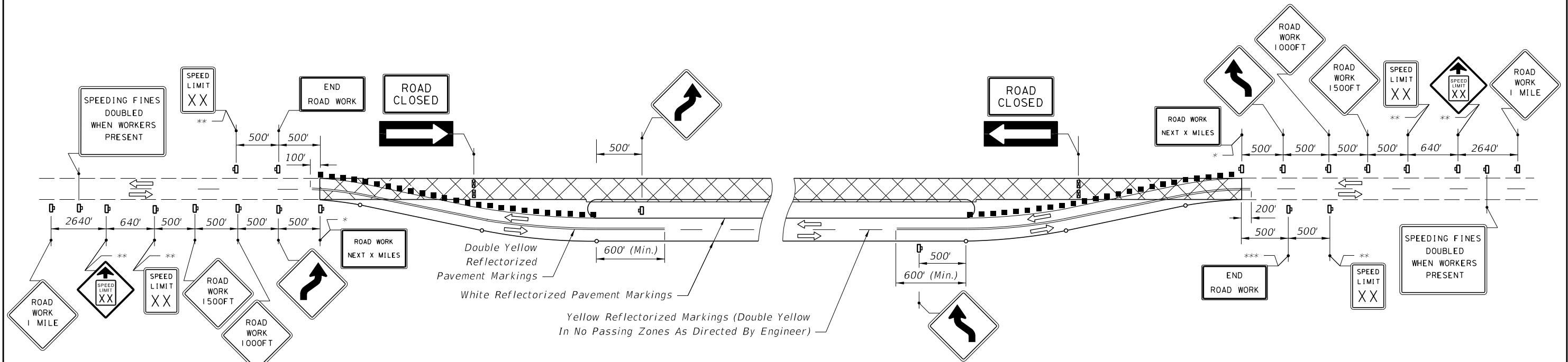

**PHASE III**

1. Remove temporary marking from the existing pavement and temporary shoulder pavement. Mark pavement, install warning devices and resign as shown. Traffic to be controlled in accordance with Index No. 607. For lane width requirements see Index No. 600.
2. Route through traffic to newly constructed roadway.
3. Resurface or reconstruct existing pavement including required shoulder pavement and friction course.

**PHASE IV**

1. Reroute through traffic as shown in Phase II. Signing to be as shown in Phase II.
2. Construct friction course over pavement constructed in Phases I and II.

**GENERAL NOTES**

1. Existing signs and pavement markings that conflict with construction signing and marking shall be obliterated or removed.
2. Lane widths for maintenance of two-way traffic should desirably be equal to lane widths of the existing facility, but lanes shall be not less than 10' in width. When one-lane one-way operations are necessary, a minimum width of 12' shall be maintained and traffic controlled in accordance with Index Nos. 603 and 607. Minimum width for the temporary shoulders is 6'.
3. Within the lateral transitions, the maximum spacing between Type I or Type II barricades or vertical panels or drums shall be based on the speed limit as follows: 15' up to 25 MPH; 30'-40 MPH; 50' for 45 MPH or greater.  
  
The maximum spacing between warning devices used for delineation between the travel way and construction area is 50' for Type I or Type II barricades or vertical panels or drums.
4. Warning devices shall be in conformance with 'Dropoffs In Work Zones', see Index No. 600.
5. For speed sign applications, see 'Regulatory Speed In Work Zones' Index No. 600.
6. For reflectORIZED raised pavement marker applications, see 'Pavement Markers' Index No. 600 and Index No. 17352.
7. Additional barricades, signing, or other traffic controls shall be provided for limited work areas in accordance with other applicable TCZ Indexes.
8. When a side road intersects the highway within the TTC zone, additional TTC devices shall be placed in accordance with other applicable TCZ Indexes.
9. Provisions approved by the Engineer shall be made for the removal of storm water from the roadway(s) during construction.
10. For general TCZ requirements and additional information, refer to Index No. 600.

\* Required For Projects > 2 Miles

\*\* Required Only When Construction Zone Speed Reduced Below Existing Posted Speed Prior To Construction

\*\*\* When Other Construction Or Maintenance Operations Occur Within 1 Mile, Sign(s) To Be Omitted And Signing To Be Coordinated In Accordance With Index No. 600.

**SYMBOLS**

- Channelizing Device (See Index No. 600)
- ▩ Type III Barricade
- Work Zone Sign
- ⇒ Lane Identification + Direction of Traffic

**LEGEND**

- ▨ Phase I Construction
- ▧ Phase II Construction
- ▩ Phase III Construction

12/3/2015 11:38:59 AM

LAST REVISION 07/01/15	REVISION	DESCRIPTION:	 <b>FY 2016-17 DESIGN STANDARDS</b>	<b>CONVERTING TWO LANES TO FOUR LANES DIVIDED, RURAL</b>	INDEX NO. <b>640</b>	SHEET NO. <b>2 of 2</b>
---------------------------	----------	--------------	--	--	-------------------------	----------------------------

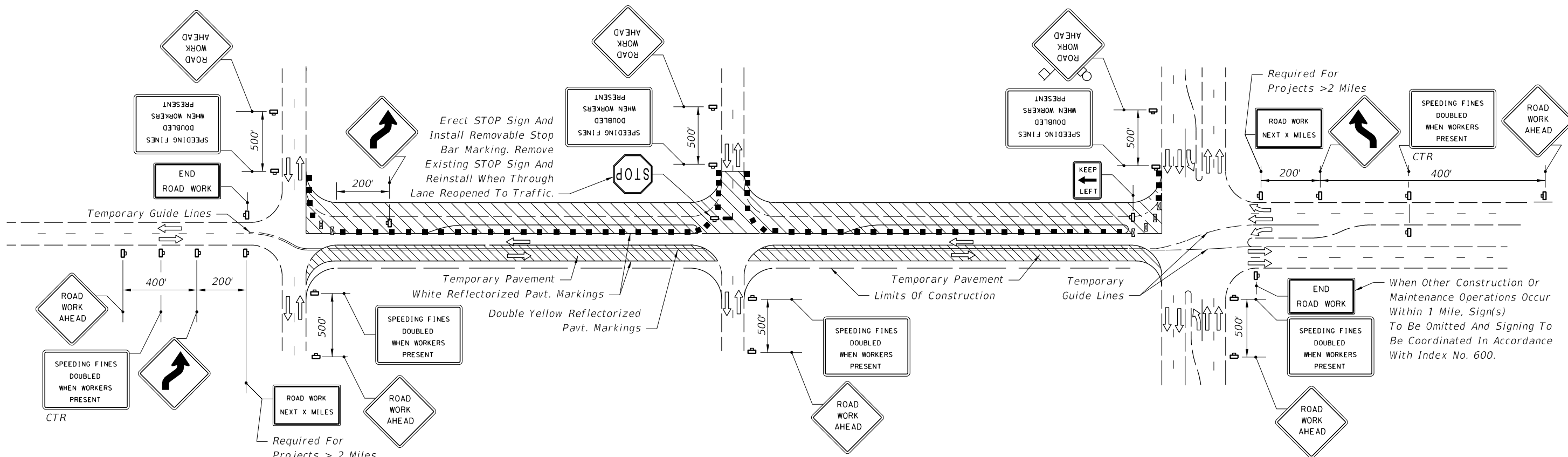

**PHASE I**

1. Maintain two-lane two-way traffic along existing facility. Install construction signing.
2. Remark existing pavement to facilitate temporary pavement construction. For lane width requirements see Index No. 600.
3. Construct temporary pavement of sufficient width to accommodate two-lane two-way traffic on the temporary pavement and a portion of the existing pavement during Phase I roadway construction. When two-lane two-way traffic can not be maintained during temporary pavement construction one-lane operations shall be maintained in accordance with Index No. 605. Channelizing devices shall be in conformance with 'Drop-Offs in Work Zones' of Index No. 600.
4. Mark the pavement in accordance with the Phase I diagram. Reroute through traffic to the temporary pavement and a portion of the existing pavement. For lane width requirements see Index No. 600.
5. Construct two lanes of the proposed roadway, excluding the friction course. Side street traffic to be maintained. Through and cross traffic to be controlled in accordance with Index Nos. 604, 605 and 615. Barricading shall be in conformance with 'Drop-Offs in Work Zones', Index No. 600. When work extends through an intersection, temporarily reroute the cross traffic to other cross streets. When rerouting is not possible, provide one-lane access (minimum) for two-lane two-way cross streets and one-lane access (minimum) each direction for four-lane two-way cross streets, in accordance with Index Nos. 604, 605 and 615.

**SYMBOLS**

- Channelizing Device (See Index No. 600)
- ⊘ Type III Barricade
- Work Zone Sign
- ▬ Stop Bar
- ⇒ Lane Identification + Direction of Traffic

**LEGEND**

- Phase I Construction
- Phase II Construction
- Phase III Construction

See Sheet 3 for General Notes.

12/3/2015 11:39:00 AM

LAST REVISION 07/01/15	REVISION	DESCRIPTION:	 FY 2016-17 DESIGN STANDARDS	CONVERTING TWO LANES TO FOUR LANES DIVIDED, URBAN	INDEX NO. 641	SHEET NO. 1 of 3
---------------------------	----------	--------------	------------------------------------	--	------------------	---------------------

12/3/2015 11:39:00 AM

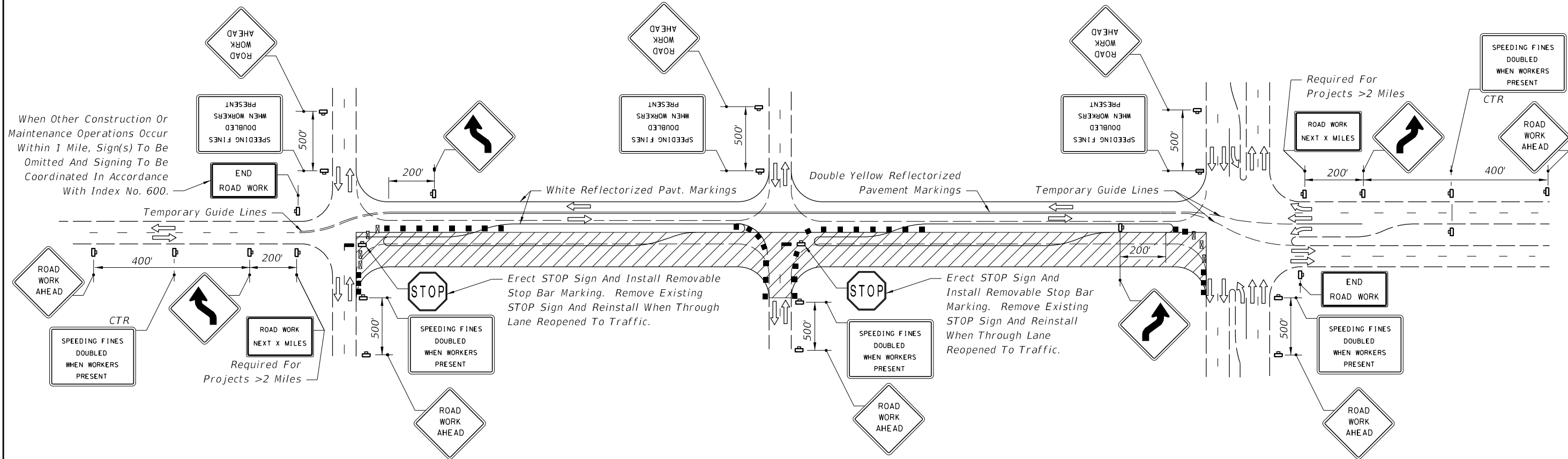

When Other Construction Or Maintenance Operations Occur Within 1 Mile, Sign(s) To Be Omitted And Signing To Be Coordinated In Accordance With Index No. 600.

**PHASE II**

1. Sign and mark Phase I pavement in accordance with the Phase II diagram. For lane width requirements see Index No. 600.
2. Reroute through traffic to Phase I pavement.
3. Complete all Phase II construction, including the friction course. Side street traffic to be maintained. Through and cross traffic to be controlled in accordance with Index Nos. 604, 605 and 615. Channelizing devices shall be in conformance with 'Drop-Offs in Work Zones' of Index No. 600. When work extends through an intersection, temporarily reroute cross traffic to other cross streets. When rerouting is not possible, provide one-lane access (minimum) for two-lane two-way cross streets and one-lane access (minimum) each direction for four-lane two-way cross streets, in accordance with Index Nos. 604, 605 and 615.

**SYMBOLS**

- Channelizing Device (See Index No. 600)
- ⊠ Type III Barricade
- Work Zone Sign
- Stop Bar
- Lane Identification + Direction of Traffic

**LEGEND**

- ▨ Phase I Construction
- ▧ Phase II Construction
- ▩ Phase III Construction

See Sheet 3 for General Notes.

LAST REVISION 07/01/15	REVISION	DESCRIPTION:	 FY 2016-17 DESIGN STANDARDS	CONVERTING TWO LANES TO FOUR LANES DIVIDED, URBAN	INDEX NO. 641	SHEET NO. 2 of 3
---------------------------	----------	--------------	------------------------------------	--	------------------	---------------------

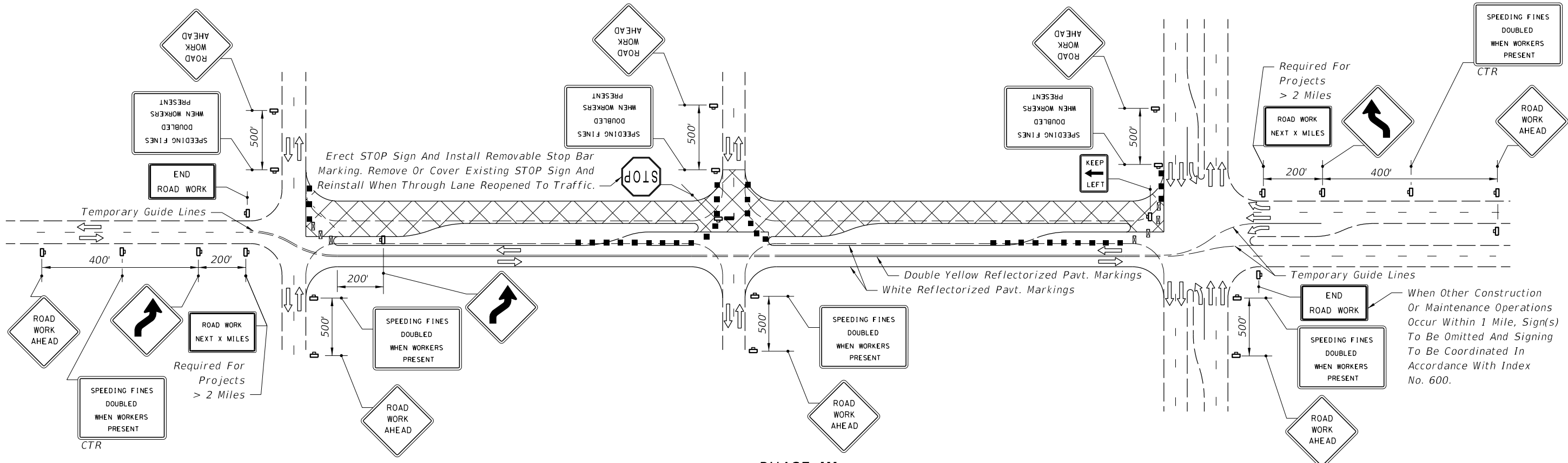

**PHASE III**

1. Sign and mark Phase II pavement in accordance with the Phase III diagram.
2. Reroute through traffic to Phase II pavement.
3. Construct friction course over Phase I pavement. Side street traffic to be maintained. Through and cross traffic to be controlled in accordance with Index Nos. 604, 605 or 615. When work extends through an intersection, temporarily reroute cross traffic to other cross streets. When rerouting is not possible, provide one-lane access (minimum) for two-lane two-way cross streets and one-lane across (minimum) each direction for four-lane two-way cross streets.

**GENERAL NOTES**

1. All signing, pavement marking, and barricades necessary for maintenance of traffic shall conform to Index No. 600.
2. Lane widths for maintenance of two-way traffic should desirably be equal to lane widths of the existing facility, but lanes shall not be less than 10' in width. When one-lane one-way operations are necessary, a minimum width of 12' should be maintained and traffic controlled in accordance with Index Nos. 604, 605 or 615.
3. At signalized intersections, signals shall be directed or relocated as required to the center of relocated lanes.
4. For reflectorized raised pavement marker application, see Index Nos. 600 and 17352.
5. Additional barricades, signing, lighting or other traffic controls for limited work areas shall be provided in accordance with other applicable TCZ Indexes as conditions warrant in each phase.
6. Provisions approved by the Engineer shall be made for the removal of storm water from the roadway(s) during construction.
7. For general TCZ requirements and additional information, refer to Index No. 600.

**SYMBOLS**

- Channelizing Device (See Index No. 600)
- ▣ Type III Barricade
- Ⓜ Work Zone Sign
- ▬ Stop Bar
- ➡ Lane Identification + Direction of Traffic

**LEGEND**

- Phase I Construction
- Phase II Construction
- Phase III Construction

12/3/2015 11:39:01 AM

LAST REVISION <b>07/01/15</b>	REVISION	DESCRIPTION:	 <b>FY 2016-17</b> <b>DESIGN STANDARDS</b>	<b>CONVERTING TWO LANES TO FOUR LANES</b> <b>DIVIDED, URBAN</b>	INDEX NO. <b>641</b>	SHEET NO. <b>3 of 3</b>
----------------------------------	----------	--------------	--	--	-------------------------	----------------------------

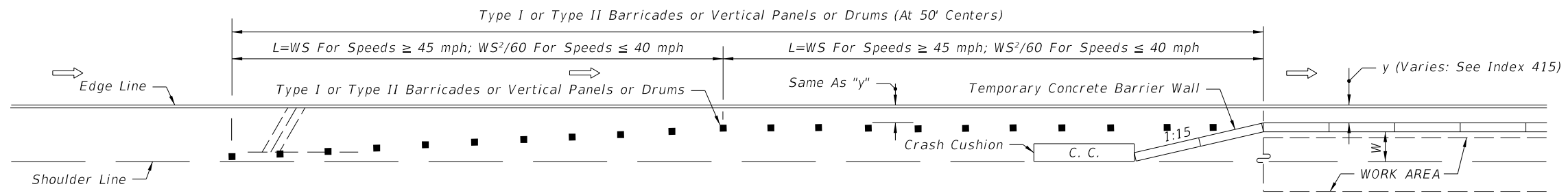

**BARRIER AND TRANSITION LOCATED ON PAVED OR UNPAVED SHOULDERS  
PLAN SHOWN FOR RIGHT LANE - INVERTED PLAN FOR LEFT LANE**

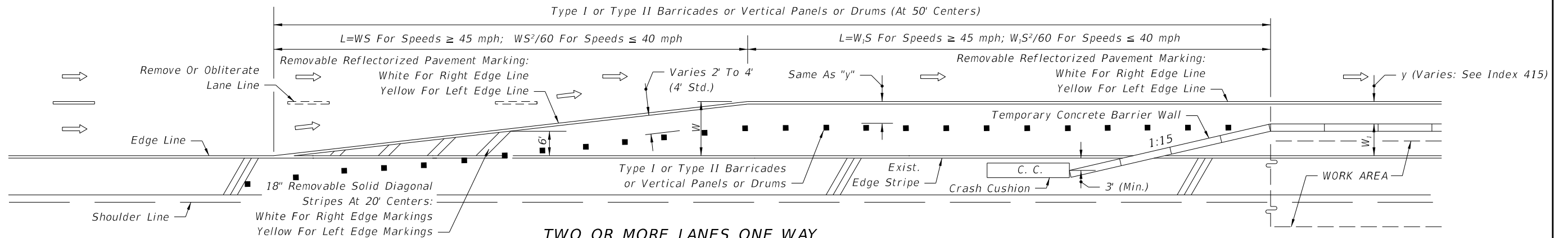

**TWO OR MORE LANES ONE WAY  
LANE DROP • PLAN SHOWN FOR RIGHT LANE MERGE LEFT - INVERTED PLAN FOR LEFT LANE MERGE RIGHT**

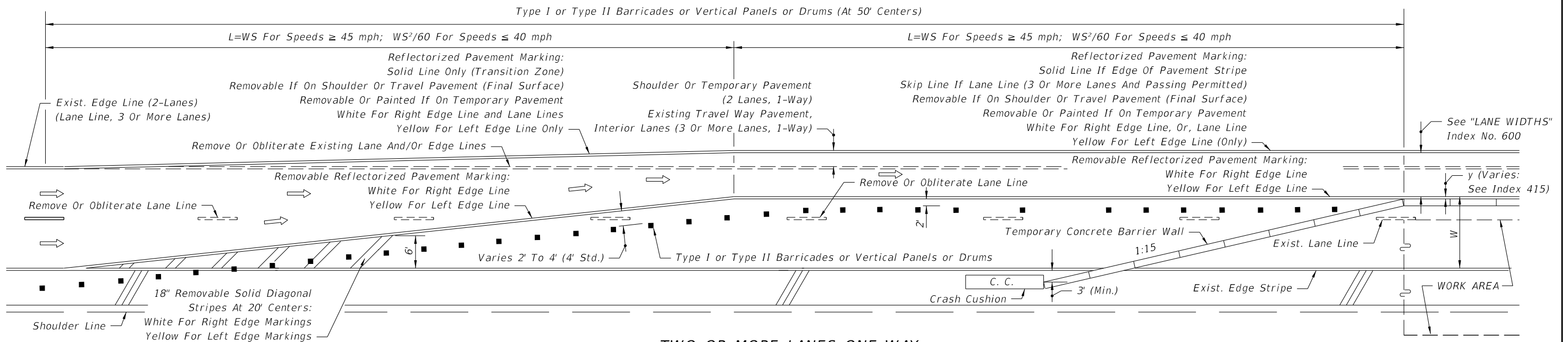

**TWO OR MORE LANES ONE WAY  
LANE DROP AND LANE SHIFTS - PLAN SHOWN FOR RIGHT LANE MERGE LEFT - INVERTED PLAN FOR LEFT LANE MERGE RIGHT**

**SYMBOLS**

- ➡ Lane Identification + Direction of Traffic
- Channelizing Device (See Index No. 600)

**GENERAL NOTES**

1. For signing information see the Plans, Specifications, MUTCD and other TCZ Standards.
2. Where W=width of lateral transition in feet, S=posted speed limit.

12/31/2015 11:39:02 AM

LAST REVISION 07/01/15	REVISION	DESCRIPTION:
---------------------------	----------	--------------



FY 2016-17  
DESIGN STANDARDS

TRANSITIONS FOR TEMPORARY CONCRETE  
BARRIER WALL ON FREEWAY FACILITIES

INDEX NO.  
642

SHEET NO.  
1 of 1



12/31/2015 11:39:03 AM

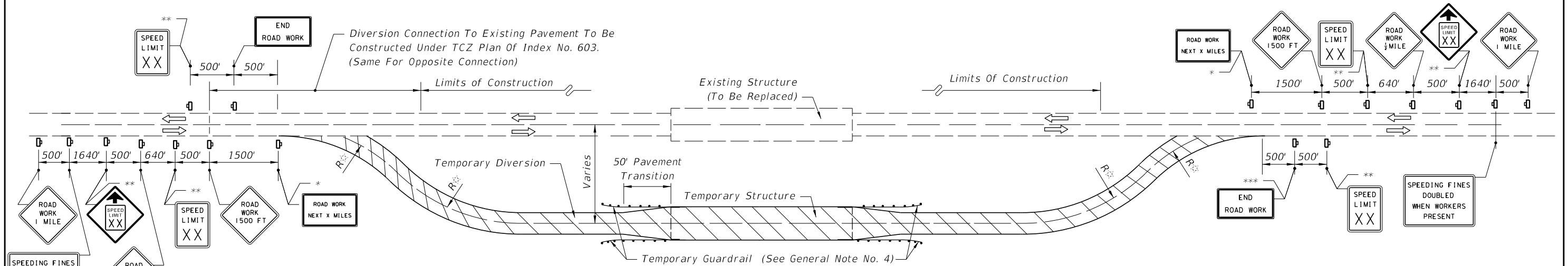

**PHASE I**

1. Maintain two-lane two-way traffic over existing facility.
2. Construct temporary structure, approaches, guardrail and install crash cushions if center truss is constructed.
3. The signing shown in the Phase I diagram is required whenever equipment workers or their activities are within 15' of the existing pavement edge.

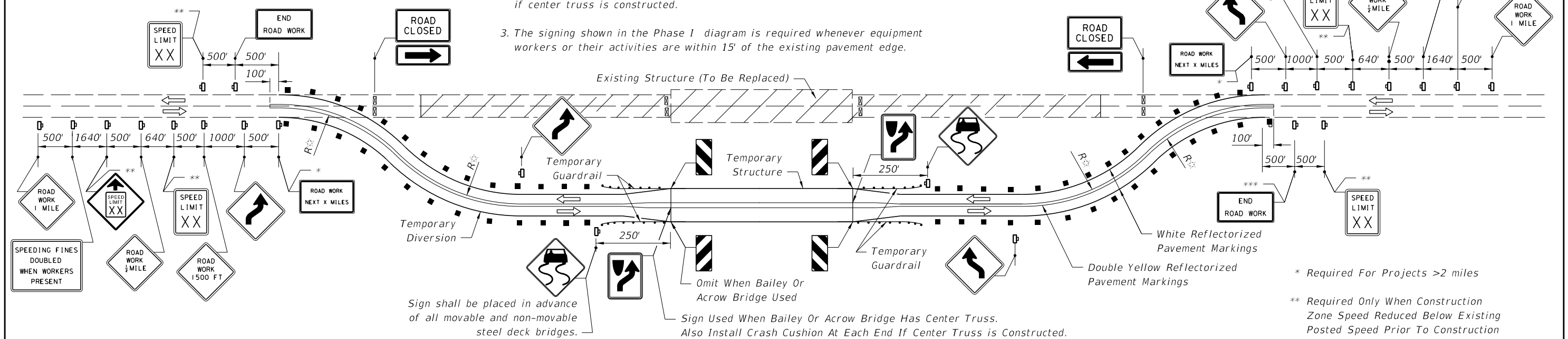

**PHASE II**

1. Resign and mark as shown in Phase II plan.
2. Reroute traffic to diversion and maintain two-way traffic on diversion. Install Type III barricades.
3. Construct proposed structure and reconstruct or resurface existing approaches.

☆ See SUPERELEVATION Index No. 600.

**SYMBOLS**

- Channelizing Device (See Index No. 600)
- ⊠ Type III Barricade
- ⊡ Work Zone Sign
- Lane Identification + Direction of Traffic

**LEGEND**

- Phase I
- Phase II

- \* Required For Projects >2 miles
- \*\* Required Only When Construction Zone Speed Reduced Below Existing Posted Speed Prior To Construction
- \*\*\* When Other Construction Or Maintenance Operations Occur Within 1 Mile, Sign(s) To Be Omitted And Signing To Be Coordinated In Accordance With Index No. 600.

PHASE III and General Notes (See Sheet 2)

LAST REVISION 07/01/15	REVISION	DESCRIPTION:	 FY 2016-17 DESIGN STANDARDS	TWO-LANE TWO-WAY, RURAL STRUCTURE REPLACEMENT	INDEX NO. 650	SHEET NO. 1 of 2
---------------------------	----------	--------------	------------------------------------	--	------------------	---------------------

**PHASE III**

1. Reroute traffic to final alignment and maintain two-way traffic.
2. Remove all temporary construction items.

**GENERAL NOTES**

1. All signing, pavement marking, and barricades necessary for maintenance of traffic shall conform to Index No. 600.
2. For speed sign applications, see Index No. 600.
3. For lane width requirements see Index No. 600. When one-way one-lane operations are necessary, a minimum width of 12' shall be maintained and traffic controlled in accordance with Index Nos. 603, 606 or 607. Minimum width for the diversion shoulders is 6'.
4. Method of attaching temporary guardrail to the diversion structure to be approved by the Engineer. Cost of temporary guardrail systems, including end anchorage assemblies, transitions and attachment to temporary structures, are to be included in the contract unit price for Guardrail (Temporary) LF.
5. Provisions approved by the Engineer shall be made for the removal of storm water from the roadway(s) during construction.
6. Only temporary crash cushions approved by the Department shall be used unless specified devices called for in the plans.
7. Where the temporary structure is not required, the diversion may be constructed in accordance with Index No. 608, unless otherwise stipulated in the plans.
8. For reflective raised pavement marker application, see Index Nos. 600 and 17352.
9. For general TCZ requirements and additional information, refer to Index No. 600.

12/3/2015 11:39:04 AM

LAST REVISION 07/01/15	REVISION DESCRIPTION:	 <b>FY 2016-17 DESIGN STANDARDS</b>	<b>TWO-LANE TWO-WAY, RURAL STRUCTURE REPLACEMENT</b>	INDEX NO. <b>650</b>	SHEET NO. <b>2 of 2</b>
---------------------------	-----------------------	--	--	-------------------------	----------------------------

BUFFER LENGTH (FEET)		
Construction Zone Speed MPH	X (ft.)	Z (ft.)
60-70	540	550
55	350	430
≤ 50	170	300

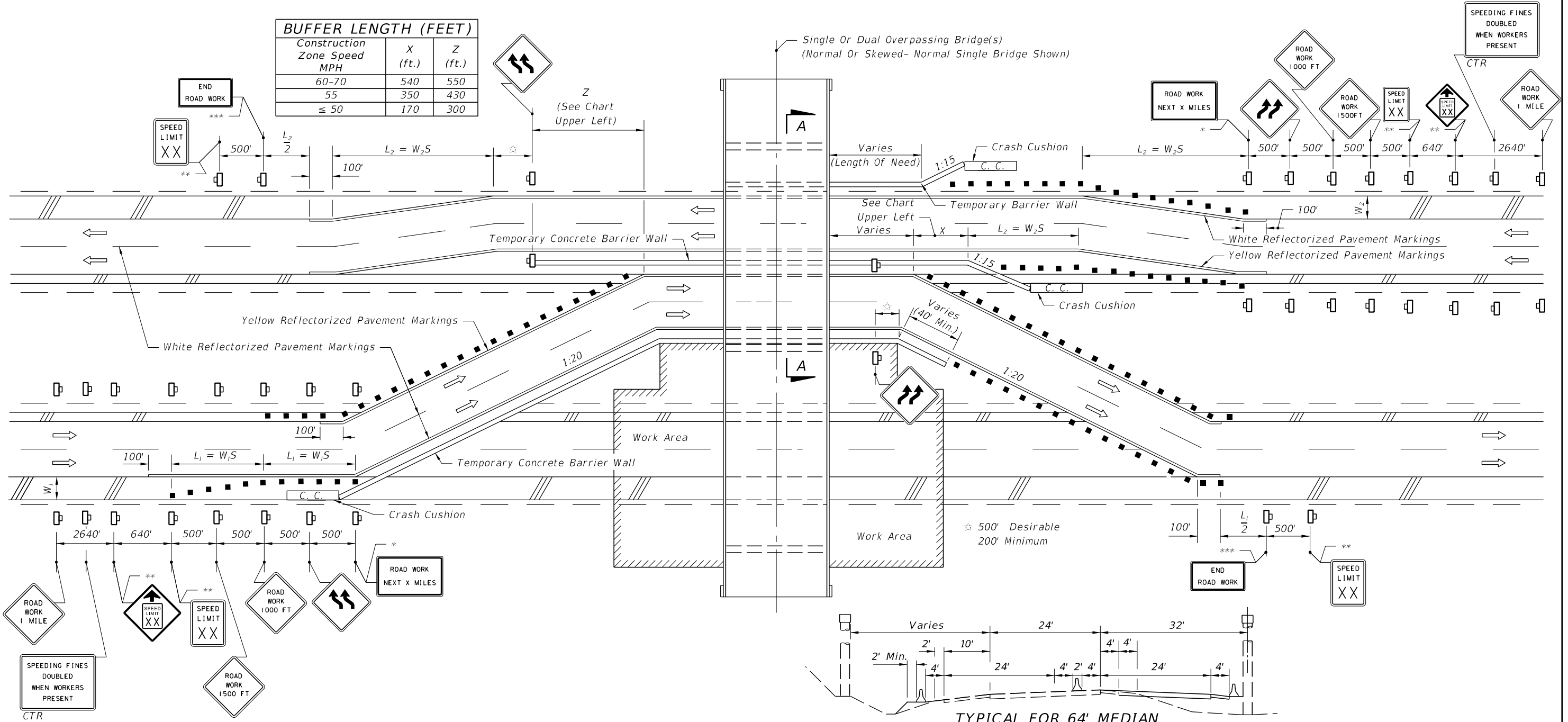

TYPICAL FOR 64' MEDIAN SECTION AA

**SYMBOLS**

- Work Area
- Channelizing Device (See Index No. 600)
- Work Zone Sign
- Lane Identification + Direction of Traffic

**GENERAL NOTES**

1. S=Posted speed limit (mph).
2. Within the lateral transitions, the maximum spacing between Type I or Type II barricades or vertical panels or drums shall be based on the speed limit as follows: 15' up to 25 MPH; 30' for 30-40 MPH; 50' for 45 MPH or greater. Barricades, vertical panels, and drums shall not be intermixed in lateral transitions.
3. For speed sign applications, see 'Regulatory Speed in Work Zones' Index No. 600.
4. All existing pavement markings within the realignment which conflict with the revised traffic pattern are to be removed and new pavement markings used for marking edge lines and lane lines.
5. When side roads, cross roads or interchanges within the TTC zone, additional TTC devices shall be placed in accordance with other applicable TCZ Indexes
6. For general TCZ requirements and additional information, refer to Index No. 600.

**CONDITIONS**

- \* Required For Projects > 2 miles
  - \*\* Required Only When Construction Zone Speed Reduced Below Existing Posted Speed Prior To Construction
  - \*\*\* When Other Construction Or Maintenance Operations Occur Within 1 Mile, Sign(s) To Be Omitted And Signing To Be Coordinated In Accordance With Index No. 600.
- WHERE ANY VEHICLE, EQUIPMENT, WORKERS OR THEIR ACTIVITIES REQUIRE THE CLOSURE OF ONE ROADWAY AND THE OPPOSING ROADWAY IS CONVERTED TO TEMPORARY TWO-WAY TRAVEL BY WAY OF CROSSOVERS.

12/31/2015 11:39:05 AM

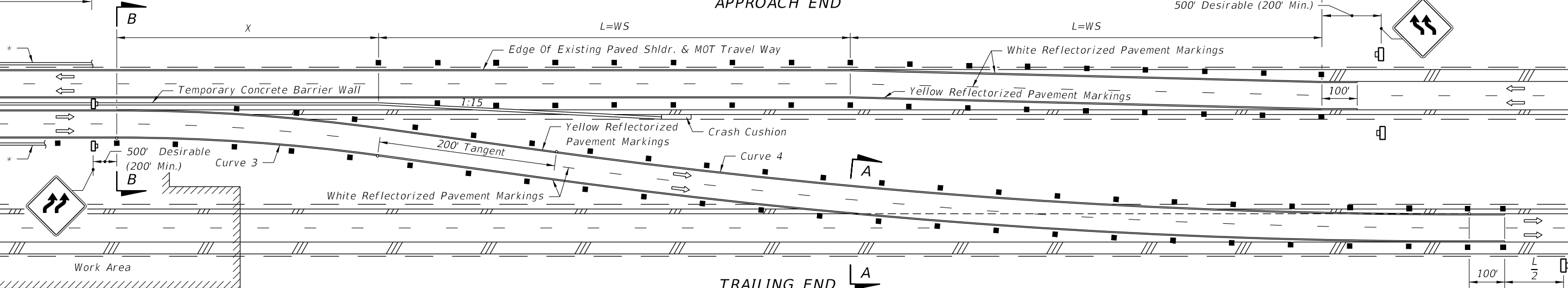
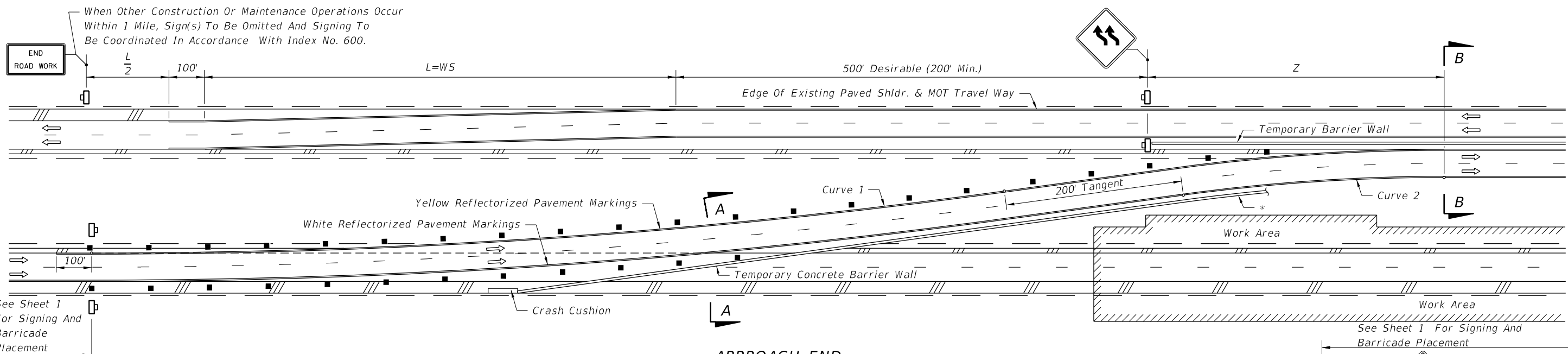

**CURVILINEAR ALIGNMENT CROSSOVER**

\*Length of barrier wall needed for protection of work area and/or other hazards to be shown in the plans. For complimentary information on barrier walls and work area see Sheet 1. See Index No. 600 for clear zone requirements.

When Other Construction Or Maintenance Operations Occur Within 1 Mile, Sign(s) To Be Omitted And Signing To Be Coordinated In Accordance With Index No. 600.

Construction Zone Speed MPH	BUFFER LENGTH (ft)			
	64' Median		88' Median	
	X	Z	X	Z
70	607	588	582	545
65	581	562	552	514
60	562	543	531	492
55	337	369	330	350
50	201	286	200	276
45	115	164	115	163
40	104	149	104	148
35	91	134	91	132
30	78	118	78	115

Construction Zone Speed MPH	MINIMUM RADII FOR NORMAL CROSS SLOPES	
	Minimum Radius (ft)	
	Curves 1 & 4	Curves 2 & 3
70	22,918 (0° 15')	4,584 (1° 15')
65	22,918 (0° 15')	3,820 (1° 30')
60	22,918 (0° 15')	3,274 (1° 45')
55	11,459 (0° 30')	2,546 (2° 15')
50	11,459 (0° 30')	2,292 (2° 30')
45	1,080 (5° 18')	700 (8° 11')
40	830 (6° 54')	550 (10° 25')
35	620 (9° 14')	410 (13° 58')
30	450 (12° 44')	285 (20° 06')

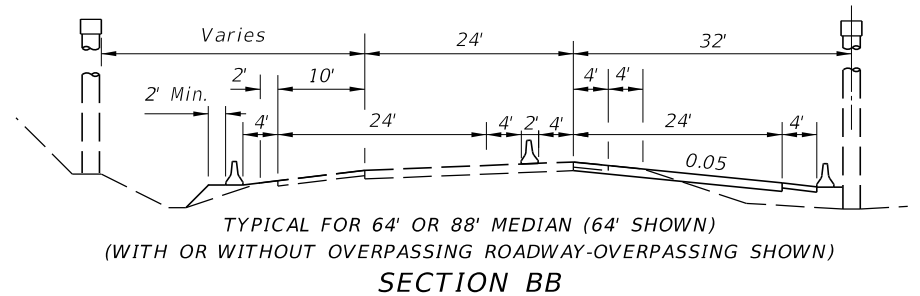
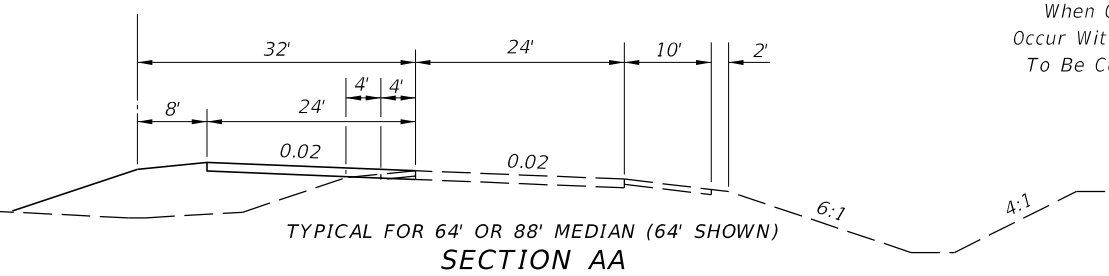

NOTE: Diversions with speeds of 50 mph or greater are considered high speed facilities; curvature and superelevation criteria for open highway conditions apply.

12/3/2015 11:39:06 AM

## TRAFFIC PACING GUIDE

Traffic pacing is a traffic control technique to slow but not stop traffic to facilitate short duration work operations without an elaborate and difficult detour or diversion. Traffic Control Officers pace or slow the traffic to a speed that provides approximately 20-30 minutes to perform the overhead construction. The Department has frequently used this technique for setting bridge beams, overhead sign structures and replacing overhead sign panels.

The traffic pacing begins with approval of the exact date of the activity that shall be made two weeks in advance. The District Public Information Office, the District Traffic Operations Engineer, Local Emergency Management Agencies and Project Personnel shall be notified of the location, date and time. Advance notification to the public shall begin at least one week in advance by using Changeable Message Signs.

The day of the traffic pacing operation, the Changeable Message Sign messages shall be revised to indicate the activity will occur that night or day. The traffic pacing operation begins with a Traffic Control Officer Supervisor at the work site initiating the pacing operation in accordance with pacing details shown on sheet 2. The intent is to keep traffic moving unless there is an emergency.

### CHANGEABLE MESSAGE SIGNS (Typical Placement and Messages)

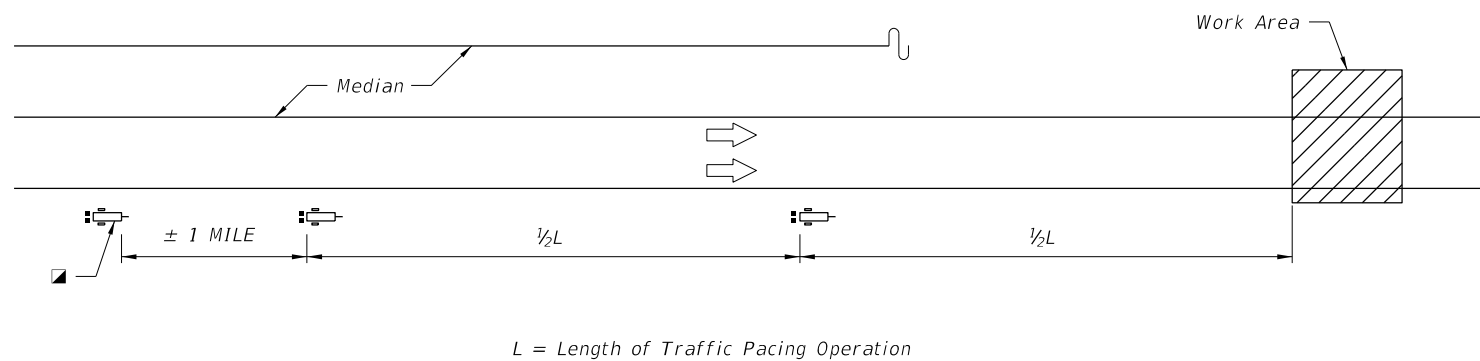

### CHANGEABLE MESSAGE SIGN MESSAGE (MAINLINE AND RAMPS)

#### Symbols

- Channelizing Device (See Index No. 600)
- Marked Police Vehicle with Flashing Blue Lights
- PCMS, Portable Changeable Message Sign
- To be placed the day of pacing operation
- ⇒ Lane Identification and Direction of Traffic

ONE WEEK PRIOR TO  
PACING OPERATION

EXPECT DELAYS ON	MMM DD-DD X AM - X AM
------------------------	-----------------------------

DURING DAY  
OF PACING OPERATION

ROAD WORK TONIGHT	EXPECT PERIODIC DELAYS
-------------------------	------------------------------

DURING PACING  
OPERATION

SLOW TRAFFIC AHEAD	BE PREPARED TO STOP
--------------------------	---------------------------

## NOTICE

This Index applies to Limited Access Facilities.

This Index represents the minimum requirements for traffic pacing operations on the State Highway System.

A site specific traffic control plan shall be developed for each pacing operation.

### TRAFFIC PACING GENERAL NOTES

1. Install ROAD CLOSED (W20-3) signs approximately 1000' prior to the work area. These signs shall remain covered until the pacing operation begins and covered when the pacing operation has ended.
2. Prior to requesting that the traffic control officer supervisor initiate the pacing operation, the contractor shall ensure that the necessary equipment is properly positioned (off the roadway) for the construction activity requiring the traffic pacing operation.
3. Truck mounted attenuator(s) with changeable message sign(s) are required to protect workers and/or equipment positioned in a travel lane(s) at the work area during the pacing operation from an errant vehicle. If no workers and/or equipment are positioned in a travel lane(s) at the work area, truck mounted attenuator(s) are not required.
4. A traffic control officer supervisor shall be stationed at the work area continuously throughout the pacing operation to insure radio communications between the contractor and/or the project administrator, and all the police vehicles involved in the pacing operation.
5. When more than one pacing operation is required in one work period the contractor shall allow sufficient time between pacing operations to permit traffic to return to normal speeds and flow. Additional time may be required between pacing operations to allow traffic to resume normal speeds and flow upstream of the work area as determined by the project administrator or traffic control officer supervisor.

### TRAFFIC CONTROL PLANS OR TECHNICAL SPECIFICATION

1. The specific activities and locations, along with allowable times of day and days of the week, when pacing will be allowed should be clearly detailed in the traffic control plans or technical specification. If there are specific holiday or special event dates that, due to anticipated traffic congestion, pacing operations should not be allowed, these dates should also be spelled out in plans or specifications. When detailing the specific activities and locations of pacing activities, identify the minimum number of traffic control officers needed for each function and location of the pacing operation. If there are certain work activities that need to be completed prior to the contractor starting the work anticipated during the pacing operation, the activities should be clearly detailed in the plans or technical specification.
2. When developing a pacing plan, failsafe "stop points" should be identified for those work operations in which a construction problem could create a condition that could not be immediately cleared. A failsafe stop point is the last safe egress from the highway facility prior to traffic coming upon the work that is being completed during the operation. In the unlikely event that the work is not completed during the time estimated for the pacing, the plans or specification should direct the pacing to not proceed past the failsafe stop point until the highway is cleared. In the event of major construction problem that cannot be immediately cleared, traffic can then be diverted off the facility.
3. The traffic control plans or technical specification should require the contractor to submit a pacing plan in advance of the operation. The pacing plan should outline the contractors expected equipment and personnel, outline the operation, and include a contingency plan should any of the contractor's critical equipment break down. If the project includes a damage recovery clause, the traffic control plan or technical specification should be clear that the damage recovery applies to the pacing operation as well.
4. Changeable message signs shall be displayed one week prior to work using messages described in the traffic pacing plan. The number and location of changeable message signs shall be called out in the traffic control plans.

12/31/2015 11:39:06 AM

LAST REVISION 07/01/09	REVISION	DESCRIPTION:	<b>FY 2016-17 DESIGN STANDARDS</b>	<h2 style="margin: 0;">TRAFFIC PACING</h2>	INDEX NO. <b>655</b>	SHEET NO. <b>1 of 3</b>
------------------------------	----------	--------------	--	--	----------------------------	-------------------------------

**MAINLINE PACING DETAILS  
(1 DIRECTION OF FOUR LANE ROADWAY EXAMPLE)**

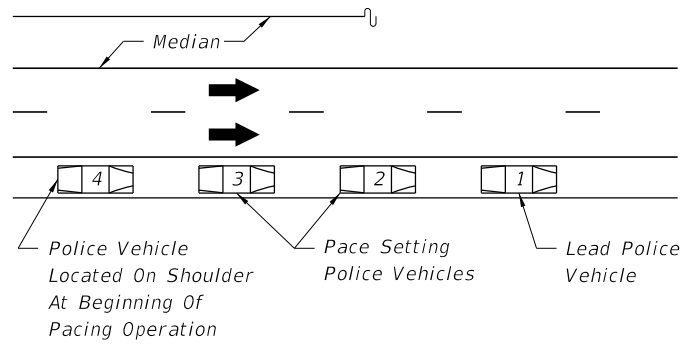

**STAGE ONE**

1. Four police vehicles located upstream of the work area at the beginning location of the traffic pacing operation with flashing blue lights off.

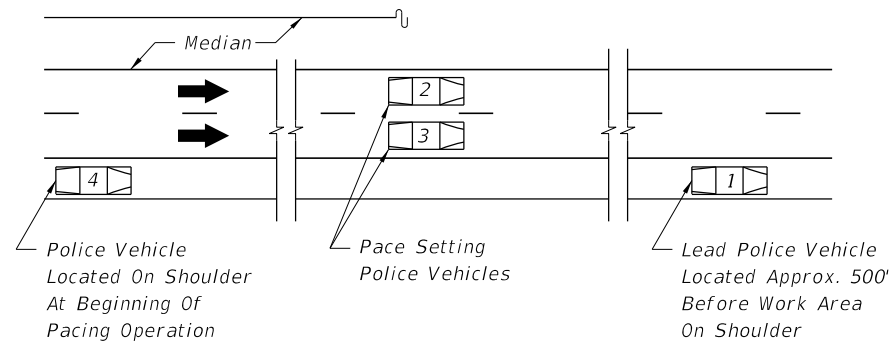

**STAGE THREE**

1. The two pace setting police vehicles shall begin to slow to the pacing speed (20 mph is preferred, 10 mph minimum), for the duration of the traffic pacing operation.
2. The lead police vehicle (flashing blue lights off) shall match the speed of the last vehicles ahead of the pacing vehicles and continue following traffic until a point approximately 500' in advance of the work area. The lead police vehicle shall then come to a complete stop on the right shoulder and turn on its flashing blue lights. If required, crash truck(s) with rear mounted impact attenuator(s) and changeable message sign(s) shall move into the travel lanes approximately 200 ft. upstream of the work area with the impact attenuators down and operating once traffic has cleared the work area.

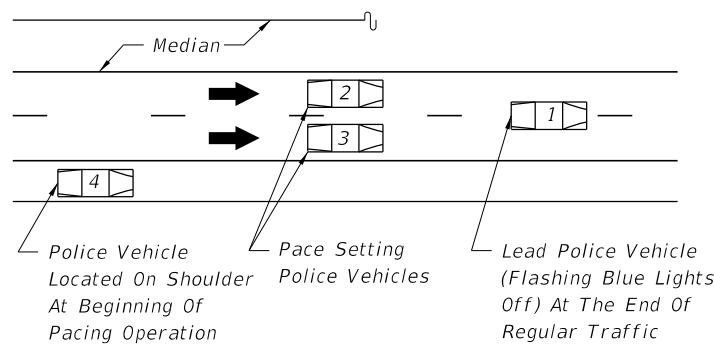

**STAGE TWO**

1. Once the police vehicles are in place and the traffic control officer supervisor at the work area notifies all officers to begin the traffic pacing operation, the last three police vehicles shall turn on their flashing blue lights. The first three police vehicles shall enter the travel lanes with the second and third police vehicles immediately forming a side by side "pacing operation" of all lanes behind the lead police vehicle (flashing blue lights off).

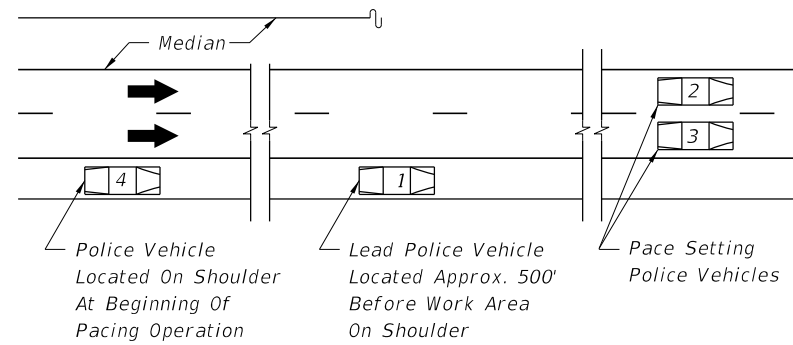

**STAGE FOUR**

1. When the pace setting police vehicles are within approximately two miles of the work area they shall notify the onsite traffic control officer supervisor who will immediately inform the contractors on site supervisor of their location. Once the contractors on site supervisor has been notified of the pacing vehicles location, the contractor shall begin to clear the travel lanes of all equipment and debris in order to reopen all travel lanes.
2. In case of emergency the pace setting police vehicles shall come to a complete stop once they reach the lead police vehicle. If no emergency is encountered, the crash truck(s) shall be moved from the travel lanes and the two pace setting police vehicles shall clear the work area and immediately move to the right shoulder or an area designated by the traffic control officer supervisor and turn off the flashing blue lights. Once the two pace setting police vehicles pass the work area, the traffic control officer supervisor shall instruct the lead and last police vehicles to turn off their flashing blue lights.

**RAMP PACING DETAILS**

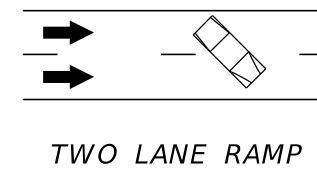
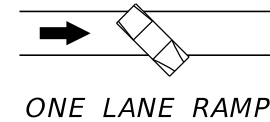

**RAMP CLOSURE DETAIL**

1. Once notified by the on site traffic control officer supervisor to begin the traffic pacing operation each police vehicle at the indicated ramp shall turn their flashing blue lights on and position the vehicle across the ramp lane(s) to close ramp access.
2. Once the pacing operation passes the closed on ramp the police vehicle on the ramp shall turn off the flashing blue lights and move from the ramp lane(s) to allow traffic to enter the mainline pacing operation.

**GENERAL NOTES**

1. Each Traffic Control Officer shall have a marked vehicle with flashing blue lights, for the pacing operation. The location and number of officers at each location will be as follows:

No. Of Traffic Control Officers With Vehicles	Function	Location
1 min.	Supervisor	Work Area
1 Lead Vehicle	Varies	Mobile operation
1 for each travel lane	Pacing Operation	Mobile operation beginning x miles upstream and terminating at the work area
1 Stationed at the Beginning of Pacing Operation	Advanced Warning to Motorist	Stationed at the Beginning of Pacing Operation
1 for each entrance ramp	Entrance Ramp Roadblocks	One at each of the entrance ramps upstream of the work area

12/3/2015 11:39:08 AM

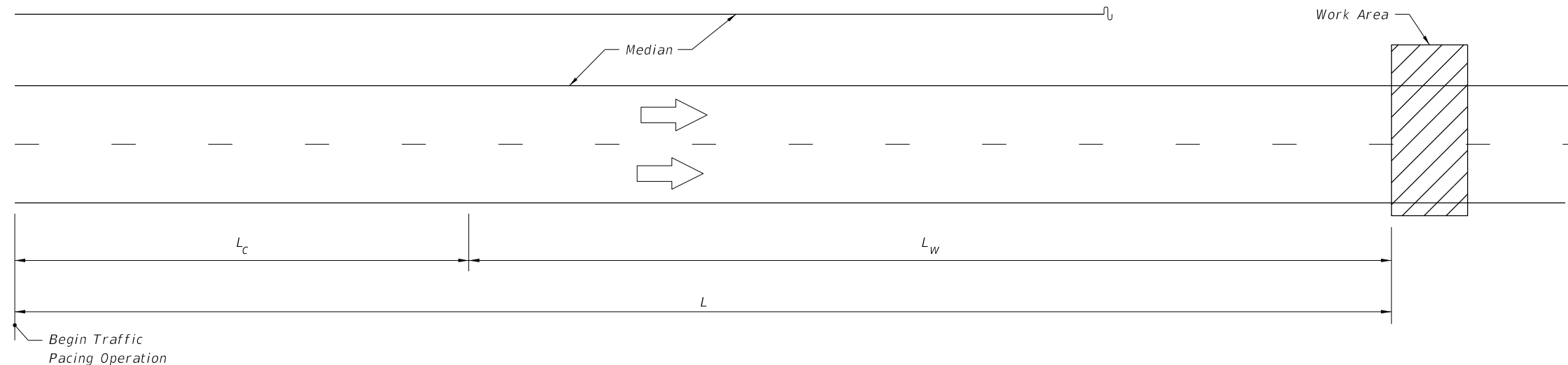

**DESIGN CONSIDERATIONS:**

The design shall evaluate the actual distance required for the pacing operation based on site specific features such as: roadway geometrics, pacing speeds, regulatory speeds, interchange spacing, work duration, availability of traffic control officers, traffic volumes and maximum queue length.

The starting point of a traffic pacing operation must consider the following factors: the speed of the pacing vehicles, the location of entrance ramps, horizontal and vertical alignment of the facility.

In some instances, it may be necessary to close a lane at the work site to position a crane(s) and the materials to be lifted.

All material to be installed shall be on-site before the traffic pacing operation begins.

It may be necessary to install temporary barrier walls to protect pre-positioned and assembled materials in the right of way.

The minimum speed allowed for a pacing operation is 10 mph with 20 mph the preferred speed.

The maximum allowed work duration is 1/2 hour (30 min).

The maximum practical pacing operation length is 10 miles.

$S_r$  = Regulatory speed (mph)

$S_p$  = Pacing speed (mph)

$t_w$  = Work duration (min)

$L$  = Total pacing distance in miles

$$L = \frac{t_w}{60} S_p \left( \frac{S_p}{S_r - S_p} + 1 \right)$$

$$L = L_c + L_w$$

$L_c$  = distance paced vehicles must travel before the vehicles at regulatory speed have cleared the work zone

$$L_c = \left( \frac{t_w}{60} \times \frac{S_p^2}{S_r - S_p} \right)$$

$L_w$  = distance paced vehicles travel while work is performed

$$L_w = \left( \frac{t_w}{60} \times S_p \right)$$

$F_{HV}$  = Heavy Vehicle Factor

$$F_{HV} = 1 + \left( \frac{P_t}{100} \times 0.5 \right)$$

$P_t$  = % Trucks

TRAFFIC PACING DISTANCES (L) miles						
$S_p=20; pcphpl \leq 1,750$						
$S_r$	$t_w$ (min)					
	5	10	15	20	25	30
70	2.3	4.7	7.0	9.3	*	*
65	2.4	4.8	7.2	9.6	*	*
60	2.5	5.0	7.5	10.0	*	*
55	2.6	5.2	7.9	*	*	*
50	2.8	5.6	8.3	*	*	*

\* Site Specific design required.

**NOTES FOR TABLE:**

$t_w$  is the total time allowed for work activity in minutes. This time starts just after the last vehicle traveling at the pre-pacing regulatory speed clears the work area and ends just as the pacing operation reaches the work area.  $t_w$  must include the time required to clear the roadway of equipment, materials, and personnel.

Demand volume may not exceed 1,750 pcphpl (passenger cars per hour per lane) without a site specific design. Traffic counts can be obtained from the Office of Planning, or you may need to collect traffic counts. Hourly directional traffic volumes must be converted to pcphpl using the following:

$$pcphpl = \left( \frac{\text{Hourly Directional Volume}}{\# \text{ Lanes (each direction)}} \right) \times \text{Heavy Vehicle Factor}$$

For additional guidance for site specific designs refer to the Plans Preparation Manual, Volume 1 Chapter 10.

12/3/2015 11:39:09 AM

LAST REVISION 07/01/09	REVISION	DESCRIPTION:
---------------------------	----------	--------------

**SYMBOLS**

-  Work Area
-  Channelizing Device (See Index 600)
-  Work Zone Sign
-  Required Locations For Either Temporary Or Permanent Curb Ramps.
-  Lane Identification + Direction of Traffic
-  Pedestrian Longitudinal Channelizing Device (LCD) with Mounted Work Zone Sign
-  Pedestrian Longitudinal Channelizing Device (LCD)

**GENERAL NOTES**

1. Route pedestrian traffic around work areas when construction activities encroach on the sidewalk for more than 60 minutes using the devices and remedies shown on this Index. Use project specific designs for scenarios not included on this Index.
2. For spacing of traffic control devices and general TCZ requirements refer to Index 600. The maximum spacing between barricades, vertical panels, drums or tubular markers is 25'.
3. Use delineators on longitudinal channelizing devices separating the work area from vehicular traffic.
4. Cover or deactivate pedestrian traffic signal display(s) controlling closed crosswalks.
5. Post mounted signs located near or adjacent to a sidewalk must have a 7' minimum clearance from the bottom of sign to the surface of the sidewalk.
6. When construction activities involve sidewalks on both sides of the street, stage the construction so that one sidewalk is in service at all times. If this is not feasible and both sidewalks must be closed, as determined by the Engineer, provide a detour to guide pedestrians around the construction zone.
7. Provide a 5' wide temporary walkway, except where space restrictions warrant a minimum width of 4'. Provide a 5' x 5' passing space for temporary walkways less than 5' in width at intervals not to exceed 200'.
8. Provide a cross-slope with a maximum value of 0.02 for all temporary walkways.
9. Temporary walkway surfaces and ramps must be stable, firm, slip resistant, and kept free of any obstructions and hazards such as holes, debris, mud, construction equipment and stored materials.
10. Remove temporary walkways immediately after reopening of the sidewalk, unless otherwise noted in the plans.
11. Meet the requirements of Index 304 for temporary curb ramps.
12. Place pedestrian longitudinal channelizing device(s) across the full width of the closed sidewalk. For temporary walkways, similar to the Sidewalk Diversion, place LCD's to delineate both sides of the temporary walkway.

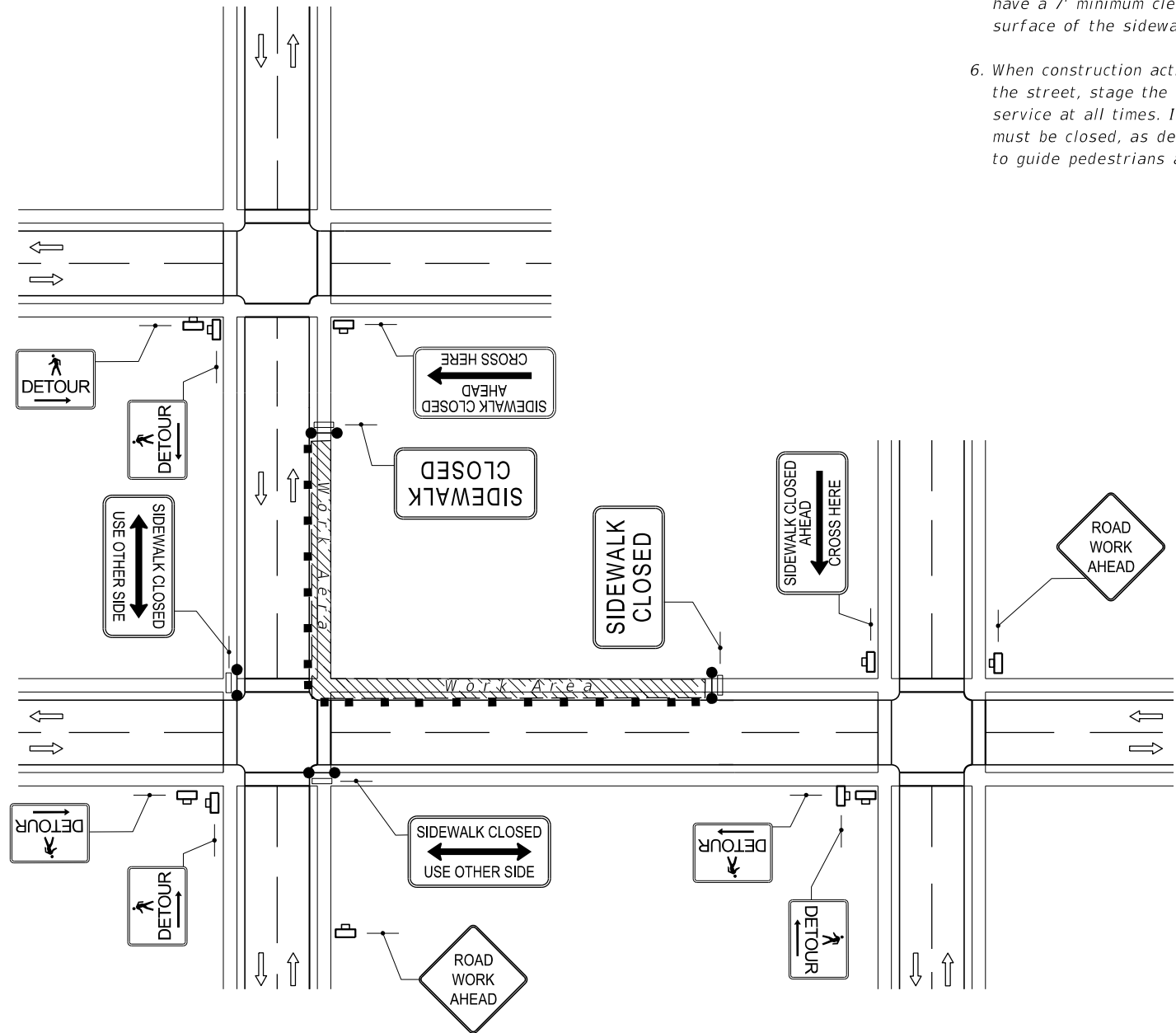

**CROSSWALK CLOSURE AND PESESTRIAN DETOUR**

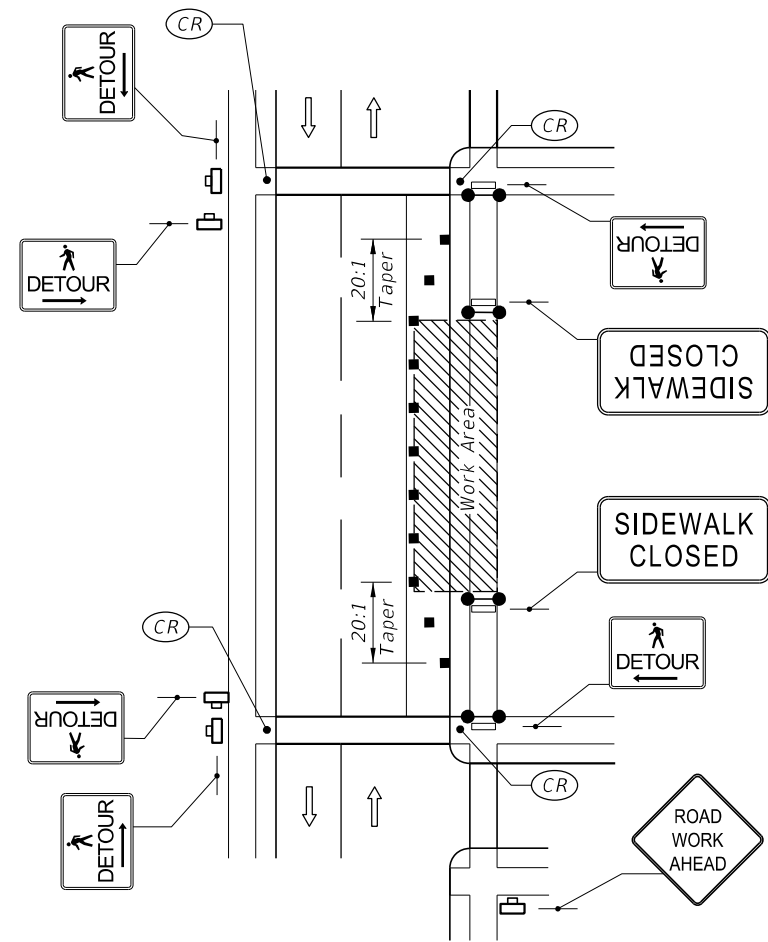

**SIDEWALK DETOUR**

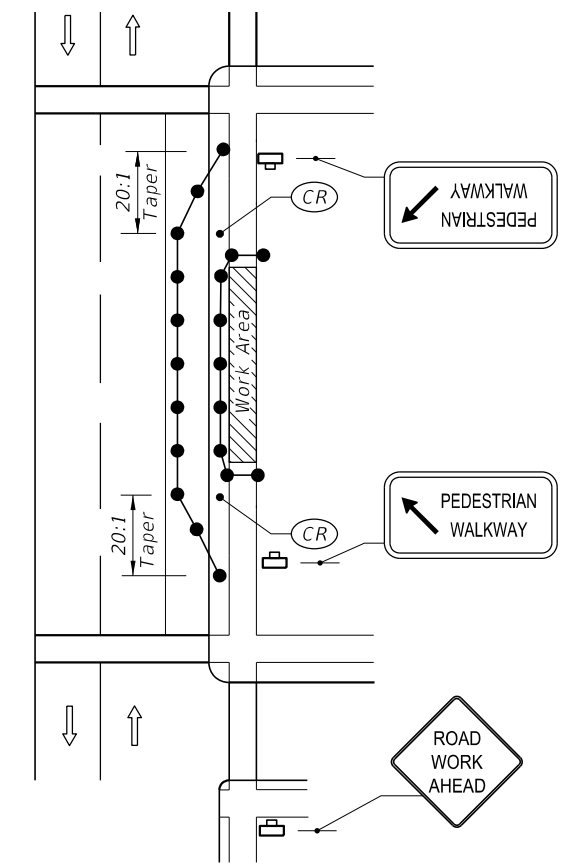

**SIDEWALK DIVERSION**

12/3/2015 11:39:10 AM

LAST REVISION 07/01/15	REVISION	DESCRIPTION:	 <b>FY 2016-17 DESIGN STANDARDS</b>	<b>PEDESTRIAN CONTROL FOR CLOSURE OF SIDEWALKS</b>	INDEX NO. <b>660</b>	SHEET NO. <b>1 of 1</b>
---------------------------	----------	--------------	--	--	-------------------------	----------------------------



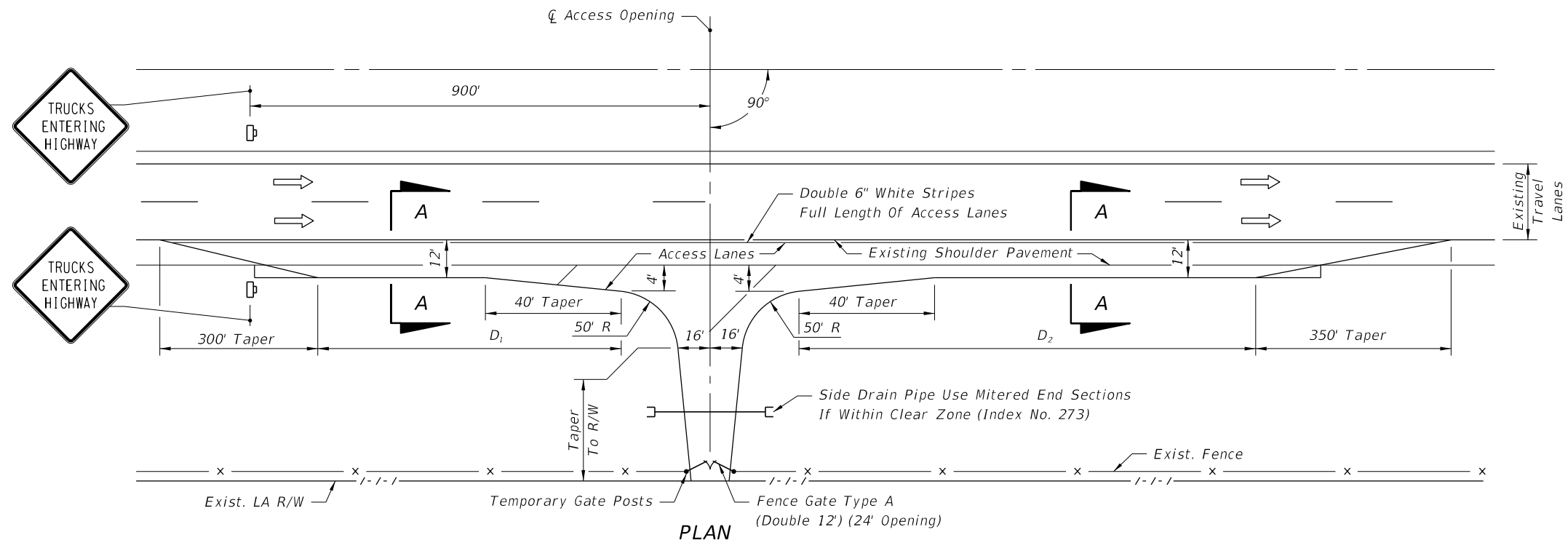

PLAN

GENERAL NOTES

LENGTH OF ACCESS LANES (Ft.)		
Grade	D <sub>1</sub>	D <sub>2</sub>
2% or less	590	1540
3 to 4% Upgrade	530	2310
3 to 4% Downgrade	710	925

- Access openings across limited access right of way and use of this Index are prohibited unless specifically permitted in the Contract Plans or Special Provisions. When permitted in the Contract Plans or Special Provisions and prior to construction of any opening, the Contractor must submit, in writing, a request identifying specific locations for approval by the Engineer.
- No more than two (2) access openings will be allowed on each project.
- Access openings shall be located only in areas having adequate sight distance and shall not be located within 1.5 miles of interchanges nor within 2000 ft. of acceleration-deceleration lanes at rest areas, other access openings or other highway service areas.
- Access openings shall not be constructed directly opposite temporary median crossovers nor within 2000 ft. of temporary median crossovers.
- Access openings shall be within the project limits and shall not be used for transporting materials to or from any other project. The acceleration-deceleration surfaces shall be paved. RAP material is acceptable for driveway surfacing.
- Any Motorist Aid Call Boxes affected by the temporary access openings shall be relocated outside the limits of access lanes and remain in use during construction. Upon removal of access lanes, call boxes shall be returned to their previous location. Temporary relocation and restoration of call boxes shall be at the contractor's expense.
- Access openings in the limited access fence shall have gates which are to be locked during nonwork hours or periods when the access is not in active use.
- The contractor shall take all precautions necessary to insure against entrance by livestock or unauthorized persons or vehicles.
- The contractor shall not vary from the plan detail without approval of the Engineer.
- Gates shall be removed and access opening locations shall be restored to preconstruction condition immediately upon completion of activities utilizing the materials being transported through the openings whether or not the project is completed.
- Failure to comply with any provision of the access opening plan shall be cause for terminating use of all openings. Upon notification by the Engineer, the contractor shall cease hauling and begin restoration of affected areas. Under this condition expense of removal, restoration and of additional hauling distances shall be borne by the contractor.
- No guardrail or barrier wall will be removed for access openings.
- Construction and removal of the access and restoring the area to preconstruction condition shall be included in the cost of Maintenance Of Traffic, LS.

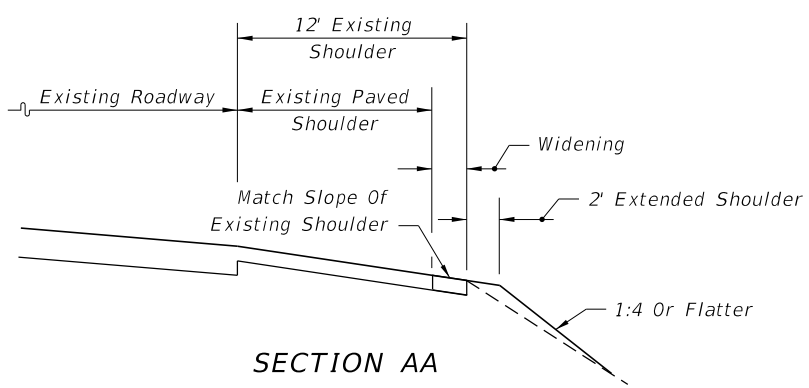

SECTION AA

SYMBOLS

Work Zone Sign

12/3/2015 11:39:11 AM

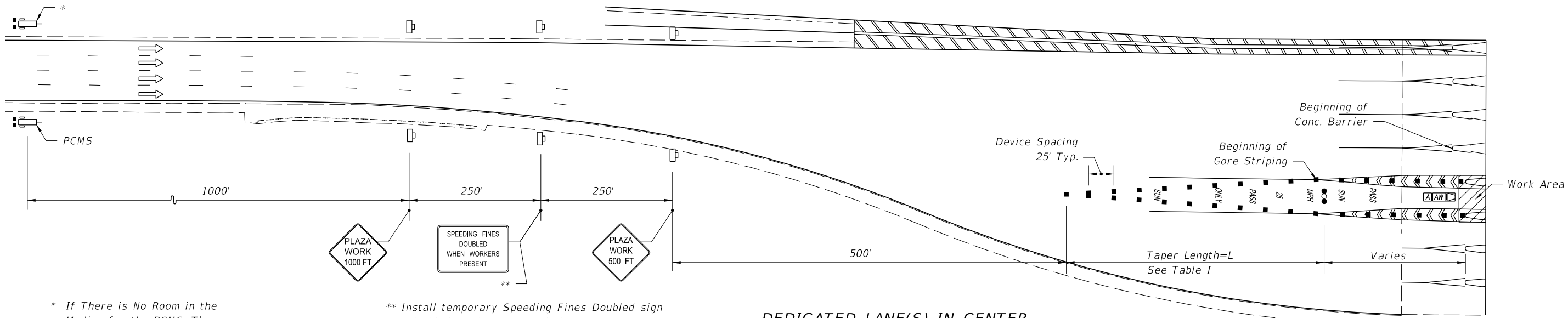

**DEDICATED LANE(S) IN CENTER**

\* If There is No Room in the Median for the PCMS, Then Locate it on the Outside of the Roadway only.

\*\* Install temporary Speeding Fines Doubled sign only if there is not an existing permanent "Speeding Fines Doubled Through Toll Plaza" sign or an existing "Speeding Fines Doubled When Workers Present" sign in place.

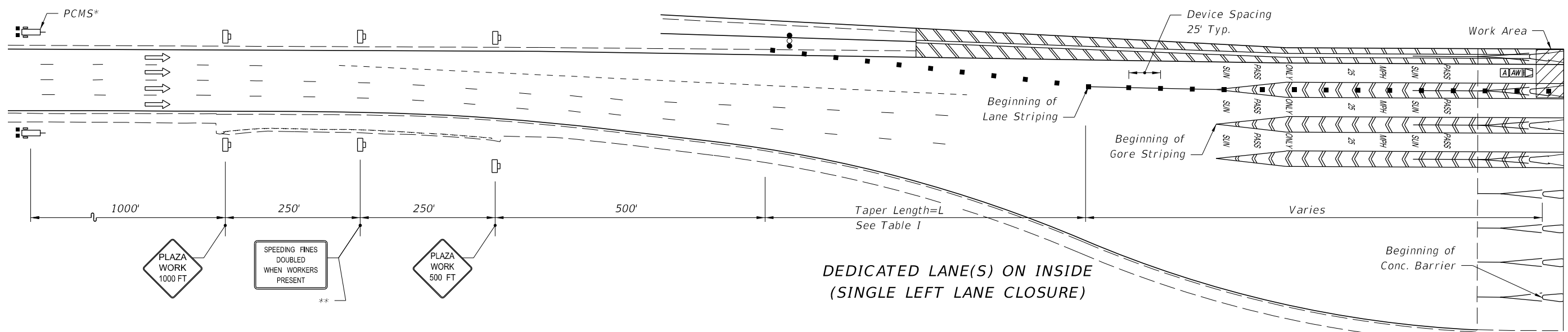

**DEDICATED LANE(S) ON INSIDE (SINGLE LEFT LANE CLOSURE)**

**SYMBOLS**

- Work Area
- Channelizing Device (See Index No. 600)
- Work Zone Sign
- Advance Warning Arrow Board
- Lane Identification + Direction of Traffic
- Advance Warning Vehicle Equipped with Advance Warning Arrow Board and Truck/Trailer Mounted Attenuator
- Portable Changeable (Variable) Message Sign

- PCMS DISPLAY A**
- MESSAGE 1: SUNPASS LANE(S) CLOSED      MESSAGE 2: USE CASH LANES
- PCMS DISPLAY B**
- MESSAGE 1: SUNPASS ONLY LANE(S)      MESSAGE 2: CLOSED AT PLAZA
- PCMS DISPLAY C**
- MESSAGE 1: SUNPASS ONLY LANE(S)      MESSAGE 2: KEEP LEFT/RIGHT

Dedicated Lane Location	Number of Dedicated Lanes	Number of Dedicated Lanes Closed	Taper Length (Feet)	PCMS Display
Center	1	1	200	A
	2	1	200	B
		2	350	A
Inside***	3	1	350	B
		2	350	B
	3	350	A	

\*\*\* See Index 667 Sheet 2 for Right or Center Inside Dedicated Lane Closed, or Two or More Inside Dedicated Lanes Closed Configurations.

**GENERAL NOTES**

1. This Plan is to be used at Mainline Plazas Only.
2. This Plan is for Lane Closures that exceed three hours.
3. Plaza canopies which have existing DMS signs on the canopies shall display the message "LANE CLOSED" for the duration of this closure.
4. A truck/trailer mounted attenuator is required.
5. Lane use control lights, signs, or signals over toll lanes shall be switched to the appropriate symbol, message, or correct color prior to the start of any lane closure. They should also be switched at project completion.
6. At least 48 hours prior to any closure, other than emergencies, the plaza manager shall be notified for security and staffing.

**DEDICATED LANES**

12/31/2015 11:39:12 AM

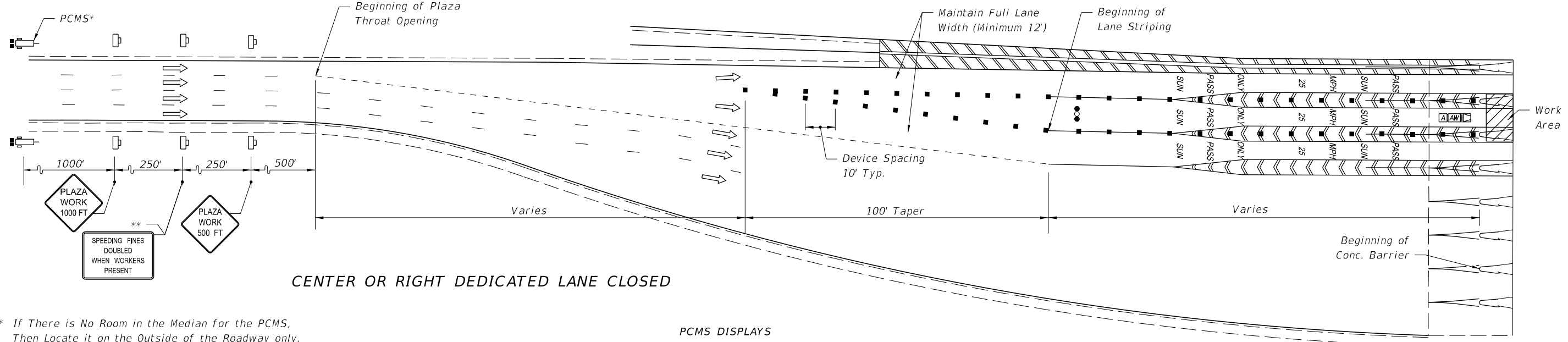

**CENTER OR RIGHT DEDICATED LANE CLOSED**

\* If There is No Room in the Median for the PCMS, Then Locate it on the Outside of the Roadway only.

\*\* Install temporary Speeding Fines Doubled sign only if there is not an existing permanent "Speeding Fines Doubled Through Toll Plaza" sign or an existing "Speeding Fines Doubled When Workers Present" sign in place.

**PCMS DISPLAYS**

MESSAGE 1: CENTER SUNPASS LANE      MESSAGE 2: CLOSED AT PLAZA      MESSAGE 1: SUNPASS ONLY LANE(S)      MESSAGE 2: KEEP LEFT

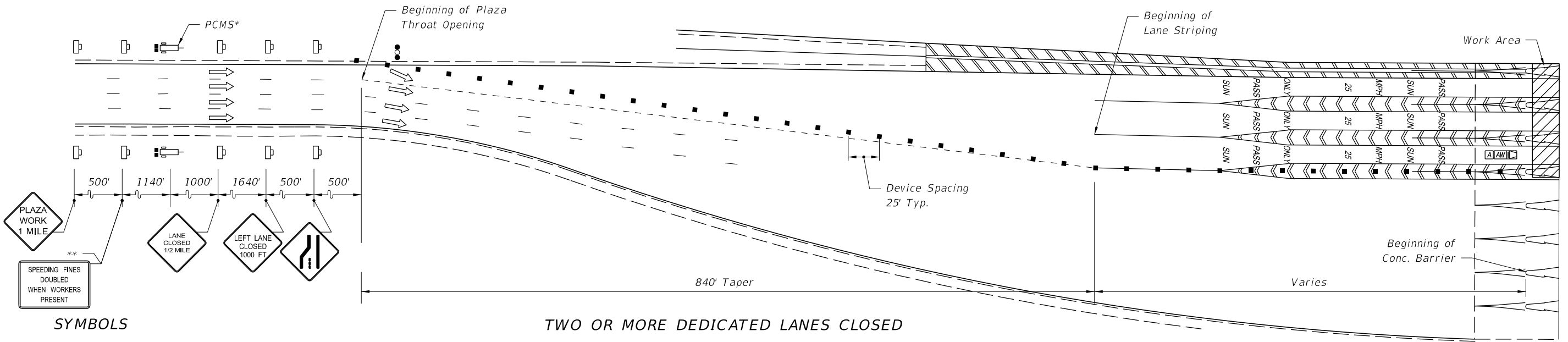

**TWO OR MORE DEDICATED LANES CLOSED**

**SYMBOLS**

- Work Area
- Channelizing Device (See Index No. 600)
- Work Zone Sign
- Advance Warning Arrow Board
- Lane Identification + Direction of Traffic
- Advance Warning Vehicle Equipped with Advance Warning Arrow Board and Truck/Trailer Mounted Attenuator
- Portable Changeable (Variable) Message Sign

**PCMS DISPLAY**  
 MESSAGE 1: SUNPASS LANES CLOSED      MESSAGE 2: USE CASH LANES

**GENERAL NOTES**

1. This Plan is to be used at Mainline Plazas Only.
2. This Plan is for Lane Closures that exceed three hours.
3. Plaza canopies which have existing DMS signs on the canopies shall display the message "LANE CLOSED" for the duration of this closure.
4. A truck/trailer mounted attenuator is required.
5. See INDEX 667 sheet 1 for Two or More Inside Dedicated Lanes Single Left Lane Closed Configuration.
6. Lane use control lights, signs, or signals over toll lanes shall be switched to the appropriate symbol, message, or correct color prior to the start of any lane closure. They should also be switched at project completion.
7. At least 48 hours prior to any closure, other than emergencies, the plaza manager shall be notified for security and staffing.

**INSIDE DEDICATED LANES**

12/3/2015 11:39:12 AM

LAST REVISION 07/01/15	REVISION	DESCRIPTION:	 FY 2016-17 DESIGN STANDARDS	TOLL PLAZA TRAFFIC CONTROL STANDARDS	INDEX NO. 667	SHEET NO. 2 of 6
---------------------------	----------	--------------	------------------------------------	--------------------------------------	------------------	---------------------

\* If there is no room in the median for the PCMS then locate it on the outside of the roadway only.

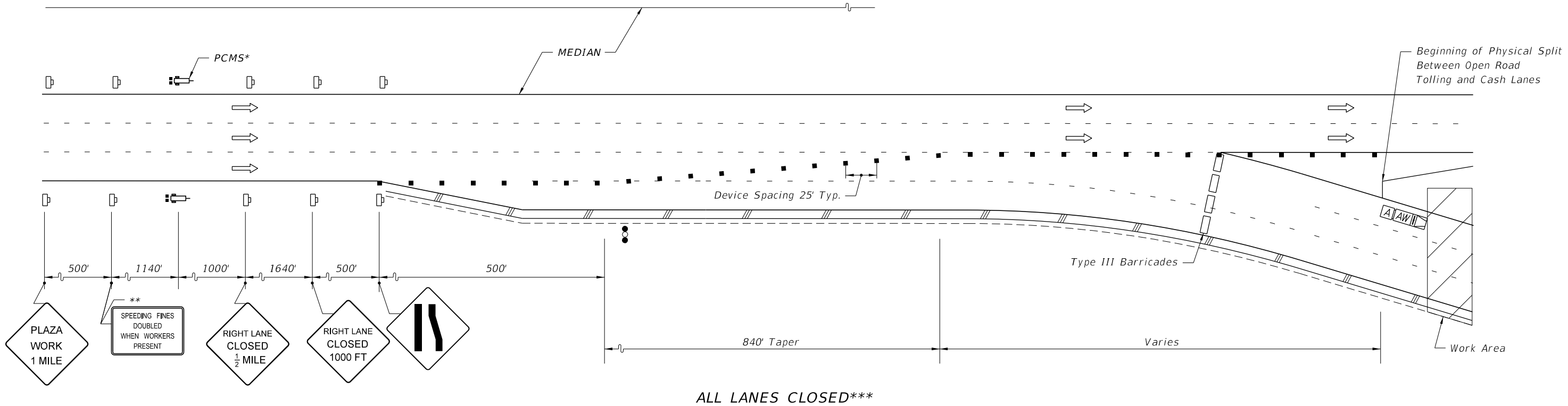

\*\* Install temporary Speeding Fines Doubled sign only if there is not an existing permanent "Speeding Fines Doubled Through Toll Plaza" sign or an existing "Speeding Fines Doubled When Workers Present" sign in place.

\*\*\* Inverted for Inside Open Road Tolling Lanes Configuration

**GENERAL NOTES**

1. This Plan is to be used at Mainline Plazas Only.
2. This Plan is for lane closures of any time length.
3. Plaza canopies which have existing DMS signs on the canopies shall display the message "LANE CLOSED" for the duration of this closure.
4. For planned lane closure, a portable changeable message sign shall be placed and shall display the message shown at a minimum of one week prior to closure. If planned lane closure is less than one week, place portable changeable message sign immediately using "prior to closure" messages.
5. A truck/trailer mounted attenuator is required.
6. Lane closure configurations applicable to 2 or 3 lane open road tolling plazas.
7. At least 48 hours prior to any closure, other than emergencies, the plaza manager shall be notified for security and staffing.

**SYMBOLS**

- Work Area
- Channelizing Device (See Index No. 600)
- Work Zone Sign
- Advance Warning Arrow Board
- Lane Identification + Direction of Traffic
- Advance Warning Vehicle Equipped with Advance Warning Arrow Board and Truck/Trailer Mounted Attenuator
- Portable Changeable (Variable) Message Sign
- Type III Barricades and "RAMP CLOSED" sign

PCMS DISPLAYS

PCMS DISPLAY PRIOR TO CLOSURE

MESSAGE 1: SUNPASS ONLY LANES      MESSAGE 2: CLOSED "DATE(S)"

PCMS DISPLAY DURING CLOSURE

MESSAGE 1: SUNPASS LANES CLOSED      MESSAGE 2: USE CASH LANES

**OUTSIDE OPEN ROAD TOLLING LANES**

12/3/2015 11:39:14 AM

LAST REVISION 07/01/15	REVISION	DESCRIPTION:	 FY 2016-17 DESIGN STANDARDS	TOLL PLAZA TRAFFIC CONTROL STANDARDS	INDEX NO. <b>667</b>	SHEET NO. <b>3 of 6</b>
---------------------------	----------	--------------	------------------------------------	--------------------------------------	-------------------------	----------------------------

\* If there is no room in the median for the PCMS sign, then locate it on the outside of the roadway only.

\*\* Install temporary Speeding Fines Doubled sign only if there is not an existing permanent "Speeding Fines Doubled Through Toll Plaza" sign or an existing "Speeding Fines Doubled When Workers Present" sign in place.

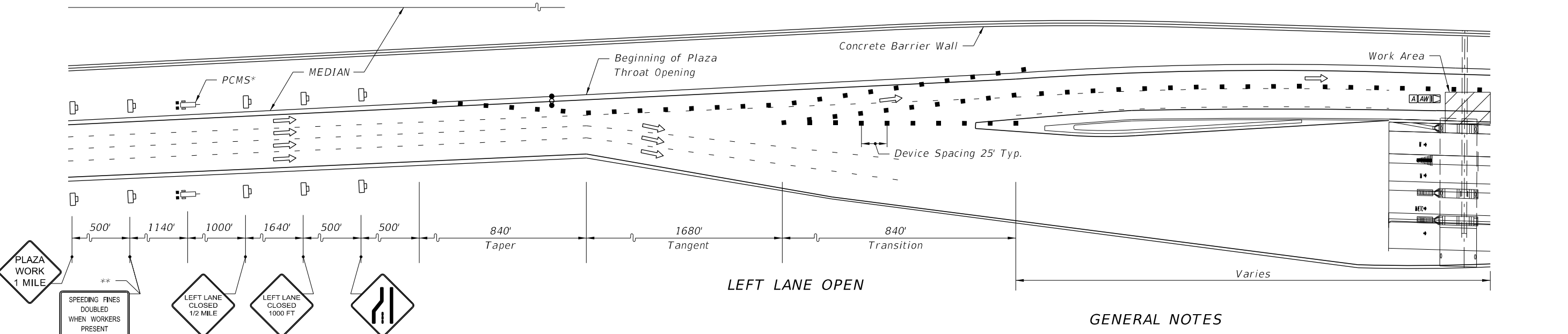
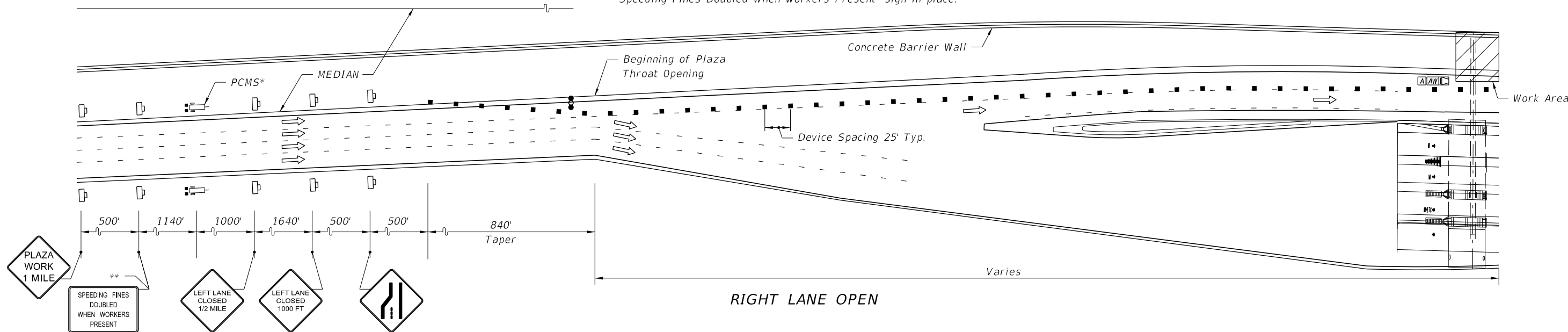

**SYMBOLS**

- Work Area
- Channelizing Device (See Index No. 600)
- Work Zone Sign
- Advance Warning Arrow Board
- Lane Identification + Direction of Traffic
- Advance Warning Vehicle Equipped with Advance Warning Arrow Board and Truck/Trailer Mounted Attenuator
- Portable Changeable (Variable) Message Sign

PCMS DISPLAYS

PCMS DISPLAY PRIOR TO CLOSURE

Message 1: ONE SUNPASS ONLY  
 Message 2: LANE OPEN "DATE(S)"

PCMS DISPLAY DURING CLOSURE

Message 1: SUNPASS ONLY LANE  
 Message 2: OPEN USE CAUTION

**GENERAL NOTES**

1. This Plan is to be used at Mainline Plazas only.
2. This Plan is for lane closures of any time length.
3. Plaza canopies which have existing DMS signs on the canopies shall display the message "LANE CLOSED" for the duration of this closure.
4. For planned lane closure, a portable changeable message sign shall be placed and shall display the messages shown at a minimum of one week prior to closure. If planned lane closure is less than one week, place portable changeable message sign immediately using "prior to closure" messages.
5. A truck/trailer mounted attenuator is required.
6. Lane closure configurations applicable to 2 or 3 lane open road tolling plazas.
7. At least 48 hours prior to any closure, other than emergencies, the plaza manager shall be notified for security and staffing.

**INSIDE OPEN ROAD TOLLING LANES**

12/3/2015 11:39:14 AM

LAST REVISION 07/01/15	REVISION	DESCRIPTION:	 FY 2016-17 DESIGN STANDARDS	TOLL PLAZA TRAFFIC CONTROL STANDARDS	INDEX NO. 667	SHEET NO. 4 of 6
---------------------------	----------	--------------	------------------------------------	--------------------------------------	------------------	---------------------

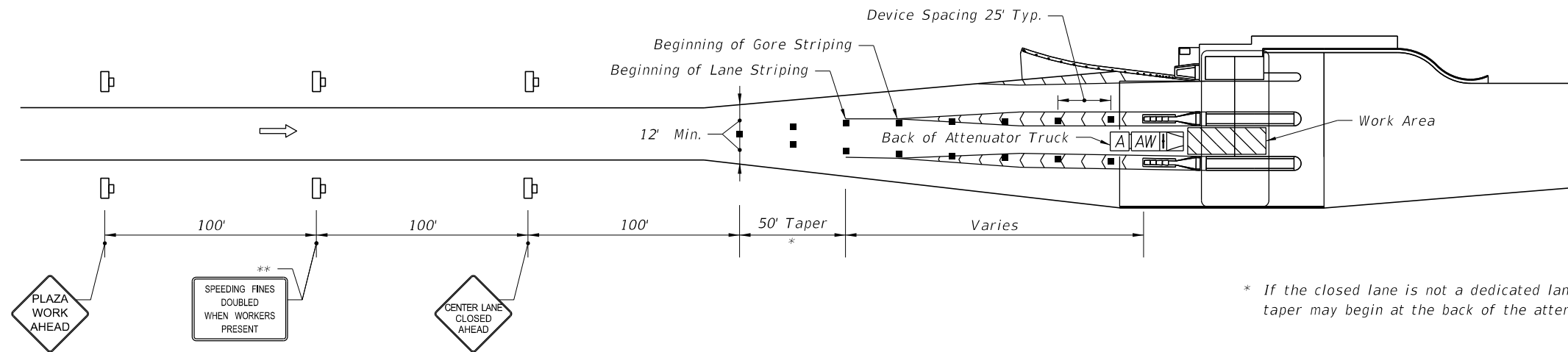

\* If the closed lane is not a dedicated lane, the 50' taper may begin at the back of the attenuator truck.

**EXHIBIT A**  
**DEDICATED, CASH, OR MIXED-USE LANES IN CENTER - ONE LANE CLOSED**  
 (This same plan can be used for any non-dedicated lane even if they are not in the center of the plaza)

\*\* Install temporary Speeding Fines Doubled sign only if there is not an existing permanent "Speeding Fines Doubled Through Toll Plaza" sign or an existing "Speeding Fines Doubled When Workers Present" sign in place.

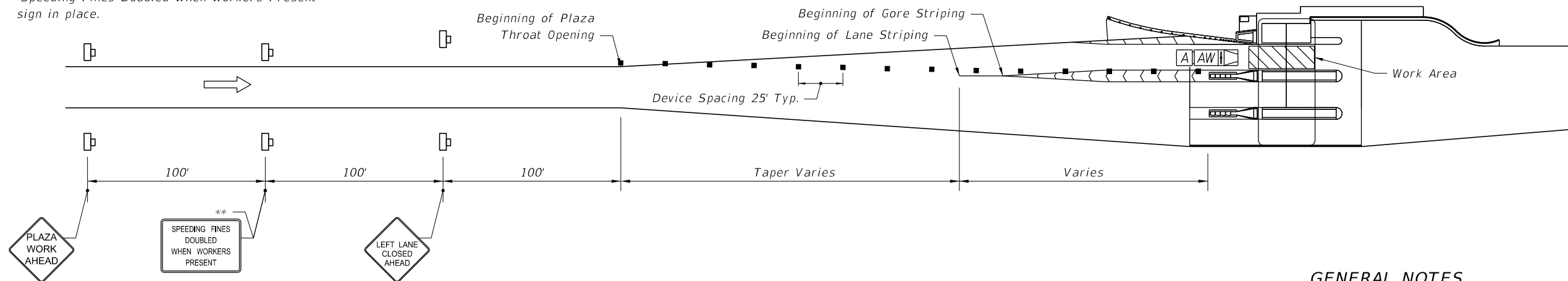

**EXHIBIT B**  
**DEDICATED LANE INSIDE OR OUTSIDE - ONE LANE CLOSED**  
 (Outside Lane Closure is a Mirror Image of this Exhibit)

**GENERAL NOTES**

1. This Plan is for lane closures that exceed three hours.
2. If the closed lane is a dedicated lane, Exhibit A shall be used at Ramp Plazas only. If the closed lane is a cash or mixed-use lane, Exhibit A may be used at Ramp or Mainline Plazas.
3. A truck/trailer mounted attenuator is required.
4. Exhibit B shall be used at Ramp Plazas only.
5. Lane use control lights, signs, or signals over toll lanes shall be switched to the appropriate symbol, message, or correct color prior to the start of any lane closure. They should also be switched at project completion.
6. At least 48 hours prior to any closure, other than emergencies, the plaza manager shall be notified for security and staffing.

**MAINLINE PLAZAS & RAMP PLAZAS**

- SYMBOLS**
- Work Area
  - Channelizing Device (See Index No. 600)
  - Work Zone Sign
  - Lane Identification + Direction of Traffic
  - Advance Warning Vehicle Equipped with Advance Warning Arrow Board and Truck/Trailer Mounted Attenuator

12/3/2015 11:39:15 AM

LAST REVISION 07/01/15	REVISION	DESCRIPTION:	 FY 2016-17 DESIGN STANDARDS	TOLL PLAZA TRAFFIC CONTROL STANDARDS	INDEX NO. 667	SHEET NO. 5 of 6
---------------------------	----------	--------------	------------------------------------	--------------------------------------	------------------	---------------------

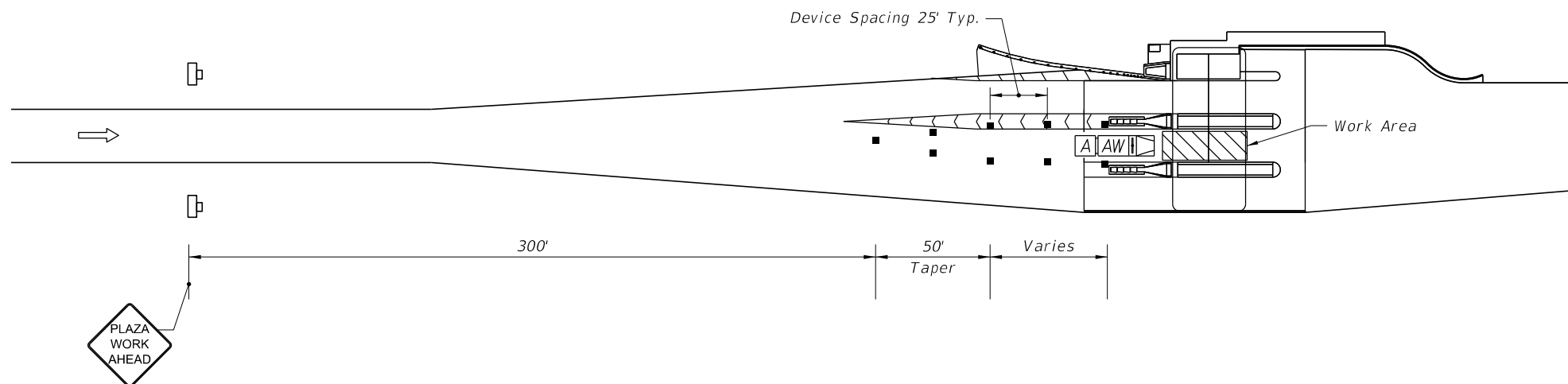



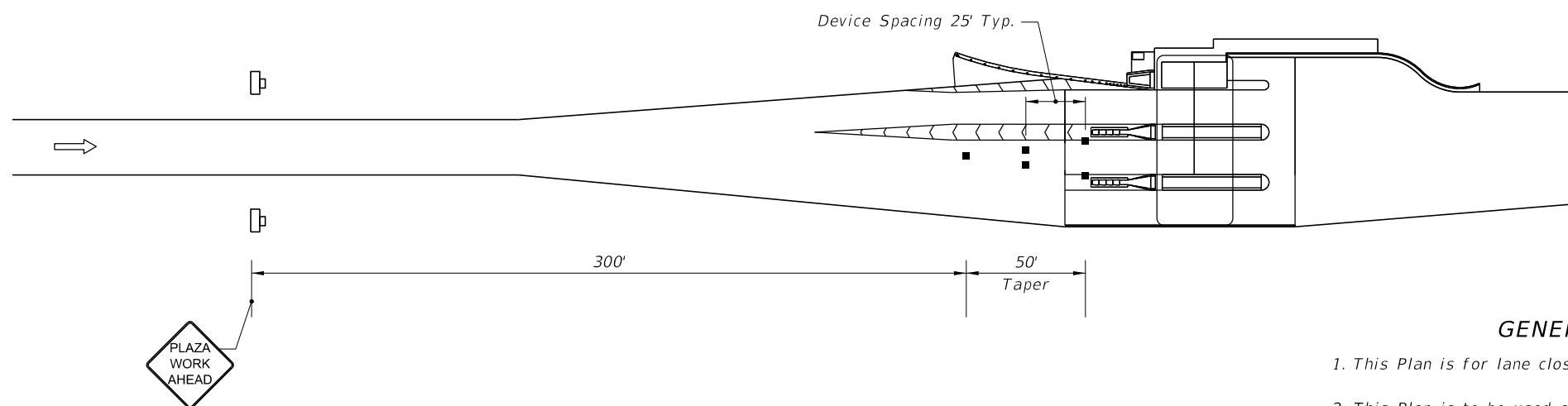

WORK DONE WITHIN TRAVEL LANE - ONE LANE CLOSED



WORK NOT DONE WITHIN TRAVEL LANE - ONE LANE CLOSED

**SYMBOLS**

-  Work Area
-  Channelizing Device (See Index No. 600)
-  Work Zone Sign
-  Lane Identification + Direction of Traffic
-  Advance Warning Vehicle Equipped with Advance Warning Arrow Board and Truck/Trailer Mounted Attenuator

**GENERAL NOTES**

1. This Plan is for lane closures that are three hours or less.
2. This Plan is to be used at Ramp or Mainline Plazas.
3. This plan can be used for any lane, with appropriate modifications, even if it is not in the center of the Plaza.
4. Lane use control lights, signs, or signals over toll lanes shall be switched to the appropriate symbol, message, or correct color prior to the start of any lane closure. They should also be switched at project completion.
5. At least 48 hours prior to any closure, other than emergencies, the plaza manager shall be notified for security and staffing.
6. A Truck/Trailer Mounted Attenuator is required for all aerial work operations (lift truck). For non-aerial operations, the Truck Mounted Attenuator or additional devices may be required by the Engineer based on the work being performed.

**SHORT-TERM CLOSURES**

12/3/2015 11:39:16 AM

LAST REVISION 07/01/15	REVISION	DESCRIPTION:	 <b>FY 2016-17 DESIGN STANDARDS</b>	<b>TOLL PLAZA TRAFFIC CONTROL STANDARDS</b>	INDEX NO. <b>667</b>	SHEET NO. <b>6 of 6</b>
---------------------------	----------	--------------	--	---	-------------------------	----------------------------

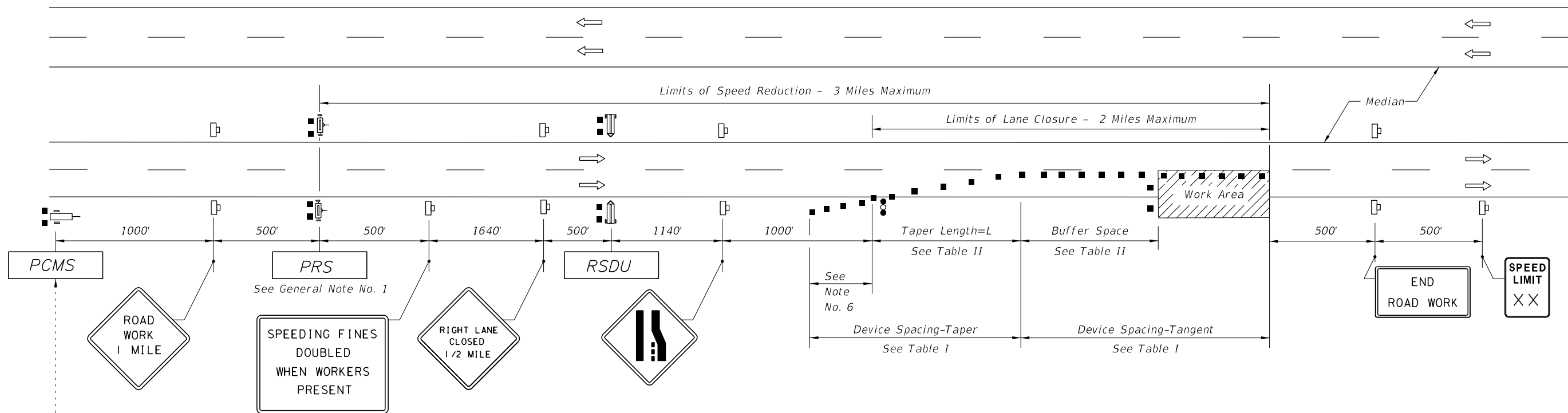

**TYPICAL PCMS DISPLAY**

With speed reduction:  
 Message 1: WORKERS PRESENT AHEAD  
 Message 2: SPEED REDUCED NEXT 3MI

Without speed reduction:  
 Message 1: WORKERS PRESENT AHEAD  
 Message 2: NEXT 3 MILES

**SYMBOLS**

- Work Area
- Channelizing Device (See Index No. 600)
- Work Zone Sign
- Advance Warning Arrow Board
- Lane Identification + Direction of Traffic
- (1) PCMS= Portable Changeable(Variable) Message Sign
- (2) PRS= Portable Regulatory Sign- Speed Limit When Flashing
- (2) RSDU= Radar Speed Display Unit

**Table I**  
**Device Spacing**

Posted Speed (mph)	Max. Distance Between Devices (ft.)			
	Cones or Tubular Markers		Type I or Type II Barricades or Vertical Panels or Drums	
	Taper	Tangent	Taper	Tangent
55 to 70	25	50	50	100

**Table II**  
**Buffer Space and Taper Length**

Posted Speed (mph)	Buffer Space	Taper Length (12' Lateral Transition)		Notes (Merge)
	Dist. (ft.)	L (ft.)		
55	495	660		L = WS
60	570	720		
65	645	780		
70	730	840		

When Buffer Space cannot be attained due to geometric constraints, the greatest attainable length shall be used, but not less than 200 ft.

For lateral transitions other than 12', use formula for L shown in the notes column.

Where:  
 L= Length of taper in feet  
 W= Width of lateral transition in feet  
 S= Posted speed limit (mph)

**GENERAL NOTES**

- If the posted speed (speed limit that existed prior to construction) is 65 MPH or greater, reduce the posted speed by 10 MPH using the Portable Regulatory Sign (PRS). If the posted speed is 55 MPH or 60 MPH, display 55 MPH using the PRS. Use the messages provided in the TYPICAL PCMS DISPLAY. Taper lengths, buffer space and device spacing shall be selected using the posted speed, not the reduced speed.
- All Arrow Boards, Portable Changeable Message Signs, Portable Regulatory Signs and Radar Speed Display Trailers, shall be turned off and moved outside the clear zone or be shielded by a barrier or crash cushion when not in use.
- Work operations shall be confined to one traffic lane, leaving the adjacent lane(s) open to traffic.
- When work is performed in the median lane on divided highways, the barricading plan is inverted and left lane closed and lane reduction signs substituted for the right lane closed and lane reduction signs.
- When work is being performed on a multilane undivided roadway, the signs and traffic control devices normally placed in the median (as shown) shall be omitted.
- When paved shoulders having a width of 8 ft. or more are closed, channelizing devices shall be used to close the shoulder in advance of the merging taper to direct vehicular traffic to remain within the travel way. See Index No. 612 for shoulder taper formulas.
- For general TCZ requirements and additional information, refer to Index No. 600.

**CONDITIONS**

The MAS shall be used if all the following conditions exist:

- MULTILANE FACILITY
- POSTED SPEED LIMIT IS 55 MPH OR GREATER
- WORK ACTIVITY REQUIRES A LANE CLOSURE FOR MORE THAN 5 DAYS (CONSECUTIVE OR NOT)
- WORKERS ARE PRESENT AND NOT PROTECTED BY BARRIER

12/3/2015 11:39:16 AM