

PLAN
(Reinforcing Steel not shown for clarity)

BARRIER DELINEATOR SPACING	
Distance - Edge of Travel Lane to Face of Railing	Spacing (Ft.)
< 4'	40'
4' to 8'	80'
> than 8'	None Required

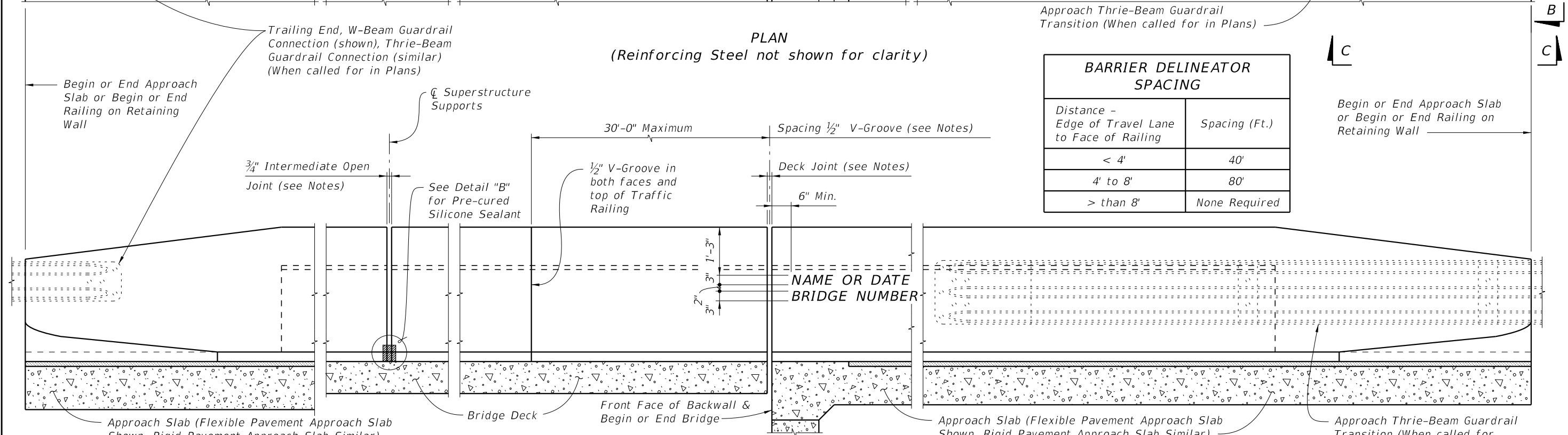

ELEVATION OF INSIDE FACE OF RAILING
(Reinforcing Steel not shown for clarity)
(Railing on Bridge Deck and Approach Slab shown, Railing on Retaining Wall Similar)

CROSS REFERENCE:
For Section A-A, End View B-B and Detail "A" see Sheet 2.
For Detail "B" see Sheet 3.

TRAFFIC RAILING NOTES

This railing has been structurally evaluated to be equivalent or greater in strength to other safety shape railings which have been crash tested to NCHRP Report 350 TL-5 Criteria.

CONCRETE AND REINFORCING STEEL : See Structures Plans, General Notes.

SUPERELEVATED BRIDGES : At the option of the Contractor the Traffic Railing on superelevated bridges may be constructed perpendicular to the roadway surface. If an adjoining railing is constructed plumb, transition the end of the Traffic Railing from perpendicular to plumb over a minimum distance of 20'-0". The cost of all modifications will be at the Contractor's expense.

GUARDRAIL : For Guardrail connection details, see Index No. 400.

RAILINGS ON RETAINING WALLS : If the Traffic Railing is to be provided on a retaining wall, the railing section will be the same as shown on Sheet 2. All other details such as the guardrail transition attachment, the maximum spacing of the 3/4" open joints and 1/2" V-groove shall apply.

V-GROOVES : Construct 1/2" V-Grooves plumb. Space V-Grooves equally between 3/4" Open Joints and/or Deck Joints and at V-Groove locations on Retaining Wall footings.

NAME, DATE, AND BRIDGE NUMBER : The Name and Bridge Number shall be placed on the Traffic Railing so as to be seen on the driver's right side when approaching the bridge. The Date shall be placed on the driver's left side when approaching the bridge. The Name shall be as shown in the General Notes in the Structures Plans. The Date shall be the year the bridge is completed. For a widening when the existing railing is removed, use both the existing date and the year of the widening. Black plastic letters and figures 3" in height may be used, as approved by the Engineer, in lieu of the letters and figures formed by 3/8" V-Grooves. V-Grooves shall be formed by preformed letters and figures.

JOINTS : See Structures Plans, Superstructure, Approach Slab and Retaining Walls Sheets for actual dimensions and joint orientation. Provide open Railing Joints at Deck Expansion Joint locations matching the dimensions of the Deck Joint. For treatment of Railings on skewed bridges see Index No. 420.

- Provide 3/4" Intermediate Open Joints shall be provided at :
- (1) - Superstructure supports where slab is continuous.
 - (2) - Ends of approach slabs when adjacent to retaining walls and at expansion joints on retaining wall junction slabs.

BARRIER DELINEATORS: Barrier Delineators shall meet Specification Section 993. Install Barrier Delineators on top of the Traffic Railing 2" from the face on the traffic side at the spacing shown in the table above. Barrier Delineator color (white or yellow) shall match the color of the near edgeline. The cost of the Barrier Delineators shall be included in the Contract Unit Price for the Traffic Railing

12/17/2015 11:17:38 AM

LAST REVISION 01/01/14	REVISION	DESCRIPTION:	 FY 2016-17 DESIGN STANDARDS	TRAFFIC RAILING - (42" F SHAPE)	INDEX NO. 425	SHEET NO. 1 of 3
---------------------------	----------	--------------	--	--	-------------------------	----------------------------

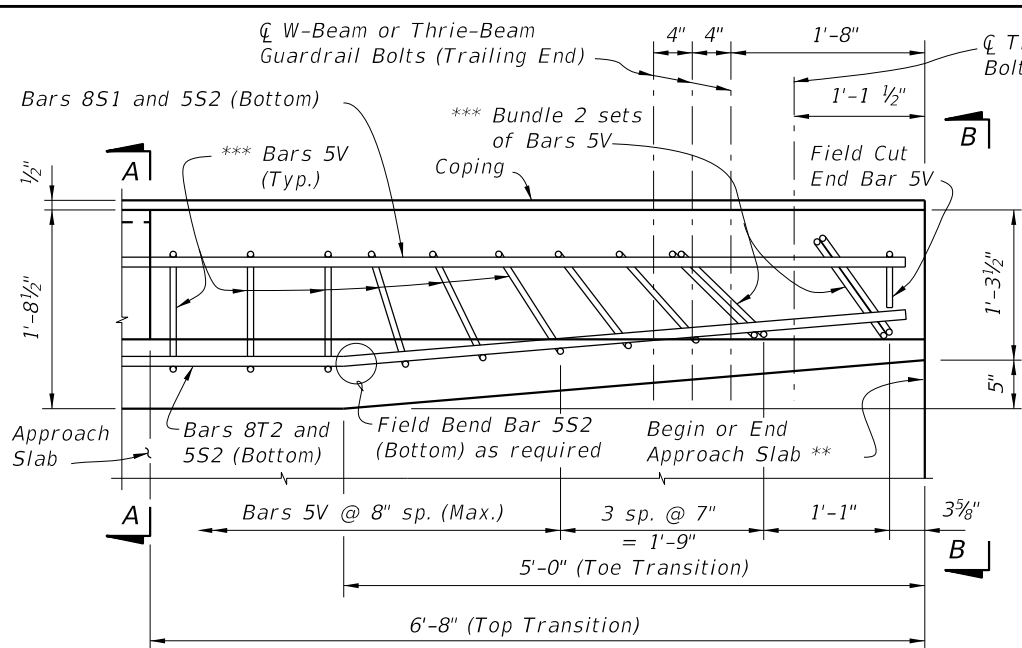

PLAN - Railing End Transition
(Showing Bars 5V, 8S1, 5S2 and 8T2)

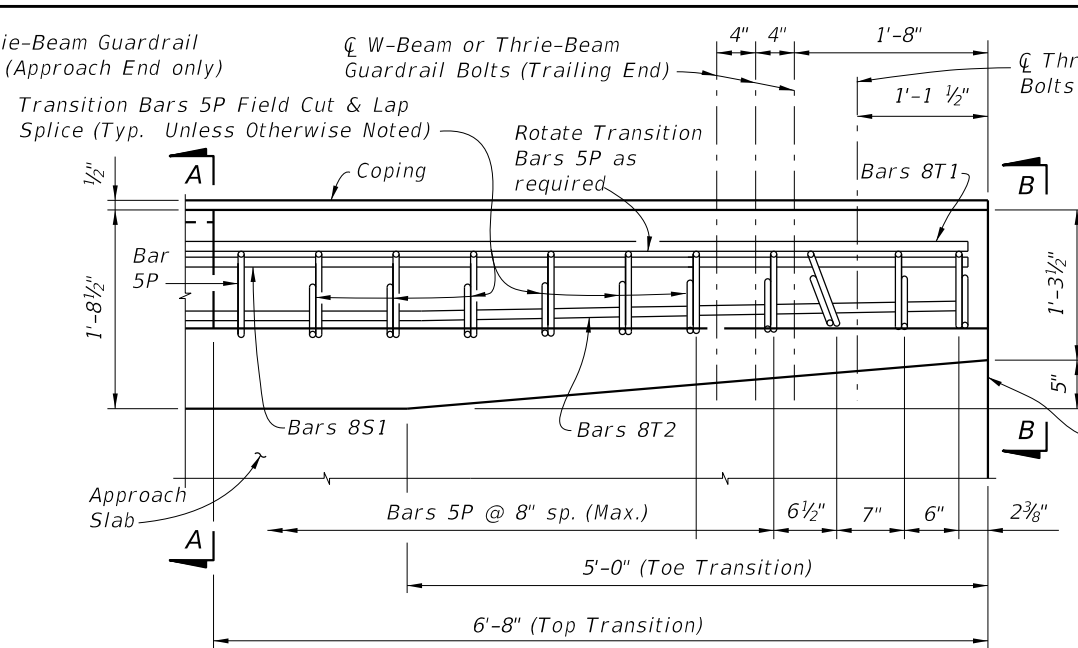

PLAN - Railing End Transition
(Showing Transition Bars 5P and Bars 8S1, 8T1 & 8T2)

NOTE:
Begin placing Railing Bars 5P and 5V on Approach Slab at the railing end and proceed toward Begin or End Bridge to ensure placement of guardrail bolt holes. If required, adjustments to the bar spacing for Bars 5P and 5V shall be made immediately adjacent to Begin or End Bridge. Shift and rotate Bars 5P and 5V (see Detail "A") as required to maintain cover in Railing End Transition.

* Where railings of adjacent bridges are to be built back to back, the outside vertical plane of the railing and deck may coincide along a plane centered 1'-8 1/2" from each gutter line. A bond breaker will be required. See Structures Plans, Superstructure Sheets for Details.

** See joint orientation note on Sheet 1.

*** Rotate Bars 5V as shown to maintain clearance.

DETAIL "A"

Note:
Lap Bars 8T1 and 8T2 with Bars 8S1 (4'-0" Min. Lap Splice).

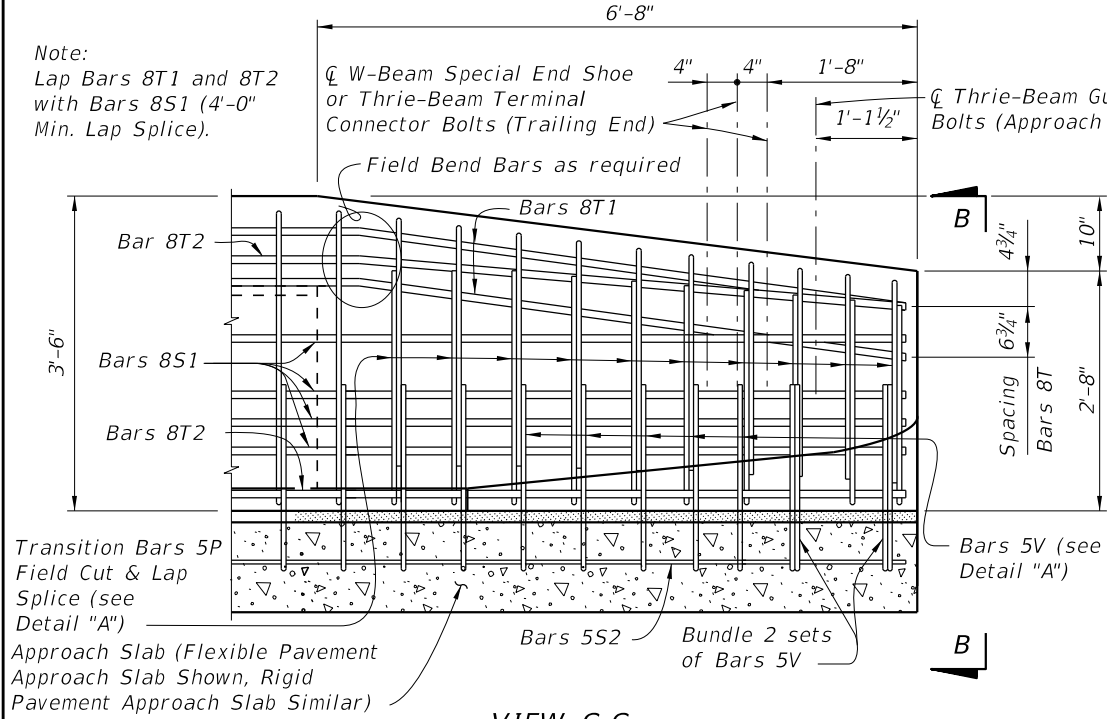

VIEW C-C
ELEVATION - RAILING END TRANSITION
(Guardrail and back leg of Stirrups not shown for clarity)

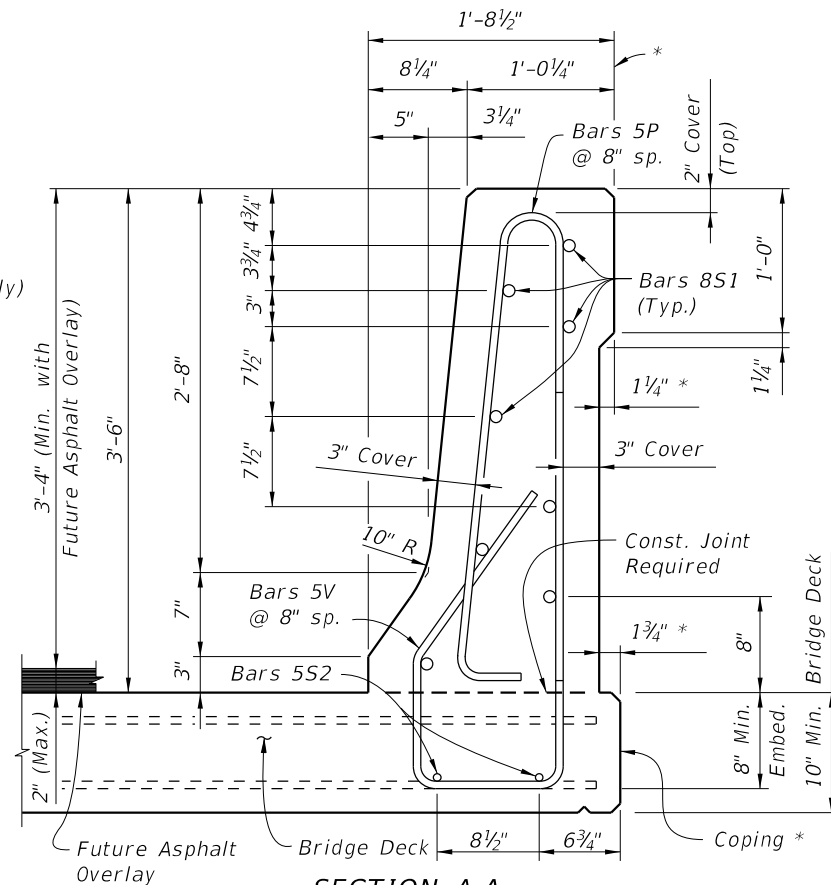

SECTION A-A
TYPICAL SECTION THRU TRAFFIC RAILING
(SECTION THRU BRIDGE DECK SHOWN - SECTION THRU APPROACH SLAB SIMILAR)

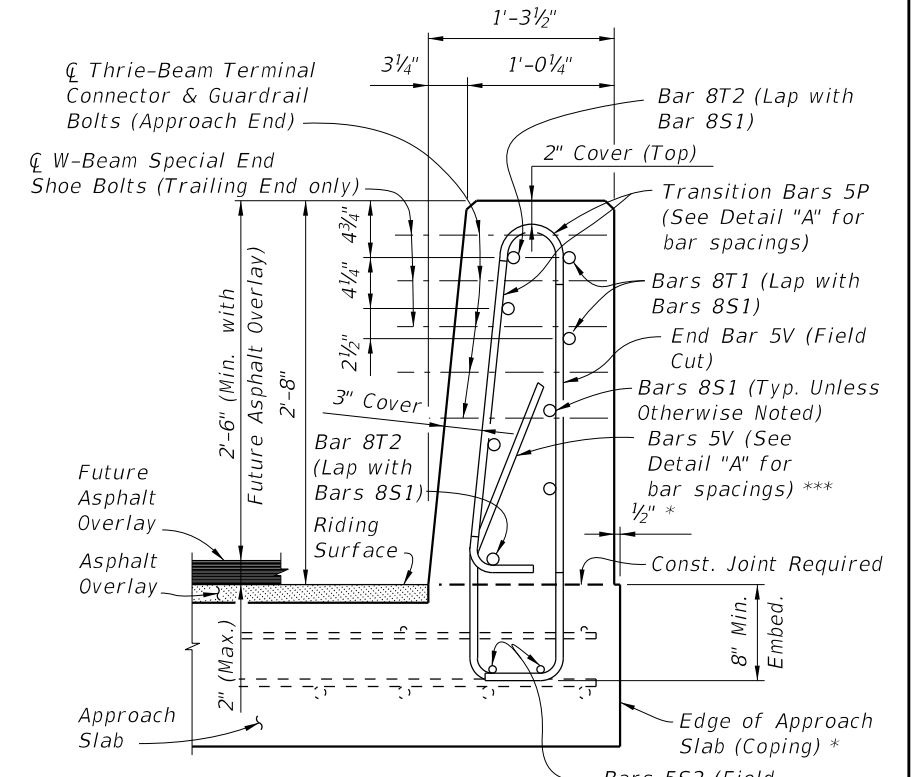

VIEW B-B
(Section thru Approach Slab shown, Section thru Retaining Walls similar)

12/17/2015 11:17:39 AM

LAST REVISION	DESCRIPTION:
07/01/14	

CONVENTIONAL REINFORCING STEEL BENDING DIAGRAMS

BILL OF REINFORCING STEEL		
MARK	SIZE	LENGTH
P	5	7'-5"
S1	8	As Req'd.
S2	5	As Req'd.
T1 & T2	8	13'-0"
V	5	6'-2"

ROADWAY CROSS-SLOPE	LOW GUTTER		HIGH GUTTER	
	∅A	∅B	∅A	∅B
0% to 2%	90°	90°	90°	90°
2% to 6%	93°	87°	87°	93°
6% to 10%	96°	84°	84°	96°

∅A and ∅B shall be 90° if Contractor elects to place Railing perpendicular to the Deck.

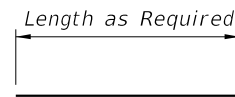

BARS 8S1 & 5S2

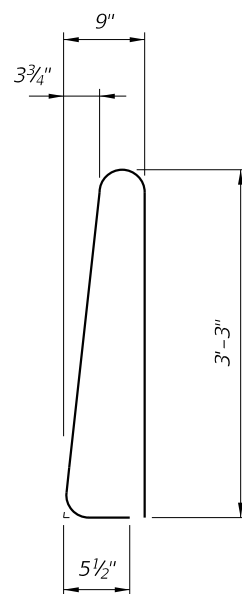

STIRRUP BAR 5P

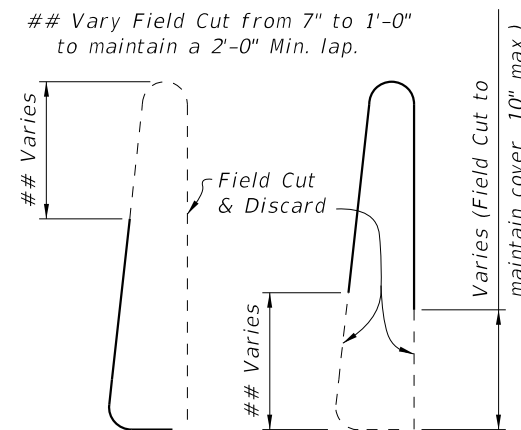

TRANSITION STIRRUP BARS 5P
To Be Field Cut (10 of each required per Railing End Transition)

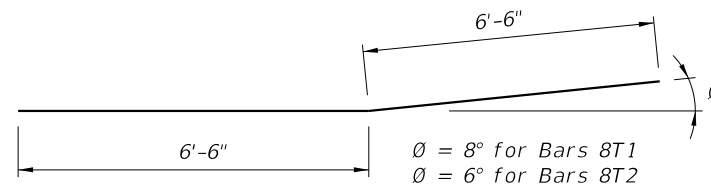

TRANSITION BARS 8T1 & 8T2
(2 of each required per Railing End Transition)

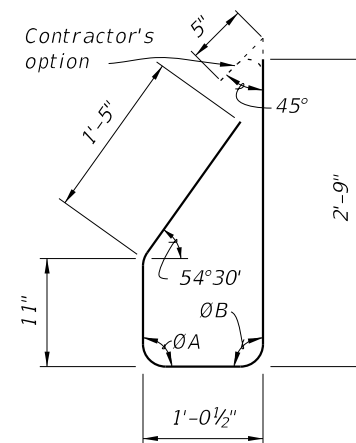

STIRRUP BAR 5V

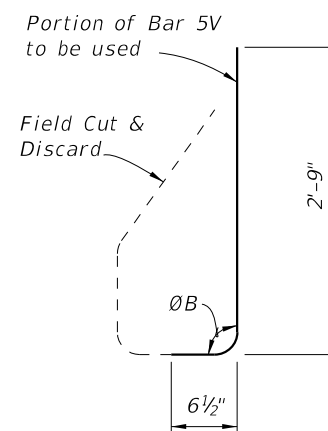

END STIRRUP BAR 5V
To Be Field Cut
(One required per Railing End Transition)

REINFORCING STEEL NOTES:

- All bar dimensions in the bending diagrams are out to out.
- The reinforcement for the railing on a retaining wall shall be the same as detailed above for a 10" deck with ∅A = ∅B = 90°.
- All reinforcing steel at the open joints shall have a 2" minimum cover.
- Bars 8S1 may be continuous or spliced at the construction joints. Lap splices for Bars 8S1 and 5S2 shall be a minimum of 4'-0" and 2'-0", respectively.
- The Contractor may utilize Welded Wire Reinforcement (WWR) when approved by the Engineer. WWR must consist of Deformed wire meeting the requirements of Specification Section 931.

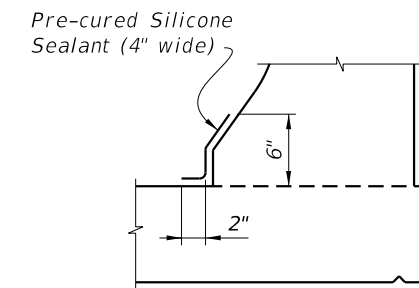

DETAIL "B" - SECTION AT INTERMEDIATE OPEN JOINT

INTERMEDIATE JOINT SEAL NOTES:

- At Intermediate Open Joints, seal the lower 6" portion of the open joint with Pre-cured Silicone Sealant in accordance with Specification Section 932.
- Apply sealant prior to any Class V finish coating and remove all curing compound and loose material from the surface prior to application of bonding agent.
- The cost of the Pre-cured Silicone Sealant shall be included in the Contract Unit Price for the Traffic Railing.

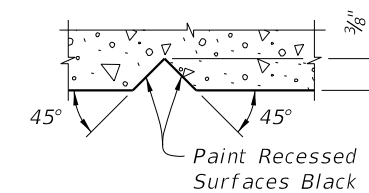

SECTION THRU RECESSED "V" GROOVE TO FORM INSCRIBED LETTERS AND FIGURES

ESTIMATED TRAFFIC RAILING QUANTITIES		
ITEM	UNIT	QUANTITY
Concrete	CY/LF	0.154
Reinforcing Steel	LB/LF	44.71

Note:

The estimated railing quantities are based on a 2% deck cross slope; railing on low side of deck.

12/17/2015 11:17:40 AM

LAST REVISION 07/01/13	DESCRIPTION:
---------------------------	--------------