

PICTORIAL

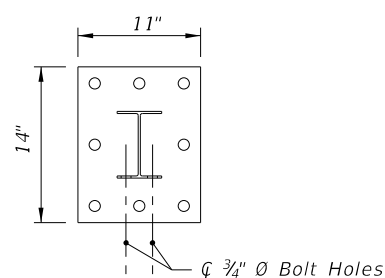

TOP VIEW

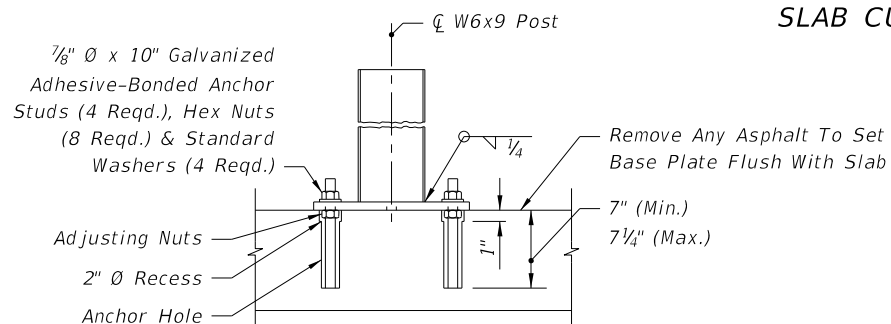

SIDE VIEW

SPECIAL STEEL POST FOR ROADWAY THRIE-BEAM TRANSITIONS TO BRIDGE TRAFFIC RAILING RETROFITS

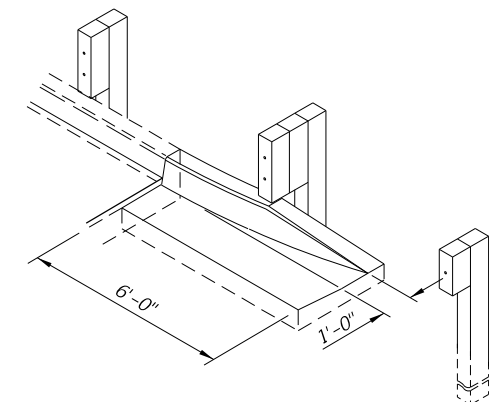

CURB TYPE F FLARE WHEN END OF EXISTING APPROACH SLAB CURB EXPOSED

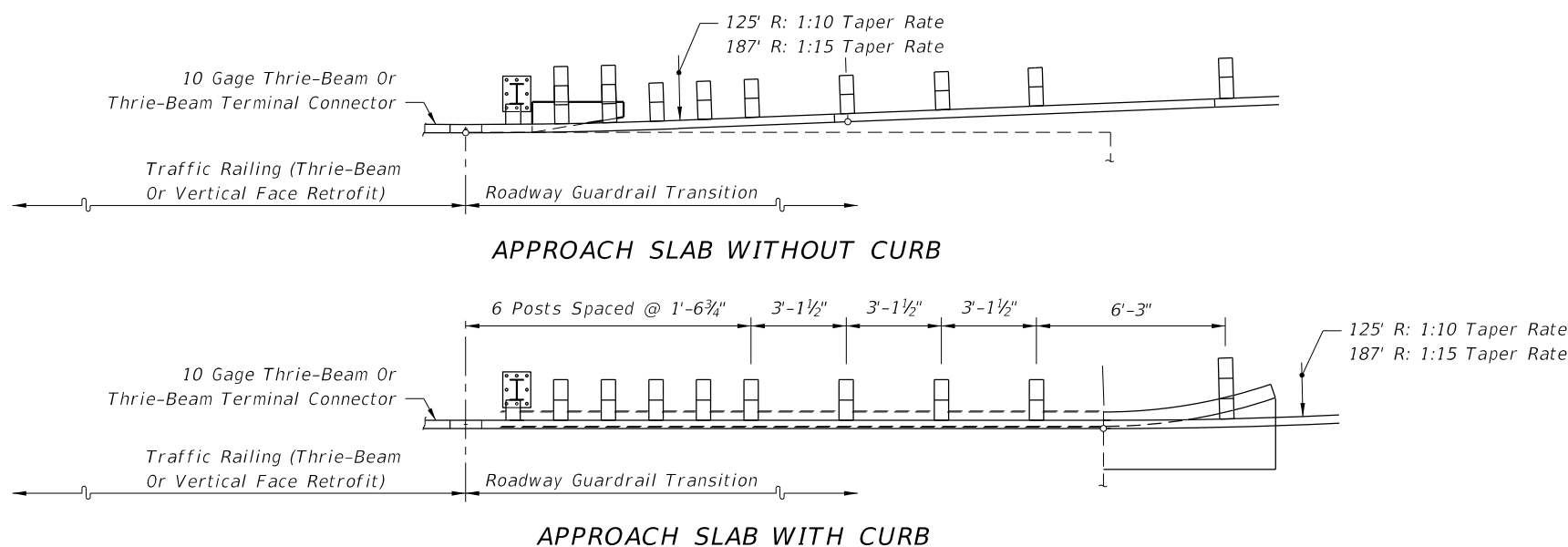

APPROACH SLAB WITHOUT CURB

APPROACH SLAB WITH CURB

Longitudinal Location Of Transition Blocks And Curb End Flares Will Vary With Scheme Type

PARTIAL PLAN VIEWS

GUARDRAIL TRANSITION ALIGNMENTS FOR BRIDGE THRIE-BEAM AND VERTICAL FACE TRAFFIC RAILING RETROFIT

GENERAL NOTES

1. This index provides thrie-beam transition and connection details for approach end guardrail on existing bridges, and anchorage details for trailing end traffic railing retrofits and safety shapes on existing bridges. Sheets 1 through 23 apply to bridges with retrofitted traffic railings, (Sheet 23 shows the trailing end guardrail connections). Sheet 24 applies to bridges with safety shaped traffic railing.
2. The schemes identified by Arabic numerals in this index are complementary to the bridge traffic railing barrier retrofit schemes with like numeral identification in Index Nos. 470, 471 through 476, 480 through 483. The schemes in this index identified by Roman numerals are complementary to bridge safety shaped traffic railing barrier where determined to be in accordance with applications of criteria specified in the Instructions for Design Standards (IDS-470 & IDS-480).
3. For guardrail applications and details of related hardware and accessories that are not provided on this index, refer to Index No. 400.

NOTES FOR GUARDRAIL TRANSITIONS CONNECTING TO TRAFFIC RAILING RETROFITS ON EXISTING BRIDGES

1. The transition detail shown on this sheet shows (a) the standard post spacings within the typical thrie-beam approach transitions connecting to existing bridges with retrofit traffic railings, and (b) depict the typical alignments of the approach transitions.
2. The curb and gutter flare shown on this sheet is typical of flares that are to be constructed when approach slab curbs extend to the beginning of the slab, and where other treatment to curb blunt ends are not in place.
3. The special steel post for roadway thrie-beam transitions detailed on this sheet is specific to all transition applications on this index that require one or more steel posts.

The special steel post and base plate assembly shall be fabricated using ASTM A36 or ASTM A709 Grade 36 steel. Welding shall conform to ANSI/AASHTO/AWS D1.5. The assembly shall be hot-dip zinc coated in accordance with Section 536 of the Specifications.

Anchor studs shall be fully threaded rods in accordance with ASTM F1554 Grade 36 or ASTM A193 Grade B7. All nuts shall be heavy hex in accordance with ASTM A563 or ASTM A19

4. Anchor studs and nuts shall be hot-dip zinc coated in accordance with the Specifications. After the nuts have been snug tightened, the anchor stud threads shall be single punch distorted immediately above the top nuts to prevent loosening of the nuts. Distorted threads shall be coated with a galvanizing compound in accordance with the Specifications.

Adhesive bonding material systems for anchors shall comply with Specification Section 937 and be installed in accordance with Specification Section 416.4. Nested beam extensions and points for terminal connector attachments will vary for traffic railing barrier vertical face retrofits. The plan views for the vertical face retrofit barriers show the primary configurations for each particular scheme. The associated pictorial views show the variations.

5. For installing thrie-beam terminal connector to traffic railing vertical face retrofits, see notations on Sheets 12 through 15 and the flag notation on Sheet 23.
6. Payment for connections to traffic railing vertical face retrofits are to be made under the contract unit price for Bridge Anchorage Assembly, EA., and shall be full compensation for bolt hole construction, terminal connector, terminal connector plate and bolts, nuts and washers.

DESIGN NOTES FOR GUARDRAIL TRANSITIONS CONNECTING TO TRAFFIC RAILING RETROFITS ON EXISTING BRIDGES

1. For selection of an appropriate transition scheme, see the Instructions for Design Standards (IDS-470 & IDS-480) for instructions to the Structures and Roadway engineers.

07/01/13

GUARDRAIL TRANSITIONS AND CONNECTIONS FOR EXISTING BRIDGES

402 1 24

6/8/2015 11:10:39 AM

LAST REVISION 07/01/13	DESCRIPTION:	2016 FDOT DESIGN STANDARDS	GUARDRAIL TRANSITIONS AND CONNECTIONS FOR EXISTING BRIDGES	INDEX NO. 402	SHEET NO. 1 of 24
---------------------------	--------------	-------------------------------	--	------------------	----------------------

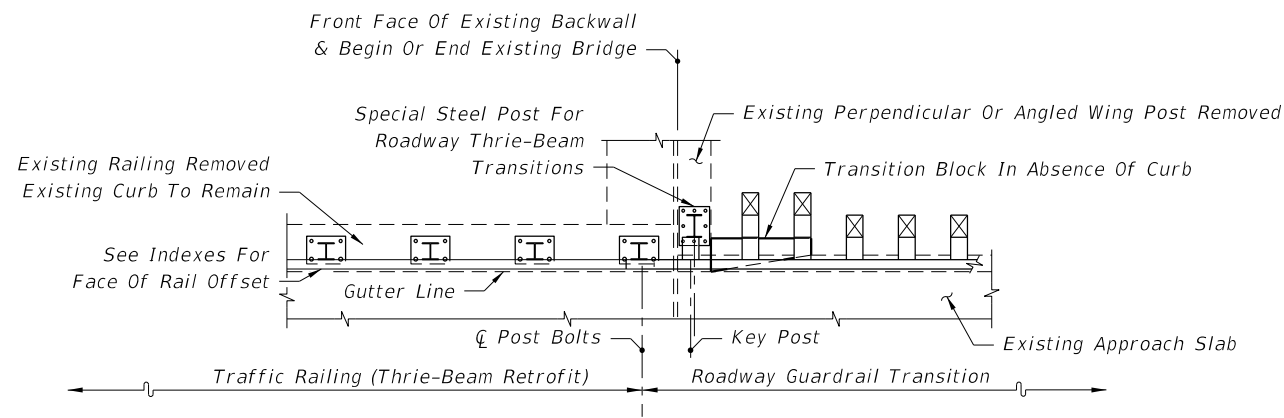

SEE INDEX NO. 471 - SCHEME 1

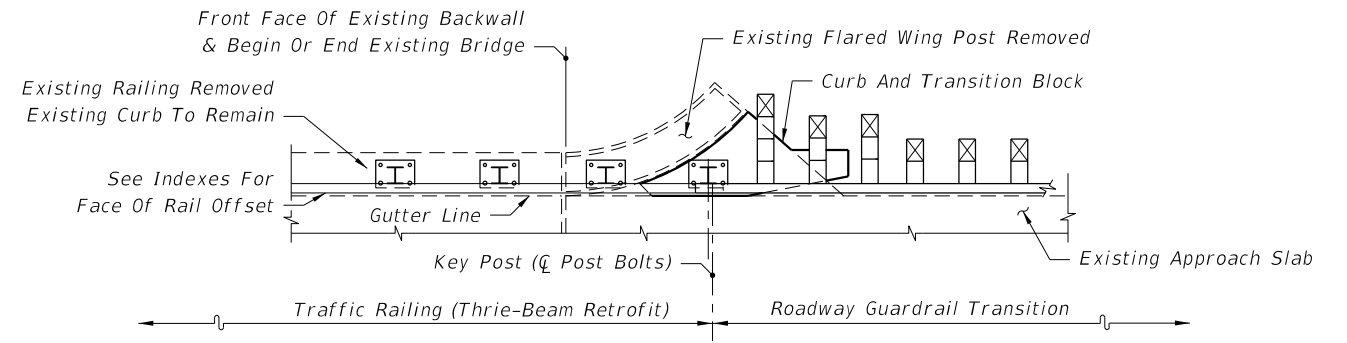

SEE INDEX NO. 471 - SCHEME 3

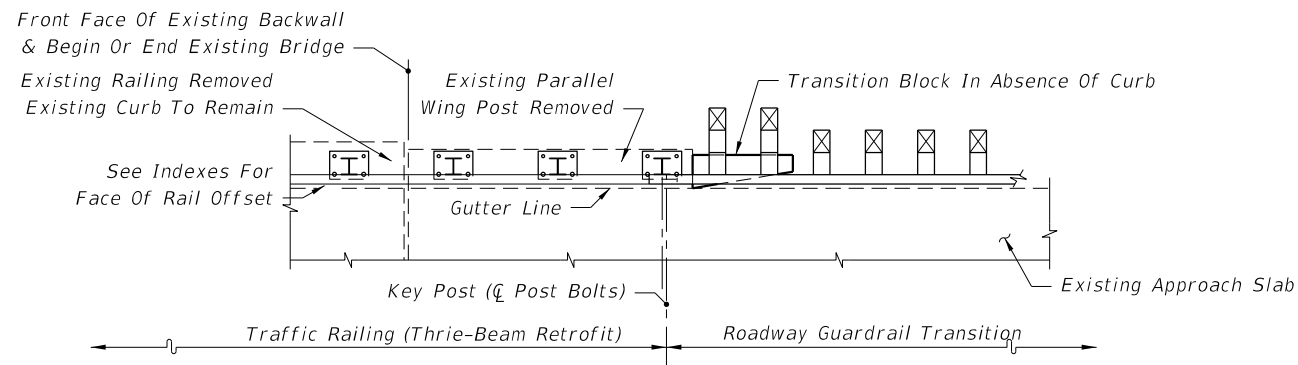

SEE INDEX NO. 471 - SCHEME 2

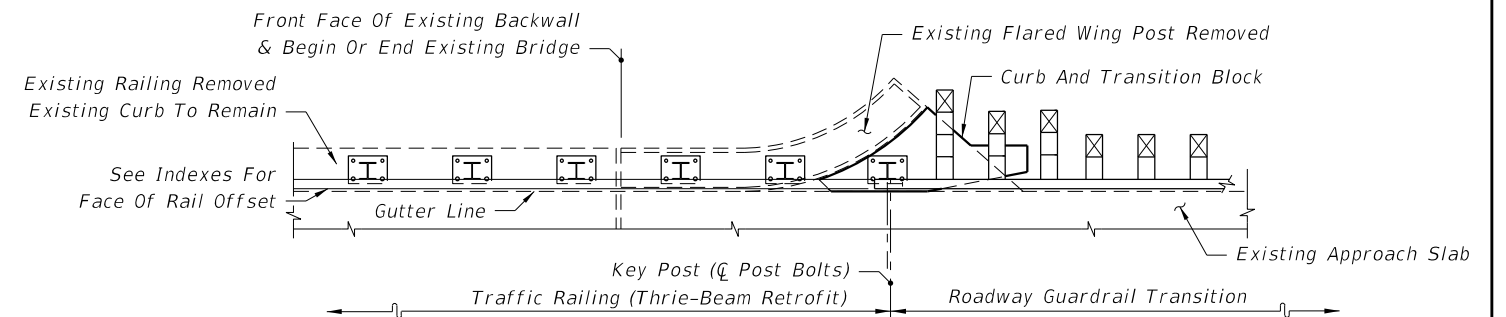

SEE INDEX NO. 471 - SCHEME 3

PARTIAL PLAN VIEWS OF GUARDRAIL APPROACH TRANSITIONS AND CONNECTIONS
FOR BRIDGE TRAFFIC RAILING (THRIE-BEAM RETROFIT)

6/8/2015 11:10:40 AM

LAST REVISION 07/01/07	REVISION	DESCRIPTION:	 2016 DESIGN STANDARDS	GUARDRAIL TRANSITIONS AND CONNECTIONS FOR EXISTING BRIDGES	INDEX NO. 402	SHEET NO. 2 of 24
---------------------------	----------	--------------	---	---	------------------	----------------------

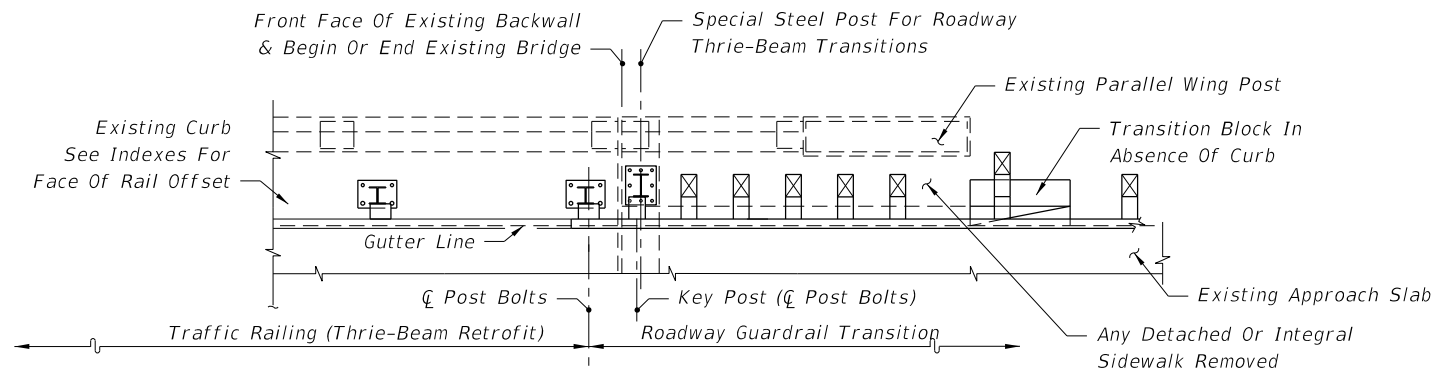

SEE INDEX NOS. 472 & 475 - SCHEME 2

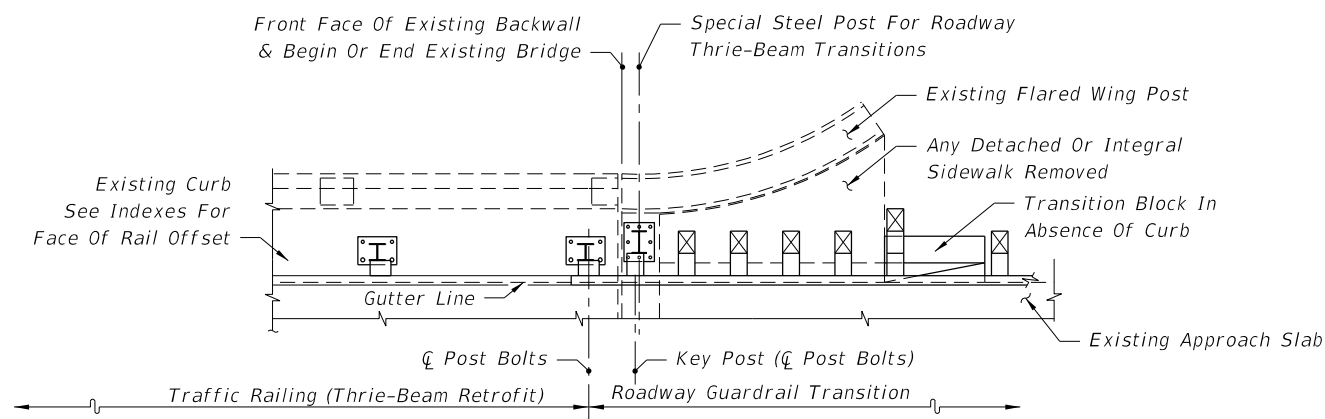

SEE INDEX NOS. 472 & 475 - SCHEME 2

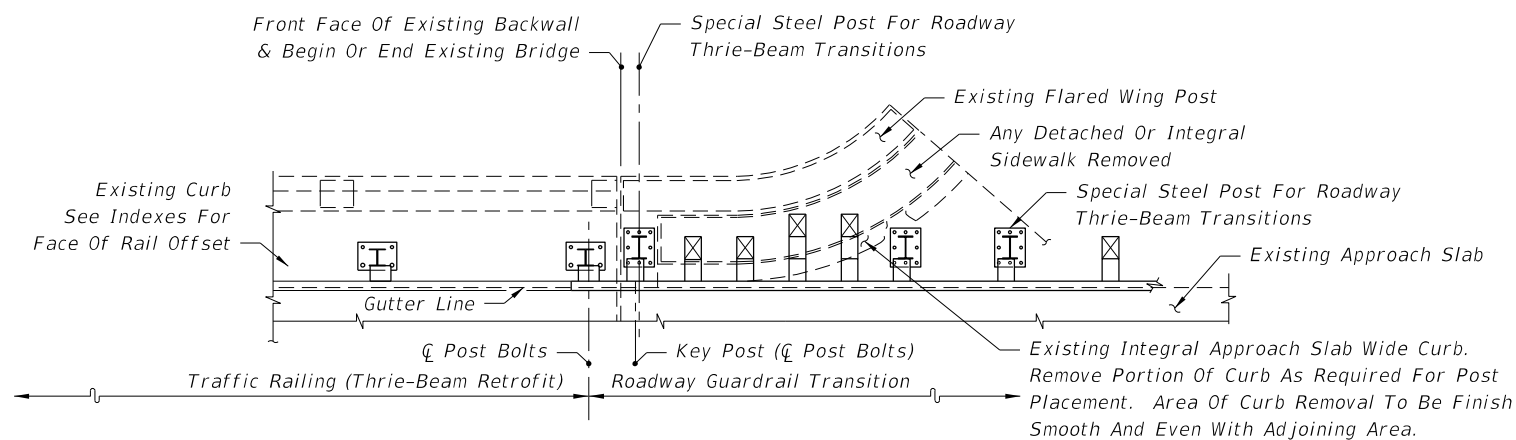

SEE INDEX NOS. 472 & 475 - SCHEME 2

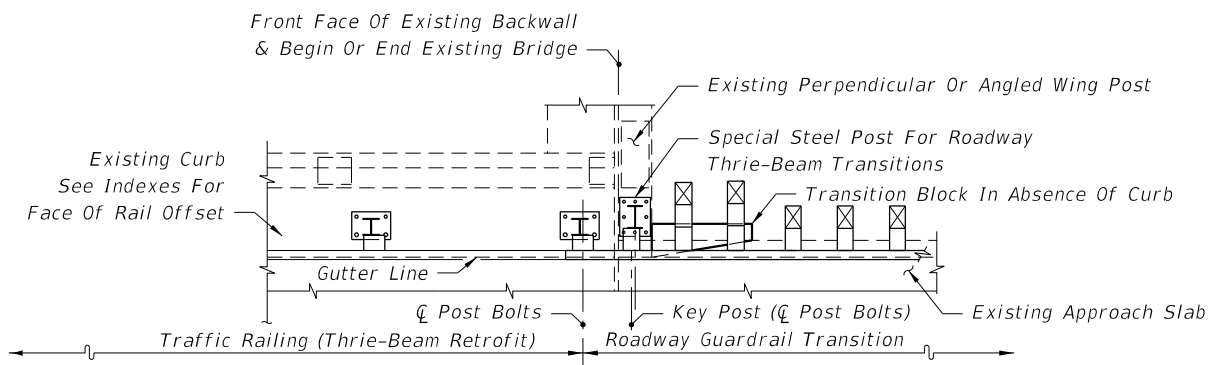

SEE INDEX NOS. 472 & 475 - SCHEME 1

PARTIAL PLAN VIEWS OF GUARDRAIL APPROACH TRANSITIONS AND CONNECTIONS
FOR BRIDGE TRAFFIC RAILING (THRIE-BEAM RETROFIT)

6/8/2015 11:10:41 AM

LAST REVISION 07/01/07	REVISION	DESCRIPTION:	 2016 DESIGN STANDARDS	GUARDRAIL TRANSITIONS AND CONNECTIONS FOR EXISTING BRIDGES	INDEX NO. 402	SHEET NO. 3 of 24
---------------------------	----------	--------------	---	---	------------------	----------------------

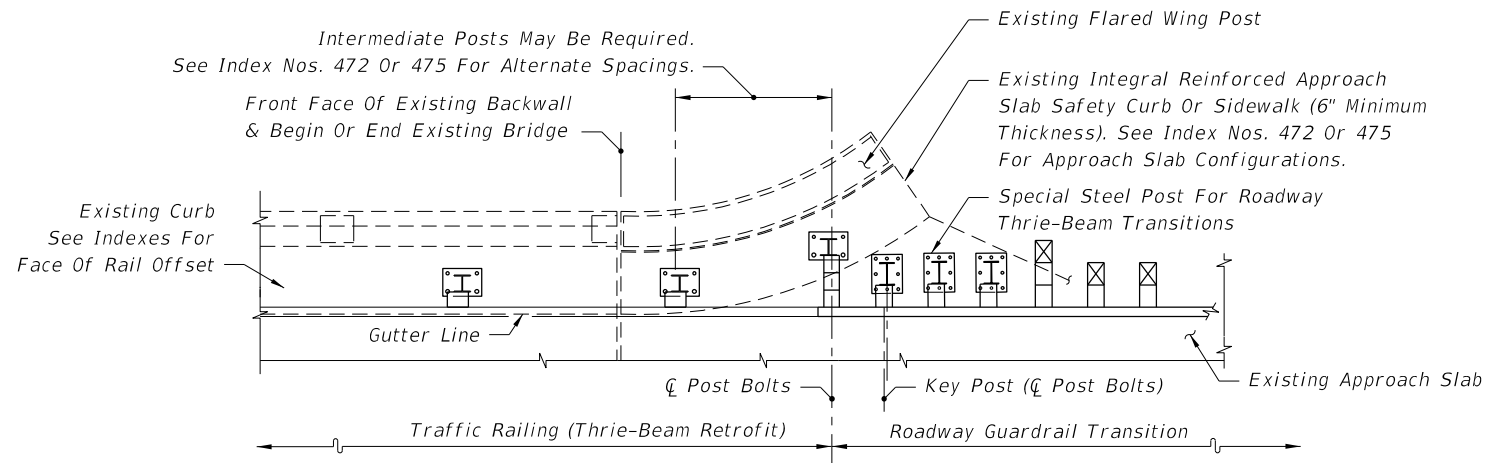

SEE INDEX NOS. 472 & 475 - SCHEMES 3 & 4

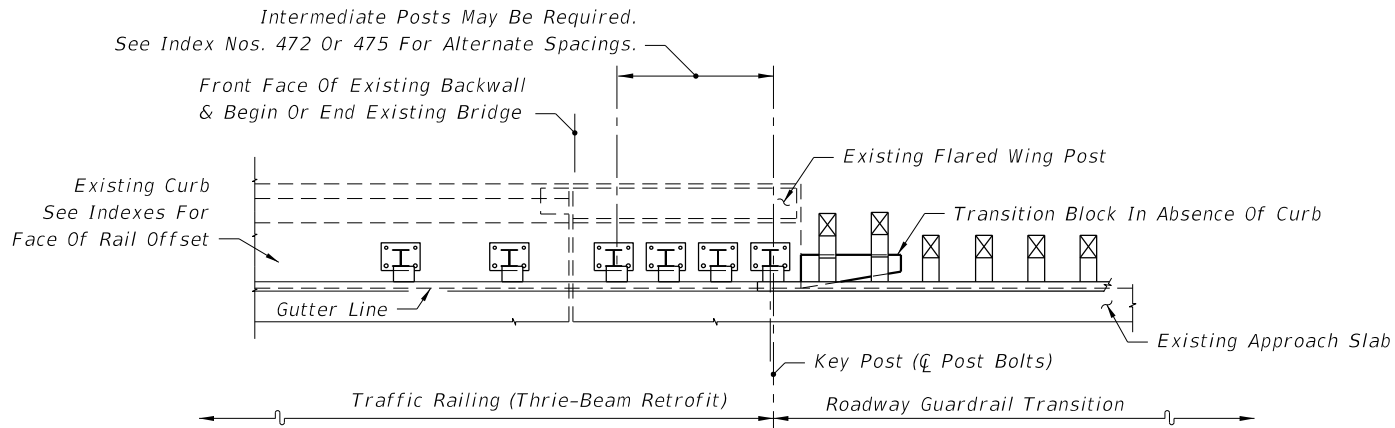

SEE INDEX NOS. 472 & 475 - SCHEMES 5 & 6

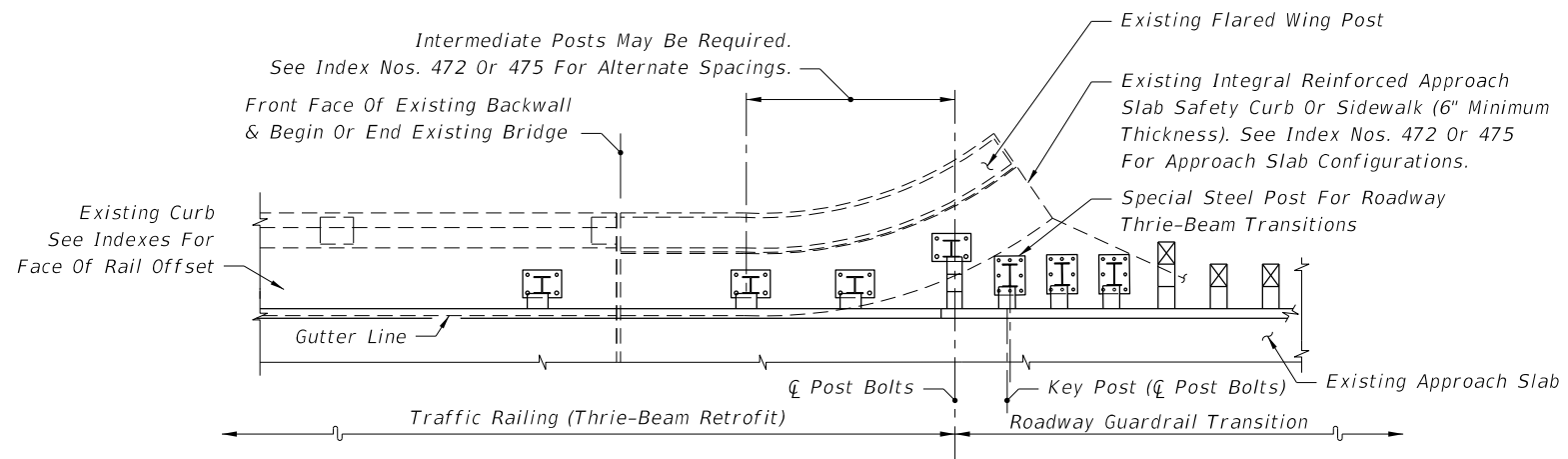

SEE INDEX NOS. 472 & 475 - SCHEMES 3 & 4

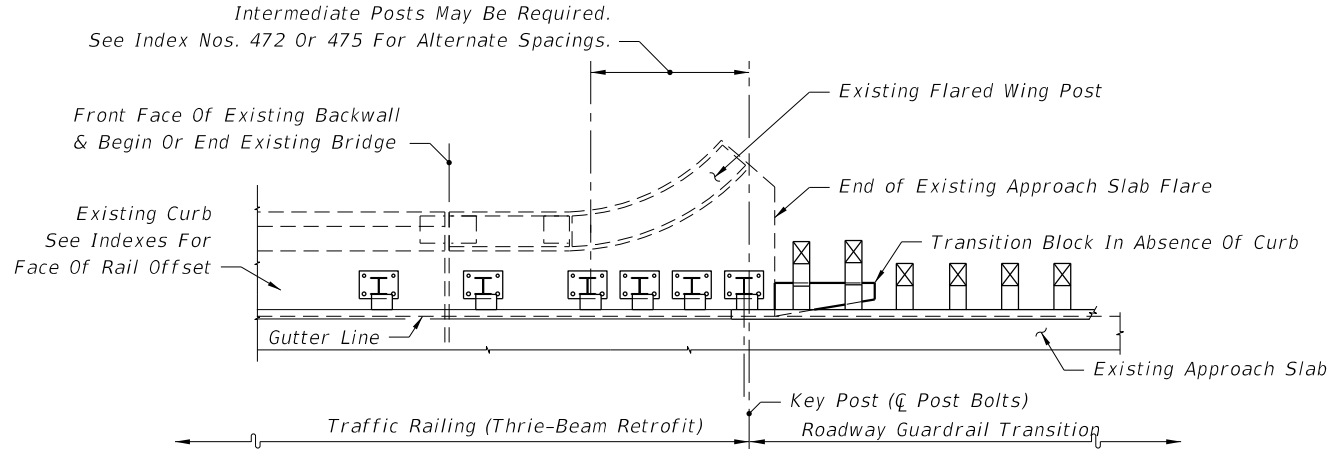

SEE INDEX NOS. 472 & 475 - SCHEMES 5 & 6

PARTIAL PLAN VIEWS OF GUARDRAIL APPROACH TRANSITIONS AND CONNECTIONS FOR BRIDGE TRAFFIC RAILING (THRIE-BEAM RETROFIT)

6/11/2015 9:03:48 AM

LAST REVISION 07/01/07	DESCRIPTION:	 2016 DESIGN STANDARDS	GUARDRAIL TRANSITIONS AND CONNECTIONS FOR EXISTING BRIDGES	INDEX NO. 402	SHEET NO. 4 of 24
---------------------------	--------------	---	--	------------------	----------------------

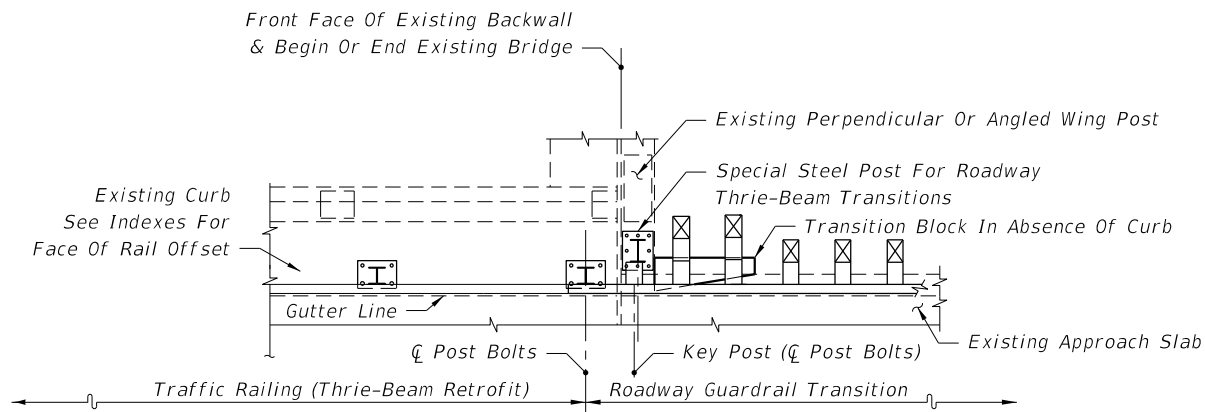

SEE INDEX NOS. 473 & 476 - SCHEME 1

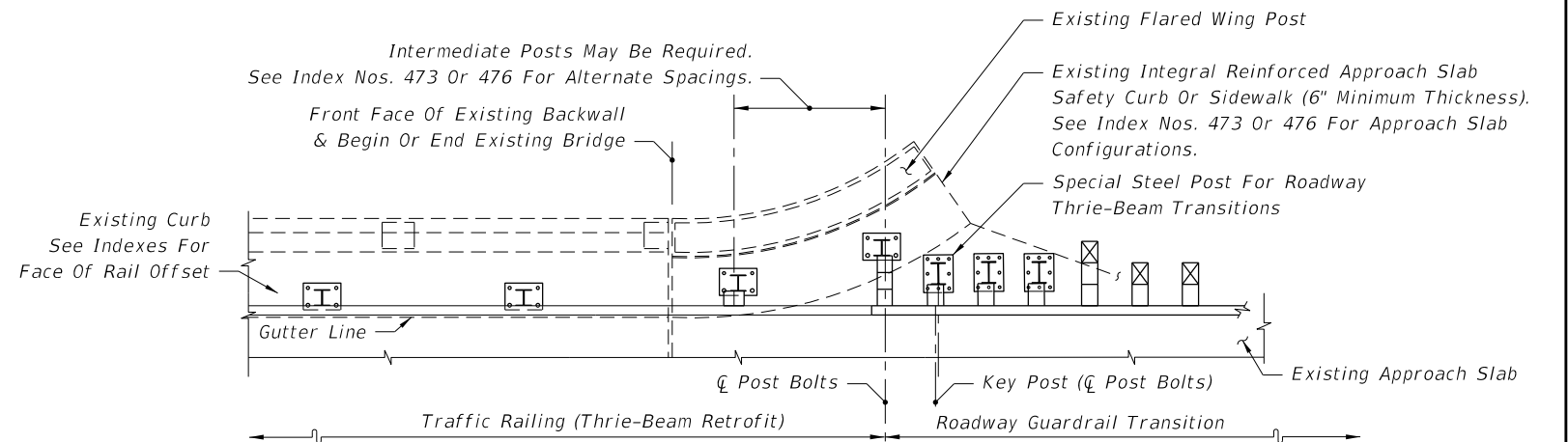

SEE INDEX NOS. 473 & 476 - SCHEMES 3 & 4

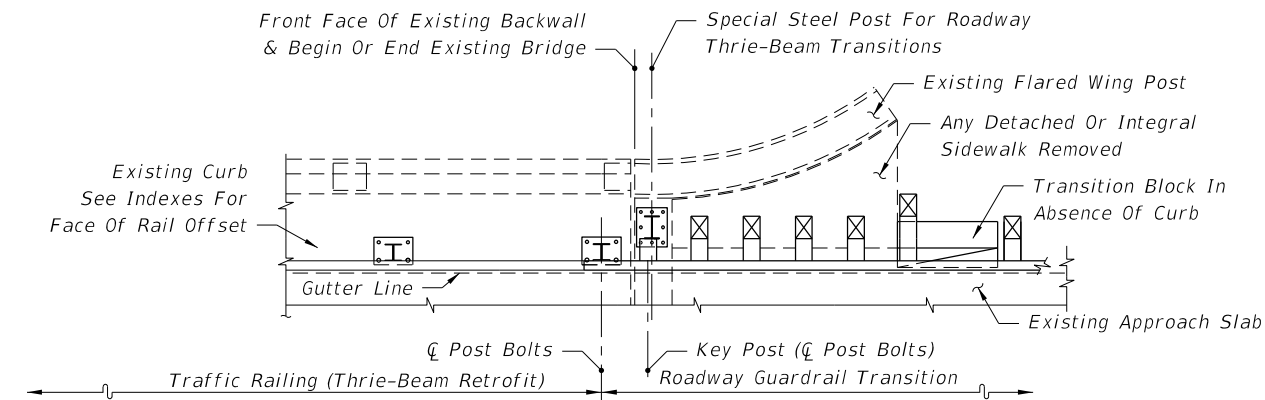

SEE INDEX NOS. 473 & 476 - SCHEME 2

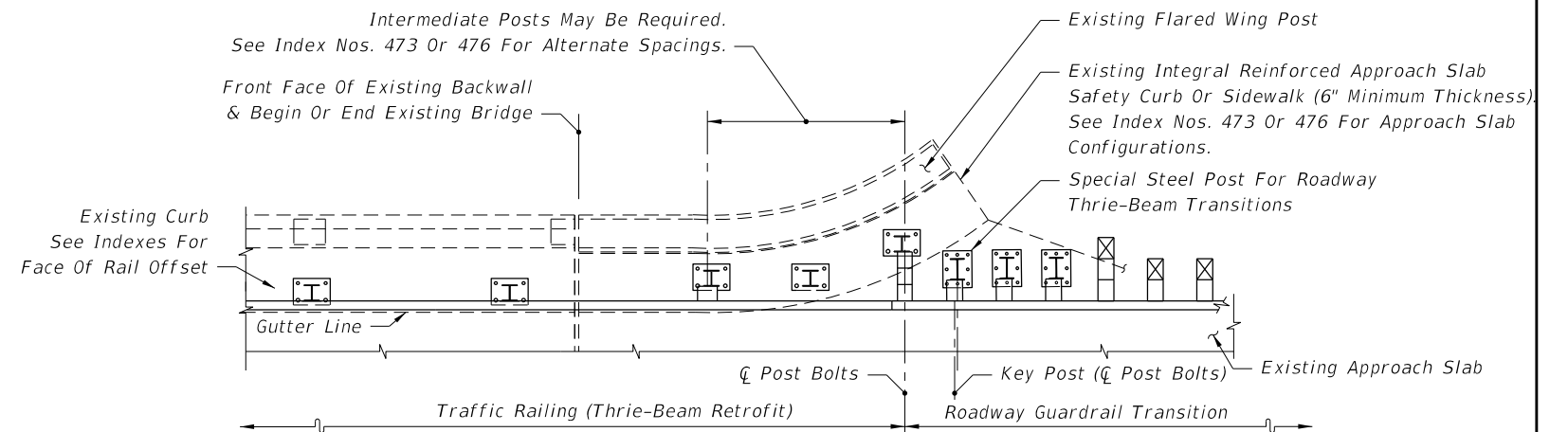

SEE INDEX NOS. 473 & 476 - SCHEMES 3 & 4

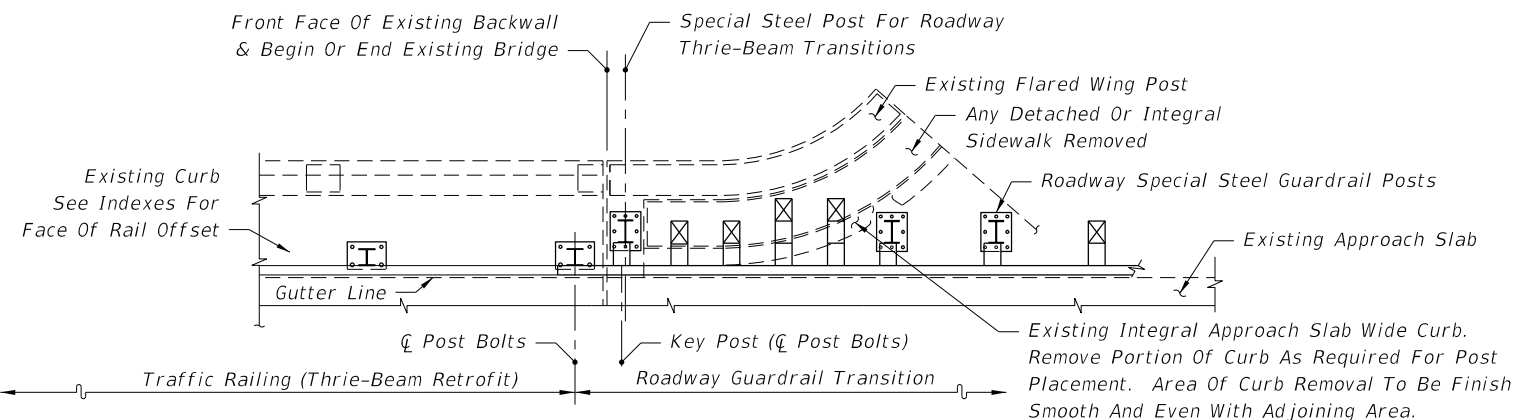

SEE INDEX NOS. 473 & 476 - SCHEME 2

PARTIAL PLAN VIEWS OF GUARDRAIL APPROACH TRANSITIONS AND CONNECTIONS FOR BRIDGE TRAFFIC RAILING (THRIE-BEAM RETROFIT)

11:10:42 AM
6/8/2015

LAST REVISION 07/01/07	DESCRIPTION:
---------------------------	--------------

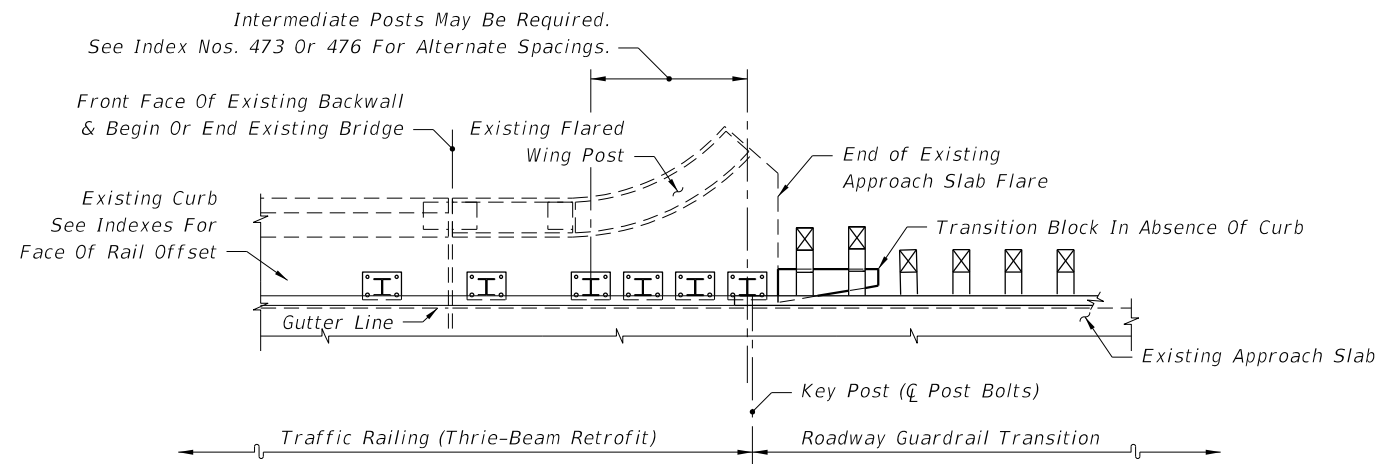

SEE INDEX NOS. 473 & 476 - SCHEMES 5 & 6

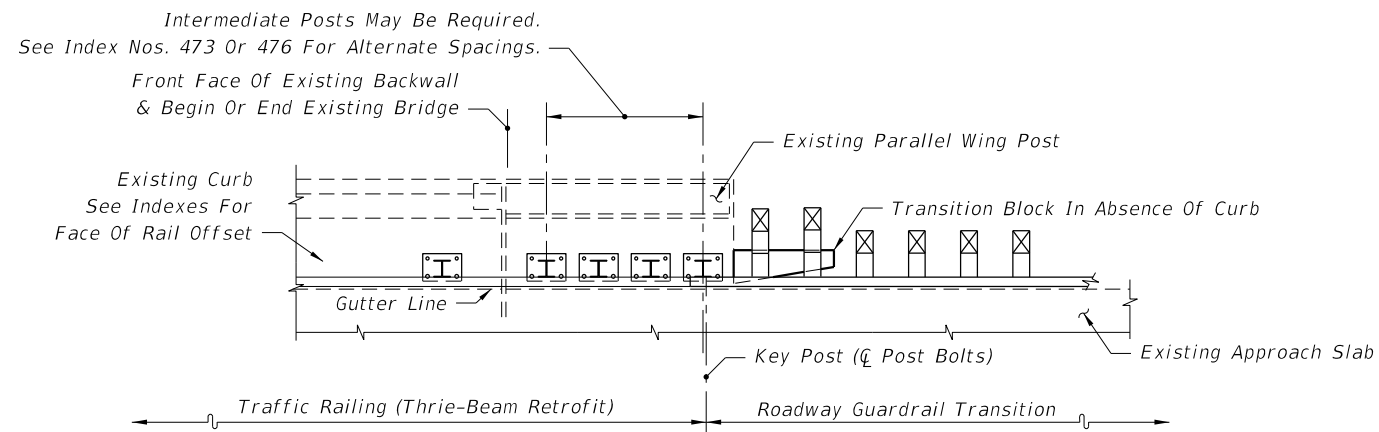

SEE INDEX NOS. 473 & 476 - SCHEMES 5 & 6

PARTIAL PLAN VIEWS OF GUARDRAIL APPROACH TRANSITIONS AND CONNECTIONS
FOR BRIDGE TRAFFIC RAILING (THRIE-BEAM RETROFIT)

6/8/2015 11:10:42 AM

LAST REVISION 07/01/07	REVISION DESCRIPTION:	 2016 DESIGN STANDARDS	GUARDRAIL TRANSITIONS AND CONNECTIONS FOR EXISTING BRIDGES	INDEX NO. 402	SHEET NO. 6 of 24
---------------------------	-----------------------	--	--	------------------	----------------------

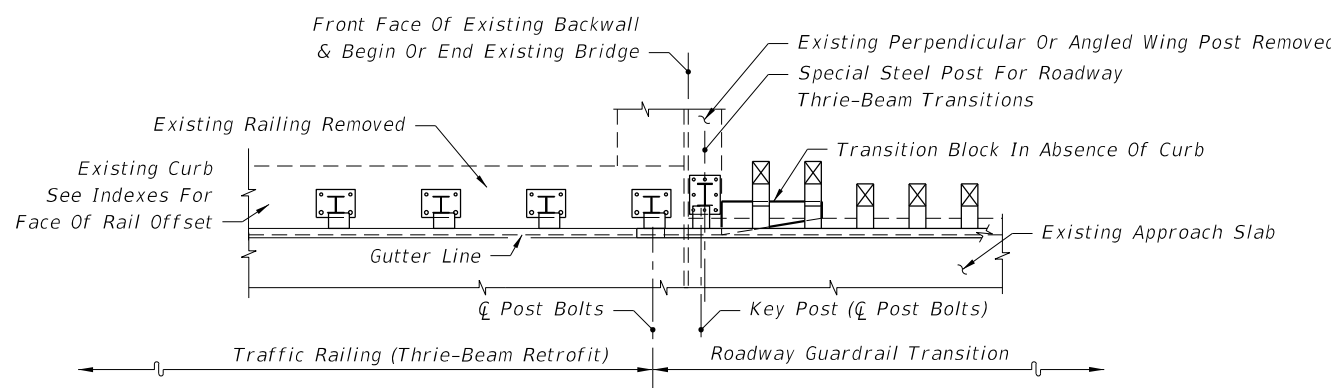

SEE INDEX NO. 474 - SCHEME 1

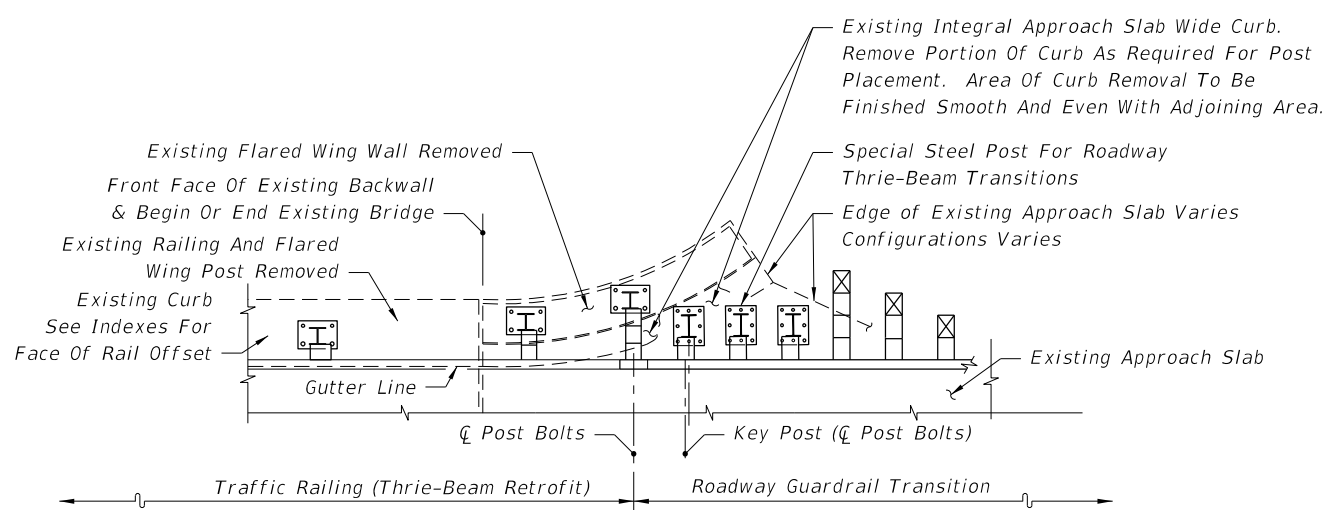

SEE INDEX NO. 474 - SCHEME 3

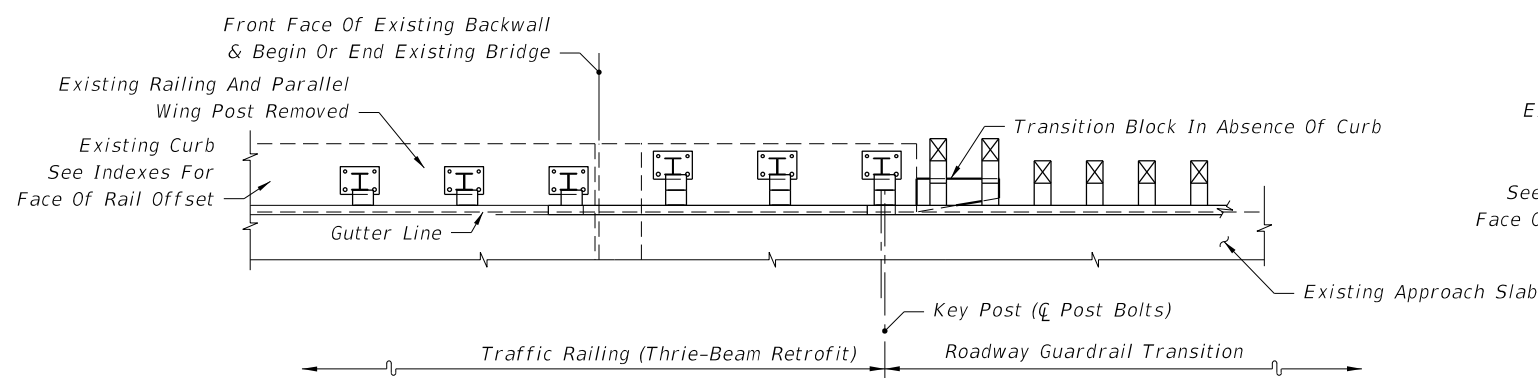

SEE INDEX NO. 474 - SCHEME 2

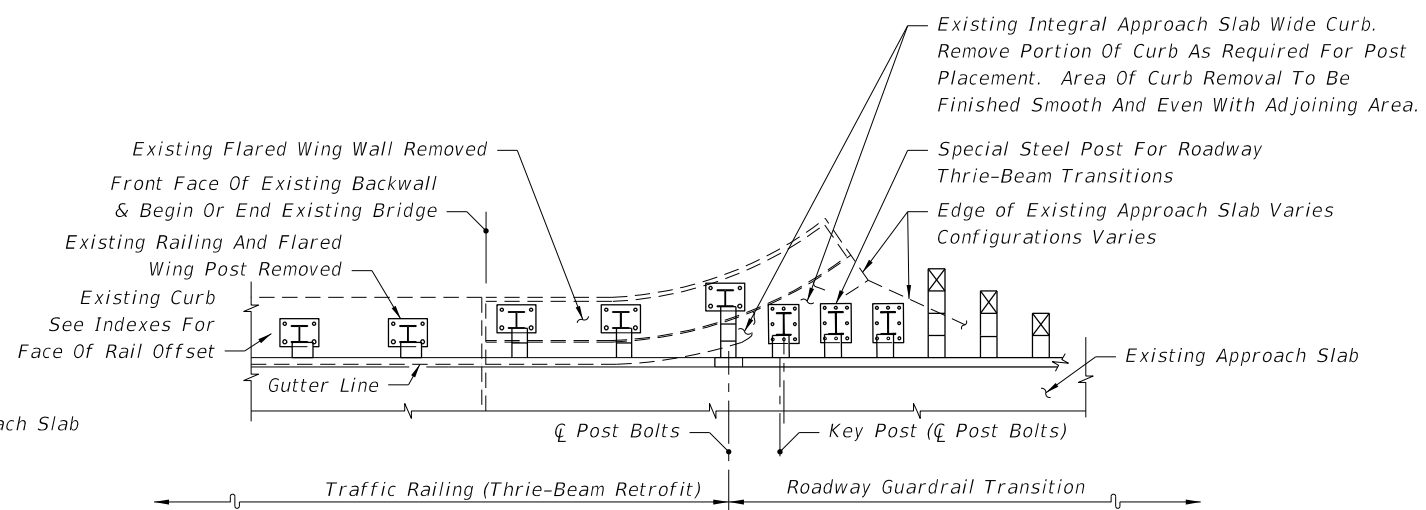

SEE INDEX NO. 474 - SCHEME 3

PARTIAL PLAN VIEWS OF GUARDRAIL APPROACH TRANSITIONS AND CONNECTIONS FOR BRIDGE TRAFFIC RAILING (THRIE-BEAM RETROFIT)

6/8/2015 11:10:43 AM

LAST REVISION 07/01/07	REVISION	DESCRIPTION:	 2016 DESIGN STANDARDS	GUARDRAIL TRANSITIONS AND CONNECTIONS FOR EXISTING BRIDGES	INDEX NO. 402	SHEET NO. 7 of 24
---------------------------	----------	--------------	---	---	-------------------------	-----------------------------

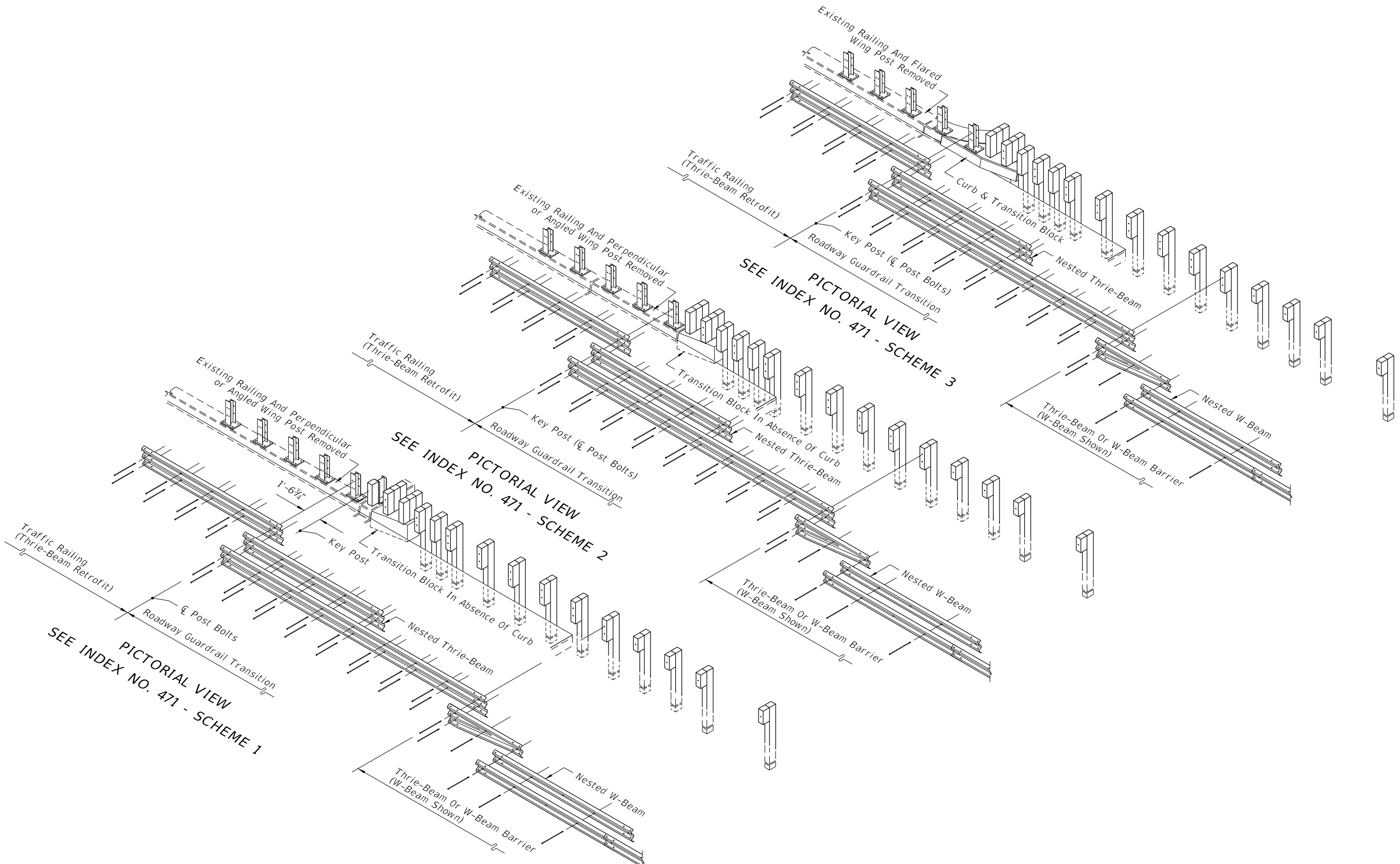

PICTORIAL VIEWS OF GUARDRAIL APPROACH TRANSITIONS AND CONNECTIONS FOR BRIDGE TRAFFIC RAILING (THRIE-BEAM RETROFIT)

6/8/2015 11:10:43 AM

LAST REVISION 07/01/14	DESCRIPTION:	 2016 DESIGN STANDARDS	GUARDRAIL TRANSITIONS AND CONNECTIONS FOR EXISTING BRIDGES	INDEX NO. 402	SHEET NO. 8 of 24
---------------------------	--------------	---	--	------------------	----------------------

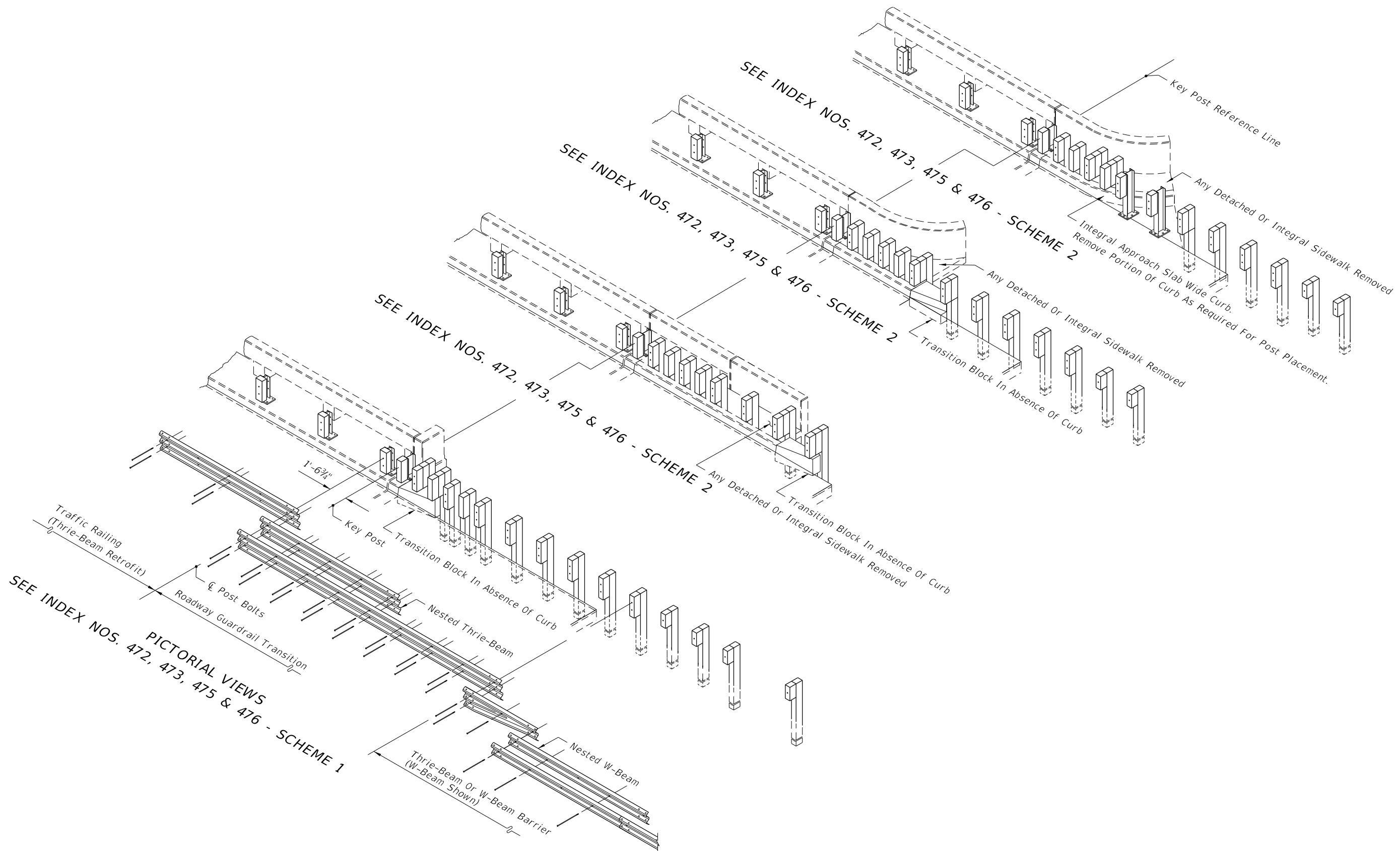

PICTORIAL VIEWS OF GUARDRAIL APPROACH TRANSITIONS AND CONNECTIONS FOR BRIDGE TRAFFIC RAILING (THRIE-BEAM RETROFIT)

6/8/2015 11:10:44 AM

LAST REVISION 07/01/14	REVISION	DESCRIPTION:	 2016 DESIGN STANDARDS	GUARDRAIL TRANSITIONS AND CONNECTIONS FOR EXISTING BRIDGES	INDEX NO. 402	SHEET NO. 9 of 24
---------------------------	----------	--------------	--	---	------------------	----------------------

6/8/2015 11:10:44 AM

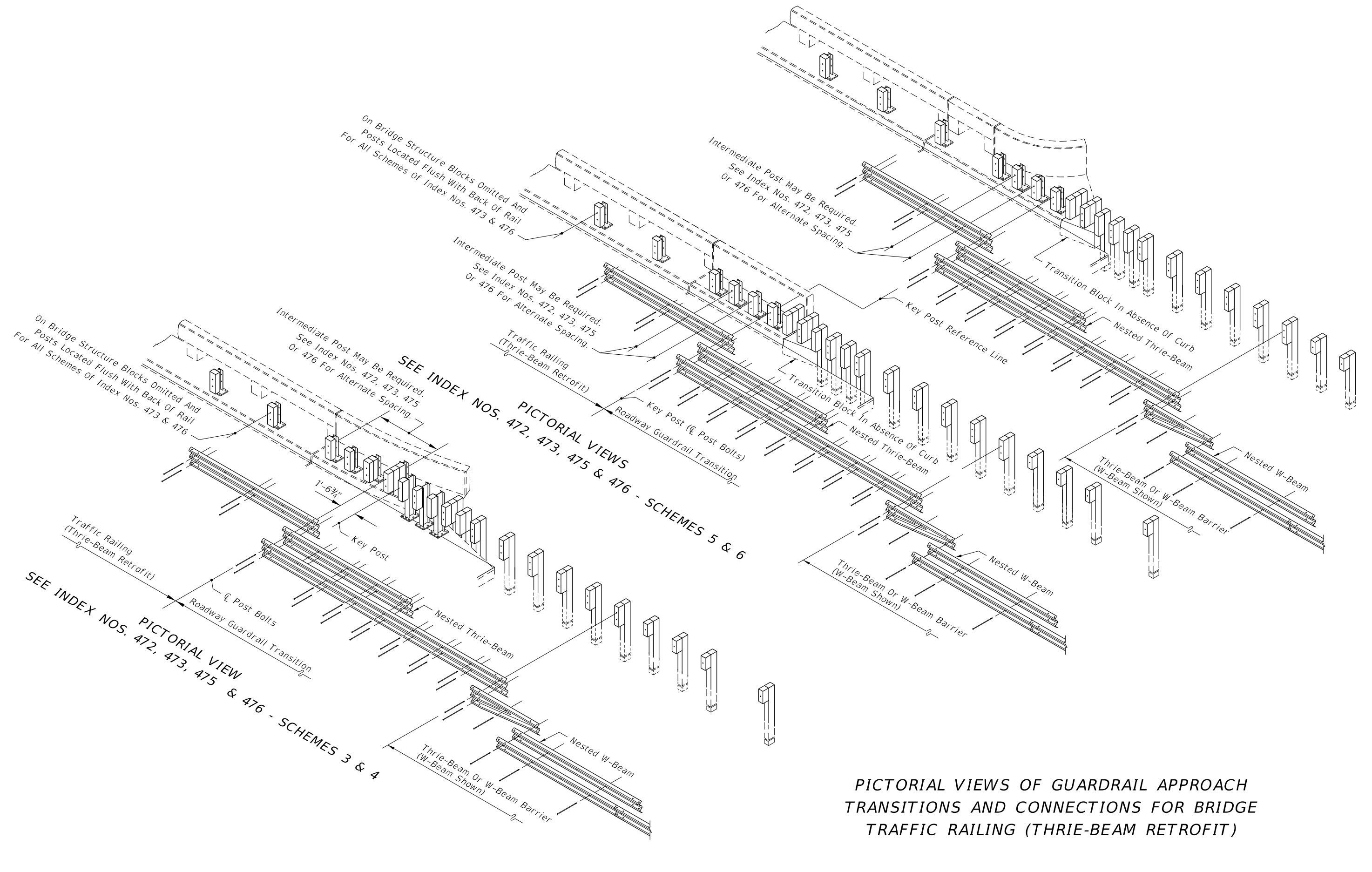

PICTORIAL VIEWS OF GUARDRAIL APPROACH TRANSITIONS AND CONNECTIONS FOR BRIDGE TRAFFIC RAILING (THRIE-BEAM RETROFIT)

LAST REVISION 07/01/14	DESCRIPTION:
---------------------------	--------------



GUARDRAIL TRANSITIONS AND CONNECTIONS FOR EXISTING BRIDGES

INDEX NO. 402	SHEET NO. 10 of 24
------------------	-----------------------

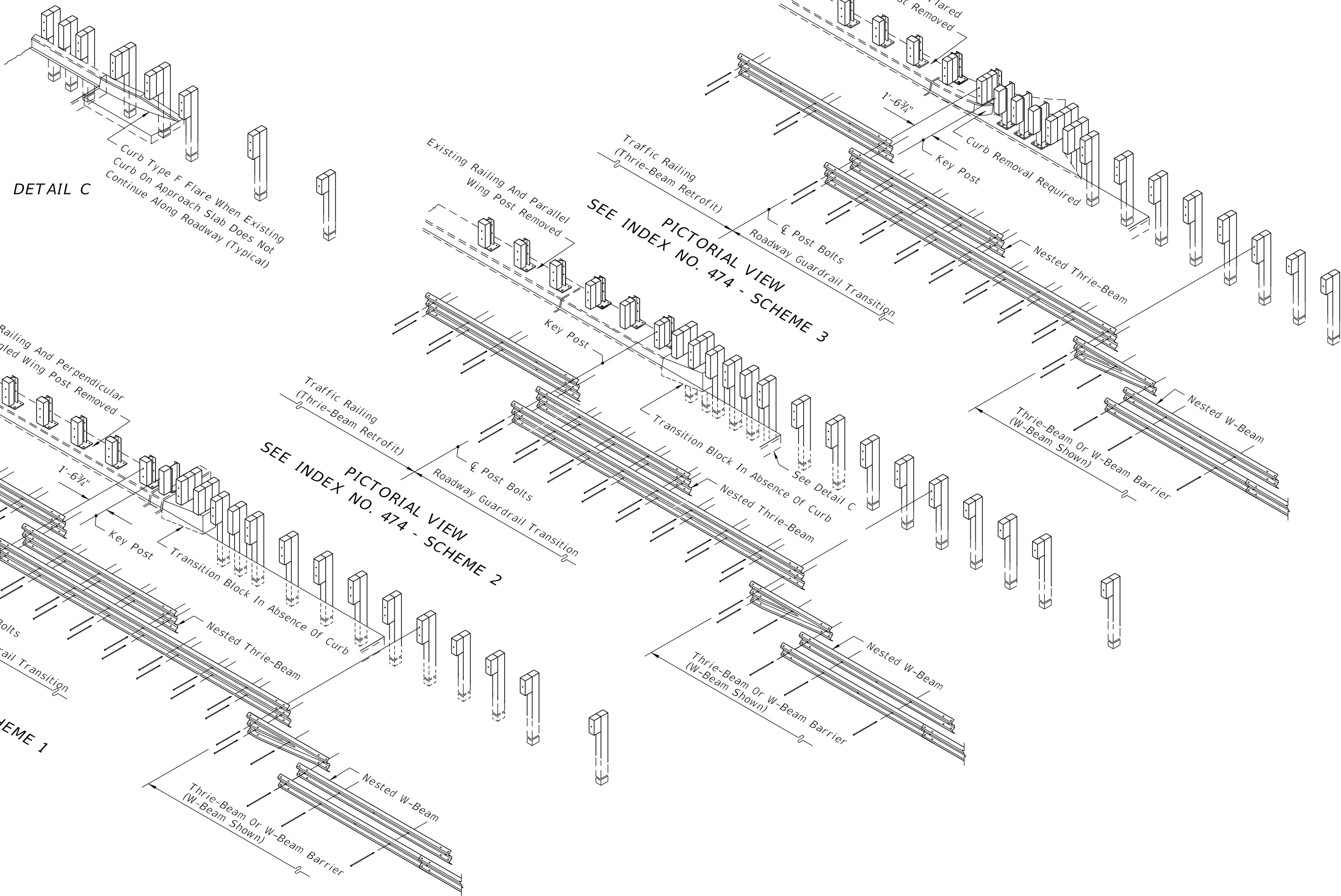

PICTORIAL VIEWS OF GUARDRAIL APPROACH TRANSITIONS AND CONNECTIONS FOR BRIDGE TRAFFIC RAILING (THRIE-BEAM RETROFIT)

6/8/2015 11:10:45 AM

LAST REVISION 07/01/14	REVISION	DESCRIPTION:
---------------------------	----------	--------------



GUARDRAIL TRANSITIONS AND CONNECTIONS FOR EXISTING BRIDGES

INDEX NO. 402	SHEET NO. 11 of 24
------------------	-----------------------

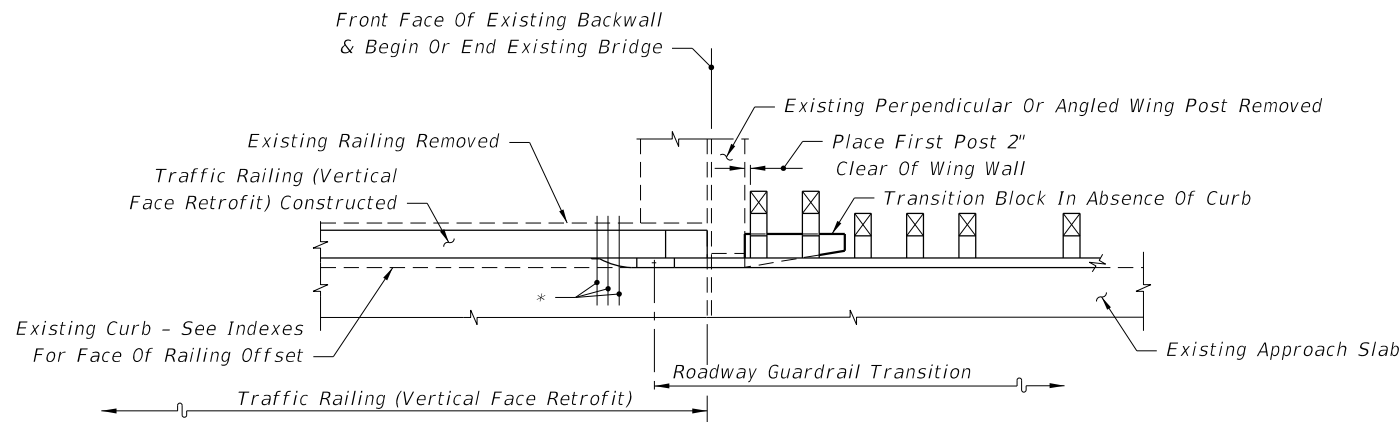

SEE INDEX NO. 481 - SCHEME 1

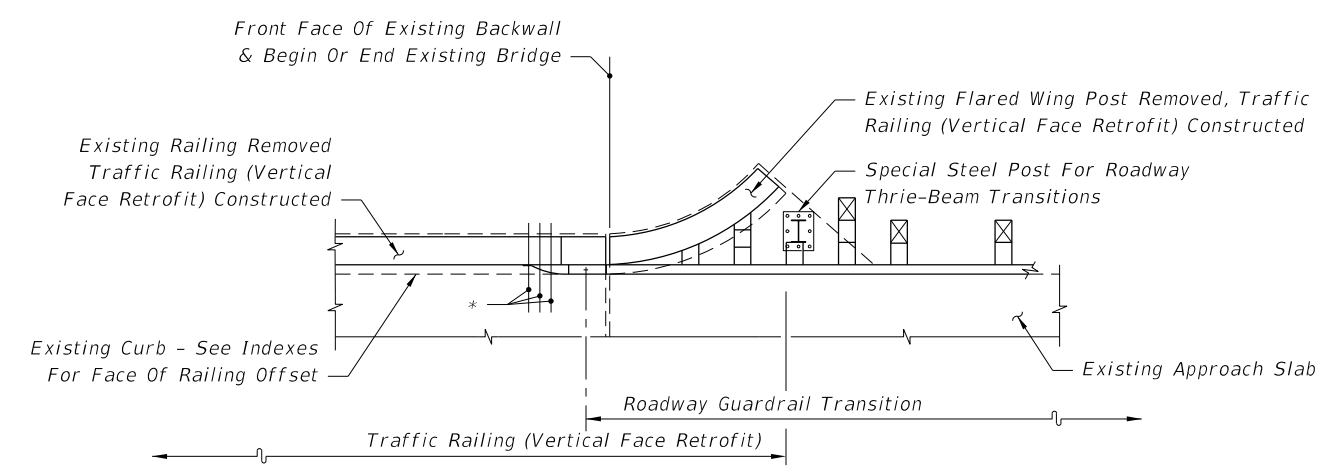

SEE INDEX NO. 481 - SCHEME 3

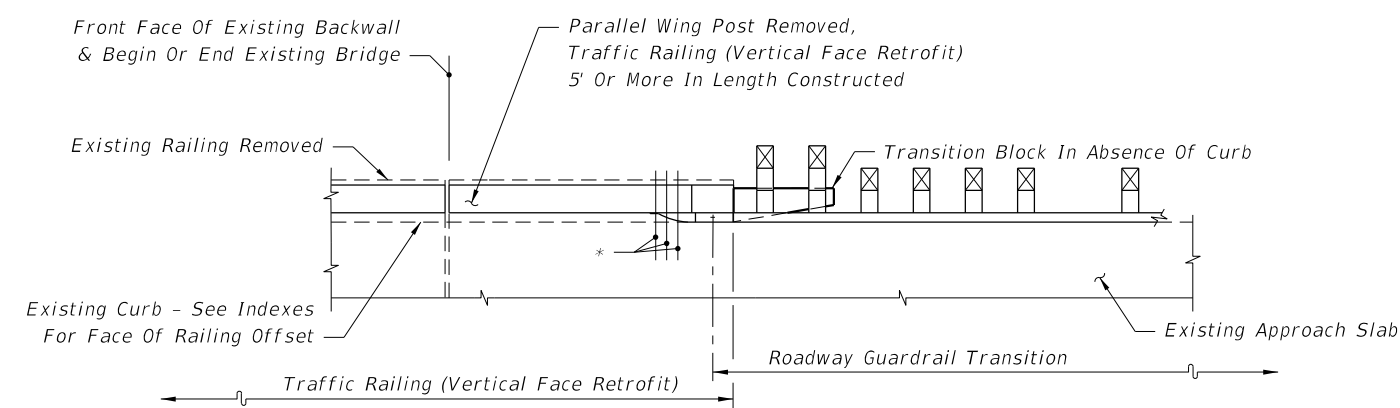

SEE INDEX NO. 481 - SCHEME 2

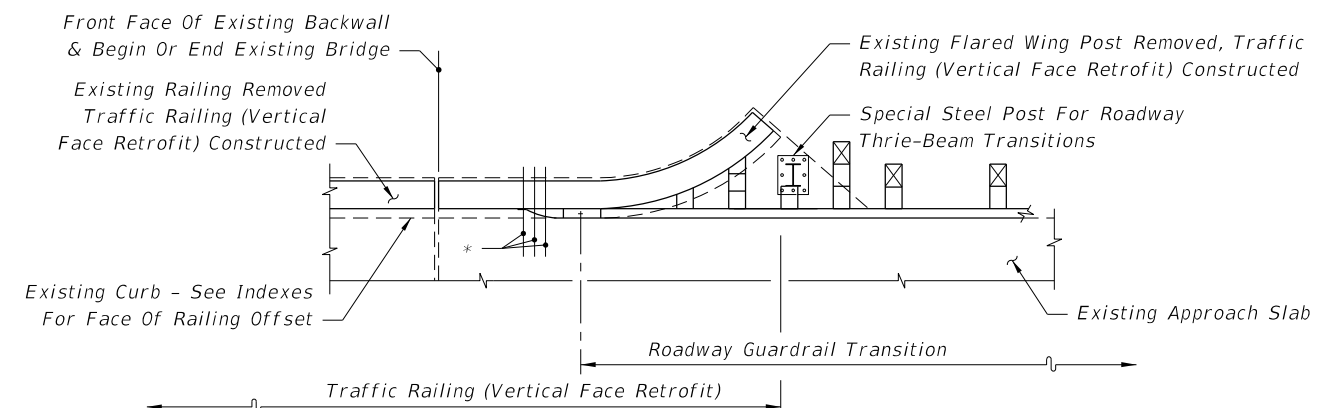

SEE INDEX NO. 481 - SCHEME 3

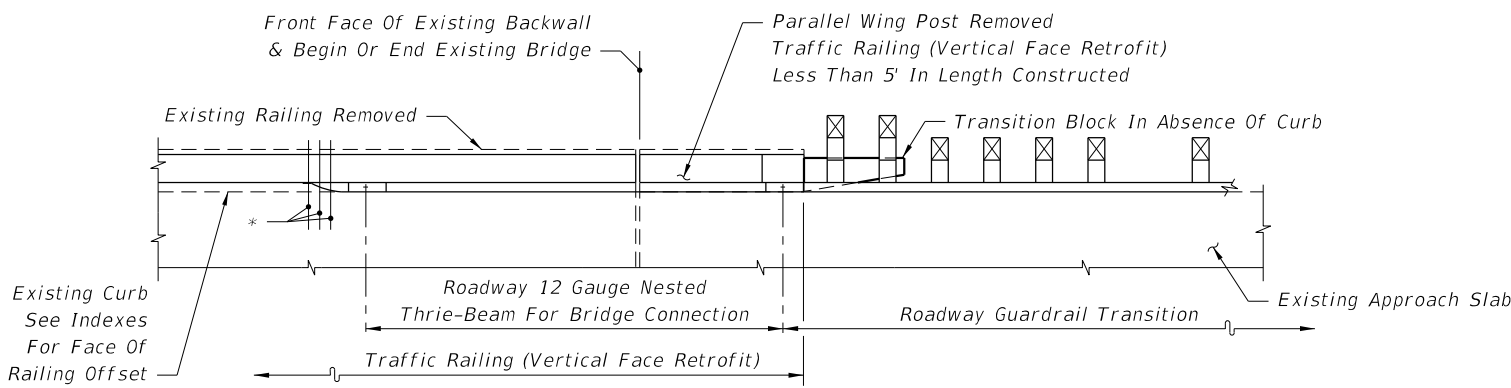

SEE INDEX NO. 481 - SCHEME 2

Note:
 * 21" x 12" x 5/8" Thrie-Beam Terminal Connector Plate (Back-Up Plate), And 7/8"Ø x 12" Long HS
 Hex Bolts And Nuts (5 Reqd.) With 2 1/4" OD Plain Round Washers Under Heads And Nuts

PARTIAL PLAN VIEWS OF TRAFFIC RAILING (VERTICAL FACE RETROFIT)

6/8/2015 11:10:46 AM

LAST REVISION 07/01/07	REVISION	DESCRIPTION:	 2016 DESIGN STANDARDS	GUARDRAIL TRANSITIONS AND CONNECTIONS FOR EXISTING BRIDGES	INDEX NO. 402	SHEET NO. 12 of 24
---------------------------	----------	--------------	--	---	-------------------------	------------------------------

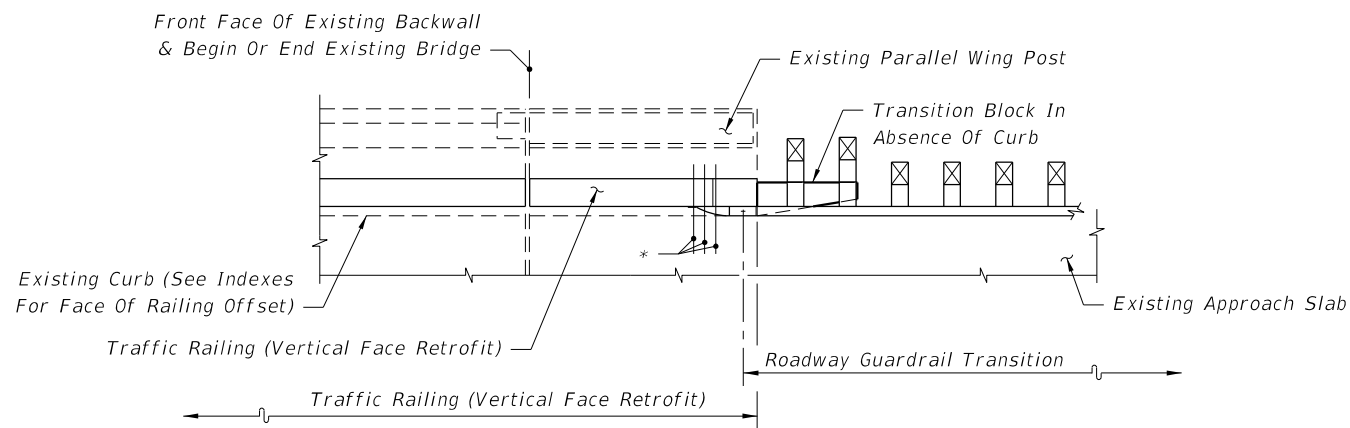

SEE INDEX NOS. 405 OR 482 - SCHEME 2

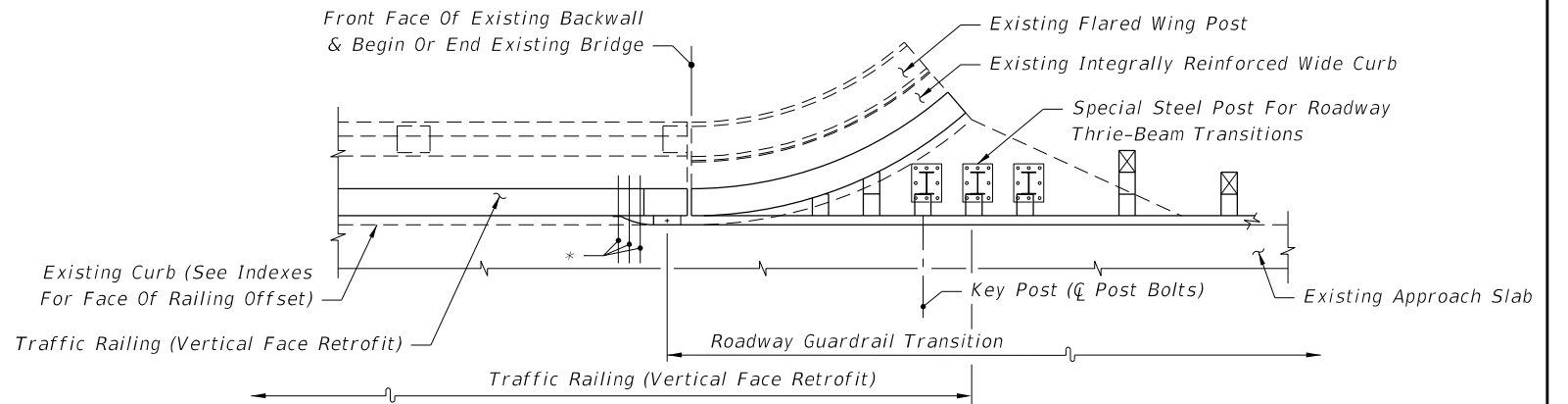

SEE INDEX NOS. 405 OR 482 - SCHEME 3

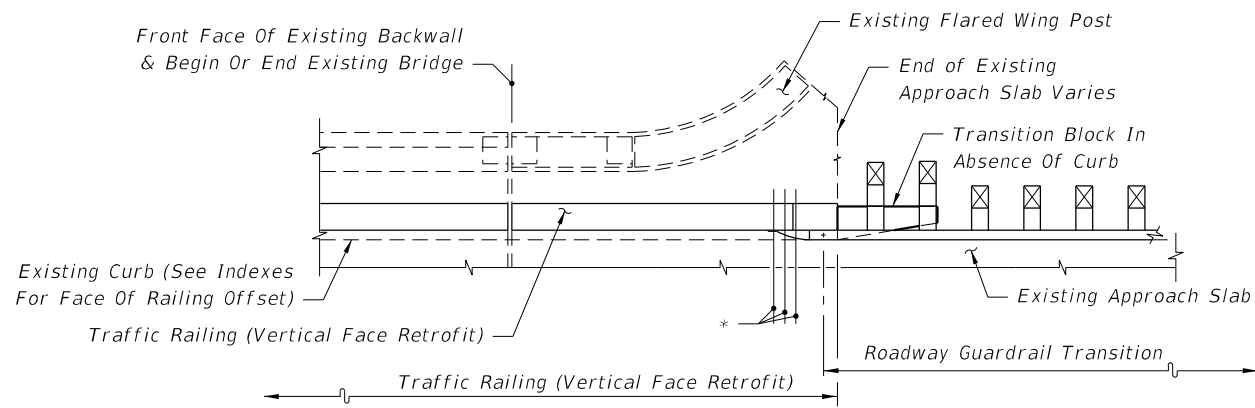

SEE INDEX NOS. 405 OR 482 - SCHEME 2

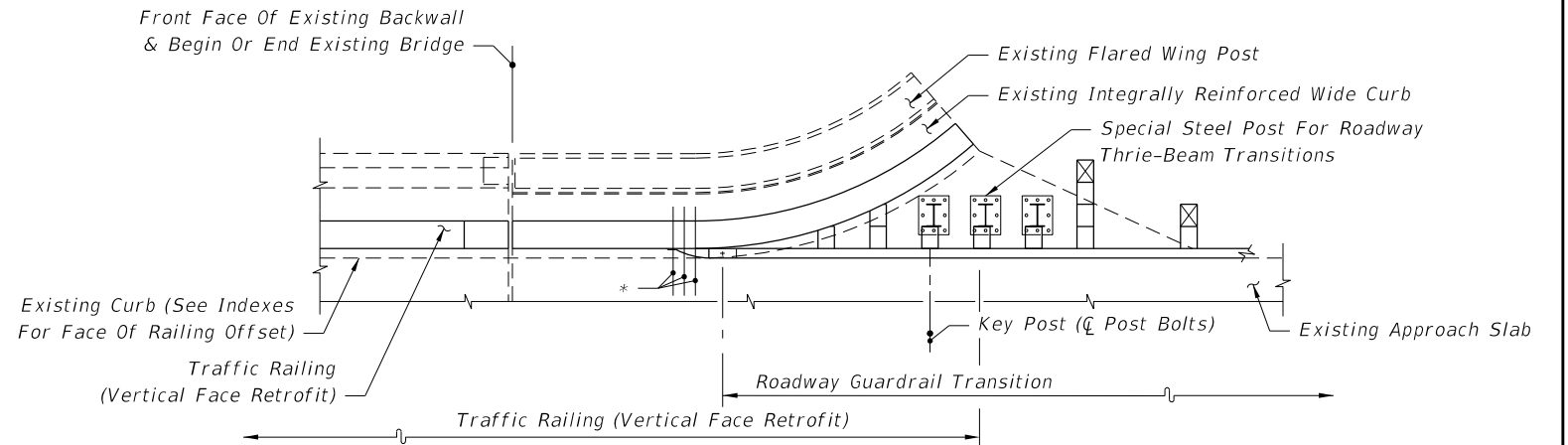

SEE INDEX NOS. 405 OR 482 - SCHEME 3

Note:
 *21" x 12" x 5/8" Thrie-Beam Terminal Connector Plate (Back-Up Plate), And 7/8"Ø x 12" Long
 HS Hex Bolts And Nuts (5 Reqd.) With 2 1/4" OD Plain Round Washers Under Heads And Nuts

PARTIAL PLAN VIEWS OF TRAFFIC RAILING (VERTICAL FACE RETROFIT)
 (INDEX 482 SHOWN, INDEX 405 SIMILAR)

6/8/2015 11:10:46 AM

LAST REVISION 07/01/13	REVISION	DESCRIPTION:	 2016 DESIGN STANDARDS	GUARDRAIL TRANSITIONS AND CONNECTIONS FOR EXISTING BRIDGES	INDEX NO. 402	SHEET NO. 13 of 24
---------------------------	----------	--------------	---	---	------------------	-----------------------

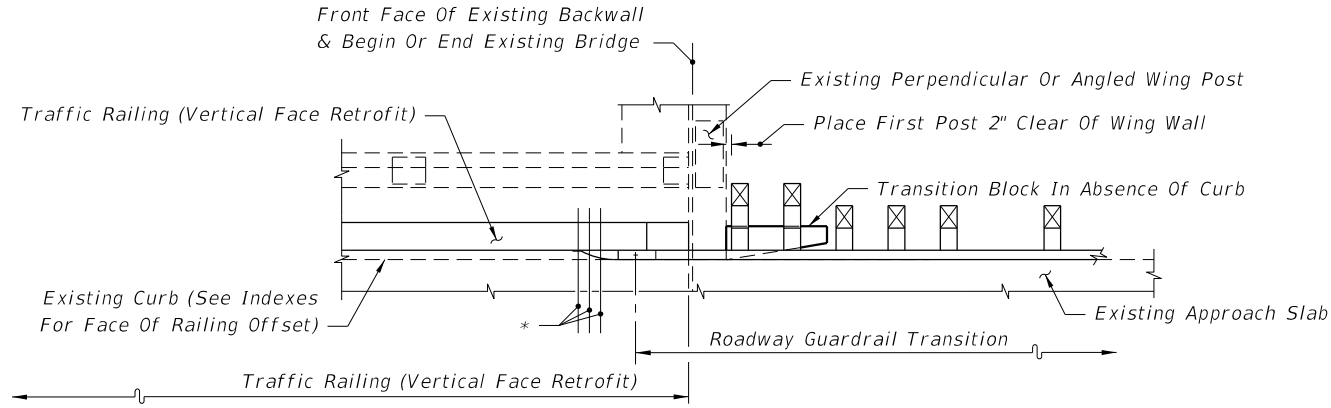

SEE INDEX NOS. 405 OR 482 - SCHEME 1

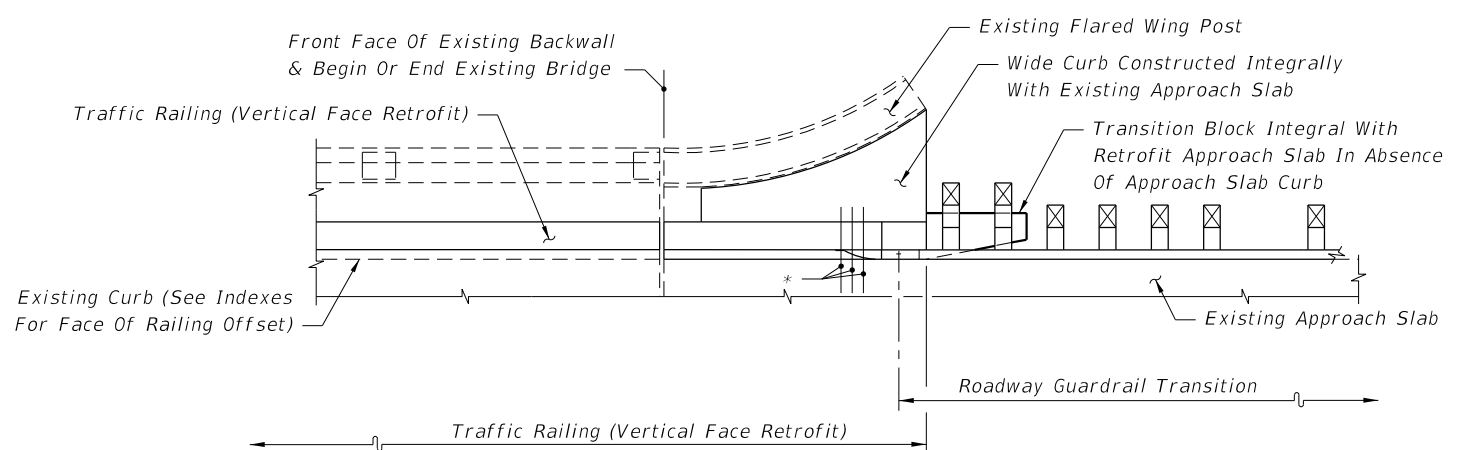

SEE INDEX NOS. 405 OR 482 - SCHEME 5

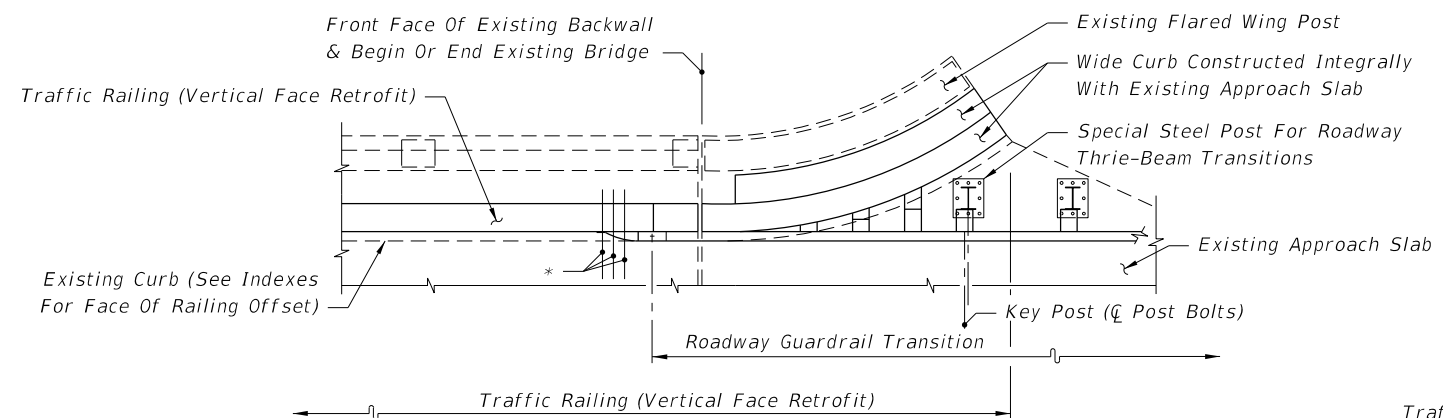

SEE INDEX NOS. 405 OR 482 - SCHEME 4

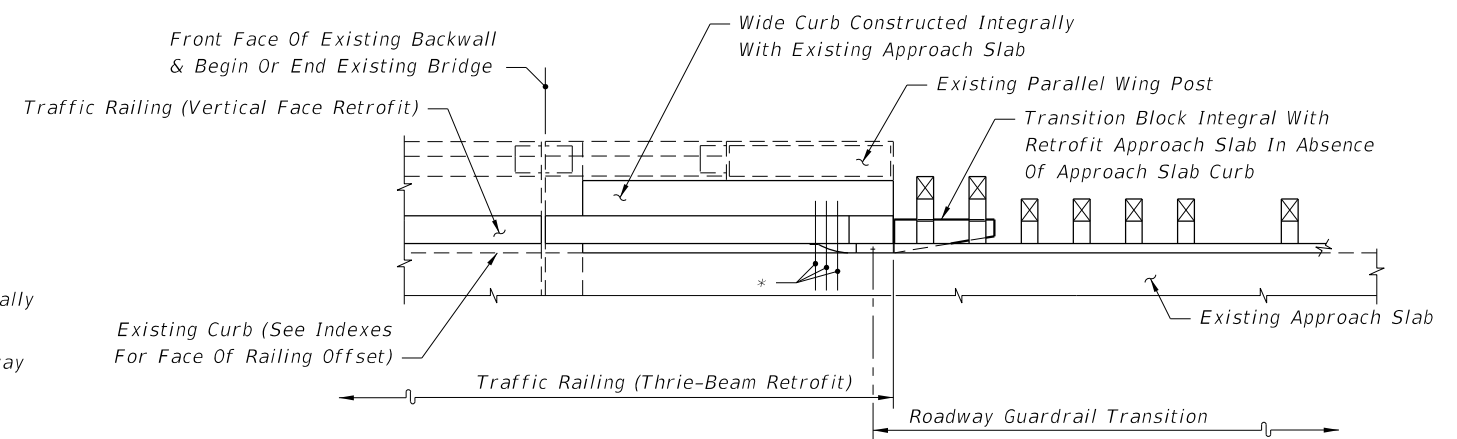

SEE INDEX NOS. 405 OR 482 - SCHEME 5

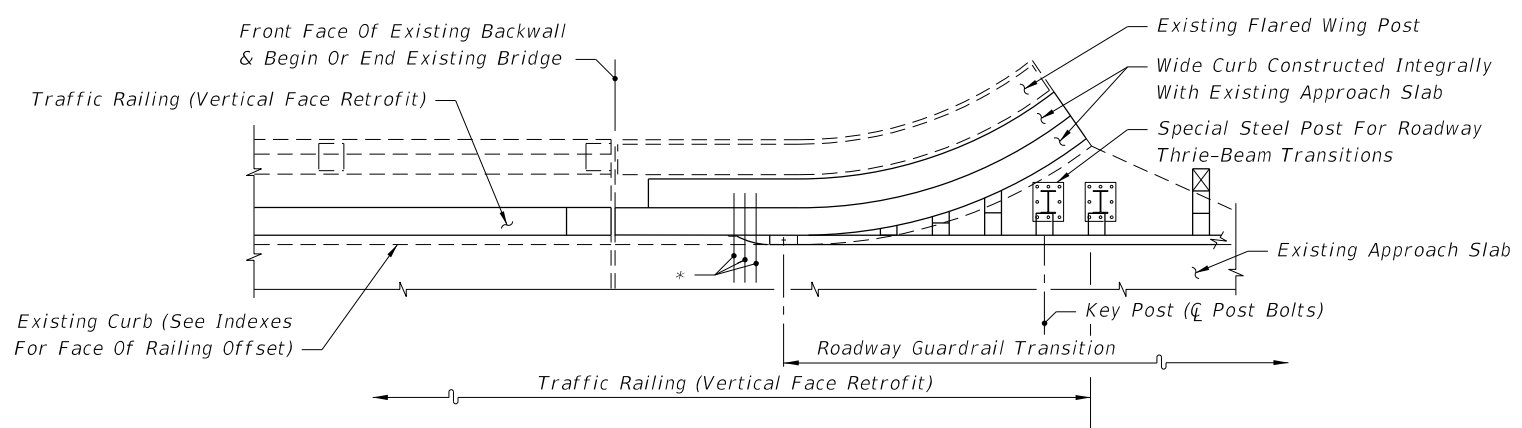

SEE INDEX NOS. 405 OR 482 - SCHEME 4

Note:
 * 21" x 12" x 5/8" Thrie-Beam Terminal Connector Plate (Back-Up Plate), And 7/8"Ø x 12" Long HS Hex Bolts And Nuts (5 Req'd.) With 2 1/4" OD Plain Round Washers Under Heads And Nuts

PARTIAL PLAN VIEWS OF TRAFFIC RAILING (VERTICAL FACE RETROFIT)
 (INDEX 482 SHOWN, INDEX 405 SIMILAR)

6/8/2015 11:10:47 AM

LAST REVISION 07/01/13	REVISION	DESCRIPTION:	 2016 DESIGN STANDARDS	GUARDRAIL TRANSITIONS AND CONNECTIONS FOR EXISTING BRIDGES	INDEX NO. 402	SHEET NO. 14 of 24
---------------------------	----------	--------------	--	---	------------------	-----------------------

6/8/2015 11:10:47 AM

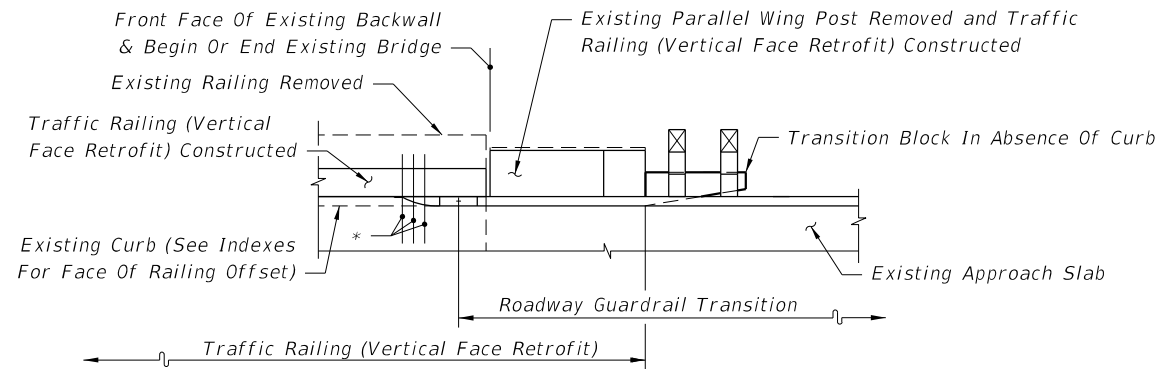

SEE INDEX NO. 483 - SCHEME 2

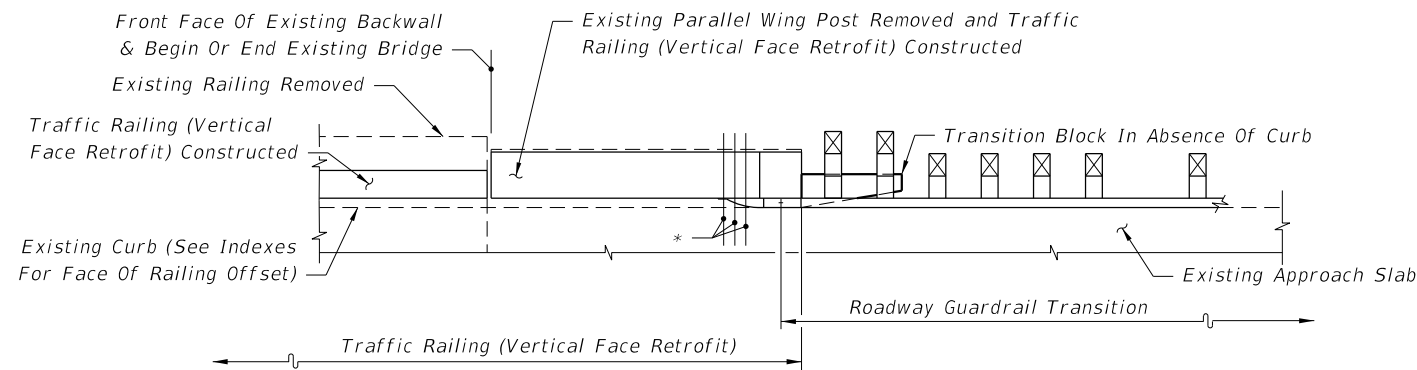

SEE INDEX NO. 483 - SCHEME 2

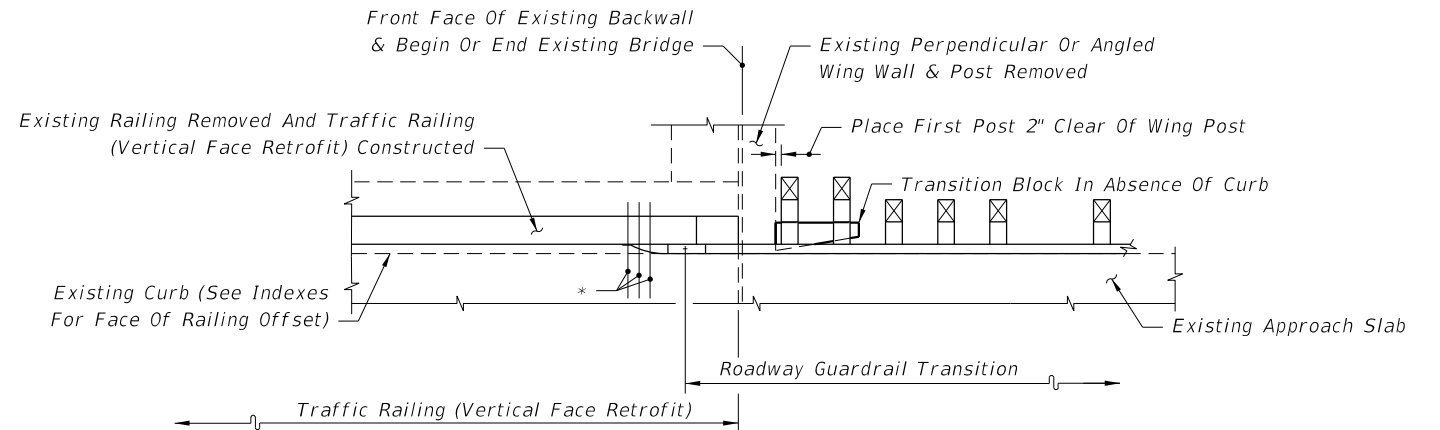

SEE INDEX NO. 483 - SCHEME 1

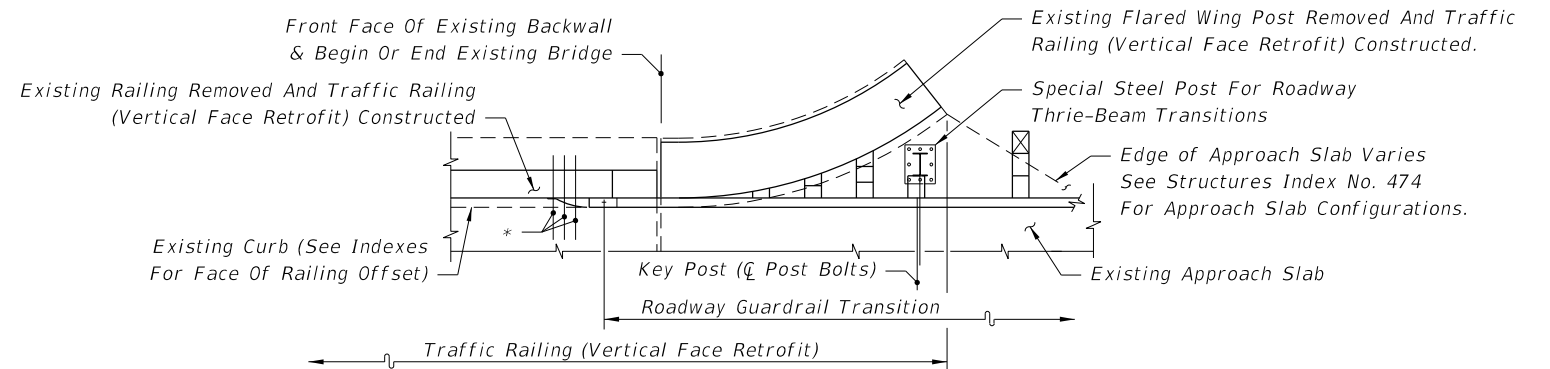

SEE INDEX NO. 483 - SCHEME 3

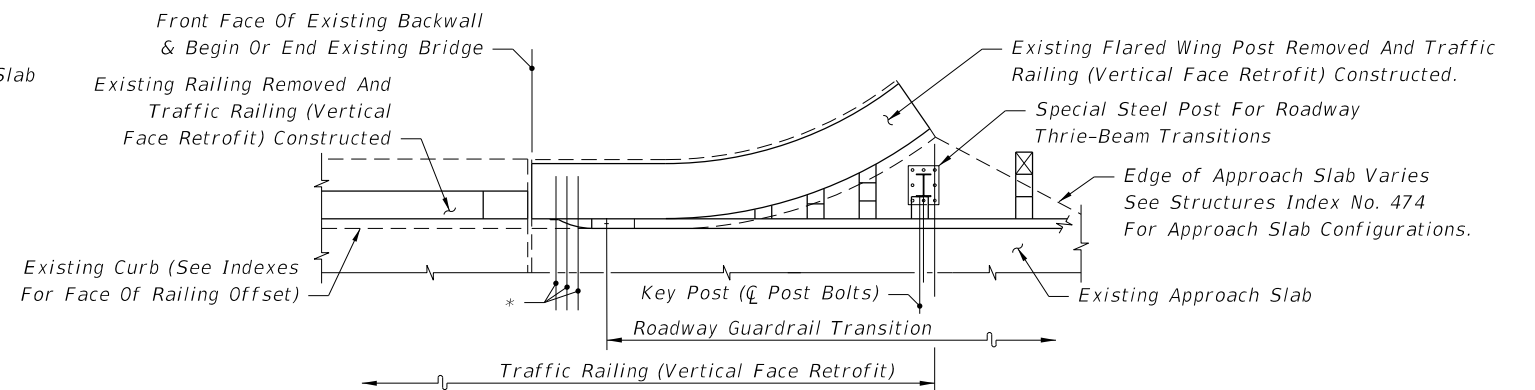

SEE INDEX NO. 483 - SCHEME 3

Note:

* 21" x 12" x 5/8" Thrie-Beam Terminal Connector Plate (Back-Up Plate), And 7/8"⌀ HS Hex Bolts And Nuts (12" Long For Scheme 1 And Length To Fit For Schemes 2 And 3) (5 Reqd.) With 2 1/4" OD Plain Round Washers Under Heads And Nuts

PARTIAL PLAN VIEWS OF TRAFFIC RAILING (VERTICAL FACE RETROFIT)

LAST REVISION 07/01/07	DESCRIPTION:
---------------------------	--------------



GUARDRAIL TRANSITIONS AND CONNECTIONS FOR EXISTING BRIDGES

INDEX NO. 402	SHEET NO. 15 of 24
------------------	-----------------------

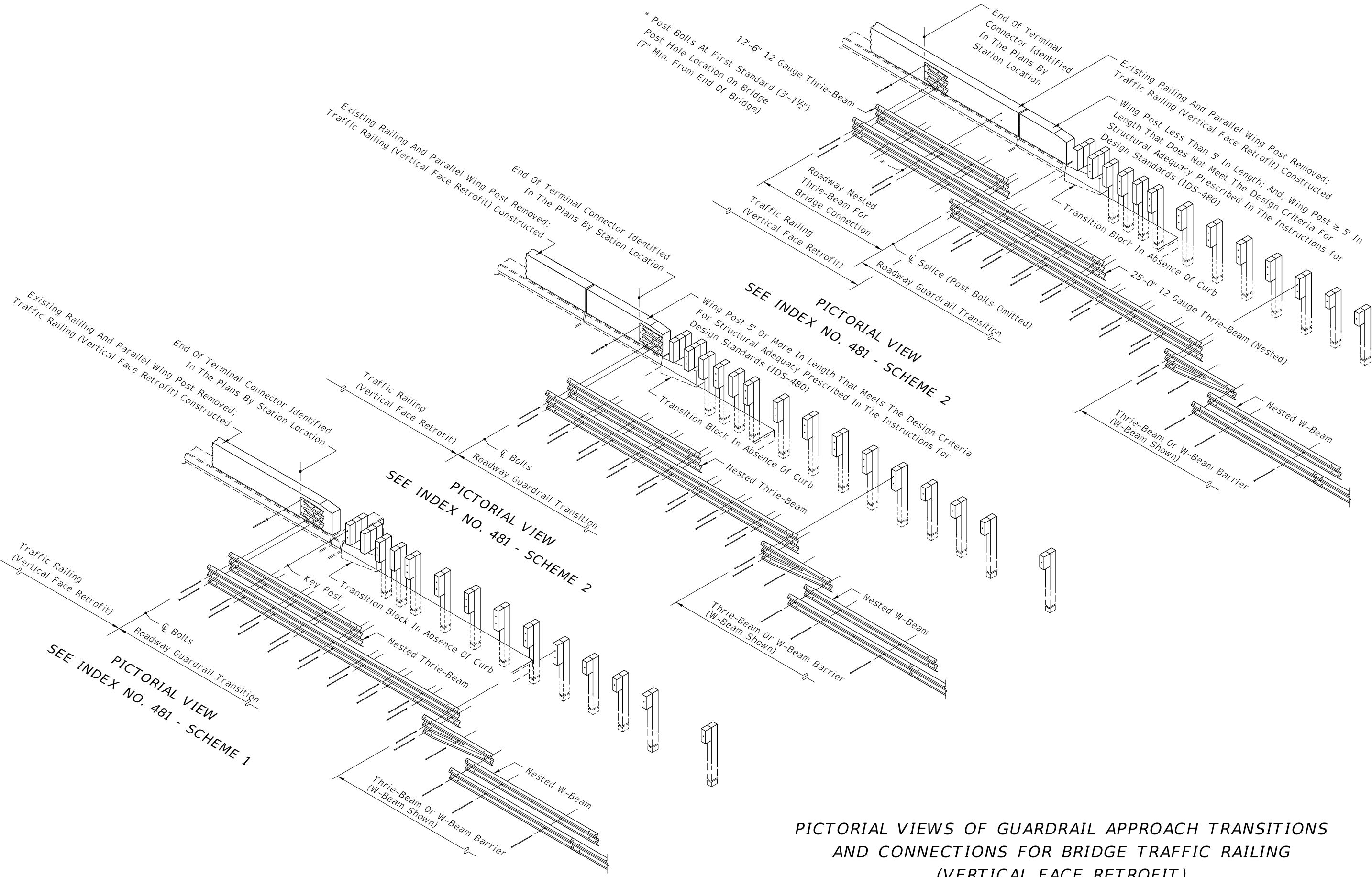

**PICTORIAL VIEWS OF GUARDRAIL APPROACH TRANSITIONS
 AND CONNECTIONS FOR BRIDGE TRAFFIC RAILING
 (VERTICAL FACE RETROFIT)**

11:10:48 AM
 6/8/2015

LAST REVISION 07/01/14	DESCRIPTION: 	 2016 DESIGN STANDARDS	GUARDRAIL TRANSITIONS AND CONNECTIONS FOR EXISTING BRIDGES	INDEX NO. 402	SHEET NO. 16 of 24
---------------------------	----------------------	---	---	------------------	-----------------------

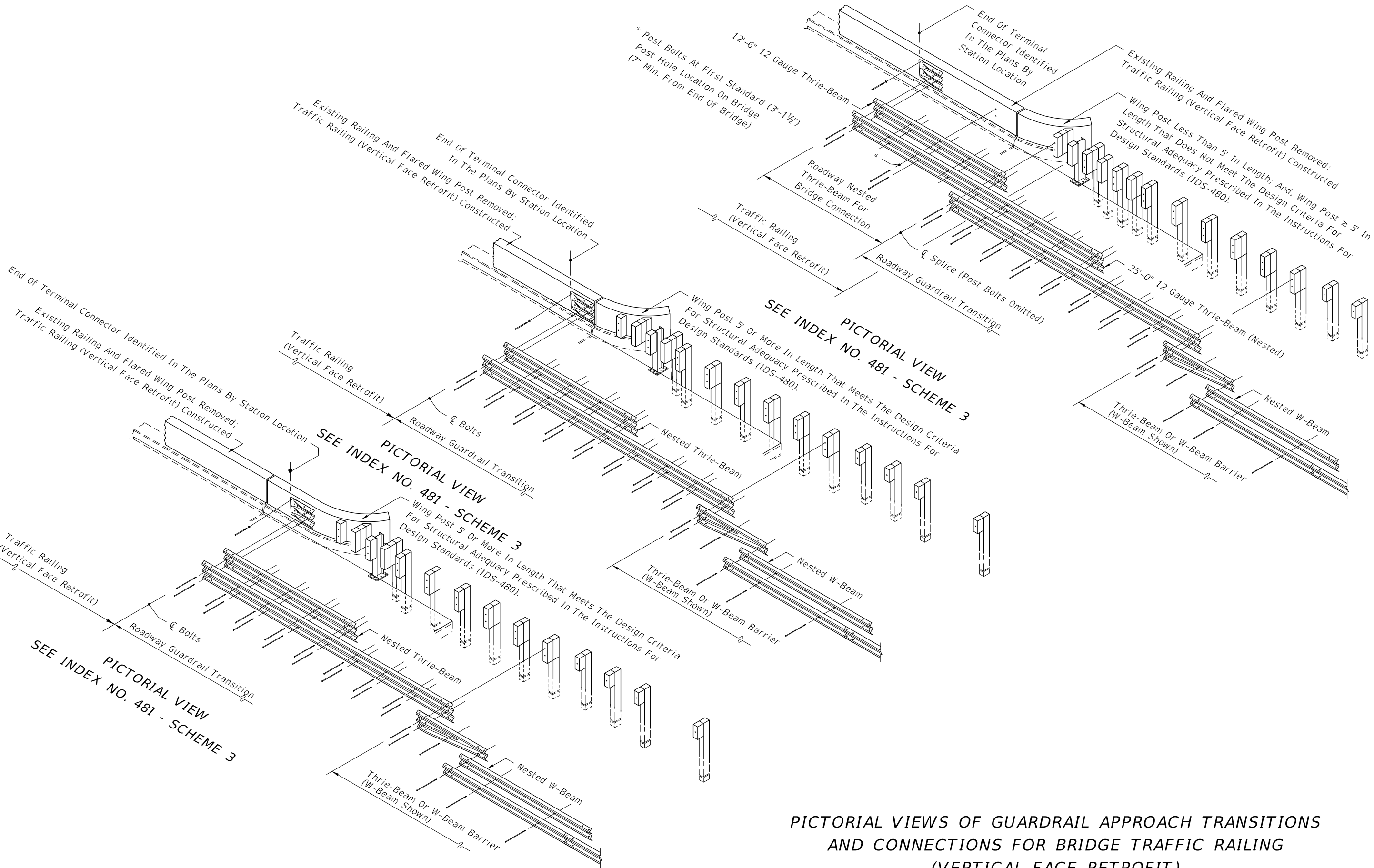

PICTORIAL VIEWS OF GUARDRAIL APPROACH TRANSITIONS AND CONNECTIONS FOR BRIDGE TRAFFIC RAILING (VERTICAL FACE RETROFIT)

6/8/2015 11:10:48 AM

LAST REVISION 07/01/14	DESCRIPTION:	 2016 DESIGN STANDARDS	GUARDRAIL TRANSITIONS AND CONNECTIONS FOR EXISTING BRIDGES	INDEX NO. 402	SHEET NO. 17 of 24
---------------------------	--------------	---	--	------------------	-----------------------

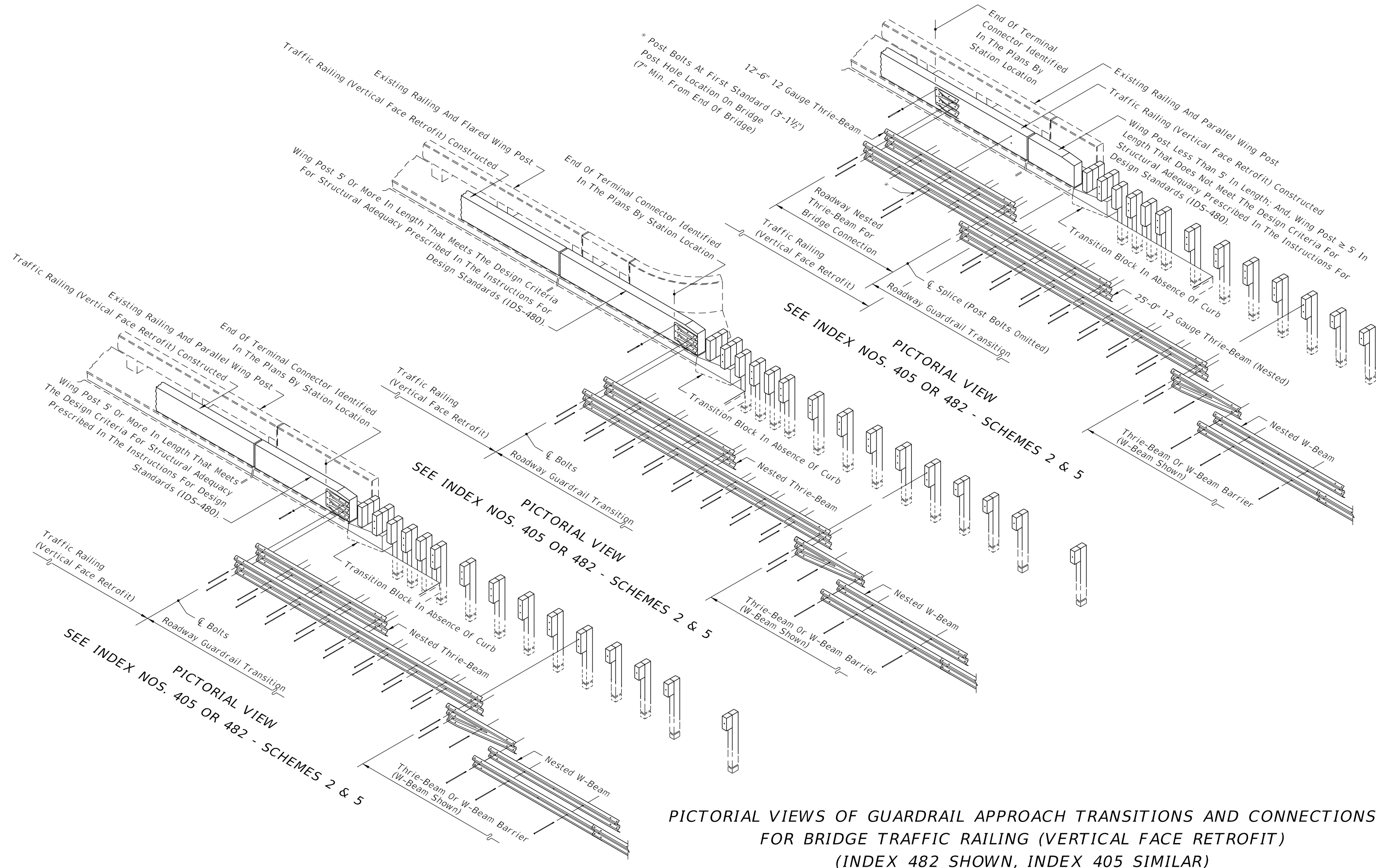

PICTORIAL VIEWS OF GUARDRAIL APPROACH TRANSITIONS AND CONNECTIONS FOR BRIDGE TRAFFIC RAILING (VERTICAL FACE RETROFIT) (INDEX 482 SHOWN, INDEX 405 SIMILAR)

11:10:49 AM
6/8/2015

LAST REVISION 07/01/14	DESCRIPTION:
---------------------------	--------------



GUARDRAIL TRANSITIONS AND CONNECTIONS FOR EXISTING BRIDGES

INDEX NO. 402	SHEET NO. 18 of 24
------------------	-----------------------

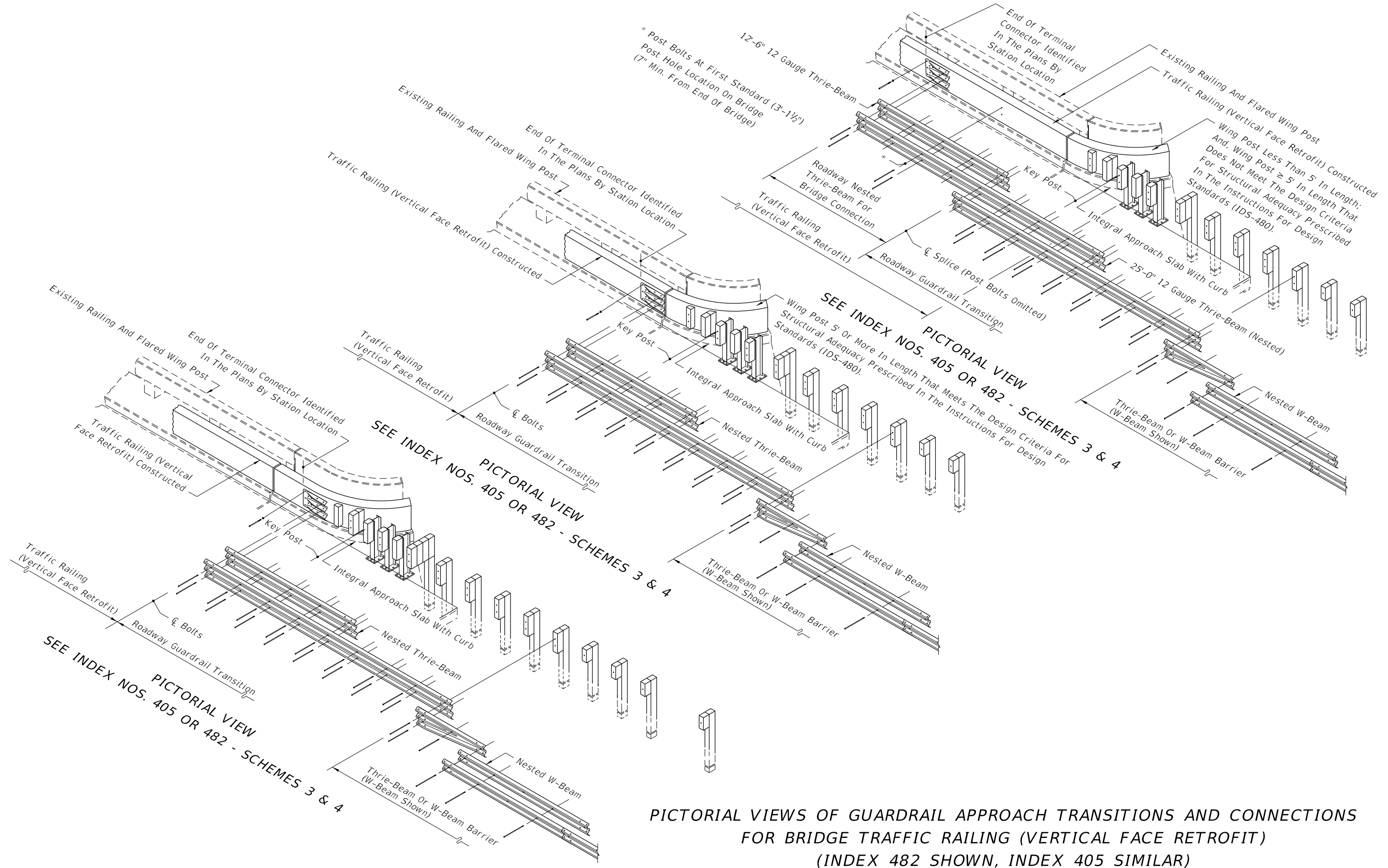

PICTORIAL VIEWS OF GUARDRAIL APPROACH TRANSITIONS AND CONNECTIONS FOR BRIDGE TRAFFIC RAILING (VERTICAL FACE RETROFIT) (INDEX 482 SHOWN, INDEX 405 SIMILAR)

6/8/2015 11:10:50 AM

LAST REVISION 07/01/14	DESCRIPTION: 	 2016 DESIGN STANDARDS	2016 GUARDRAIL TRANSITIONS AND CONNECTIONS FOR EXISTING BRIDGES	INDEX NO. 402	SHEET NO. 19 of 24
---------------------------	----------------------	---	--	------------------	-----------------------

6/8/2015 11:10:51 AM

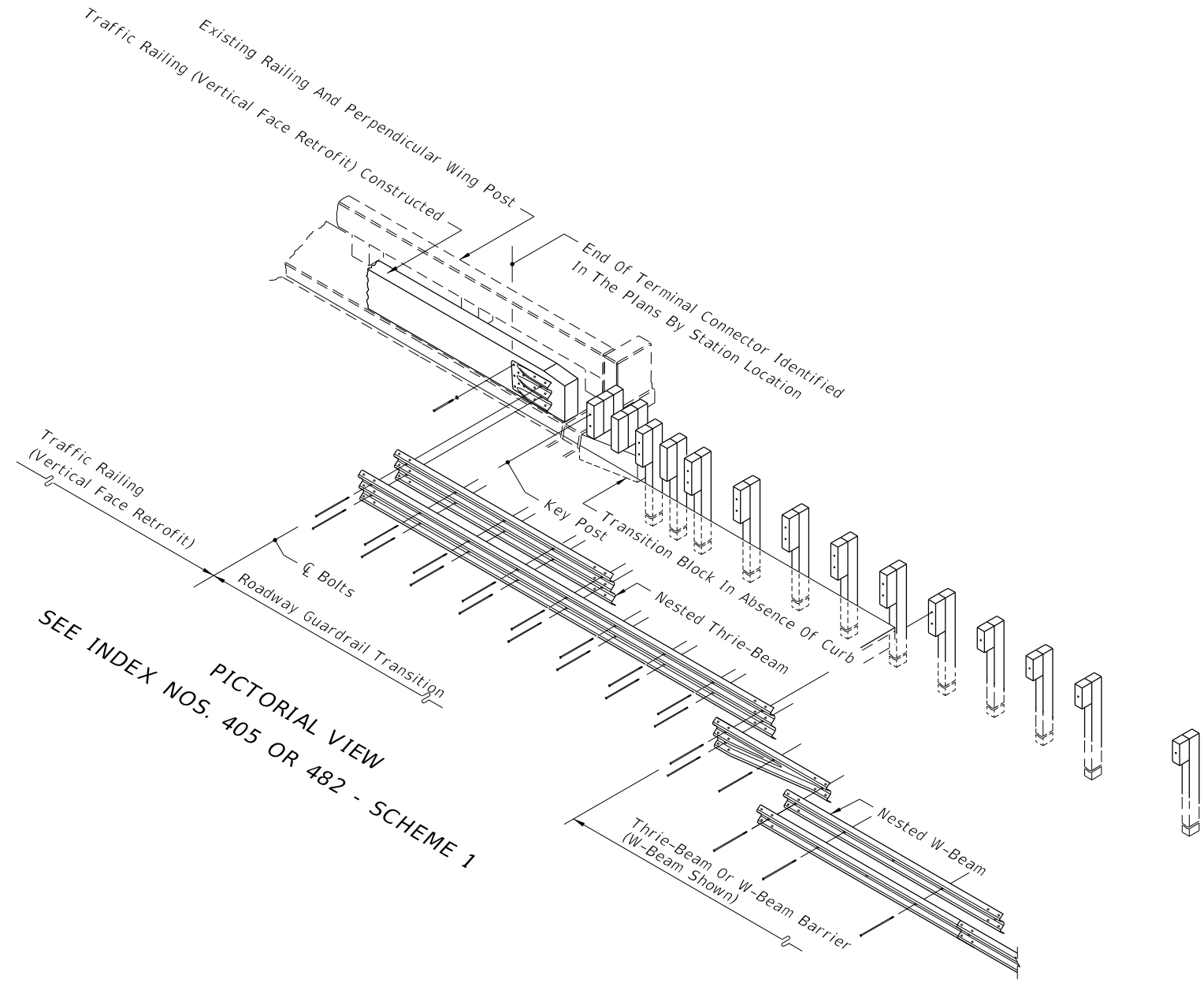

PICTORIAL VIEW
 SEE INDEX NOS. 405 OR 482 - SCHEME 1

PICTORIAL VIEWS OF GUARDRAIL APPROACH TRANSITIONS AND CONNECTIONS FOR BRIDGE TRAFFIC RAILING (VERTICAL FACE RETROFIT) (INDEX 482 SHOWN, INDEX 405 SIMILAR)

LAST REVISION 07/01/14	DESCRIPTION:
---------------------------	--------------



GUARDRAIL TRANSITIONS AND CONNECTIONS FOR EXISTING BRIDGES

INDEX NO. 402	SHEET NO. 20 of 24
------------------	-----------------------

6/8/2015 11:10:51 AM

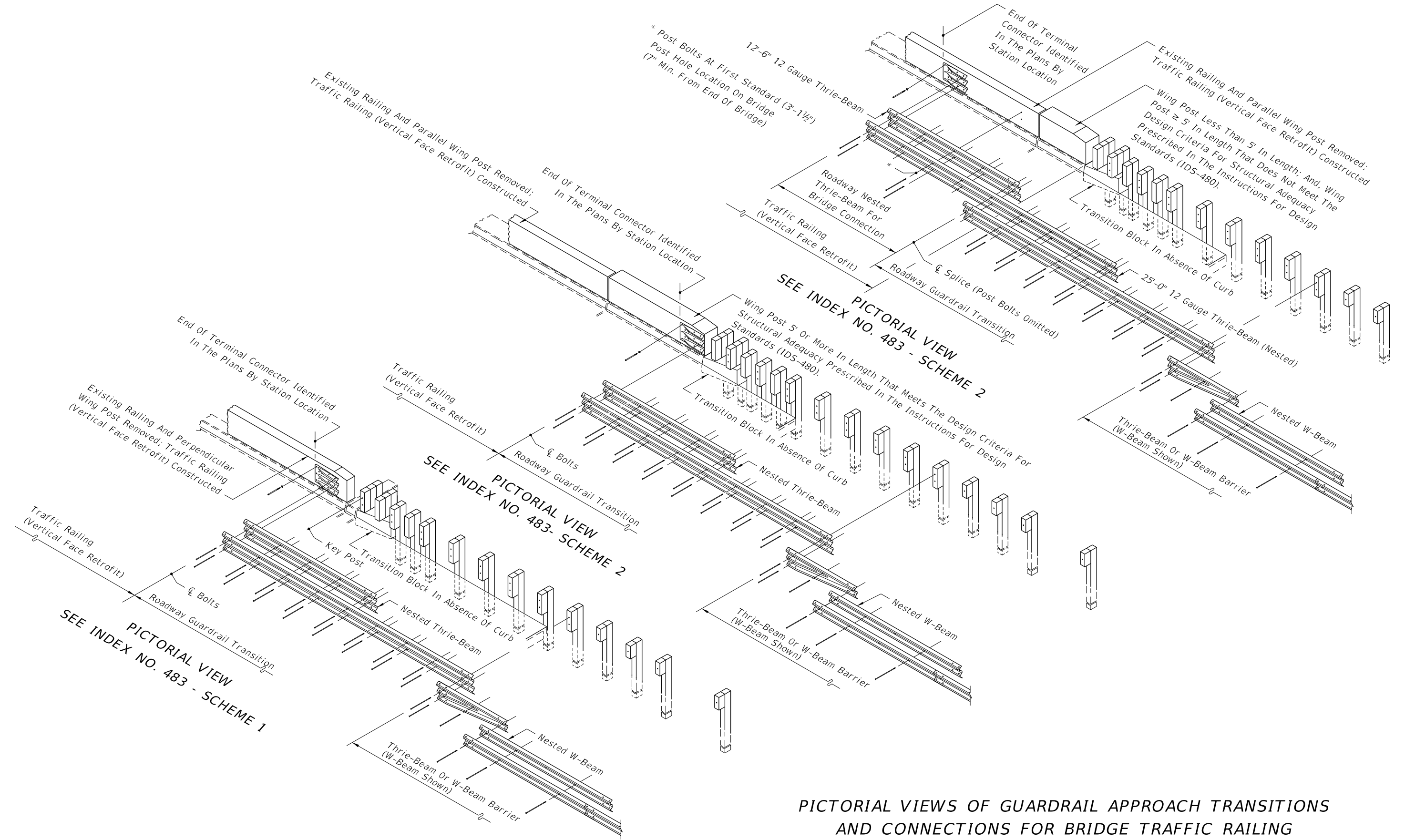

PICTORIAL VIEWS OF GUARDRAIL APPROACH TRANSITIONS AND CONNECTIONS FOR BRIDGE TRAFFIC RAILING (VERTICAL FACE RETROFIT)

LAST REVISION 07/01/14	REVISION	DESCRIPTION:
---------------------------	----------	--------------

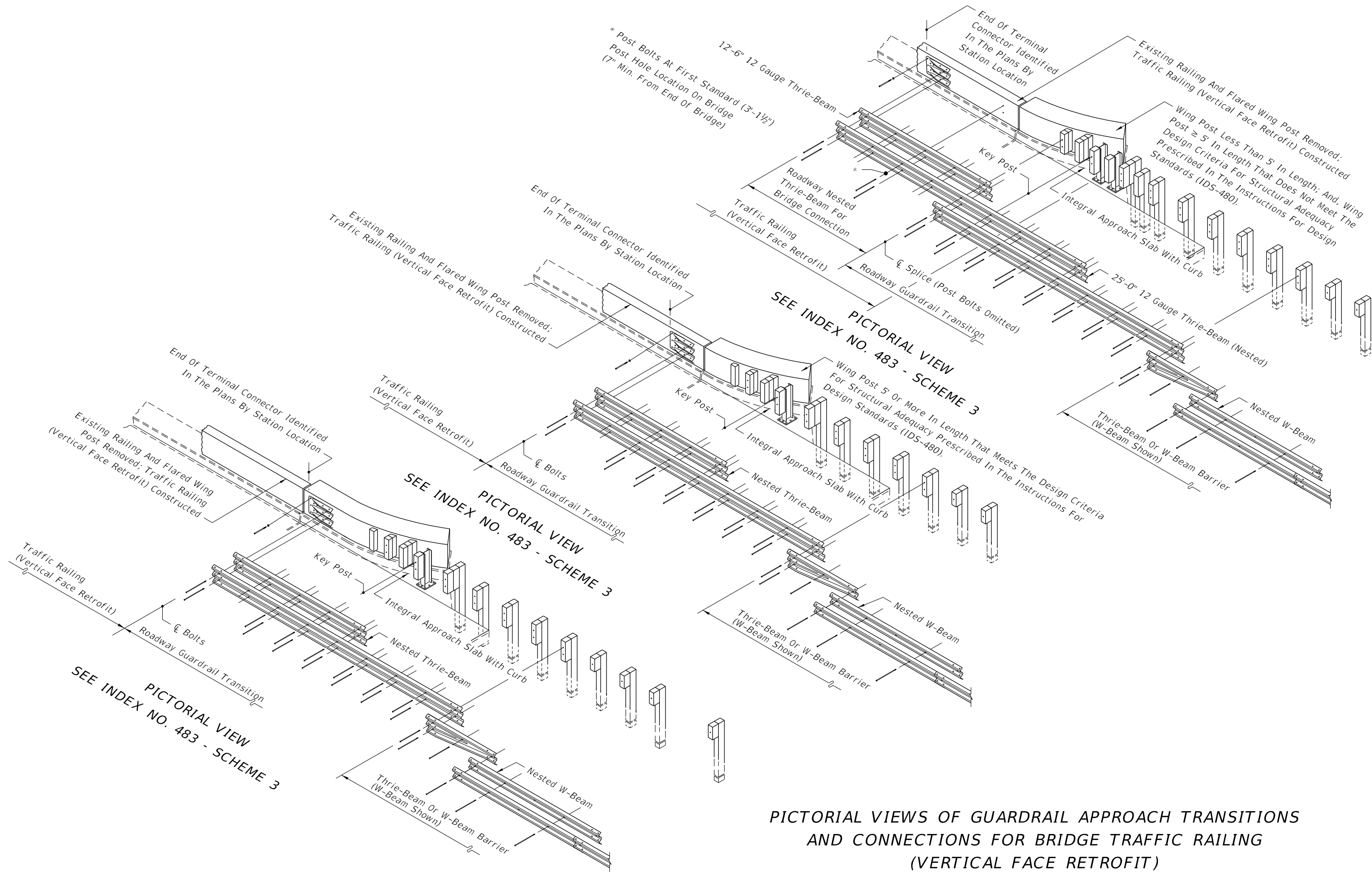

**PICTORIAL VIEWS OF GUARDRAIL APPROACH TRANSITIONS
AND CONNECTIONS FOR BRIDGE TRAFFIC RAILING
(VERTICAL FACE RETROFIT)**

11:10:52 AM
6/8/2015

LAST REVISION 07/01/14	DESCRIPTION:
---------------------------	--------------

 2016
DESIGN STANDARDS

GUARDRAIL TRANSITIONS AND CONNECTIONS FOR EXISTING BRIDGES

INDEX NO. 402	SHEET NO. 22 of 24
------------------	-----------------------

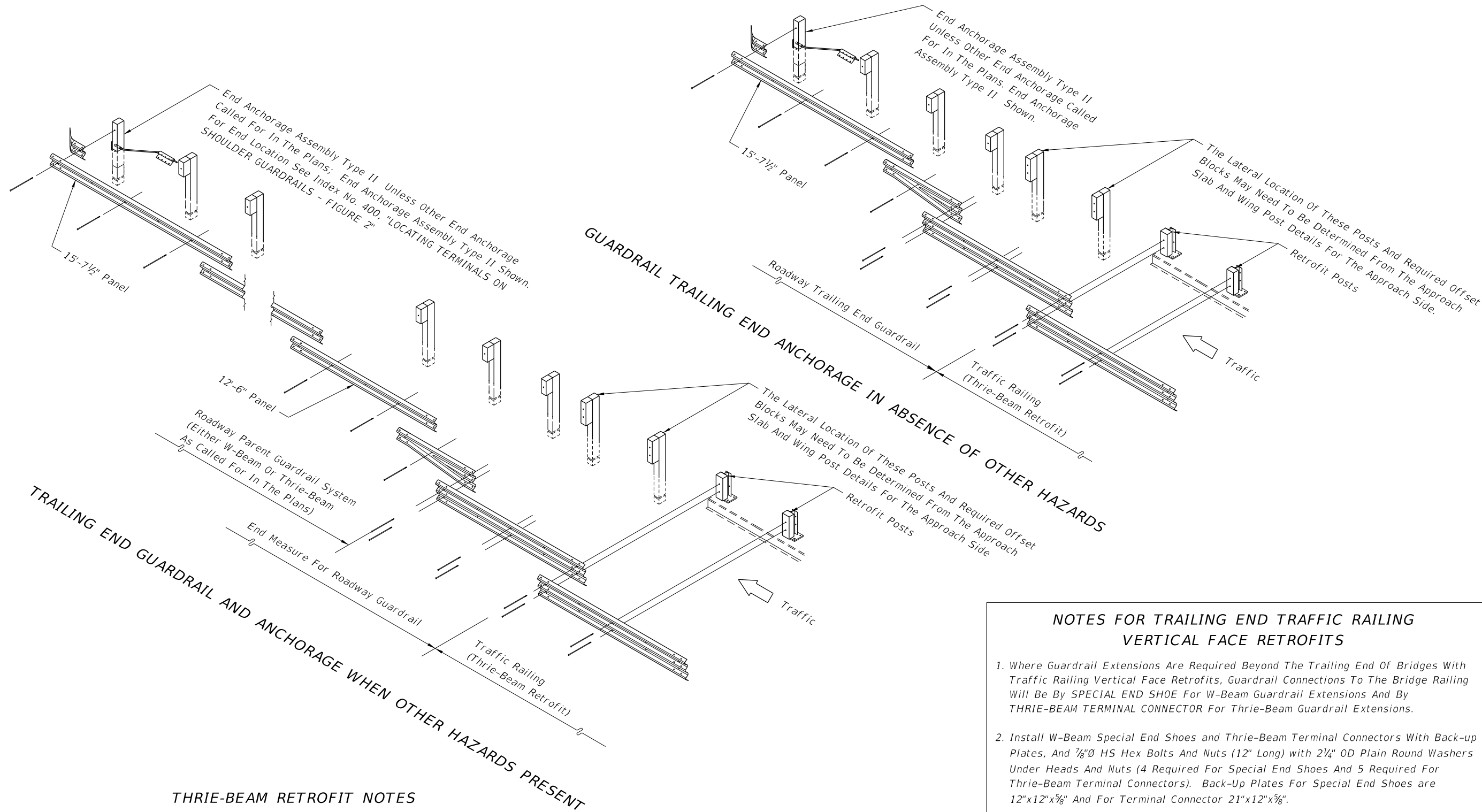

THRIE-BEAM RETROFIT NOTES

1. See indexes for bridge thrie-beam traffic railing retrofits.
2. Trailing end guardrail to be paid for under the contract unit price for the parent roadway guardrail; end measure includes length of end anchorage assembly; additional payment made for end anchorage assembly. No additional payment for connecting roadway thrie-beam to bridge thrie-beam retrofit.

NOTES FOR TRAILING END TRAFFIC RAILING VERTICAL FACE RETROFITS

1. Where Guardrail Extensions Are Required Beyond The Trailing End Of Bridges With Traffic Railing Vertical Face Retrofits, Guardrail Connections To The Bridge Railing Will Be By SPECIAL END SHOE For W-Beam Guardrail Extensions And By THRIE-BEAM TERMINAL CONNECTOR For Thrie-Beam Guardrail Extensions.
2. Install W-Beam Special End Shoes and Thrie-Beam Terminal Connectors With Back-up Plates, And 7/8" HS Hex Bolts And Nuts (12" Long) with 2 1/4" OD Plain Round Washers Under Heads And Nuts (4 Required For Special End Shoes And 5 Required For Thrie-Beam Terminal Connectors). Back-Up Plates For Special End Shoes are 12"x12"x5/8" And For Terminal Connector 21"x12"x5/8".
3. Payment For Connecting Trailing End Special End Shoes And Thrie-Beam Terminal Connectors To Traffic Railing Vertical Face Retrofits Will Be Made Under The Contract Unit Price For Guardrail Bridge Anchorage Assembly, EA.

TRAILING END GUARDRAIL AND ANCHORAGE FOR BRIDGE TRAFFIC RAILING (THRIE BEAM RETROFITS)

6/8/2015 11:10:53 AM

LAST REVISION 07/01/14	REVISION	DESCRIPTION:	 2016 DESIGN STANDARDS	GUARDRAIL TRANSITIONS AND CONNECTIONS FOR EXISTING BRIDGES	INDEX NO. 402	SHEET NO. 23 of 24
---------------------------	----------	--------------	------------------------------	---	------------------	-----------------------

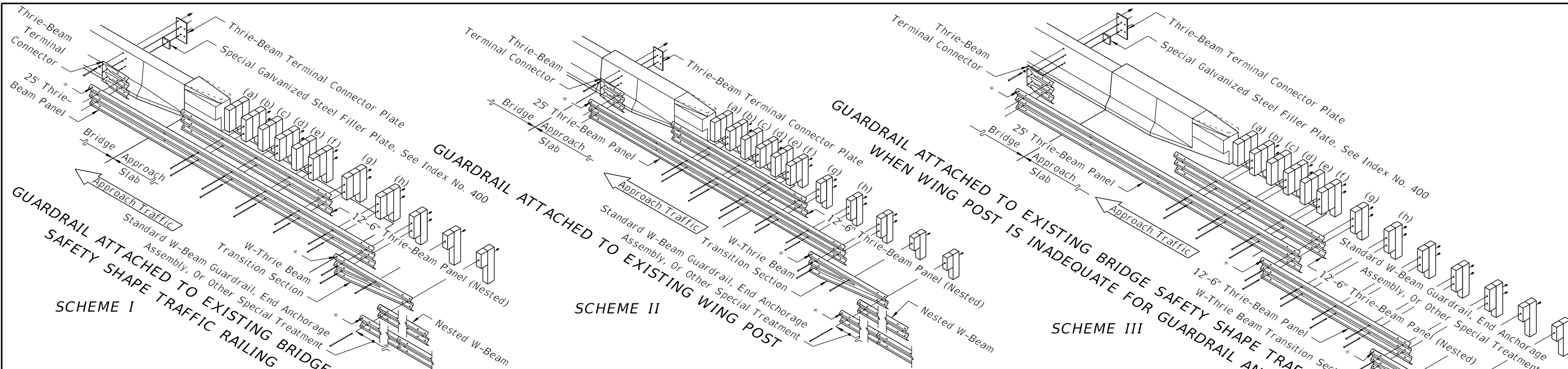

SCHEME I
GUARDRAIL ATTACHED TO EXISTING BRIDGE SAFETY SHAPE TRAFFIC RAILING

SCHEME II
GUARDRAIL ATTACHED TO EXISTING WING POST

SCHEME III
GUARDRAIL ATTACHED TO EXISTING BRIDGE SAFETY SHAPE TRAFFIC RAILING WHEN WING POST IS INADEQUATE FOR GUARDRAIL ANCHORAGE

Use Of Scheme I Shall Be Determined In Accordance With The Instructions For Design Standards (IDS-402).
GUARDRAIL TRANSITION TO EXISTING FLAT SLAB BRIDGES

* Splice Locations: Thrie-Beam - 12 Guardrail Splice Bolts And Recessed Nuts
 W-Beam - 8 Guardrail Splice Bolts And Recessed Nuts
 Use Of Schemes II And III Shall Be Determined In Accordance With The Instruction For Design Standards (IDS-402).
GUARDRAIL TRANSITIONS TO EXISTING PRESTRESSED BEAM OR GIRDER BRIDGES

APPROACH POSTS AND SPECIAL OFFSET BLOCKS
 Block assemblies for special offsets can be made up of one special block plus one standard size block or of three standard size blocks field dressed to approximately equal size, with the pieces secured for relative position by 16d galvanized nails, see '16d NAIL FOR PREVENTION OF OFFSET BLOCK ROTATION' - Index 400. The nested rails shall not be bolted to the blocks and posts at posts (a), (c) and (e). The details shown are for approach slabs with internal edge dike extending beyond parapet type traffic railing termini.

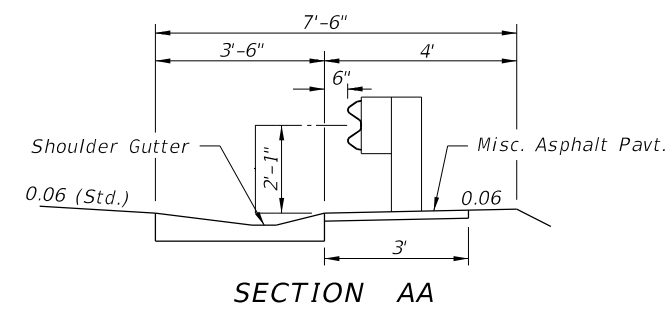
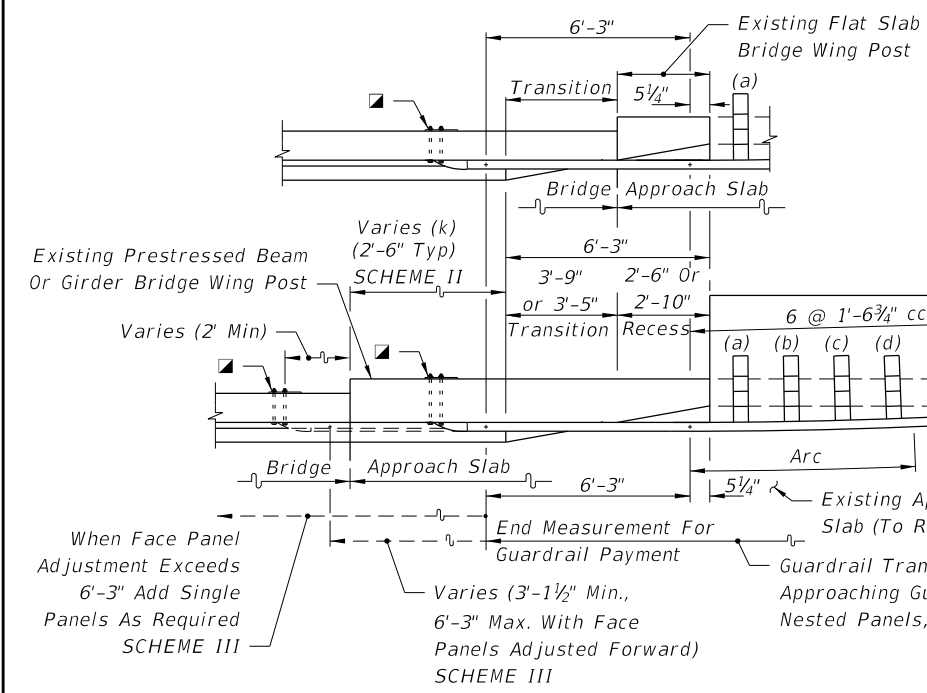

When Face Panel Adjustment Exceeds 6'-3" Add Single Panels As Required SCHEME III

21"x12"x5/8" Thrie-Beam Terminal Connector Plate (Back-Up Plate), And 7/8"Ø x 18" Long [15" Long With 3 1/2" Min. Thread Length For Bridge Safety Shape Railing] HS Hex Bolts And Nuts (5 Req'd.) With 2 1/4" OD Plain Round Washers Under Heads And Nuts. [When Attaching Guardrail To Existing Wing Posts Or Bridge Rails, Care Should Be Exercised To Avoid Damaging Conduits And Their Utilities That May Be Routed Through Wing Posts Or Bridge Rails. When Conduits And Their Utilities Are Encountered, At Least Five 7/8" HS Hex Bolts Shall Be Installed In Any Of The Seven Holes Provided In The Thrie-Beam Terminal Connector.]

NOTES FOR GUARDRAIL TRANSITIONS TO SAFETY SHAPE TRAFFIC RAILINGS ON EXISTING BRIDGES

1. When the existing wing post is to be replaced with a bridge traffic railing in accordance with the Instructions For Design Standards (IDS-402), the thrie-beam guardrail connection shall be in accordance with Detail J of Index No. 400.
2. When the guardrail attachment overlays the Bridge Number, Bridge Name or Date on the traffic railing, provide an aluminum sign panel with the obscured information. Attach the sign panel to the face of the traffic railing adjacent to the Thrie-Beam Terminal Connector with 1/4"Ø x 1" long concrete screws or expansion anchors at each corner, as approved by the Engineer. The sign panel shall be a minimum 1/16" thick and meet the requirements of Specification Section 700 with a white background and 3" tall black letters and sized appropriately to contain the information required. The cost of the sign panel shall be included in the cost of the Guardrail Bridge Anchorage Assembly.
3. When retrofitting thrie-beam guardrail to existing wing posts or existing bridge safety shape traffic railing, attachment construction to be paid for under the contract unit price for Guardrail Bridge Anchorage Assembly, EA., and shall be full compensation for bolt hole construction, terminal connector, terminal connector plate(s) and bolts, nuts and washers.

GUARDRAIL APPROACH TRANSITIONS AND CONNECTIONS FOR EXISTING FLAT SLAB, PRESTRESSED BEAM AND GIRDER BRIDGES WITH SAFETY SHAPE TRAFFIC RAILING EXTENDING LESS THAN FULL APPROACH SLAB LENGTH

LAST REVISION 07/01/14	DESCRIPTION:	2016 FDOT DESIGN STANDARDS	GUARDRAIL TRANSITIONS AND CONNECTIONS FOR EXISTING BRIDGES	INDEX NO. 402	SHEET NO. 24 of 24
---------------------------	--------------	-------------------------------	--	------------------	-----------------------

6/8/2015 11:10:54 AM