

SINGLE COLUMN GROUND SIGN NOTES:

- DESIGN WIND SPEED: See Wind Speeds by County.
- GENERAL SPECIFICATIONS: Current FDOT Standard Specifications for Road and Bridge Construction and supplements thereto.
- DESIGN SPECIFICATIONS: AASHTO Standard Specifications for Structural Supports for Highway Signs, Luminaires and Traffic Signals, as modified by the FDOT Structures Manual.
- ALUMINUM: Aluminum Materials shall meet the requirements of Aluminum Association Alloy 6061-T6 (ASTM B209, B221, or B308), except as noted below.
- CONCRETE: Class I.
- SIGN PANELS: 0.08 inches min. thick Aluminum Plate with all corners rounded.
- ALUMINUM BOLTS, NUTS, AND LOCK WASHERS:
 - Aluminum bolts: ASTM F468, Alloy 2024-T4 with at least 0.0002 inches thick anodic coating and chromate sealed.
 - Nuts: ASTM F467, Alloy 6061-T6 or 6262-T9.
 - Lockwashers: ASTM B221, Alloy 7075-T6.
- STAINLESS STEEL BOLTS, NUTS, AND LOCKWASHERS: Stainless Steel Bolts, Nuts, and Lockwashers: ASTM F593 and ASTM F594, Alloy Group 2. Condition A, CW2, or SH4 may be provided in lieu of Aluminum Bolts, Nuts, and Washers.
- U-BOLTS, NUTS, AND LOCKWASHERS: U-bolts, Nuts, and Lockwashers: ASTM A307, Grade A, galvanized in accordance with ASTM F2329.
- BREAKAWAY SUPPORTS REQUIREMENTS: Install non-frangible aluminum column (post) (larger than 3 1/2") with breakaway supports as shown on Sheet 5. Signs shielded by barrier wall or guardrail do not require breakaway support.

GUIDE TO USE THIS STANDARD:

- Calculate the area and the centroid for an individual sign or a sign cluster. Note that the centroid and areas have been calculated for frequently used sign clusters. These are shown on Sheet No. 6, 7 & 8 of 8.
- Determine the height 'H' from groundline for the individual sign or the cluster.
- Select the appropriate Column (Post) Selection Tables by Wind Speed and find the intersection point.
- Design the post and the foundation according to the dark-bold lines or shaded area (if cantilever sign) in the Column (Post) Selection Tables and Post and Foundation Table. For sign posts with signs oriented in two directions, only the sign with the largest area should be analyzed to determine the post requirements.

EXAMPLE:

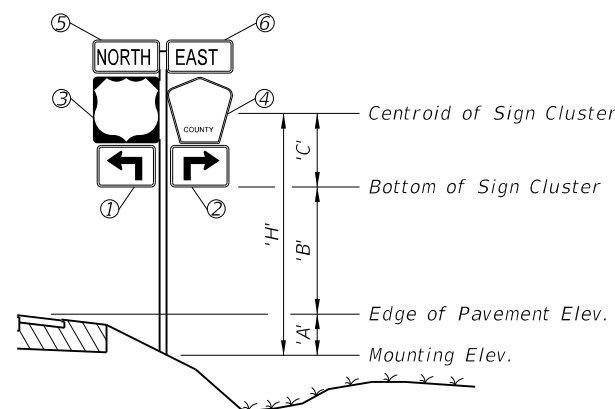

Size H x V	Centroid			'A _n '	'X _n ' x 'A _n '	'Y _n ' x 'A _n '	
	local 'Y _n '	global 'X _n '	global 'Y _n '				
(in. x in.)	(in.)	(in.)	(in.)	(in. ²)	(in. ³)	(in. ³)	
① 21 x 15	7.5	-10.5-1.5-1.5 = -13.5	7.5	315	-4,252.5	2,362.5	
② 21 x 15	7.5	10.5+1.5+1.5 = 13.5	7.5	315	+4,252.5	2,362.5	
③ 24 x 24	12	-12-1.5 = -13.5	15+1+12= 28	576	-7,776	16,128	
④ 24 x 24	12	12+1.5 = 13.5	15+1+12= 28	436	5,886	12,208	
⑤ 24 x 12	6	-12-1.5 = -13.5	15+1+24+ 1+6=47	288	-3,888	13,536	
⑥ 24 x 12	6	12+1.5 = 13.5	15+1+24+ 1+6=47	288	3,888	13,536	
				2,218	-1,890	60,133	TOTALS

$\Sigma(A_n) = 2,218 \text{ in.}^2 = 15.4 \text{ ft.}^2$ $\Sigma(X_n' \times A_n') = -1,890 \text{ in.}^3 = -1.09 \text{ ft.}^3$ $\Sigma(Y_n' \times A_n') = 60,133 \text{ in.}^3 = 34.8 \text{ ft.}^3$

$X'_c = \frac{\Sigma(X_n' \times A_n')}{\Sigma A_n} = -0.1 \text{ ft.}$ $Y'_c = \frac{\Sigma(Y_n' \times A_n')}{\Sigma A_n} = 2.26 \text{ ft.}$

Assume: Bay County, 'A' = 1 ft., 'B' = 7 ft.

Calculated: 'X'_c = -0.1 ft. 'C' = 'Y'_c = 2.26 ft.

Since 'X'_c < 6", it is not a cantilever sign, only dark-bold lines in the table will be referenced to.

'H' = 'A' + 'B' + 'C' = 10.26 ft. ==> **USE 11 ft.** $\Sigma(A_n) = 15.4 \text{ ft.}^2$ ==> **USE 16 ft.²**

**ALUMINUM COLUMN (POST) SELECTION TABLE
(WIND SPEED = 130 MPH)**

TOTAL PANEL AREA (SF)	'H' (ft.)												
	8	9	10	11	12	13	14	15	16	17	18	19	20
3													
4													
5													
6													
7													
8													
9													
10													
11													
12													
13													
14													
15													
16													
17													
18													
19													
20													
21													
22													
23													
24													
25													
26													
27													
28													
29													
30													

For WIND SPEED = 130 MPH,
'H' = 11 ft., Area = 16 ft.²

- Refer to the 130 mph Column (Post) Selection Table, as copied from Sheet 3 and shown here.
- Using the 16 ft.² area on the left hand side of the table, go across to the 11 ft. height and find the cell marked with X.
- find the symbol **4** which the dark-bold line under the X cell leads to.
- In the Post and Foundation Table, the symbol **4** concludes that the design requires a 4.0" diameter and 0.25" thick Aluminum Column (Post) and a 2.0' diameter and 4.0' deep Concrete Foundation.

= If CANTILEVER SIGN configuration (see Cantilever Sign Details) falls in this region, use next larger post size than that indicated.

NOTES AND EXAMPLE

WIND SPEEDS BY COUNTY:

110 MPH
Alachua, Baker, Bradford, Clay, Columbia, Gadsden, Gilchrist, Hamilton, Hardee, Jackson, Jefferson, Lafayette, Lake, Leon, Madison, Marion, Polk, Putnam, Sumter, Suwannee and Union counties.

130 MPH
Bay, Brevard, Calhoun, Charlotte, Citrus, De Soto, Dixie, Duval, Flagler, Franklin, Glades, Gulf, Hendry, Hernando, Highlands, Hillsborough, Holmes, Lee, Levy, Liberty, Manatee, Nassau, Okaloosa, Okeechobee, Orange, Osceola, Pasco, Pinellas, Sarasota, Seminole, St Johns, Taylor, Volusia, Wakulla, Walton and Washington counties.

150 MPH
Broward, Collier, Dade, Escambia, Indian River, Martin, Monroe, Palm Beach, Santa Rosa and St. Lucie counties.

6/5/2014 12:52:01 PM

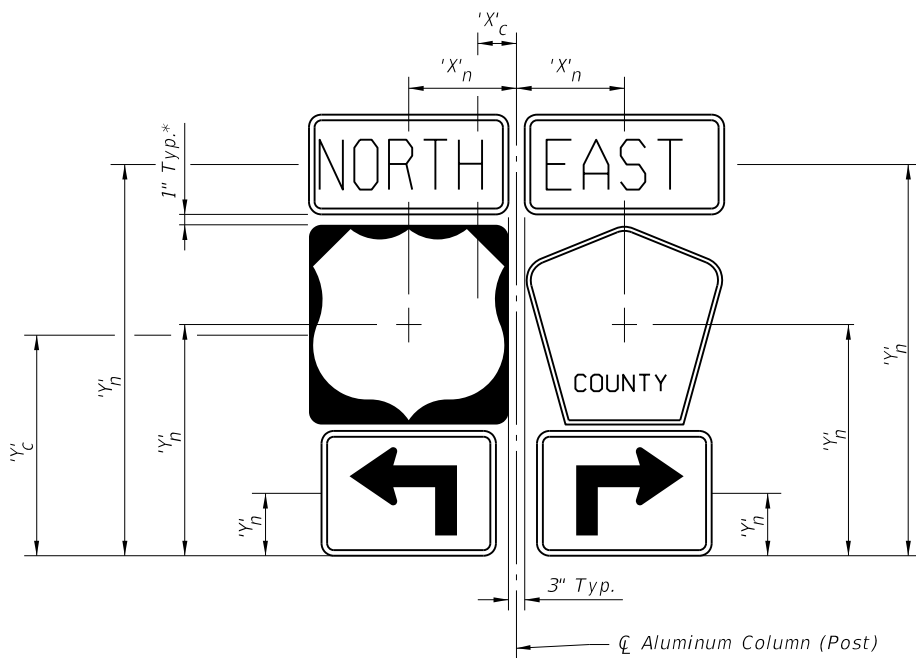

SIGN CLUSTER

CALCULATION OF SIGN CLUSTER CENTROID:

$$'X'_c = \frac{\sum ('X'_n \times 'A'_n)}{\sum 'A'_n}$$

$$'Y'_c = \frac{\sum ('Y'_n \times 'A'_n)}{\sum 'A'_n}$$

'X'_c = Centroid horizontal location of sign or cluster from ϕ Column (post)

'Y'_c = Centroid height of sign or cluster from bottommost edge

'H' = Height of sign or cluster centroid from groundline

'X'_n = Individual sign centroid horizontal location from ϕ Column (post)

'Y'_n = Individual sign centroid height from bottommost edge

'A'_n = Area of individual sign

For 'A' & 'B' see Index No. 17302 and Roadway Plans.

NOTE:
No sign or sign cluster area shall exceed 30 SF nor shall any sign or sign cluster have a total width exceeding 60 inches.

* Also applies to rotated signs.

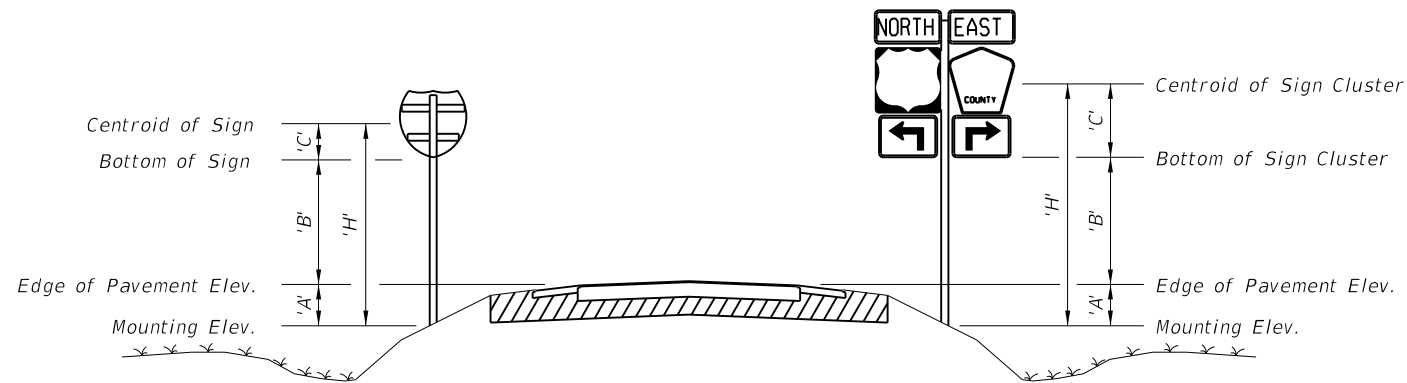

TYPICAL SECTION

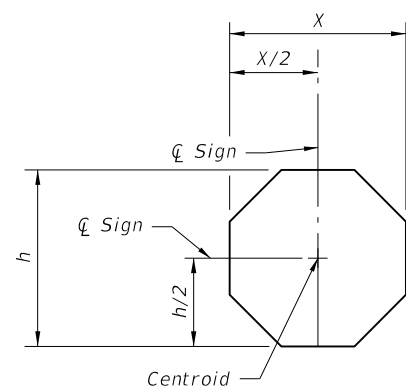

STOP

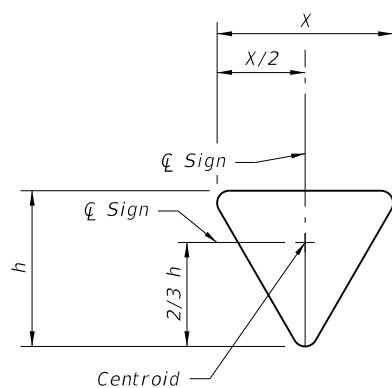

YIELD

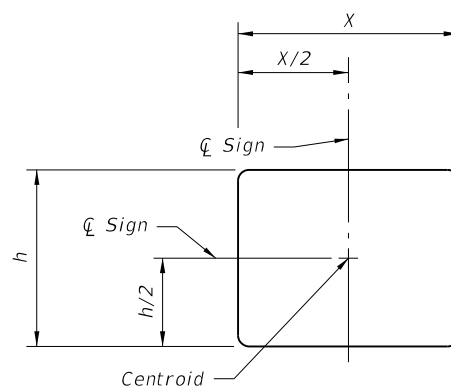

RECTANGLE

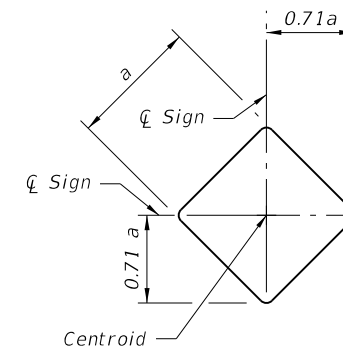

DIAMOND

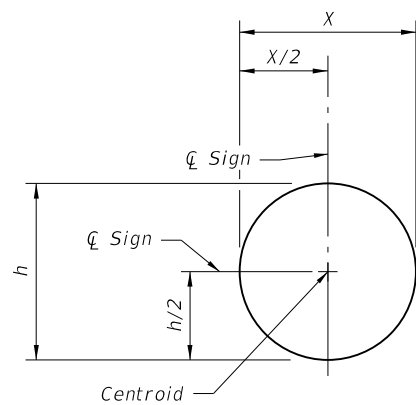

RAILROAD

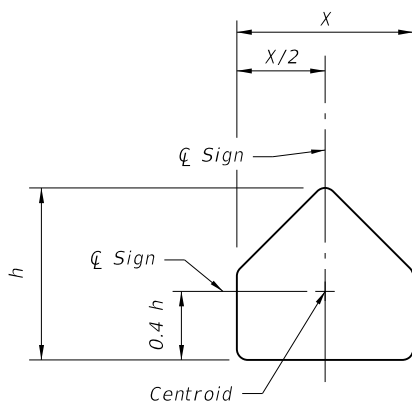

SCHOOL

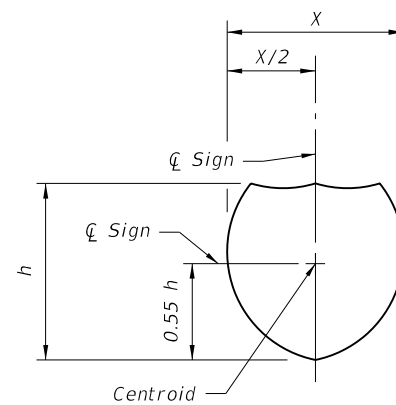

SHIELD

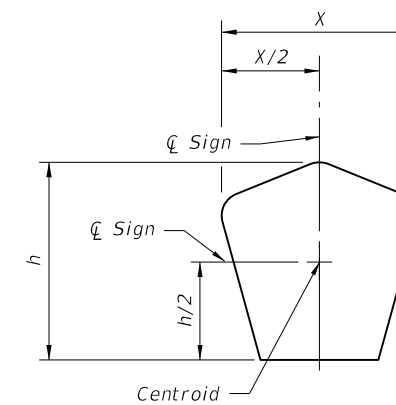

COUNTY

CENTROID AND HEIGHT

6/5/2014 12:52:02 PM

LAST REVISION	DESCRIPTION:
07/01/14	

REVISION	DESCRIPTION:

ALUMINUM COLUMN (POST) SELECTION TABLE
(WIND SPEED = 110 MPH)

TOTAL PANEL AREA (SF)	'H' (FT)												
	8	9	10	11	12	13	14	15	16	17	18	19	20
3			0			1						2	
4													3
5													
6													
7													
8													
9													
10													
11													4
12													
13													
14													
15													5
16													
17													
18													
19													6
20													
21													
22													
23													
24													
25													
26													
27													
28													
29													
30													7

ALUMINUM COLUMN (POST) SELECTION TABLE
(WIND SPEED = 130 MPH)

TOTAL PANEL AREA (SF)	'H' (FT)												
	8	9	10	11	12	13	14	15	16	17	18	19	20
3			0				1						2
4													3
5													
6													
7													
8													4
9													
10													
11													5
12													
13													
14													6
15													
16													
17													
18													
19													
20													
21													
22													
23													
24													7
25													
26													
27													
28													
29													
30													8

ALUMINUM COLUMN (POST) SELECTION TABLE
(WIND SPEED = 150 MPH)

TOTAL PANEL AREA (SF)	'H' (FT)												
	8	9	10	11	12	13	14	15	16	17	18	19	20
3													
4													
5													
6													4
7													
8													
9													
10													6
11													
12													
13													
14													
15													
16													
17													
18													
19													
20													
21													
22													
23													
24													
25													
26													
27													
28													
29													
30													8

▨ = If CANTILEVER SIGN configuration (see Cantilever Sign Details) falls in this region, use next larger post size than that indicated.

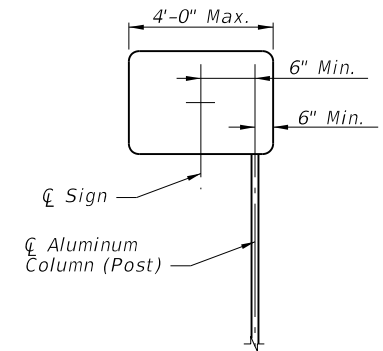

CANTILEVER SIGN

NOTE:
All cantilever sign installations shall comply with Standard Index 17302.

POST AND FOUNDATION TABLE							
Foundation Alternatives							
Post Size	Driven Post *		Concrete (Class I)				
	Diameter (IN)	Wall (IN)	Depth (FT)		Diameter (FT)	Depth (FT)	Stub Length (FT)
			without Soil Plate	with Soil Plate			
0	2.0	1/8	4.5	2.5	2.0	2.0	2.0
1	2.5	1/8	5.0	3.0	2.0	2.0	2.0
2	3.0	1/8	5.0	3.5	2.0	2.5	2.5
3	3.5	3/16	6.0	4.5	2.0	3.0	3.0
4	4.0	1/4	---	---	2.0	4.0	3.0
5	4.5	1/4	---	---	2.0	4.0	3.0
6	5.0	1/4	---	---	2.0	4.5	3.0
7	6.0	1/4	---	---	2.0	5.0	3.0
8	8.0	5/16	---	---	2.0	5.5	3.0

* INSTALLING FRANGIBLE COLUMN SUPPORTS:
Columns (posts) may be installed by driving the columns in accordance with this Index, or as an alternate method, the columns (posts) may be set to the depth indicated in preformed holes backfilled with suitable material tamped in layers not thicker than 6" to provide adequate compaction or filled with flowable fill or bagged concrete.

1/16" Ø Bolt Holes (Hole spacing to match U-Bolts) (washers as required)

R Thickness = 1/4"

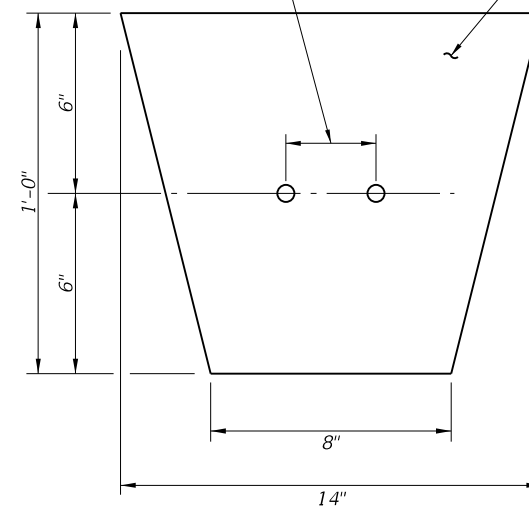

ALUMINUM SOIL PLATE DETAILS

NOTES:
1. Align Soil Plate bottom at 2/3 of foundation depth.
2. Slot up to 1" long is allowed to accommodate various post sizes.
3. Rectangular soil plate of size 1'-2" x 1'-0" may be used as an alternative.

POST AND FOUNDATION TABLES

6/5/2014 12:52:02 PM

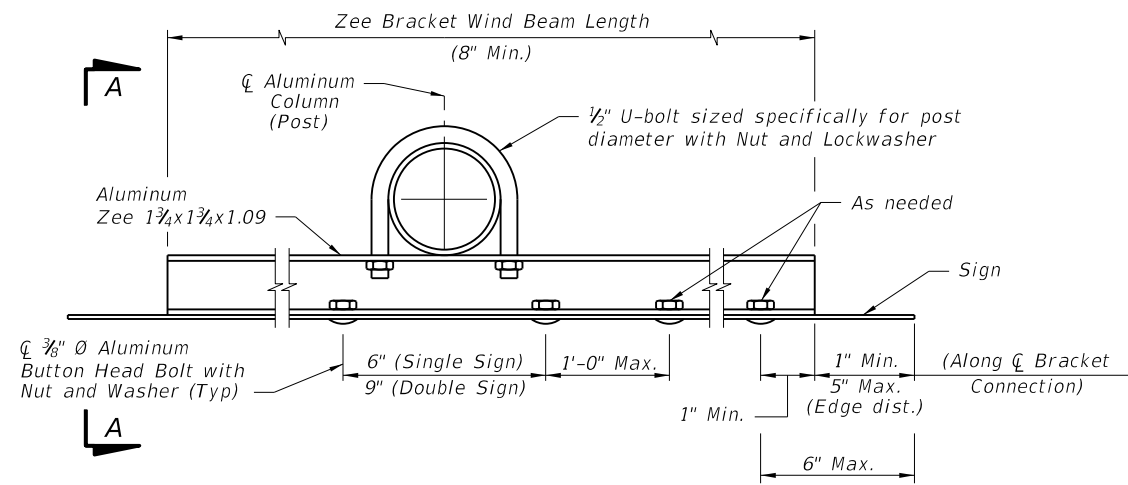

NOTES:

1. 5/16" Ø Stainless Steel Hex Head Bolts with Flat Washer under Head and Lockwasher under Nut may be used in lieu of 3/8" Ø Aluminum Button Head Bolts.
2. Nylon washers provided by the sheeting supplier shall be used on all ground mounted signs. The washers shall be installed under the sign bolt head to protect the sheeting.
3. Vertical spacing of brackets shall not exceed 2'-6". Use additional brackets, spaced evenly, to maintain maximum spacing.
4. Slots for U-bolts are allowed in zee bracket to accommodate various post diameters.

BRACKET DETAIL

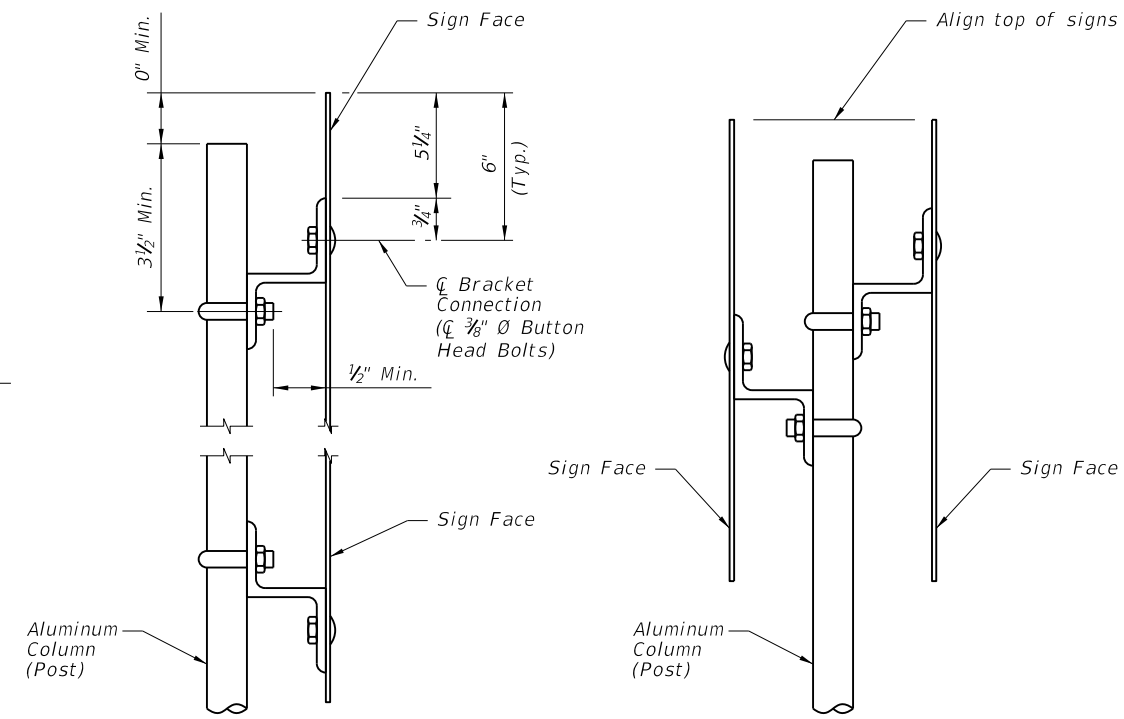

VIEW A-A

NOTE:
Use the area and the centroid location of the largest sign to determine column (post) size.

SIGNS BACK-TO-BACK

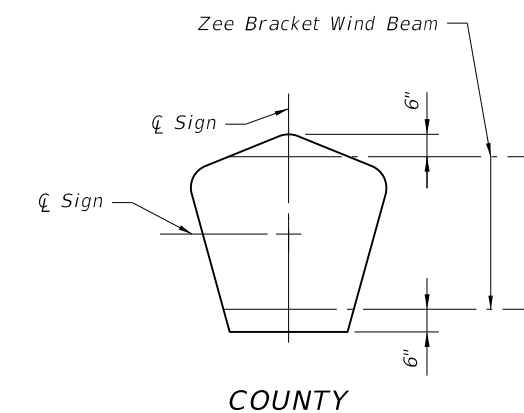
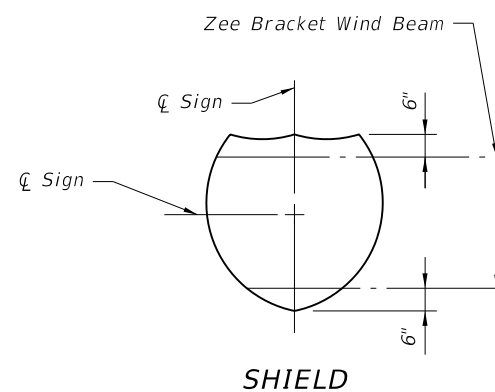
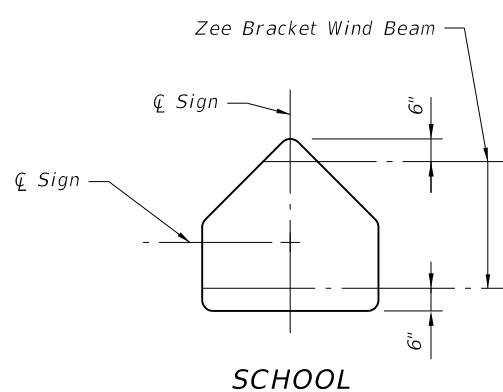
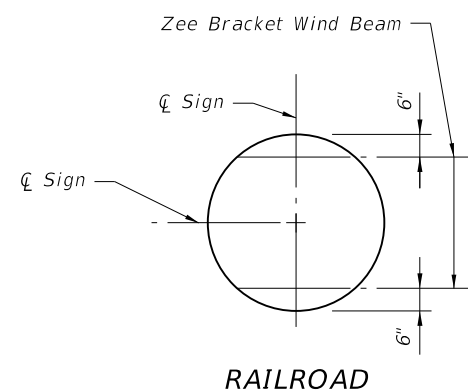
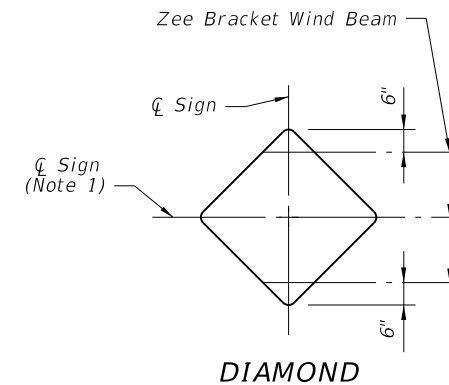
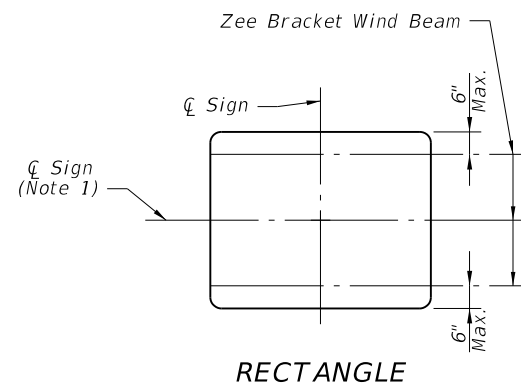
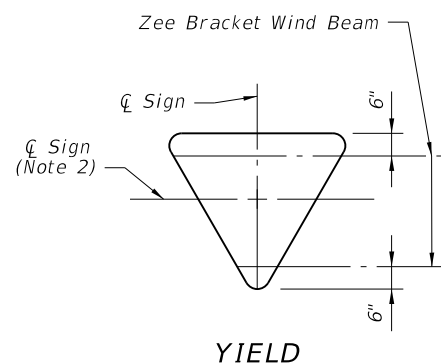
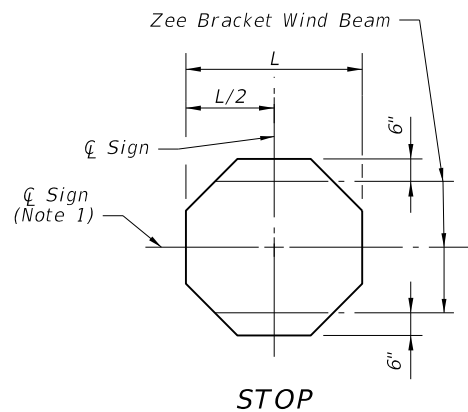

NOTES:

1. For signs with heights greater than 30" a third zee bracket wind beam shall be installed along the centerline.
2. For Yield signs greater than 36" a third zee bracket wind beam shall be installed along the centerline.
3. Use only one Wind Beam at centerline for sign height up to 12".

CONNECTION AND WIND BEAM

6/5/2014 12:52:03 PM

LAST REVISION 07/01/14	REVISION	DESCRIPTION:	 2015 DESIGN STANDARDS	SINGLE COLUMN GROUND SIGNS	INDEX NO. 11860	SHEET NO. 4 of 8
---------------------------	----------	--------------	----------------------------------	-----------------------------------	---------------------------	----------------------------

SLIP BASE NOTES:

- Use sleeves with an inside diameter (I.D.) no more than $\frac{1}{16}$ " larger than the outside diameter (O.D.) of the column.
- Sleeve Bolts: ASTM A-307, $\frac{1}{2}$ " \varnothing galvanized steel bolt (with lock nuts) or Alloy 2024-T4 or 6061-T6 (ASTM B-211).
- Base bolts, Nuts, and Washers: high strength ASTM A-325 galvanized per ASTM F2329.
- Base plates may have either single or double beveled slots.
- Cast base plate/sleeves, made of aluminum alloy 356 and T6 temper and bolted to aluminum pipe, may be used as an alternate to fabricated base plate welded aluminum pipe stub combination. For cast base plate and sleeves bolted to aluminum pipe foundation stubs, use a foundation stub of the same size as the sign column.
- Assemble the slip base connection in the following manner:
 - Connect column to sleeve using two $\frac{1}{2}$ " \varnothing machine bolts.
 - Assemble top base plate to stub base plate using high strength bolts with three hardened washers per bolt. One of the three washers per bolt and two bolt keeper plates go between the base plates. Orient the bolt keeper plates in the Directions of Traffic.
 - Use shim stock as required to plumb the column.
 - Tighten all bolts to the maximum possible with a 12" to 15" wrench. (This will bed the washers and shims and clear the bolt threads.)
 - Loosen each bolt one turn and using a calibrated wrench retighten to the prescribed torque (see table) under the supervision of the Project Engineer.
 - Burr threads at junction with nut using a center punch to prevent nut loosening.
- Use galvanized steel shims to obtain a tight fit between the column face and the sleeve. Place shims in all quadrants between the $\frac{1}{2}$ " \varnothing sleeve bolts. Use shims that are 1" shorter than the height of the sleeve.
- Both fabricated and cast base assemblies were impact tested by the Texas Transportation Institute, College Station, TX on February 10, 2003, and both alternate assemblies were determined to be compliant with the performance recommendations of the National Cooperative Highway Research Program (NCHRP) report 350.

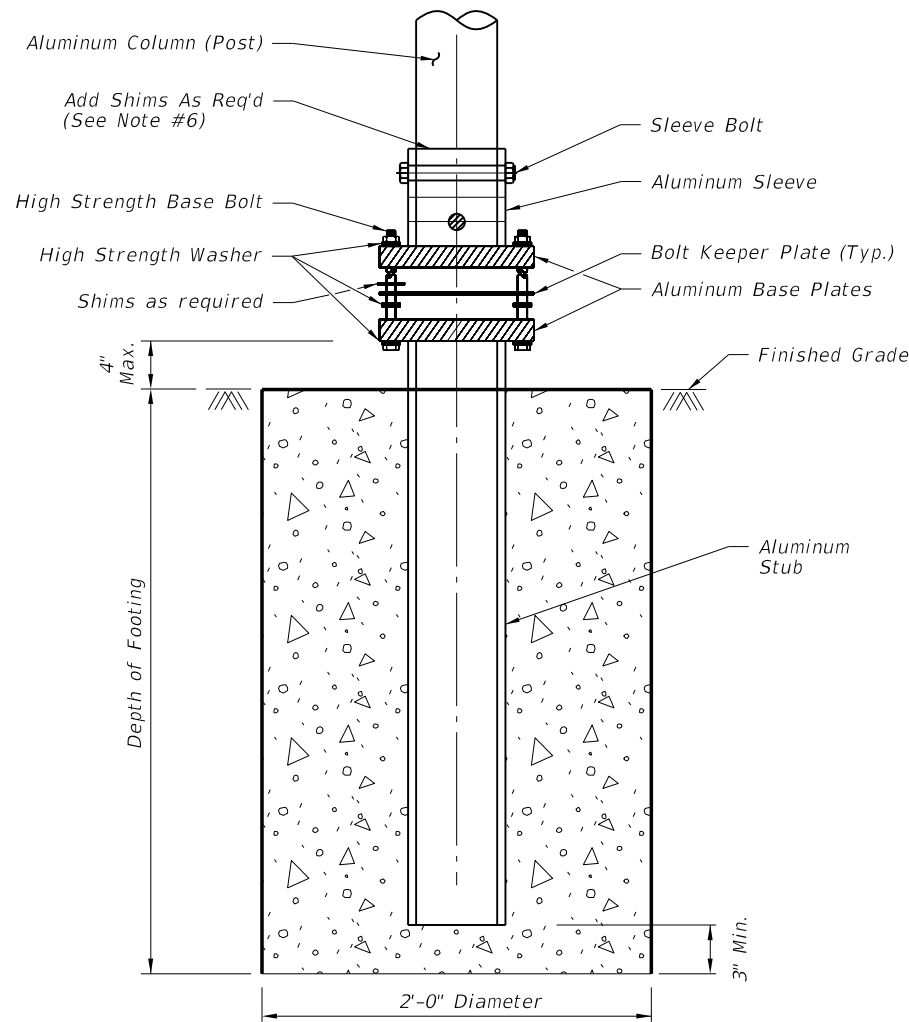

SLIP BASE AND FOOTING DETAIL (non-frangible post)

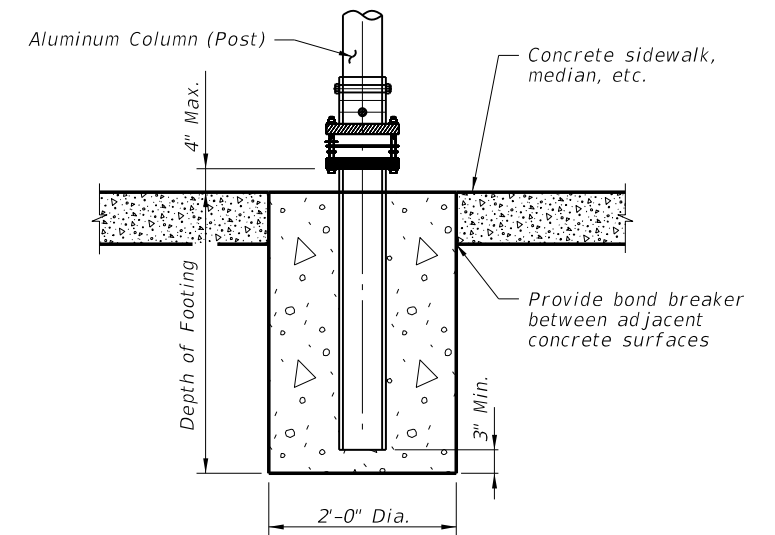

SLIP BASE AND FOOTING DETAIL IN CONCRETE (non-frangible post in crossovers, medians, & sidewalks)

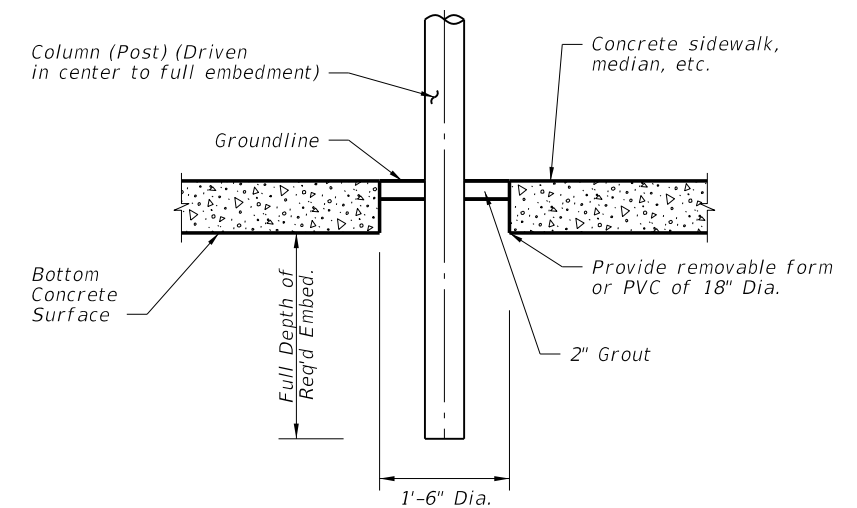

DRIVEN POST DETAIL IN CONCRETE (frangible post in crossovers, medians, & sidewalks)

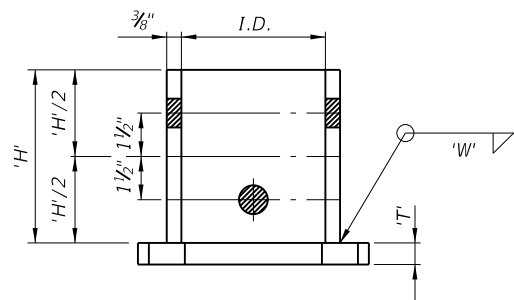

ALUMINUM SLEEVE & BASE PLATE DETAILS (DOUBLE BEVELED SLOTS)

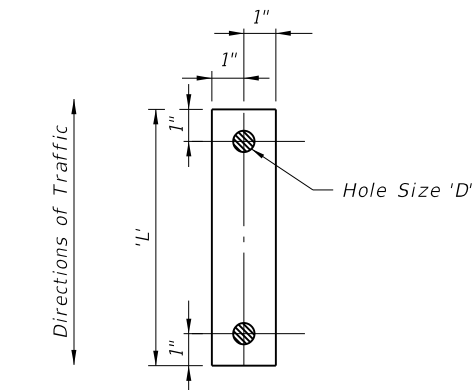

BOLT KEEPER PLATE DETAIL

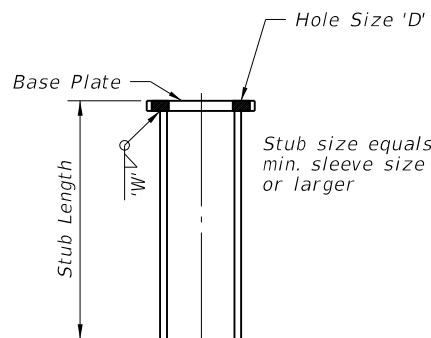

STUB DETAIL

SLIP BASE DETAILS















Column Size	Sleeve I.D. (Max)	Sleeve Height 'H'	Weld 'W'	Base Plate		Radius 'R'	Base Bolt Size	Base Bolt Length	Base Plate Torque		Hole Size 'D'
				'L'	'T'				ft.-lbs	in.-lbs	
4 x $\frac{1}{4}$	$4\frac{1}{16}$	6	$\frac{5}{8}$	8	$\frac{3}{4}$	$\frac{11}{32}$	$\frac{5}{8}$	3	29	345	$\frac{11}{16}$
$4\frac{1}{2}$ x $\frac{1}{4}$	$4\frac{9}{16}$	6	$\frac{5}{8}$	8	$\frac{7}{8}$	$\frac{11}{32}$	$\frac{5}{8}$	$3\frac{1}{4}$	29	345	$\frac{11}{16}$
5 x $\frac{1}{4}$	$5\frac{1}{16}$	7	$\frac{5}{8}$	8	$\frac{7}{8}$	$\frac{11}{32}$	$\frac{5}{8}$	$3\frac{1}{4}$	29	345	$\frac{11}{16}$
6 x $\frac{1}{4}$	$6\frac{1}{16}$	8	$\frac{11}{16}$	9	1	$\frac{13}{32}$	$\frac{3}{4}$	$3\frac{1}{2}$	46	554	$\frac{13}{16}$
8 x $\frac{5}{16}$	$8\frac{1}{16}$	10	$\frac{3}{4}$	11	1	$\frac{15}{32}$	$\frac{7}{8}$	$3\frac{3}{4}$	53	640	$\frac{15}{16}$



















Note: Unless noted otherwise, all dimensions are in inches.























BASE AND FOUNDATION DETAILS

6/5/2014 12:52:04 PM

6/5/2014 12:52:04 PM

	Size	Area	Total Area	Centroid
 	36x12	3.00 SF	6.31 SF	1.75 Ft.
	24x24	3.31 SF		
 	36x12	3.00 SF	8.18 SF	1.92 Ft.
	30x30	5.18 SF		
 	36x12	3.00 SF	10.46 SF	2.10 Ft.
	36x36	7.46 SF		
 	36x12	3.00 SF	16.25 SF	2.48 Ft.
	48x48	13.25 SF		
 	24x24	3.31 SF	6.31 SF	1.71 Ft.
	24x18	3.00 SF		
 	30x30	5.18 SF	10.18 SF	2.19 Ft.
	30x24	5.00 SF		
 	36x36	7.46 SF	12.46 SF	2.55 Ft.
	30x24	5.00 SF		

	Size	Area	Total Area	Centroid
  	36x12	3.00 SF	13.18 SF	2.87 Ft.
	30x30	5.18 SF		
	30x24	5.00 SF		
  	36x12	3.00 SF	15.46 SF	3.15 Ft.
	36x36	7.46 SF		
	30x24	5.00 SF		
 	21x15	2.19 SF	6.19 SF	1.60 Ft.
	24x24	4.00 SF		
	30x24	5.00 SF		
 	21x15	2.19 SF	7.19 SF	1.52 Ft.
	30x24	5.00 SF		
	24x12	2.00 SF		
  	24x12	2.00 SF	6.00 SF	1.53 Ft.
	24x24	4.00 SF		
	30x24	5.00 SF		
  	24x12	2.00 SF	7.00 SF	1.45 Ft.
	30x24	5.00 SF		
	30x15	3.13 SF		
  	30x15	3.13 SF	8.13 SF	1.66 Ft.
	30x24	5.00 SF		

	Size	Area	Total Area	Centroid
 	24x24	4.00 SF	6.19 SF	1.73 Ft.
	21x15	2.19 SF		
 	30x24	5.00 SF	7.19 SF	1.81 Ft.
	21x15	2.19 SF		
    	24x12	2.00 SF	8.19 SF	2.26 Ft.
	24x24	4.00 SF		
	21x15	2.19 SF		
    	24x12	2.00 SF	9.19 SF	2.27 Ft.
	30x24	5.00 SF		
	21x15	2.19 SF		
    	30x15	3.13 SF	10.32 SF	2.49 Ft.
	30x24	5.00 SF		
	21x15	2.19 SF		
   	24x12	2.00 SF	10.19 SF	2.80 Ft.
	24x12	2.00 SF		
	24x24	4.00 SF		
	21x15	2.19 SF		

LAST REVISION 07/01/07

REVISION

DESCRIPTION:











2015 DESIGN STANDARDS

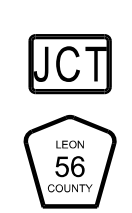
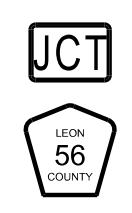
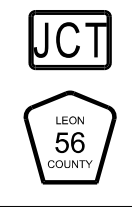

SINGLE COLUMN GROUND SIGNS

INDEX NO. 11860

SHEET NO. 6 of 8

	Size	Area	Total Area	Centroid
	24x12	2.00 SF	11.19 SF	2.76 Ft.
	24x12	2.00 SF		
	30x24	5.00 SF		
	21x15	2.19 SF		
	30x15	3.13 SF	13.45 SF	3.16 Ft.
	30x15	3.13 SF		
	30x24	5.00 SF		
	21x15	2.19 SF		
	21x15	2.19 SF	3.90 SF	1.57 Ft.
	18x18	1.71 SF		
	21x15	2.19 SF	5.22 SF	1.72 Ft.
	24x24	3.03 SF		
	21x15	2.19 SF	6.95 SF	1.87 Ft.
	30x30	4.76 SF		

	Size	Area	Total Area	Centroid
	18x18	1.71 SF	3.90 SF	1.26 Ft.
	21x15	2.19 SF		
	24x24	3.03 SF	5.22 SF	1.62 Ft.
	21x15	2.19 SF		
	30x30	4.76 SF	6.95 SF	1.97 Ft.
	21x15	2.19 SF		
	24x12	2.00 SF	9.39 SF	2.87 Ft.
	24x12	2.00 SF		
	24x24	3.20 SF		
	21x15	2.19 SF		
	24x12	2.00 SF	10.18 SF	2.84 Ft.
	24x12	2.00 SF		
	30x24	3.99 SF		
	21x15	2.19 SF		

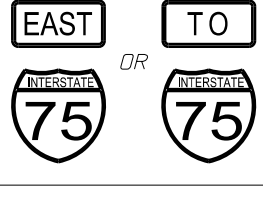
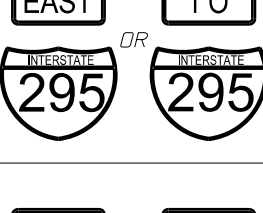
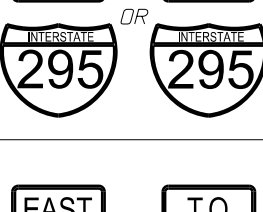
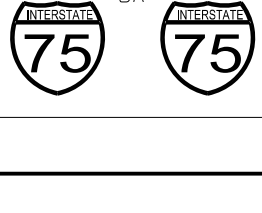
	Size	Area	Total Area	Centroid
	30x15	3.13 SF	12.44 SF	3.26 Ft.
	30x15	3.13 SF		
	30x24	3.99 SF		
	21x15	2.19 SF		
	21x15	2.19 SF	5.39 SF	1.75 Ft.
	24x24	3.20 SF		
	21x15	2.19 SF	6.18 SF	1.67 Ft.
	30x24	3.99 SF		
	24x12	2.00 SF	5.20 SF	1.67 Ft.
	24x24	3.20 SF		
	24x12	2.00 SF	5.99 SF	1.60 Ft.
	30x24	3.99 SF		
	30x15	3.13 SF	7.12 SF	1.81 Ft.
	30x24	3.99 SF		
	30x15	3.13 SF	10.33 SF	2.27 Ft.
	36x36	7.20 SF		

6/5/2014 12:52:05 PM

6/5/2014 12:52:05 PM

Size	Area	Total Area	Centroid
30x15	3.13 SF	12.12 SF	2.18 Ft.
45x36	8.99 SF		
Size	Area	Total Area	Centroid
24x12	2.00 SF	7.39 SF	2.30 Ft.
24x24	3.20 SF		
21x15	2.19 SF		
Size	Area	Total Area	Centroid
24x12	2.00 SF	8.18 SF	2.31 Ft.
30x24	3.99 SF		
21x15	2.19 SF		
Size	Area	Total Area	Centroid
30x15	3.13 SF	9.31 SF	2.55 Ft.
30x24	3.99 SF		
21x15	2.19 SF		
Size	Area	Total Area	Centroid
30x30	4.69 SF	6.69 SF	1.61 Ft.
24x12	2.00 SF		
Size	Area	Total Area	Centroid
30x30	4.69 SF	8.44 SF	1.77 Ft.
30x18	3.75 SF		
Size	Area	Total Area	Centroid
36x36	6.75 SF	10.50 SF	2.06 Ft.
30x18	3.75 SF		
Size	Area	Total Area	Centroid
36x36	6.75 SF	10.50 SF	2.06 Ft.
30x18	3.75 SF		

Size	Area	Total Area	Centroid
30x30	4.69 SF	6.69 SF	1.61 Ft.
24x12	2.00 SF		
Size	Area	Total Area	Centroid
30x30	4.69 SF	8.44 SF	1.77 Ft.
30x18	3.75 SF		
Size	Area	Total Area	Centroid
36x36	6.75 SF	10.50 SF	2.06 Ft.
30x18	3.75 SF		
Size	Area	Total Area	Centroid
30x30	6.25 SF	8.25 SF	2.28 Ft.
24x12	2.00 SF		
Size	Area	Total Area	Centroid
36x36	9.00 SF	12.75 SF	2.84 Ft.
30x18	3.75 SF		
Size	Area	Total Area	Centroid
30x30	6.25 SF	10.25 SF	2.74 Ft.
24x24	4.00 SF		
Size	Area	Total Area	Centroid
36x36	9.00 SF	15.25 SF	3.29 Ft.
30x30	6.25 SF		

Size	Area	Total Area	Centroid
30x30	6.25 SF	9.25 SF	2.51 Ft.
24x18	3.00 SF		
Size	Area	Total Area	Centroid
36x36	9.00 SF	14.00 SF	3.06 Ft.
30x24	5.00 SF		

LAST REVISION 07/01/07

DESCRIPTION: