

6/24/2013 7:18:32 PM sm970re C:\projects\standards\roadway\17300-s\17355-01.dgn

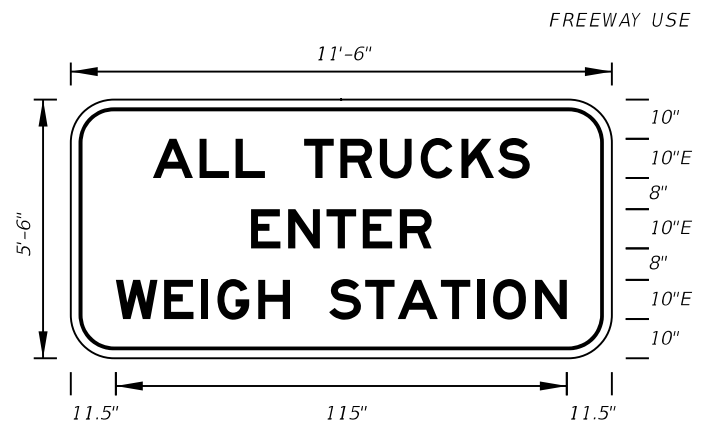

FTP-1-06
11'-6" X 5'-6"
9" Radii 2" Border
10" Series E Legend
White Background
Black Legend and Border

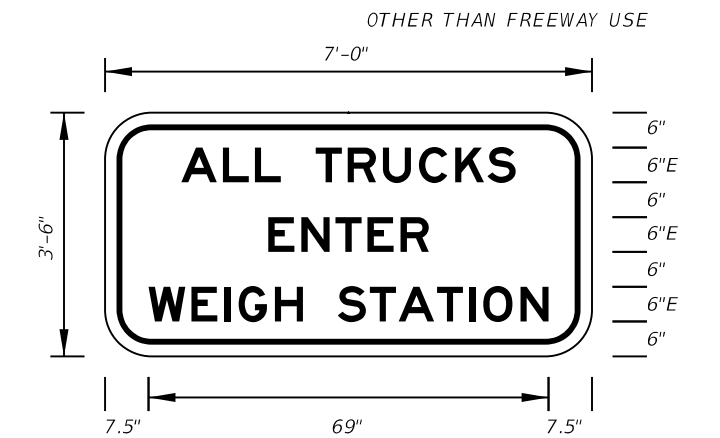

FTP-2-06
7' X 3'-6"
6" Radii 2" Border
6" Series E Legend
White Background
Black Legend and Border

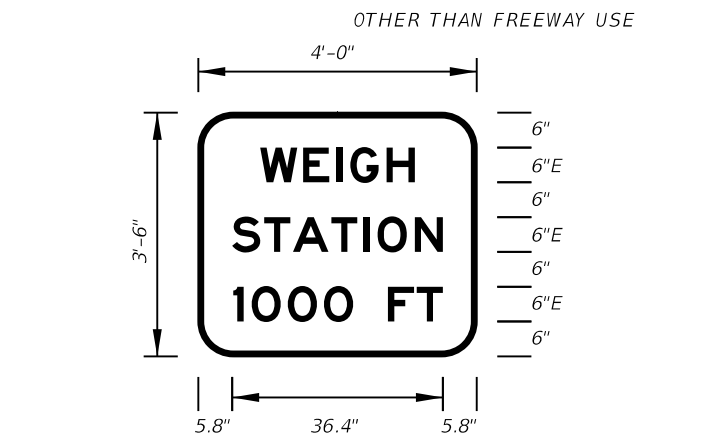

FTP-3-06
4' X 3'-6"
6" Radii 2" Border
6" Series E Legend
Green Background
White Legend and Border

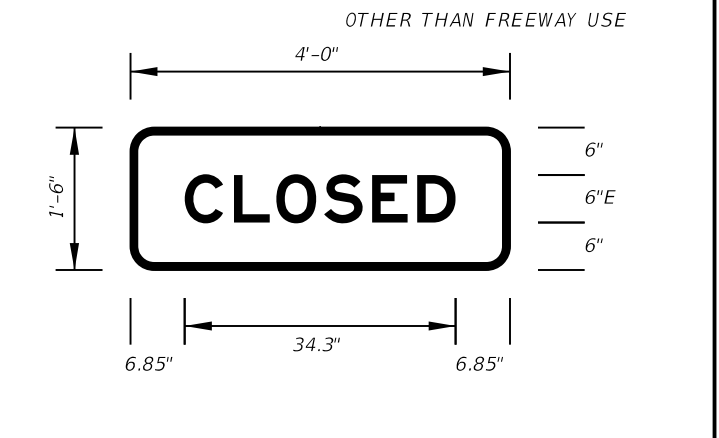

FTP-4-06
4' X 1'-6"
3" Radii 2" Border
6" Series E Legend
Green Background
White Legend and Border

Note:
FTP-4-06 to be used with FTP-3-06

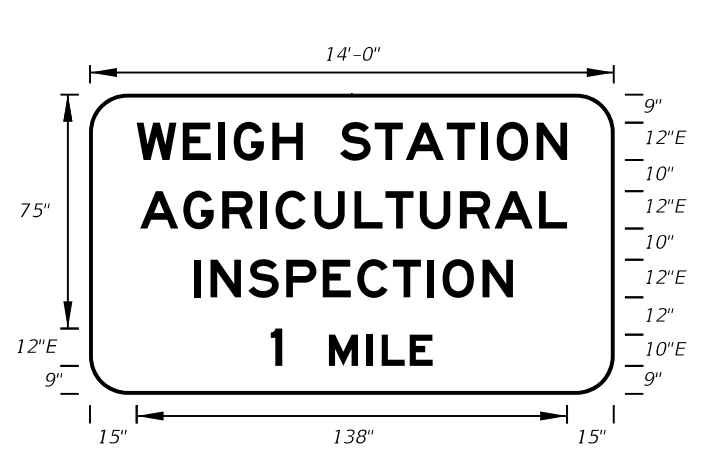

FTP-5-06
14' X 8'
12" Radii 2" Border
12" and 10" Series E Legend
Green Background
White Legend and Border

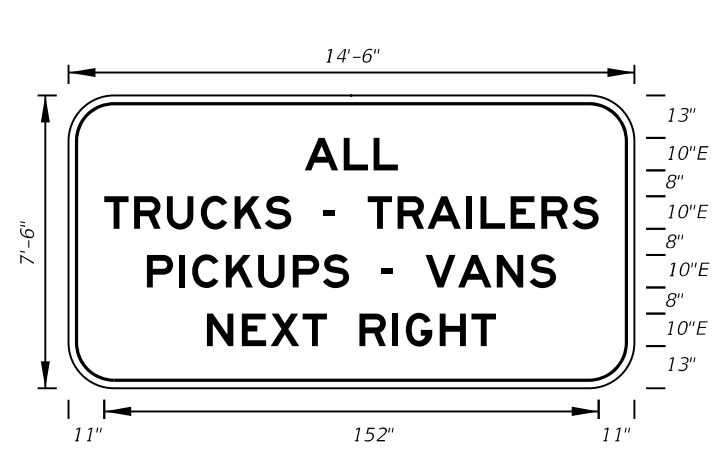

FTP-6A-06
14'-6" X 7'-6"
12" Radii 2" Border
10" Series E Legend
White Background
Black Legend and Border

On Interstate Station Delete Pickups-Vans, and reduce Sign height accordingly.

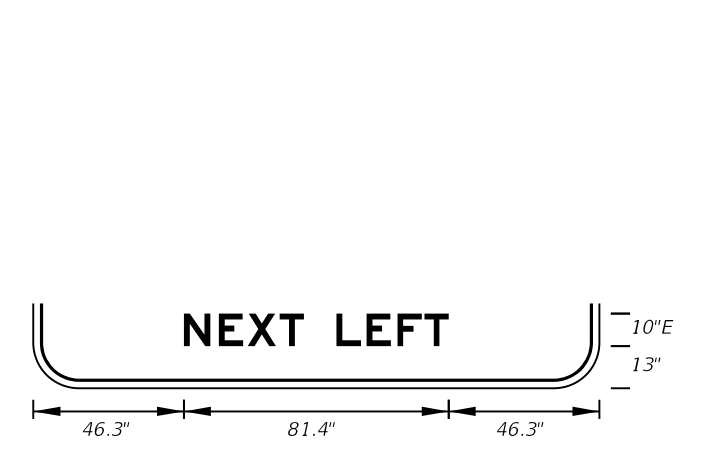

FTP-6B-06
14'-6" X 7'-6"
12" Radii 2" Border
10" Series E Legend
White Background
Black Legend and Border

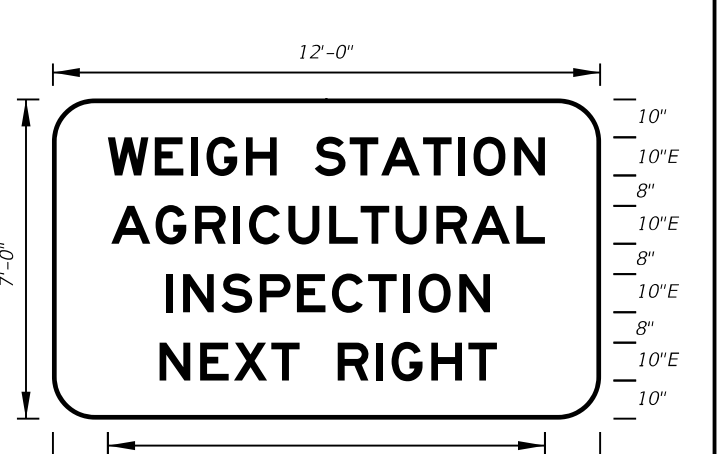

FTP-7A-06
12' X 7'
11" Radii 2" Border
10" Series E Legend
Green Background
White Legend and Border

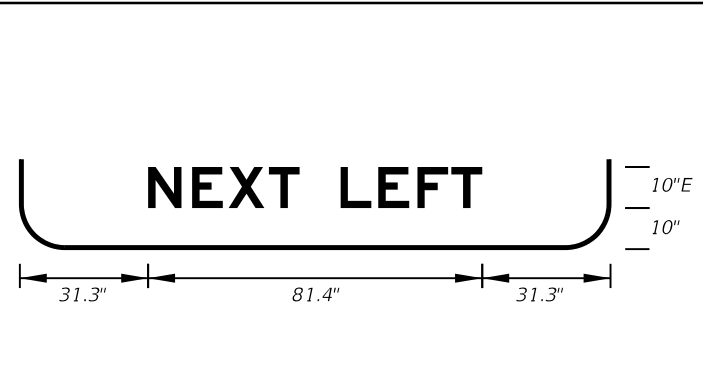

FTP-7B-06
12' X 7'
11" Radii 2" Border
10" Series E Legend
Green Background
White Legend and Border

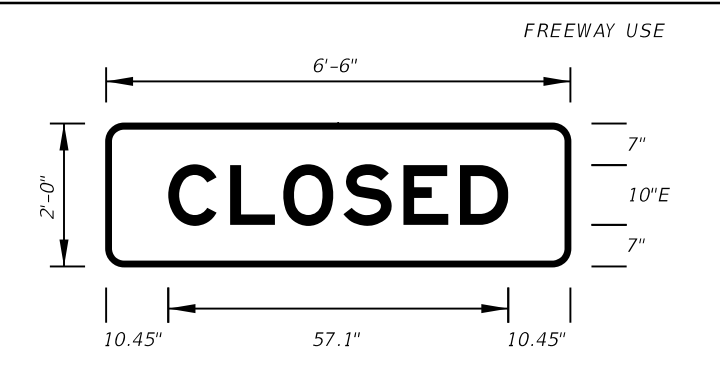

FTP-8-06
6'-6" X 2'
3" Radii 2" Border
10" Series E Legend
Green Background
White Legend and Border

Note:
FTP-8-06 to be used with FTP-7A-06 & FTP-7B-06.

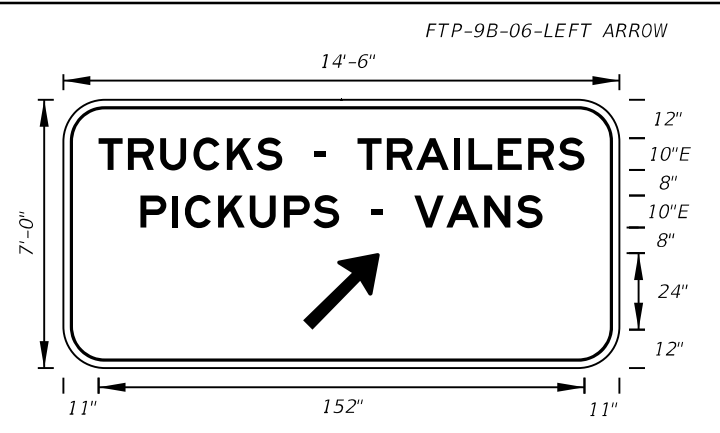

FTP-9A-06
14'-6" X 7'
11" Radii 2" Border

10" Series E Legend
Green Background
White Legend and Border

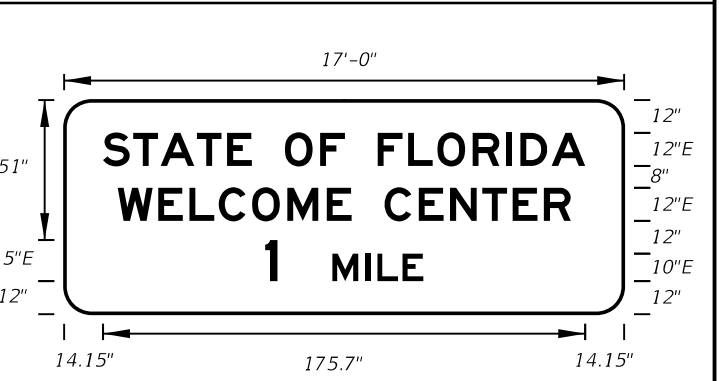

FTP-10-06
17' X 6'-6"
10" Radii 2" Border

12", 10" and 15" Series E Legend
Blue Background
White Legend and Border

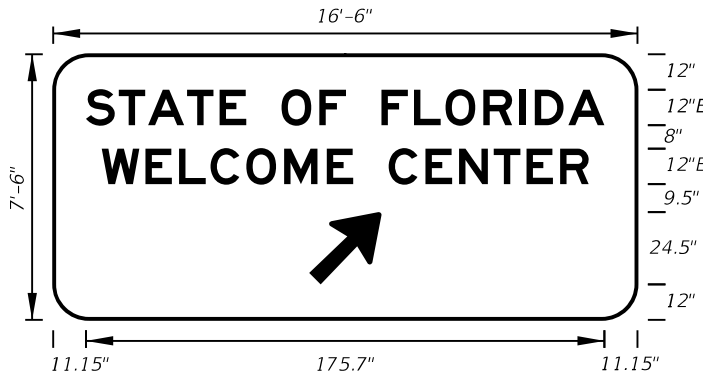

FTP-11-06
16'-6" X 7'-6"
12" Radii 2" Border
12" Series E Legend
Blue Background
White Legend and Border

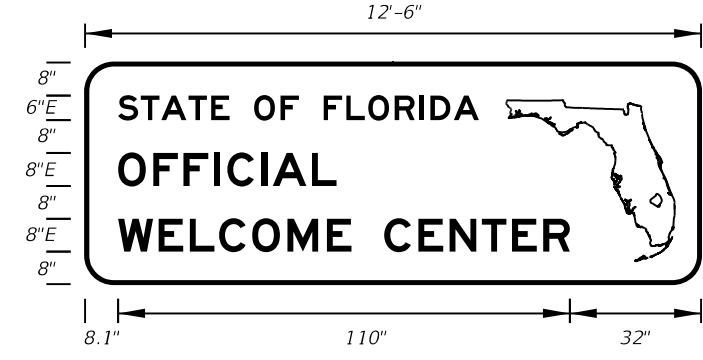

FTP-12-06
12'-6" X 4'-6"
7" Radii 2" Border
6" and 8" Series E Legend
Blue Background
White Legend and Border

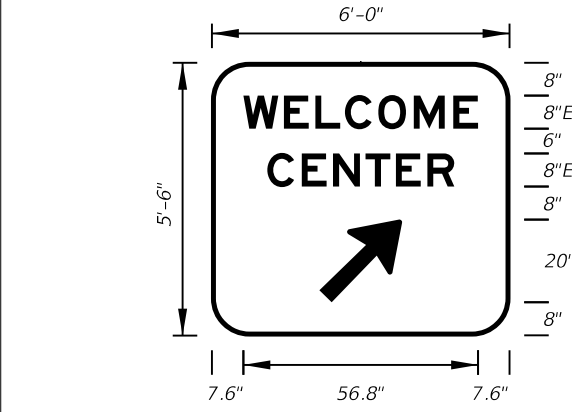

FTP-13-06
6' 0" X 5'-6"
9" Radii 2" Border
8" Series E Legend
Blue Background
White Legend and Border

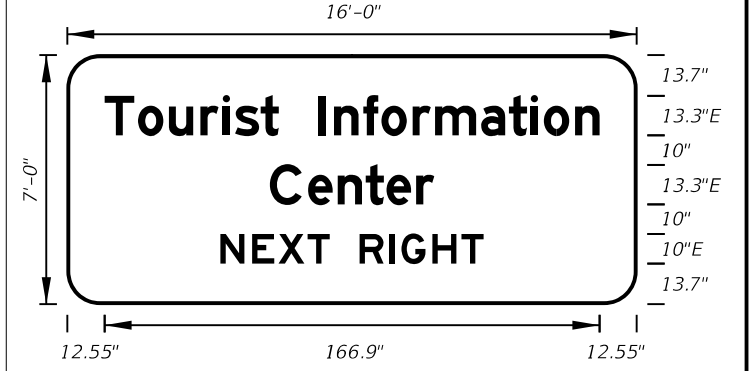

FTP-14-06
16'-0" X 7'-0"
11" Radii 2" Border
13.3 and 10" Series E Legend
Blue Background
White Legend and Border

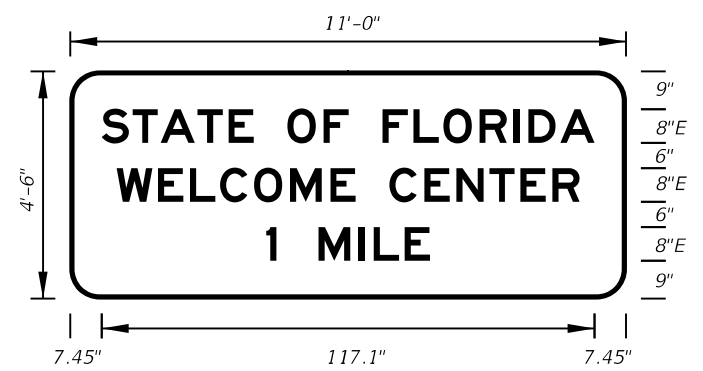

FTP-15A-06
11'-0" X 4'-6"
7" Radii 2" Border
8" Series E Legend
Blue Background
White Legend and Border

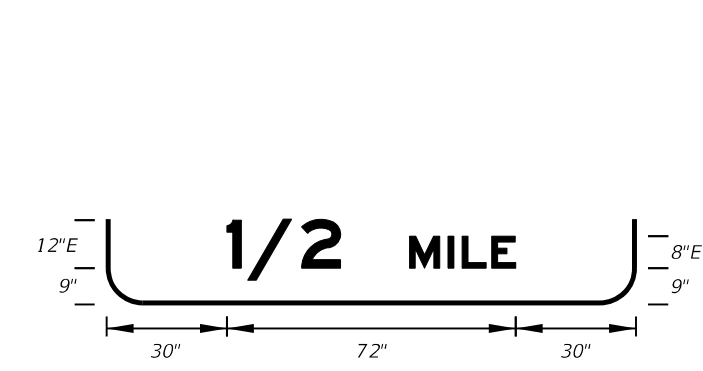

FTP-15B-06
11'-0" X 5'-0"
8" Radii 2" Border
8" and 12" Series E Legend
Blue Background
White Legend and Border

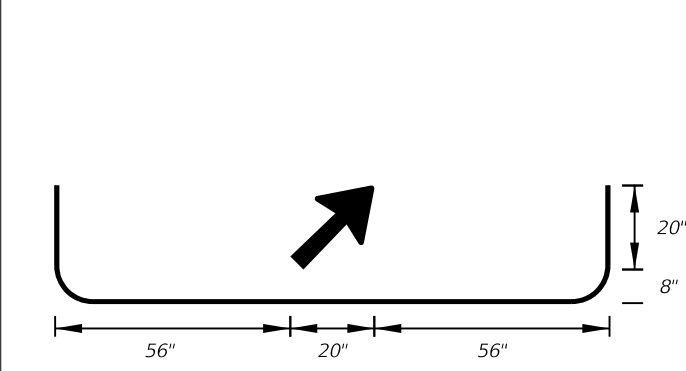

FTP-15C-06
11'-0" X 5'-6"
9" Radii 2" Border
8" Series E Legend
Blue Background
White Legend and Border

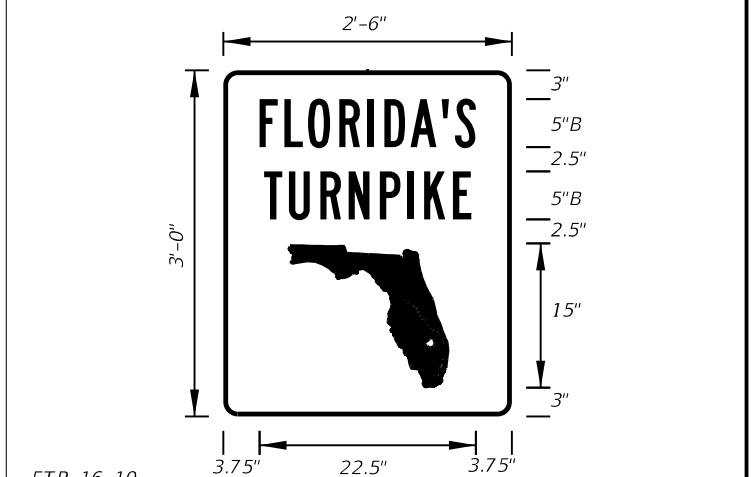

FTP-16-10
2'-6" X 3'-0"
1.5" Radii 3/4" Border
5" Series B Legend
Green Background
White Legend, Border, and Florida Symbol

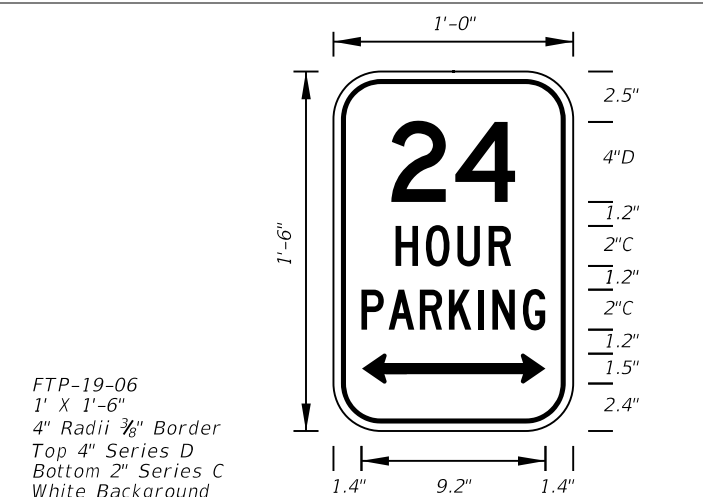

FTP-19-06
1' X 1'-6"
4" Radii 3/8" Border
Top 4" Series D
Bottom 2" Series C
White Background
Green Legend and Border

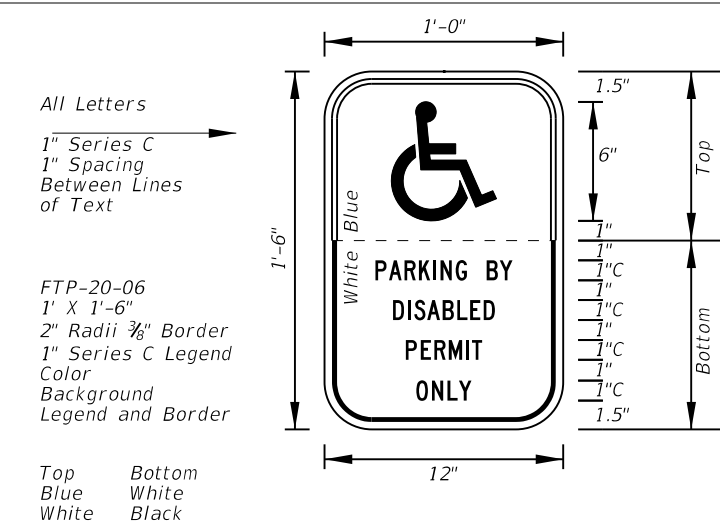

FTP-20-06
1' X 1'-6"
2" Radii 3/8" Border
1" Series C Legend
Color Background
Legend and Border

Top Blue
Bottom White
White Black

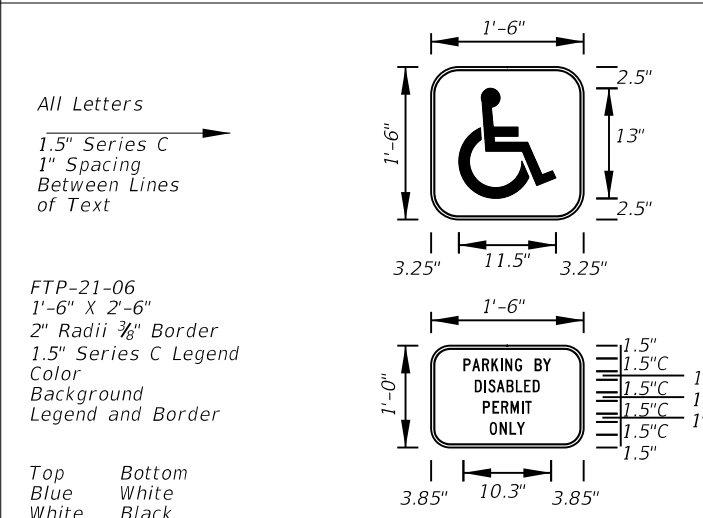

FTP-21-06
1'-6" X 2'-6"
2" Radii 3/8" Border
1.5" Series C Legend
Color Background
Legend and Border

Top Blue
Bottom White
White Black

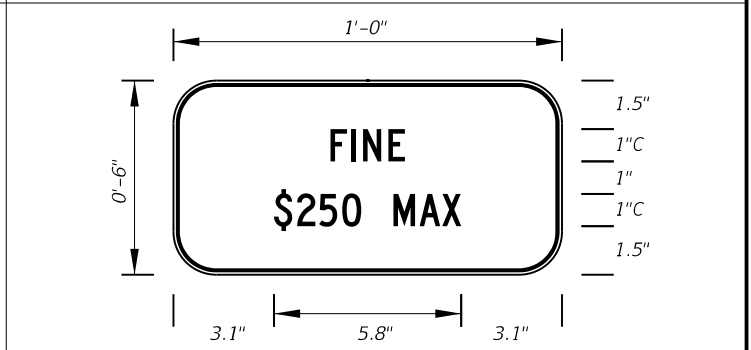

FTP-22-06
1' X 6"
1" Radii 3/8" Border
1" Series C Legend
White Background
Black Legend and Border

Supplemental Panel
for the FTP-20-06
and FTP-21-06 signs

6/24/2013 7:18:34 PM sm970re C:\projects\standards\roadway\17300-s\17355-02.dgn

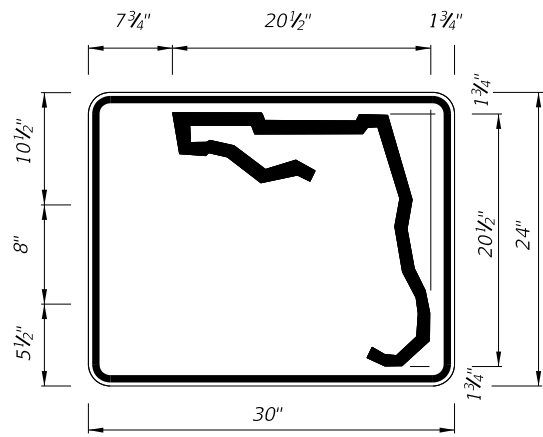

3 or 4 DIGITS

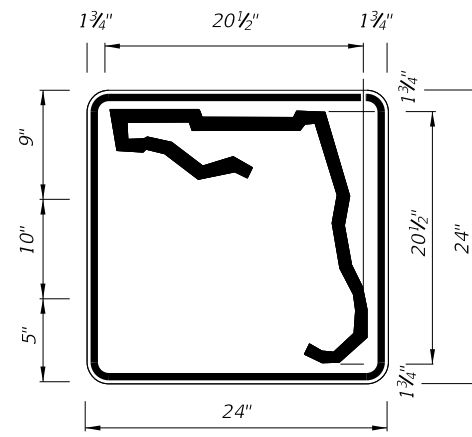

1 or 2 DIGITS

DIGITS	NUMERAL SIZE	SERIES	PANEL SIZE
1-2	10"	D	24" x 24"
3-4	8"	D	24" x 24"
3	8"	C	30" x 24"
4	8"	C	30" x 24"

Note:
The 24" X 24" panel shall only be used for a 3 or 4 digit route when the panel is to be used on a sign cluster with other 24" X 24" panels.

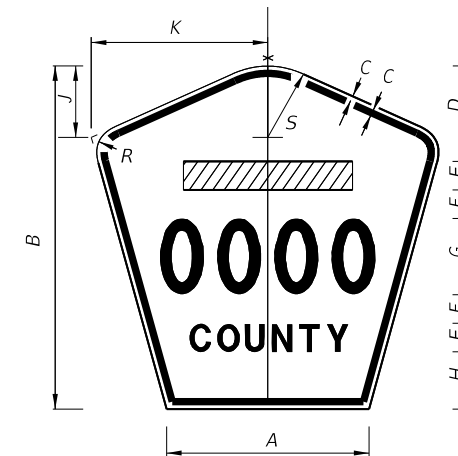

- Notes :
1. All Legend Series "D".
 2. Color: Yellow Legend and Border on Blue Background.
 3. When used on a guide sign, marker must be overlaid on a rectangular Yellow Background as shown in chart. **

INDEPENDENT USE OTHER THAN FREEWAY

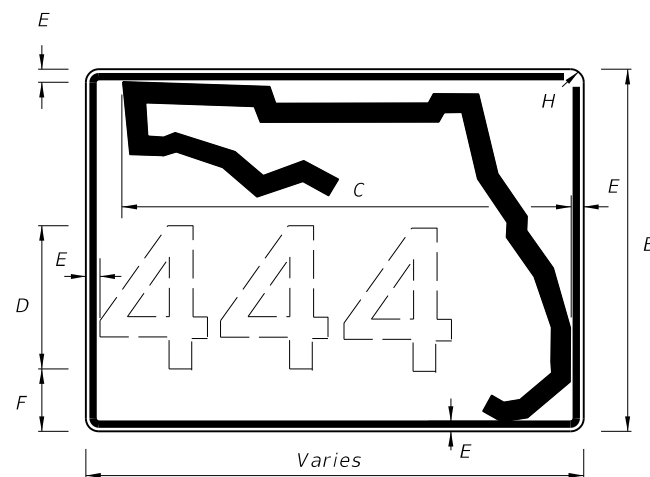

3 OR MORE DIGITS

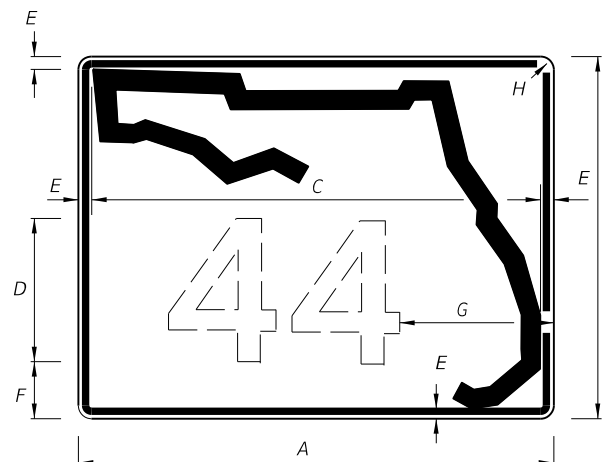

1 OR 2 DIGITS

SIGN	DIMENSIONS												**
	A	B	C	D	E	F	G	H	J	K	R	S	
4 DIGIT POST MOUNTED	25 1/8"	42"	3/4"	10"	4"	4"	8"	8"	8 3/8"	22"	5"	8 3/4"	
2 DIGIT OVERHEAD	21 1/2"	36"	1/2"	7 1/2"	3"	3"	12"	4 1/2"	7 1/8"	18 7/8"	4 1/4"	7 1/2"	42" x 42"
3 DIGIT OVERHEAD	25 1/8"	42"	3/4"	8"	4"	4"	12"	6"	8 3/8"	22"	5"	8 3/4"	48" x 48"
4 DIGIT OVERHEAD	29 7/8"	48"	3/4"	8"	5"	5"	12"	8"	9 3/4"	25 5/8"	5 3/4"	10 1/4"	52" x 52"

M-1-6 COUNTY ROUTE MARKER DETAIL
FTP-18-06

A	B	C	D	E	F	G	H
30"	24"	26"	12"	1 1/4"	2 3/4"	8 1/4"	1 1/4"
36"	30"	32"	15"	1 1/4"	3 1/4"	8 3/4"	1 1/4"
42"	36"	38"	15"	1 1/4"	6 1/4"	11"	1 1/4"

GUIDE SIGN USE

- Notes:
1. Florida marker shall have Black Legend with White Background.
 2. Stroke width of State outline to be 1" for independent use and 1 1/4" for Guide Sign.
 3. Numbers are series D.

FLORIDA ROUTE MARKER
FTP-17-06

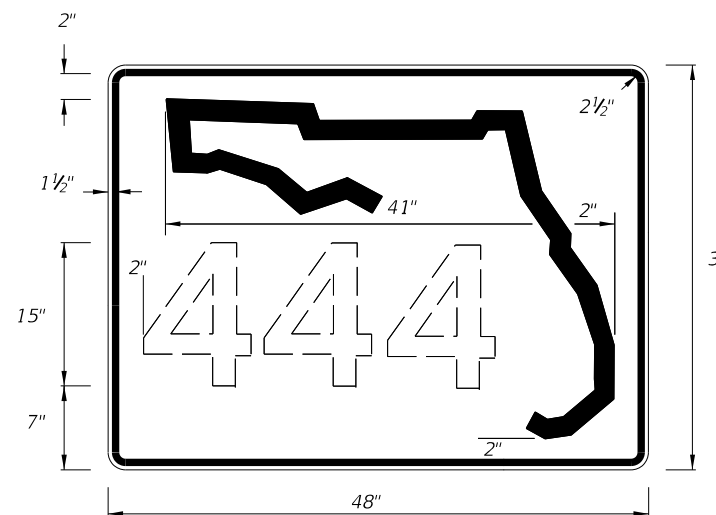

1-3 DIGITS 15" SERIES C
4 DIGITS 12" SERIES C
INDEPENDENT USE FOR FREEWAY

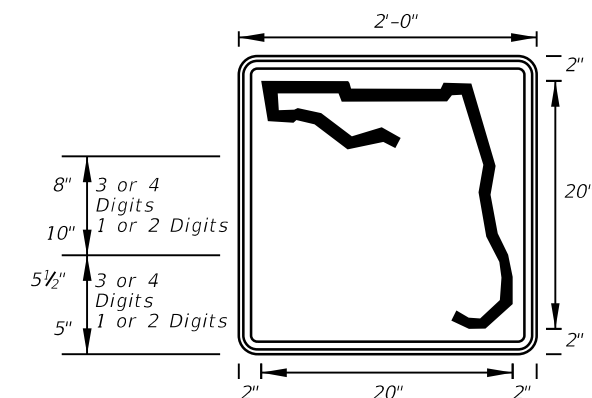

FTP-17-06
2' X 2'
1.13" Radii .0521" Border
White Background
Black Legend and Border

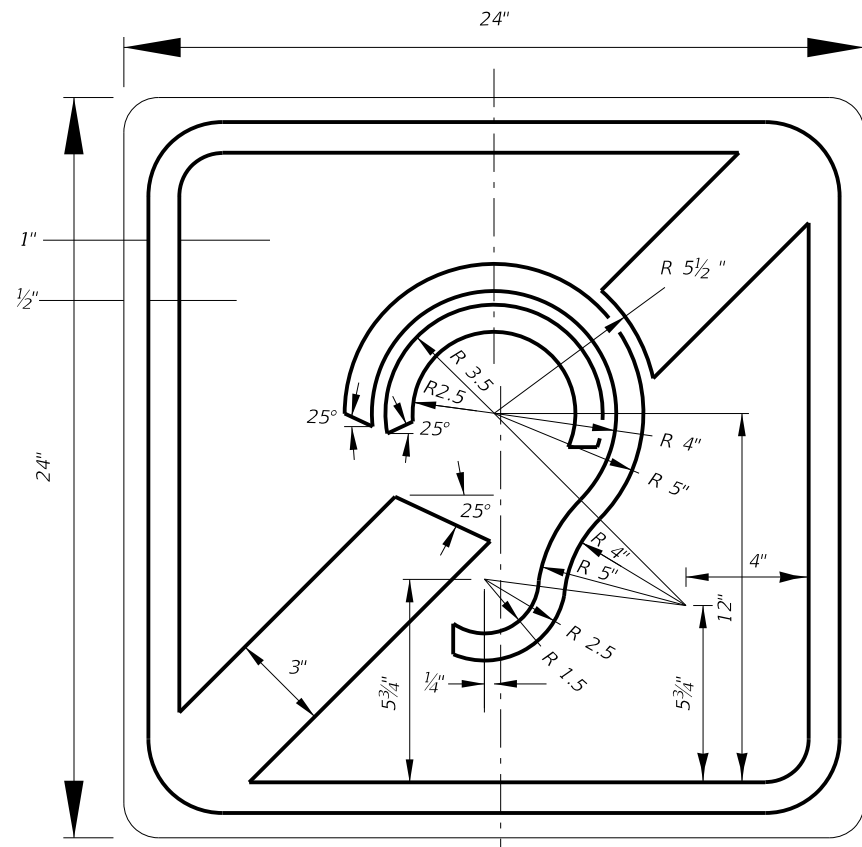

FTP-23-06
2' X 2'
1.5" Radii 5/8" Border
Blue Background
White Legend and Border

INTERNATIONAL SYMBOL OF
ACCESS FOR HEARING LOSS

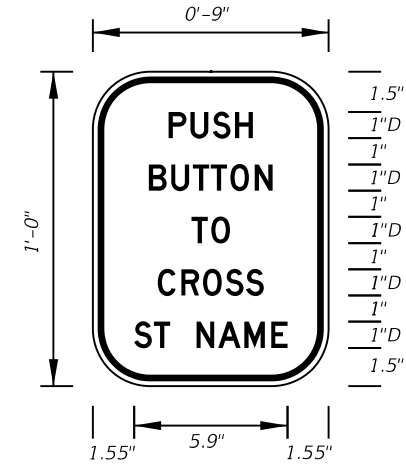

FTP-25-06
9" X 1'-0"
2" Radii 3/8" Border
1" Series D Legend
White Background
Black Legend and Border

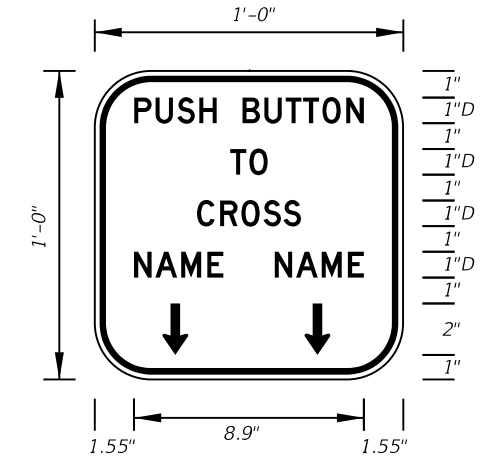

FTP-26-06
1' X 1'
2" Radii 3/8" Border
1" Series D Legend
White Background
Black Legend and Border

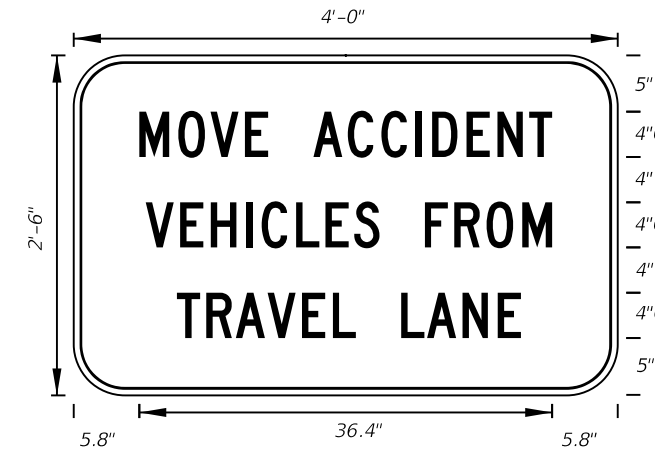

FTP-27-06
4' X 2'-6"
4" Radii 3/4" Border
4" Series C Legend
White Background
Black Legend and Border

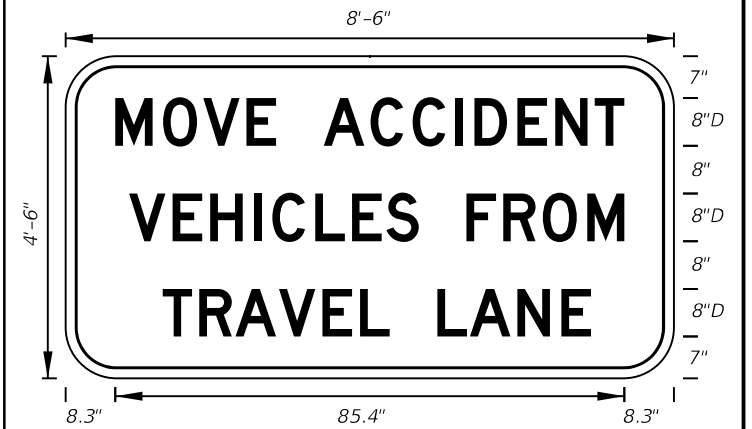

FTP-28-06
8'-6" X 4'-6"
7" Radii 3/4" Border
8" Series D Legend
White Background
Black Legend and Border

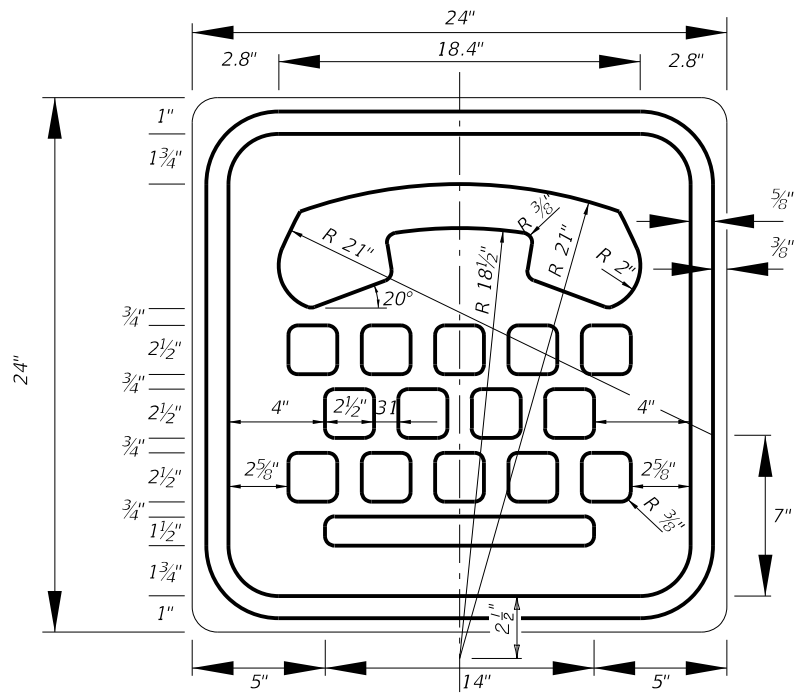

FTP-24-06
2' X 2'
1.5" Radii 5/8" Border
Blue Background
White Legend and Border

INTERNATIONAL TDD SYMBOL

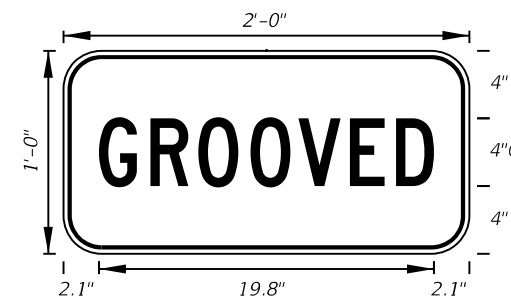

FTP-29-06
2'-0" X 1'-0"
2" Radii 5/8" Border
4" Series C Legend
Yellow Background
Black Legend and Border

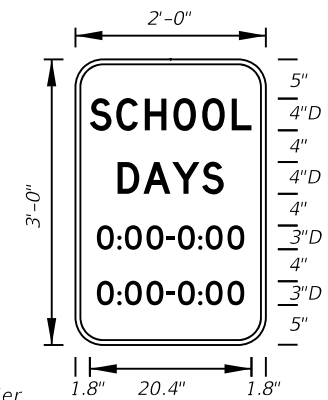

FTP-30-06
2'-0" X 3'-0"
3" Radii 5/8" Border
White Background
Black Legend and Border
Top 4" Series D Legend
Bottom 3" Series C Legend

6/24/2013 7:18:38 PM sm970re C:\projects\standards\roadway\17300-s\17355-04.dgn

6/24/2013 7:18:39 PM sm970re C:\projects\standards\roadway\17300-s\17355-05.dgn

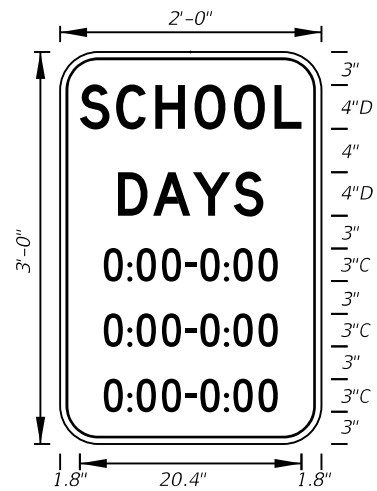

FTP-30A-06
2' X 3'
3" Radii 5/8" Border
Top 4" Series D Legend
Bottom 3" Series C Legend
White Background
Black Legend and Border

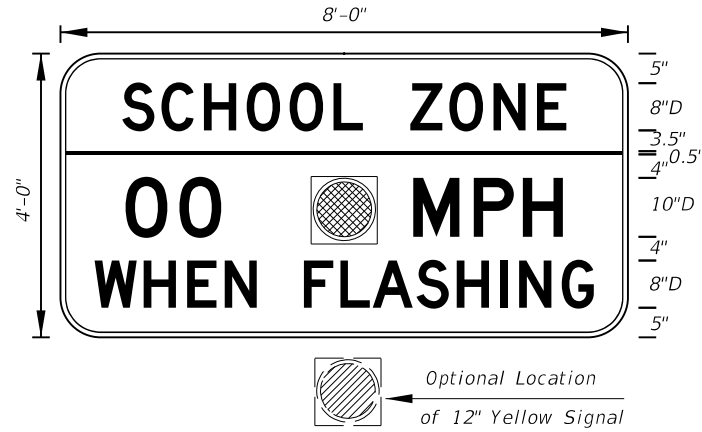

FTP-31-06
8' X 4'
6" Radii 3/4" Border
Series D Legend
Yellow Background Top
White Background Bottom
Black Legend and Border

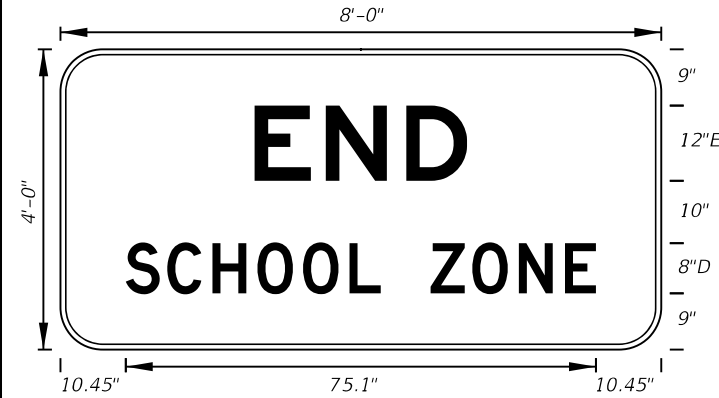

FTP-32-06
8' X 4'
6" Radii 3/4" Border
12" Series E and 8" Series D Legend
White Background
Black Legend and Border

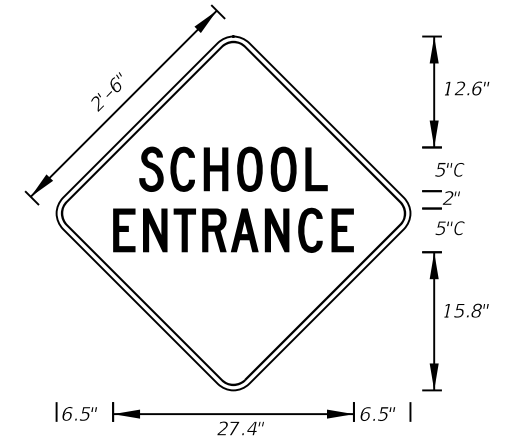

FTP-33-06
2'-6" X 2'-6"
2" Radii 3/4" Border
5" Series C Legend
Yellow Background
Black Legend and Border

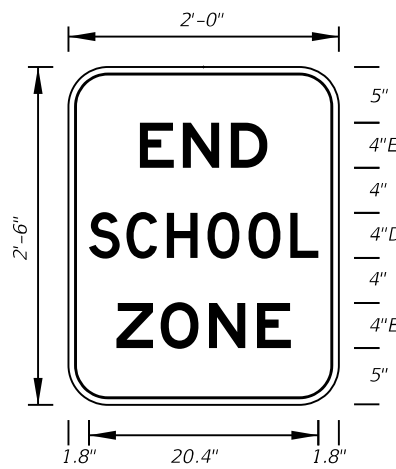

FTP-34-06
2' X 2'-6"
3" Radii 5/8" Border
4" Series D and E Legend
White Background
Black Legend and Border

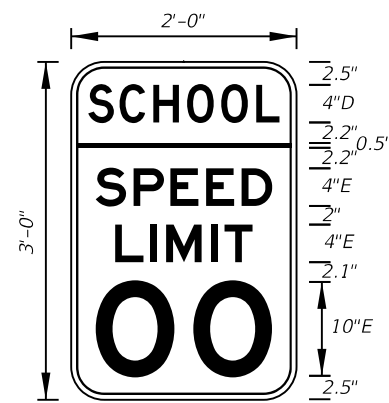

FTP-35-06
2' X 3'
3" Radii 5/8" Border
Top 4" Series D Legend
Bottom 4" and 10" Series E Legend
Yellow Background Top White Background Bottom
Black Legend and Border

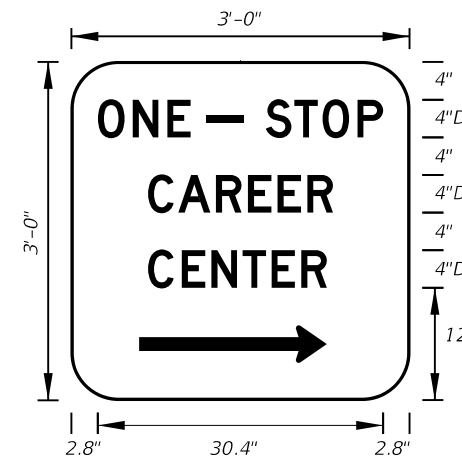

FTP-36-06
3' X 3'
5" Radii
4" Series D Legend
Green Background
White Legend and Border

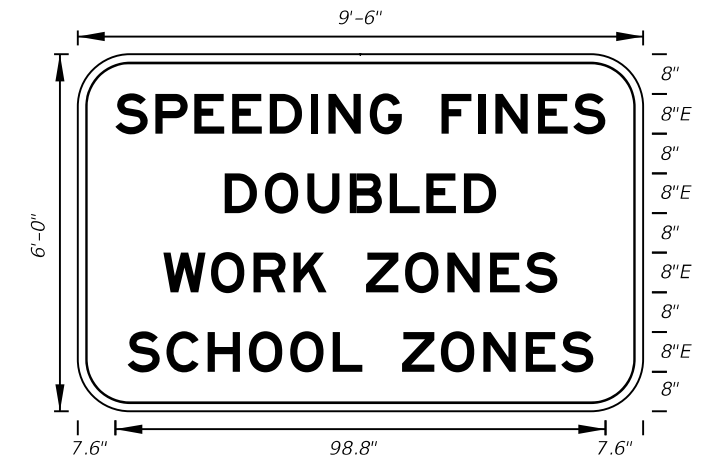

FTP-37-06
9'-6" X 6'
9" Radii 2" Border
8" Series E Legend
White Background
Black Legend and Border
State Line Sign

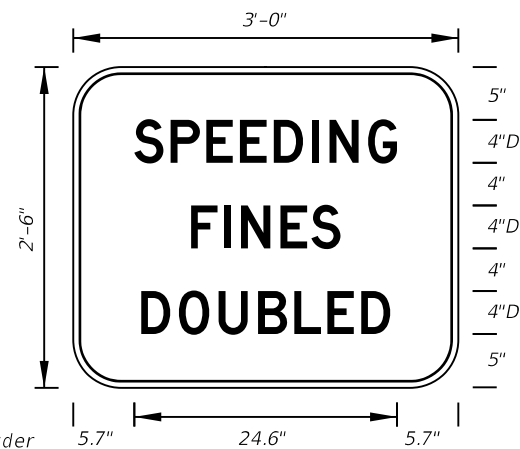

FTP-38-06
3' X 2'-6"
4" Radii 3/4" Border
4" Series D Legend
White Background
Black Legend and Border
Arterial Sign

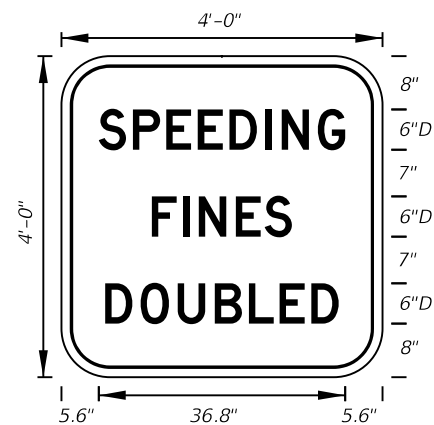

FTP-39-06
4' X 4'
6" Radii 3/4" Border
6" Series D Legend
White Background
Black Legend and Border
Freeway Sign



FTP-40-06
3'-6" X 4'
6" Radii 3/4" Border
3" and 6" Series C Legend
White Background
Black Legend and Border

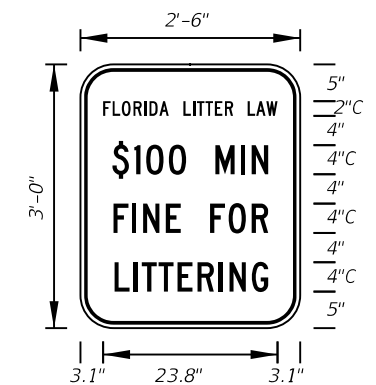

FTP-41-06
2'-6" X 3'
4" Radii 3/4" Border
2" and 4" Series C Legend
White Background
Black Legend and Border

LAST REVISION 01/01/12	REVISION	DESCRIPTION:	 <p>FDOT 2014 DESIGN STANDARDS</p>	SPECIAL SIGN DETAILS	INDEX NO. 17355	SHEET NO. 5 of 12
---------------------------	----------	--------------	---	----------------------	--------------------	----------------------

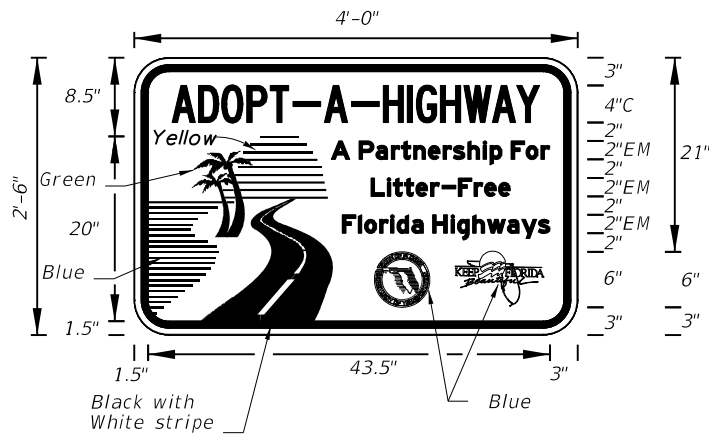

FTP-42-06
4' X 2'-6"
3" Radii
Top 4" Series C Legend
Bottom 2" Series EM Legend
White Background
Blue Legend and Border

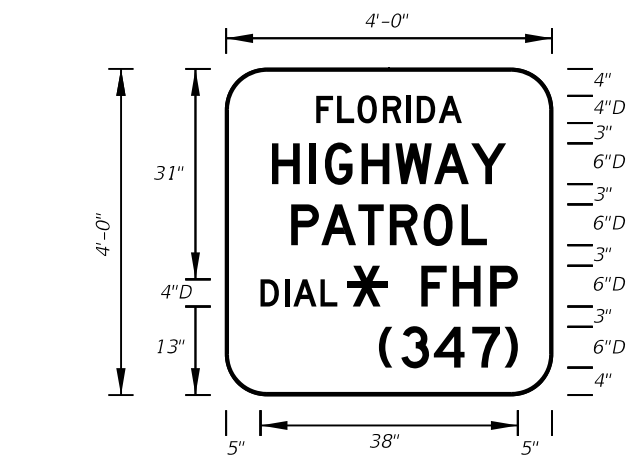

FTP-43-06
4' X 4'
6" Radii 1" Border
Top 4" Series D Legend
Bottom 6" Series D Legend
Blue Background
White Legend and Border



FTP-44-06
9' X 6'
9" Radii 3/4" Border
8" Series D Legend
White Background
Black Legend and Border

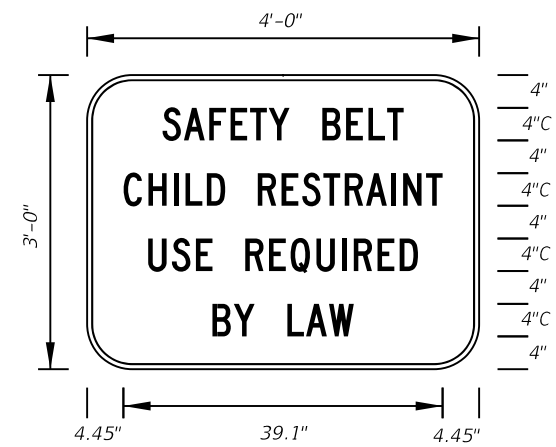

FTP-45-06
4' X 3'
5" Radii 3/4" Border
4" Series C Legend
White Background
Black Legend and Border

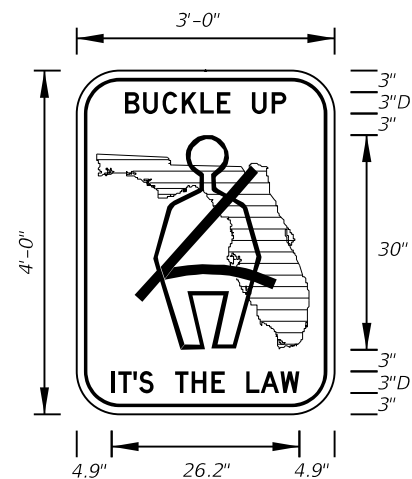

FTP-46-06
3' X 4'
5" Radii 3/4" Border
3" Series D Legend
White Background Florida Shield Green
Black Legend, Border and Man Belt Symbol

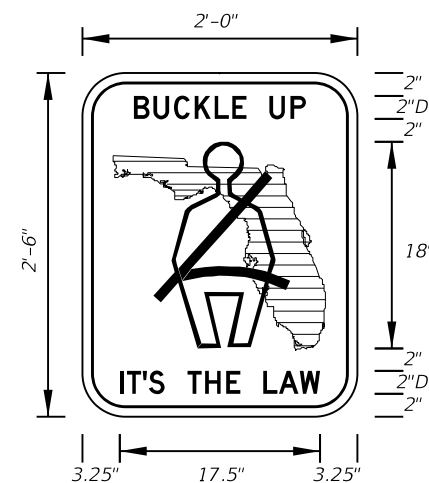

FTP-47-06
2' X 2'-6"
3" Radii 3/8" Border
2" Series D Legend
White Background Florida Shield Green
Black Legend, Border and Man Belt Symbol

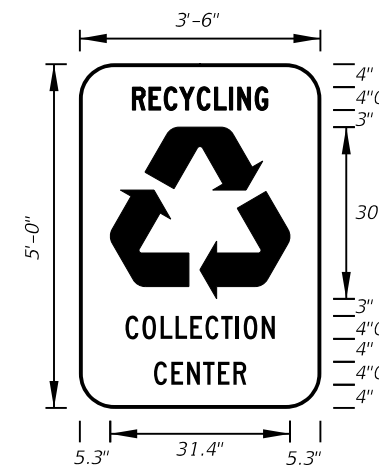

FTP-48-06
3'-6" X 5'
6" Radii
4" Series C Legend
Green Background
White Legend, Border and Symbol

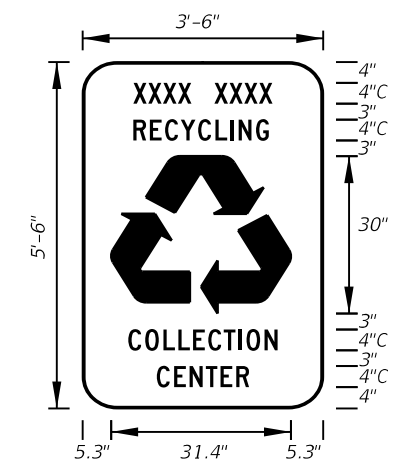

FTP-49-06
3'-6" X 5'-6"
6" Radii
4" Series C Legend
Green Background Municipality Name Optional
White Legend, Border and Symbol

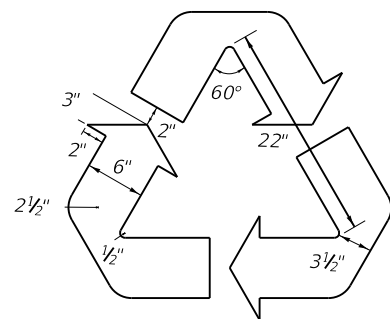

Detail for FTP-48-06 and FTP-49-06

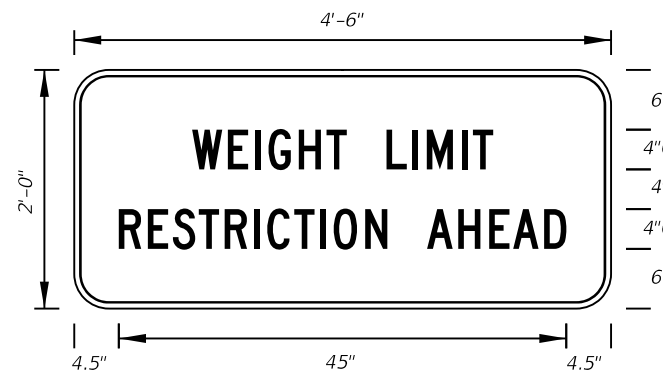

FTP-50-06
4'-6" X 2'
3" Radii 3/4" Border
4" Series C Legend
Yellow Background
Black Legend and Border

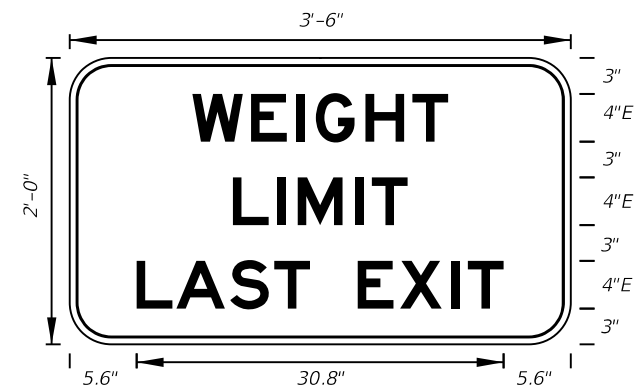

FTP-51-06
3' X 2'
3" Radii 3/4" Border
4" Series E Legend
White Background
Black Legend and Border

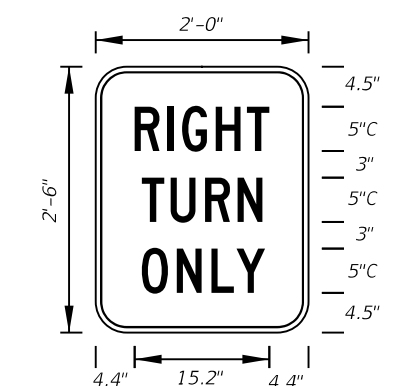

FTP-52-06
2' X 2'-6"
3" Radii 3/8" Border
5" Series C Legend
White Background
Black Legend and Border

6/24/2013 7:18:41 PM sm970re C:\projects\standards\roadway\17300-s\17355-06.dgn

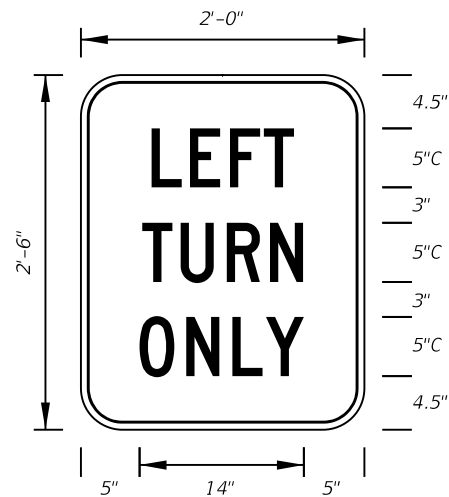

FTP-53-06
2' X 2'-6"
3" Radii 5/8" Border
5" Series C Legend
White Background
Black Legend and Border

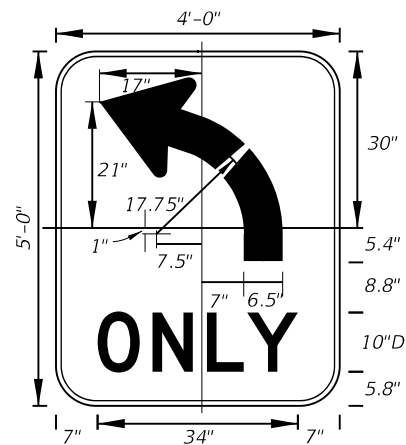

FTP-54L-06
4' X 5'
6" Radii 3/4" Border
10" Series D Legend
White Background
Black Legend and Border

FTP-54R-06 for
(Right Turn Arrow)

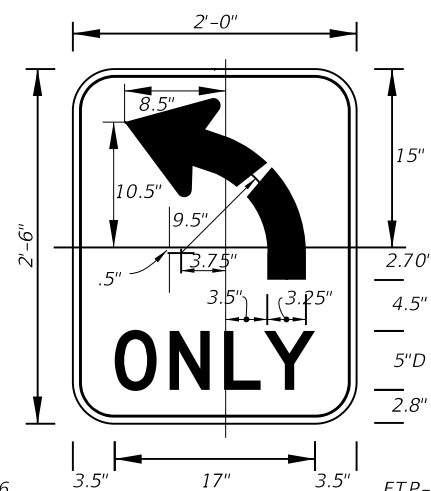

FTP-55L-06
2' X 2'-6"
3" Radii 5/8" Border
5" Series D Legend
White Background
Black Legend and Border

FTP-55R-06 for
(Right Turn Arrow)



FTP-56-06
6'-6" X 4'
6" Radii 3/4" Border
8" and 6" Series D Legend
Blue Background
White Legend and Border

Design Project Manager
or Transit Administrator
will supply correct 1-8XX
number.

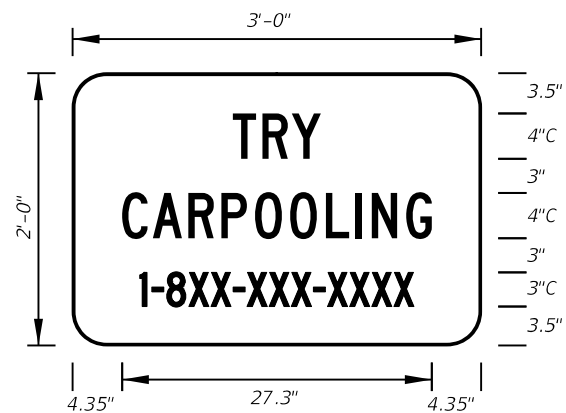

FTP-56A-06
3' X 2'
3" Radii
4" and 3" Series C Legend
Blue Background
White Legend and Border

Design Project Manager
or Transit Administrator
will supply correct 1-8XX
number.

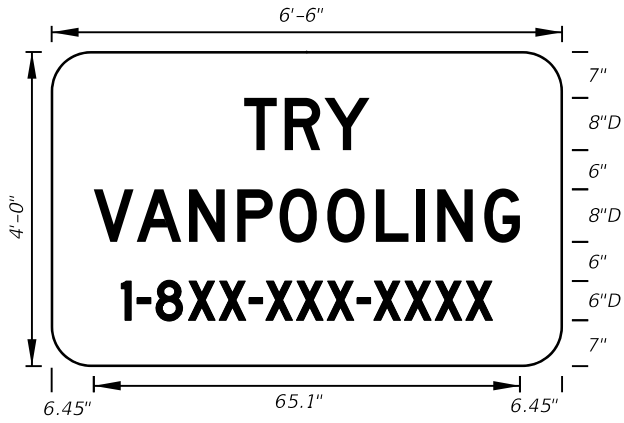

FTP-57-06
6'-6" X 4'
6" Radii
8" and 6" Series D Legend
Blue Background
White Legend and Border

Design Project Manager
or Transit Administrator
will supply correct 1-8XX
number.

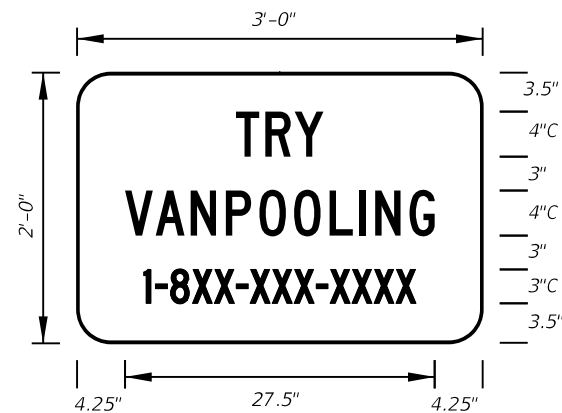

FTP-58-06
3' X 2'
3" Radii
4" and 3" Series C Legend
Blue Background
White Legend and Border

Design Project Manager
or Transit Administrator
will supply correct 1-8XX
number.

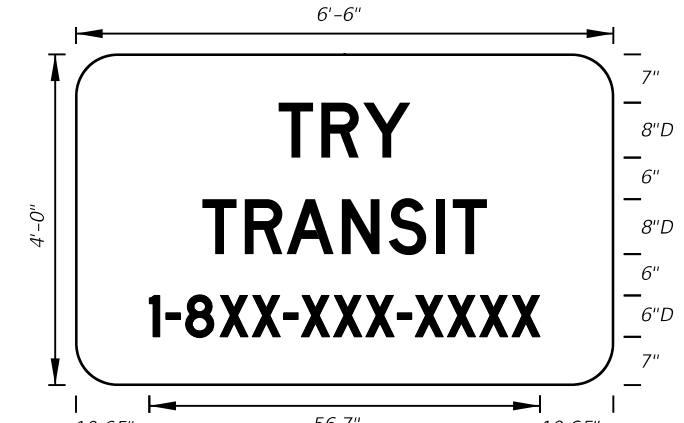

FTP-59-06
6'-6" X 4'
6" Radii
8" and 6" Series D Legend
Blue Background
White Legend and Border

Design Project Manager
or Transit Administrator
will supply correct 1-8XX
number.

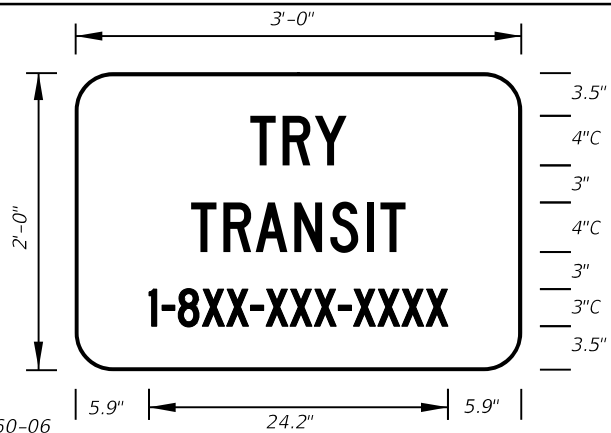

FTP-60-06
3' X 2'
3" Radii
4" and 3" Series C Legend
Blue Background
White Legend and Border

Design Project Manager
or Transit Administrator
will supply correct 1-8XX
number.



FTP-61-06
3' X 2'
3" Radii 3/4" Border
4" and 3" Series C Legend
Yellow Background
Black Legend and Border

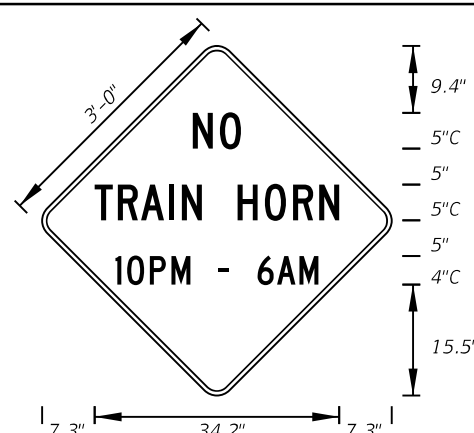

FTP-62-06
3' X 3'
2" Radii 3/4" Border 4" and 5" Series C Legend
Yellow Background Black Legend and Border

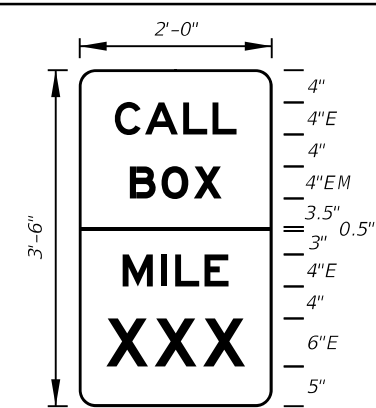

FTP-63-06
2' X 3'-6"
2" Radii 4" and 6" Series E and EM Legend
Top Blue Background White Legend and Border
Bottom Green Background White Legend and Border

6/24/2013 7:18:43 PM sm970re C:\projects\standards\roadway\17300-s\17355-07.dgn

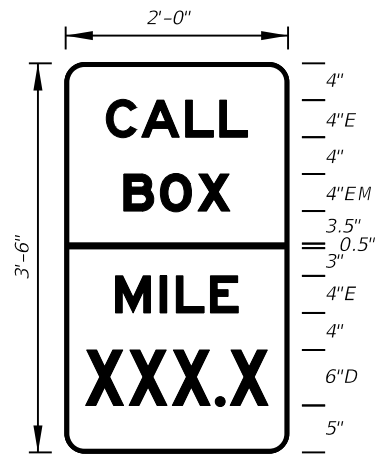

FTP-64-06
2' X 3'-6"
2" Radii
Top 4" Series E and 4" Series EM Legend
Blue Background White Legend and Border
Bottom 4" Series E and 6" Series D Legend
Green Background White Legend and Border

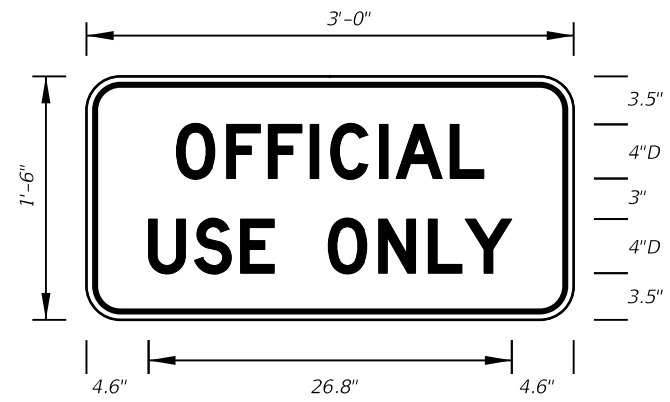

FTP-65-06
3' X 1'-6"
2" Radii 3/4" Border
4" Series D Legend
White Background
Black Legend and Border



FTP-66-06
4' X 5'
2" Radii 3/4" Border
7" Series D Legend
Blue Background
White Legend and Border



FTP-67-06
3' X 4'
2" Radii 3/4" Border
5" Series D Legend
Blue Background
White Legend and Border



DETAIL for FTP-66 AND FTP-67

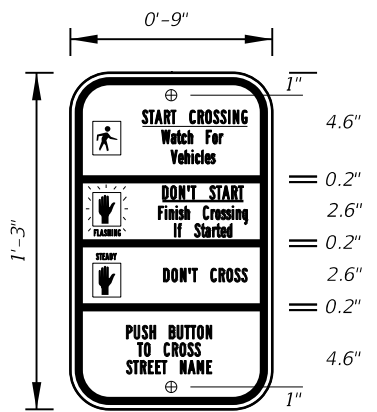

FTP-68A-06
9" X 1'-3"
1.5" Radii 3/4" Border
Series B Legend
White Background
Black Legend and Border

See Standard Highway Signs Manual, Sign R10-3b For Letter Size Spacing And Symbol Sizes.

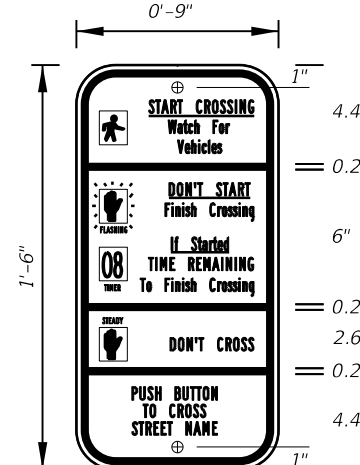

FTP-68B-06
9" X 1'-6"
1.5" Radii 3/4" Border
Series B Legend
White Background
Black Legend and Border

See Standard Highway Signs Manual, Sign R10-3b For Letter Size Spacing And Symbol Sizes.

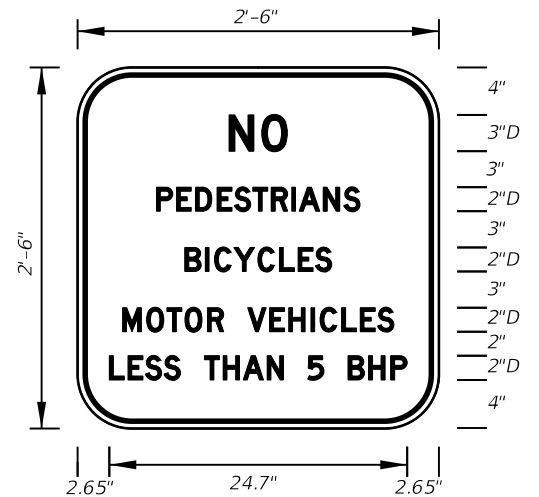

FTP-69-06
2'-6" X 2'-6"
4" Radii 3/4" Border
2" and 3" Series D Legend
White Background
Black Legend and Border



FTP-70-06
3'-6" X 2'-6"
2.25" Radii 3/4" Border
5" Series C and 7" Series C Legend
Blue Background
White Legend and Border

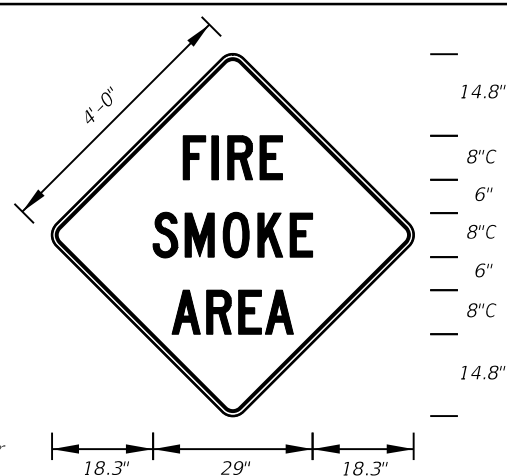

FTP-71-06
4' X 4'
2" Radii 3/4" Border
8" Series C Legend
Yellow Background
Black Legend and Border



FTP-72-06
3' X 3'
2" Radii 3/4" Border

6" Series C Legend
Yellow Background
Black Legend and Border

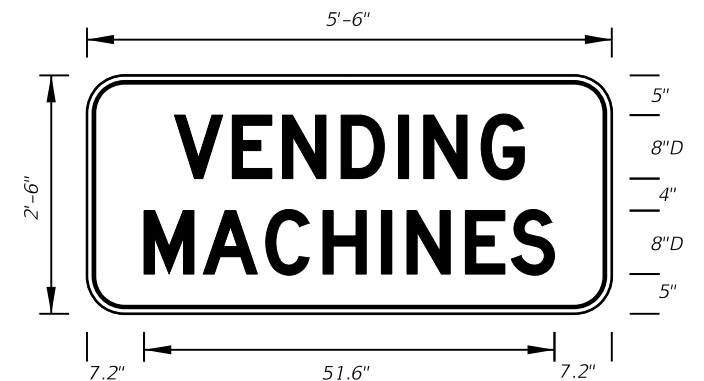

FTP-73-06
5'-6" X 2'-6"
4" Radii 3/4" Border

8" Series D Legend
Blue Background
White Legend and Border

6/24/2013 7:18:45 PM sm970re C:\projects\standards\roadway\17300-s\17355-08.dgn



FTP-74-06
5'-6" X 2'-6"
4" Radii 3/4" Border
6" Series D Legend
Blue Background
White Legend and Border

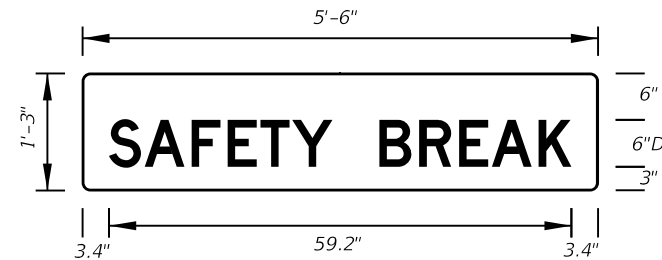

FTP-75-06
5'-6" X 1'-3"
1" Radii
6" Series D Legend
Blue Background
White Legend

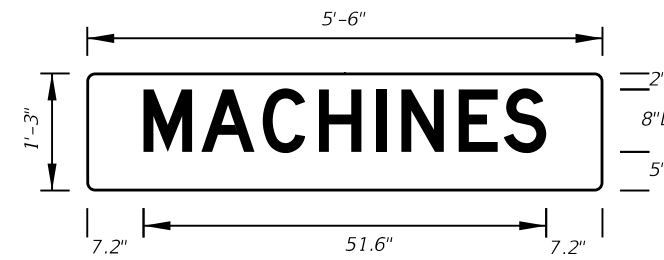

FTP-76-06
5'-6" X 1'-3"
1" Radii
8" Series D Legend
Blue Background
White Legend

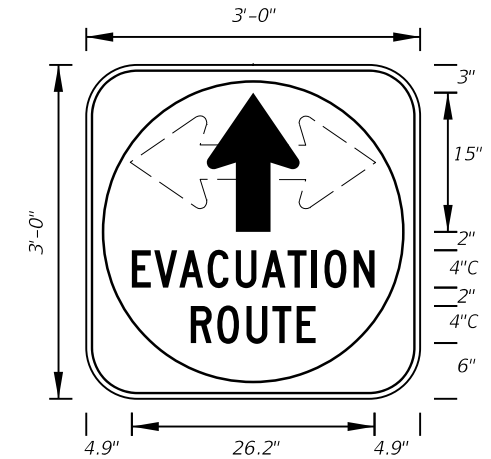

FTP-77-06
3' X 3'
5" Radii 3/4" Border
4" Series C Legend
White Background with Blue Circle Background
White Legend and Black Border

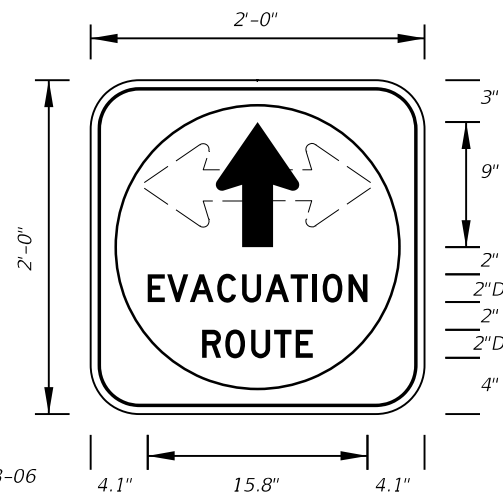

FTP-78-06
2' X 2'
3" Radii 3/4" Border
2" Series D Legend
White Background with Blue Circle Background
White Legend and Black Border

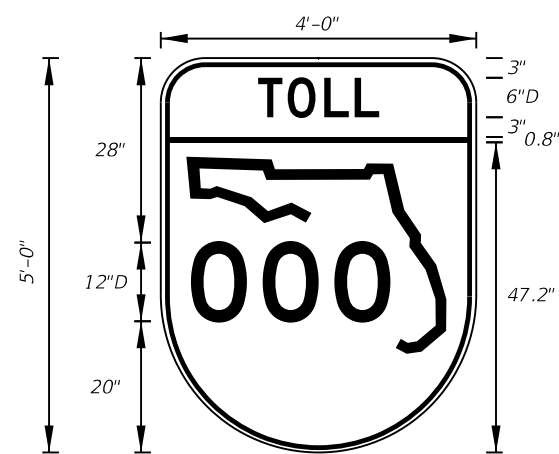

FTP-79-06
4' X 5'
6" Radii 3/4" Border
6" and 12" Series D Legend
Top Yellow Background with Black Legend and Black Border
Bottom White Background with Black Legend and Border

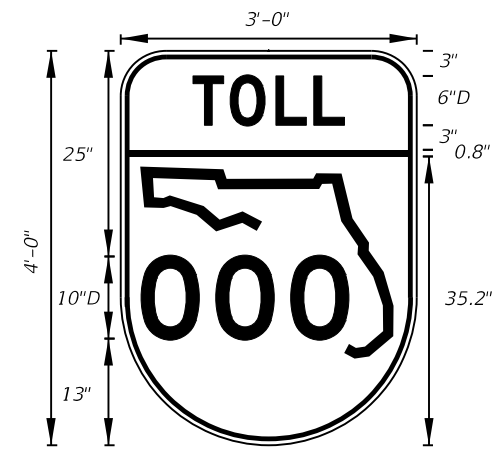

FTP-80-06
3' X 4'
5" Radii 3/4" Border
6" and 10" Series D Legend
Top Yellow Background with Black Legend and Black Border
Bottom White Background with Black Legend and Border

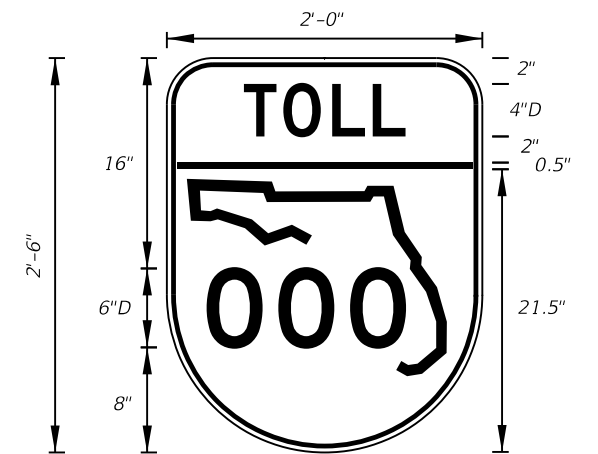

FTP-81-06
2' X 2'-6"
3" Radii 3/4" Border
4" and 6" Series D Legend
Top Yellow Background with Black Legend and Black Border
Bottom White Background with Black Legend and Border

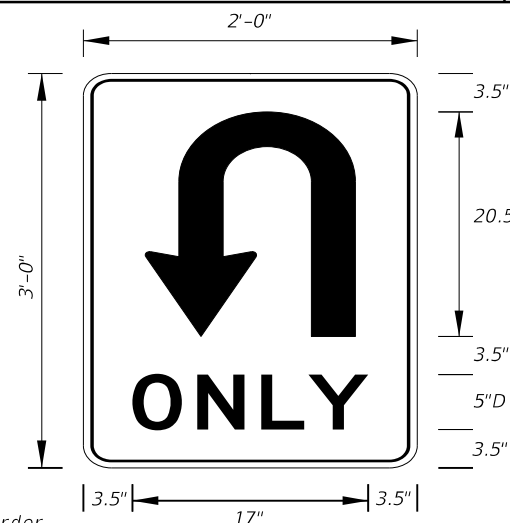

FTP-82-08
2' X 3'
1.5" Radii
5" Series D Legend
White Background
Black Legend and Border

ARROW HEAD

A	3.125
B	3.625
C	6.375
D	.5
E	.625

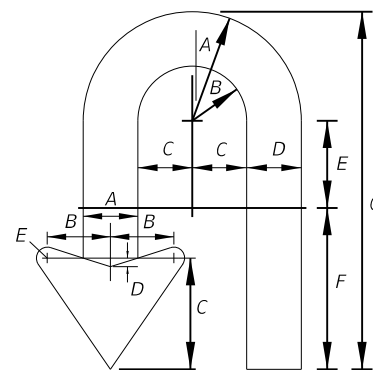

ARROW BODY

A	B	C	D	E	F	G
6.25	3.125	3.125	3.125	5	9.25	20.5

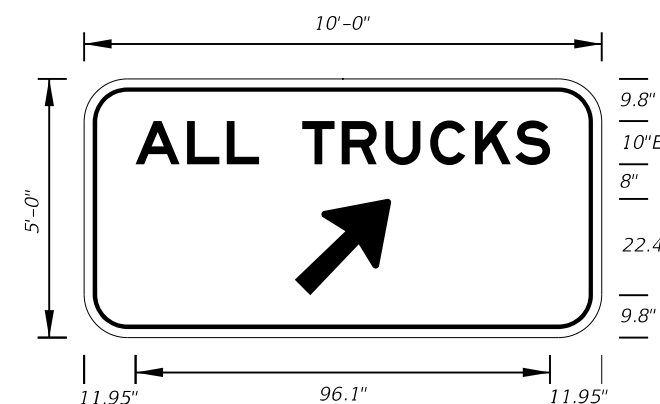

FTP-83-08
10'-0" X 5'-0"
8" Radii
10" Series E Legend
Green Background
White Legend

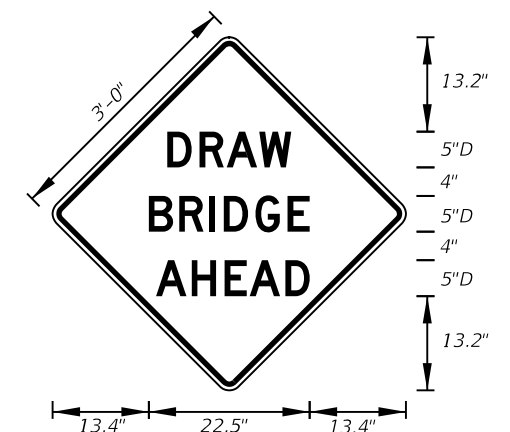

FTP-84-09
3' X 3'
1.5" Radii
5" Series D Legend
Yellow Background
Black Legend

6/24/2013 7:18:48 PM sm970re C:\projects\standards\roadway\17300-s\17355-09.dgn

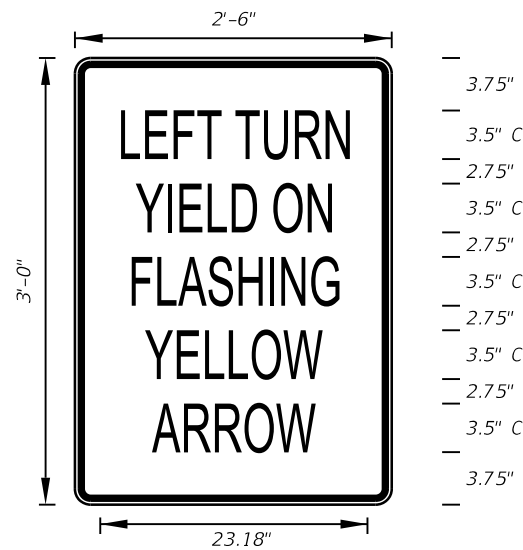

FTP-85-13
 3' X 2'-6"
 1.875" Radii 3/4" Border
 3.5" Series C Legend
 White Background
 Black Legend and Border

C:\projects\standards\roadway\17300-s\17355-10.dgn 6/24/2013 7:18:50 PM sm970re

LAST REVISION 07/01/13	REVISION DESCRIPTION:	 FDOT 2014 DESIGN STANDARDS	SPECIAL SIGN DETAILS	INDEX NO. 17355	SHEET NO. 10 of 12
---------------------------	-----------------------	---	----------------------	--------------------	-----------------------

6/24/2013 7:18:51 PM sm970re C:\projects\standards\roadway\17300-s\17355-11.dgn

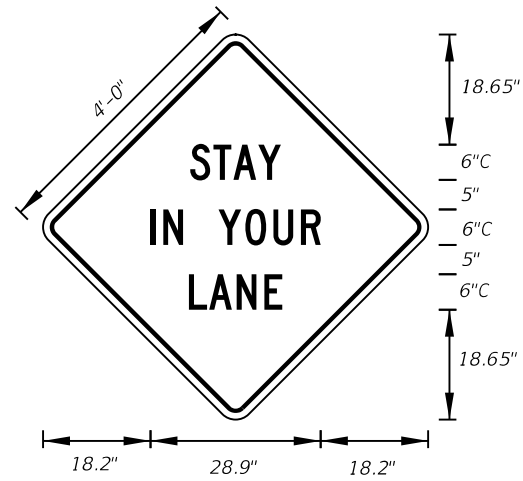

M0T-1-06
4' X 4'
2" Radii 3/4" Border
6" Series C Legend
Orange Background
Black Legend and Border

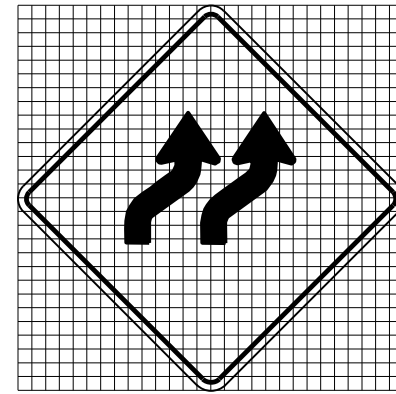

M0T-2-06
4' X 4'
2" Radii 3/4" Border
Orange Background
Black Arrows and Border

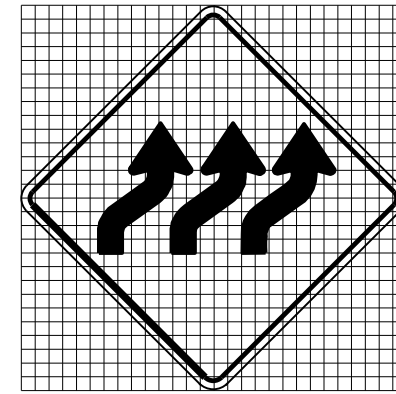

M0T-3-06
4' X 4'
2" Radii 3/4" Border
Orange Background
Black Arrows and Border

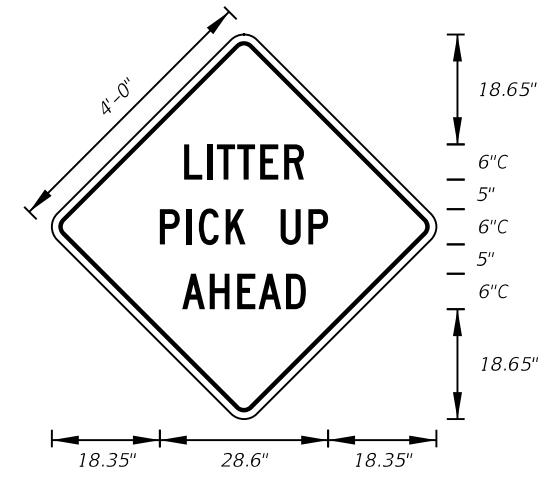

M0T-4-06
4' X 4'
2" Radii 3/4" Border
6" Series C Legend
Orange Background
Black Legend and Border

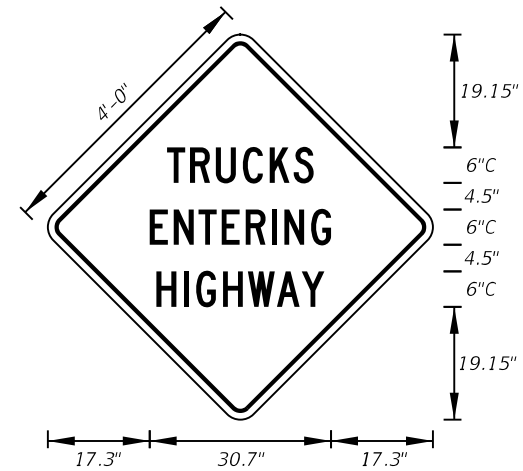

M0T-5-06
4' X 4'
2" Radii 3/4" Border
6" Series C Legend
Orange Background
Black Legend and Border

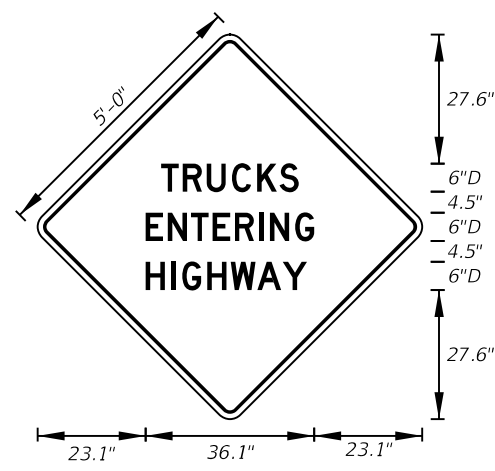

M0T-6-06
5' X 5'
2" Radii 3/4" Border
6" Series D Legend
Orange Background
Black Legend and Border

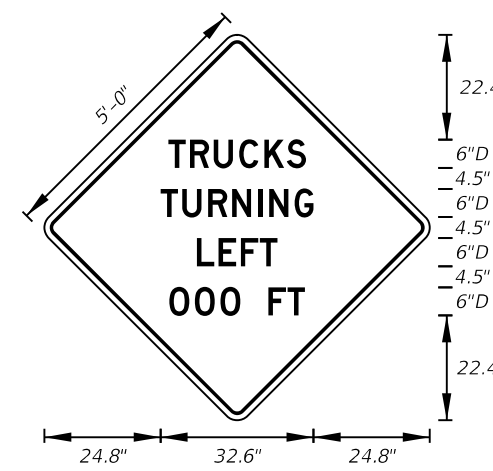

M0T-7-06
5' X 5'
2" Radii 3/4" Border
6" Series D Legend
Orange Background
Black Legend and Border

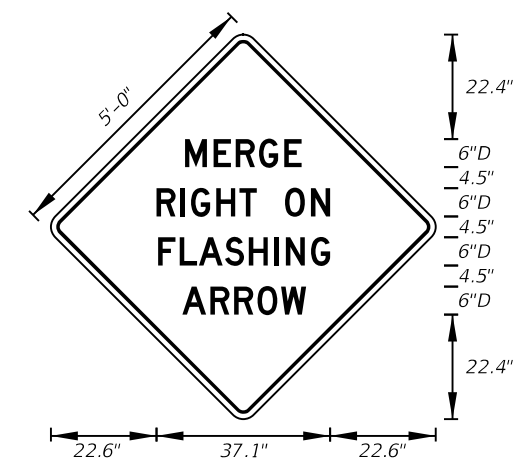

M0T-8-06
5' X 5'
2" Radii 3/4" Border
6" Series D Legend
Orange Background
Black Legend and Border

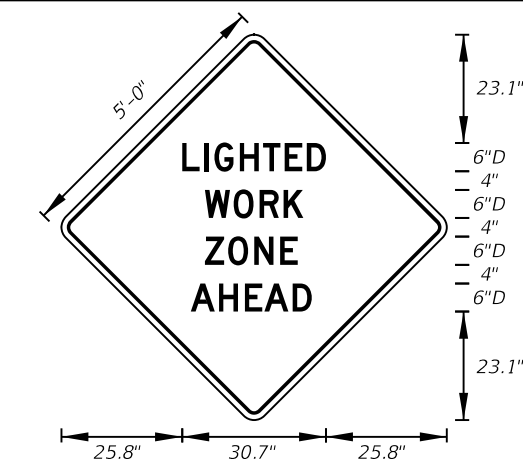

M0T-9-06
5' X 5'
2" Radii 3/4" Border
6" Series D Legend
Orange Background
Black Legend and Border

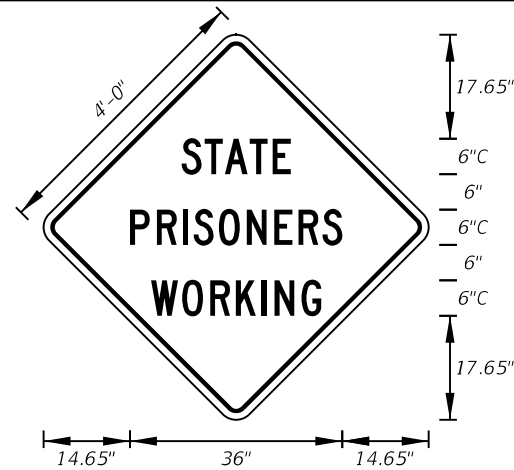

M0T-10-06
4' X 4'
2" Radii 3/4" Border
6" Series C Legend
Orange Background
Black Legend and Border

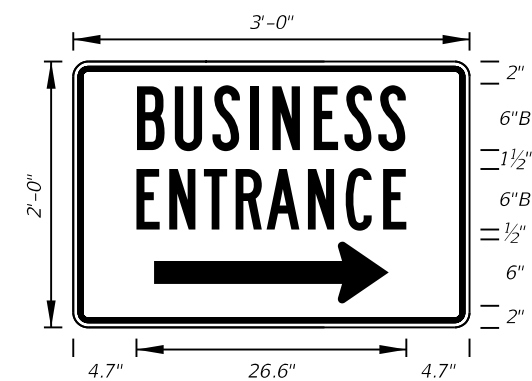

M0T-11-06
3' X 2'
2" Radii 3/4" Border
6" Series B Legend
Blue Background
White Legend and Border

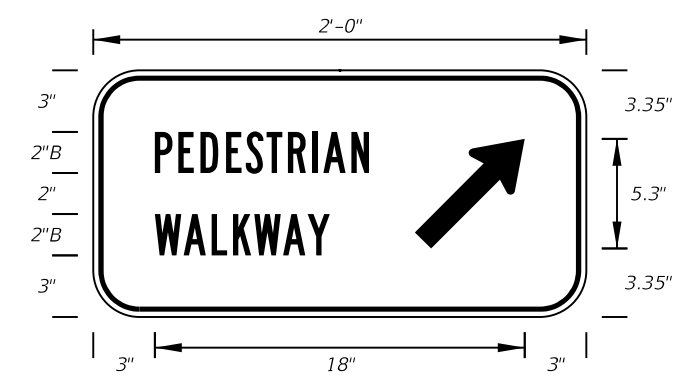

M0T-12-06
2' X 1'
2" Radii 3/4" Border
2" Series B Legend
White Background
Black Legend and Border

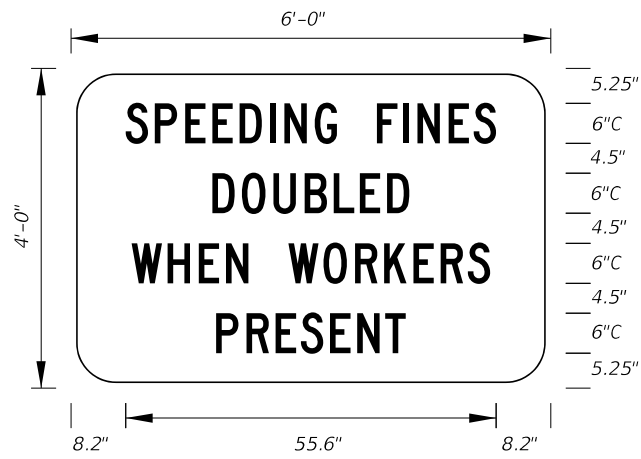

M0T-13-06 Freeway Sign
6' X 4'
6" Radii 3/4" Border

6" Series C Legend
White Background
Black Legend and Border

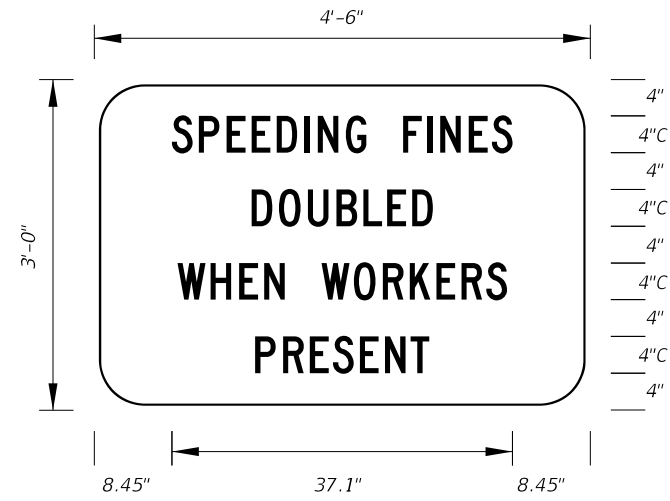

M0T-14-06 Arterial Sign
4'-6" X 3'
5" Radii 3/4" Border

4" Series C Legend
White Background
Black Legend and Border

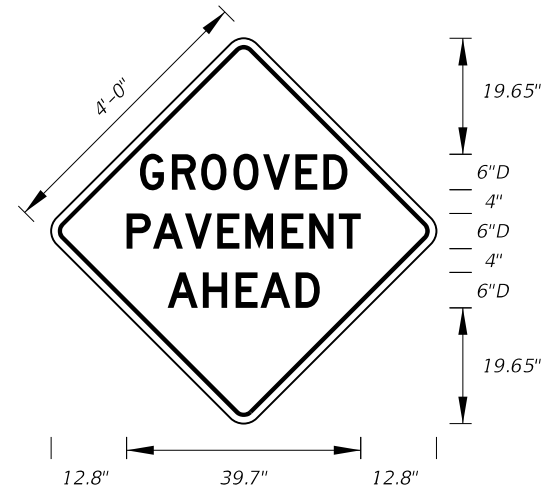

M0T-15-06
4' X 4'
2" Radii 3/4" Border

6" Series D Legend
Orange Background
Black Legend and Border

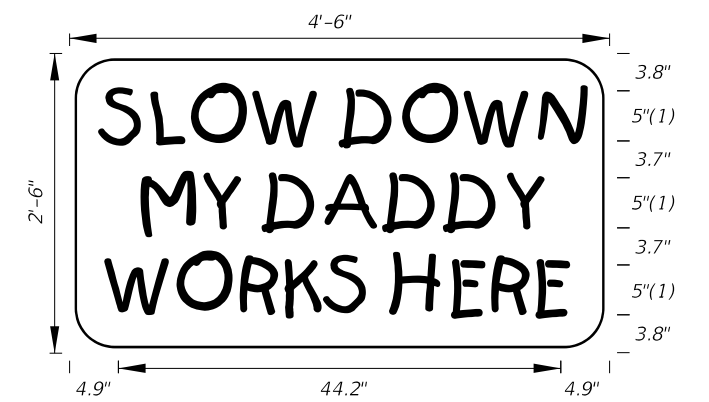

M0T-16-06
4'-6" X 2'-6"
4" Radii 3/4" Border

5" Kids Series Legend
Orange Background
Black Legend and Border

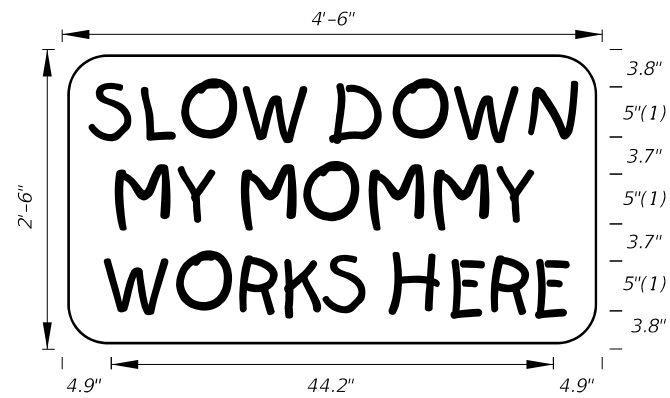

M0T-17-06
4'-6" X 2'-6"
4" Radii 3/4" Border

5" Kids Series Legend
Orange Background
Black Legend and Border

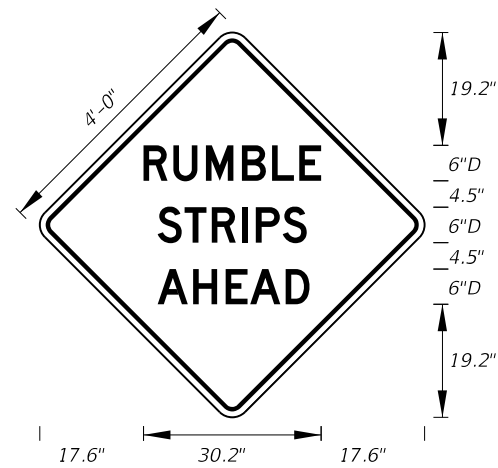

M0T-18-10
4' X 4'
2" Radii 3/4" Border

6" Series D Legend
Orange Background
Black Legend and Border

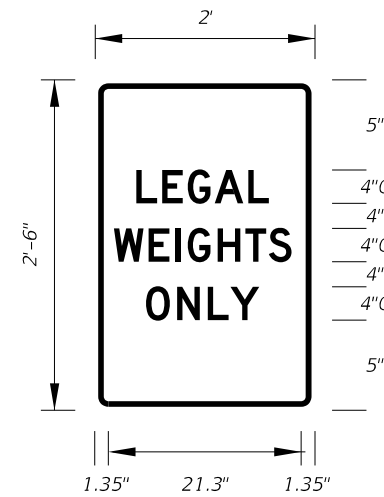

M0T-19-11
2' X 3'
1.13" Radii 3/4" Border

4" Series C Legend
White Background
Red Legend and Border

C:\projects\standards\roadway\17300-s\17355-12.dgn 6/24/2013 7:18:53 PM sm970re

LAST REVISION 01/01/12	REVISION	DESCRIPTION:	 FDOT 2014 DESIGN STANDARDS	SPECIAL SIGN DETAILS	INDEX NO. 17355	SHEET NO. 12 of 12
---------------------------	----------	--------------	--	----------------------	--------------------	-----------------------