

DIMENSIONS ARE WITHIN 1" ±

PAVEMENT ARROW AND MESSAGE DETAILS

TYPES OF PERMANENT LONGITUDINAL LINES

NOTE: When arrow and pavement message are used together, the arrow shall be located down stream of the pavement message and shall be separated from the pavement message by a distance of 25' (Base of the arrow to the base of the message). Stop message shall be placed 25' from back of stop line.

BASIC COLOR RULE:

White lines separate traffic in the same direction. Yellow lines separate traffic in opposing directions. Yellow dotted lines may be used in special cases. Black may be used in combination with white for skip lines where a light-colored pavement does not provide sufficient contrast with the markings.

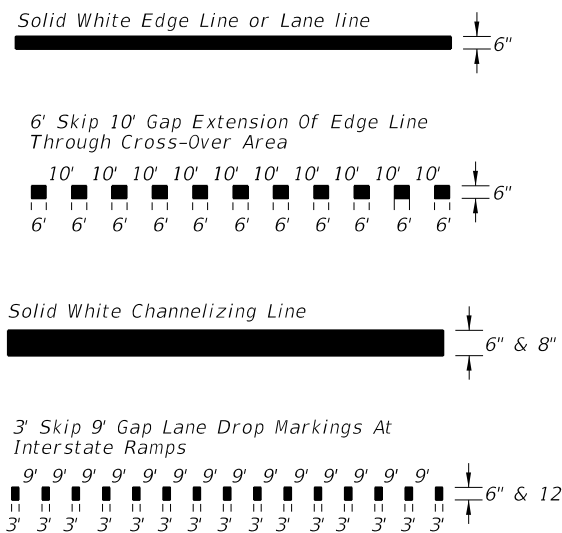
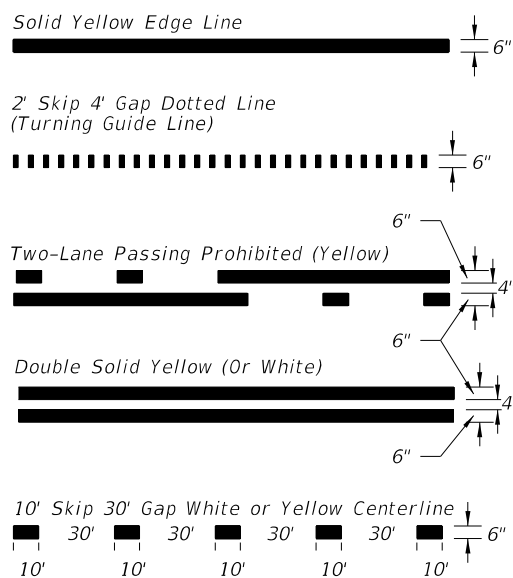

CONTRAST MARKINGS

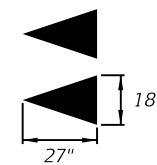
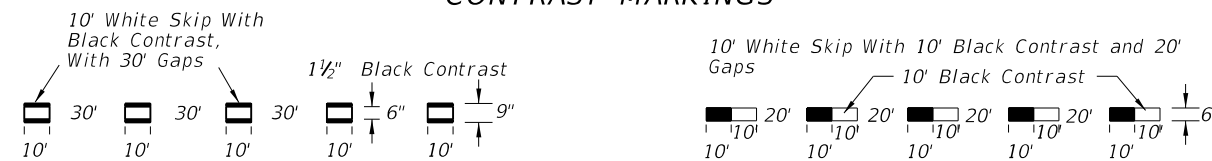

Yield Lines 5-18" X 27" White triangles facing traffic equally spaced within travel lane with 1 additional triangle using same spacing when a bike lane is present.

C:\projects\standards\roadway\17300-s\17346-01.dgn sm970re 7:13:03 PM 6/24/2013

LAST REVISION 07/01/13	REVISION	DESCRIPTION:	 <p>FDOT 2014 DESIGN STANDARDS</p>	<p>SPECIAL MARKING AREAS</p>	<p>INDEX NO. 17346</p>	<p>SHEET NO. 1 of 14</p>
---------------------------	----------	--------------	---	------------------------------	----------------------------	------------------------------

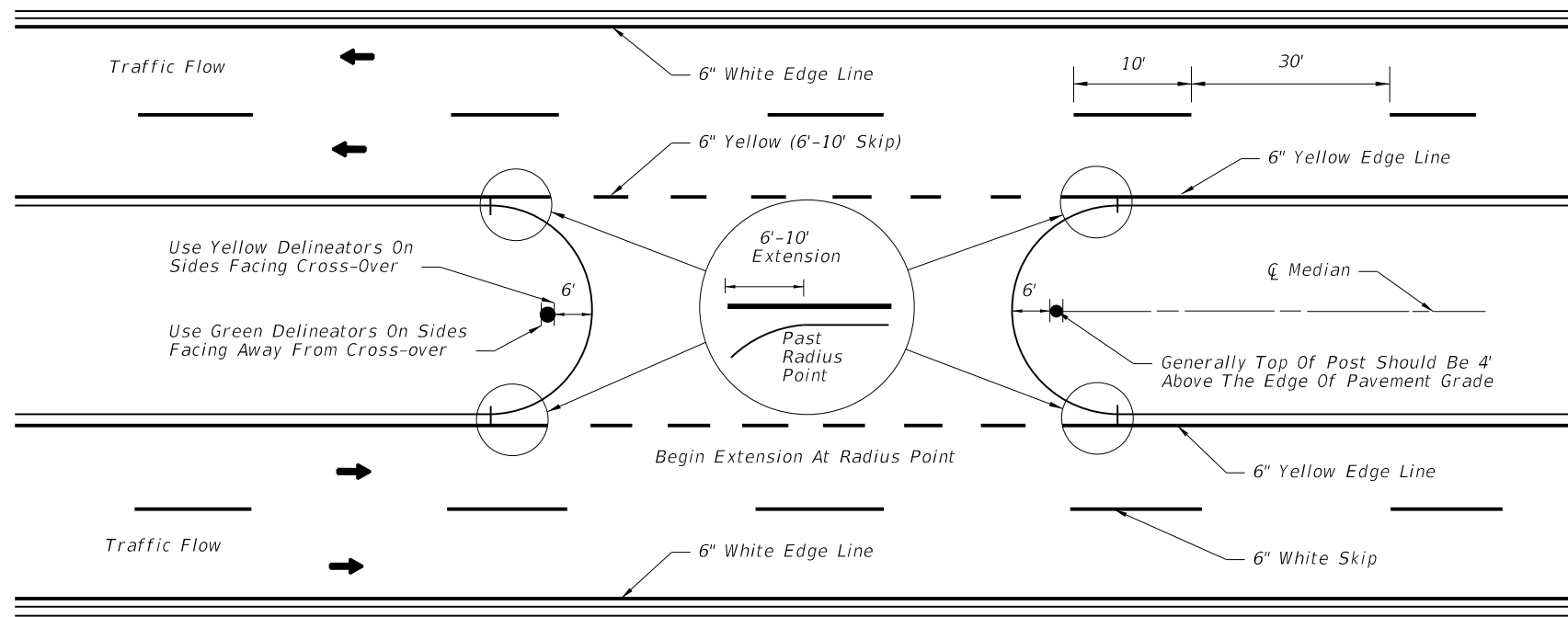

PAVEMENT MARKINGS AND DELINEATORS FOR MEDIAN CROSS-OVER

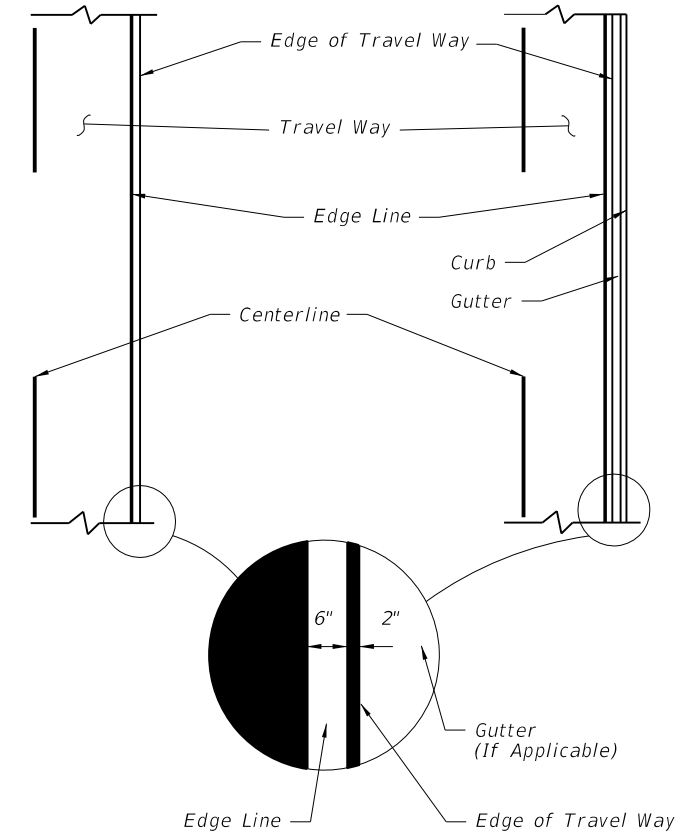

PLACEMENT OF EDGE LINES

NOTE:
Markings applied to median noses shall be yellow in color.

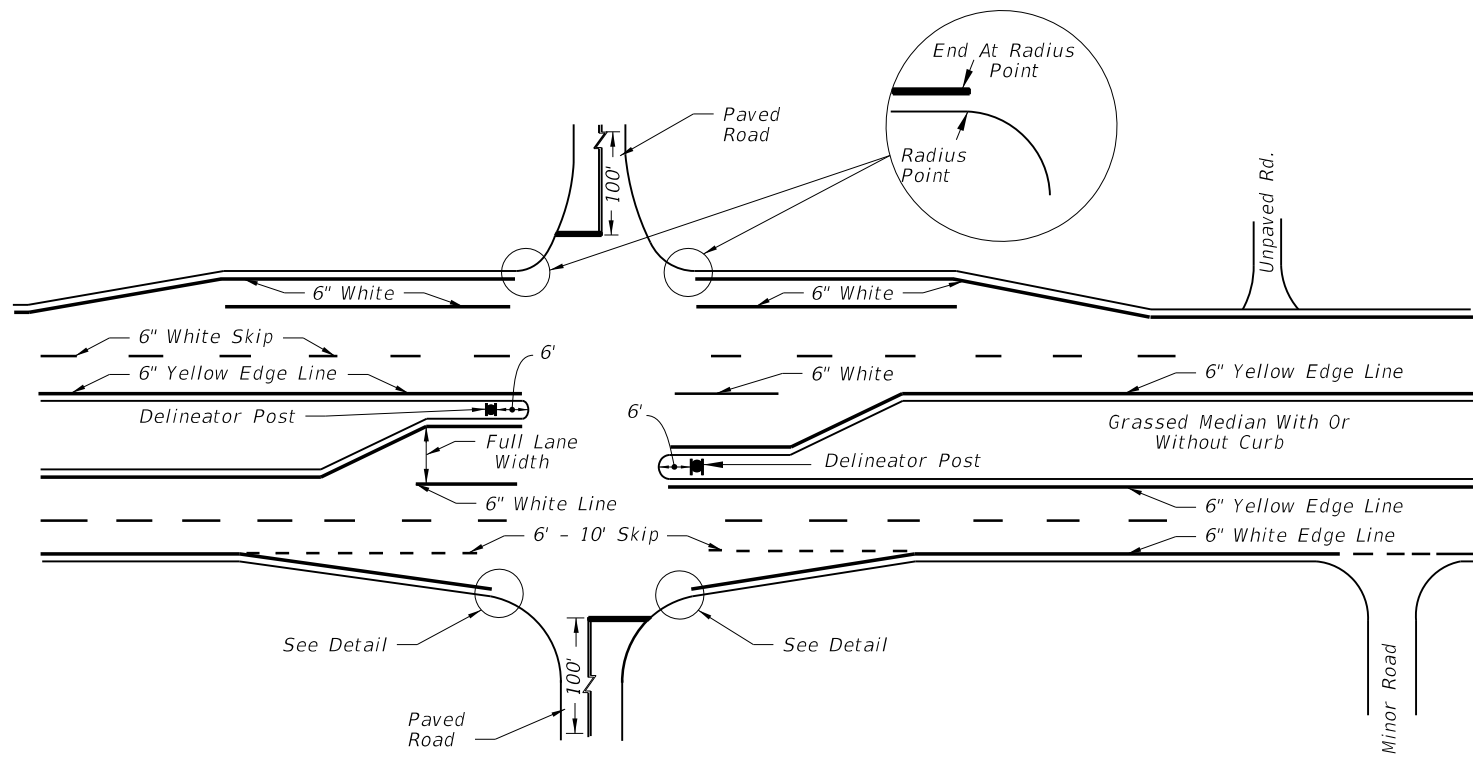

PAVEMENT MARKINGS FOR INTERSECTIONS WITH MAJOR AND MINOR ROADS

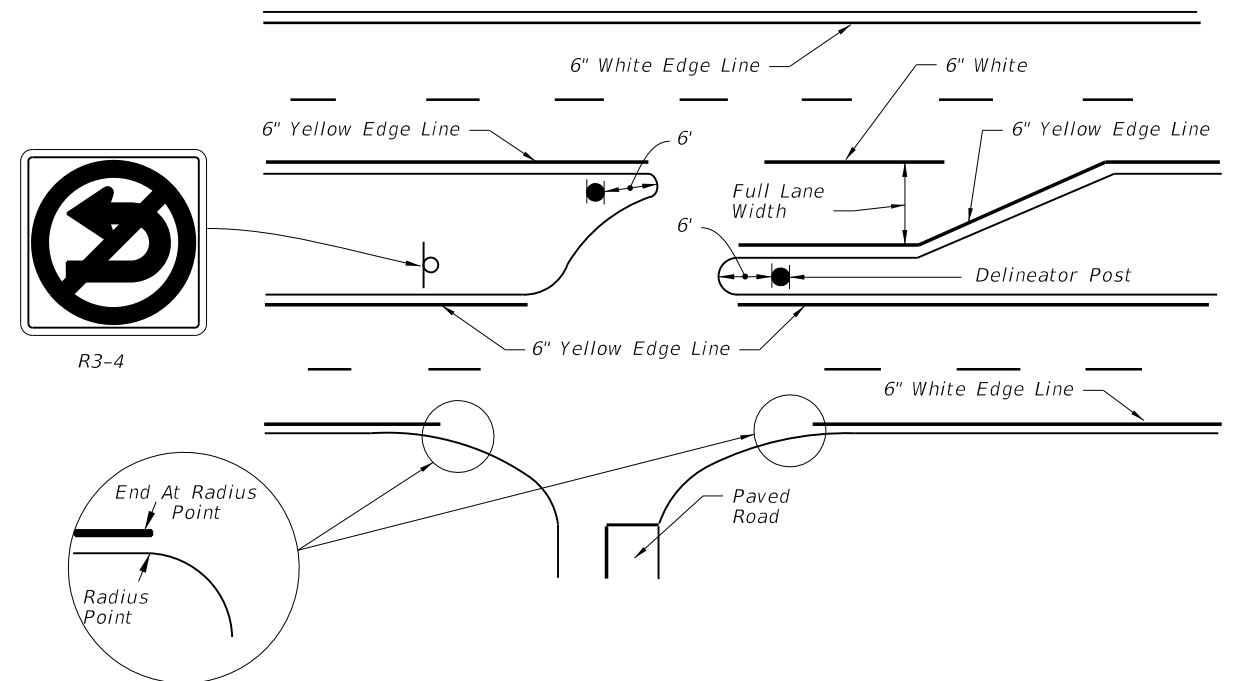

C:\projects\standards\roadway\17300-s\17346-02.dgn
sm970re
7:13:05 PM
6/24/2013

LAST REVISION 01/01/10	REVISION	DESCRIPTION:	 <p>FDOT 2014 DESIGN STANDARDS</p>	SPECIAL MARKING AREAS		INDEX NO. 17346	SHEET NO. 2 of 14
---------------------------	----------	--------------	---	-----------------------	--	--------------------	----------------------

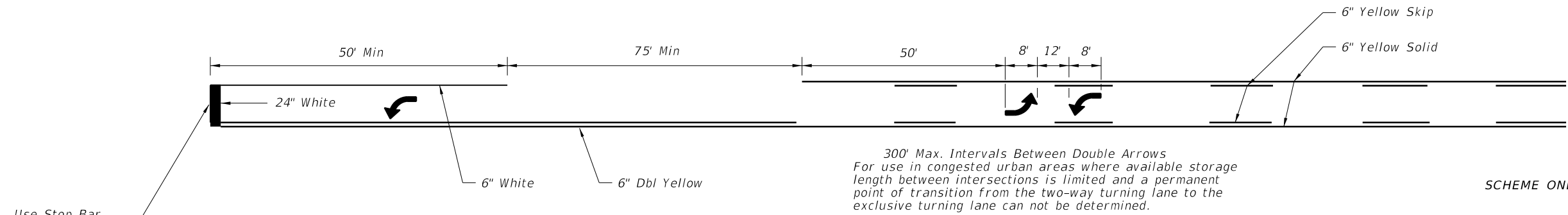

Use Stop Bar At Signalized Intersection Only

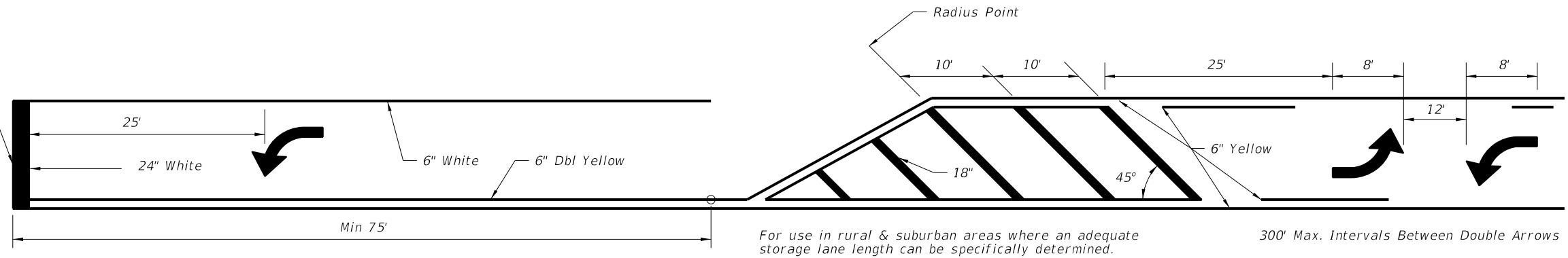

(WITH SINGLE LANE LEFT TURN CHANNELIZATION)
TWO WAY LEFT TURN LANE

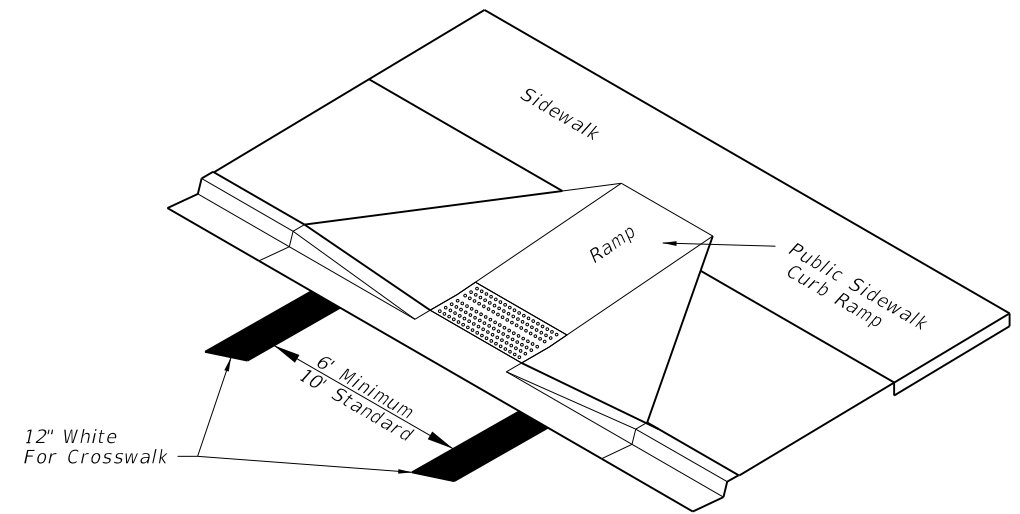
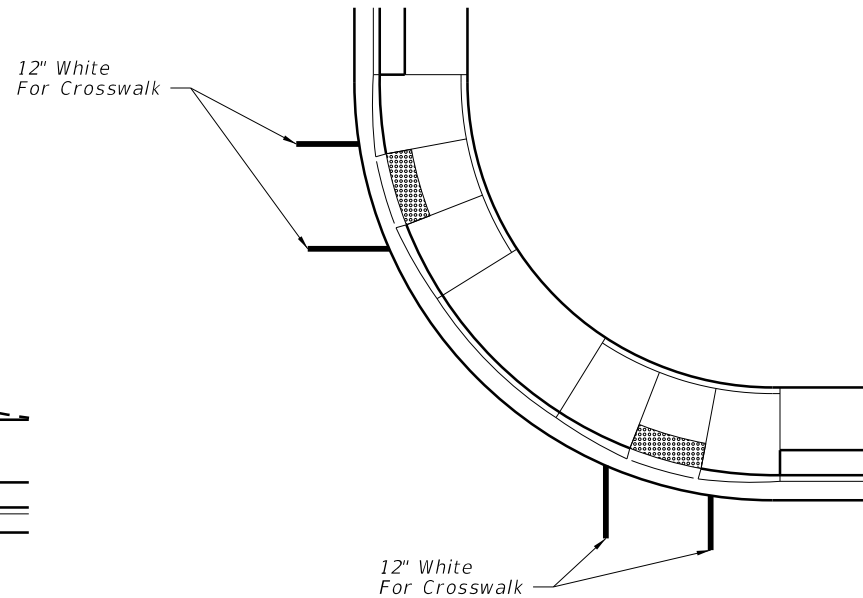
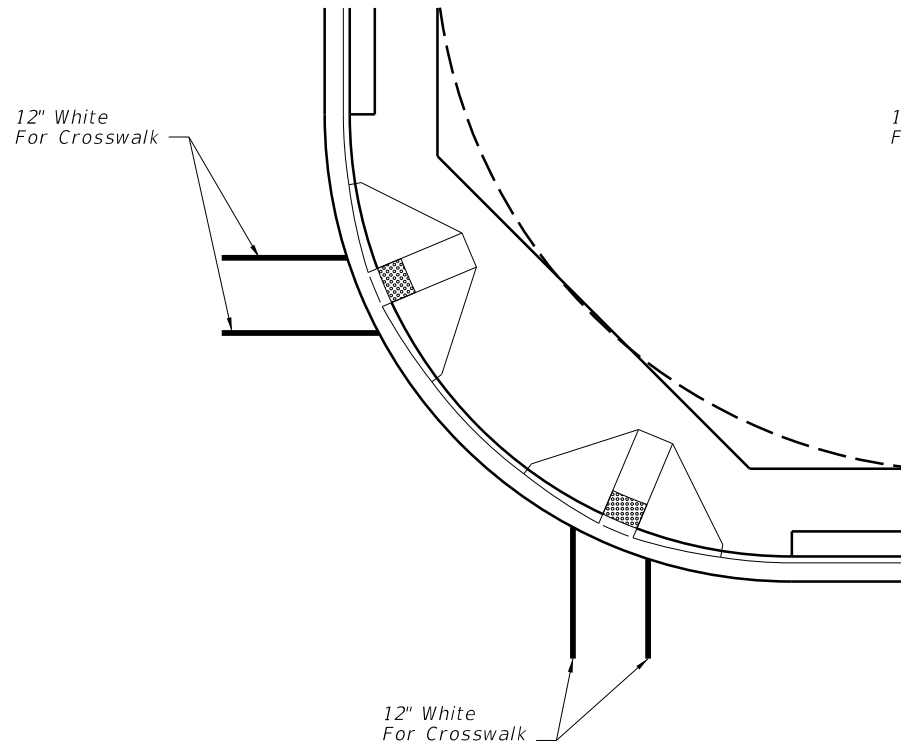

TYPICAL CROSSWALK MARKINGS FOR CURB RAMPS

C:\projects\standards\roadway\17300-s\17346-03.dgn
sm970re
7:13:07 PM
6/24/2013

LAST REVISION 07/01/13	REVISION	DESCRIPTION:	 FDOT 2014 DESIGN STANDARDS	SPECIAL MARKING AREAS	INDEX NO. 17346	SHEET NO. 3 of 14
---------------------------	----------	--------------	---	------------------------------	--------------------	----------------------

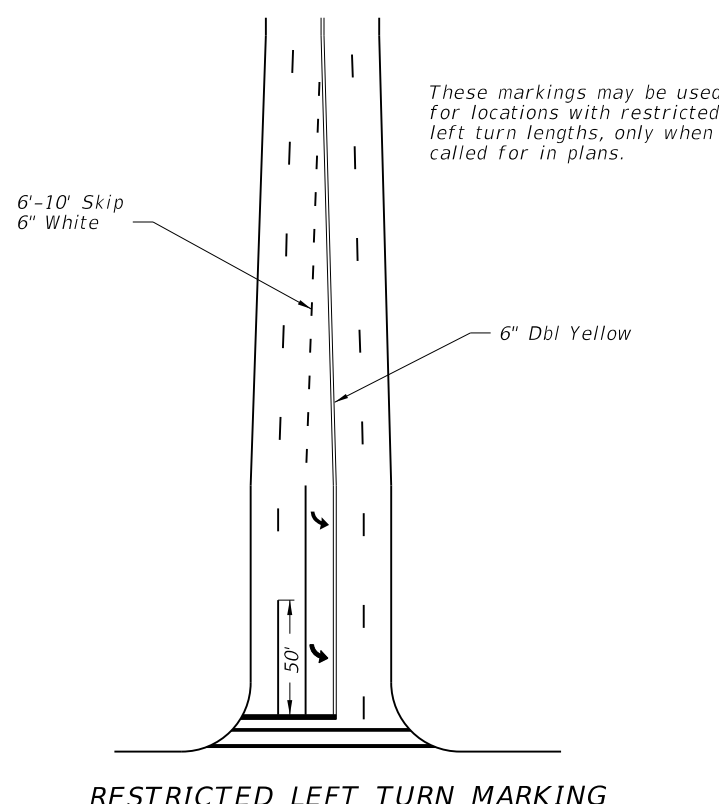

These markings may be used for locations with restricted left turn lengths, only when called for in plans.

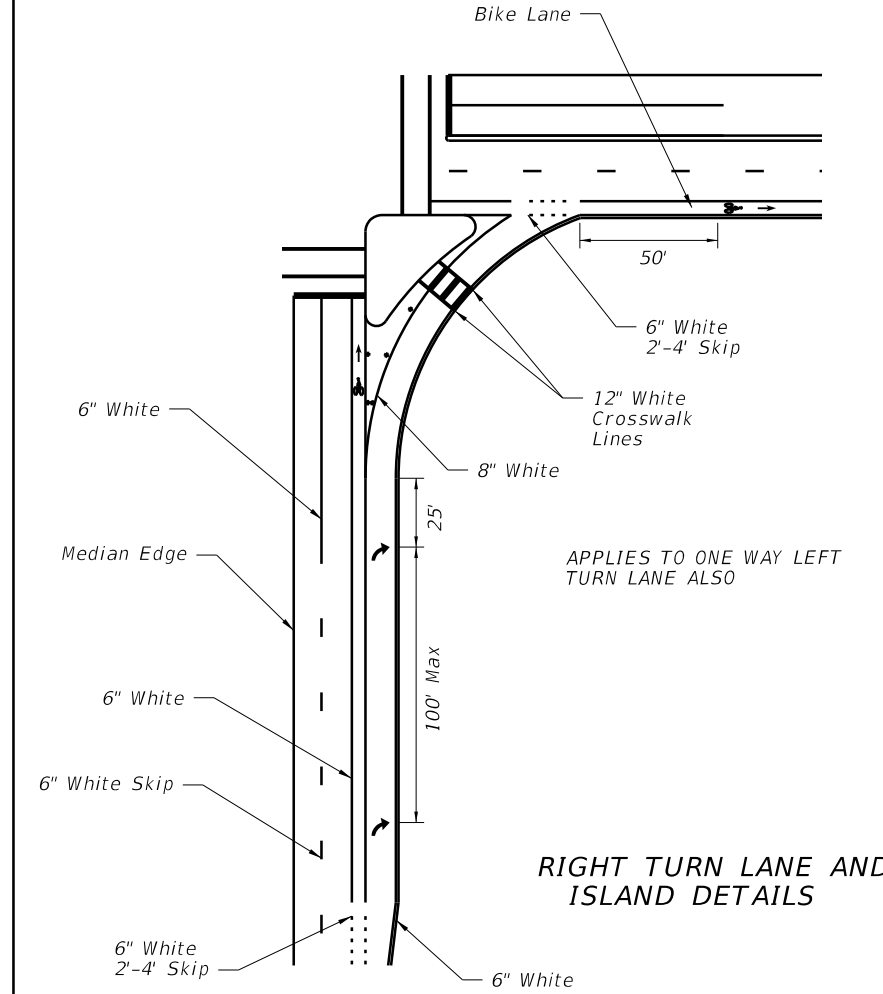
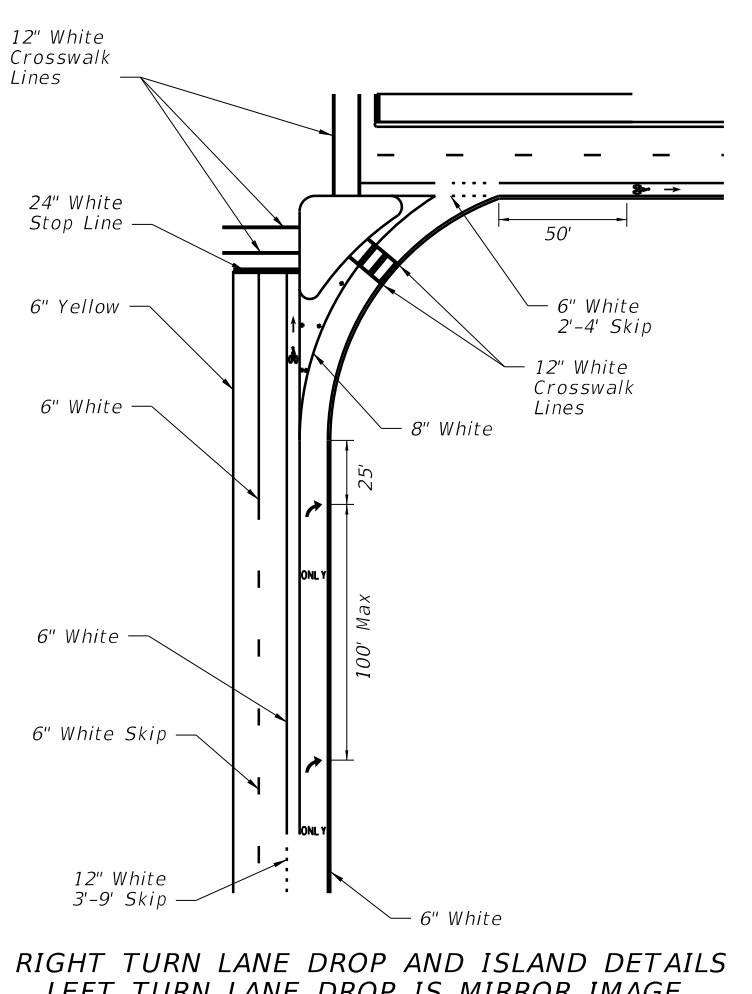

100' Minimum or as determined by $L=WS$

$(L = \frac{WS^2}{60} < 45 \text{ mph})$ where

W is the lateral offset in feet and S is the 85th percentile speed in miles per hour (speed limit)

For left turn storage lane detail see sheet 3 of this index.

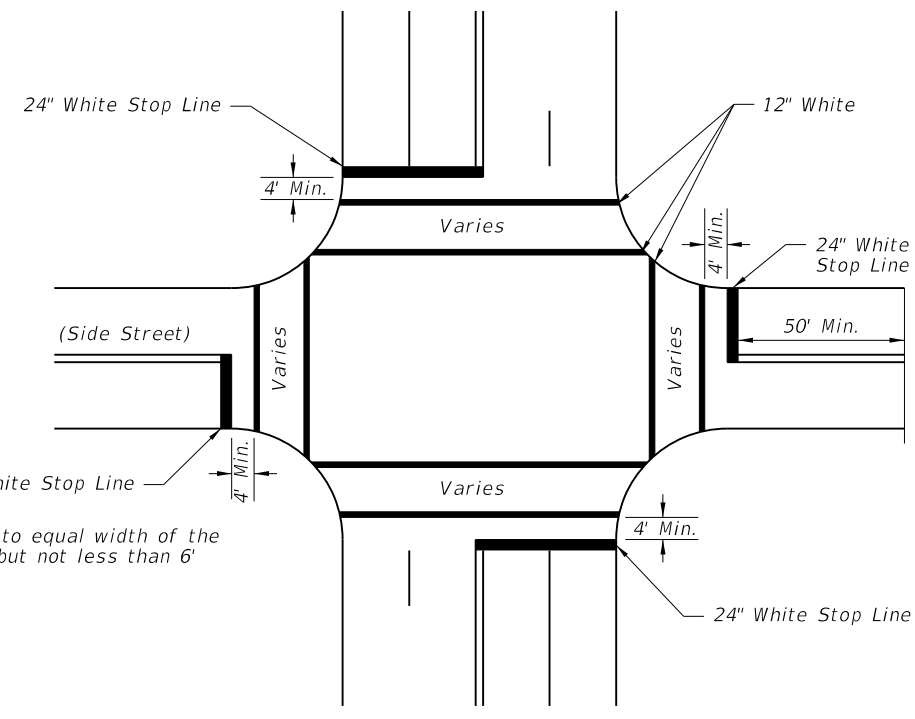
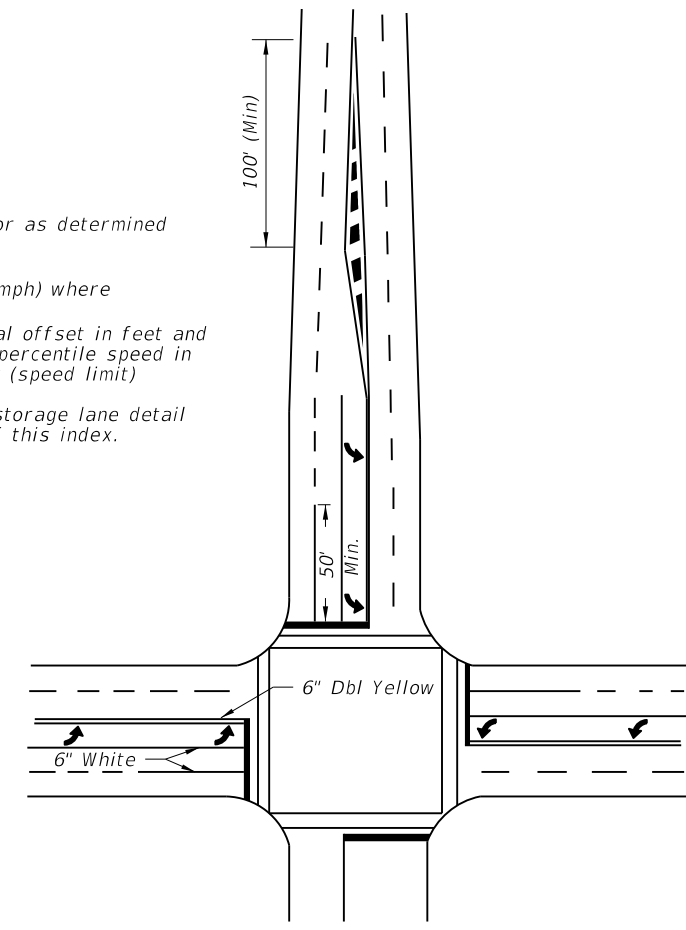

- NOTES:
1. When public sidewalk curb ramps are present, refer Index No. 17344 and Index No. 304 for crosswalk widths.
 2. Double yellow longitudinal center lines on all roadway approaches shall be extended back 100' for projects involving intersection improvements only.
 3. When specified, "stop" message shall be placed 25' back of stop lines.

6/24/2013 7:13:09 PM sm970re C:\projects\standards\roadway\17300-s\17346-04.dgn

LAST REVISION 01/01/13	REVISION	DESCRIPTION: R2013-02--Removed Chevrons from Raised Islands.	 FDOT 2014 DESIGN STANDARDS	SPECIAL MARKING AREAS		INDEX NO. 17346	SHEET NO. 4 of 14
---------------------------	----------	---	---	------------------------------	--	---------------------------	-----------------------------

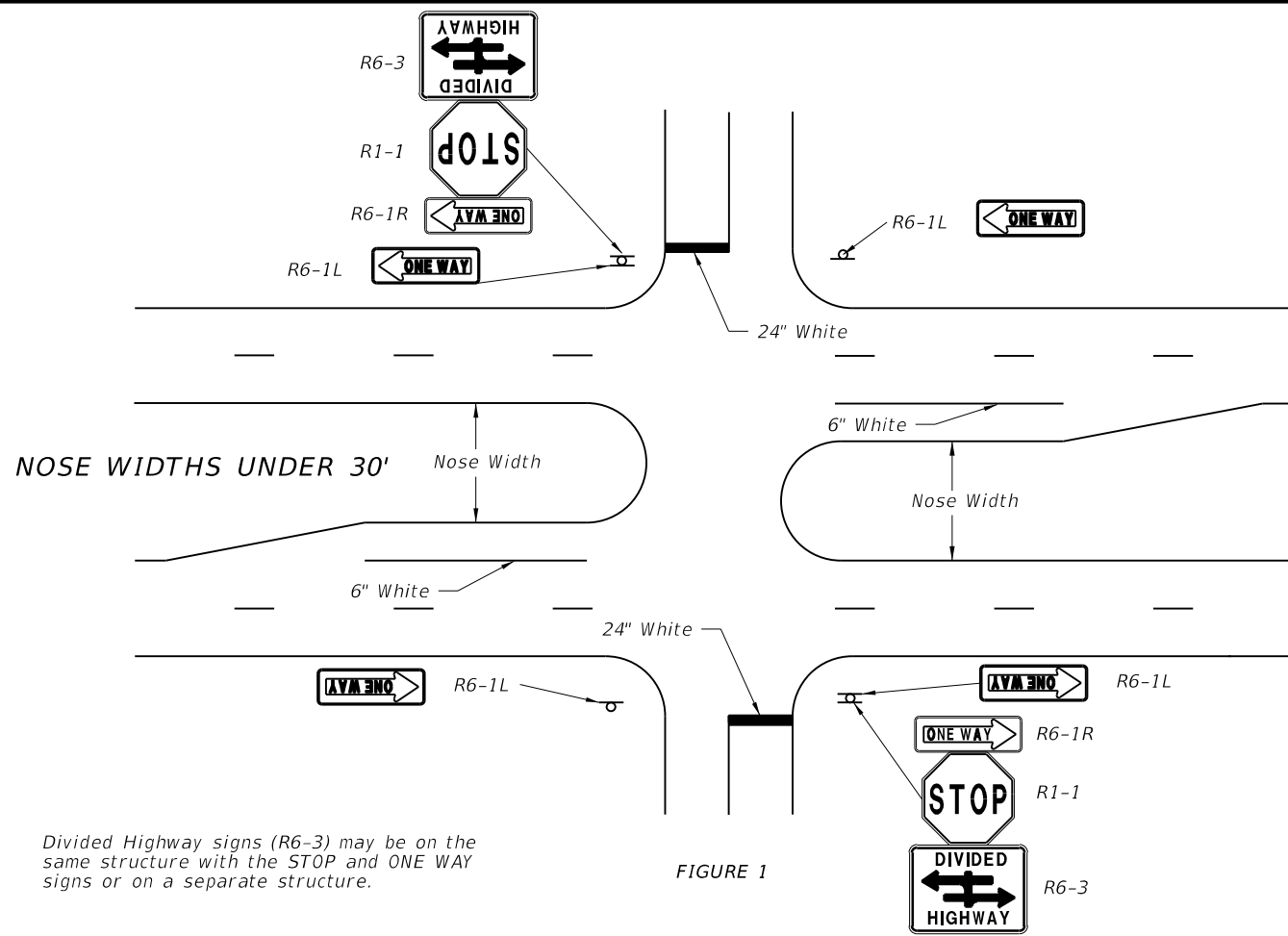

Divided Highway signs (R6-3) may be on the same structure with the STOP and ONE WAY signs or on a separate structure.

FIGURE 1

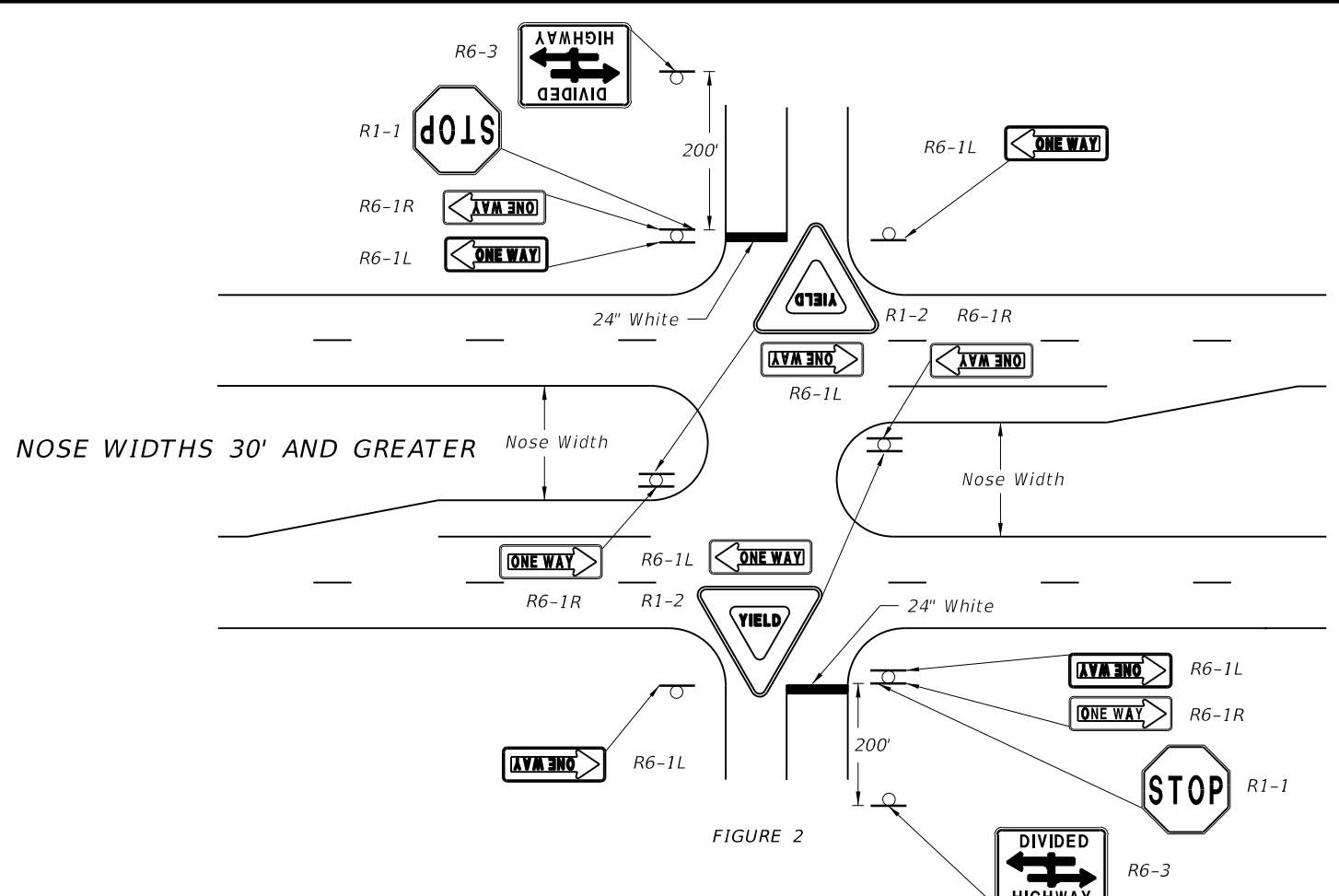
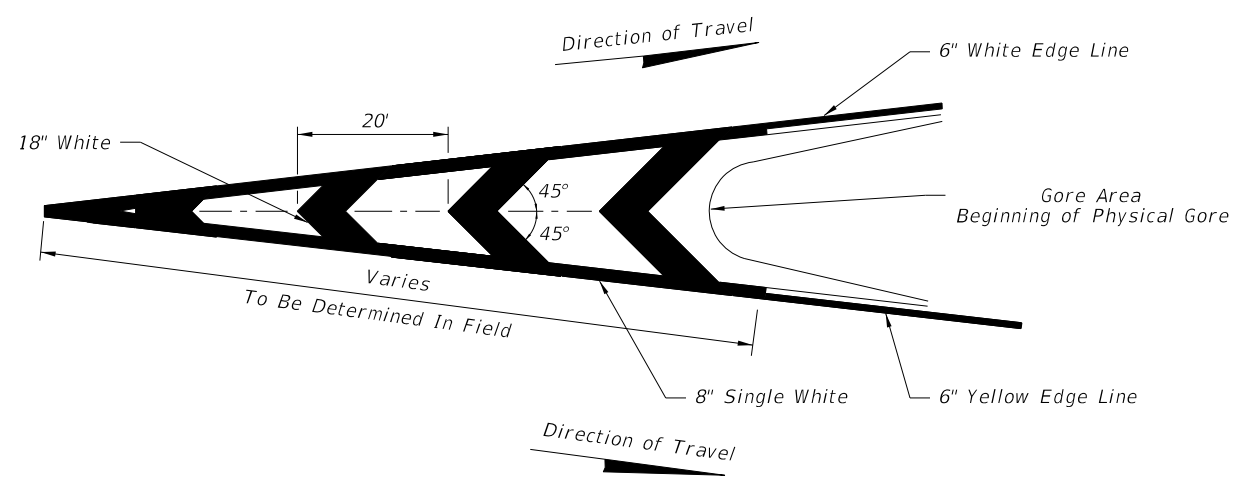
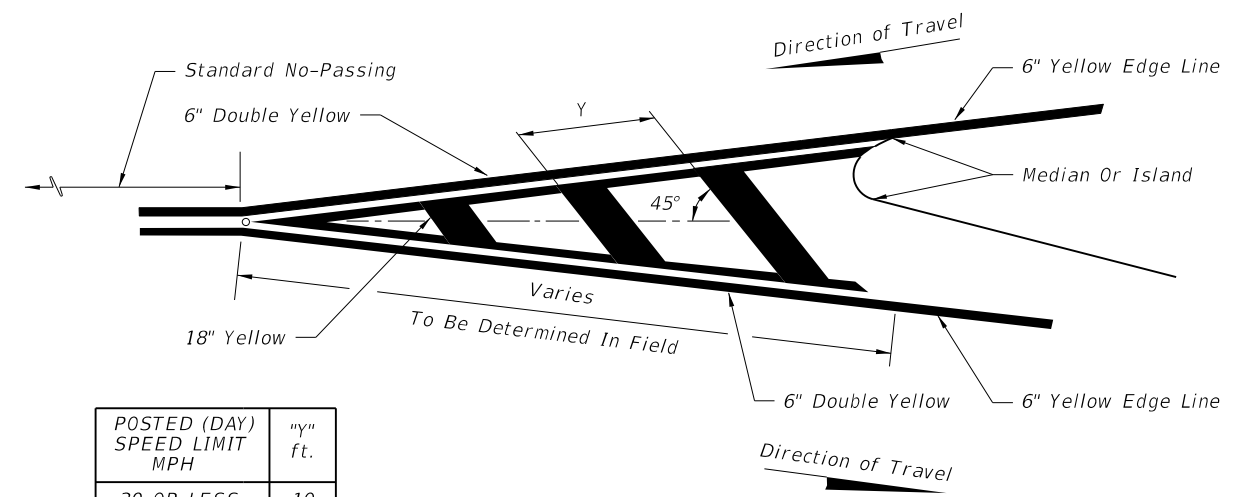

FIGURE 2

ONE-WAY SIGNS ON DIVIDED HIGHWAY INTERSECTIONS



PAVEMENT MARKINGS FOR TRAFFIC CHANNELIZATION AT GORE
(TRAFFIC FLOWS IN SAME DIRECTION)



POSTED (DAY) SPEED LIMIT MPH	"Y" ft.
30 OR LESS	10
35	20
40	20
45	30
50 OR MORE	40

PAVEMENT MARKING FOR TRAFFIC SEPARATION
(TRAFFIC FLOWS IN OPPOSING DIRECTIONS)

C:\projects\standards\roadway\17300-s\17346-05.dgn sm970re 6/24/2013 7:13:11 PM

TYPICAL TRANSITION MARKING
 COLOR SHALL BE THE SAME AS RESPECTIVE EDGE LINE

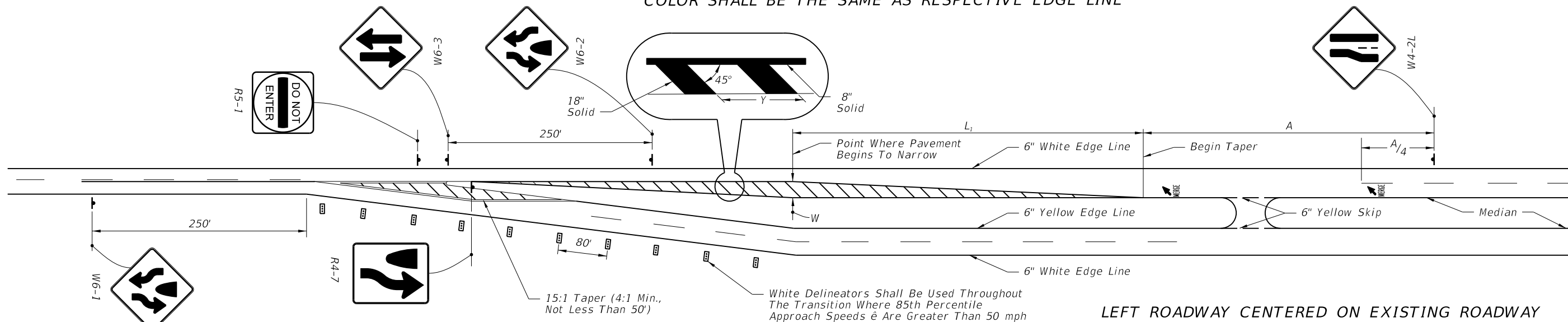

LEFT ROADWAY CENTERED ON EXISTING ROADWAY

**W *S	TRANSITION DISTANCE L_1 (FEET)						
MPH	8	9	10	11	12	13	14
30	120	135	150	165	180	195	210
35	165	185	205	225	245	265	285
40	215	240	270	295	320	350	375
45	360	405	450	495	540	585	630
50	400	450	500	550	600	650	700
55	440	495	550	605	660	715	770
60	480	540	600	660	720	780	840
65	520	585	650	715	780	845	910

SPEED* MPH	"A" (FT.)	POSTED (DAY) SPEED LIMIT MPH	"y" (FT.)
55	950	30 OR LESS	10
50	850	35	20
45	750	40	20
40	650	45	30
30	450	50 OR MORE	40

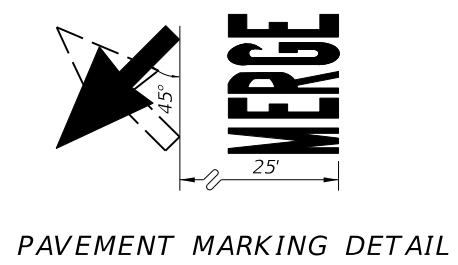
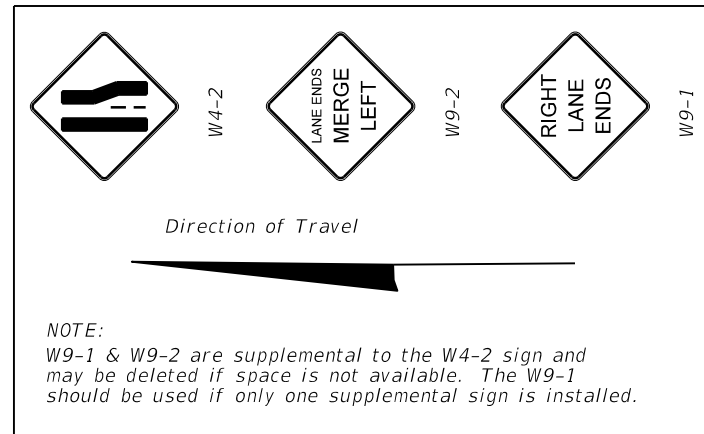

$L_1 = WS$ (45 MPH or Greater) *Design Speed
 $L_1 = \frac{WS^2}{60}$ (≤ 40 MPH) **Lateral offset
 White Delineators Shall Be Used Throughout The Transition Where 85th Percentile Approach Speeds* Are Greater Than 50 mph.

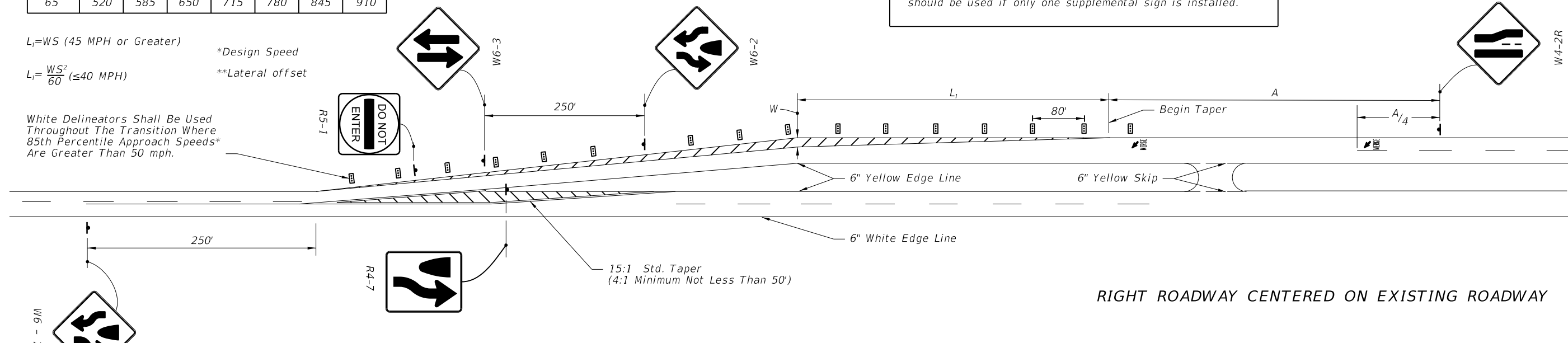

RIGHT ROADWAY CENTERED ON EXISTING ROADWAY

SCHEMES FOR TRANSITION - 2 LANE / 4 LANE ROADWAY

6/24/2013 7:13:12 PM sm970re C:\projects\standards\roadway\17300-s\17346-06.dgn

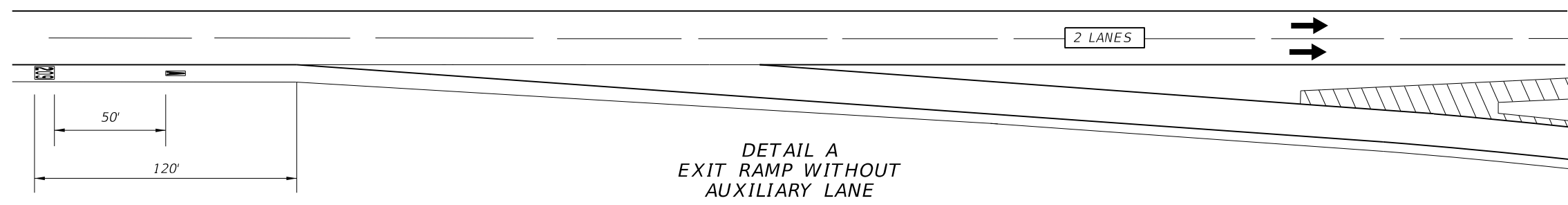

DETAIL A
EXIT RAMP WITHOUT
AUXILIARY LANE

LAYOUT FOR 1, 2 AND 3 DIGIT NUMBERS AND LETTERS

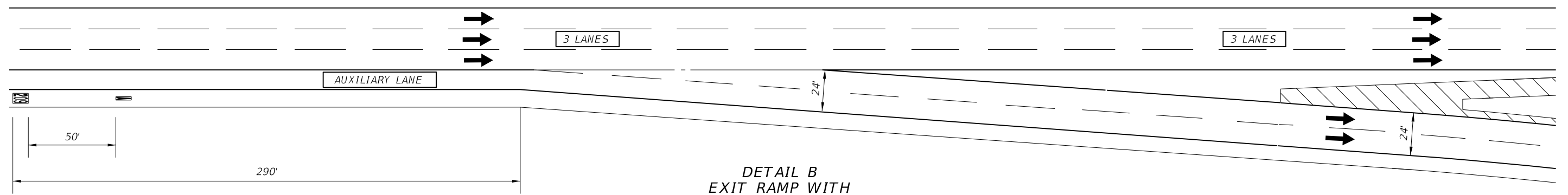

DETAIL B
EXIT RAMP WITH
AUXILIARY LANE

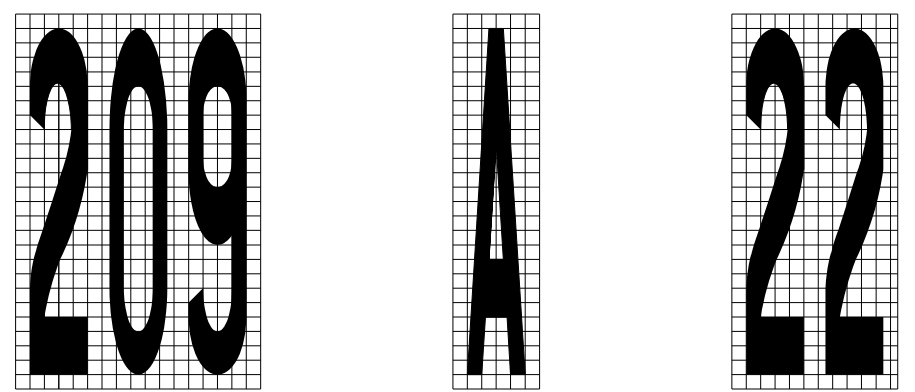

MESSAGE SIZE AND SPACING
4" X 4" squares

NOTES:

1. Messages shall meet requirements of Specification Section 971-6 and Section 711.
2. The thickness of the preformed message shall be 125 mils.
3. The message shall consist of white letters and numbers with black contrasting material. The black material shall meet the mat dimensions shown and have a minimum skid resistance value of 55 BPN.
4. The "EXIT NUMBER" position remains the same distance from the beginning of taper regardless of the number of lines of information.

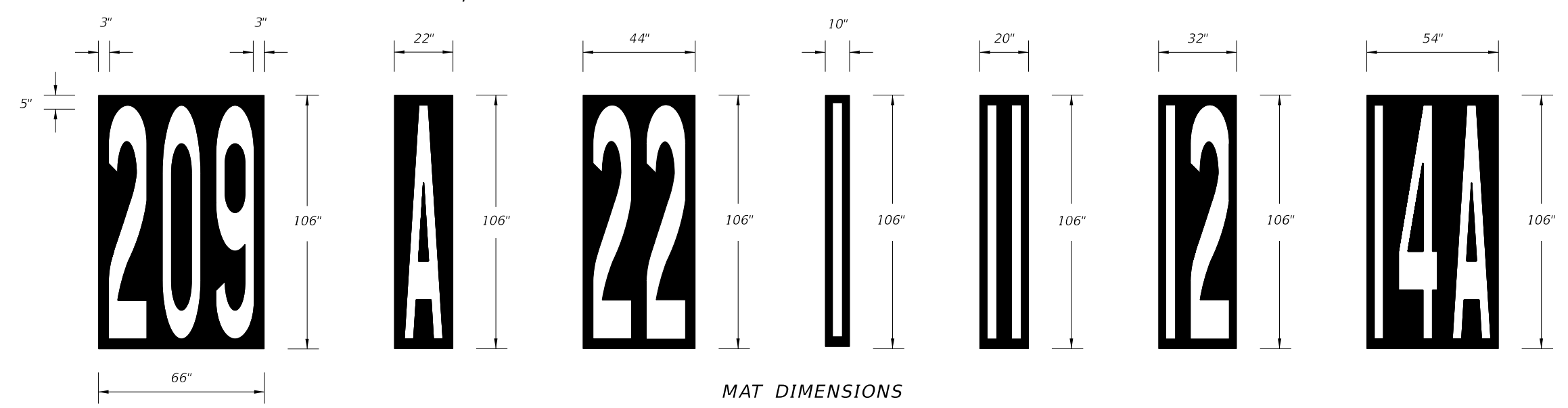

MAT DIMENSIONS

6/24/2013 7:13:14 PM sm970re C:\projects\standards\roadway\17300-s\17346-07.dgn

LAST REVISION 07/01/10	REVISION	DESCRIPTION:	 FDOT 2014 DESIGN STANDARDS	SPECIAL MARKING AREAS	INDEX NO. 17346	SHEET NO. 7 of 14
---------------------------	----------	--------------	---	-----------------------	--------------------	----------------------

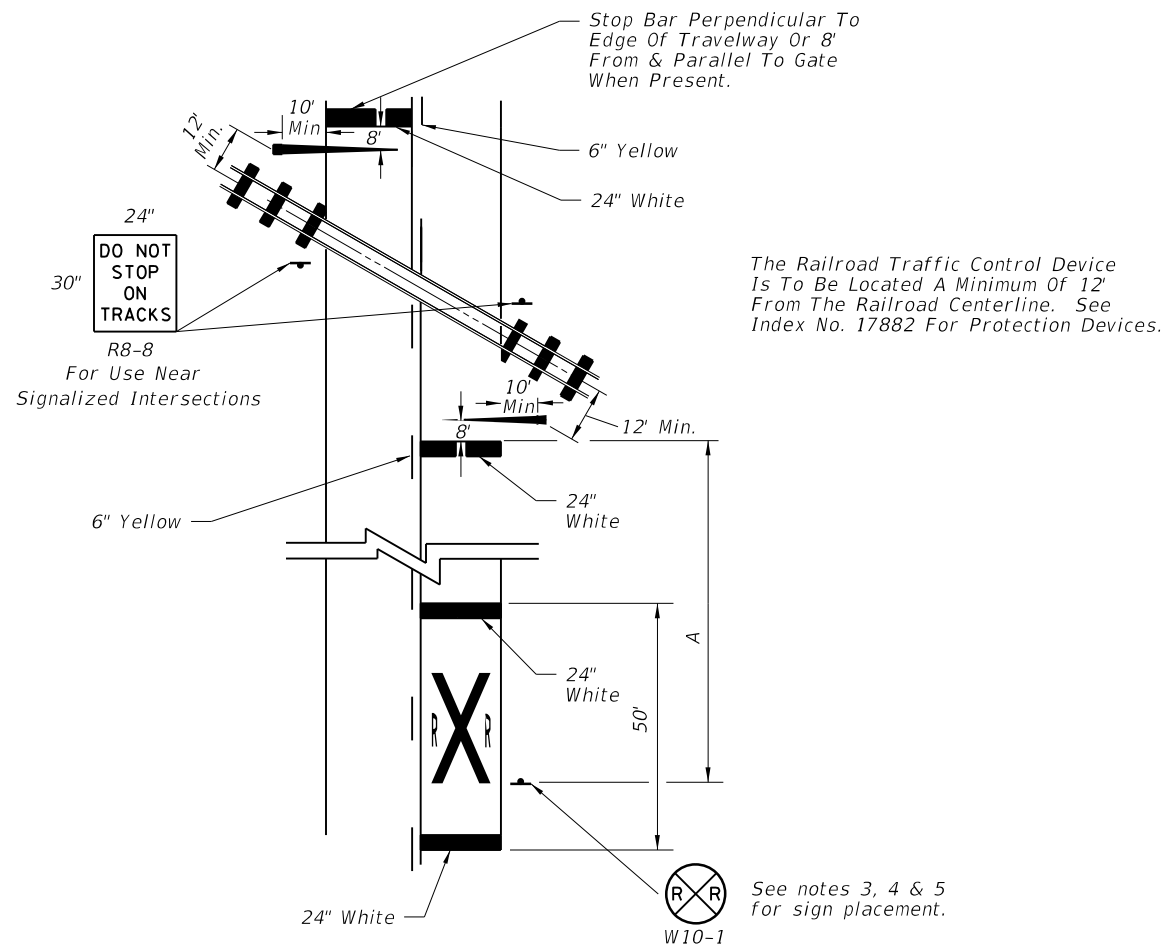

RAILROAD CROSSING AT 2-LANE ROADWAY

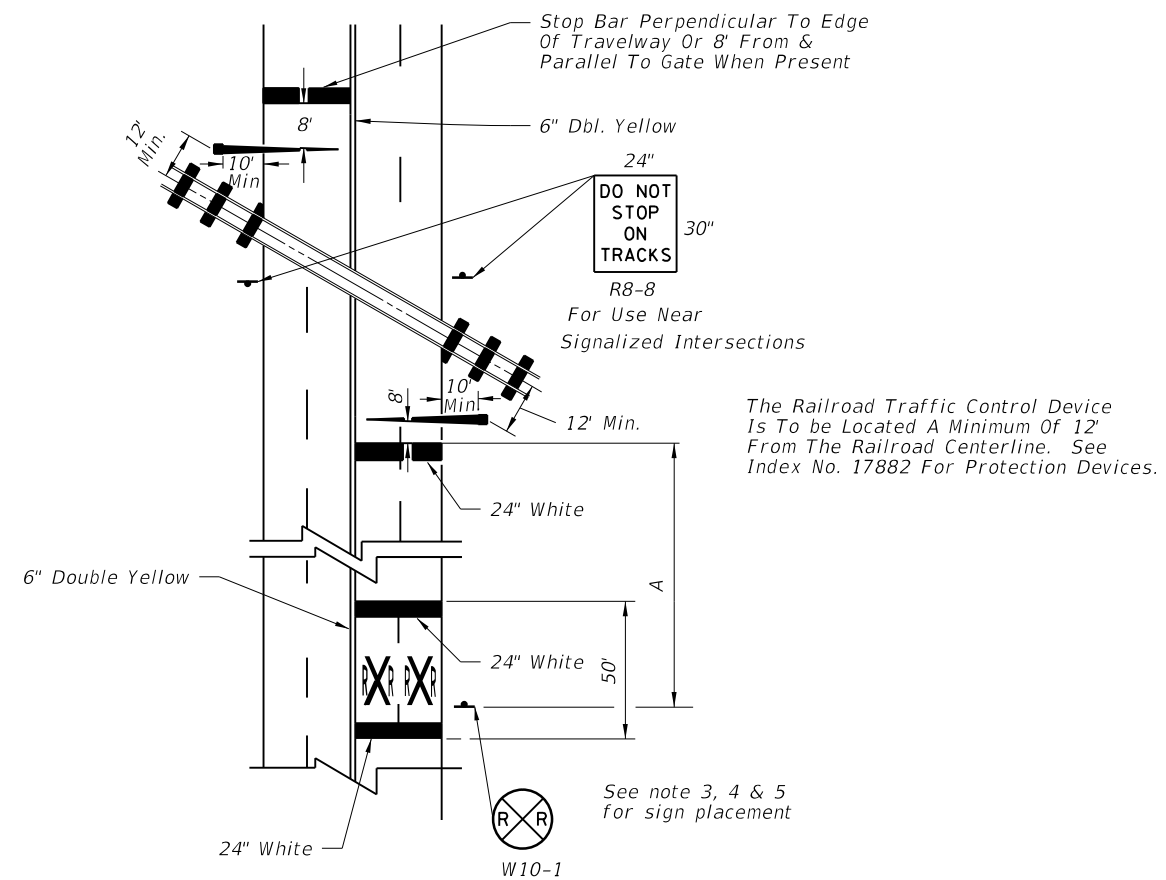

RAILROAD CROSSING AT 4-LANE ROADWAY

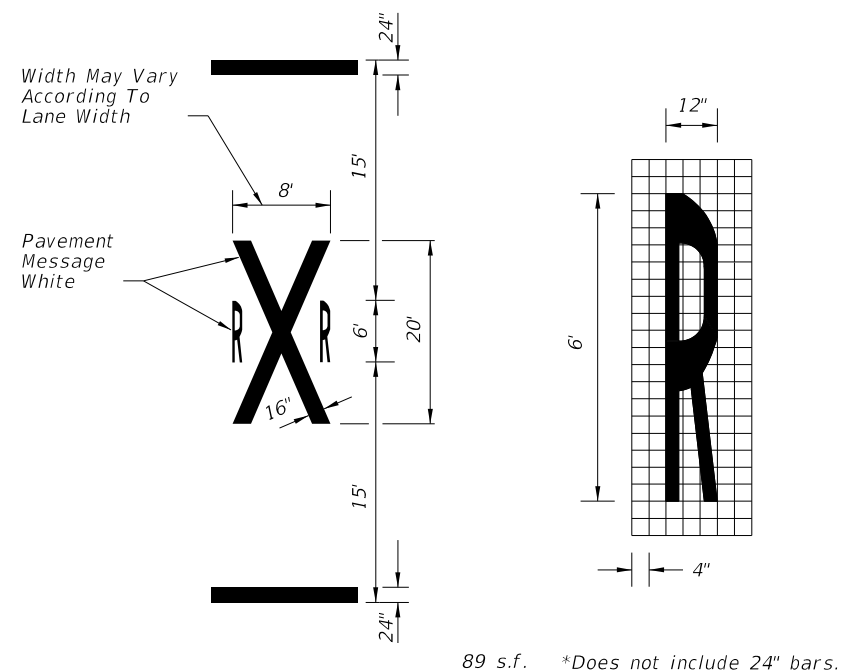

TYPICAL PAVEMENT MARKINGS FOR R/R CROSSING

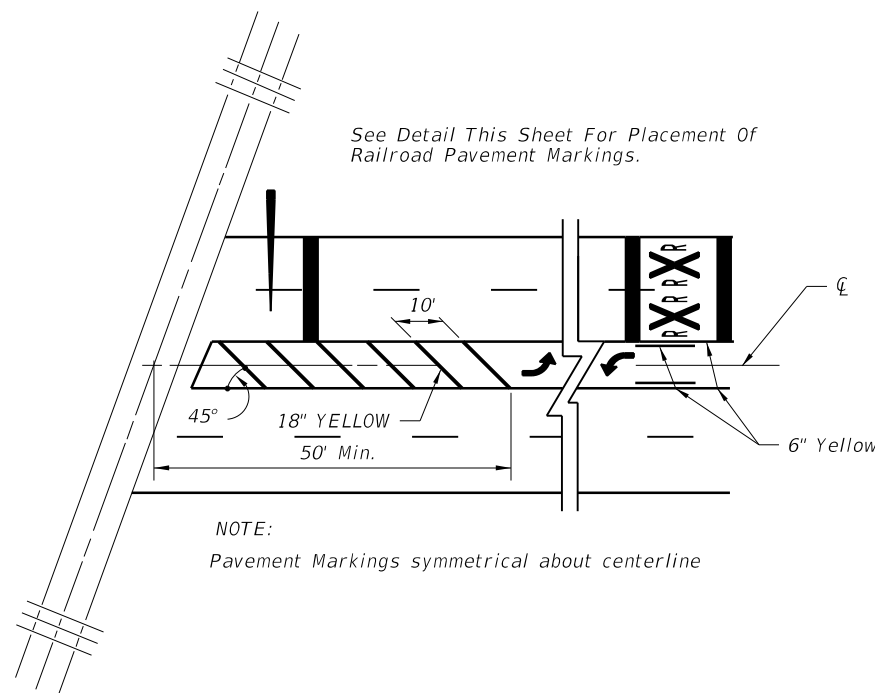

PAVEMENT MARKINGS FOR TERMINATION OF TWO WAY LEFT TURN AT R/R CROSSINGS

NOTES:

1. When computing pavement messages, quantities do not include transverse lines.
2. When dynamic devices are not present or are to be installed, the crossbuck shall be located at the future location of the RR gate or signal and gate in accordance with Index No. 17882.
3. Placement of sign W10-1 in a residential or business district, where low speeds are prevalent. The W10-1 sign may be placed a minimum distance of 100' from the crossing. Where street intersections occur between the RR pavement message and the tracks an additional W10-1 sign & additional Pavement message should be used.
4. Recommended location for FTP-61-06 or FTP-62-06 sign, 100' urban & 300' rural in advance of the crossing.
5. A portion of the pavement marking symbol should be directly opposite the W10-1 sign.

SPEED MPH	" A " IN FT.
60	400
55	325
50	250
45	175
40	125
35	100
URBAN	85 MIN.

6/24/2013 7:13:16 PM sm970re C:\projects\standards\roadway\17300-s\17346-08.dgn

C:\projects\standards\roadway\17300-s\17346-09.dgn
sm970re
7:13:17 PM
6/24/2013

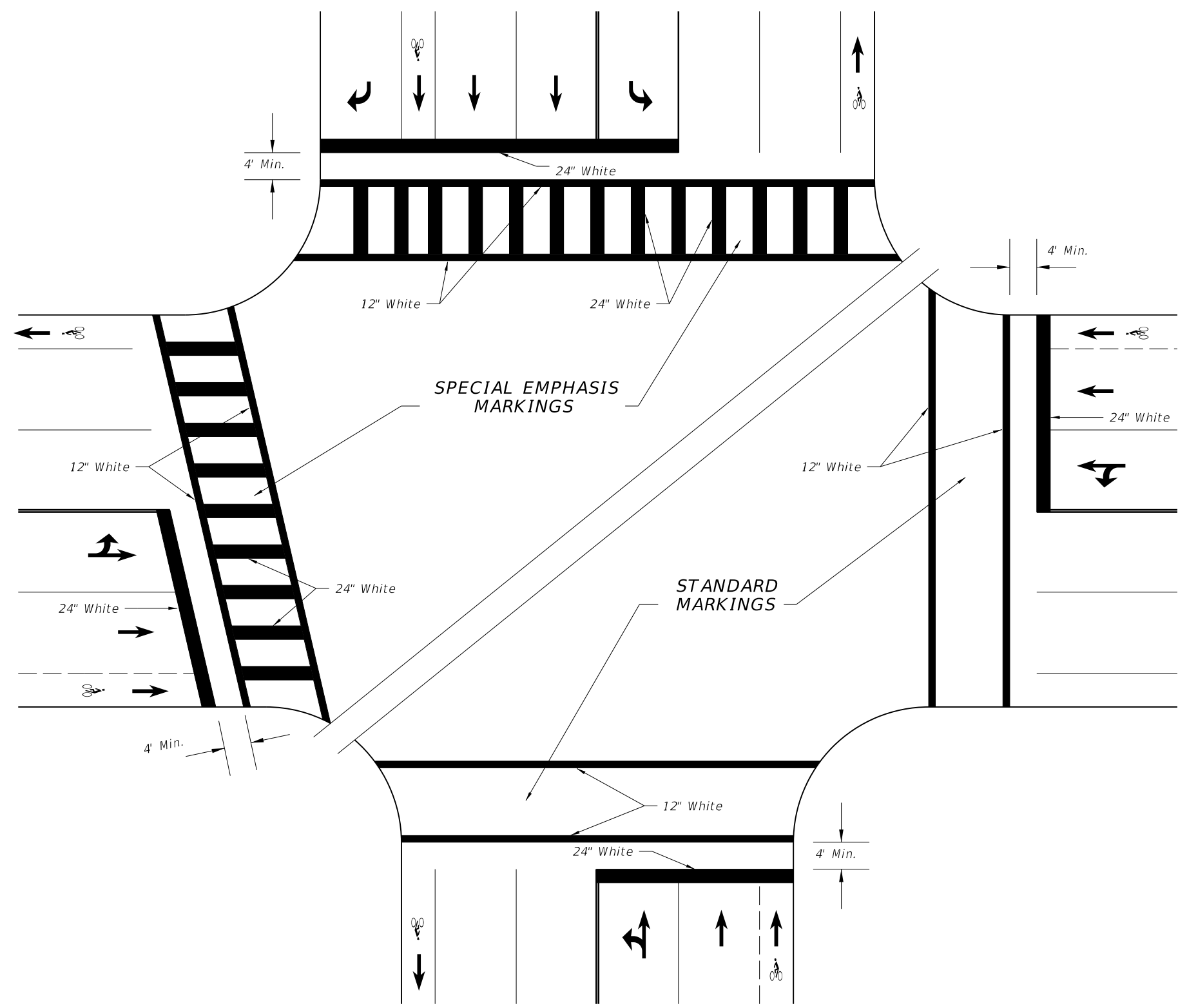

**SPECIAL EMPHASIS AND STANDARD CROSSWALKS
SIGNALIZED OR STOP SIGN CONTROLLED INTERSECTION**

GENERAL NOTES

1. For traffic and pedestrian signal installation, refer to Index No. 17721 through 17890.
2. For public sidewalk curb ramps, refer to Index No. 304.
3. For pavement marking and sign installation, refer to Indexes 11200 through 17356.
4. Crosswalk minimum widths: Intersection Crosswalk 6'. Midblock Crosswalk 10'.
5. All crosswalk marking shall be white.
6. Longitudinal lines in Special Emphasis Crosswalk shall be 24" wide and spaced to avoid the wheel path of vehicles as shown in detail. The maximum space between markings shall not exceed 60". A longitudinal marking shall be centered at each lane line. Additional longitudinal markings shall be placed at the center of each lane (1/2W).

Where the Crosswalk is skewed to the lane lane lines, the Special Emphasis longitudinal lines should be parallel to the lane line.

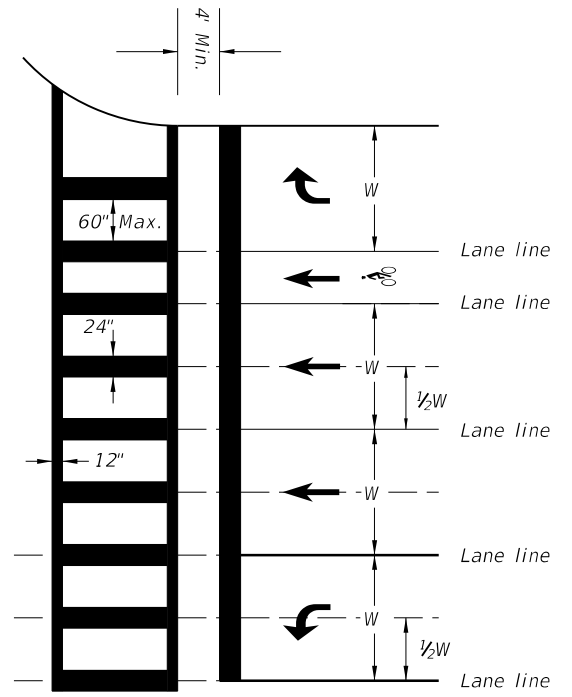

**SPECIAL EMPHASIS
CROSSWALK MARKING
DETAIL**

LAST REVISION 07/01/09	REVISION	DESCRIPTION:	 <p>FDOT 2014 DESIGN STANDARDS</p>	SPECIAL MARKING AREAS	INDEX NO. 17346	SHEET NO. 9 of 14
---------------------------	----------	--------------	--	------------------------------	---------------------------	-----------------------------

C:\projects\standards\roadway\17300-s\17346-10.dgn
sm970re
7:13:19 PM
6/24/2013

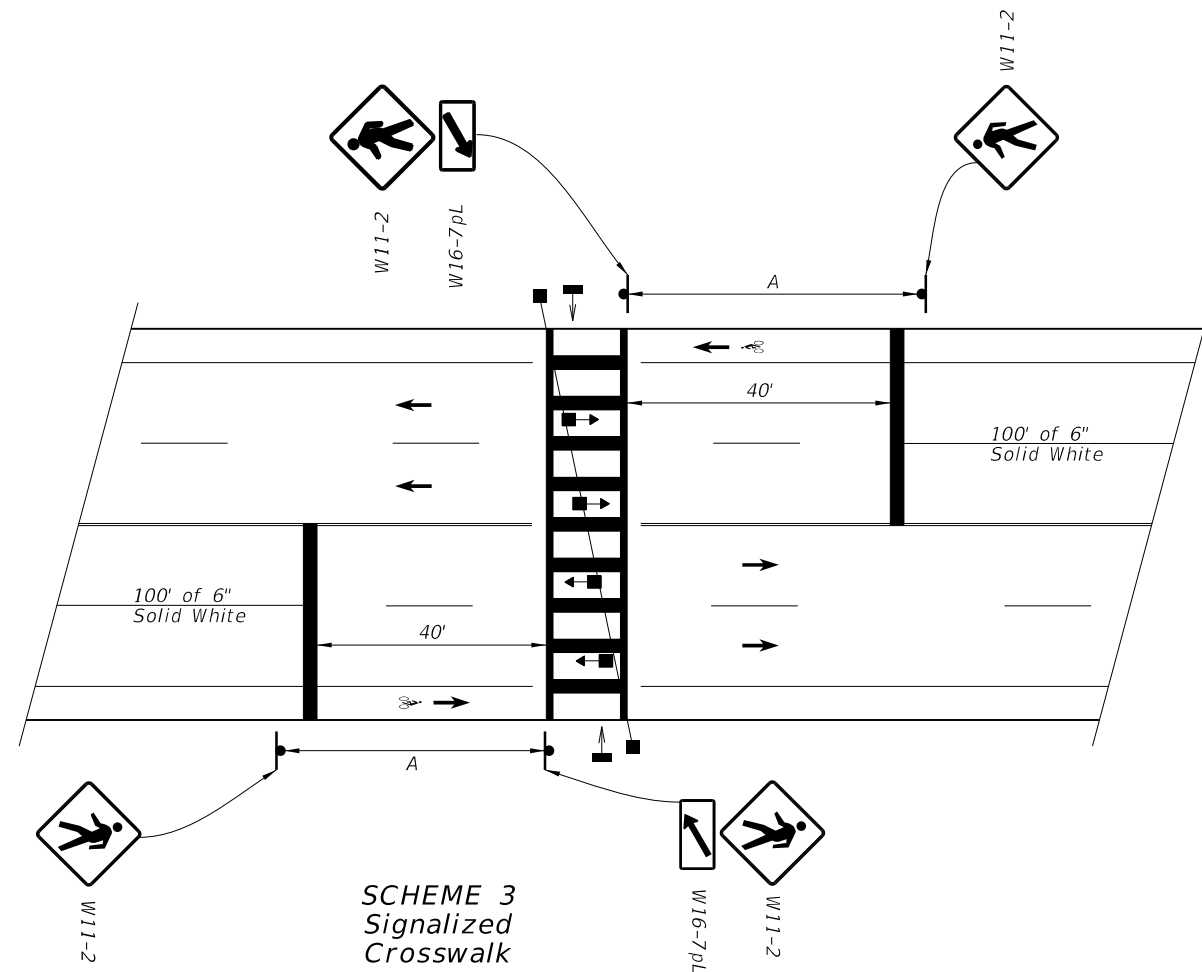
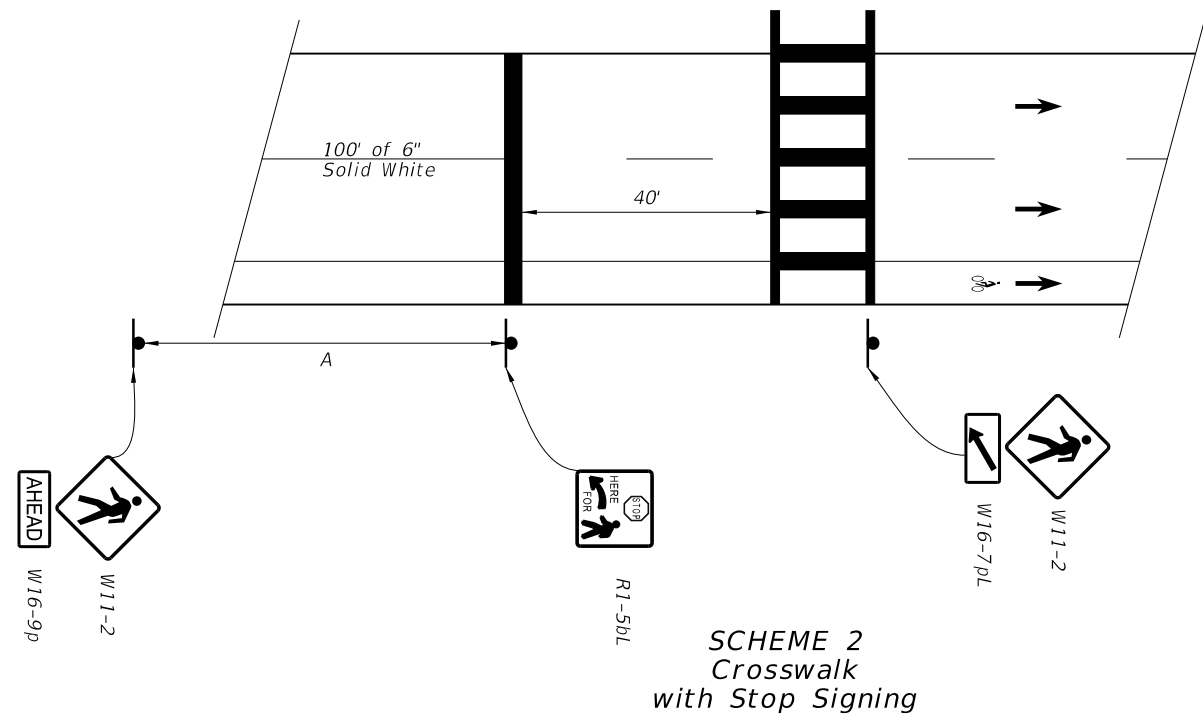
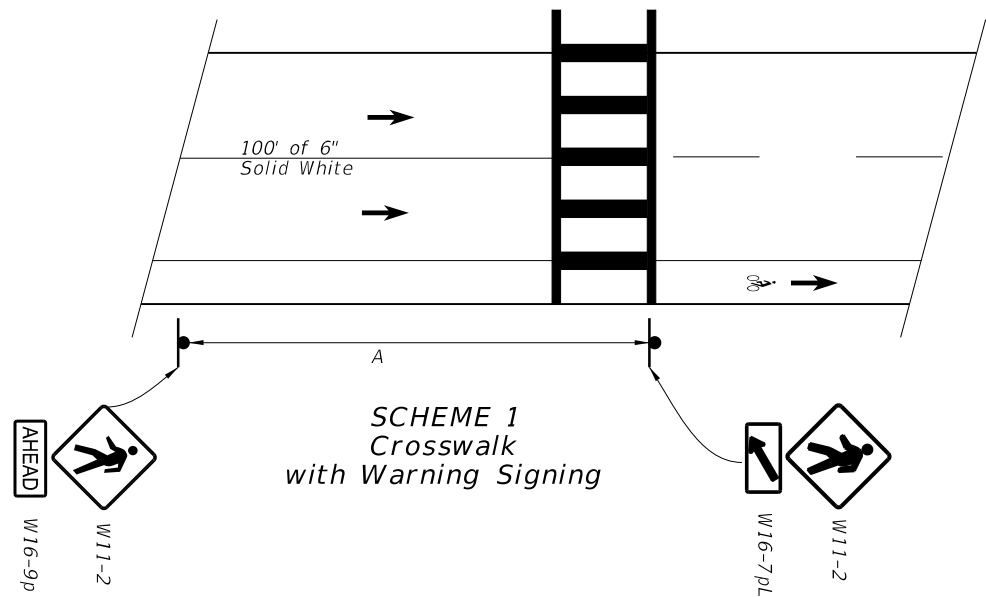

APPROACH SPEED MPH	A-SUGGESTED DISTANCE (Ft.)
25 Or Less	200
26 To 35	250
36 To 45	300

- Plans shall indicate which crosswalk scheme is to be used.
- The details shown do not depict the signing and markings for multi-lane roadways with divided medians. For these applications, additional signs shall be installed on the median side. Minimum width of Mid-Block Crosswalks is 10'.
- All mid-block crosswalks shall use special emphasis crosswalk markings.
- Crosswalk marking should utilize preformed marking materials.

LAST REVISION
01/01/12

REVISION

DESCRIPTION:



FDOT 2014
DESIGN STANDARDS

SPECIAL MARKING AREAS

INDEX NO.
17346

SHEET NO.
10 of 14

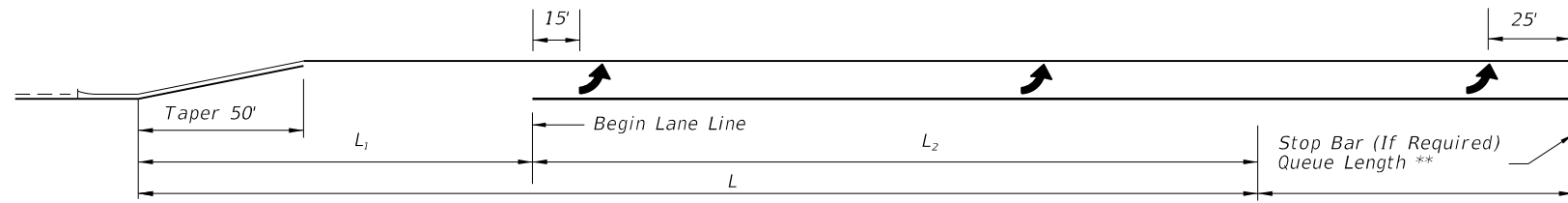

SINGLE LEFT TURNS

** Queue Length Is Measured From The Median Nose Radial Point Or, When A Stop Bar Is Required, From The Stop Bar.

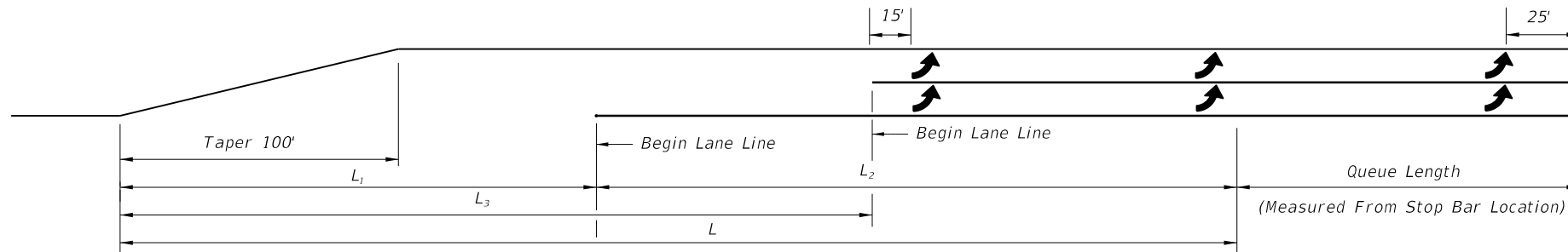

DOUBLE LEFT TURNS

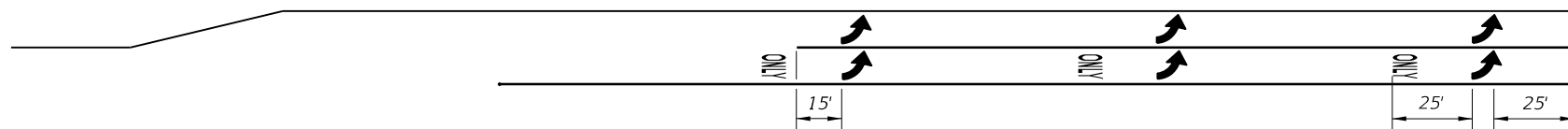

The ONLY pavement message is required for turn lanes, where the thru lane becomes turn lane.

Through Lane Becomes Exclusive Left Turn

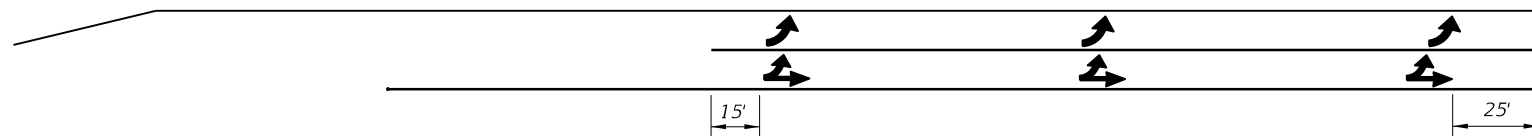

Through Lane Becomes Optional Left Turn

DOUBLE LEFT TURN MARKINGS

TURN LANES - CURBED AND UNCURBED MEDIANS							
Design Speed (mph)	Clearance Distance L ₁	URBAN CONDITIONS			RURAL CONDITIONS		
		Brake To Stop Distance L ₂	Total Decel. Distance L	Clearance Distance L ₃	Brake To Stop Distance L ₂	Total Decel. Distance L	Clearance Distance L ₃
35	70'	75'	145'	110'	---	---	---
40	80'	75'	155'	120'	---	---	---
45	85'	100'	185'	135'	---	---	---
50	105'	135'	240'	160'	185'	290'	160'
55	125'	---	---	---	225'	350'	195'
60	145'	---	---	---	260'	405'	230'
65	170'	---	---	---	290'	460'	270'

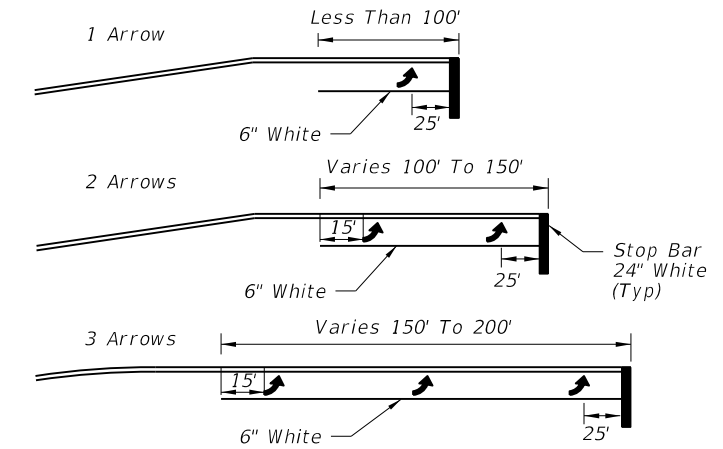

Arrow should be evenly spaced between first and last arrow. Turn lanes longer than 200' add one arrow for each 100' additional length.

ARROW SPACING

NOTES:

1. The "Begin Lane Line" locations are based on the standard lengths shown in Design Standard 301. These locations must be adjusted on a case by case basis for turn lanes not meeting the standard lengths.
2. Yellow left turn edge marking may be used adjacent to raised curb or grass medians if lane use is not readily apparent to drivers approaching a left turn storage lane.
3. Refer to Design Standard Index 301 for Roadway Details.
4. This Index also applies to right turn lanes.

C:\projects\standards\roadway\17300-s\17346-1.dgn sm970re 7:13:21 PM 6/24/2013

6/24/2013 7:13:23 PM sm970re C:\projects\standards\roadway\17300-s\17346-12.dgn

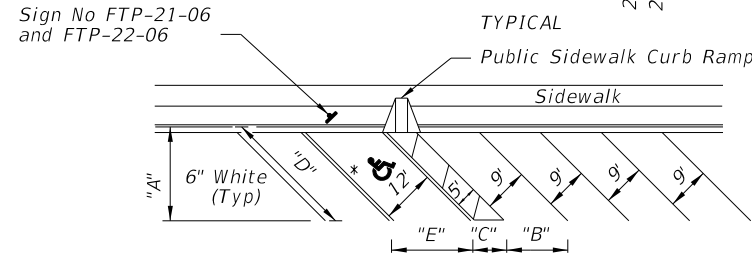
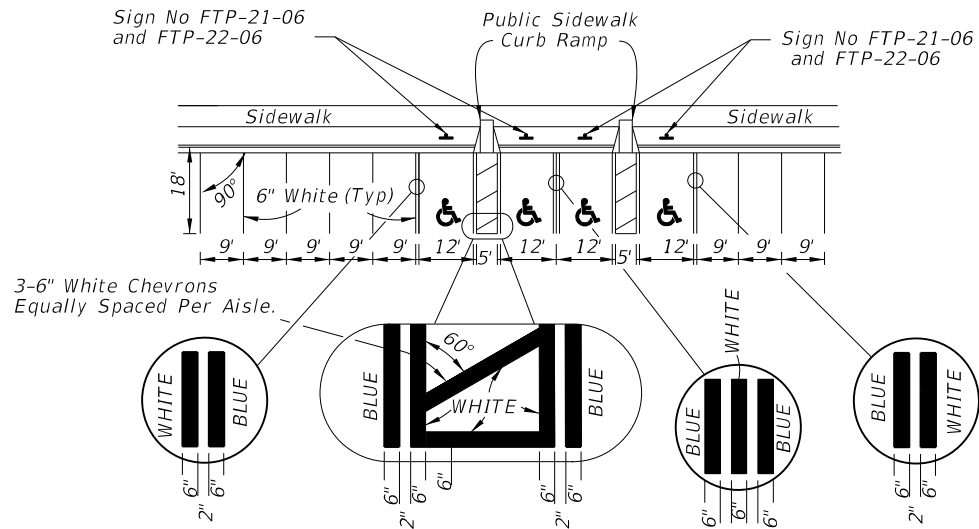
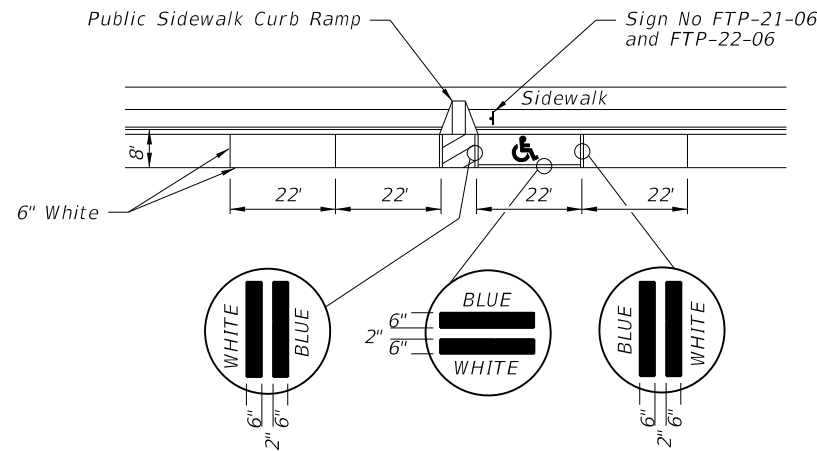

* FOR ACCESSIBLE MARKINGS - SEE ABOVE

"DIMENSIONS"					
∠ θ	"A"	"B"	"C"	"D"	"E"
45°	19'-1"	12'-9"	7'-0"	27'-0"	17'-0"
60°	20'-1"	10'-5"	5'-9"	23'-2"	13'-10"

- NOTES:
- Dimensions are to the centerline of markings.
 - An Access Aisle is required for each accessible space when angle parking is used.
 - Criteria for pavement markings only, not public sidewalk curb ramp locations. For ramp locations refer to plans.
 - Blue pavement markings shall be tinted to match shade 15180 of Federal Standards 595a.
 - The FTP-22-06 panel shall be mounted below the FTP-21-06 sign.

PAVEMENT MARKING FOR PUBLIC SIDEWALK CURB RAMPS IN REST AREAS

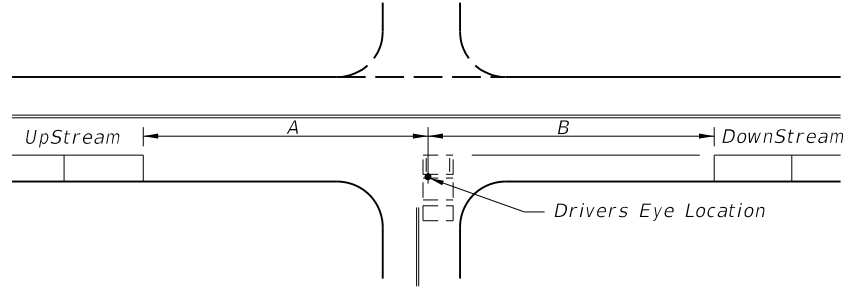

SPEED MPH	UP STREAM (A)	DOWN STREAM (B)	
		2 LANE	4 LANE
0-30	85'	60'	45'
35	100'	70'	50'

- NOTES
- Distances measured longitudinally along the street from driver location of entering vehicle to end of parking restriction.
 - Distances applicable to intersecting street, major driveways and other driveways to the extent practical.
 - For nonsignalized intersections, the values above shall be compared with the values for signalized intersections and the maximum restrictions implemented. These restrictions apply to both accessible and nonaccessible parking.

MINIMUM PARKING RESTRICTION FOR NONSIGNALIZED INTERSECTIONS

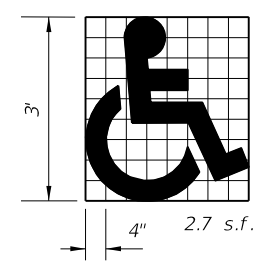
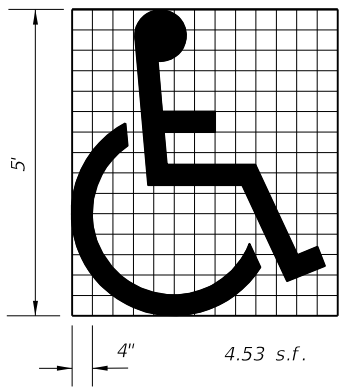

Use of pavement symbol in accessible parking spaces is optional, when used the symbol shall be 3' or 5' high and white in color.

UNIVERSAL SYMBOL OF ACCESSIBILITY

GENERAL NOTES (Signalized & Nonsignalized)

- For entrances to a one-way street, the downstream restriction may be reduced to 20'.
- Parking shall not be allowed within 20' of a crosswalk.
- All parking lane markings shall be 6" white.
- Parking lane lines shall be broken at driveways.
- Refer to Chapter 316, Fla. Statutes, for laws governing parking spaces.
- Where curb and gutter is used, the gutter pan width may be included as part of the minimum width of parking lane, but desirably the lane width should be in addition to that of the gutter pan.

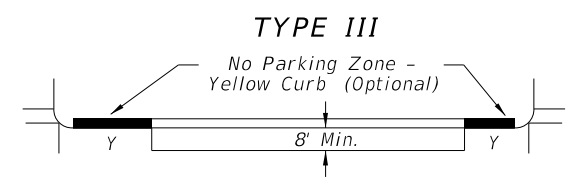
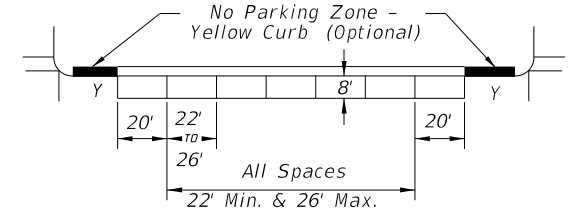
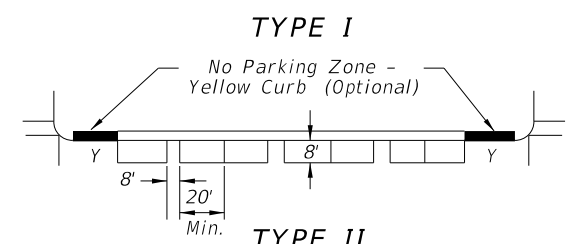

SPEED LIMIT MPH	SIGNALIZED INTERSECTIONS
0-30	30'
35	50'

DISTANCE FROM CURB RADIUS (Y)

PARKING RESTRICTION (FT.) FOR SIGNALIZED INTERSECTION

- NOTES:
- Parking restrictions measured from curb radius point.
 - Restrictions for accessible parking are the same as those applied to nonsignalized intersections.

MINIMUM PARKING RESTRICTION FOR SIGNALIZED INTERSECTION

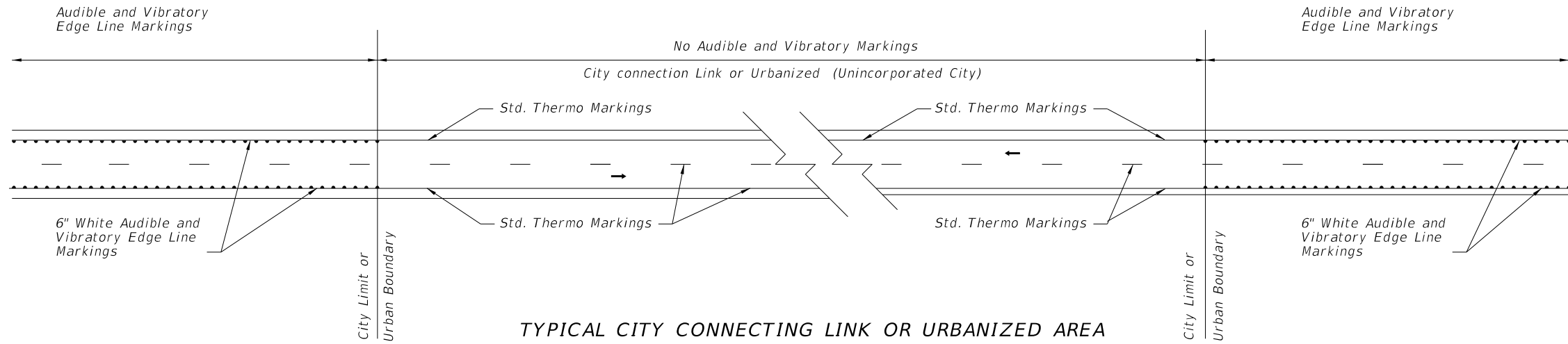

TYPICAL CITY CONNECTING LINK OR URBANIZED AREA

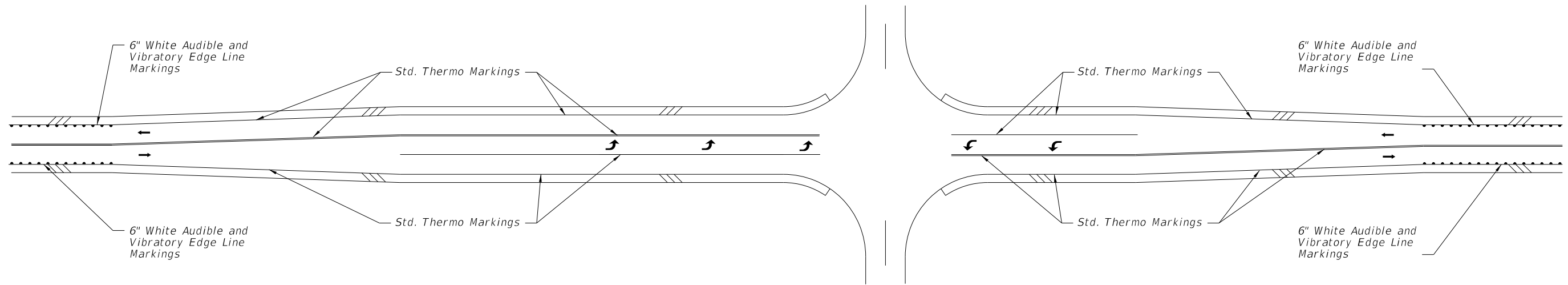

TYPICAL RURAL INTERSECTION WITH TURN LANES

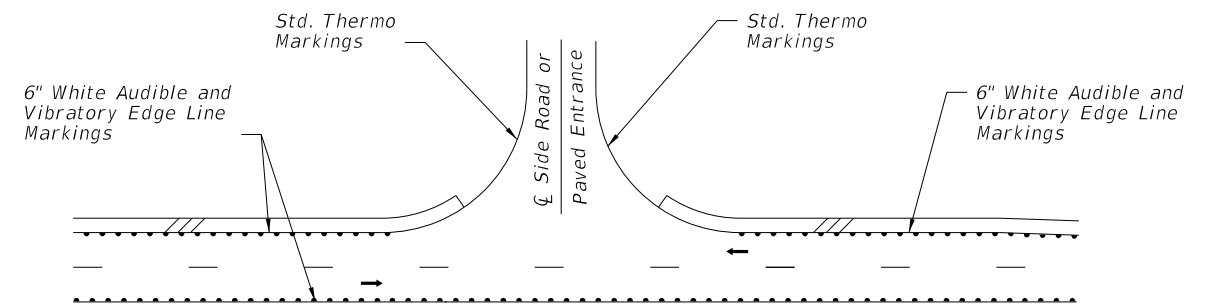
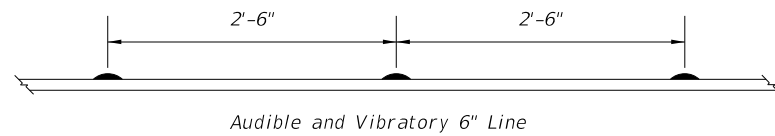

TYPICAL RURAL INTERSECTION WITHOUT TURN LANES

AUDIBLE AND VIBRATORY MARKINGS

2 LANE ROADWAYS

6/24/2013 7:13:25 PM sm970re C:\projects\standards\roadway\17300-s\17346-13.dgn

LAST REVISION	DESCRIPTION:
07/01/09	

REVISION	DESCRIPTION:

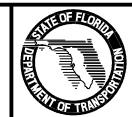

FDOT 2014
DESIGN STANDARDS

SPECIAL MARKING AREAS

INDEX NO.
17346

SHEET NO.
13 of 14

C:\projects\standards\roadway\17300-s\17346-14.dgn
sm970re
7/13/26 PM
6/24/2013

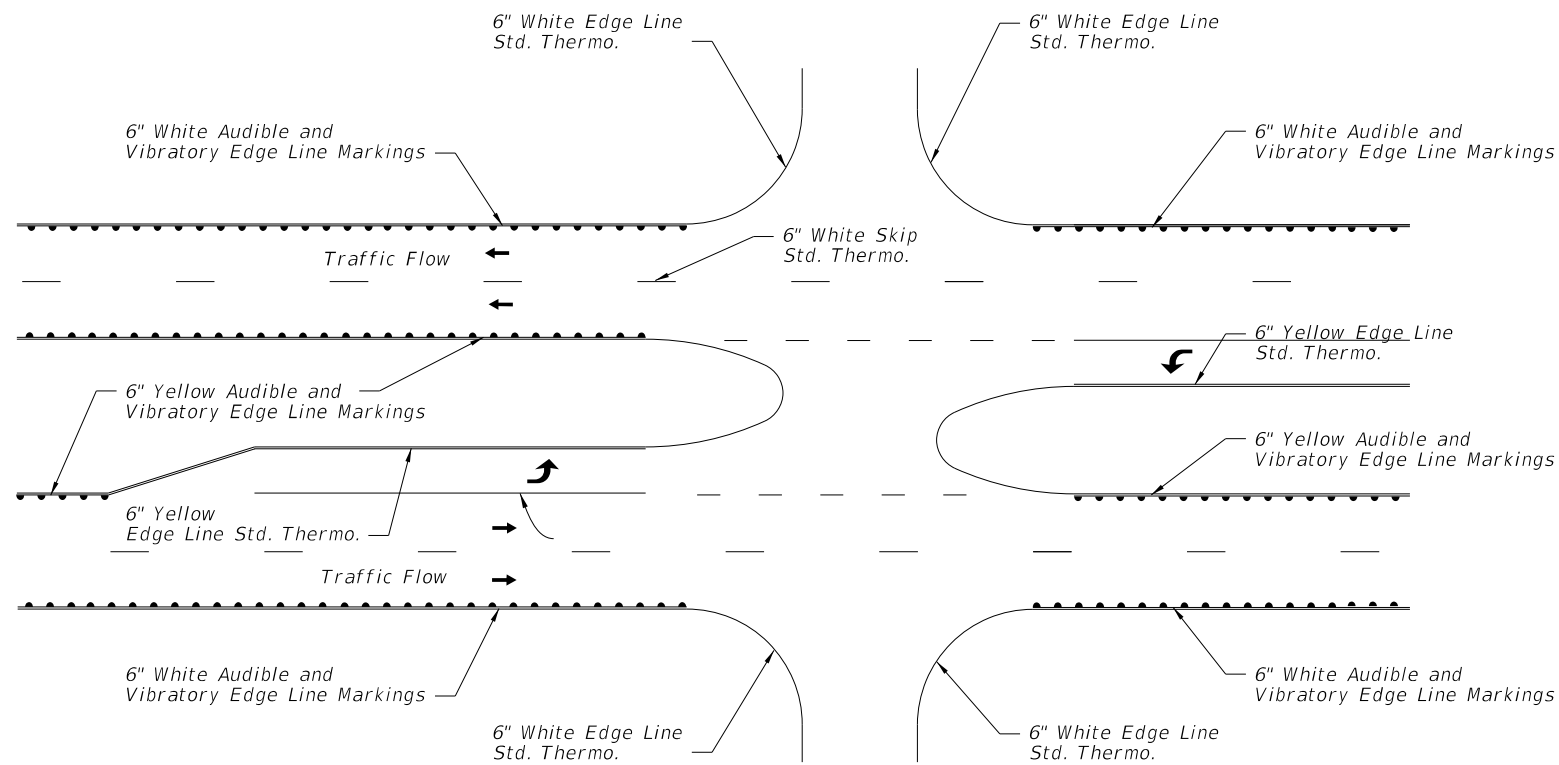

1. The Contractor Shall Adjust The Maintenance Of Traffic During Installation To Provide Sufficient Time For The Markings To Bear Traffic.
2. The Height Of The Transverse Bar For Markings Shall Be A Minimum Of 0.45 Inches Above The Pavement Surface At The Edge Of The Marking.
3. Transverse Bars Shall Be Evenly Space In The Marking At Intervals Of 30 Inches Center To Center.
4. The Transverse Bar May Have A Drainage Channel On Each Bar. The Width Of The Drainage Channel May Not Exceed 0.25 Inches At The Bottom Of The Channel.
5. Audible And Vibratory Markings Shall Only Be Installed On Centerline Markings Of Two Lane Roads When Shown In The Plans.
6. When Raised Pavement Markers Conflict With The Installation Of The Centerline Markings, The Contractor Shall Be Responsible For Removing And Replacing The Raised Pavement Markings. The Additional Expenses Associated With The Raised Pavement Markings Shall Be Included In The Cost Of The Marking.
7. Grinding Is An Acceptable Method Of Removal Of The Existing Markings Where Markings Are Installed As Replacement Markings.
8. The Specifications Allow The Audible Markings To Utilize A Flat Base Line Or An Inverted Rib Profile Base Line.

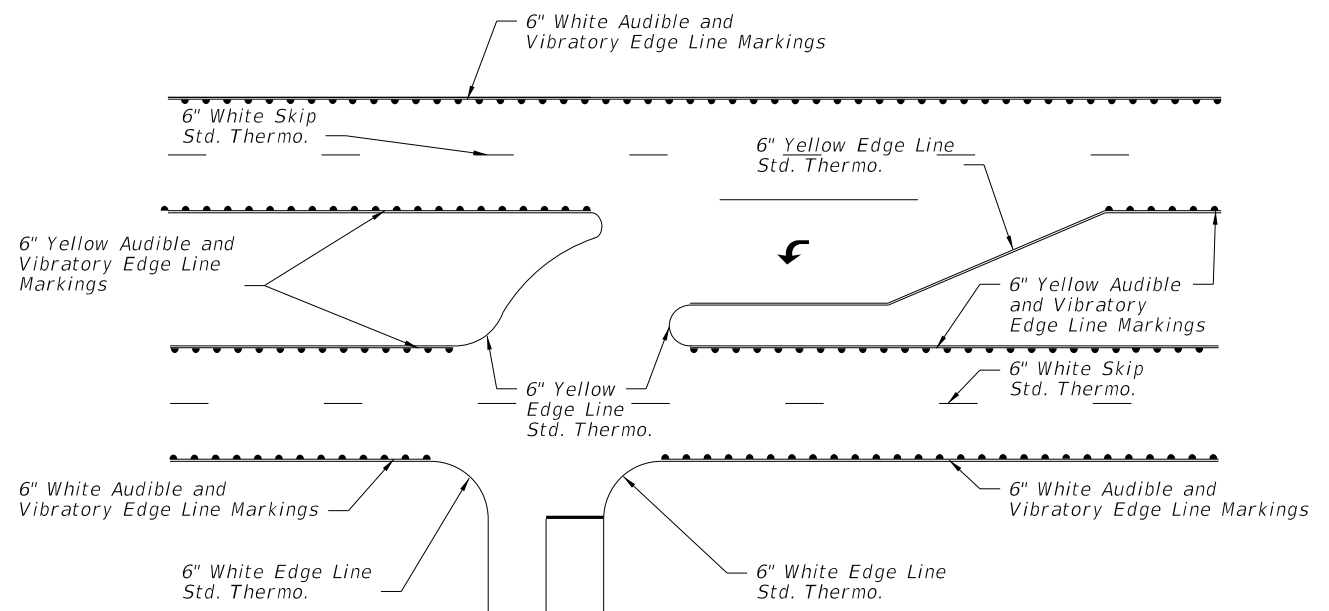
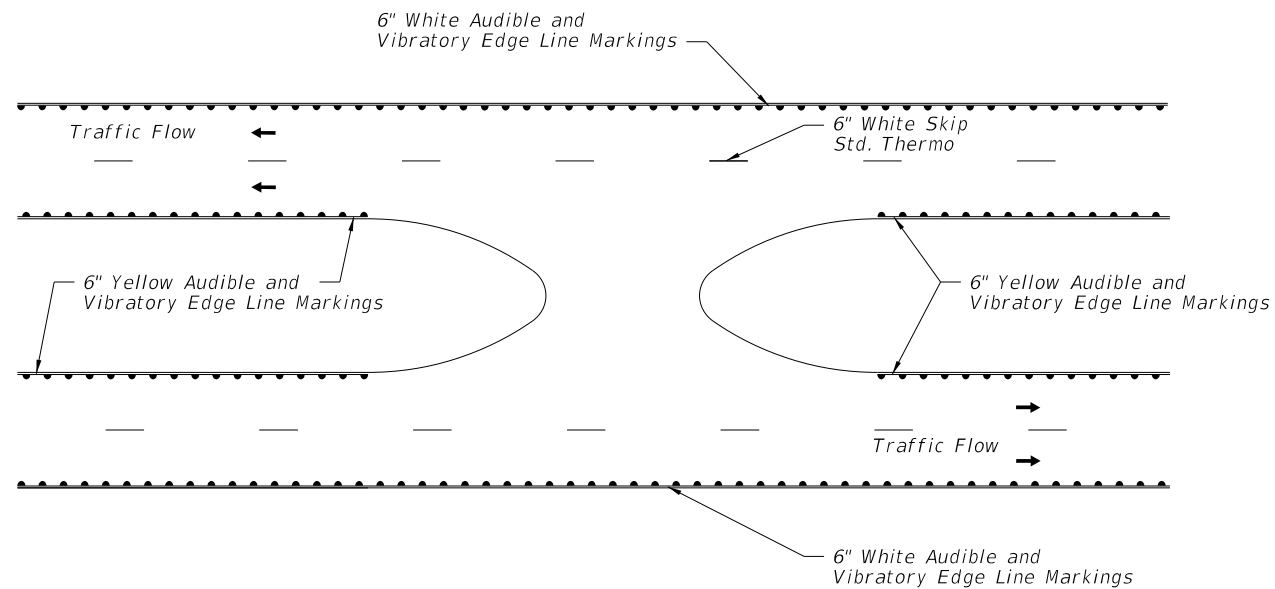

AUDIBLE AND VIBRATORY MARKINGS

MULTI-LANE ROADWAYS

LAST REVISION 07/01/10	REVISION	DESCRIPTION:	 <p>FDOT 2014 DESIGN STANDARDS</p>	<p>SPECIAL MARKING AREAS</p>		INDEX NO. 17346	SHEET NO. 14 of 14