

6/28/2012 12:16:44 PM rd960/h C:\projects\standards\roadway\17300-s\17355-01.dgn

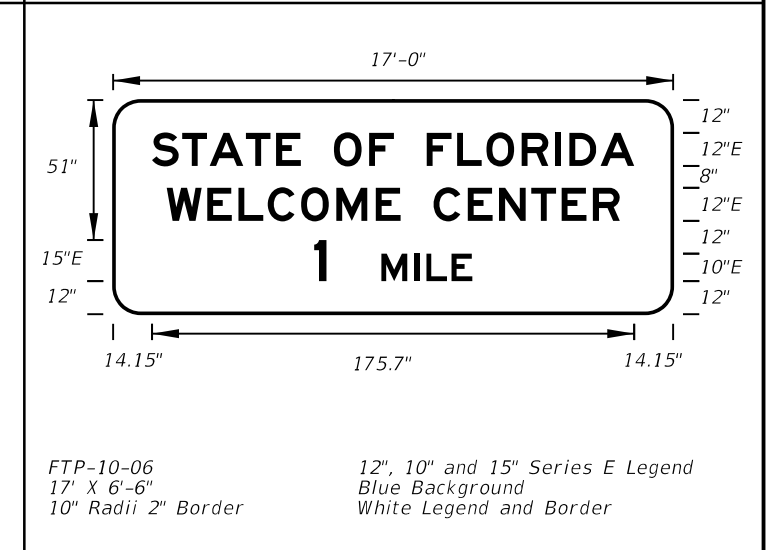

LAST REVISION	07/01/09	DESCRIPTION:	<b>FDOT DESIGN STANDARDS</b> 2013	<b>SPECIAL SIGN DETAILS</b>	INDEX NO.	SHEET NO.
					17355	1

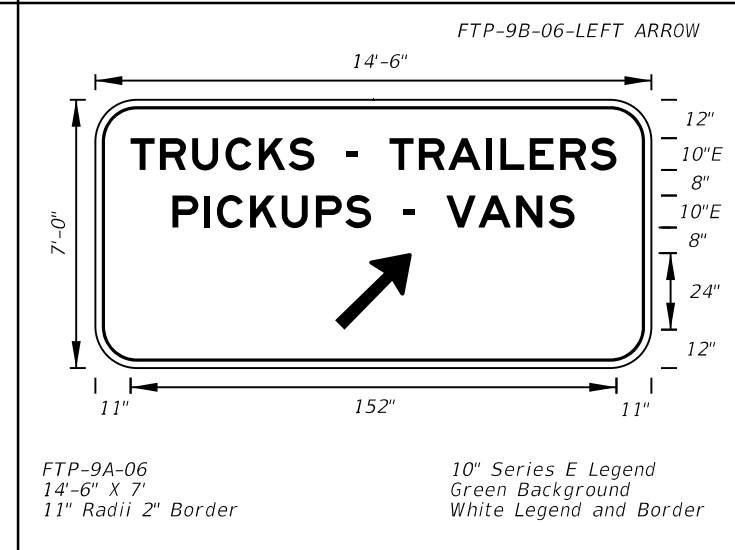
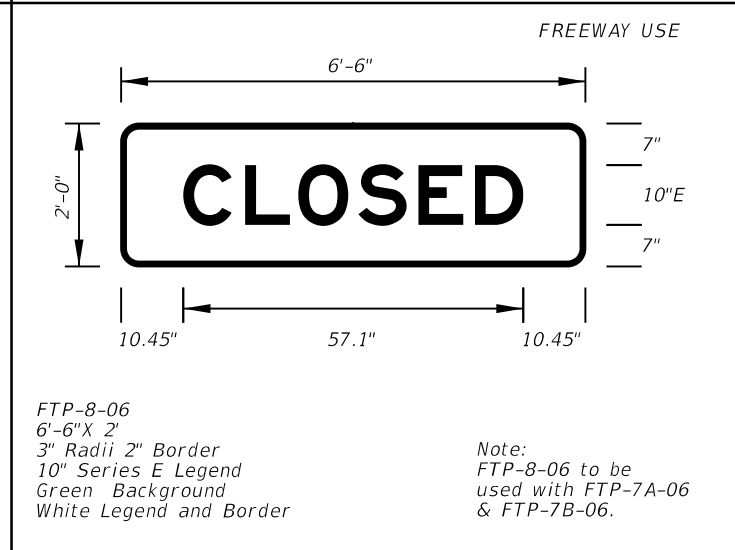
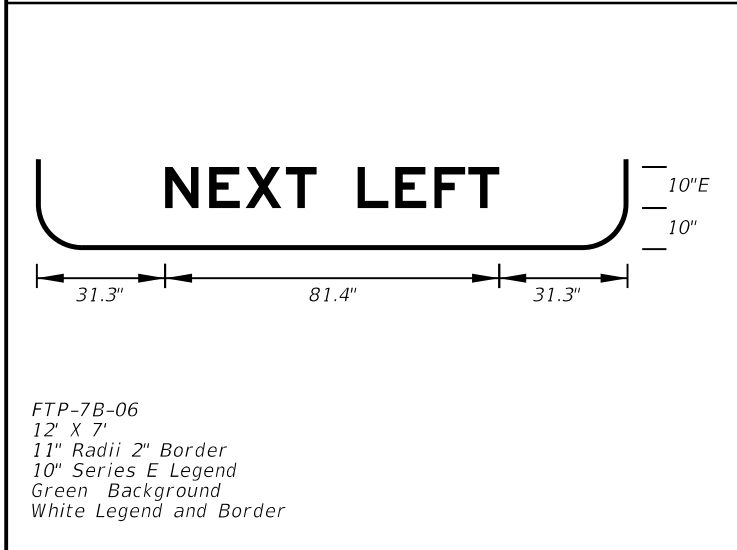
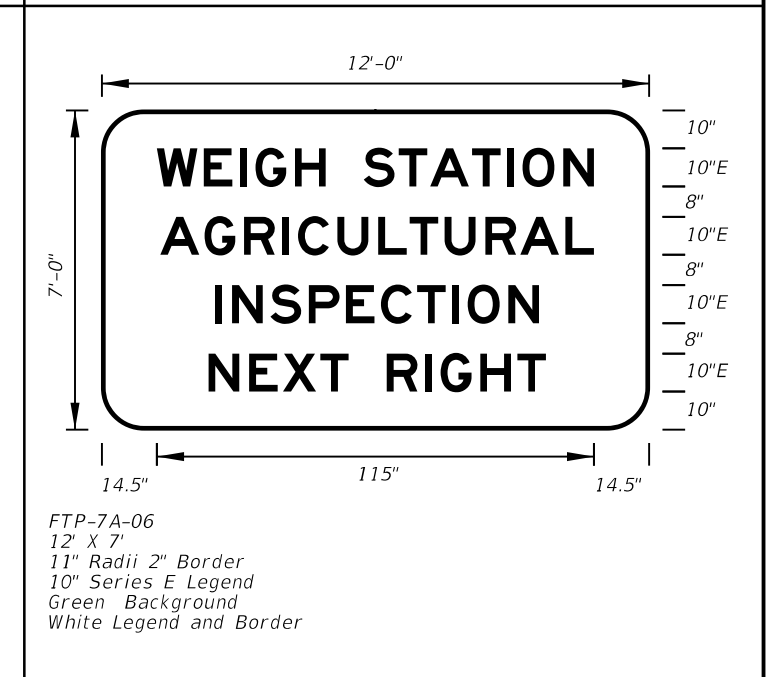
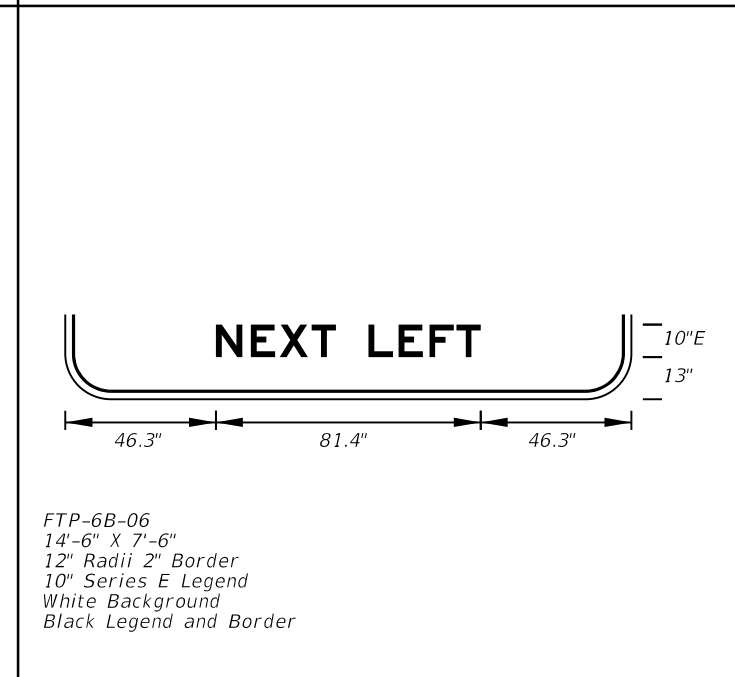
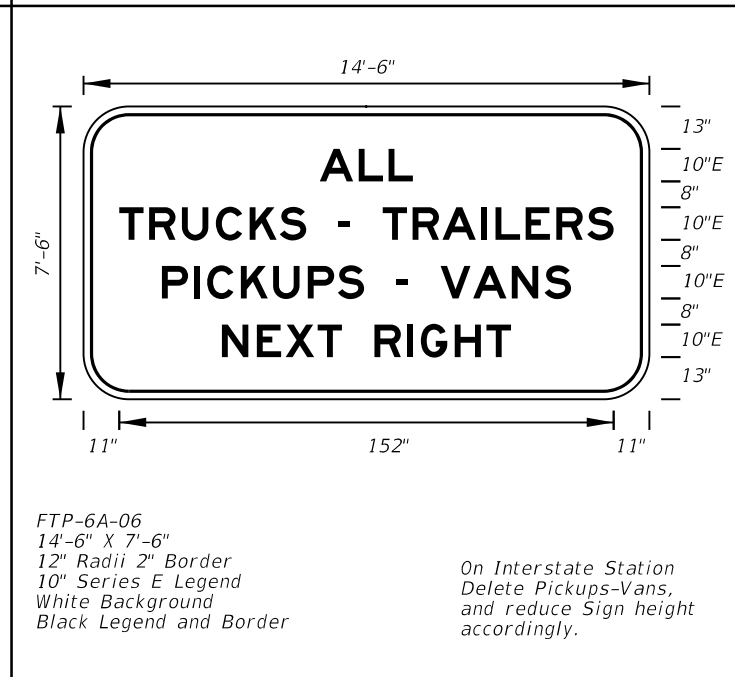
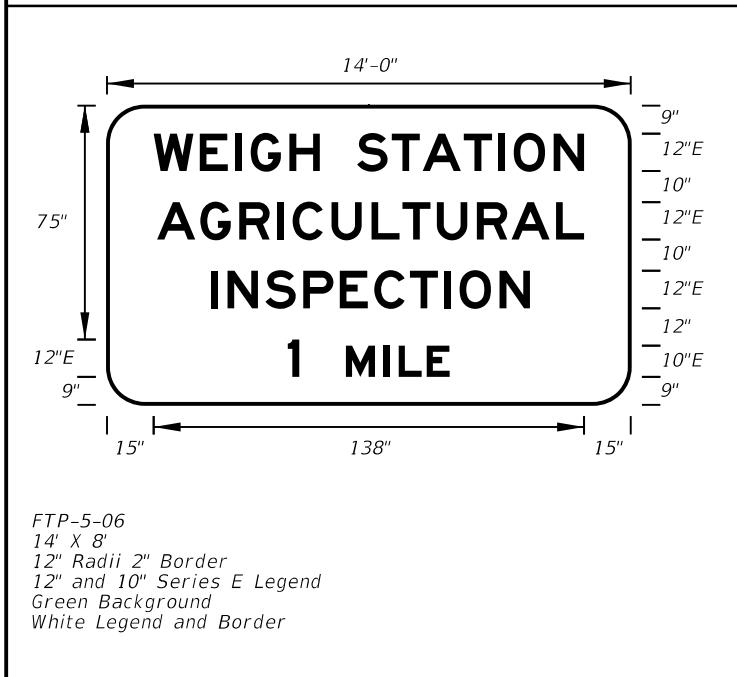
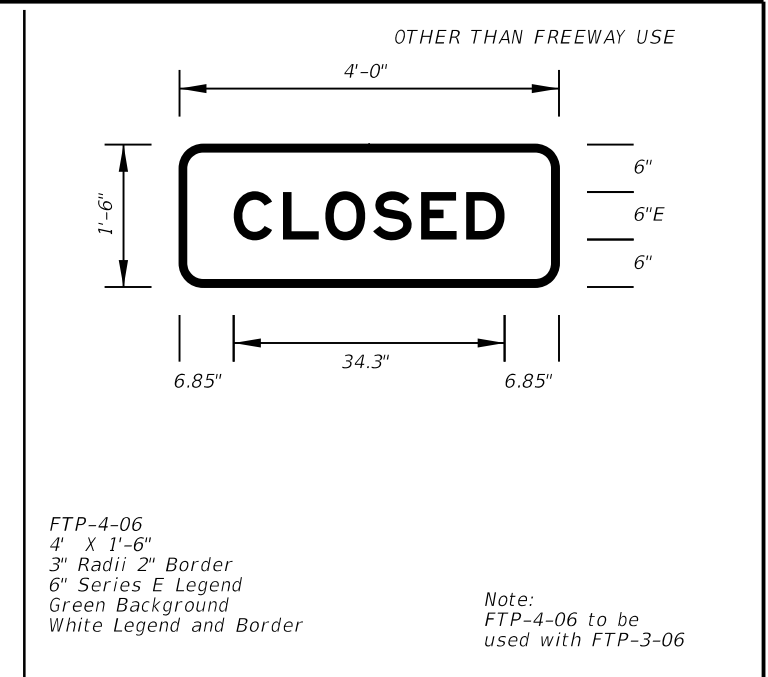
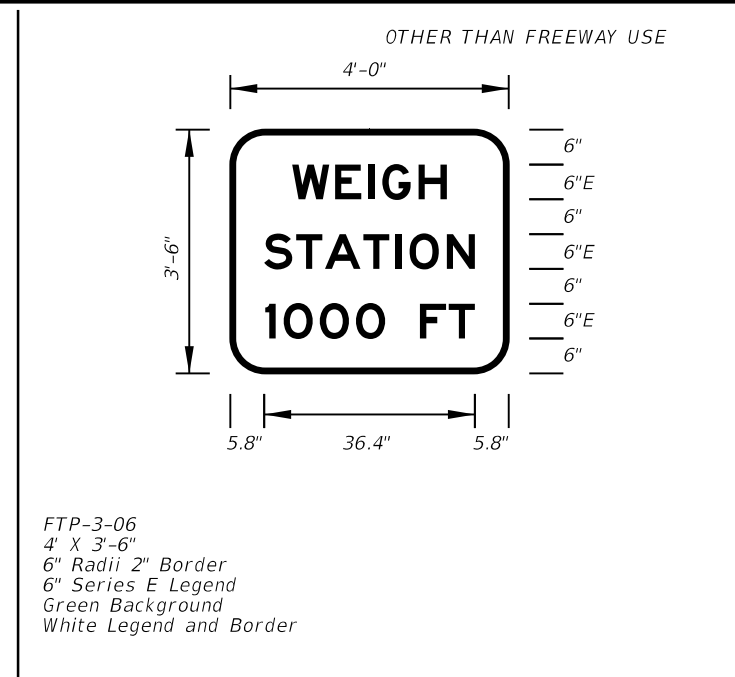
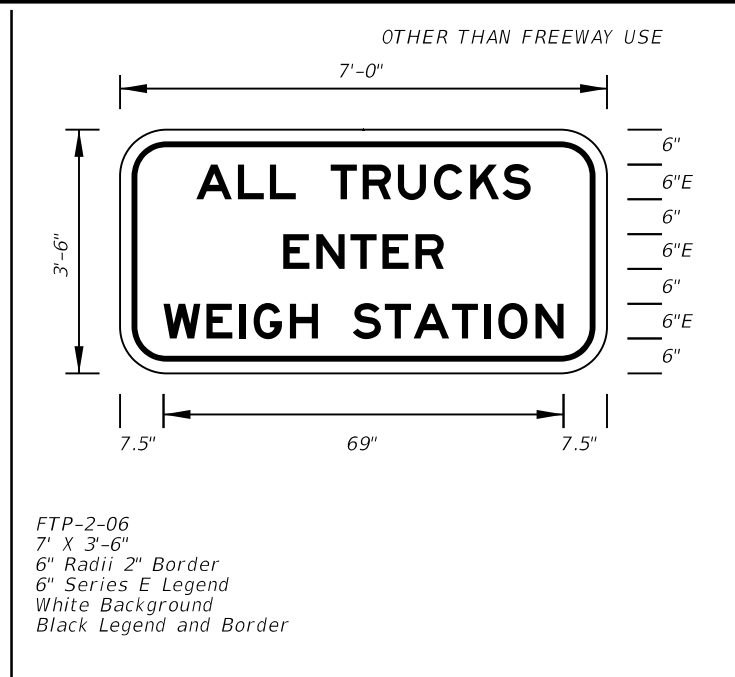
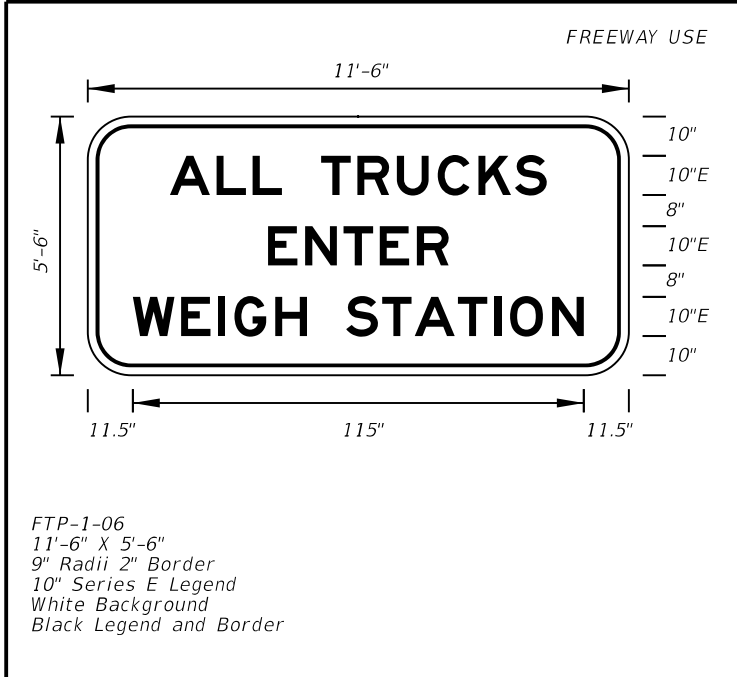
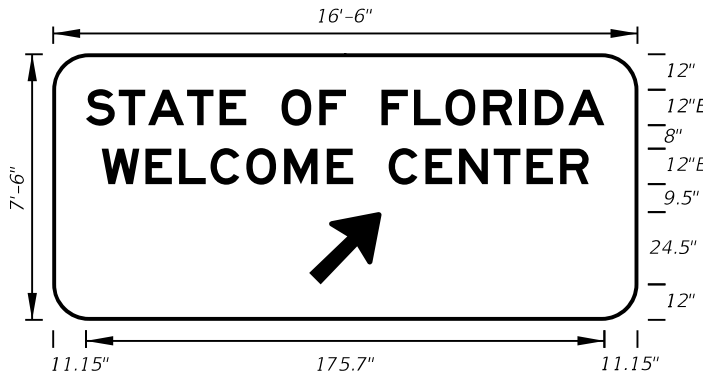

FTP-11-06  
16'-6" X 7'-6"  
12" Radii 2" Border  
12" Series E Legend  
Blue Background  
White Legend and Border

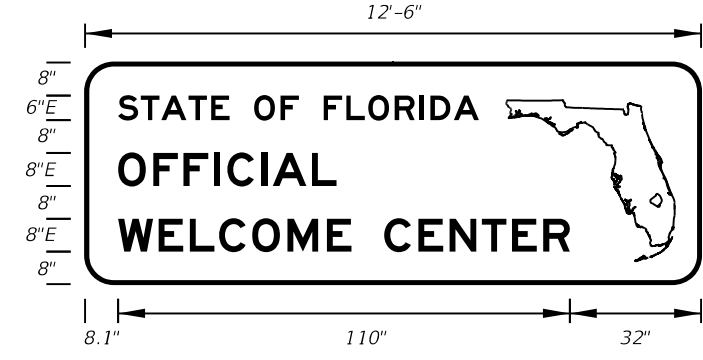

FTP-12-06  
12'-6" X 8'-6"  
7" Radii 2" Border  
6" and 8" Series E Legend  
Blue Background  
White Legend and Border

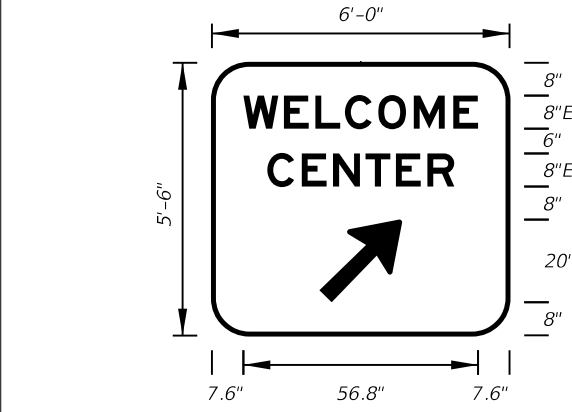

FTP-13-06  
6' 0" X 5'-6"  
9" Radii 2" Border  
8" Series E Legend  
Blue Background  
White Legend and Border

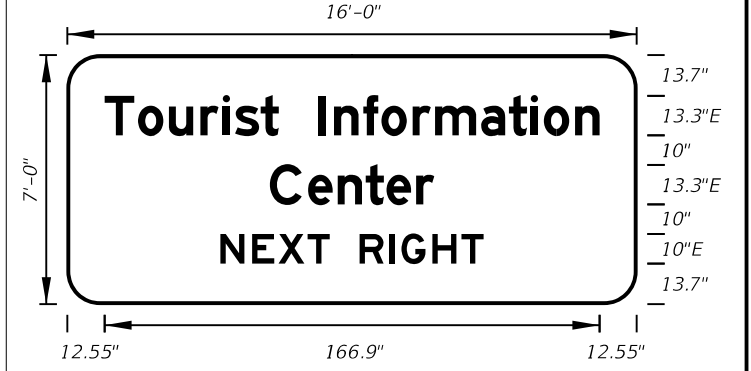

FTP-14-06  
16'-0" X 7'-0"  
11" Radii 2" Border  
13.3 and 10" Series E Legend  
Blue Background  
White Legend and Border

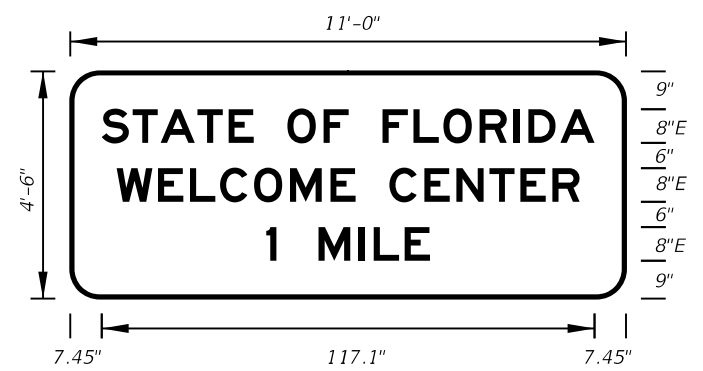

FTP-15A-06  
11'-0" X 4'-6"  
7" Radii 2" Border  
8" Series E Legend  
Blue Background  
White Legend and Border

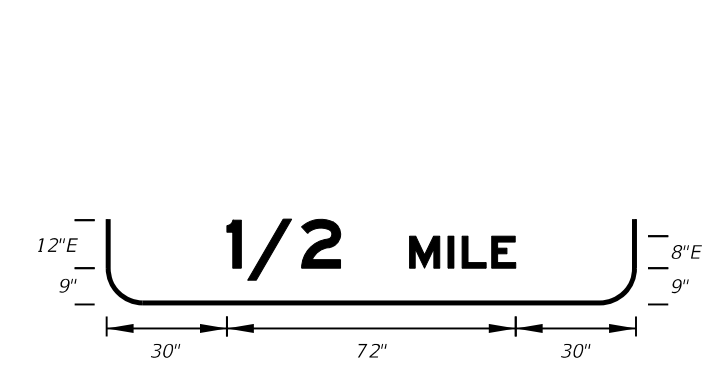

FTP-15B-06  
11'-0" X 5'-0"  
8" Radii 2" Border  
8" and 12" Series E Legend  
Blue Background  
White Legend and Border

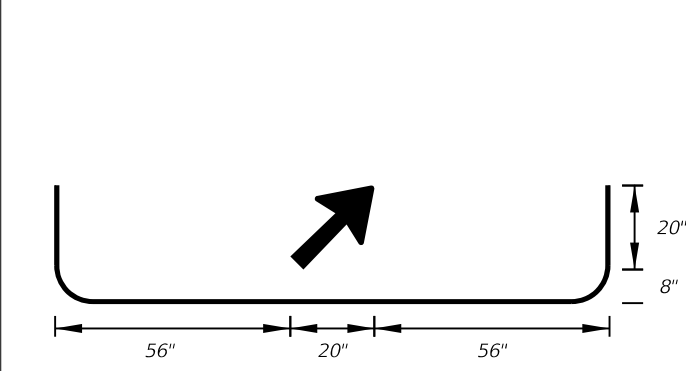

FTP-15C-06  
11'-0" X 5'-6"  
9" Radii 2" Border  
8" Series E Legend  
Blue Background  
White Legend and Border

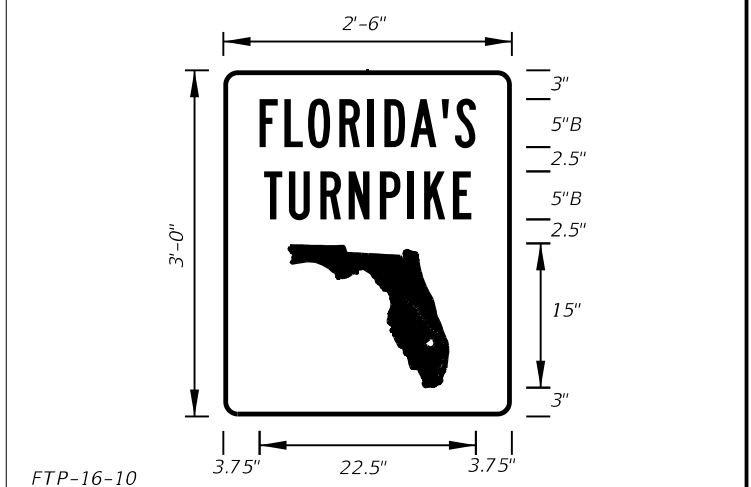

FTP-16-10  
2'-6" X 3'-0"  
1.5" Radii 3/4" Border  
5" Series B Legend  
Green Background  
White Legend, Border, and Florida Symbol

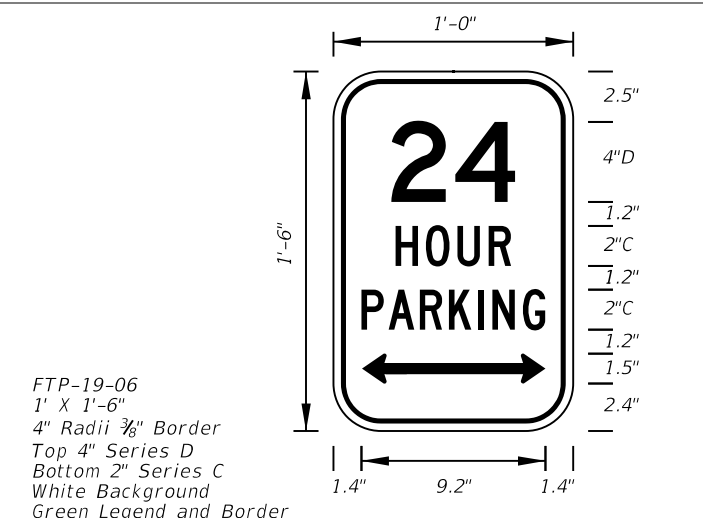

FTP-19-06  
1' X 1'-6"  
4" Radii 3/8" Border  
Top 4" Series D  
Bottom 2" Series C  
White Background  
Green Legend and Border

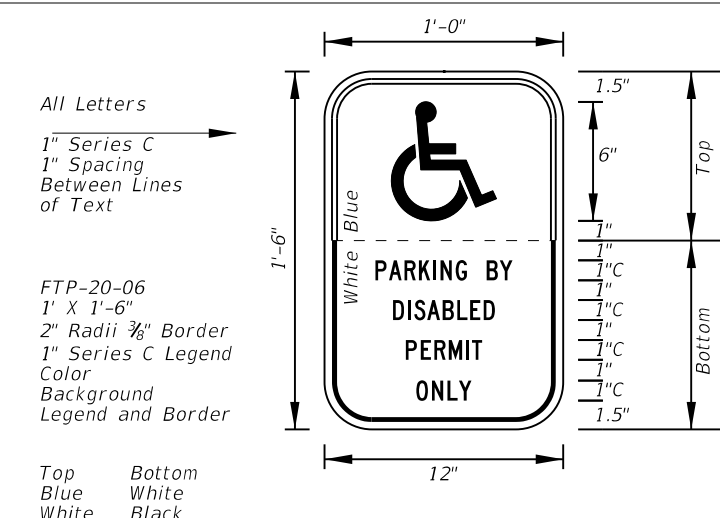

All Letters  
1" Series C  
1" Spacing  
Between Lines  
of Text

FTP-20-06  
1' X 1'-6"  
2" Radii 3/8" Border  
1" Series C Legend  
Color  
Background  
Legend and Border

Top Bottom  
Blue White  
White Black

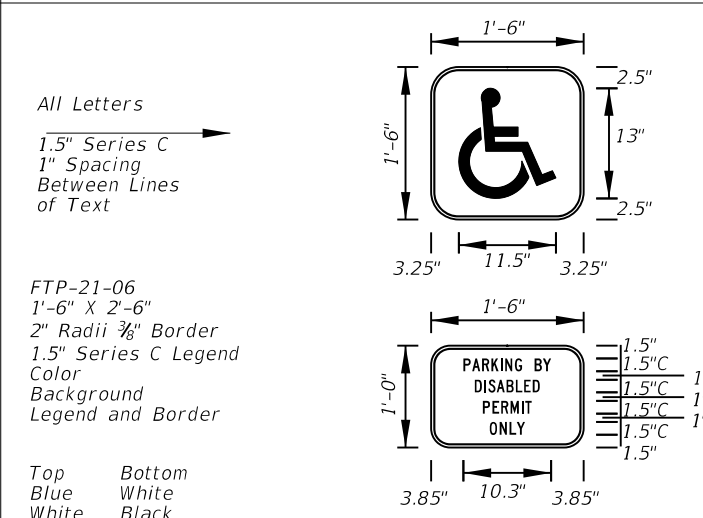

All Letters  
1.5" Series C  
1" Spacing  
Between Lines  
of Text

FTP-21-06  
1'-6" X 2'-6"  
2" Radii 3/8" Border  
1.5" Series C Legend  
Color  
Background  
Legend and Border

Top Bottom  
Blue White  
White Black

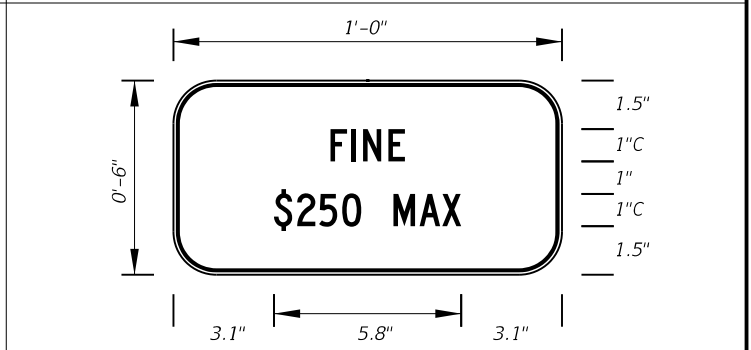

FTP-22-06  
1' X 6"  
1" Radii 3/8" Border  
1" Series C Legend  
White Background  
Black Legend and Border

Supplemental Panel  
for the FTP-20-06  
and FTP-21-06 signs

6/28/2012 12:16:46 PM r0960rh C:\projects\standards\roadway\17300-s\17355-02.dgn

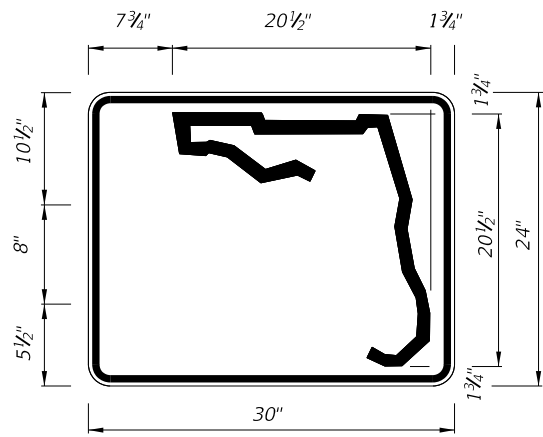

3 or 4 DIGITS

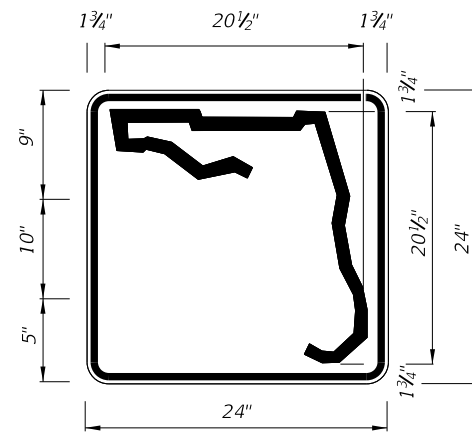

1 or 2 DIGITS

DIGITS	NUMERAL SIZE	SERIES	PANEL SIZE
1-2	10"	D	24" x 24"
3-4	8"	D	24" x 24"
3	8"	C	30" x 24"
4	8"	C	30" x 24"

Note:  
The 24" X 24" panel shall only be used for a 3 or 4 digit route when the panel is to be used on a sign cluster with other 24" X 24" panels.

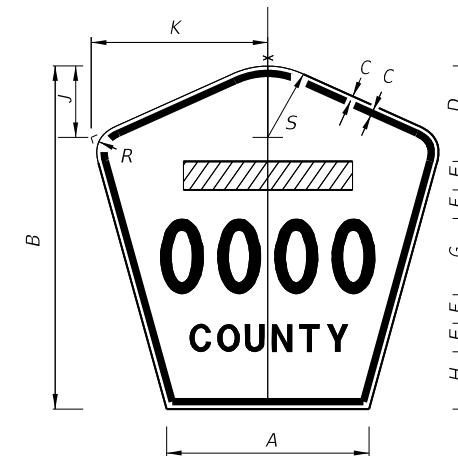

- Notes :
1. All Legend Series "D".
  2. Color: Yellow Legend and Border on Blue Background.
  3. When used on a guide sign, marker must be overlaid on a rectangular Yellow Background as shown in chart. \*\*

INDEPENDENT USE OTHER THAN FREEWAY

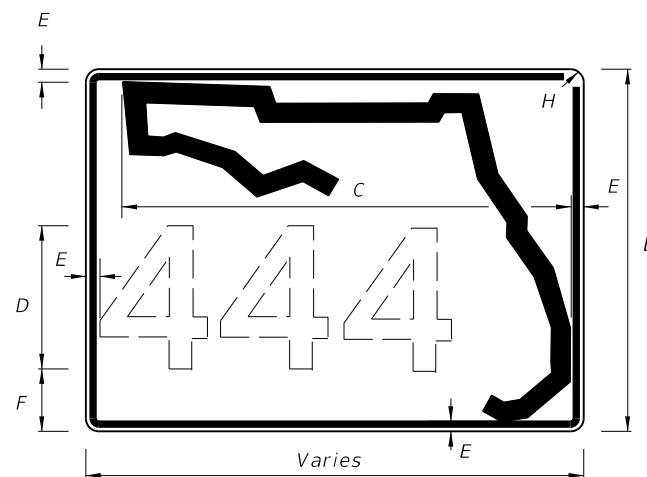

3 OR MORE DIGITS

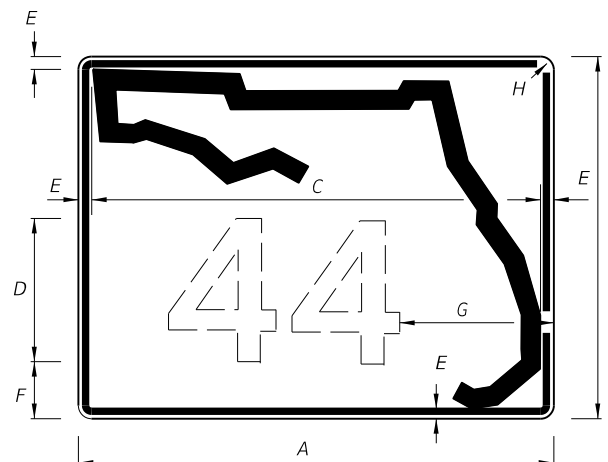

1 OR 2 DIGITS

SIGN	DIMENSIONS												**
	A	B	C	D	E	F	G	H	J	K	R	S	
4 DIGIT POST MOUNTED	25 1/8"	42"	3/4"	10"	4"	4"	8"	8"	8 3/8"	22"	5"	8 3/4"	
2 DIGIT OVERHEAD	21 1/2"	36"	1/2"	7 1/2"	3"	3"	12"	4 1/2"	7 1/8"	18 7/8"	4 1/4"	7 1/2"	42" x 42"
3 DIGIT OVERHEAD	25 1/8"	42"	3/4"	8"	4"	4"	12"	6"	8 3/8"	22"	5"	8 3/4"	48" x 48"
4 DIGIT OVERHEAD	29 7/8"	48"	3/4"	8"	5"	5"	12"	8"	9 3/4"	25 5/8"	5 3/4"	10 1/4"	52" x 52"

M1-6 COUNTY ROUTE MARKER DETAIL  
FTP-18-06

A	B	C	D	E	F	G	H
30"	24"	26"	12"	1 1/4"	2 3/4"	8 1/4"	1 1/4"
36"	30"	32"	15"	1 1/4"	3 1/4"	8 3/4"	1 1/4"
42"	36"	38"	15"	1 1/4"	6 1/4"	11"	1 1/4"

GUIDE SIGN USE

- Notes:
1. Florida marker shall have Black Legend with White Background.
  2. Stroke width of State outline to be 1" for independent use and 1 1/4" for Guide Sign.
  3. Numbers are series D.

FLORIDA ROUTE MARKER  
FTP-17-06

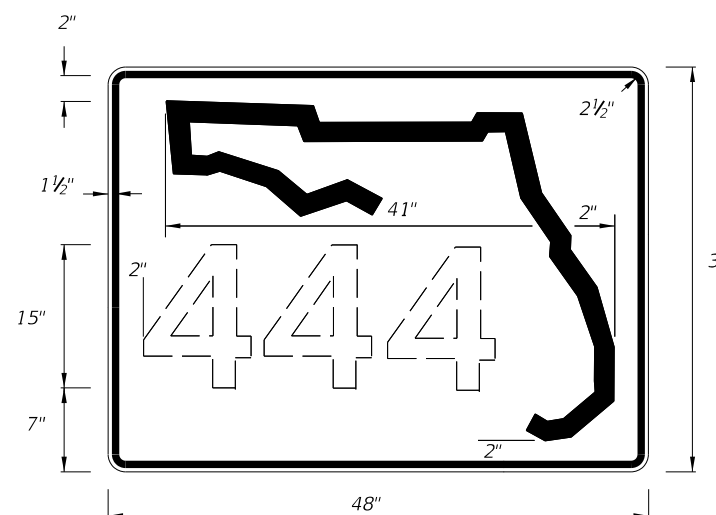

1-3 DIGITS 15" SERIES C  
4 DIGITS 12" SERIES C  
INDEPENDENT USE FOR FREEWAY

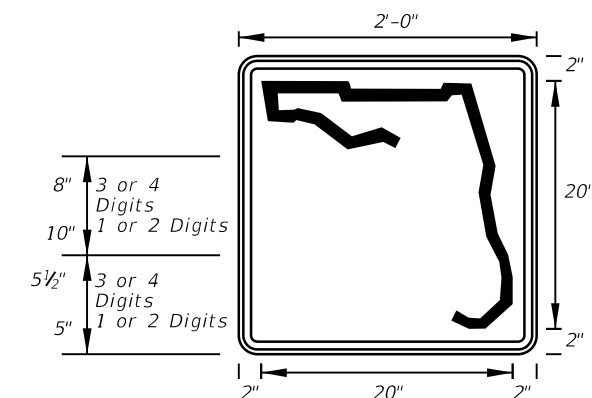

FTP-17-06  
2' X 2'  
1.13" Radii .0521" Border  
White Background  
Black Legend and Border

C:\projects\standards\roadway\17300-s\17355-03.dgn 6/28/2012 12:16:49 PM rd960rh

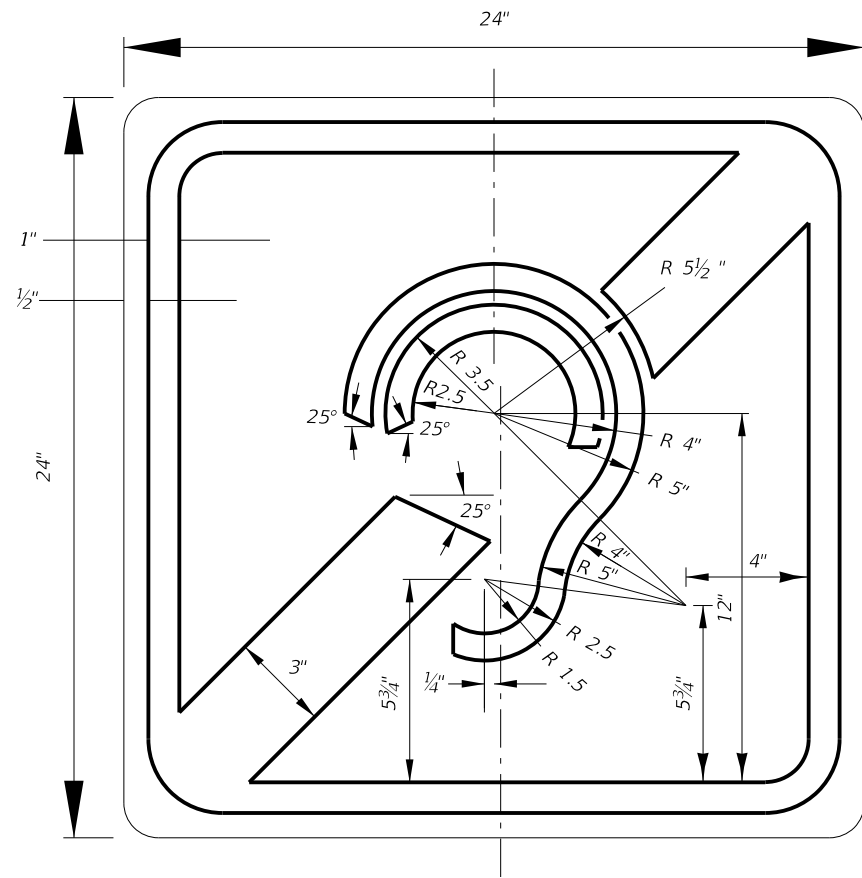

FTP-23-06  
2' X 2'  
1.5" Radii 5/8" Border  
Blue Background  
White Legend and Border

INTERNATIONAL SYMBOL OF  
ACCESS FOR HEARING LOSS

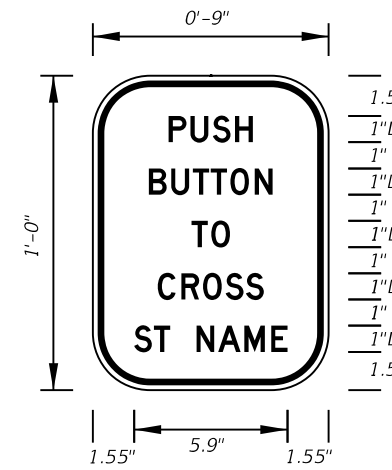

FTP-25-06  
9" X 1'-0"  
2" Radii 3/8" Border  
1" Series D Legend  
White Background  
Black Legend and Border

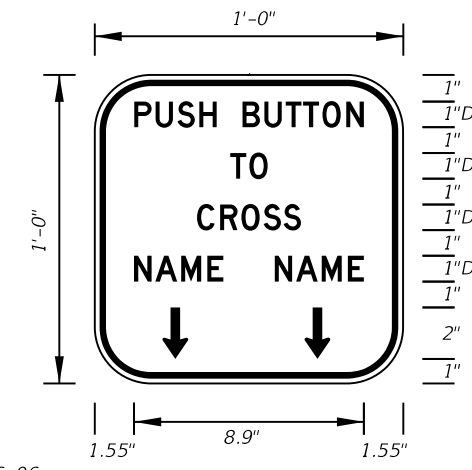

FTP-26-06  
1' X 1'  
2" Radii 3/8" Border  
1" Series D Legend  
White Background  
Black Legend and Border

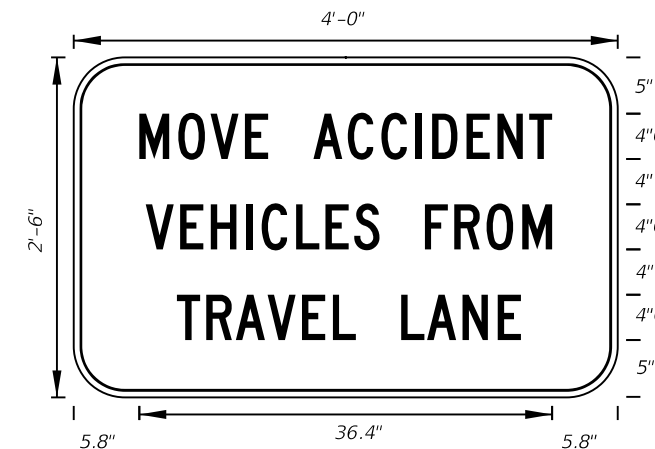

FTP-27-06  
4' X 2'-6"  
4" Radii 3/4" Border  
4" Series C Legend  
White Background  
Black Legend and Border

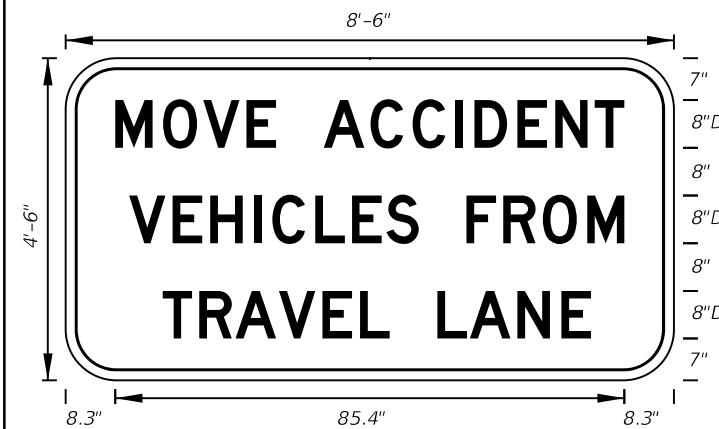

FTP-28-06  
8'-6" X 4'-6"  
7" Radii 3/4" Border  
8" Series D Legend  
White Background  
Black Legend and Border

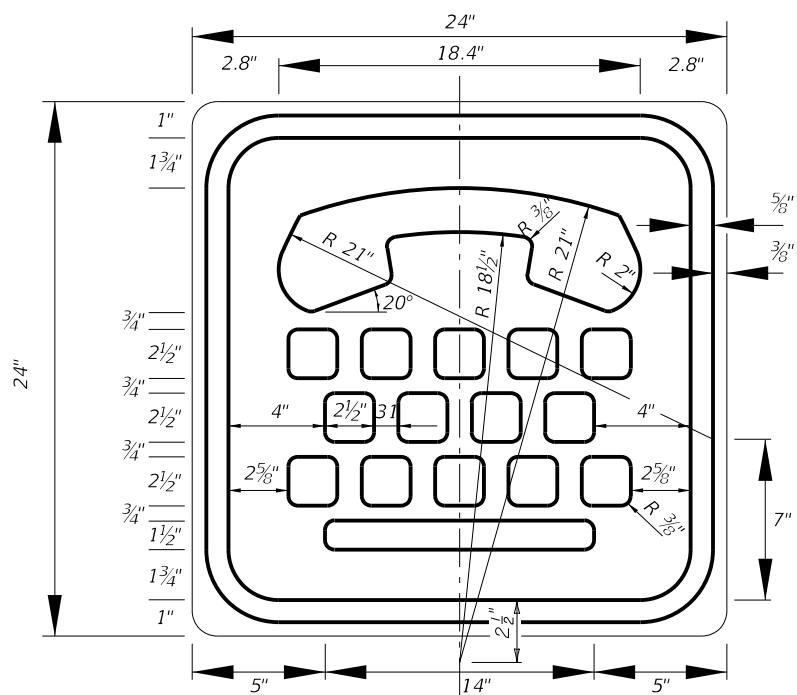

FTP-24-06  
2' X 2'  
1.5" Radii 5/8" Border  
Blue Background  
White Legend and Border

INTERNATIONAL TDD SYMBOL

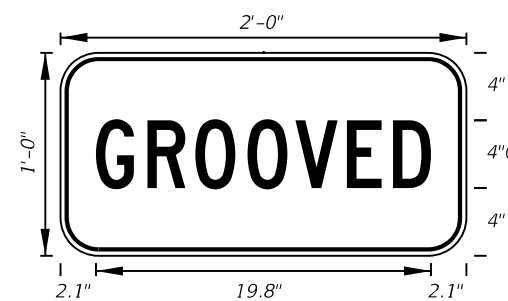

FTP-29-06  
2'-0" X 1'-0"  
2" Radii 5/8" Border  
4" Series C Legend  
Yellow Background  
Black Legend and Border

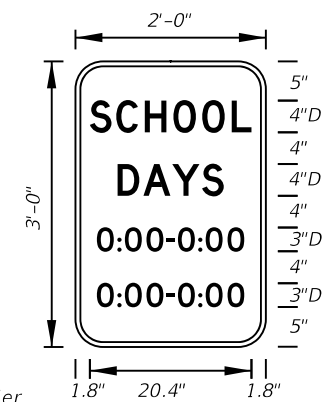

FTP-30-06  
2'-0" X 3'-0"  
3" Radii 5/8" Border  
White Background  
Black Legend and Border  
Top 4" Series D Legend  
Bottom 3" Series C Legend

6/29/2012 12:16:51 PM rd960rhc C:\projects\standards\roadway\17300-s\17355-04.dgn

LAST REVISION	DESCRIPTION:	 <b>FDOT DESIGN STANDARDS</b> 2013	<b>SPECIAL SIGN DETAILS</b>		INDEX NO.	SHEET NO.
01/01/12	REVISION				17355	4

6/28/2012 12:16:53 PM r0960rjh C:\projects\standards\roadway\17300-s\17355-05.dgn

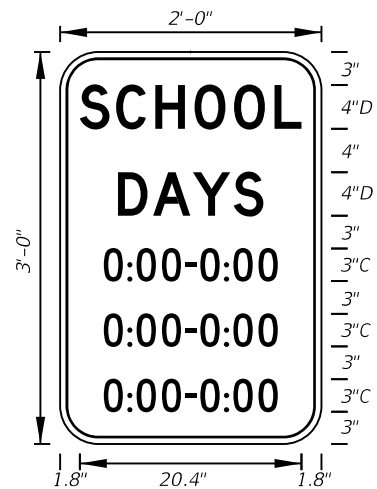

FTP-30A-06  
2' X 3'  
3" Radii 5/8" Border  
Top 4" Series D Legend  
Bottom 3" Series C Legend  
White Background  
Black Legend and Border

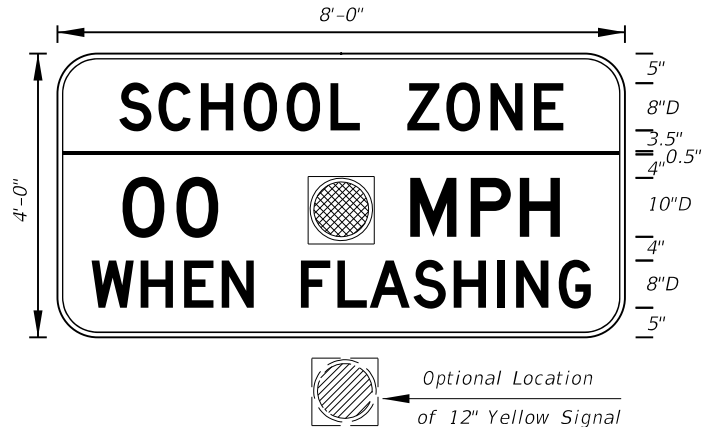

FTP-31-06  
8' X 4'  
6" Radii 3/4" Border  
Series D Legend  
Yellow Background Top  
White Background Bottom  
Black Legend and Border

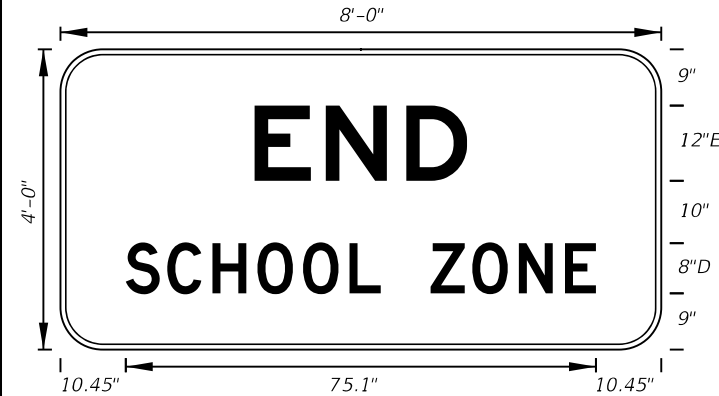

FTP-32-06  
8' X 4'  
6" Radii 3/4" Border  
12" Series E and 8" Series D Legend  
White Background  
Black Legend and Border

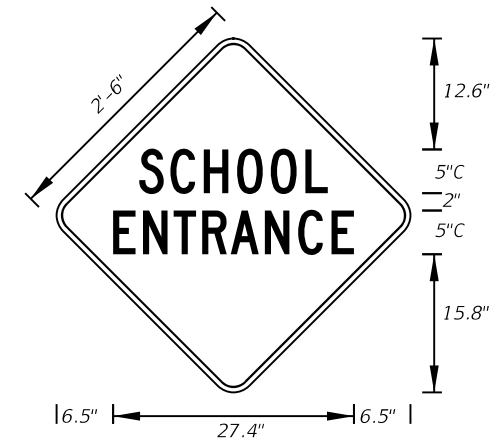

FTP-33-06  
2'-6" X 2'-6"  
2" Radii 3/4" Border  
5" Series C Legend  
Yellow Background  
Black Legend and Border

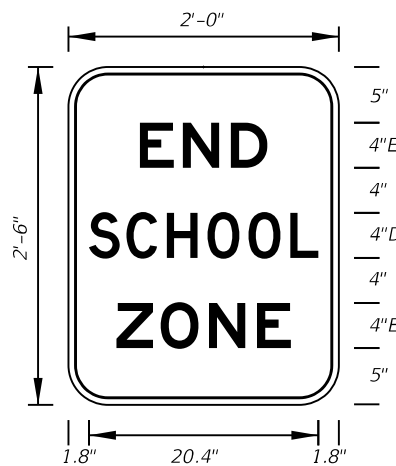

FTP-34-06  
2' X 2'-6"  
3" Radii 5/8" Border  
4" Series D and E Legend  
White Background  
Black Legend and Border

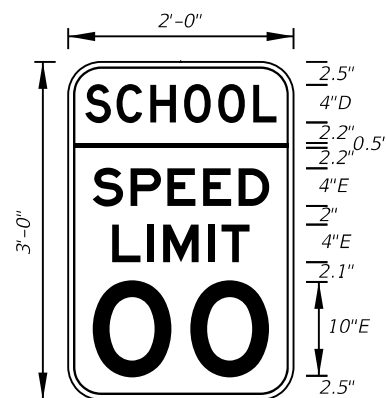

FTP-35-06  
2' X 3'  
3" Radii 5/8" Border  
Top 4" Series D Legend  
Bottom 4" and 10" Series E Legend  
Yellow Background Top White Background Bottom  
Black Legend and Border

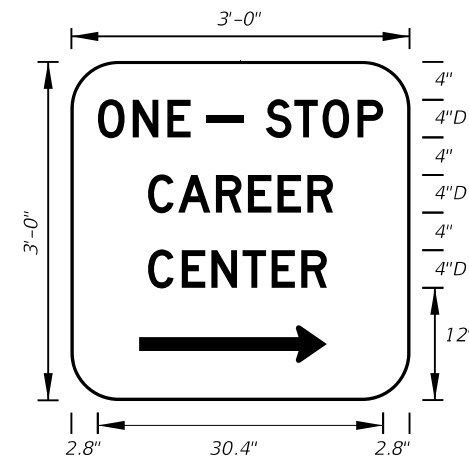

FTP-36-06  
3' X 3'  
5" Radii  
4" Series D Legend  
Green Background  
White Legend and Border

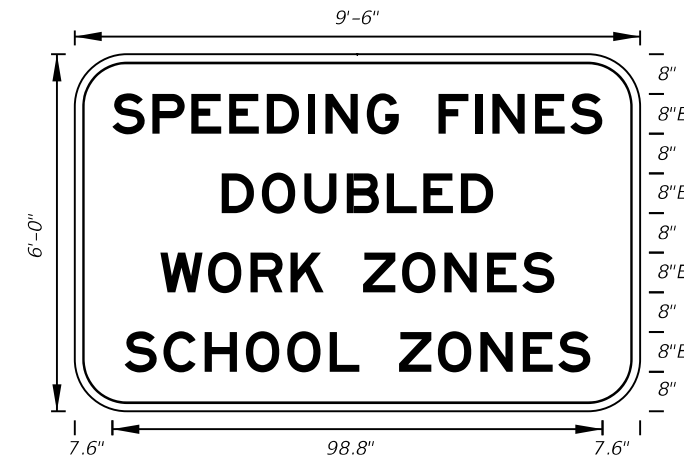

FTP-37-06  
9'-6" X 6'  
9" Radii 2" Border  
8" Series E Legend  
White Background  
Black Legend and Border  
State Line Sign

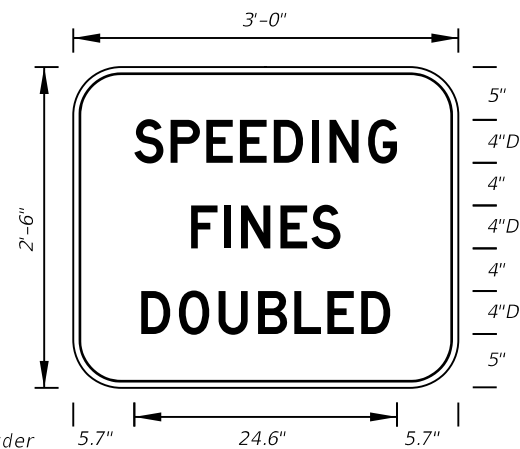

FTP-38-06  
3' X 2'-6"  
4" Radii 3/4" Border  
4" Series D Legend  
White Background  
Black Legend and Border  
Arterial Sign

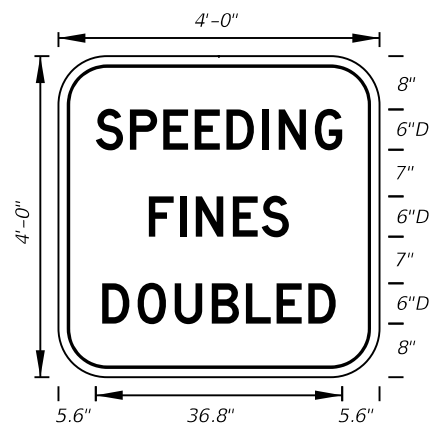

FTP-39-06  
4' X 4'  
6" Radii 3/4" Border  
6" Series D Legend  
White Background  
Black Legend and Border  
Freeway Sign



FTP-40-06  
3'-6" X 4'  
6" Radii 3/4" Border  
3" and 6" Series C Legend  
White Background  
Black Legend and Border



FTP-41-06  
2'-6" X 3'  
4" Radii 3/4" Border  
2" and 4" Series C Legend  
White Background  
Black Legend and Border

LAST REVISION	DESCRIPTION:
01/01/12	



FDOT DESIGN STANDARDS  
2013

SPECIAL SIGN DETAILS

INDEX NO.	SHEET NO.
17355	5



FTP-42-06  
4' X 2'-6"  
3" Radii  
Top 4" Series C Legend  
Bottom 2" Series EM Legend  
White Background  
Blue Legend and Border

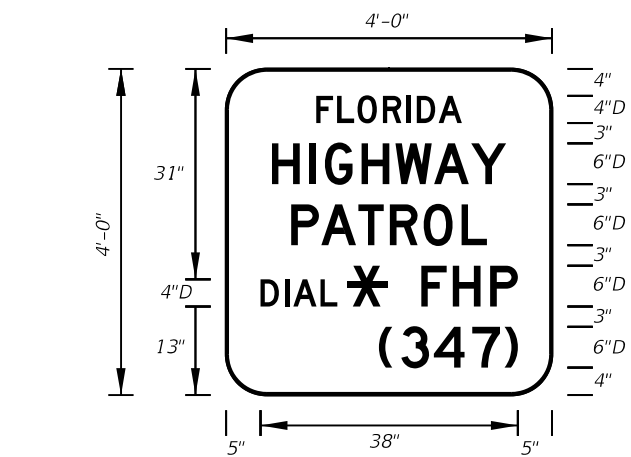

FTP-43-06  
4' X 4'  
6" Radii 1" Border  
Top 4" Series D Legend  
Bottom 6" Series D Legend  
Blue Background  
White Legend and Border



FTP-44-06  
9' X 6'  
9" Radii 3/4" Border  
8" Series D Legend  
White Background  
Black Legend and Border



FTP-45-06  
4' X 3'  
5" Radii 3/4" Border  
4" Series C Legend  
White Background  
Black Legend and Border

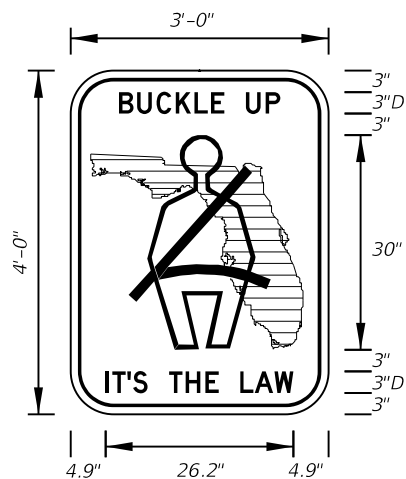

FTP-46-06  
3' X 4'  
5" Radii 3/4" Border  
3" Series D Legend  
White Background Florida Shield Green  
Black Legend, Border and Man Belt Symbol

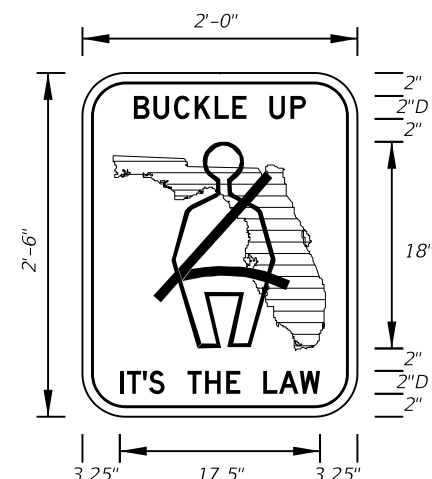

FTP-47-06  
2' X 2'-6"  
3" Radii 3/8" Border  
2" Series D Legend  
White Background Florida Shield Green  
Black Legend, Border and Man Belt Symbol

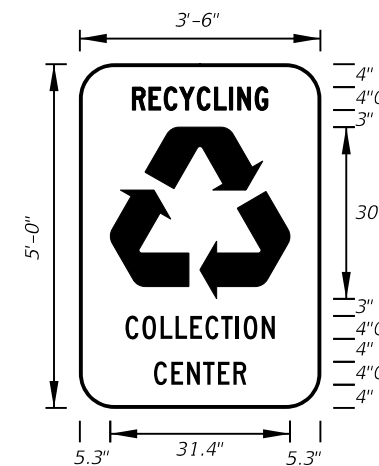

FTP-48-06  
3'-6" X 5'  
6" Radii  
4" Series C Legend  
Green Background  
White Legend, Border and Symbol

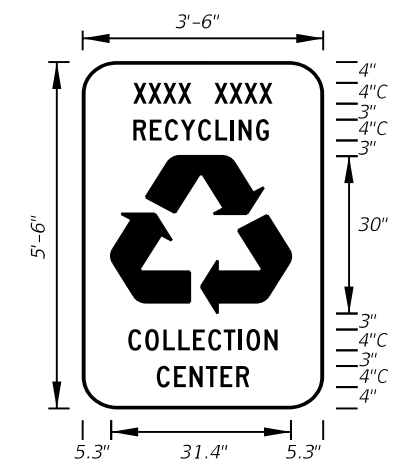

FTP-49-06  
3'-6" X 5'-6"  
6" Radii  
4" Series C Legend  
Green Background Municipality Name Optional  
White Legend, Border and Symbol

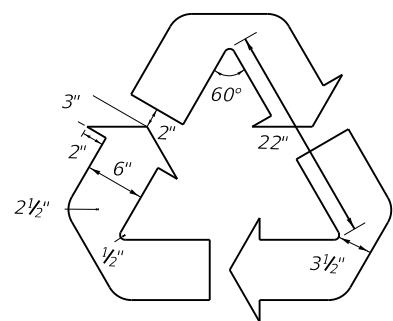

Detail for FTP-48-06 and FTP-49-06

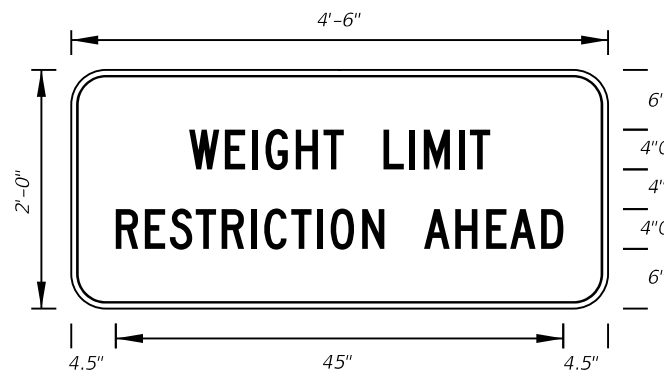

FTP-50-06  
4'-6" X 2'  
3" Radii 3/4" Border  
4" Series C Legend  
Yellow Background  
Black Legend and Border

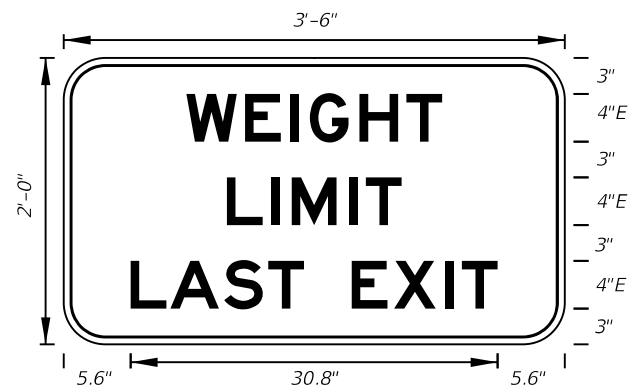

FTP-51-06  
3' X 2'  
3" Radii 3/4" Border  
4" Series E Legend  
White Background  
Black Legend and Border

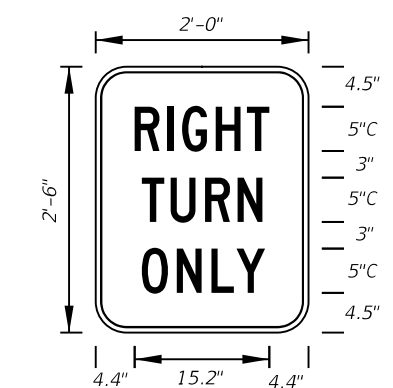

FTP-52-06  
2' X 2'-6"  
3" Radii 3/8" Border  
5" Series C Legend  
White Background  
Black Legend and Border

6/28/2012 12:16:55 PM rd960rjh C:\projects\standards\roadway\17300-s\17355-06.dgn

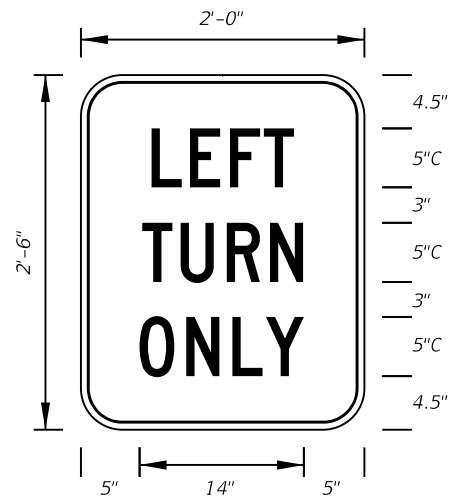

FTP-53-06  
2' X 2'-6"  
3" Radii 5/8" Border  
5" Series C Legend  
White Background  
Black Legend and Border

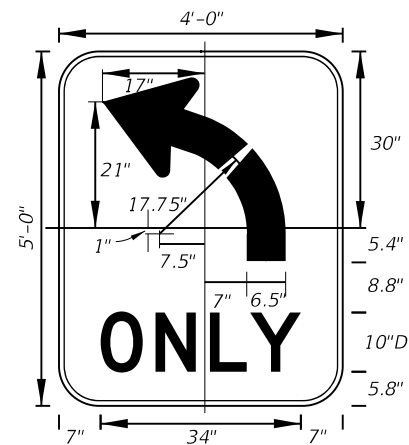

FTP-54L-06  
4' X 5'  
6" Radii 3/4" Border  
10" Series D Legend  
White Background  
Black Legend and Border

FTP-54R-06 for  
(Right Turn Arrow)

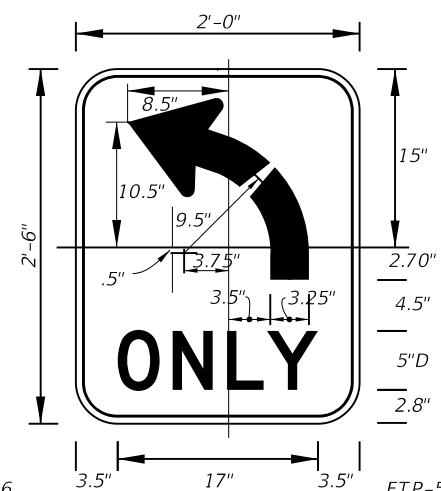

FTP-55L-06  
2' X 2'-6"  
3" Radii 5/8" Border  
5" Series D Legend  
White Background  
Black Legend and Border

FTP-55R-06 for  
(Right Turn Arrow)

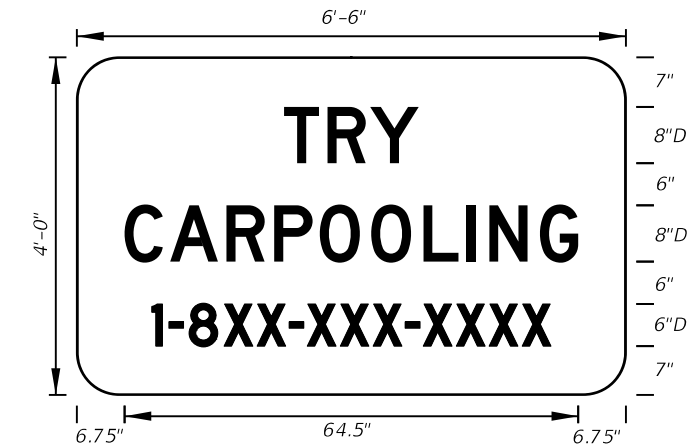

FTP-56-06  
6'-6" X 4'  
6" Radii 3/4" Border  
8" and 6" Series D Legend  
Blue Background  
White Legend and Border

Design Project Manager  
or Transit Administrator  
will supply correct 1-8XX  
number.

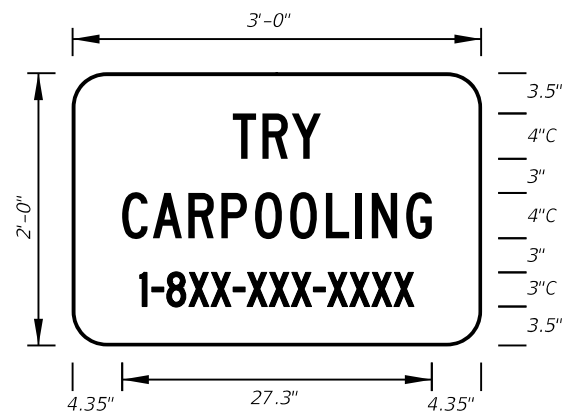

FTP-56A-06  
3' X 2'  
3" Radii  
4" and 3" Series C Legend  
Blue Background  
White Legend and Border

Design Project Manager  
or Transit Administrator  
will supply correct 1-8XX  
number.

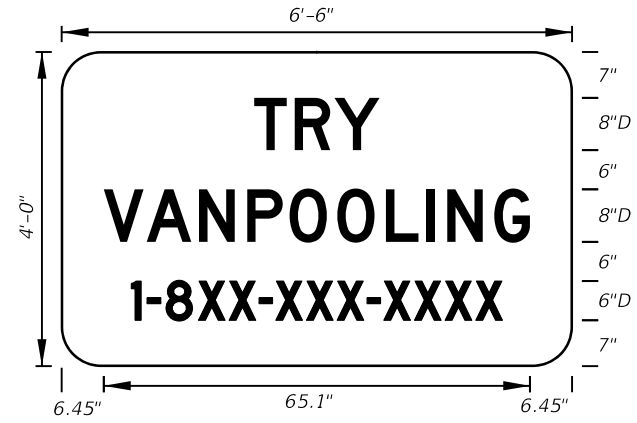

FTP-57-06  
6'-6" X 4'  
6" Radii  
8" and 6" Series D Legend  
Blue Background  
White Legend and Border

Design Project Manager  
or Transit Administrator  
will supply correct 1-8XX  
number.

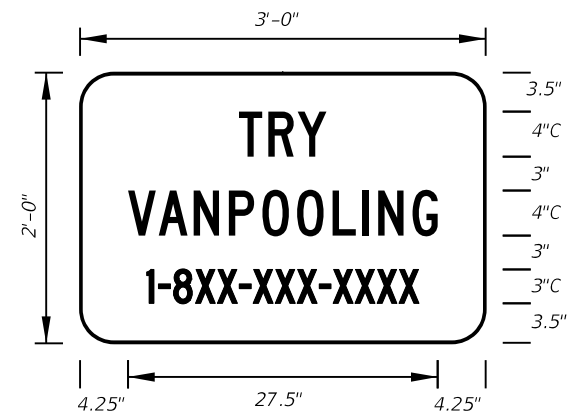

FTP-58-06  
3' X 2'  
3" Radii  
4" and 3" Series C Legend  
Blue Background  
White Legend and Border

Design Project Manager  
or Transit Administrator  
will supply correct 1-8XX  
number.

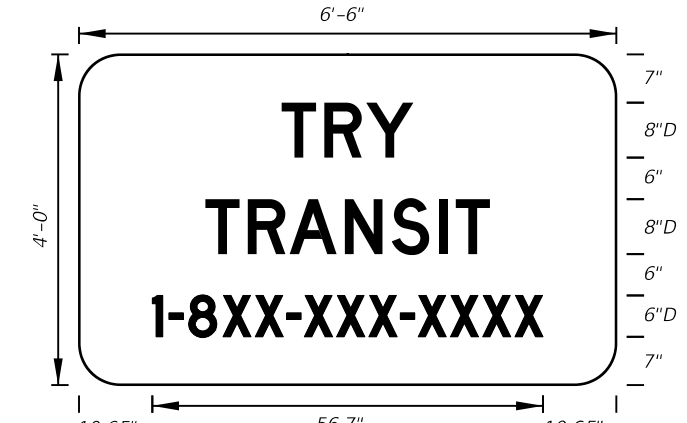

FTP-59-06  
6'-6" X 4'  
6" Radii  
8" and 6" Series D Legend  
Blue Background  
White Legend and Border

Design Project Manager  
or Transit Administrator  
will supply correct 1-8XX  
number.

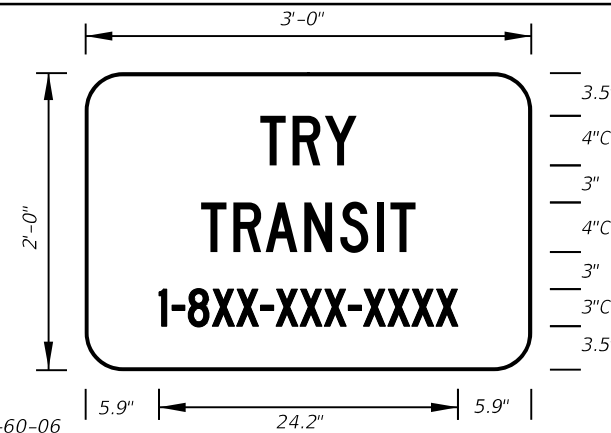

FTP-60-06  
3' X 2'  
3" Radii  
4" and 3" Series C Legend  
Blue Background  
White Legend and Border

Design Project Manager  
or Transit Administrator  
will supply correct 1-8XX  
number.

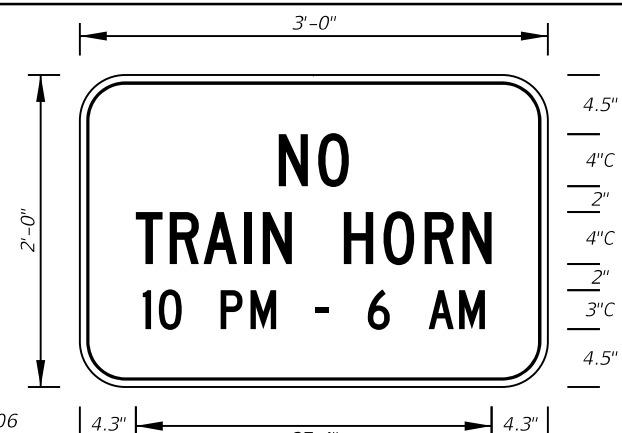

FTP-61-06  
3' X 2'  
3" Radii 3/4" Border  
4" and 3" Series C Legend  
Yellow Background  
Black Legend and Border

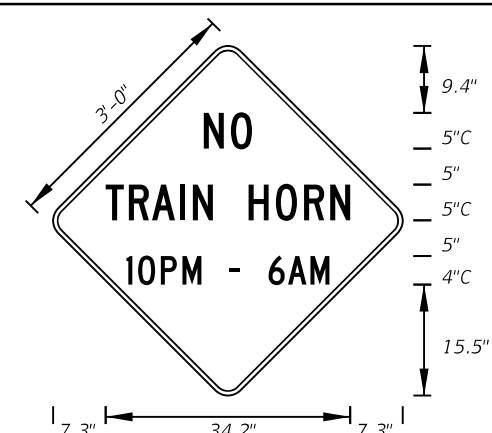

FTP-62-06  
3' X 3'  
2" Radii 3/4" Border 4" and 5" Series C Legend  
Yellow Background Black Legend and Border

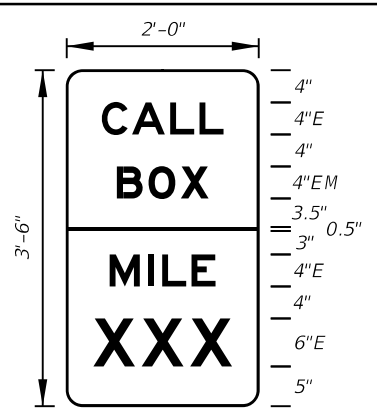

FTP-63-06  
2' X 3'-6"  
2" Radii 4" and 6" Series E and EM Legend  
Top Blue Background White Legend and Border  
Bottom Green Background White Legend and Border

C:\projects\standards\roadway\17300-s\17355-07.dgn  
12:16:57 PM  
r0960rh  
6/29/2012

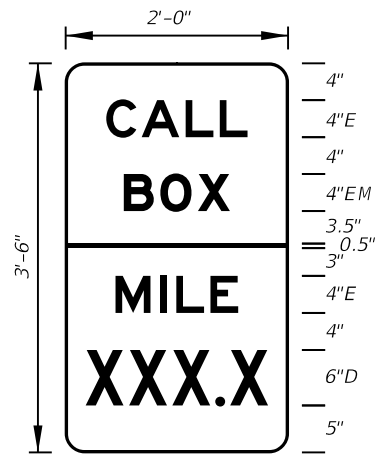

FTP-64-06  
2' X 3'-6"  
2" Radii  
Top 4" Series E and 4" Series EM Legend  
Blue Background White Legend and Border  
Bottom 4" Series E and 6" Series D Legend  
Green Background White Legend and Border

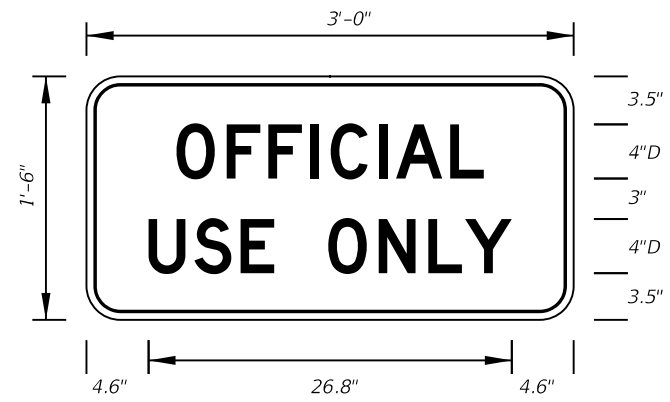

FTP-65-06  
3' X 1'-6"  
2" Radii 3/4" Border  
4" Series D Legend  
White Background  
Black Legend and Border



FTP-66-06  
4' X 5'  
2" Radii 3/4" Border  
7" Series D Legend  
Blue Background  
White Legend and Border



FTP-67-06  
3' X 4'  
2" Radii 3/4" Border  
5" Series D Legend  
Blue Background  
White Legend and Border



DETAIL for FTP-66 AND FTP-67

Sign Mounting Holes Can Be Punched Or Field Drilled With No Obstruction To Text Or Symbols From Holes Or Bolts.

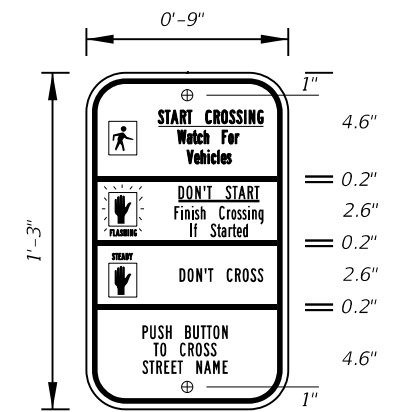

FTP-68A-06  
9" X 1'-3"  
1.5" Radii 3/4" Border  
Series B Legend  
White Background  
Black Legend and Border

See Standard Highway Signs Manual, Sign R10-3b For Letter Size Spacing And Symbol Sizes.

Sign Mounting Holes Can Be Punched Or Field Drilled With No Obstruction To Text Or Symbols From Holes Or Bolts.

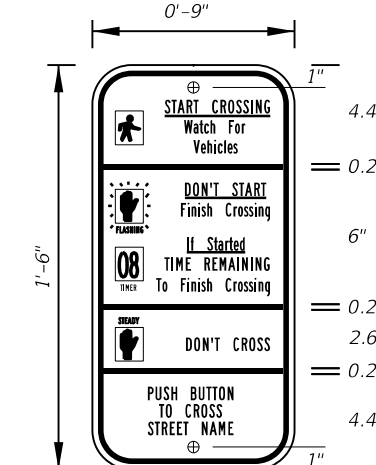

FTP-68B-06  
9" X 1'-6"  
1.5" Radii 3/4" Border  
Series B Legend  
White Background  
Black Legend and Border

See Standard Highway Signs Manual, Sign R10-3b For Letter Size Spacing And Symbol Sizes.

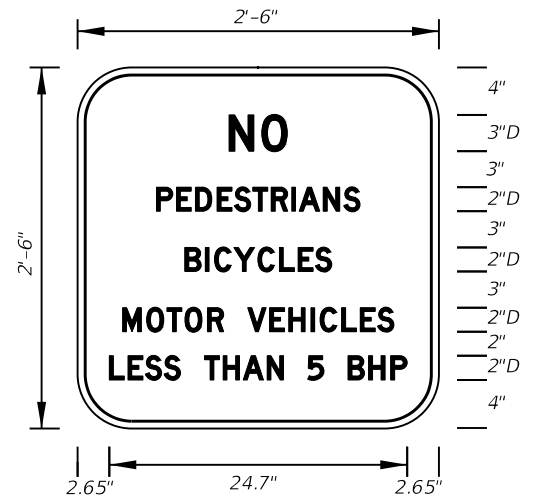

FTP-69-06  
2'-6" X 2'-6"  
4" Radii 3/4" Border  
2" and 3" Series D Legend  
White Background  
Black Legend and Border

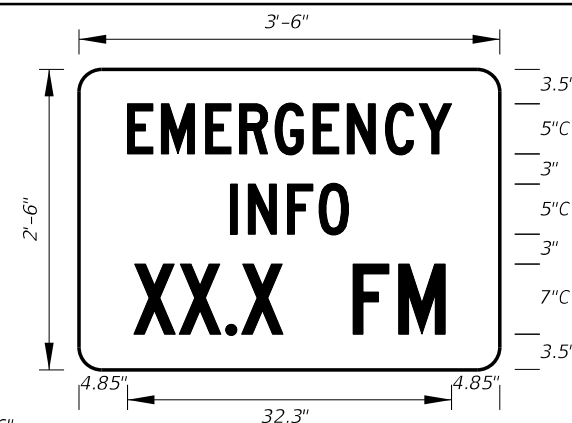

FTP-70-06  
3'-6" X 2'-6"  
2.25" Radii 3/4" Border  
5" Series C and 7" Series C Legend  
Blue Background  
White Legend and Border

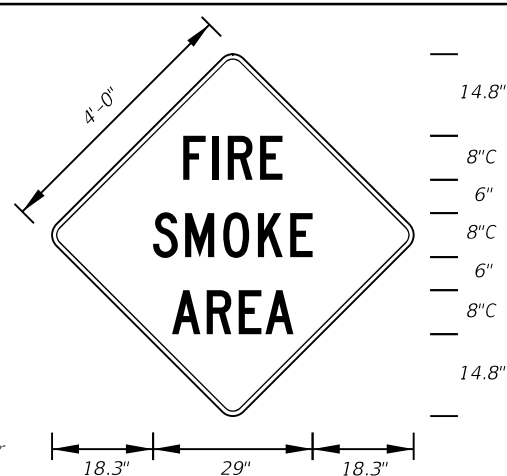

FTP-71-06  
4' X 4'  
2" Radii 3/4" Border  
8" Series C Legend  
Yellow Background  
Black Legend and Border



FTP-72-06  
3' X 3'  
2" Radii 3/4" Border

6" Series C Legend  
Yellow Background  
Black Legend and Border

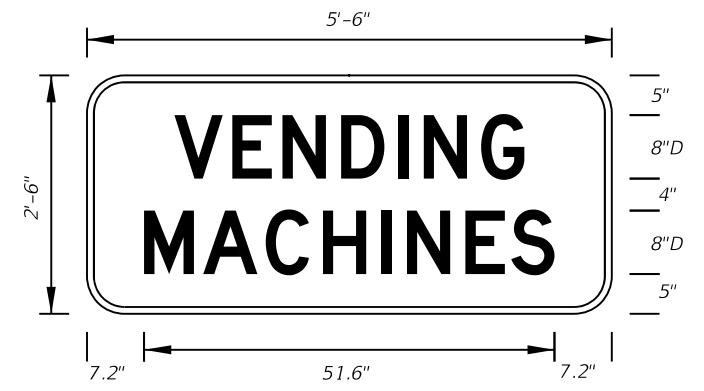

FTP-73-06  
5'-6" X 2'-6"  
4" Radii 3/4" Border

8" Series D Legend  
Blue Background  
White Legend and Border

6/28/2012 12:17:00 PM r0960/h C:\projects\standards\roadway\17300-s\17355-08.dgn





FTP-74-06  
5'-6" X 2'-6"  
4" Radii 3/4" Border  
6" Series D Legend  
Blue Background  
White Legend and Border

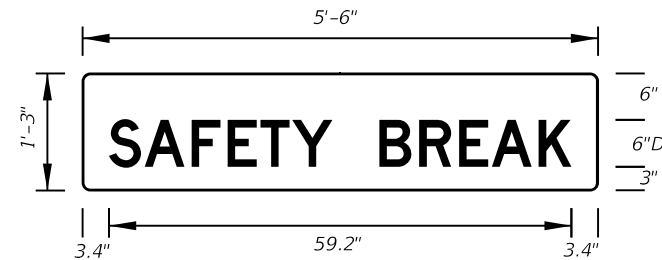

FTP-75-06  
5'-6" X 1'-3"  
1" Radii  
6" Series D Legend  
Blue Background  
White Legend

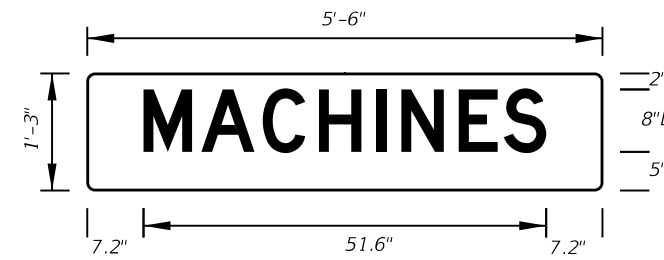

FTP-76-06  
5'-6" X 1'-3"  
1" Radii  
8" Series D Legend  
Blue Background  
White Legend

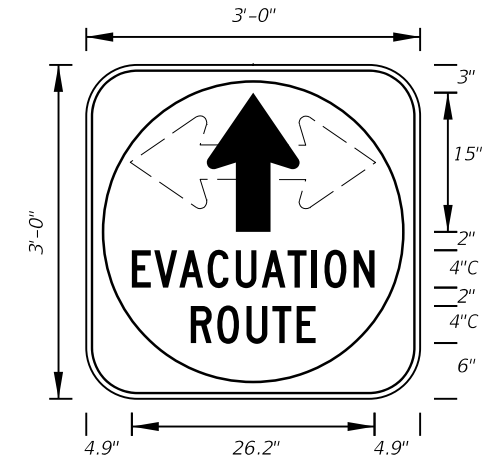

FTP-77-06  
3' X 3'  
5" Radii 3/4" Border  
4" Series C Legend  
White Background with Blue Circle Background  
White Legend and Black Border

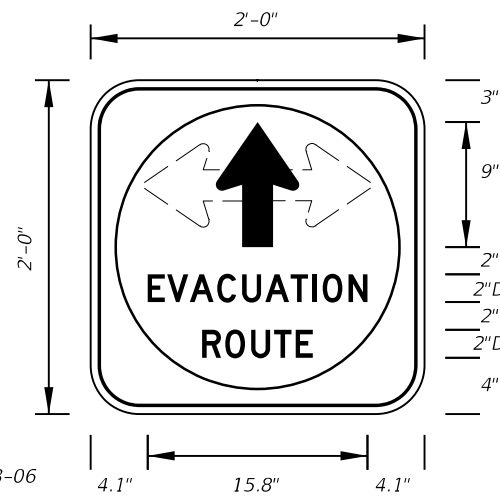

FTP-78-06  
2' X 2'  
3" Radii 3/4" Border  
2" Series D Legend  
White Background with Blue Circle Background  
White Legend and Black Border

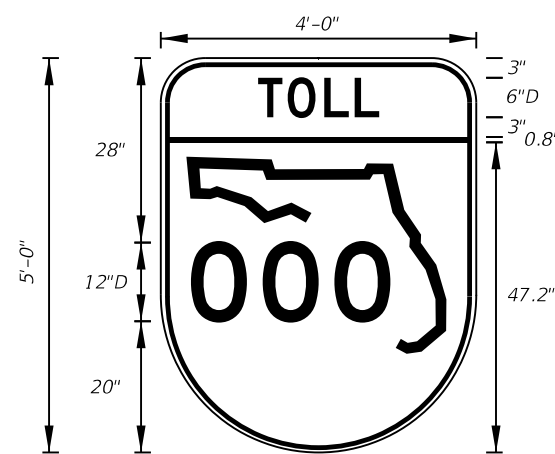

FTP-79-06  
4' X 5'  
6" Radii 3/4" Border  
6" and 12" Series D Legend  
Top Yellow Background with White Legend and Black Border  
Bottom White Background with Black Legend and Border

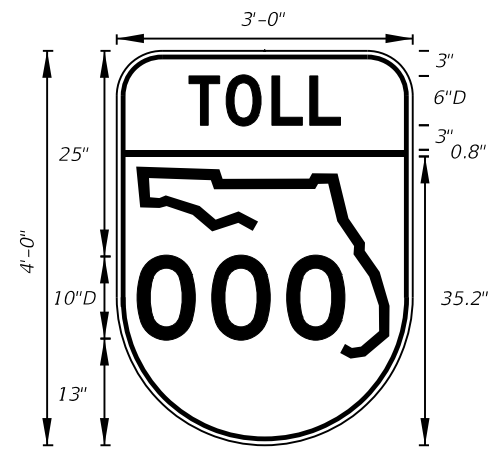

FTP-80-06  
3' X 4'  
5" Radii 3/4" Border  
6" and 10" Series D Legend  
Top Yellow Background with White Legend and Black Border  
Bottom White Background with Black Legend and Border

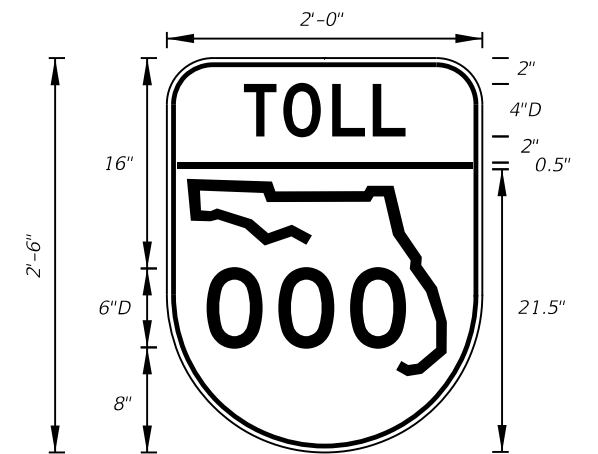

FTP-81-06  
2' X 2'-6"  
3" Radii 3/4" Border  
4" and 6" Series D Legend  
Top Yellow Background with White Legend and Black Border  
Bottom White Background with Black Legend and Border

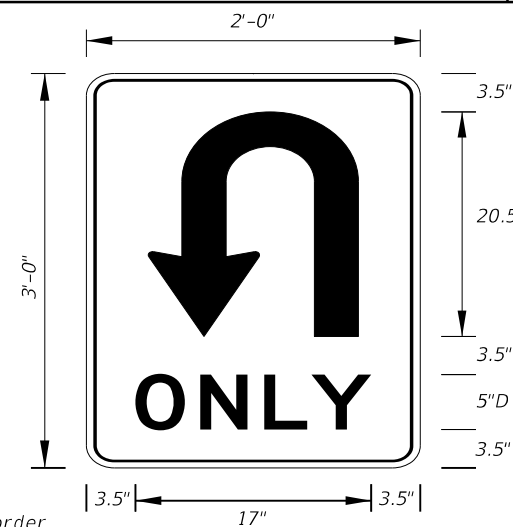

FTP-82-08  
2' X 3'  
1.5" Radii  
5" Series D Legend  
White Background  
Black Legend and Border

ARROW HEAD

A	3.125
B	3.625
C	6.375
D	.5
E	.625

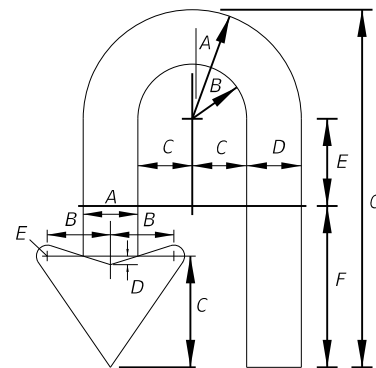

ARROW BODY

A	B	C	D	E	F	G
6.25	3.125	3.125	3.125	5	9.25	20.5

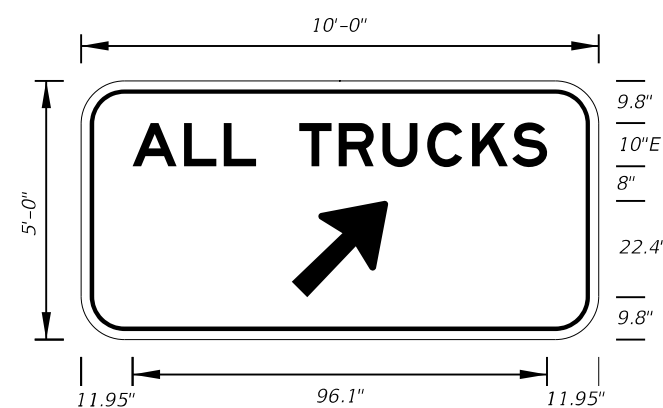

FTP-83-08  
10'-0" X 5'-0"  
8" Radii  
10" Series E Legend  
Green Background  
White Legend

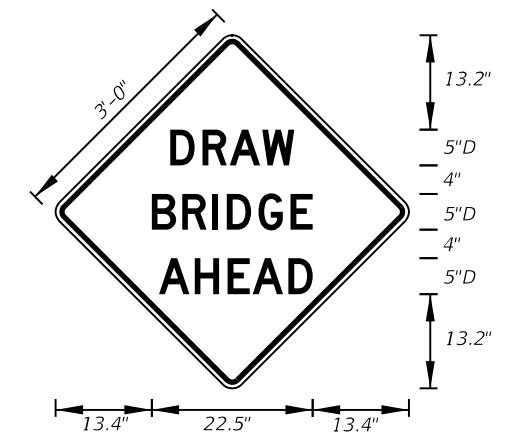

FTP-84-09  
3' X 3'  
1.5" Radii  
5" Series D Legend  
Yellow Background  
Black Legend

6/28/2012 12:17:02 PM rd960rh C:\projects\standards\roadway\17300-s\17355-09.dgn

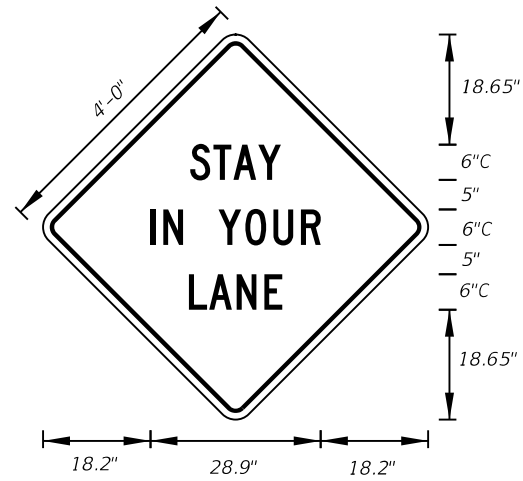

M0T-1-06  
4' X 4'  
2" Radii 3/4" Border  
6" Series C Legend  
Orange Background  
Black Legend and Border

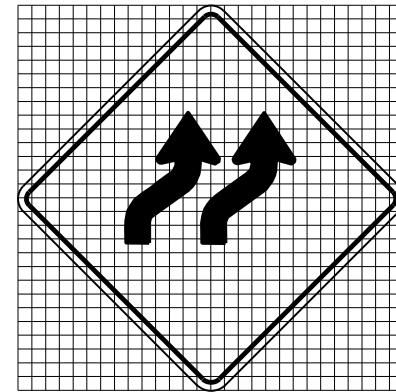

M0T-2-06  
4' X 4'  
2" Radii 3/4" Border  
Orange Background  
Black Arrows and Border

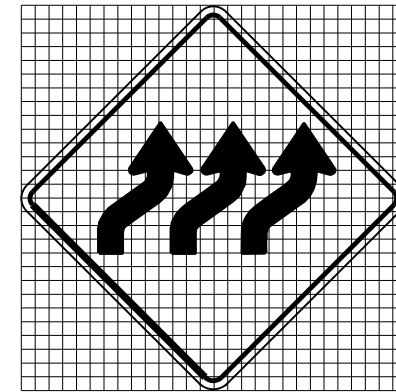

M0T-3-06  
4' X 4'  
2" Radii 3/4" Border  
Orange Background  
Black Arrows and Border

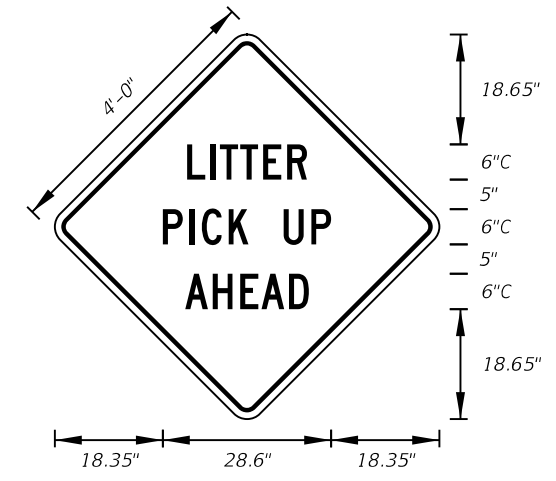

M0T-4-06  
4' X 4'  
2" Radii 3/4" Border  
6" Series C Legend  
Orange Background  
Black Legend and Border

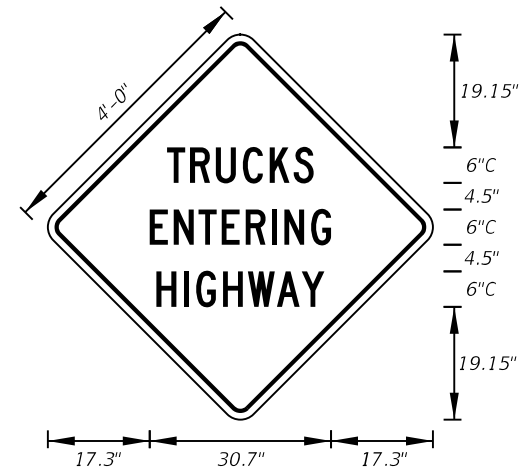

M0T-5-06  
4' X 4'  
2" Radii 3/4" Border  
6" Series C Legend  
Orange Background  
Black Legend and Border

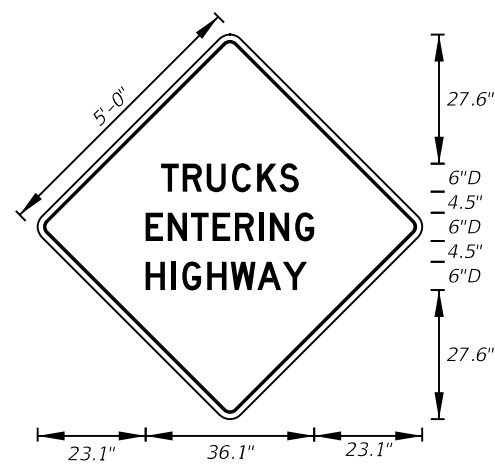

M0T-6-06  
5' X 5'  
2" Radii 3/4" Border  
6" Series D Legend  
Orange Background  
Black Legend and Border

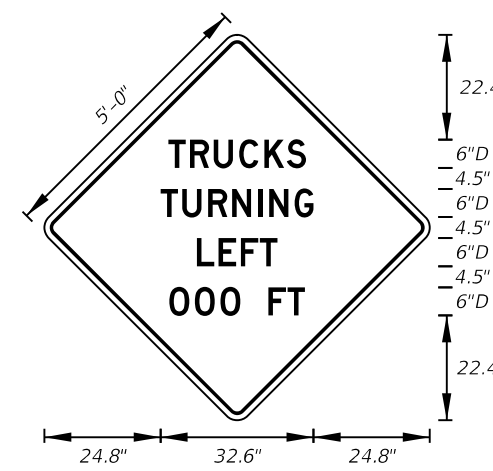

M0T-7-06  
5' X 5'  
2" Radii 3/4" Border  
6" Series D Legend  
Orange Background  
Black Legend and Border

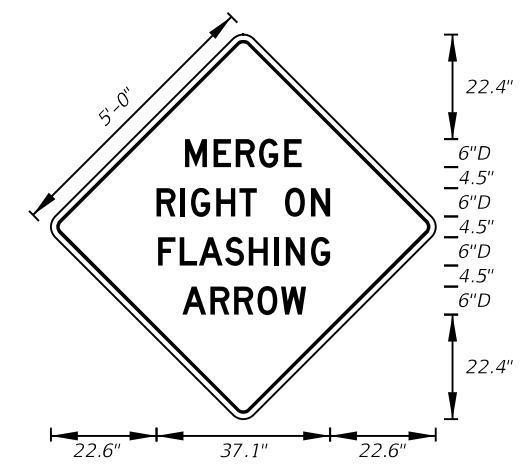

M0T-8-06  
5' X 5'  
2" Radii 3/4" Border  
6" Series D Legend  
Orange Background  
Black Legend and Border

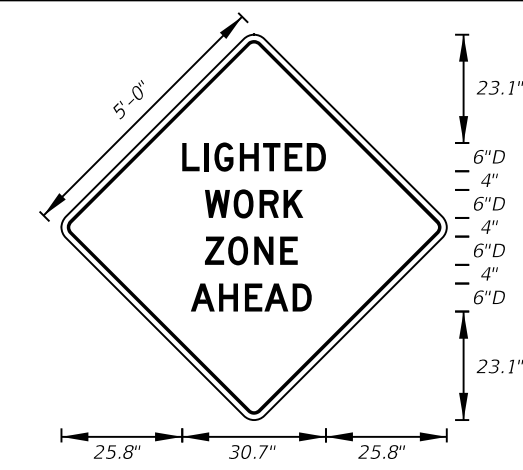

M0T-9-06  
5' X 5'  
2" Radii 3/4" Border  
6" Series D Legend  
Orange Background  
Black Legend and Border

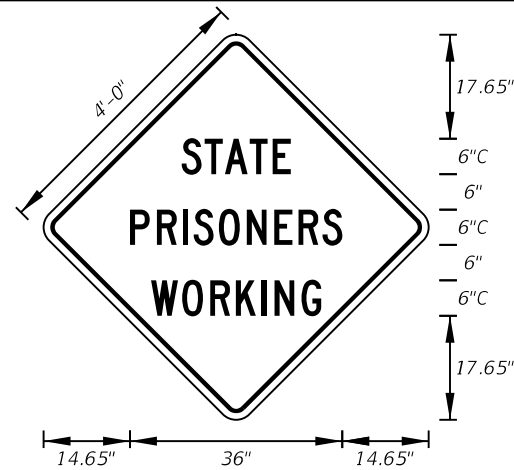

M0T-10-06  
4' X 4'  
2" Radii 3/4" Border  
6" Series C Legend  
Orange Background  
Black Legend and Border

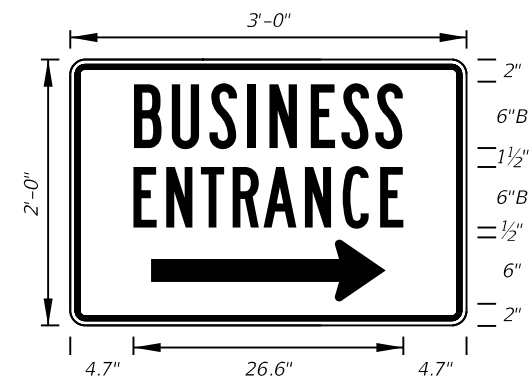

M0T-11-06  
3' X 2'  
2" Radii 3/4" Border  
6" Series B Legend  
Blue Background  
White Legend and Border

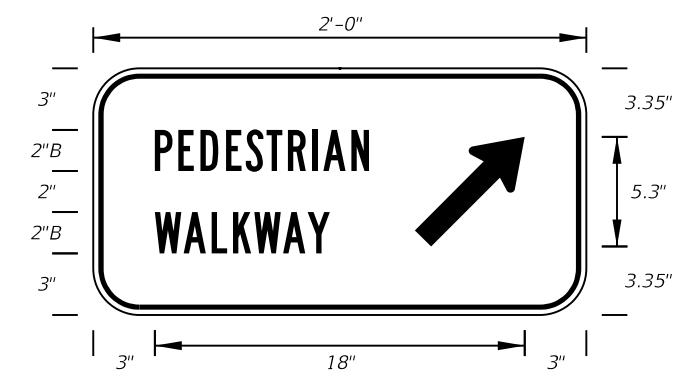

M0T-12-06  
2' X 1'  
2" Radii 3/4" Border  
2" Series B Legend  
White Background  
Black Legend and Border

6/28/2012 12:17:04 PM r0960/h C:\projects\standards\roadway\17300-s\17355-10.dgn

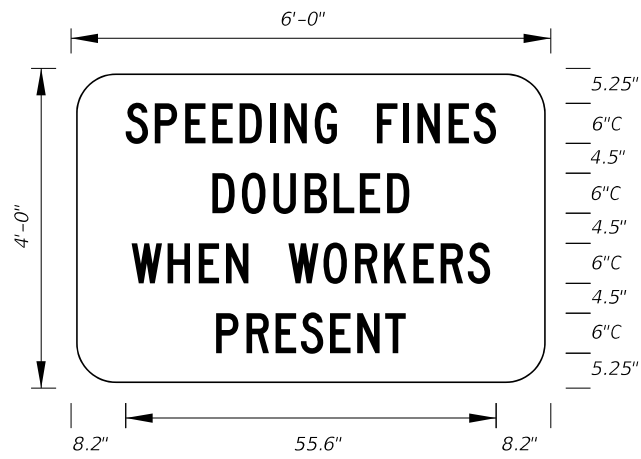

M0T-13-06 Freeway Sign  
6' X 4'  
6" Radii 3/4" Border

6" Series C Legend  
White Background  
Black Legend and Border

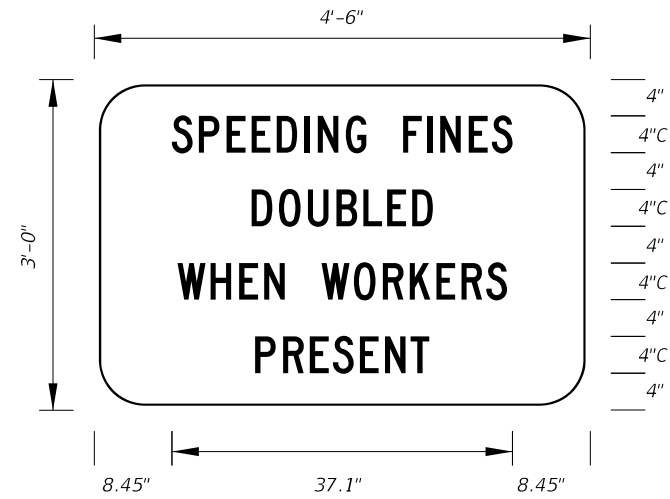

M0T-14-06 Arterial Sign  
4'-6" X 3'  
5" Radii 3/4" Border

4" Series C Legend  
White Background  
Black Legend and Border

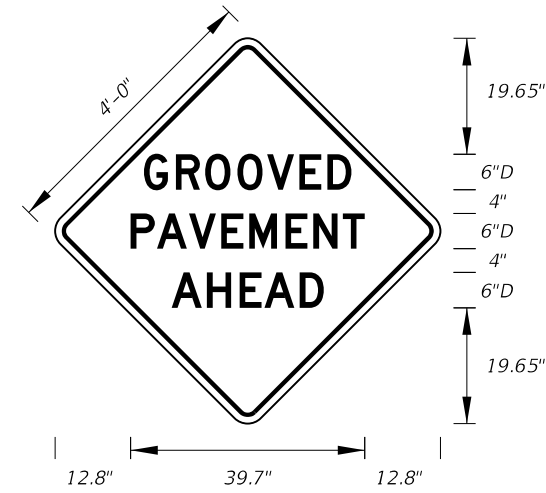

M0T-15-06  
4' X 4'  
2" Radii 3/4" Border

6" Series D Legend  
Orange Background  
Black Legend and Border

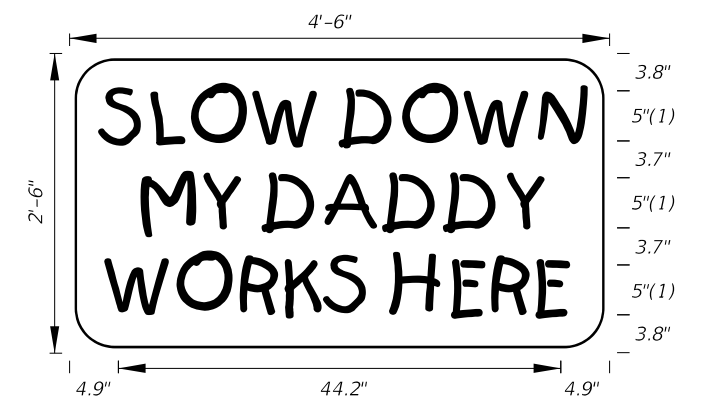

M0T-16-06  
4'-6" X 2'-6"  
4" Radii 3/4" Border

5" Kids Series Legend  
Orange Background  
Black Legend and Border

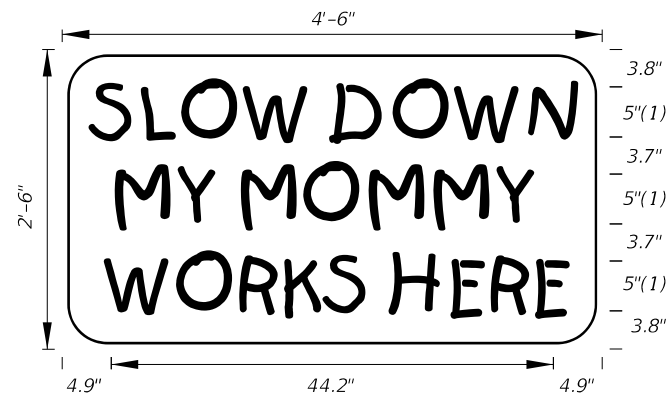

M0T-17-06  
4'-6" X 2'-6"  
4" Radii 3/4" Border

5" Kids Series Legend  
Orange Background  
Black Legend and Border

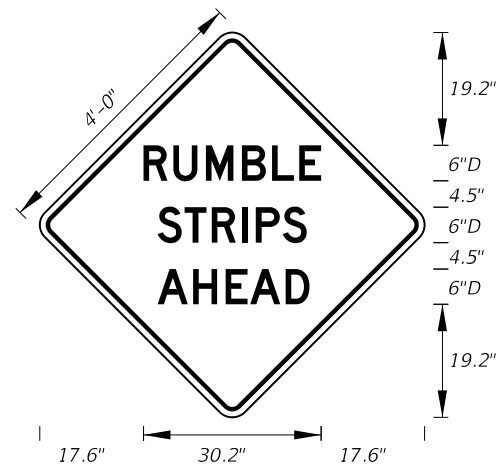

M0T-18-10  
4' X 4'  
2" Radii 3/4" Border

6" Series D Legend  
Orange Background  
Black Legend and Border

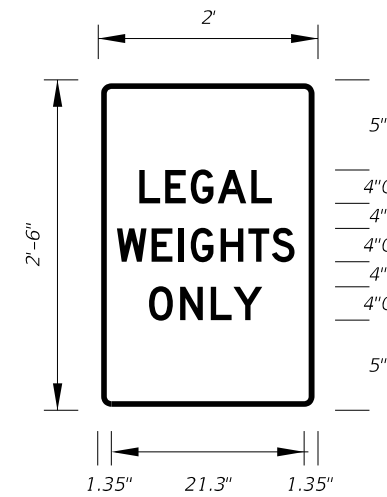

M0T-19-11  
2' X 3'  
1.13" Radii 3/4" Border

4" Series C Legend  
White Background  
Red Legend and Border

6/28/2012 12:17:06 PM rd960/h C:\projects\standards\roadway\17300-s\17355-11.dgn

LAST REVISION	01/01/12	DESCRIPTION:		<b>FDOT DESIGN STANDARDS</b> 2013	<b>SPECIAL SIGN DETAILS</b>	INDEX NO.	17355	SHEET NO.	11
---------------	----------	--------------	---	--------------------------------------	-----------------------------	-----------	-------	-----------	----