

**GENERAL NOTES FOR
RAISED RUMBLE STRIPS**

1. Raised rumble strips shall be constructed on all paved shoulders approaching structures, where the structure shoulder width is less than the usable shoulder width of the approach roadway. Raised rumble strips at intersections shall be constructed only when specified in the plans.
2. Raised rumble strips are to be constructed in accordance with Section 546 of the Specifications.
3. When any portion of a curve falls within the limit of rumble strips shown in these details, additional rumble strip sets spaced at 200' centers shall be constructed throughout the remainder of the approaching curve.
4. Raised rumble strips shall be paid for per set under the contract unit price for Rumble Strip Sets, PS. Such price and payment shall be full compensation for all work and materials required without adjustment due to width of pavement receiving the strips or length of strips.

See Index 17359 for rumble strip placement on approaches to narrow bridges.

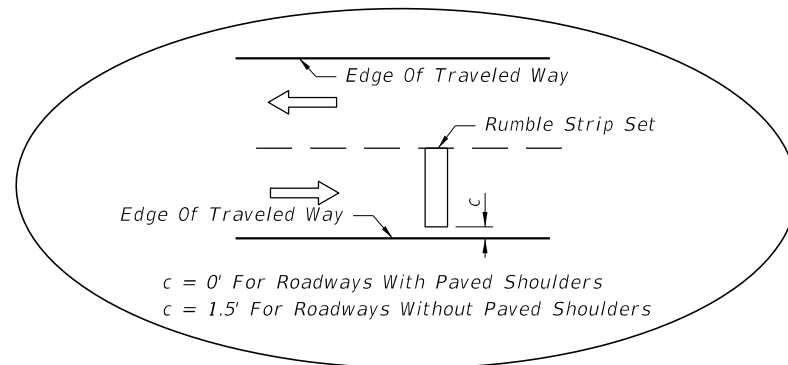

$c = 0'$ For Roadways With Paved Shoulders
 $c = 1.5'$ For Roadways Without Paved Shoulders

INSET A

Note: Rumble strips may be required for one or more legs of the intersection (one leg shown for spacing information). Rumble strips shall be constructed only on the legs identified in the plans. See General Note No. 1.

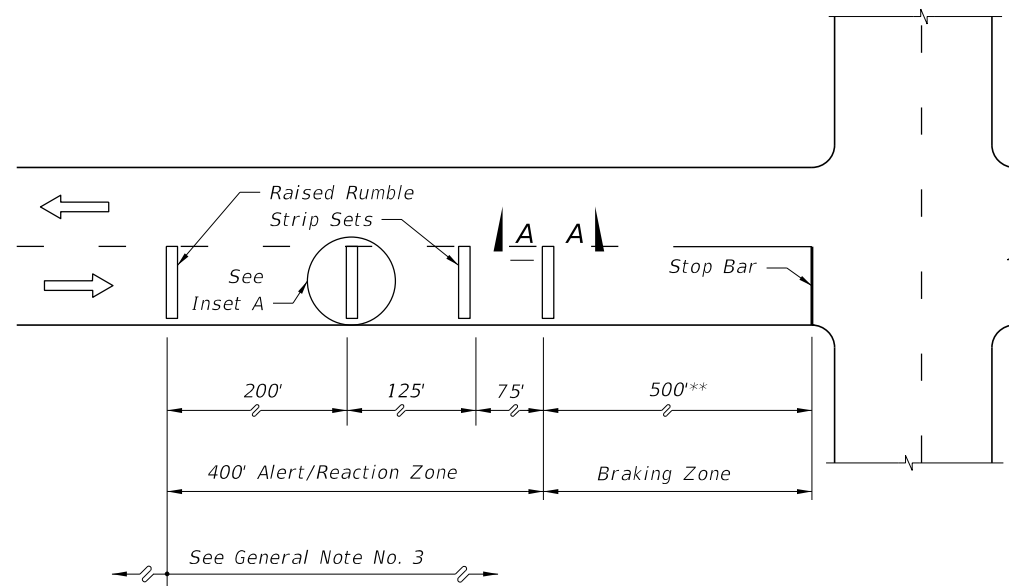

** May be decreased in urban areas with low operating speeds.

PLAN

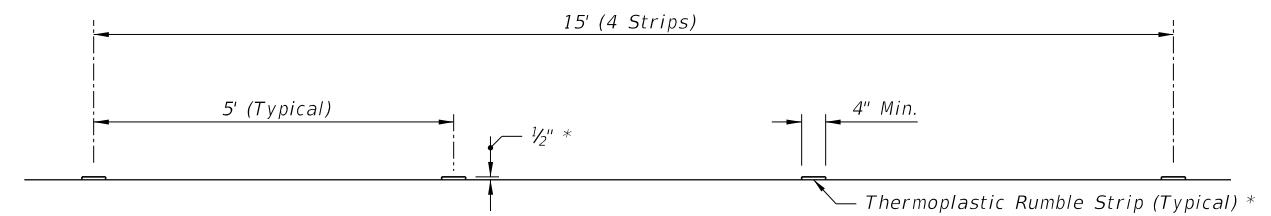

* Use multiple applications to achieve desired 1/2" thickness

Note: Shoulder thermoplastic rumble strip sets shall match edgeline color. Intersection thermoplastic rumble strip sets shall be white.

THERMOPLASTIC SET

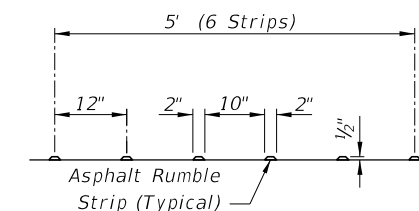

ASPHALT SET

SECTION AA * FOR THERMOPLASTIC AND ASPHALT RUMBLE STRIP SETS

RAISED RUMBLE STRIPS AT INTERSECTIONS

C:\projects\standards\roadway\00500-s\00518-01.dgn
r1960rh
11:44:36 AM
12/30/2011

LAST REVISION 07/01/09	DESCRIPTION:	 FDOT DESIGN STANDARDS FY 2012/2013	RUMBLE STRIPS	INDEX NO. 518	SHEET NO. 1
REVISION					

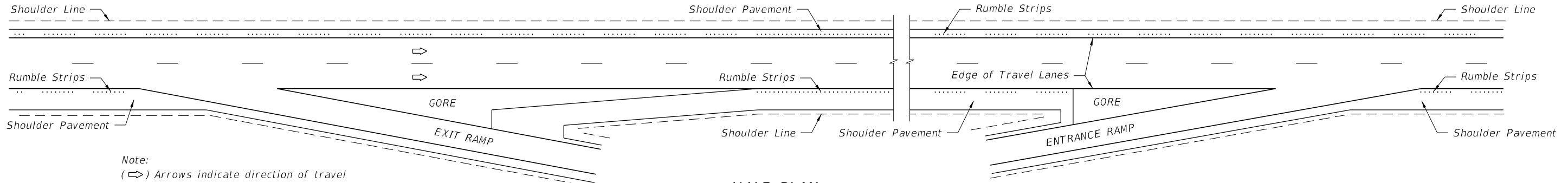

Note:
 (→) Arrows indicate direction of travel and not the number of lanes nor width of median shoulder pavement.

HALF PLAN
 LIMITED ACCESS FACILITIES

SHOULDER GROUND-IN RUMBLE STRIP PLACEMENT

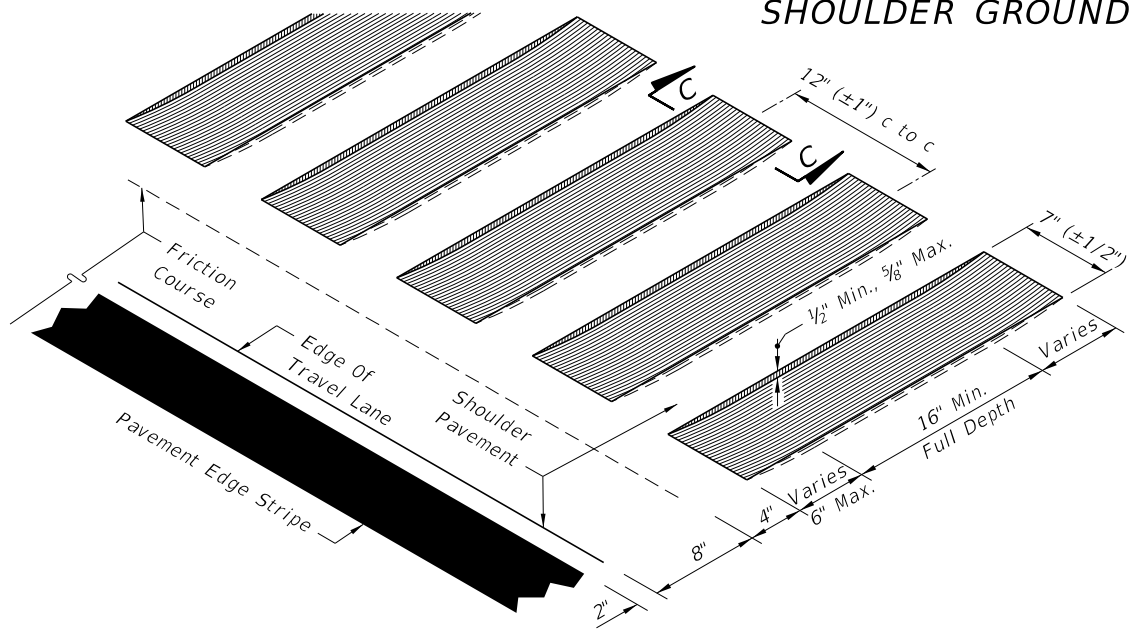

ISOMETRIC - TRANSVERSE CUT

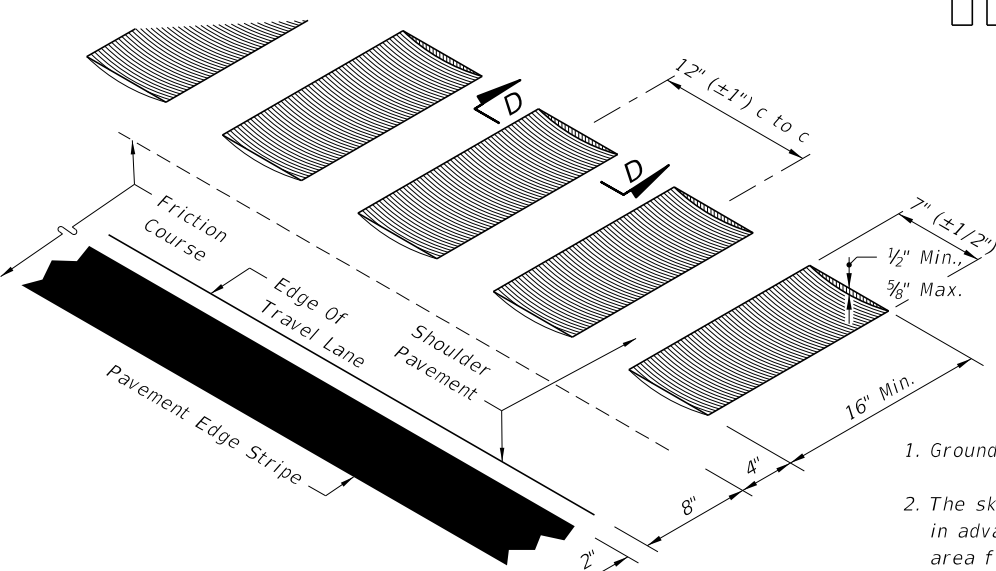

ISOMETRIC - LONGITUDINAL CUT

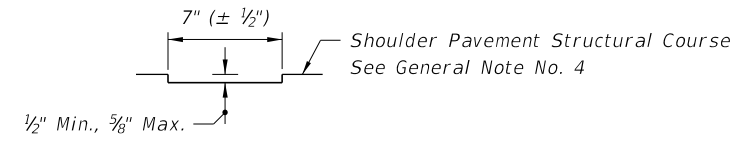

SECTION CC
 TRANSVERSE CUT

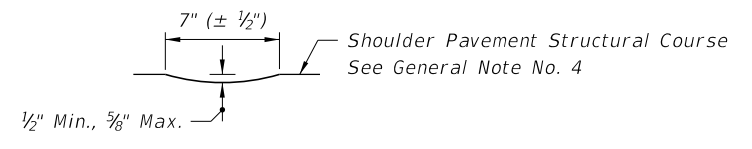

SECTION DD
 LONGITUDINAL CUT

LOCATION ALONG SHOULDER (FLEXIBLE PAVEMENT)

SHOULDER GROUND-IN RUMBLE STRIPS

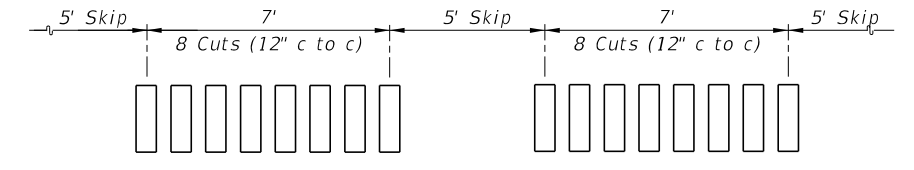

SKIP ARRAY

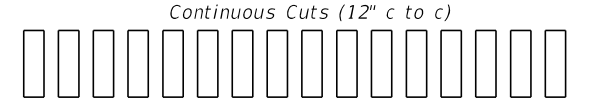

CONTINUOUS ARRAY

ARRAYS

GENERAL NOTES FOR SHOULDER GROUND-IN RUMBLE STRIPS

1. Ground-in rumble strips shall be constructed on limited access facilities.
2. The skip array is the standard array. The continuous array shall be constructed in advance of bridge ends for a distance of 1000', or back to the gore recovery area for mainline interchange bridges; and constructed at other specific locations as called for in the plans.
3. Ground-in rumble strips are to be constructed in accordance with Section 546 of the Specifications.
4. When friction course extends more than 8" beyond the edge of the travel lane, the extended friction course shall be bladed off back to the 8" line, prior to rumble strip grinding.
5. Both arrays shall be paid for under the contract unit price for Rumble Strips (Ground-In), PM. Such price and payment shall be full compensation for all work and materials required.

DESIGN NOTE

1. The rumble strips described on this sheet are intended for use on flexible pavement shoulders. When constructing ground-in rumble strips on existing rigid (concrete) shoulders, no rumble strips shall be located closer than 6" from any pavement joint. When specifying ground-in rumble strips on existing rigid shoulders their location and array shall be detailed in the plans.
2. Other methods and types of applications shall not be used unless approved in writing by the State Roadway Design Engineer. Approval will be considered only with sufficient documented justification for deviation from this standard.

C:\projects\standards\roadway\00500-s\00518-02.dgn
 r0960rh
 11:44:36 AM
 12/30/2011

LAST REVISION	DESCRIPTION:	FDOT DESIGN STANDARDS FY 2012/2013	RUMBLE STRIPS	INDEX NO.	SHEET NO.
07/01/07				518	2

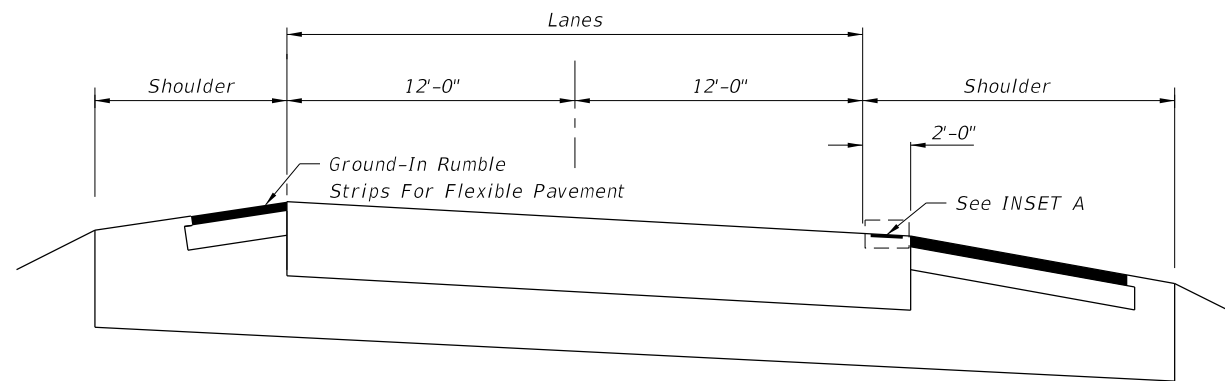

NTS
RIGID PAVEMENT WITH FLEXIBLE PAVEMENT SHOULDER

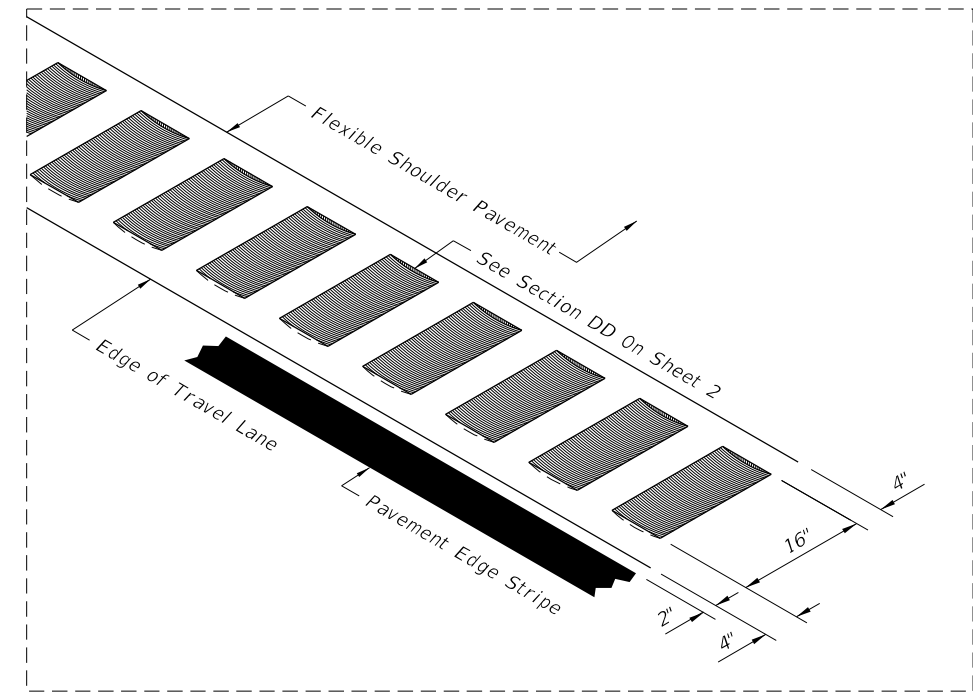

ISOMETRIC - LONGITUDINAL CUT
INSET A

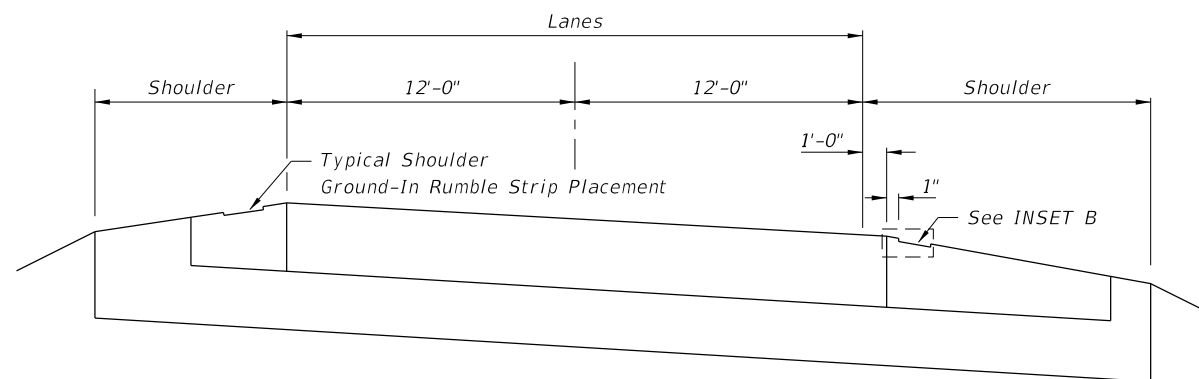

NTS
RIGID PAVEMENT WITH RIGID PAVEMENT SHOULDER

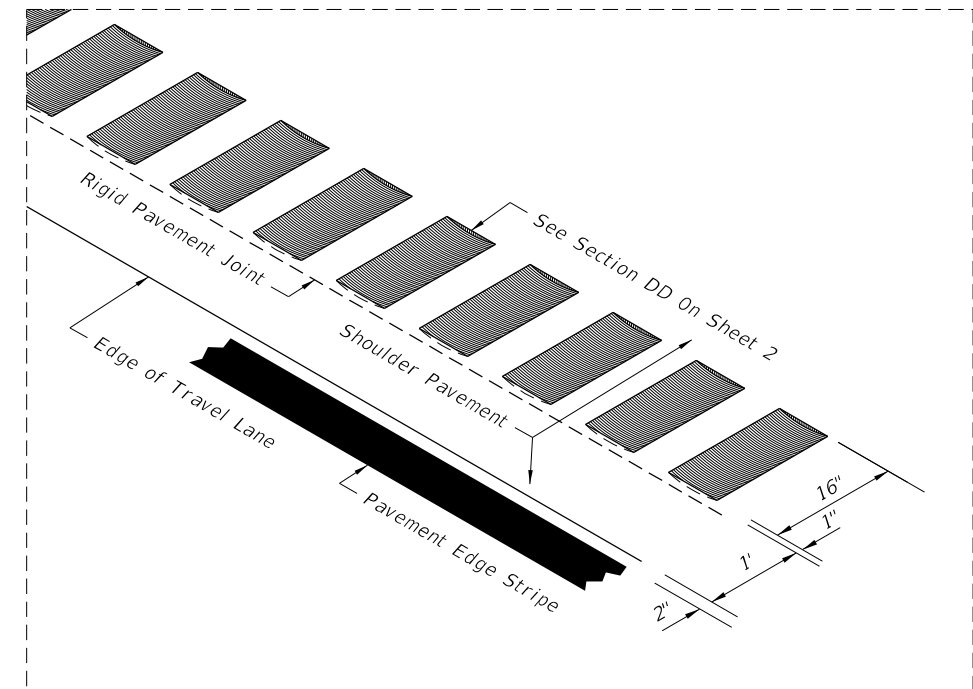

ISOMETRIC - LONGITUDINAL CUT (RIGID PAVEMENT)
INSET B

12/30/2011 11:44:37 AM r19960/h C:\projects\standards\roadway\00500-s\00518-03.dgn

LAST REVISION	DESCRIPTION:
07/01/09	

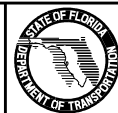

FDOT DESIGN STANDARDS
FY 2012/2013

RUMBLE STRIPS

INDEX NO.	SHEET NO.
518	3