

* These dimensions are measured perpendicular to the end of beam

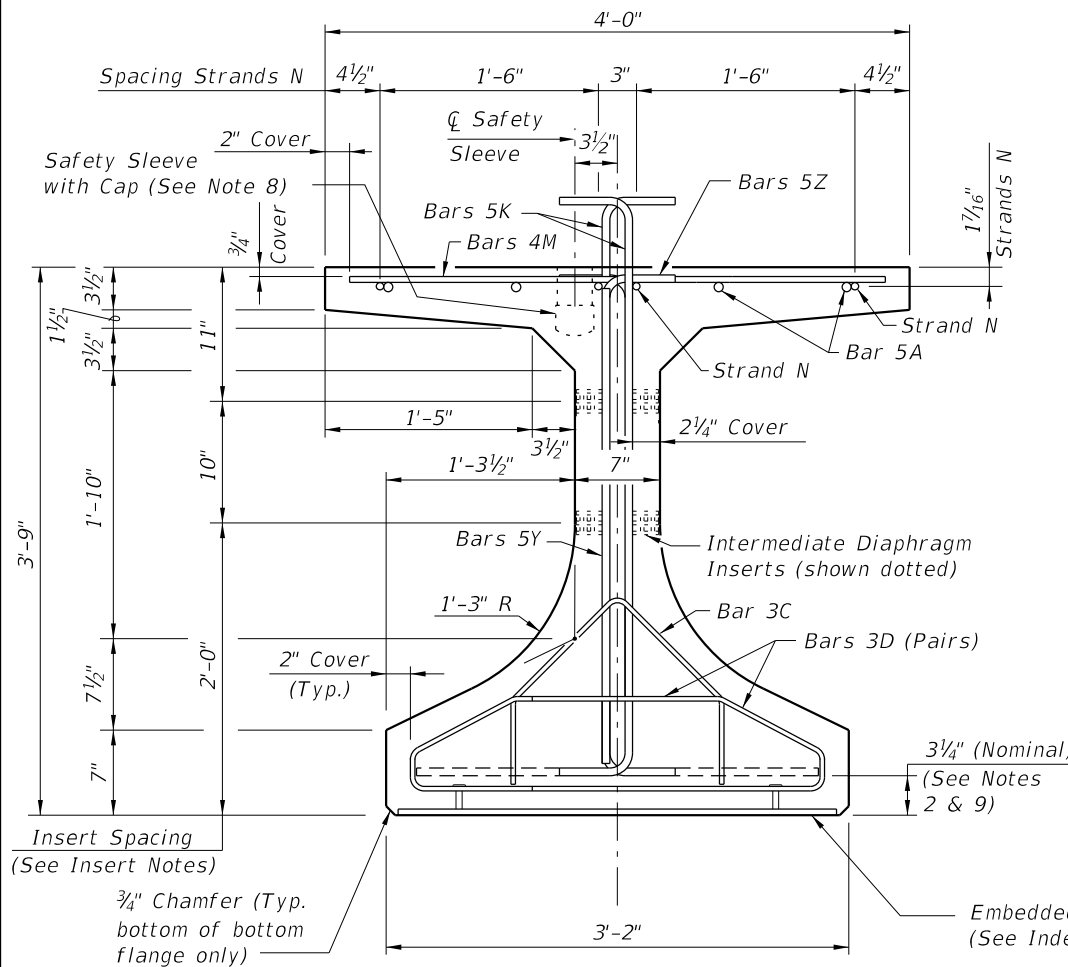

END VIEW

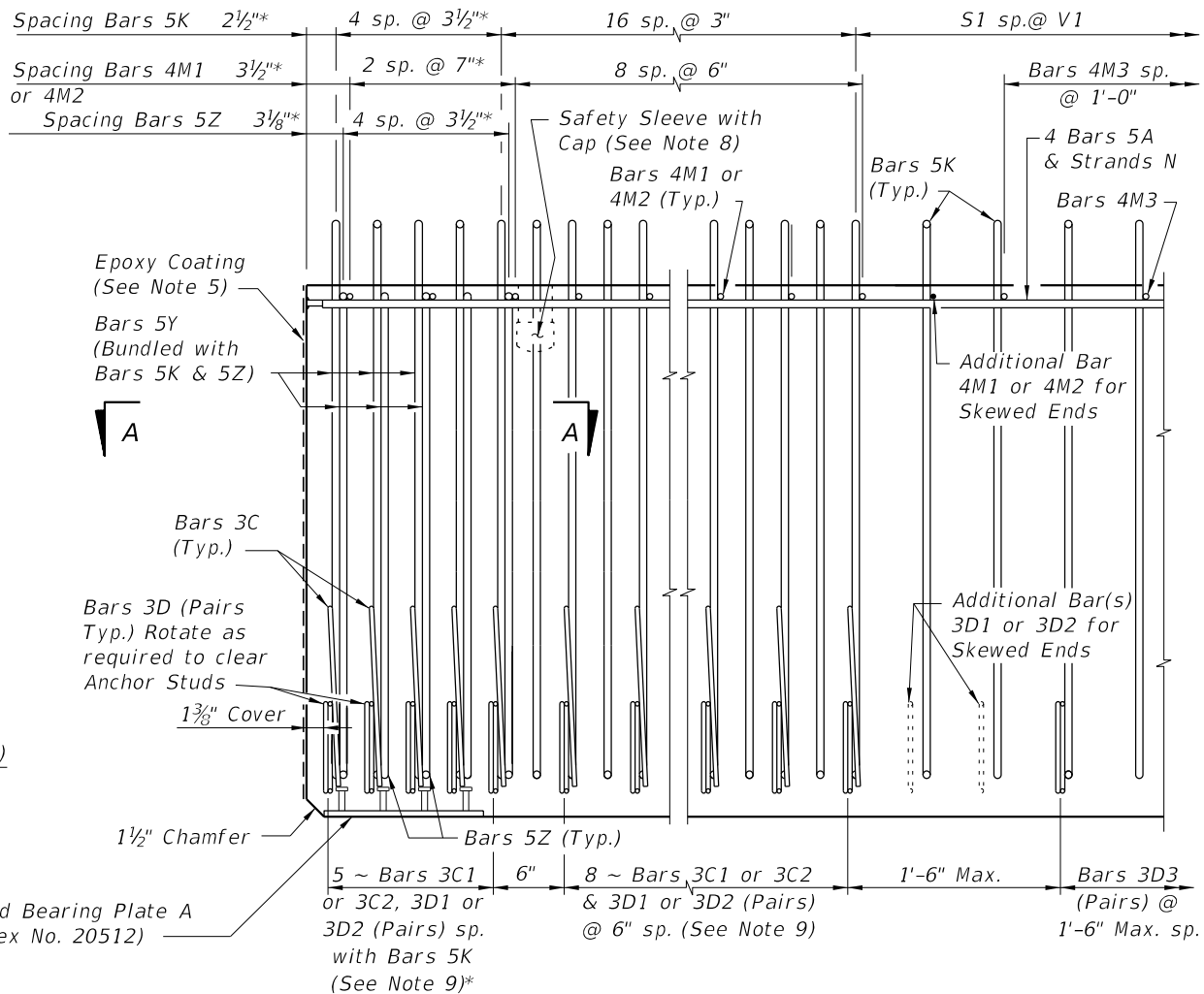

ELEVATION AT END OF BEAM
(Flanges Not Shown For Clarity)
(End 1 Shown, End 2 Similar)

CONVENTIONAL REINFORCING BAR BENDING DETAILS

BILL OF REINFORCING STEEL				
MARK	NOTE NUMBERS	SIZE	NUMBER REQUIRED	LENGTH (NOTE 1)
A	—	5	8	19'-0"
C1	9, 10 & 11	3	13 (End 1)	Varies
C2	9, 10 & 11	3	13 (End 2)	Varies
D1	9, 10, 11 & 14	3	26 (End 1)	Varies
D2	9, 10, 11 & 14	3	26 (End 2)	Varies
D3	9 & 14	3	See Table	4'-3"
K	2, 9, 11 & 13	5	See Table	4'-11"
M1	9 & 10	4	11 (End 1)	Varies
M2	9 & 10	4	11 (End 2)	Varies
M3	9	4	See Table	3'-8"
N	3 & 4	3/8" Ø Strand	4	DIM L
Y	9 & 11	5	12	3'-3"
Z	2, 9, 11 & 13	5	10	4'-5"

BENDING DIAGRAMS (See Note 1)

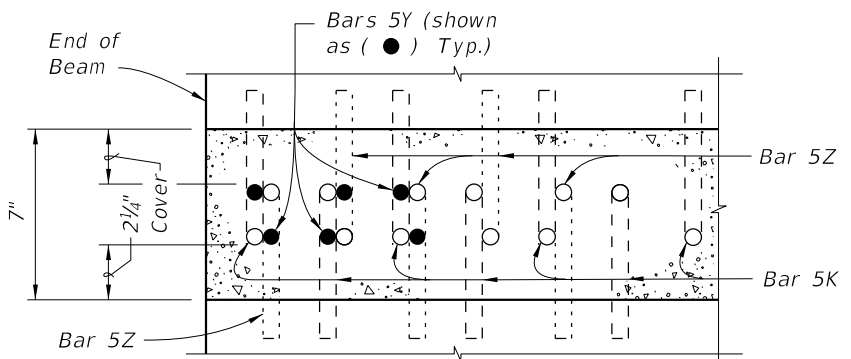
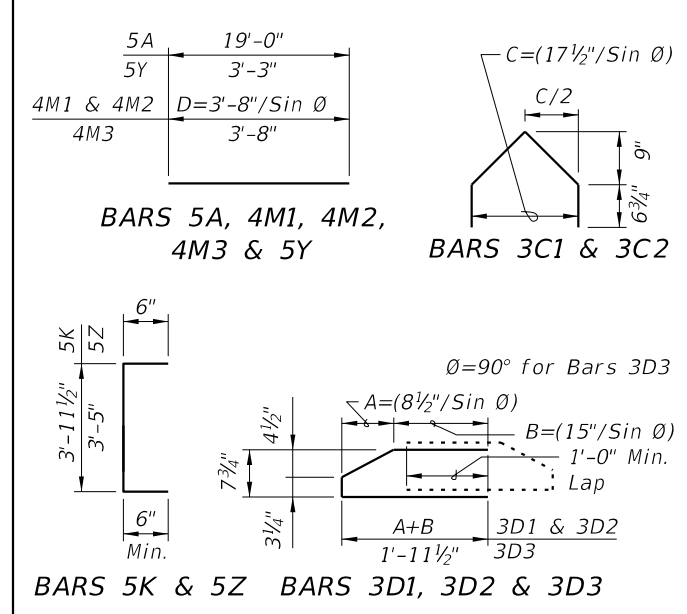

SECTION A-A FOR CONVENTIONAL REINFORCING
(Showing Bars 5K, 5Y & 5Z Only)

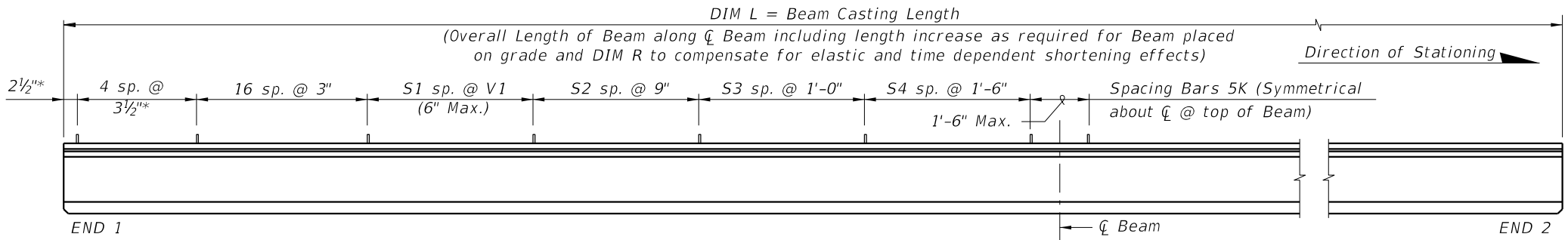

ELEVATION

NOTES:
 A. Work this Index with Index No. 20010 - Typical Florida-I Beam Details and Notes and the Florida-I Beam - Table of Beam Variables in Structures Plans.
 B. For referenced notes, see Index No. 20010.
 C. For Dimensions A, B, C, D, L, R & V1 and number of spaces S1 thru S4, see Florida-I Beam - Table of Beam Variables in Structures Plans.

REVISIONS			
DATE	BY	DESCRIPTION	
01/01/10	RMS	New Design Standard	
07/01/10	SJN	Deleted Bars 4L; Changed NOTE NUMBERS for Strand N; and Embedded Bearing Plate A to Index No. 20512; Added Epoxy Coating to end of beam.	

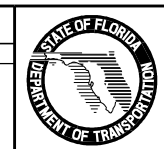

2010 Interim Design Standard

FLORIDA-I 45 BEAM - STANDARD DETAILS

Interim Date: 07/01/10
 Sheet No.: 1 of 2
 Index No.: 20045

ALTERNATE REINFORCING STEEL (WELDED WIRE REINFORCEMENT) DETAILS

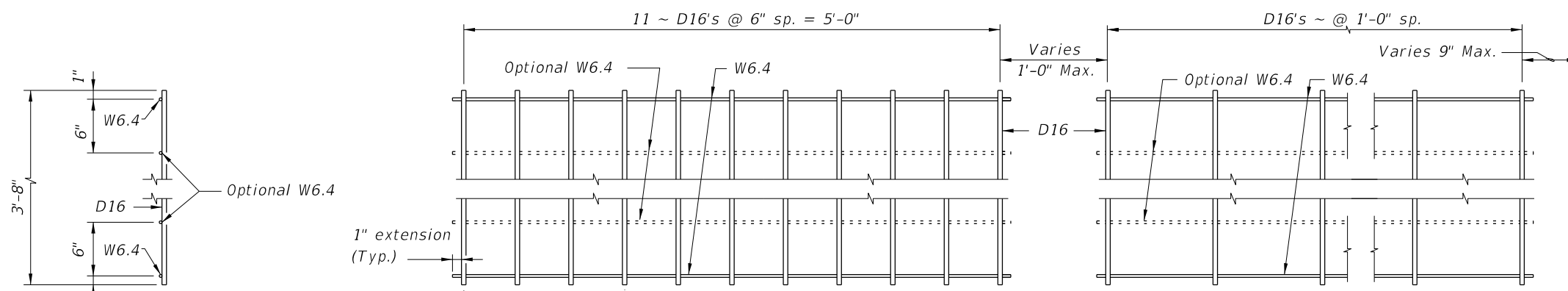

PLAN VIEW
PIECE M-1
(2 Required)

PLAN VIEW
PIECE M-3
(2 Required)

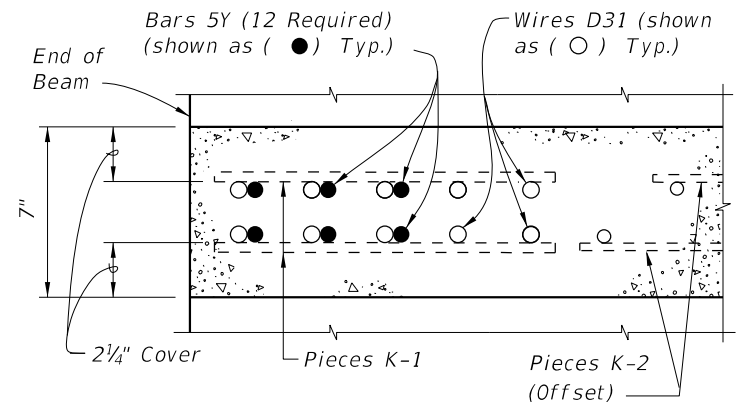

SECTION A-A
FOR WELDED WIRE REINFORCEMENT

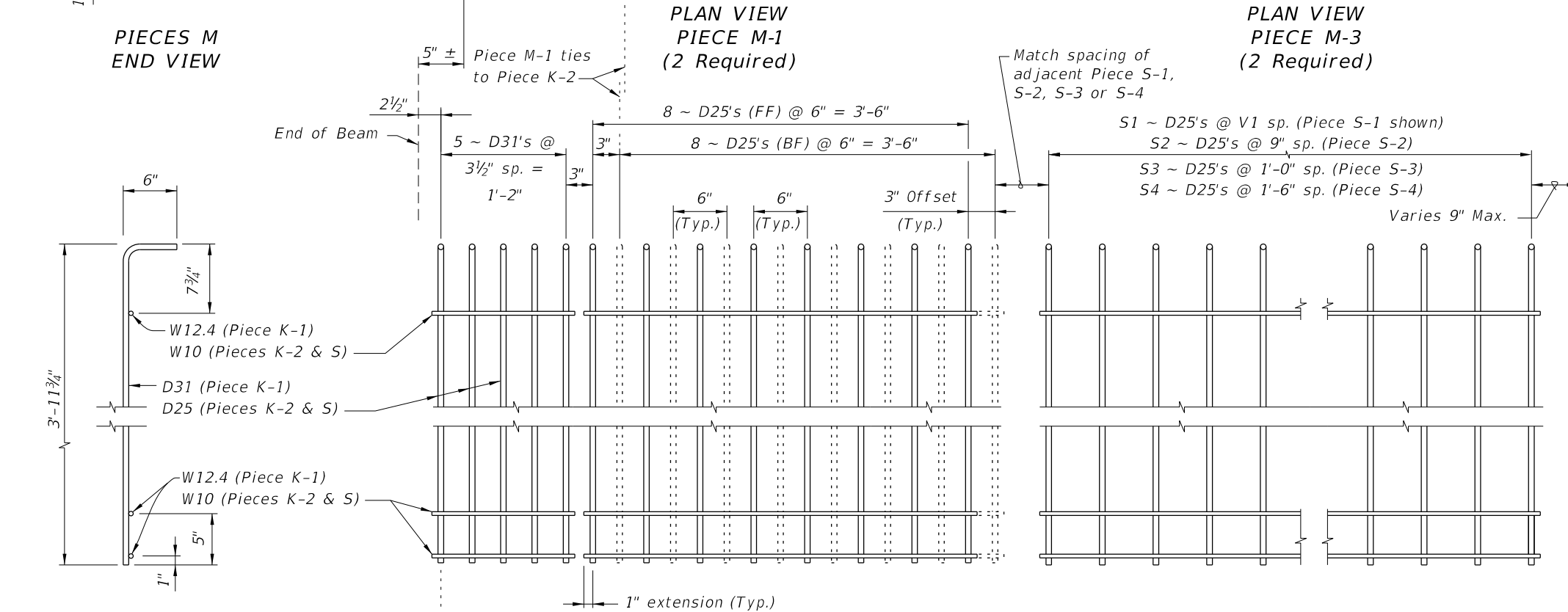

PIECE K-1
(Aligned EF) (FF Shown Solid, BF Shown Dashed)
(4 Required ~ 2 Pairs)

PIECE K-2
(4 Required)

PIECE S-1, S-2, S-3 or S-4
(2 Required Each Piece)

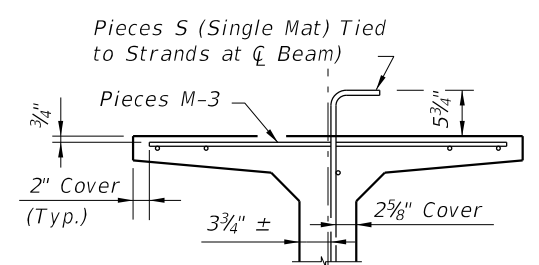

PARTIAL SECTION AT CENTER BEAM

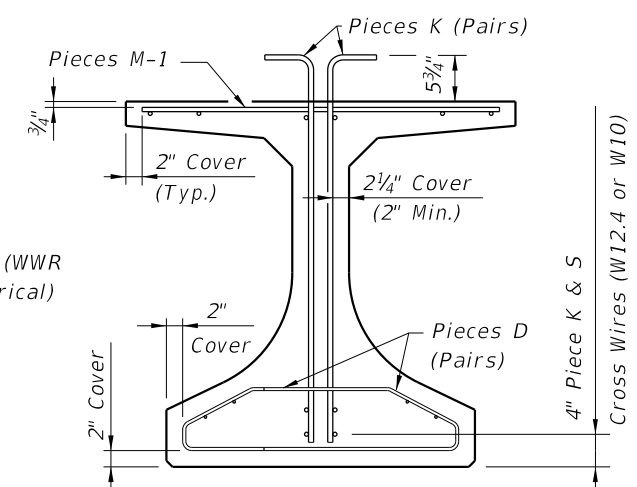

PARTIAL BEAM END VIEW
(Conventional Reinforcing Bars A, C, Y and Strands not Shown for Clarity)

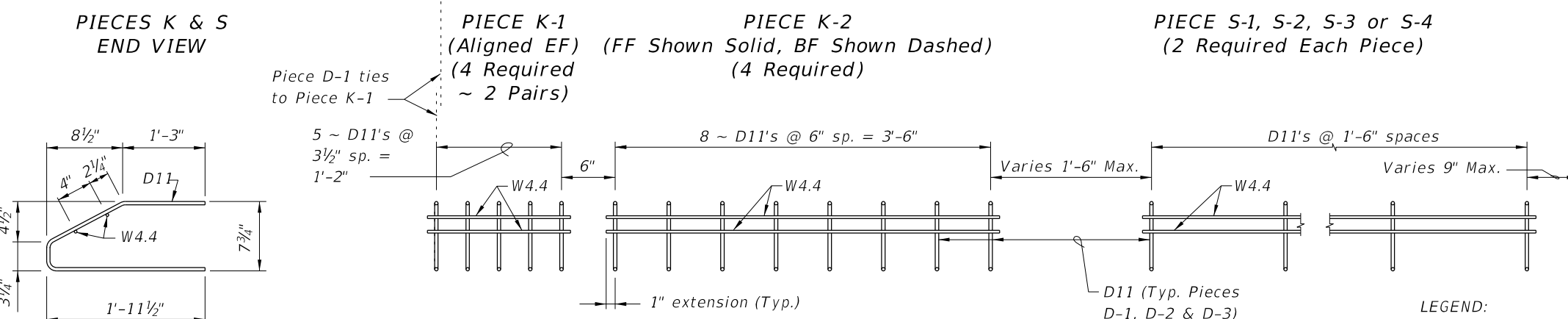

PIECE D-1
(4 Required ~ 2 Pairs)

PIECE D-2
(4 Required ~ 2 Pairs)

PIECE D-3
(4 Required ~ 2 Pairs)

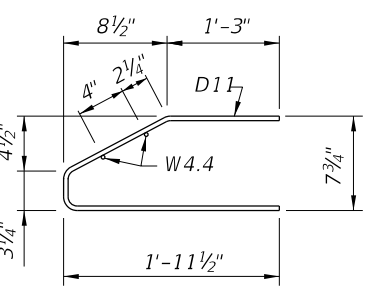

PIECES D
END VIEW

NOTES:

- See Sheet 1 for placement details & Table of Beam Variables in Structures Plans for variables S1, S2, S3, S4 & V1.
- Place Conventional Reinforcing Bars 5A & 3C as shown on Sheet 1. Place additional Bars 5Y as shown in Section A-A for Welded Wire Reinforcement. Bars 5Z will not be used with the WWR Option.
- Pieces may be fabricated in multiple length sections.
- For beams with skewed end conditions, Pieces D-1, D-2 & M-1 shall not be used; Conventional Reinforcing Bars D1, D2, C1, C2, M1 & M2 shall be used. See Index No. 20010 Skew Details and Note 9 for placement details. Shift Pieces K & Bars 5Y to accommodate skewed end conditions and align with Bars C and D.

LEGEND:
EF = Each Face
FF = Front Face
BF = Back Face

REVISIONS					
DATE	BY	DESCRIPTION	DATE	BY	DESCRIPTION
01/01/10	RMS	New Design Standard			
07/01/10	SJN	Deleted Bars L references; Changed interior W6.4 wires to "Optional" for PIECES M.			

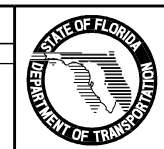

2010 Interim Design Standard

FLORIDA-I 45 BEAM - STANDARD DETAILS

Interim Date: 07/01/10
Sheet No.: 2 of 2
Index No.: 20045