

PLAN - OPTION B
SPREAD FOOTING ADJACENT TO SKEWED APPROACH SLAB AND WITH BARRIER WALL INLET
(Option A Similar)

NOTES

1. **CONSTRUCTION REQUIREMENTS:** Construct the Spread Footing level transversely and expansion joints plumb; do not construct the spread footing perpendicular to the roadway surface. Slip forming is not permitted.
2. **CONCRETE:** Use Class II concrete for slightly aggressive environments. Use Class IV concrete for moderately or extremely aggressive environments. Concrete will be in accordance with Specification Section 346.
3. **REINFORCING STEEL:** Provide Grade 60 reinforcing steel in accordance with Specification Section 931. Dowel Load Transfer Devices will be ASTM A 36 smooth round bar and hot-dip galvanized in accordance with Specification Section 962. Install Dowel Load Transfer Devices in accordance with Specification Section 350.
4. Construct 3/4" Expansion Joints plumb and perpendicular or radial to Gutter Line. Provide at 90'-0" maximum intervals as shown.
5. Provide and install Preformed Expansion Joint Filler in accordance with Specification Section 932.
6. Construct 1/2" V-Grooves plumb and provide at 30'-0" maximum intervals as shown. Space V-Grooves equally between 3/4" Expansion Joints and/or Begin or End Spread Footing. V-Groove locations are to coincide with V-Groove locations in the Railing/Sound Barrier.
7. **FILL REQUIREMENTS:** Shoulder or Roadway Pavement and Fill is required on the traffic side of the spread footing for a distance of 4'-0" and the full length of the spread footing (3'-0" minimum depth) on the backside of the spread footing for Option A. Fill is required for a distance of 4'-0" on the backside of the spread footing and the full length of the spread footing (3'-0" minimum depth) on the traffic side of the spread footing for Option B. See Typical Sections on Sheet Nos. 2 and 3 for details.
8. Spacing shown is along the Gutter Line.
9. Work this Standard Drawing with one or both of the following:
 - a. Index No. 5210 - Traffic Railing/Sound Barrier (8'-0").
 - b. Index No. 5211 - Traffic Railing/Sound Barrier (14'-0").

CROSS REFERENCE:
 For Detail "A", see Sheet 3.
 For Section A-A and Estimated Quantities, see Sheet 4.



2010 FDOT Design Standards

TRAFFIC RAILING/SOUND BARRIER
L-SHAPED SPREAD FOOTING

Last Revision	Sheet No.
07/01/05	1 of 4
Index No.	
5214	

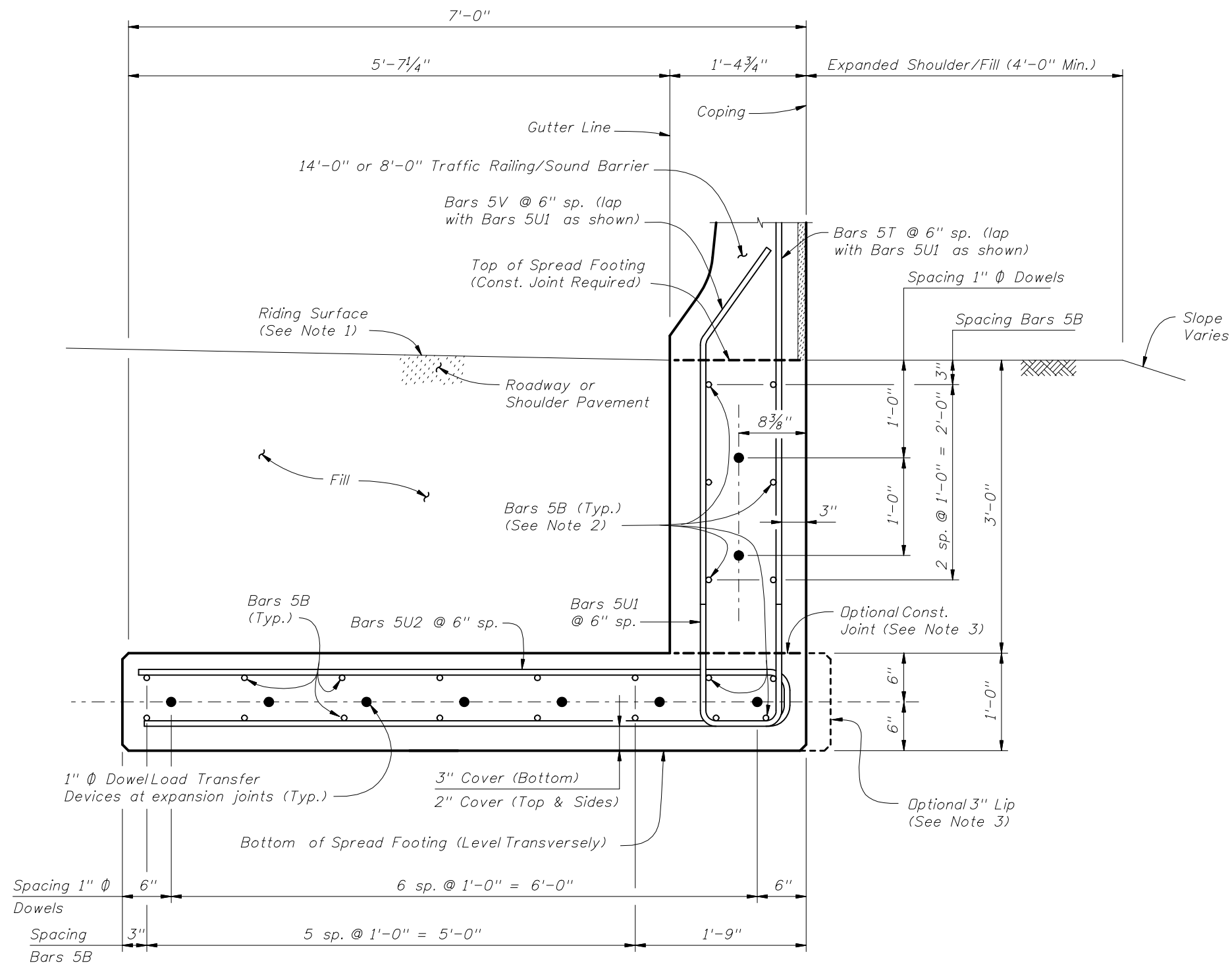

TYPICAL SECTION THRU SPREAD FOOTING - OPTION B
 (Bars 5P, 5R and 5S1 in Traffic Railing/Sound Barrier not shown for clarity)

NOTES:

1. Match Cross Slope of Travel Lane or Shoulder.
2. Place 10 ~ Bars 5B inside Bars 5U1 as shown.
3. Provide 3" lip when optional construction joint is used.

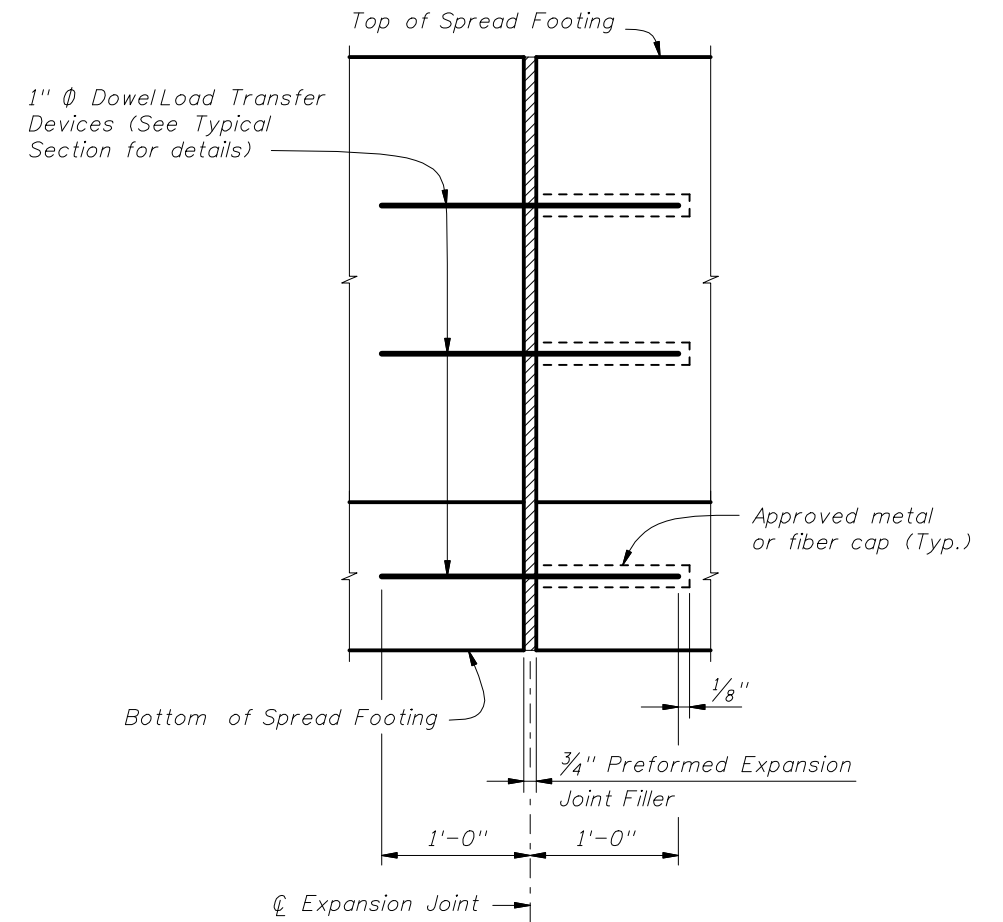

EXPANSION JOINT DETAIL

(Spread Footing expansion joints are required at 3/4" open joints in Traffic Railing/Sound Barrier)

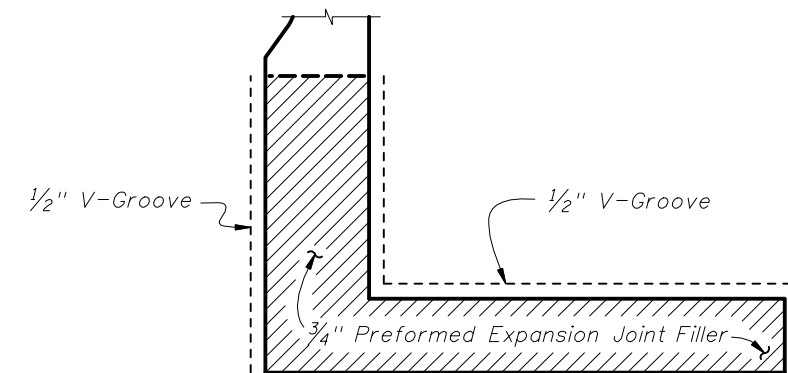

DETAIL "A"
 (Option A Shown, Option B Similar)

(Showing Locations of 1/2" V-Grooves and 3/4" Preformed Expansion Joint Filler)



2010 FDOT Design Standards

**TRAFFIC RAILING/SOUND BARRIER
 L-SHAPED SPREAD FOOTING**

Last Revision 07/01/05 Sheet No. 3 of 4

Index No.

5214

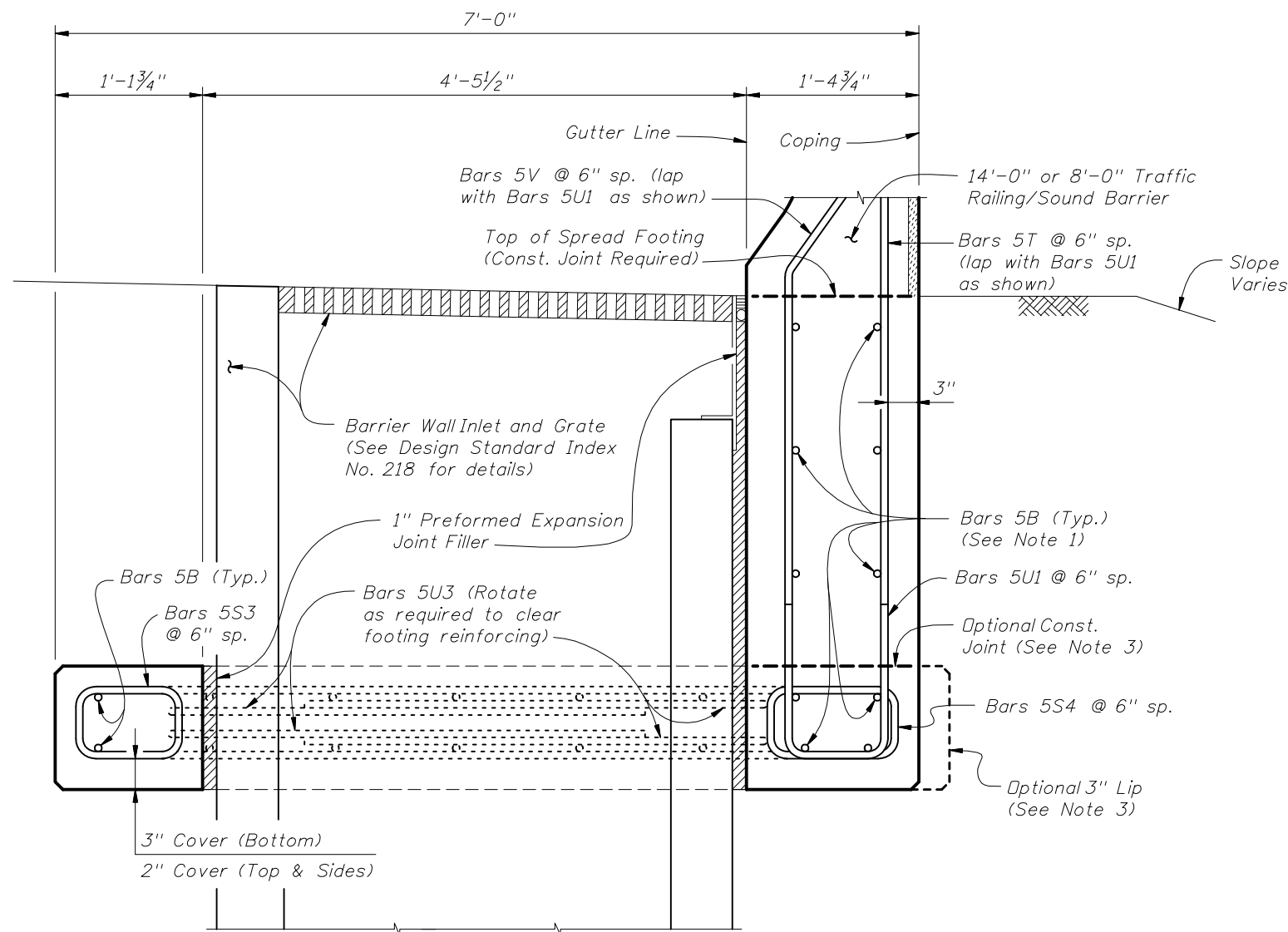

SECTION A-A
TYPICAL SECTION THRU SPREAD FOOTING AND BARRIER WALL INLET - OPTION B
(Bars 5P, 5R and 5S1 in Traffic Railing/Sound Barrier not shown for clarity)

NOTES:

1. Place 10 ~ Bars 5B inside Bars 5U1 as shown.
2. For Reinforcing Steel spacing, see Typical Section Thru Spread Footing - Option B on Sheet 3.
3. Provide 3" lip when optional construction joint is used.

ESTIMATED L-SHAPED SPREAD FOOTING QUANTITIES

ITEM	UNIT	QUANTITY
Concrete (Footing)	CY/Ft.	0.414
Reinforcing Steel (Typical)	LB/Ft.	85.53
Additional Reinf. @ Expansion Joint	Lb.	48.06

(Subtract 12.69 lb/ft from typical reinforcing steel quantity shown on Index No. 5210 to account for the absence of Stirrup Bars 5V and 5S1 in L-Shaped Spread Footings.)

CROSS REFERENCE:
For location of Section A-A, see Sheet 1.

REINFORCING STEEL BENDING DIAGRAMS

BILL OF REINFORCING STEEL		
MARK	SIZE	LENGTH
B	5	AS REQD.
C	5	5'-6"
S3	5	3'-10"
S4	5	4'-3"
T	5	4'-3"
U1	5	8'-0"
U2	5	13'-11"
U3	5	12'-10"
V	5	3'-10"
DOWEL	1" ϕ Smooth Bar	2'-0"

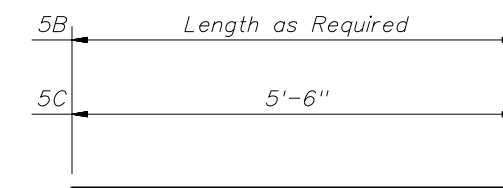

BARS 5B & 5C

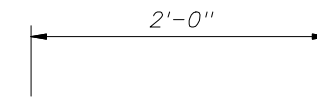

1" ϕ DOWEL

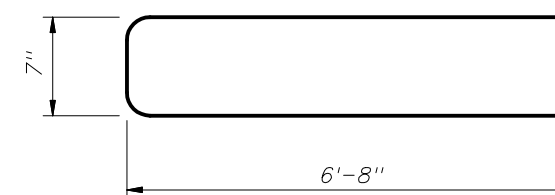

BAR 5U2

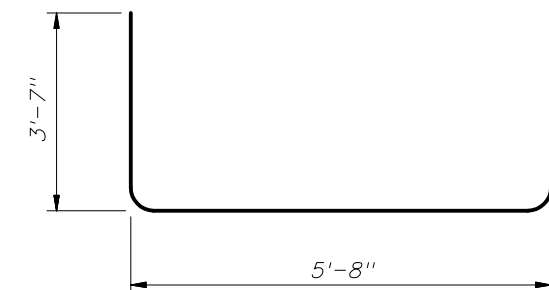

BAR 5U3

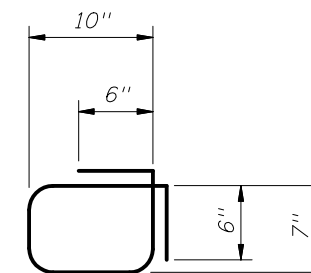

BAR 5S3

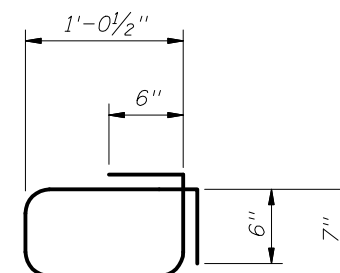

BAR 5S4

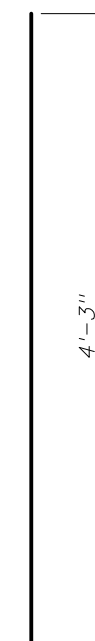

BAR 5T

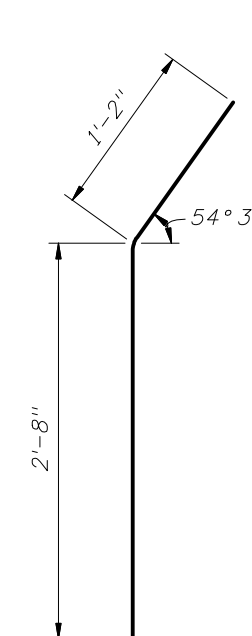

BAR 5V

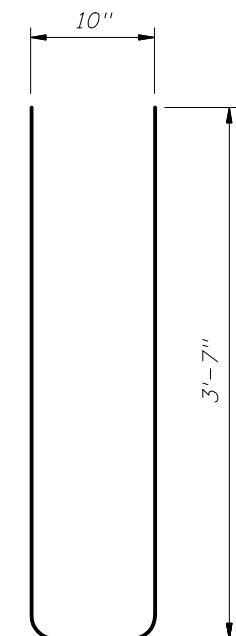

BAR 5U1

REINFORCING STEEL NOTES:

1. All bar dimensions in the bending diagrams are out to out.
2. All reinforcing steel at the open joints will have a 2" minimum cover.
3. Lap splices for Bars 5B will be a minimum of 2'-2".
4. Lap splices Bars 5T and 5V with 5U1 will be a minimum of 2'-2".
5. The Contractor may use Welded Wire Fabric when approved by the Engineer. Welded Wire Fabric will conform to ASTM A 497.



2010 FDOT Design Standards

TRAFFIC RAILING/SOUND BARRIER
L-SHAPED SPREAD FOOTING

Last Revision: 07/01/05
Sheet No. 4 of 4
Index No. 5214