

# DESIGN STANDARDS

FOR DESIGN, CONSTRUCTION, MAINTENANCE AND UTILITY  
OPERATIONS ON THE STATE HIGHWAY SYSTEM

**2010**

**TOPIC NO. 625-010-003**

Approved For Use On Federal Aid Projects

  
For Martin Knopp, Division Administrator

State of Florida, Department Of Transportation  
Roadway Design Office  
Mail Station 32  
605 Suwannee Street  
Tallahassee, Florida 32399-0450

### NOTICE

*These Design Standards are intended to support the various engineering obligations for designing, constructing, inspecting, maintaining and monitoring the highways, roads and streets on the State Highway System. They are prepared to encourage uniform application of designs and standard details in the preparation of project plans. These Standards may be adopted by other authorities for use on projects under their jurisdiction.*

*It is the responsibility of the Design Engineer of Record using these Standards to determine the fitness for a particular use of each standard in the design of a project. The inappropriate use of and adherence to these standards does not exempt the engineer from the professional responsibility of developing an appropriate design.*

### PATENTED DEVICES, MATERIALS AND PROCESSES

*The use of any design, method, process, material or device either expressed or implied by these standards that are covered by patent, copyright, or proprietary privilege is the sole responsibility of the user. Any infringement on the rights of the inventor, patentee, assignee or licensee shall be the sole responsibility of the user. For additional information refer to Subsection 7-3 of the FDOT Standard Specifications for Road and Bridge Construction.*

### *Distribution of Exempt Public Documents:*

*It is the policy of the Department to protect the State Highway System's infrastructure from disclosure under Florida's public records law for documents concerning Department structures. This exemption is created by Section 119.07(3)(ee), F.S. and covered by Department Procedure "Distribution of Exempt Public Documents Concerning Department Structures and Security System Plans (Topic No. 050-020-026)." Structure is defined in Section 334.03(28), F.S., as "a bridge, viaduct, tunnel, causeway, approach, ferry slip, culvert, toll plaza, gate, or other similar facility used in connection with a transportation facility." This includes pipes and pipe systems. Therefore, those portions of Department plans that depict pipes, pipe systems, or the internal layout and structural elements of a structure owned or operated by the Department, are exempt from a public records request under Section 119.07(3)(ee), F.S.. This applies to all formats (paper, electronic, etc.), and at any phase of completion (existing, draft, preliminary, phase reviews, final). Entities or persons outside the Department requesting or receiving copies of any portion of plans considered Exempt Documents will need to complete a request form (Form No. 050-020-26). The form also advises the requestor that the entity or person receiving the information shall maintain the confidential and exempt status of the information. This procedure applies to both Department internal or contracted staff who produce such Exempt Documents in their Department work or have other methods of access to such Exempt Documents in the distribution to persons or entities outside of the Department. Refer to Topic No. 050-020-026 for further requirements.*

*The pdf version of these standards can be accessed on the following website:*

*<http://www.dot.state.fl.us/rddesign/DesignStandards/Standards.shtm>*

*Copies of this document can be procured by contacting the following:*

**FLORIDA DEPARTMENT OF TRANSPORTATION**

**MAPS & PUBLICATION SALES**

**MAIL STATION 12**

**605 SUWANNEE STREET**

**TALLAHASSEE, FLORIDA 32399-0450**

**Phone (850) 414-4050**

**Fax Number (850) 414-8036**

*<http://www.dot.state.fl.us/mapsandpublications/>*

**CERTIFICATION STATEMENT**

*I hereby certify that this Design Standard Book was compiled under my responsible charge from designs prepared, examined, adopted and implemented by the Florida Department of Transportation in accordance with established procedures, and as approved by the Federal Highway Administration.*

|   |   |   |   |
|---|---|---|---|
| <p align="center"><i>As To Structures<br/>Design Standards Nos.</i></p> <p align="center">199<br/>289-292<br/>302 (Sheets 2-4)<br/>306<br/>403<br/>411<br/>414<br/>420-425<br/>470-490<br/>501,505<br/>521<br/>530<br/>810-880<br/>5100-5301<br/>11200-11860<br/>13417<br/>17502 (Sheets 3-7)<br/>17515<br/>17723,17725<br/>17743,17745<br/>17749<br/>20110-21930</p> | <p align="center"><i>As To Roadway<br/>Design Standards Nos.</i></p> <p align="center">001-106<br/>200-288<br/>293,295<br/>300-301<br/>302 (Sheet 1)<br/>303-305<br/>307-310<br/>400-402<br/>410<br/>412<br/>415,417<br/>430<br/>461<br/>500<br/>506-520<br/>525-527<br/>532-540<br/>546,560<br/>600-670<br/>700<br/>800-803<br/>17302-17501<br/>17502 (Sheets 1,2)<br/>17504, 17505<br/>17600,17721<br/>177727-17736<br/>17748<br/>17764-17890</p> | <p align="center"><i>As To Planning<br/>Design Standard No.</i></p> <p align="center">17900</p>                 | <p align="center"><i>Manager, Traffic Data Section<br/>Transportation Statistics Office<br/>Richard L. Reel, Jr.<br/>P.E. No. 22400</i></p> <p align="right">Sig: _____<br/>Date:</p> |
|   |   | <p align="center"><i>As To ITS<br/>Design Standard Nos.</i></p> <p align="center">18100-18305</p>               | <p align="center"><i>Deputy State Traffic<br/>Operations Engineer<br/>Mark C. Wilson<br/>P.E. No. 46780</i></p> <p align="right">Sig: _____<br/>Date:</p>                             |
| <p><i>State Structures Design Engineer<br/>Robert V. Robertson, Jr.<br/>P.E. No. 36160</i></p> <p align="right">Sig: _____<br/>Date:</p>  | <p><i>State Roadway Design Engineer<br/>David C. D'Hagan<br/>P.E. No. 33713</i></p> <p align="right">Sig: _____<br/>Date:</p>   | <p align="center"><i>As To Landscape<br/>Architecture<br/>Design Standard No.</i></p> <p align="center">544</p> | <p align="center"><i>State Transportation<br/>Landscape Architect<br/>Jeff H. Caster<br/>LA0001592</i></p> <p align="right">Sig: _____<br/>Date:</p>                                  |

THIS SHEET INTENDED TO BE BLANK

## TABLE OF CONTENTS

### REVISIONS

Revisions Sheets Since Publication Of The 2008 Booklet (5 Sheets)

### ABBREVIATIONS AND SYMBOLS

001 Standard Abbreviations (3 Sheets)  
002 Standard Symbols (3 Sheets)

### EROSION CONTROL AND WATER QUALITY

100 Temporary Slope Drain And Sod Flume  
101 Trash Retainer And Sediment Basin  
102 Temporary Erosion And Sediment Control (3 Sheets)  
103 Turbidity Barriers  
104 Permanent Erosion Control (2 Sheets)  
105 Shoulder Sodding And Turf On Existing Facilities  
106 Soil Tracking Prevention Device Type A

### DRAINAGE

199 Geotextile Criteria  
200 Structure Bottoms—Type J And P (5 Sheets)  
201 Supplementary Details For Manholes And Inlets (5 Sheets)  
205 Cover Height (6 Sheets)  
206 Trench Drain (2 Sheets)  
210 Curb Inlet Tops—Types 1, 2, 3 And 4  
211 Curb Inlet Tops—Types 5 and 6 (5 Sheets)  
212 Curb Inlet—Type 7  
213 Curb Inlet—Type 8  
214 Curb Inlet Top—Type 9  
215 Curb Inlet Top—Type 10  
216 Closed Flume Inlet (3 Sheets)  
217 Median Barrier Inlets Types 1, 2, 3, 4 And 5 (2 Sheets)  
218 Barrier Wall Inlet (2 Sheets)  
219 Barrier Wall Inlet—Barrier Wall, Concrete (Rigid) (C & G) (2 Sheets)  
220 Gutter Inlet—Type S (3 Sheets)  
221 Gutter Inlet—Type V (2 Sheets)  
230 Ditch Bottom Inlet—Type A (2 Sheets)  
231 Ditch Bottom Inlet—Type B (3 Sheets)  
232 Ditch Bottom Inlets—Types C, D, E And H (7 Sheets)  
233 Ditch Bottom Inlets—Types F And G (2 Sheets)  
234 Ditch Bottom Inlet—Type J (2 Sheets)  
235 Ditch Bottom Inlet—Type K (2 Sheets)  
240 Skimmer For Outlet Control Structures (2 Sheets)  
241 Skimmers For French—Drain Outlets  
245 Underdrain Inspection Box  
250 Straight Concrete Endwalls—Single And Multiple Pipe (2 Sheets)  
251 Straight Concrete Endwalls—Single And Double 60" Pipe (2 Sheets)  
252 Straight Concrete Endwalls—Single And Double 66" Pipe (2 Sheets)  
253 Straight Concrete Endwalls—Single And Double 72" Pipe (2 Sheets)  
255 Straight Concrete Endwall—Single 84" Pipe  
258 Straight Sand—Cement Endwalls  
260 U—Type Concrete Endwalls With Grates—15" To 30" Pipe  
261 U—Type Concrete Endwalls—Baffles And Grate Optional—15" To 30" Pipe (3 Sheets)

### DRAINAGE (CONT.)

264 U—Type Concrete Endwall—Energy Dissipator—30" To 72" Pipe (2 Sheets)  
266 Winged Concrete Endwalls—Single Round Pipe  
268 U—Type Sand—Cement Endwalls  
270 Flared End Section  
272 Cross Drain Mitered End Section (6 Sheets)  
273 Side Drain Mitered End Section (7 Sheets)  
280 Miscellaneous Drainage Details (3 Sheets)  
281 Ditch Pavement And Sodding (2 Sheets)  
282 Back Of Sidewalk Drainage (3 Sheets)  
283 Median Opening Flume  
284 Concrete Shoulder Gutter Spillway  
285 French Drain (2 Sheets)  
286 Underdrain (2 Sheets)  
287 Concrete Pavement Subdrainage (4 Sheets)  
288 Deep Well Injection Box  
289 Concrete Box Culvert Details (LRFD) (7 Sheets)  
291 Supplemental Details For Precast Concrete Box Culverts (5 Sheets)  
292 Standard Precast Concrete Box Culverts (14 Sheets)  
293 Safety Modifications For Inlets In Box Culverts  
295 Safety Modifications For Endwalls

### CURBS AND PAVEMENT JOINTS

300 Curb & Curb And Gutter (2 Sheets)  
301 Turn Lanes  
302 Traffic Separators (4 Sheets)  
303 Curb Return Profiles  
304 Public Sidewalk Curb Ramps (6 Sheets)  
305 Concrete Pavement Joints (4 Sheets)  
306 Bridge Approach Expansion Joint—Concrete Pavement  
307 Miscellaneous Utility Details (3 Sheets)  
308 Concrete Slab Replacement (2 Sheets)  
310 Concrete Sidewalk (2 Sheets)

### TRAFFIC RAILINGS

400 Guardrail (26 Sheets)  
402 Guardrail Transitions And Connections For Existing Bridges (24 Sheets)  
403 Guardrail Transitions For Existing Bridge Traffic Railing Retrofits (3 Sheets)  
410 Concrete Barrier Wall (25 Sheets)  
411 Pier Protection Barrier (10 Sheets)  
412 Low Profile Barrier (5 Sheets)  
414 Type K Temporary Concrete Barrier (15 Sheets)  
415 Temporary Concrete Barrier (10 Sheets)  
417 Inertial Crash Cushion  
420 Traffic Railing — (32" F Shape) (3 Sheets)  
421 Traffic Railing — (Median 32" F Shape) (3 Sheets)  
422 Traffic Railing — (42" Vertical Shape) (3 Sheets)  
423 Traffic Railing — (32" Vertical Shape) (3 Sheets)  
424 Traffic Railing — (Corral Shape) (7 Sheets)  
425 Traffic Railing — (42" F Shape) (3 Sheets)  
430 Optional Crash Cushion Details (2 Sheets)  
461 Opaque Visual Barrier

### TRAFFIC RAILINGS (CONT.)

470 Traffic Railing — (Thrie Beam Retrofit) General Notes & Details (3 Sheets)  
471 Traffic Railing — (Thrie Beam Retrofit) Narrow Curb (4 Sheets)  
472 Traffic Railing — (Thrie Beam Retrofit) Wide Strong Curb Type 1 (4 Sheets)  
473  
474 Traffic Railing — (Thrie Beam Retrofit) Intermediate Curb (4 Sheets)  
475 Traffic Railing — (Thrie Beam Retrofit) Wide Curb Type 1 (4 Sheets)  
476 Traffic Railing — (Thrie Beam Retrofit) Wide Curb Type 2 (4 Sheets)  
480 Traffic Railing — (Vertical Face Retrofit) General Notes & Details (2 Sheets)  
481 Traffic Railing — (Vertical Face Retrofit) Narrow Curb (3 Sheets)  
482 Traffic Railing — (Vertical Face Retrofit) Wide Curb (4 Sheets)  
483 Traffic Railing — (Vertical Face Retrofit) Intermediate Curb (3 Sheets)  
490

### GENERAL

500 Removal Of Organic And Plastic Material (2 Sheets)  
501 Geosynthetic Reinforced Soils (9 Sheets)  
505 Embankment Utilization (4 Sheets)  
506 Miscellaneous Earthwork Details  
510 Superelevation—Rural Highways, Urban Freeways And High Speed Urban Highways (2 Sheets)  
511 Superelevation—Urban Highways And Streets (3 Sheets)  
514 Optional Base Group And Structural Numbers (2 Sheets)  
515 Turnouts (7 Sheets)  
516 Turnouts—Resurfacing Projects  
518 Rumble Strips (3 Sheets)  
520 Gravity Wall  
521 Concrete Steps  
525 Ramp Terminals (5 Sheets)  
526 Roadway Transitions (8 Sheets)  
527 Directional Median Opening (3 Sheets)  
530 Rest Area Equipment (3 Sheets)  
532 Mailboxes (3 Sheets)  
535 Tractor Crossings  
540 Settlement Plate  
544 Landscape Installation (3 Sheets)  
546 Sight Distance At Intersections (6 Sheets)  
560 Railroad Crossings

### TRAFFIC CONTROL THROUGH WORK ZONES

600 General Information For Traffic Control Through Work Zones (13 Sheets)  
601 Two-Lane Two-Way, Work Outside Shoulder  
602 Two-Lane Two-Way, Work On Shoulder  
603 Two-Lane Two-Way, Work Within The Travel Way (2 Sheets)  
604 Two-Lane Two-Way, Work In Intersection  
605 Two-Lane Two-Way, Work Near Intersection  
606 Two-Lane Two-Way, Work Within The Travel Way—Signal Control (4 Sheets)  
607 Two-Lane Two-Way, Mobile Operation, Work On Shoulder And Work Within The Travel Way  
608 Two-Lane Two-Way, Temporary Diversion Connection  
611 Multilane, Work Outside Shoulder  
612 Multilane, Work On Shoulder  
613 Multilane, Work Within The Travel Way—Median Or Outside Lane (2 Sheets)  
614 Multilane, Work Within The Travel Way—Center Lane (2 Sheets)  
615 Multilane, Work In Intersection

## TABLE OF CONTENTS

### TRAFFIC CONTROL THROUGH WORK ZONES (CONT.)

|     |  |
|-----|--|
| 616 | Multilane, Work Near Intersection-Median Or Outside Lane (3 Sheets)              |
| 617 | Multilane, Work In Intersection-Center Lane                                      |
| 618 | Multilane, Work In Intersection-Two Lanes Closed-45 MPH Or Less                  |
| 619 | Multilane, Mobile Operations Work On Shoulder, Work Within Travel Way            |
| 620 | Multilane Divided, Temporary Diversion Connection (2 Sheets)                     |
| 621 | Multilane Undivided, Temporary Diversion Connection                              |
| 622 | Multilane, Work Near Intersection-Temporary Diversion Connection -35 MPH or Less |
| 625 | Temporary Road Closure-5 Minutes Or Less   |
| 628 | Two Way Left Turn Lane Closure   |
| 630 | Crossover For Paving Train Operations, Rural (2 Sheets)                          |
| 631 | Temporary Crossover (2 Sheets)   |
| 635 | Work In Vicinity Of Railroad Crossing  |
| 640 | Converting Two-Lanes To Four-Lanes Divided, Rural (2 Sheets)                     |
| 641 | Converting Two-Lanes To Four-Lanes Divided, Urban (3 Sheets)                     |
| 642 | Transitions For Temporary Concrete Barrier Wall On Freeway Facilities            |
| 650 | Two-Lane Two-Way, Rural Structure Replacement (2 Sheets)                         |
| 651 | Multilane Divided, Maintenance And Construction (2 Sheets)                       |
| 655 | Traffic Pacing (3 Sheets)  |
| 660 | Pedestrian Control For Closure Of Sidewalks                                      |
| 665 | Limited Access, Temporary Opening  |
| 667 | Toll Plaza, Traffic Control Standards (6 Sheets)                                 |
| 670 | Motorist Awareness System  |

### ROADSIDE OFFSETS

|     |                             |
|-----|-----------------------------|
| 700 | Roadside Offsets (2 Sheets) |
|-----|-----------------------------|

### FENCING AND PEDESTRIAN RAILINGS

|     |  |
|-----|--|
| 800 | Fence Location (2 Sheets)  |
| 801 | Fence-Type A (3 Sheets)  |
| 802 | Fence-Type B (3 Sheets)  |
| 803 | Cantilever Slide Gate-Type B Fence   |
| 810 | Bridge Fencing (Vertical) (4 Sheets)   |
| 811 | Bridge Fencing (Curved Top) (3 Sheets)                                       |
| 812 | Bridge Fencing (Enclosed) (4 Sheets)   |
| 820 | Pedestrian/Bicycle Railing   |
| 821 | Aluminum Pedestrian/Bicycle Bullet Railing For Traffic Railing (32" F Shape) |
| 822 | Aluminum Pedestrian/Bicycle Bullet Railing Details (2 Sheets)                |
| 850 | Steel Pedestrian/Bicycle Picket Railing (5 Sheets)                           |
| 851 | Bridge Pedestrian/Bicycle Picket Railing (Steel) (2 Sheets)                  |
| 860 | Aluminum Pedestrian/Bicycle Picket Railing (5 Sheets)                        |
| 861 | Bridge Pedestrian/Bicycle Picket Railing (Aluminum) (2 Sheets)               |
| 870 | Aluminum Pipe Guiderail (5 Sheets)   |
| 880 | Steel Pipe Guiderail (5 Sheets)  |

### WALL AND SOUND BARRIER SYSTEMS

|      |   |
|------|---|
| 5100 | Retaining Wall-Cast In Place (2 Sheets)                           |
| 5200 | Precast Sound Barriers-General Notes                              |
| 5201 | Precast Sound Barriers-Texture Options                            |
| 5202 | Precast Sound Barriers-Flush Panel Option (4 Sheets)              |
| 5203 | Precast Sound Barriers-Recessed Panel Option (5 Sheets)           |
| 5204 | Precast Sound Barriers-Fire Hose Access Hole & Drainage Details   |
| 5205 | Precast Sound Barriers-Pile and Post Reinforcing Steel (7 Sheets) |
| 5206 | Precast Sound Barriers-Pile Depth and Reinforcing Summary         |
| 5207 | Precast Sound Barriers-Precast Post Capital                       |
| 5210 | Traffic Railing/Sound Barrier (8'-0") (5 Sheets)                  |
| 5211 | Traffic Railing/Sound Barrier (14'-0") (3 Sheets)                 |
| 5212 | Traffic Railing/Sound Barrier (8'-0") Junction Slab (2 Sheets)    |
| 5213 | Traffic Railing/Sound Barrier T-Shape Spread Footing (2 Sheets)   |
| 5214 | Traffic Railing/Sound Barrier L-Shaped Spread Footing (4 Sheets)  |
| 5215 | Traffic Railing/Sound Barrier Trench Footing                      |
| 5300 | Permanent Retaining Wall Systems (19 Sheets)                      |
| 5301 | Temporary Retaining Wall Systems                                  |

### SIGNING AND MARKINGS

|       |  |
|-------|--|
| 11200 | Multi-Column Ground Sign (2 Sheets)                              |
| 11300 | Steel Overhead Sign Structures                                   |
| 11310 | Cantilever Sign Structure (5 Sheets)                             |
| 11320 | Span Sign Structure (5 Sheets)                                   |
| 11860 | Single Column Ground Signs (8 Sheets)                            |
| 13417 | Mounting Exit Numbering Panels To Highway Signs                  |
| 17302 | Typical Sections For Placement Of Single & Multi-Column Signs    |
| 17328 | Typical Signing For Truck Weigh & Inspection Stations (2 Sheets) |
| 17344 | School Signs & Markings (6 Sheets)                               |
| 17345 | Interchange Markings (4 Sheets)                                  |
| 17346 | Special Marking Areas (14 Sheets)                                |
| 17347 | Bicycle Markings (4 Sheets)                                      |
| 17349 | Traffic Controls For Street Terminations                         |
| 17350 | Signing For Motorist Services                                    |
| 17351 | Welcome Center Signing (2 Sheets)                                |
| 17352 | Typical Placement Of Reflective Pavement Markers (2 Sheets)      |
| 17355 | Special Sign Details (11 Sheets)                                 |
| 17356 | Span Wire Mounted Sign Details                                   |
| 17357 | Bridge Weight Restrictions                                       |
| 17359 | Rural Narrow Bridge Treatment (2 Sheets)                         |

### ROADWAY LIGHTING

|       |   |
|-------|---|
| 17500 | Conventional Lighting (3 Sheets)              |
| 17501 | Highway Lighting General Notes                |
| 17502 | Highmast Lighting (7 Sheets)                  |
| 17504 | Service Point Details                         |
| 17505 | External Lighting For Signs (2 Sheets)        |
| 17515 | Standard Roadway Aluminum Lighting (8 Sheets) |

### TRAFFIC SIGNAL AND EQUIPMENT

|       |  |
|-------|--|
| 17600 | Motorist Aid Call Box (3 Sheets)                                   |
| 17721 | Conduit Installation Details (2 Sheets)                            |
| 17723 | Steel Strain Pole (3 Sheets)                                       |
| 17725 | Concrete Poles (2 Sheets)  |
| 17727 | Signal Cable And Span Wire Installation Details (2 Sheets)         |
| 17733 | Aerial Interconnect  |
| 17736 | Electric Power Service   |
| 17743 | Standard Mast Arm Assemblies (3 Sheets)                            |
| 17745 | Mast Arm Assemblies (5 Sheets)                                     |
| 17748 | Free-Swinging, Internally-Illuminated Street Sign Assemblies       |
| 17749 | Damping Device For Miscellaneous Structures                        |
| 17764 | Pedestrian Control Signal Installation Details                     |
| 17781 | Vehicle Loop Installation Details (2 Sheets)                       |
| 17784 | Pedestrian Detector Assembly Installation Details (2 Sheets)       |
| 17841 | Cabinet Installation Details                                       |
| 17870 | Standard Signal Operating Plans (2 Sheets)                         |
| 17881 | Advance Warning For R/R Crossing                                   |
| 17882 | Railroad Grade Crossing Traffic Control Devices (4 Sheets)         |
| 17890 | Traffic Control Devices For Movable Span Bridge Signals (3 Sheets) |

### MISCELLANEOUS

|       |                                    |
|-------|------------------------------------|
| 17900 | Traffic Monitoring Site (7 Sheets) |
|-------|------------------------------------|

### ITS

|       |   |
|-------|---|
| 18100 | CCTV Pole Placement                           |
| 18101 | Typical CCTV Site                             |
| 18102 | CCTV Pole Grounding (2 Sheets)                |
| 18104 | CCTV Cabinet Equipment Layout                 |
| 18105 | CCTV Block Diagram                            |
| 18107 | Ground Mounted CCTV Cabinet                   |
| 18108 | Pole Mounted CCTV Cabinet                     |
| 18110 | Camera Mounting Details (2 Sheets)            |
| 18111 | Steel CCTV Pole (2 Sheets)                    |
| 18113 | Concrete CCTV Pole (2 Sheets)                 |
| 18202 | Fiber Optic Pullbox And Trench Details        |
| 18204 | Fiber Optic Splice Box And Pullbox            |
| 18300 | DMS Cabinet And Sign Wiring And Block Diagram |
| 18301 | DMS Cabinet Layout                            |
| 18302 | Typical DMS Mounting Details                  |
| 18303 | DMS Structures Details (2 Sheets)             |
| 18305 | DMS Grounding Details (2 Sheets)              |

## TABLE OF CONTENTS

### PRESTRESSED CONCRETE AASHTO BEAMS

- 20110 Typical AASHTO And Bulb-T Beam Details and Notes
- 20120 AASHTO Type II-Beam Standard Details
- 20130 AASHTO Type III Beam - Standard Details
- 20140 AASHTO Type IV Beam - Standard Details
- 20150 AASHTO Type V Beam - Standard Details
- 20160 AASHTO Type VI Beam - Standard Details
- 20172 Florida Bulb-T 72 Beam - Standard Details
- 20178 Florida Bulb-T 78 Beam - Standard Details
- 20199 Build-Up And Deflection Data For AASHTO And Bulb-T Beams

### PRESTRESSED CONCRETE FLORIDA U BEAMS (FUB)

- 20210 Typical Florida U Beam Details And Notes (2 Sheets)
- 20248 Florida U 48 Beam - Standard Details (3 Sheets)
- 20254 Florida U 54 Beam - Standard Details (3 Sheets)
- 20263 Florida U 63 Beam - Standard Details (3 Sheets)
- 20272 Florida U 72 Beam - Standard Details (3 Sheets)
- 20299 Build-Up And Deflection Data For Florida U Beams

### PRESTRESSED CONCRETE INVERTED-T BEAMS

- 20310 Typical Inverted-T Beam Details And Notes
- 20320 Inverted-T Beam Standard Details

### CONCRETE SHEET PILES

- 20400 Notes And Details For Precast Concrete Sheet Piles
- 20410 Precast Concrete Sheet Pile Type "A" - 10 Inch Thick
- 20412 Precast Concrete Sheet Pile Type "A" - 12 Inch Thick
- 20430 Precast Concrete Sheet Pile Type "B" - Variable Angle Corner Pile
- 20440 Precast Concrete Sheet Pile Type "C" - Right Angle Corner Pile

### BEARING PADS

- 20500 Composite Elastomeric Bearing Pads
- 20501 Beveled Bearing Plate Details-Prestressed AASHTO And Bulb-T Beams
- 20502 Beveled Bearing Plate Details-Florida U-Beams

### SQUARE AND ROUND CONCRETE PILES

- 20600 Notes And Details For Square Prestressed Concrete Piles
- 20601 Square Prestressed Concrete Pile Splices
- 20602 EDC Instrumentation For Square Prestressed Concrete Piles
- 20612 12" Square Prestressed Concrete Pile
- 20614 14" Square Prestressed Concrete Pile
- 20618 18" Square Prestressed Concrete Pile
- 20620 20" Square Prestressed Concrete Pile
- 20624 24" Square Prestressed Concrete Pile
- 20630 30" Square Prestressed Concrete Pile
- 20631 High Moment Capacity 30" Square Prestressed Concrete Pile
- 20654 54" Precast/Post-Tensioned Concrete Cylinder Pile (2 Sheets)
- 20660 60" Prestressed Concrete Cylinder Pile (2 Sheets)

### APPROACH SLABS

- 20900 Approach Slabs (Flexible Pavement Approaches) (2 Sheets)
- 20910 Approach Slabs (Rigid Pavement Approaches) (2 Sheets)

### BRIDGE EXPANSION JOINTS

- 21100 Strip Seal Expansion Joint (3 Sheets)
- 21110 Poured joint With Backer Rod Expansion Joint System (2 Sheets)

### STRUCTURES LIGHTING AND UTILITIES

- 21200 Light Pole Pilaster (2 Sheets)
- 21210 Utility Conduit Details (2 Sheets)
- 21220 Navigation Light System Details (Fixed Bridges) (2 Sheets)
- 21240 Maintenance Lighting For Box Girders (2 Sheets)

### STANDARD BAR BENDING DETAILS

- 21300 Standard Bar Bending Details

### TEMPORARY DETOUR BRIDGES

- 21600 Temporary Detour Bridge General Notes And Details (7 Sheets)
- 21610 Temporary Detour Bridge Details-Timber Pile Foundations (3 Sheets)
- 21620 Temporary Detour Bridge Details-Steel H Pile Foundations (2 Sheets)
- 21630 Temporary Detour Bridge Details-Steel Pipe Pile Foundations (3 Sheets)

### POST-TENSIONING DETAILS

- 21801 Post-Tensioning Vertical Profiles (2 Sheets)
- 21802 Post-Tensioning Anchorage Protection
- 21803 Post-Tensioning Anchorage And Grouting Details (3 Sheets)

### FENDER SYSTEMS DETAILS

- 21900 Fender System General Notes And Layout (2 Sheets)
- 21910 Fender System Heavy Duty (5 Sheets)
- 21920 Fender System Medium Duty (5 Sheets)
- 21930 Fender System Light Duty (5 Sheets)

**Revisions  
Design Standards 2010**

| Index Number | Sheet Number | Description  | Index Number | Sheet Number | Description   |
|--------------|--------------|--|--------------|--------------|---|
| 001          | 1 thru 3     | Added the following standard abbreviations:<br>B Base Line, Base Line Control<br>F Flow Line<br>GRI Geosynthetic Research Institute<br>HDPE High Density Polyethylene<br>NPS Nominal Pipe Size<br><br>Deleted the following standard abbreviations:<br>Bbl Barrel<br>FRCP Fiber Reinforced Concrete Pipe<br>FRP Fiber Reinforced Pipe<br>FS Far Side   | 233          | 1 thru 2     | Index was expanded due to font size change.   |
|              |              |  | 234          | 1 thru 2     | Index was expanded due to font size change.   |
|              |              |  |              | 2 of 2       | Under Pavement & Sodding detail changed "1/2" Exp. Joint" to "1/2" Preformed Joint Filler".   |
|              |              |  | 235          | 1 of 2       | "GENERAL NOTES", Note 3, deleted "Alternate B" replaced with "Index 200"; Note 8 changed "Specification Section 962" to "Specification Section 975".  |
|              |              |  | 245          | 1 of 1       | "GENERAL NOTES" Note 2, delete and replace with the following: "Concrete shall be Class I (Structural), except ASTM C478 (4000 psi) concrete may be substituted for precast items manufactured in plants meeting the requirements of Section 449 of the Specifications. Box shall be reinforced with No. 3 bars (Grade 60) on 8" centers both ways, sides and bottom. |
| 002          | 2 of 3       | Deleted Hand Drafting Symbols  | 250          | 1 of 2       | "GENERAL NOTES" Note 5, deleted and replaced with the following: "Concrete shall be Class I (Structural), except ASTM C478 (4000 psi) concrete may be substituted for precast items manufactured in plants meeting the requirements of Section 449 of the Specifications."  |
| 102          | 2 of 3       | NOTES FOR SYNTHETIC BALES OR BALE TYPE BARRIERS, Note 2, deleted the text "trenched 3" to 4" and" from the first sentence.   | 251          | 1 of 2       | "GENERAL NOTES" Note 4, deleted and replaced with the following: "Concrete shall be Class II, except ASTM C478 (4000 psi) concrete may be substituted for precast items manufactured in plants meeting the requirements of Section 449 of the Specifications."  |
| 104          | 2 of 2       | RURAL DIVIDED detail, changed "5' Shoulder Pavement" to "4' Shoulder Pavement".  | 252          | 1 of 2       | "GENERAL NOTES" Note 4, deleted and replaced with the following: "Concrete shall be Class II, except ASTM C478 (4000 psi) concrete may be substituted for precast items manufactured in plants meeting the requirements of Section 449 of the Specifications."  |
| 105          | 1 of 1       | TREATMENT I, Criteria for using Treatment I, replaced text of the last bullet with the following: "resurfacing build-up is less than 3" "  | 253          | 1 of 2       | "GENERAL NOTES" Note 4, deleted and replaced with the following: "Concrete shall be Class II, except ASTM C478 (4000 psi) concrete may be substituted for precast items manufactured in plants meeting the requirements of Section 449 of the Specifications."  |
| 200          | 1 of 5       | TOP SLAB REINFORCING STEEL DIAGRAM (ALTERNATE B) to the notes "2 Additional Bars A @ 5" O.C." and "2 Additional Bars B @ 5" Max. O.C. Each Side Of Opening", added "(Minimum #4 Bars)".  | 255          | 1 of 2       | "GENERAL NOTES" Note 4, deleted and replaced with the following: "Concrete shall be Class II, except ASTM C478 (4000 psi) concrete may be substituted for precast items manufactured in plants meeting the requirements of Section 449 of the Specifications."  |
|              | 2 of 5       | Note 9, Delete second sentence and substitute, "Additional bars used to restrain hole formers for precast structures with grouted pipe connections, may be left flush with the hole surface."  | 260          | 1 of 1       | "GENERAL NOTES" Note 3 changed "Specification Section 962" to "Specification Section 975".  |
|              | 4 of 5       | SLAB AND WALL DESIGN TABLE NOTES, added the following to the end of Note 10: "See Index No. 201, Sheet 4 for allowable bar spacing adjustments when larger areas of reinforcing are substituted."  | 261          | 1 of 3       | "GENERAL NOTES" Note 4 changed "Specification Section 962" to "Specification Section 975".  |
| 201          | 4 of 5       | "Revised title of notes to ""NOTES FOR PRECAST OPTIONS AND EQUIVALENT REINFORCEMENT SUBSTITUTION"" and added the following to Note 4, ""When an increased area of reinforcing is provided, then the maximum bar spacing may be increased by the squared ratio of increased steel area, but not to exceed 12 inches:<br>Max. Bar Spacing Provided < Max. Bar Spacing Required x (Steel Area Provided/Min. Steel Area Required) <sup>2</sup> " | 264          | 1 thru 2     | Index was expanded due to font size change. General note 3 changed.   |
| 205          | 1 of 6       | Changed maximum size of allowed PVC pipe to 36".   | 270          | 1 of 1       | "GENERAL NOTES" Note 2 changed "Specification Section 941-1.5" to "Specification Section 449". Changed Note 3.  |
|              | 2 of 6       | ROUND PIPE DIMENSIONS, deleted the column, "Wall Thickness (In.) Class III" and subcolumn "NRCHP" and heading "SRCP". Also deleted the ** note at the bottom of the table.   | 272          | 6 of 6       | Reordered "GENERAL NOTES" and changed "Class I concrete" to "Class NS concrete".  |
|              | 3 of 6       | NOTES: deleted note 4; table "PIPE ARCH: SPIRAL RIB: 3/4" x 3/4" x 7 1/2" RIB SPACING..." deleted references to note 4; table "ROUND PIPE - SPIRAL RIB", "Maximum Height of Fill (Ft.)", "Sheet Thickness In Inches (Gage)", "0.138 (10)" added measurements.  | 273          | 1 thru 7     | Index was expanded due to font size change.   |
| 210          | 1 of 1       | Delete General Note 4, and substitute the following: "For precast units the rear wall and apron may be precast as a separate piece from the top slab. Provide a minimum of 7 ~ #4 dowels in accordance with Index No. 201 "OPTIONAL CONSTRUCTION JOINTS".  |              | 7 of 7       | "GENERAL NOTES", Note 8, deleted "Class I concrete" and substituted "Class NS concrete".  |
| 211          | 1 thru 5     | Revised index completely 3 sheets added, Reinforcing configuration and C.I.P. details revised; precast and WWR details added. Changed Note 4 to allow 4'-0" round risers.  | 280          | 1 thru 3     | Index was expanded due to font size change.   |
| 213          | 1 of 1       | In PLAN view changed "1/2" Exp. Joint (Typ)" to "1/2" Preformed Joint Filler (Typ)".   |              | 1 of 3       | "DISSIMILAR TYPES CONCRETE JACKET FOR CONNECTING DISSIMILAR TYPES OF PIPE AND CONCRETE PIPES WITH DISSIMILAR JOINTS" detail, added the note, "Alternate connection must be approved by the State Drainage Engineer."  |
| 218          | 2 of 2       | "STEEL GRATE", "TOP VIEW", for the overall dimension on the left side of the grate, inserted "44 1/4" ". For the small dimension at the upper left corner of the grate, inserted "3 1/2" ".  | 282          | 1 thru 3     | Index was expanded due to font size change.   |
| 219          | 1 of 2       | In PLAN view and Section HH changed "Expansion Joint (Typ)" and "Expansion Material Joint" to "1/2" Preformed Joint Filler (Typ)".   |              | 1 of 3       | "FRONT ELEVATION" and "SECTION AA" details changed "1/2" Exp. Matl. " to "1/2" Preformed Joint Filler".   |
| 220          | 1 of 3       | "GUTTER INLET TYPE S", "SECTION BB", Changed the vertical dimension between the top of the inlet and the grate elevation from "5 1/2" to "4 1/2" ".<br><br>"SECTION AA", at the top right corner, for precast thickness changed " 6" " to " 3" " (same as left side).<br><br>"SECTION BB", at the top, changed "3'-11" Precast" to " 4'-3" Precast". "PLAN", at the top, changed " 3'-11" Precast to " 4'-3" Precast".                       | 284          | 2 of 3       | "PLAN" and "SECTION AA" details changed "1/2" Exp. Matl. " to "1/2" Preformed Joint Filler".  |
|              |              |  | 287          | 1 of 1       | Deleted note "1" and substituted the following: "1. Spillway to be paid for as Shoulder Gutter, LF." Deleted note "2", and substituted the following: "2. If spillway empties into an unpaved ditch the detail should be modified as necessary."  |
|              |              |  | 288          | 1 thru 4     | Sheet 3 is new. Renumbered other sheets.  |
|              |              |  | 289          | 1 of 4       | Changed all 3 occurrences of "Class I concrete" to "Class NS concrete".   |
| 230          | 1 of 2       | In "PLAN" view changed "1/2" Exp. Joint (typ)" to "1/2" Preformed Joint Filler (Typ)". Section E-E, Changed 4Z15.9 shape to built up section (3.5 x 3 x 1/2 L + 1/2 x 3 Bar) for grating.  | 288          | 1 of 1       | New Index added "DEEP WELL INJECTION BDX".  |
| 231          | 1 of 3       | "DITCH BOTTOM INLET TYPE B", "SECTION BB", upper left side, deleted the dimension "2'-6" (Min.)" and replaced with "1'-10" (Min.)".  | 289          | 6 of 7       | Changed "FLARED ENDWALL" to "FLARED WINGWALL" and "STRAIGHT ENDWALL" to "STRAIGHT WINGWALL".  |
| 232          | 1 thru 7     | Index was expanded due to font size change.  | 291          | 1 of 5       | Changed "Class I Concrete" to "Class NS".   |
|              |              |  |              | 5 of 5       | Changed "Bond Beam" to "Link Slab", and "Class I Concrete" to "Class NS".   |
|              |              |  | 292          | 2 of 14      | "GENERAL NOTES" note 1, changed AASHTO LRFD Bridge Specifications, to "4th Edition"; added note 10.   |



**Revisions  
Design Standards 2010**

| Index Number | Sheet Number | Description  | Index Number | Sheet Number | Description  |
|--------------|--------------|--|--------------|--------------|--|
| 295          | 1 of 1       | "GENERAL NOTES" Note 2 changed "Specification Section 962" to "Specification Section 975".   | 421          | 1 of 3       | Changed REFLECTIVE RAILING MARKERS note, "Reflective Railing Markers shall meet Specification Section 993. Install markers on top of the Traffic Railing along the centerline at the spacing shown in the table above. Reflector color (white or yellow) shall match the color of the near edgeline. The cost of the reflective markers shall be included in the Contract Unit Price for the Traffic Railing."   |
| 300          | 1 thru 2     | Index was expanded due to change in font.  |              |              |  |
| 304          | 6 of 6       | Added alternate location of detectable warnings on linear ramps. Added note "On curb ramps, landings and flush transitions perpendicular to the curb line: Rows of domes shall be aligned with the centerline of the ramp. (See Pictorial View A)" at top of sheet. Added Rail Road Crossing PLAN view.  | 422          | 1 of 3       | Added the following to the NAME, DATE AND BRIDGE NUMBER note: "The Name shall be as shown in the General Notes in the Structures Plans."; Changed REFLECTIVE RAILING MARKERS note.   |
| 305          | 1 & 4 of 4   | Deleted bar spacing table and revised notes (Sheet 1); Changed width of outside lanes (Sheet 4).   |              |              | Changed REFLECTIVE RAILING MARKERS note, "Reflective Railing Markers shall meet Specification Section 993. Install markers on top of the Traffic Railing 2" from the face on the traffic side at the spacing shown in the table above. Reflector color (white or yellow) shall match the color of the near edgeline. The cost of the reflective markers shall be included in the Contract Unit Price for the Traffic Railing."   |
| 307          | 2 of 3       | "UTILITY CONFLICT PIPES THRU STORM SEWER STRUCTURES" changed to "UTILITY CONFLICT PIPES THRU STORM DRAIN STRUCTURES"   |              |              |  |
| 310          | 1 of 2       | "SIDEWALK WITH EDGE BEAM FOR SURFACE MOUNTED RAILINGS", "Clear Width", deleted "3' Min." and substituted "4' Min. *".  | 423          | 1 of 3       | Added the following to the NAME, DATE AND BRIDGE NUMBER note: "The Name shall be as shown in the General Notes in the Structures Plans."; Bicycle Railing to "Special Height Bicycle Railing" and Post "B" to Post "B1".   |
|              |              | "NOTES FOR CONCRETE SIDEWALK ON CURBED ROADWAYS", deleted "Note 1", and substituted the following: "1. Sidewalks shall be constructed in accordance with Section 522 of the FDOT Standard Specifications. Public sidewalk curb ramps shall include detectable warnings and be constructed in accordance with Index No. 304. Detectable warnings are not required where sidewalks intersect urban flared turnouts."   |              |              | "TRAFFIC RAILING-(32" VERTICAL SHAPE)", deleted the "REFLECTIVE RAILING MARKERS" note and substituted the following: "Reflective Railing Markers shall meet Specification Section 993. Install markers on top of the Traffic Railing 2" from the face on the traffic side at the spacing shown in the table above. Reflector color (white or yellow) shall match the color of the near edgeline. The cost of the reflective markers shall be included in the Contract Unit Price for the Traffic Railing."   |
|              |              | "Note 3" , deleted.  |              | 2 of 3       | Changed Bicycle Railing to "Special Height Bicycle Railing" and Post "B" to Post "B1".   |
|              | 2 of 2       | "NOTES FOR CONCRETE SIDEWALKS ON UNCURBED ROADWAYS", Changed Note 2 to "Provide detectable warnings that extend the fullwidth of the sidewalk and 24" deep from the edge of pavement where sidewalks adjoin the following vehicular ways:<br>side roads and streets<br>driveways with signalized entrances<br>driveways with entrance volumes greater than 600 vpd<br>driveways with entrance speeds of 25 mph or greater<br>right in - right out composite driveways. |              | 3 of 3       | Changed 83 degrees to 93 degrees in CONVENTIONAL REINFORCING STEEL BENDING DIAGRAM Cross-slope table.  |
| 400          | 1 thru 26    | Index expanded by one sheet due to font size change and added new sheet 2, "APPROACH END ANCHORAGE DETAILS", Index renumbered.   | 424          | 1 of 7       | Added the following to the NAME, DATE AND BRIDGE NUMBER note: "The Name shall be as shown in the General Notes in the Structures Plans."   |
|              | 1 of 26      | "GENERAL NOTES" Note 17 changed "Specification Section 971" to "Specification Section 975".  | 425          | 1 of 3       | "TRAFFIC RAILING - (CORRAL SHAPE)", deleted the "REFLECTIVE RAILING MARKERS" note and substituted the following: "Reflective Railing Markers shall meet Specification Section 993. Install markers on top of the Traffic Railing 2" from the face on the traffic side at the spacing shown in the table above. Reflector color (white or yellow) shall match the color of the near edgeline. The cost of the reflective markers shall be included in the Contract Unit Price for the Traffic Railing."   |
|              | 2 of 26      | New sheet added showing limits of pay for guardrail, details of shoulder treatment and miscellaneous asphalt for guardrail approach end treatments.  |              |              | Added the following to the NAME, DATE AND BRIDGE NUMBER note: "The Name shall be as shown in the General Notes in the Structures Plans."   |
|              | 3 of 26      | Corrected spelling of guardrail in last paragraph.   |              |              | "TRAFFIC RAILING - (42" F SHAPE)", added the following note: "REFLECTIVE RAILING MARKERS: Reflective Railing Markers shall meet Specification Section 993. Install markers on top of the Traffic Railing 2" from the face on the traffic side at the spacing shown in the table above. Reflector color (white or yellow) shall match the color of the near edgeline. The cost of the reflective markers shall be included in the Contract Unit Price for the Traffic Railing."   |
|              | 15 of 26     | "LOCATIONS ON FRONT SLOPES", deleted the details for guardrail on slope and rubrail termination and the chart for lateral placement on slopes. (See sheet 26)  |              |              |  |
|              | 16 of 26     | Deleted "REFLECTORS- DETAIL M" (See sheet 17)  |              |              |  |
|              | 26 of 26     | Added "GUARDRAIL ON SLOPES", details for guardrail on slope and rubrail termination and the chart for lateral placement on slopes.   | 470          | 1 of 3       | Added Field testing proof loads to the ADHESIVE BONDED ANCHORS AND DWELS note; "TRAFFIC RAILING-(THRIE BEAM RETROFIT) GENERAL NOTES & DETAILS", deleted the "BRIDGE NAME PLATE" note and substituted the following: "If a portion of the existing Traffic Railing is to be removed that carries the bridge name, number and or date, or if the installation of the Traffic Railing (Thrie Beam Retrofit) will obscure the bridge name, number and or date, then replace the information that has been removed or obscured, with 3" tall black lettering on white nonreflective sheeting applied to the top of the adjacent guardrail. The information must be clearly visible from the right side of the approaching travel lane. The sheeting and adhesive backing shall comply with Specification Section 994 and may comprise of individual decals of letters and numbers." |
| 410          | 1 thru 25    | Index completely revised and reorganized.  |              |              |  |
| 411          | 2 of 10      | Changed tangent offsets In Detail 'A' to "2.49'-Design Speed ≤45 mph; 1.76' - Design Speed ≥50 mph".   |              |              |  |
|              | 4 of 10      | Changed tangent offsets In Detail 'B' to "2.49'-Design Speed ≤45 mph; 1.76' - Design Speed ≥50 mph".   |              |              |  |
| 414          | 1 of 15      | Updated Specification reference Section 971 to 975; Added steel option to ALTERNATE DESIGN note.   |              |              |  |
|              | 5 of 15      | Added PTFE tape option to anchor bolt details.   |              |              |  |
| 415          | 4 of 10      | "NOTES FOR WALL END SHIELDING", Note 1, changed the second sentence to: "Except where the plans designate a particular type crash cushion for a specific location, the contractor has the option to construct any of the redirective crash cushions listed on the Qualified Products List, subject to the uses and limitations described on their respective drawings."  |              | 3 of 3       | Added the following note: "NEOPRENE PADS: Neoprene pads must be plain pads with a durometer hardness of 60 or 70 and meet the requirements of Specification Section 932, except that testing of the finished pad will not be required."  |
|              |              | "ANCHOR PLATE BDLTS", upper note, changed "?" to "3/4".  | 471          | 2 of 4       | Changed offset of 7/8" dia. anchor bolts to 2 3/4" from back edge of base plate in SECTION B-B.  |
| 420          | 1 of 3       | Added the following to the NAME, DATE AND BRIDGE NUMBER note: "The Name shall be as shown in the General Notes in the Structures Plans."; Changed REFLECTIVE RAILING MARKERS note.   | 472          | 2 of 4       | "SECTION A-A" and "SECTION B-B", changed "Resilient Pad" to "Neoprene Pad".  |
|              |              | Changed REFLECTIVE RAILING MARKERS note, "Reflective Railing Markers shall meet Specification Section 993. Install markers on top of the Traffic Railing 2" from the face on the traffic side at the spacing shown in the table above. Reflector color (white or yellow) shall match the color of the near edgeline. The cost of the reflective markers shall be included in the Contract Unit Price for the Traffic Railing."   | 473          | 2 of 4       | "SECTION A-A" and "SECTION B-B", changed "Resilient Pad" to "Neoprene Pad".  |
|              |              |  | 474          | 2 of 4       | "SECTION A-A" and "SECTION B-B", changed "Resilient Pad" to "Neoprene Pad".  |
|              |              |  |              | 4 of 4       | "SECTION C-C", changed "Resilient Pad" to "Neoprene Pad".  |

**Revisions  
Design Standards 2010**

| Index Number | Sheet Number | Description  | Index Number | Sheet Number | Description  |
|--------------|--------------|--|--------------|--------------|--|
| 475          | 2 of 4       | "SECTION A-A" and "SECTION B-B", changed "Resilient Pad" to "Neoprene Pad".  | 600          | 3 of 13      | LANE WIDTHS, in the second sentence, change the word "expected" to "excepted".   |
| 476          | 2 of 4       | "SECTION A-A" and "SECTION B-B", changed "Resilient Pad" to "Neoprene Pad".  |              | 5 of 13      | Changed note under "SIGN COVERING AND INTERMITTENT WORK STOPPAGE SIGNING"; added information for the use of the new "PROJECT INFORMATION SIGN".  |
| 480          | 1 of 2       | "TRAFFIC RAILING-(VERTICAL FACE RETROFIT) GENERAL NOTES & DETAILS", added the following to the "ADHESIVE-BONDED ANCHORS AND DOWELS" note, "The field testing proof loads required by Specification Section 416 shall be 23,800 lbs. for Dowel Bars 6D on the inside face (traffic side) of the railing (1'-0" embedment) and 18,500 lbs for Dowel Bars 6D along the outside face of the traffic railing (5" min. embedment)." Added NEOPRENE PADS note.<br><br>Also deleted the "REFLECTIVE RAILING MARKERS" note and substituted the following: "Reflective Railing Markers shall meet Specification Section 993. Install markers on top of the Traffic Railing 2" from the face on the traffic side at the spacing shown in the table below. Reflector color (white or yellow) shall match the color of the near edgeline."  |              | 6 of 13      | GENERAL NOTES, deleted note 1, substituted the following:<br>"1. All signs shall be post mounted when work operations exceed one day except for:<br>a) Road closure signs mounted in accordance with the vendor drawing for the Type III Barricade shown on the QPL.<br>b) Pedestrian advanced warning or regulatory signs mounted on sign supports shown on the QPL."<br><br>"2. POST SIGN SUPPORT MOUNTING DETAILS", updated text to include a tolerance between sign supports. Insert "+/- 3" " after "1'-6" " and insert "+/- 6" " after "2'-6" ". |
|              | 2 of 2       | CONVENTIONAL REINFORCING STEEL BENDING DIAGRAM, added Bars 5E, 5F and 4G for Index No. 484   |              |              | POST AND FOUNDATION TABLE FOR WORK ZONE SIGNS, expanded Note 2 by adding: "unless otherwise specified in the vendor drawing on the QPL."   |
| 484          | 1-10 of 10   | New Index added TRAFFIC RAILING (VERTICAL FACE RETROFIT) SPREAD FOOTING APPROACH   |              |              | POST MOUNTED SIGN NOTES, added new notes 1 and 12.   |
| 500          | 2 of 2       | "HALF SECTION" detail, deleted "Storm Sewer Mains" replaced with "Storm Drain Trunk Lines"   |              | 7 of 13      | Added new sheet showing Project Information Sign and renumbered index.   |
| 501          | 3-9 of 9     | Changed the REQUIRED TEST METHOD for Burst Strength, Soil-Geosynthetic Friction, Creep Reduction Factor & Joint Overlap to ASTM D 6706.  | 605          | 1 of 1       | "GENERAL NOTES", deleted the text of "Note 8" and substituted the following: "The two channelizing devices directly in front and directly at the end of the work area may be omitted provided vehicles in the work area have high intensity rotating, flashing, oscillating or strobe lights operating."   |
|              | 4 of 9       | Updated values for COMTRAC 70.70; Deleted AMOCD 2006, 2016 & 2044; Added GEOTEX 315ST, 2x2HF, 4x4, 3x3HF, 4x4HF & 4x6 woven geogrids.  |              |              | Added new heading "DURATION NOTE" and placed the following note under this heading:<br>1. ROAD WORK AHEAD sign may be omitted if all of the following conditions are met:<br>a) Work operations are 60 minutes or less.<br>b) Speed is 45 mph or less.<br>c) No sight obstructions to vehicles approaching the work area for a distance of 600 feet.<br>d) Vehicles in the work area have high-intensity, rotating, flashing, oscillating, or strobe lights operating.<br>e) Volume and complexity of the roadway has been considered.                 |
|              | 5 of 9       | Changed Joint Strength Overlap value to 1.2 for all Marafi products.   |              |              |  |
|              | 6 of 9       | Deleted Application Usage 3 & 4 for SYNTEN SF 11 & SF 12.  |              |              |  |
|              | 7 of 9       | Added Fornir 20  |              |              |  |
|              | 8 of 9       | Changed Creep Resistance and Creep Reduction Factors for TENSAR BX 1120, BX 1200, BX 1220 & BX 1500  |              |              |  |
|              | 9 of 9       | Updated values for TENAX MS 220 & TENAX MS 330. Added Combigrid 30/30, Secugrid 20/20 & 30/30 extruded geogrids.   | 625          | 1 of 1       | New Index added "TEMPORARY ROAD CLOSURE- 5 MINUTES OR LESS".   |
| 505          | 1-4 of 4     | Sheet 3 is new. Renumbered other sheets.   | 655          | 1-3 of 3     | New Index added "TRAFFIC PACING-LIMITED ACCESS".   |
| 515          | 5 of 7       | In second symbolized note changed "Section 102-6" to "Section 102-8".  | 667          | 1-6 of 6     | New Index added "TOLL PLAZAS".   |
|              | 6 of 7       | "PAVEMENT STRUCTURE FOR TURNOUTS AND AUXILIARY LANES TABLE 515-1", "NOTES", Note 5, Deleted "Class I concrete" substituted "Class NS concrete".  | 801          | 1 of 3       | "GENERAL NOTES", Note 15 and 21, deleted "Class I" and substituted "Class NS".   |
| 518          | 3 of 3       | Revised width of rigid pavement outside travellane and changed location of rumble strip.   | 802          | 1-3 of 3     | Added tolerance to ground clearance; revised Notes 7a and 7b; rearranged sheets.   |
| 520          | 1 of 1       | "GENERAL NOTES", Note 7, Deleted "Class I Concrete (Retaining Walls)" and substituted "Class NS Concrete"  |              | 1 of 3       | "GENERAL NOTES", Note 6 and 13, deleted "Class I concrete" and substituted "Class NS concrete" for all occurrences.  |
| 546          | 1 of 6       | Added detail "PLAN", "PICTORIAL" and ** note. Index sheets reordered.  | 803          | 1 of 1       | "GENERAL NOTES", Note 4, deleted both occurrences of "Class I" and substituted "Class NS".   |
|              | 5 of 6       | Under "NOTES FOR 4-LANE DIVIDED ROADWAY", Note 1, changed reference from "Sheet 6" to "Sheet 2".   | 810          | 2 of 4       | Deleted "Section 971" and substituted "Section 975" in ANCHOR RODS, NUTS AND WASHERS note.   |
| 600          | 2 of 13      | OVERHEAD WORK, deleted "OPTION 4 - - -" and substituted the following:<br>OPTION 4 (OVERHEAD WORK MAINTAINING TRAFFIC WITH NO ENCROACHMENT BELOW THE OVERHEAD WORK AREA) Traffic shall be detoured, shifted, diverted or paced as to not encroach in the area directly below the overhead work operations in accordance with the appropriate standard index drawing or detailed in the plans. This option applies to, but not limited to, the following construction activities:<br>(a) Beam, girder and segment placement.<br>(b) Deck form placement and removal.<br>(c) Concrete deck placement.<br>(d) Railing construction located at edge of deck.<br>(e) Structure demolition.<br><br>DEFINITIONS, added the following after definition of TRAVEL WAY:<br>a. Travel Lane: The designated widths of roadway pavement marked to carry through traffic and to separate it from opposing traffic or traffic occupying other lanes.<br>b. Auxiliary Lane: The designated widths of roadway pavement marked to separate speed change, turning, passing and climbing maneuvers from through traffic.<br><br>CLEAR ZONE WIDTHS FOR WORK ZONES, deleted the text "travel" in the first sentence and substituted "traffic".<br><br>Replaced chart "CLEAR ZONE WIDTHS FOR WORK ZONES". | 811          | 3 of 3       | Deleted "Section 971" and substituted "Section 975" in ANCHOR RODS, NUTS AND WASHERS note.   |
|              |              |  | 812          | 2 of 4       | Deleted "Section 971" and substituted "Section 975" in ANCHOR RODS, NUTS AND WASHERS note.   |
|              |              |  | 820          | 1 of 1       | Changed Top Rail to "Special Height Bicycle Railing" and added new Post "B2" for 3'-6" height Pedestrian/Bicycle Railing.  |
|              |              |  | 821          | 1 of 1       | Changed designation of 4'-6" tall railing to "Special Height Bicycle Railing" and added 3'-6" tall Pedestrian/Bicycle Railing.   |
|              |              |  | 822          | 1 of 2       | Changed designation of 4'-6" tall railing to "Special Height Bicycle Railing" and "Post B" to "Post B1"; Added "Post B2" details.  |
|              |              |  | 850          | 1 of 5       | Changed "Pedestrian Railing" to "Pedestrian/Bicycle Railing" and "Bicycle Railing" to "Special Height Bicycle Railing"; Added anchor bolt requirements to SHOP DRAWINGS note.  |
|              |              |  |              | 2 of 5       | Added "DETAIL FOR NON-CONTINUOUS RAILING AT CORNERS" detail. Changed Pedestrian and Bicycle Railing designation; maximum ramp length for slopes less than 6.25%; and minimum clear picket opening at post to 3/4".   |
|              |              |  |              | 3 of 5       | Changed Pedestrian and Bicycle Railing designation.  |
|              |              |  |              | 4 of 5       | Added requirement for set screw to be set flush against outside face of rail and 18-8 Alloy option in DETAILS "D" & "E", option to notch post in SECTION G-G, and 1/4" joint tolerance in DETAIL "D".  |
|              |              |  |              | 5 of 5       | Added DETAIL "F" and note (*) to ANCHOR BOLT TABLE. Changed Pedestrian and Bicycle Railing designation. Corrected height dimension on steps to top of nosing.  |

**Revisions  
Design Standards 2010**

| Index Number | Sheet Number | Description  | Index Number | Sheet Number     | Description  |
|--------------|--------------|--|--------------|------------------|--|
| 851          | 1 of 2       | Changed Pedestrian and Bicycle Railing designation.  | 5204         | 1 of 1           | Changed "Ribbed" to "Slotted" in PLUG DETAIL.  |
|              | 2 of 2       | Added requirement for set screw to be set flush against outside face of rail and 18-8 Alloy option in DETAIL "B". Changed field splice joint tolerance to 1/4" in DETAIL "B".  | 5205         | 1, 3, 4 & 6 of 7 | Added note in Elevation Views to 'Extend post 2" above high side wall panel when post caps are shown in the plans'.  |
| 860          | 1 of 5       | Changed "Pedestrian Railing" to "Pedestrian/Bicycle Railing" and "Bicycle Railing" to "Special Height Bicycle Railing"; Added anchor bolt requirements to SHOP DRAWINGS note. Added filler metal ER4043 to WELDING note.   |              | 2 of 7           | Added tolerance between Top of Precast Collar and Auger Cast Pile; Changed "Composite Bearing Pads" to "Fiber Reinforced Bearing Pads".  |
|              | 2 of 5       | Added "DETAIL FOR NON-CONTINUOUS RAILING AT CORNERS" detail. Changed Pedestrian and Bicycle Railing designation; maximum ramp length for slopes less than 6.25%; and minimum clear picket opening at post to 3/4".   |              | 5 of 7           | Changed "Composite Bearing Pads" to "Fiber Reinforced Bearing Pads".   |
|              | 3 of 5       | Changed Pedestrian and Bicycle Railing designation.  | 5206         | 7 of 7           | Added "Octagonal Precast Collar" details and tolerance between Top of Precast Collar and Auger Cast Pile; Changed "Composite Bearing Pads" to "Fiber Reinforced Bearing Pads".   |
|              | 4 of 5       | Added requirement for set screw to be set flush against outside face of rail and 18-8 Alloy option in DETAILS "D" & "E"; option to notch post in SECTION G-G; 1/4" joint tolerance in DETAIL "D"; Type B (Nonwelded) connection detail in SECTION A-A. Changed Expansion Joint sleeve embedded length to 10" in DETAIL "D" and picket fillet weld size to 1/8", handrail and top rail fillet weld size to 1/4", and base plate fillet weld size to 3/8". | 5207         | 1 of 1           | Added "POST LENGTH WITH CAP" column, BARS D, P5 thru P8 to table and bar bending details for corner posts.   |
|              | 5 of 5       | Added DETAIL "F" and note (*) to ANCHOR BOLT TABLE. Changed Pedestrian and Bicycle Railing designation. Corrected height dimension on steps to top of nosing.  | 5210         | 1 of 1           | New Index added "PRECAST SOUND BARRIERS-PRECAST POST CAPITAL".   |
| 861          | 1 of 2       | Changed designation of 54" tall railing to "Special Height Bicycle Railing".   | 5211         | 2 of 5           | Changed NAME, DATE AND BRIDGE NUMBER note, and "Ribbed" to "Slotted" in NEOPRENE DIAPHRAGM PLUG DETAIL. Added REFLECTIVE RAILING MARKERS note and SELECTIVE RAILING MARKER SPACING table.  |
|              | 2 of 2       | Added requirement for set screw to be set flush against outside face of rail and 18-8 Alloy option in DETAIL "B". Changed field splice joint tolerance to 1/4" and "Steel Sleeve" to "Aluminum Sleeve" in DETAIL "B".  | 5212         | 3 of 3           | Changed "Ribbed" to "Slotted" in NEOPRENE DIAPHRAGM PLUG DETAIL. Corrected Anchor Pin diameter on FIRE HOSE ACCESS DETAIL.   |
| 870          | 1 of 5       | Deleted Pedestrian and Bicycle designations from DESIGN LIVE LOADS and ALTERNATE DESIGN notes.   | 5300         | 2 of 2           | Added note for "Full Depth Structural Asphalt" above junction slab and changed coping dimension to 6" Min.   |
|              | 2 of 5       | Deleted 4'-6" Bicycle Railing option and "*" note. Changed maximum ramp length for slopes less than 6.25%.   |              | 3 of 19          | Increased max. gap at back of precast coping and added timber blocking.  |
|              | 3 of 5       | Deleted 4'-6" Bicycle Railing option.  |              | 6 of 19          | Added note for "Full Depth Structural Asphalt" above junction slab and increased max. gap at back of precast coping.   |
|              | 4 of 5       | Added requirement for set screw to be set flush against outside face of rail and 18-8 Alloy option in DETAILS "D" & "E"; and 1/4" joint tolerance in DETAIL "D". Deleted Intermediate Rails from DETAILS "B" and "C".  | 11200        | 7 of 19          | Added note for "Full Depth Structural Asphalt" above junction slab.  |
|              | 5 of 5       | Added DETAIL "F". Deleted 4'-6" Bicycle Railing option. Corrected height dimension on steps to top of nosing.  |              | 12 & 15 of 19    | Increased max. gap at back of precast coping. Corrected size of Bar 5U1 in BILL OF REINFORCING TABLE   |
| 880          | 1 of 5       | Deleted Pedestrian and Bicycle designations from DESIGN LIVE LOADS and ALTERNATE DESIGN notes.   | 11200        | 1-2 of 2         | Deleted sheet 2  |
|              | 2 of 5       | Deleted 4'-6" Bicycle Railing option and "*" note. Changed maximum ramp length for slopes less than 6.25%.   |              | 1 of 2           | Revised and rearranged notes, sheet renumbered to 1 of 2.  |
|              | 3 of 5       | Deleted 4'-6" Bicycle Railing option.  | 11300        | 2 of 2           | Renumbered sheet 3 of 3 to sheet 2 of 2 revised and rearranged notes. Deleted "Class 1 (Special) Concrete" replaced with "Class 1 Concrete".   |
|              | 4 of 5       | Added requirement for set screw to be set flush against outside face of rail and 18-8 Alloy option in DETAILS "D" & "E"; and 1/4" joint tolerance in DETAIL "D". Deleted Intermediate Rails from DETAILS "B" and "C".  | 11310        | 1 of 1           | Hanger table values revised; connection bolt size revised; sign depth for horizontal splice changed to 10'. U-Bolt material spec (A325) added to Typical Detail of Sign & Truss Connection.  |
|              | 5 of 5       | Added DETAIL "F". Deleted 4'-6" Bicycle Railing option. Corrected height dimension on steps to top of nosing.  | 11320        | 1 of 5           | Deleted A307 bolts and Palnut (Note 4e). Changed foundation concrete (Note 7). Changed to 1/2" mesh (Note 9). Deleted grout pad and notes (former Notes 7c & 9). Added CSL tube note (Note 14).  |
| 5100         | 2 of 2       | Changed to plastic sleeve expansion joint and "Premoulded Expansion Material" to "Preformed Joint Filler". Changed wall and expansion joint key.   |              | 2 of 5           | Changed foundation standoff distance and changed drilled shaft detail. Deleted grout pad and added wire screen. Added CSL tubes. Changed FC & FL reinforcing.  |
| 5200         | 1 of 1       | Post caps added to note C.1.b; Changed note K.2 to allow 8 ft height panels. Added note K.11; Changed notes H.1, H.2 and D.2; Deleted note H.3.  | 11860        | 5 of 5           | Changed bolt spacing connection details.   |
| 5201         | 1 of 1       | Texture Type "I" (Cut Coral Block) added.  |              | 2 of 5           | Changed foundation standoff distance. Deleted grout pad and added wire screen.   |
| 5202         | 1 of 4       | Added precast post cap; Changed clearance tolerance on stepped panel and Neoprene Pad options.   |              | 4 of 5           | Changed bolt spacing connection details.   |
|              | 3 of 4       | Changed #4 Bar Mark to Bars P5 and P6 for Pile/Post Options A, B, & E; changed Texture Thickness to 1 1/4" Max.  |              | 5 of 5           | Changed drilled shaft detail. Added CSL tubes.   |
| 5203         | 1 of 5       | Added precast post cap; Changed clearance tolerance on stepped panel and Neoprene Pad options.   |              | 1 of 8           | Changed SINGLE COLUMN GROUND SIGN NOTES, Note 11, and GUIDE TO USE THIS STANDARD, Note 4 and example. Modified concrete classification. Modified "ALUMINUM COLUMN (POST) SELECTION TABLE".   |
|              | 3 of 5       | Changed #4 Bar Mark to Bars P5 & P6 for Pile/Post Options A, B & E, and changed texture thickness dimension to 1/4" Max.   |              | 2 of 8           | Changed maximum limits of sign cluster area and width in NOTE.   |
|              | 4 of 5       | New sheet added for 45 degree corner post.   | 17302        | 3 of 8           | Added Aluminum Soil Plate details and notes. Changed Post and Foundation Table depth values. Modified "ALUMINUM COLUMN (POST) SELECTION TABLE".  |
|              | 5 of 5       | Renumbered from Sheet 4 of 4.  | 17328        | 4 of 8           | Deleted "Signs at 90°" note. Added "For" note. Changed number of Z-brackets for STOP and RECTANGULAR sign. Changed '1" Min.' to '0" Min.' and sign panel edge distance in VIEW A-A. Modified U-bolt size. Changed panel overhang length. |
|              |              |  |              | 5 of 8           | Modified "DRIVEN POST DETAIL IN CONCRETE".   |
|              |              |  |              | 1 of 1           | CASE II, and CASE VIII dimensions and notes revised.   |
|              |              |  |              | 1 of 1           | Weigh Station and combination Weigh Station and Inspection Station signing details separated.  |

**Revisions  
Design Standards 2010**

| <b>Index Number</b> | <b>Sheet Number</b> | <b>Description</b>  | <b>Index Number</b> | <b>Sheet Number</b> | <b>Description</b>  |
|---------------------|---------------------|---|---------------------|---------------------|---|
| 17344               | 2, 3, 4 & 6 of 6    | SCHOOL SIGNS AND MARKINGS, on each sheet, in the Distance table at the bottom of the sheet, deleted the "A" column. Also deleted the "A" dimension from the detail drawings.  | 17725               | 1 of 2              | Round pole note revised; pole height dimensions added to Type P-III through P-VIII; Copper Ground note changed.   |
| 17345               | 2 of 4              | NORMAL TAPERED ENTRANCE WITH ADDED LANE, note in lower left corner, arrow now points to the reflective markers on the LEFT side of the ramp.  |                     | 2 of 2              | Notes revised and rearranged, D(feet) changed to H(feet) in both tables.  |
|                     | 4 of 4              | Deleted note 2  | 17727               | 1-2 of 2            | Schedule 40 aluminum pipe (T6061) added as an alternate to stainless steel pipe in assembly details and signalhead notes. Added backplates to signalhead details. |
| 17346               | 1-14 of 14          | Completely revised and renumbered.  | 17736               | 1 of 1              | Added notes 5 & 6.  |
| 17347               | 1-4 of 4            | New Index BICYCLE MARKINGS added.   | 17743               | 1 of 3              | Updated assembly dimensions. Changed drilled shaft reinforcing.   |
| 17349               | 1 of 1              | Case I and Case II revised; 18" x 18" marker detail revised; notes at bottom right revised.   |                     | 2 of 3              | Updated assembly dimensions. Changed drilled shaft reinforcing. Changed T3-BF.  |
| 17355               | 1 of 11             | Revised signs FTP-9A-06 & FTP-9B-06 and notes.  |                     | 3 of 3              | Updated assembly dimensions. Changed drilled shaft reinforcing.   |
|                     | 7 of 11             | For all signs with 1-800 phone number, deleted "1-800-998-RIDE" and substituted "1-8XX-XXX-XXXX" and below each sign added note: "Design Project Manager or Transit Administrator will supply correct 1-8XX number".  | 17745               | 1 of 5              | QPL requirements added in new note 17; added backplates to pole detail; Notes 6 & 14 revised, deleted note 19.  |
|                     | 8 of 11             | Revised sign FTP-68A-06, bolt holes located outside of sign message, notes revised. Sign FTP-69-06 and FTP-68B-06 message and spacing revised.  | 17748               | 2 of 5              | Revised foundation reinforcing details, Section AA, Section DD and Foundation Plan details.   |
|                     | 9 of 11             | Revised sign FTP-82-08 and arrow detail. Added Sign FTP-83-08.  |                     | 1 of 1              | Option 1 deleted and Options 2 and 3 renumbered; Note 1 revised. Added backplates to signalhead displays.   |
| 17356               | 1 of 1              | Removed signalhead from detail. Single point attachment details deleted from Index. (Deleted sheet 1.)  | 17784               | 1 of 2              | Dimensions revised on Figures A & B. Note 5 and Note to Designers revised.  |
| 17359               | 1 of 2              | Changed delineators to object markers; revised reference notes; sign W13-1 made optional. RURAL NARROW BRIDGE TREATMENT, changed the DM3L on the right side of the roadways to an DM3R.   | 17890               | 2-3 of 3            | Added backplates to signalhead displays.  |
|                     | 2 of 2              | Notes revised; inserts reorganized  | 17900               | 7 of 7              | Changed pole type callouts, deleted "N-III" and substituted "P-III".  |
| 17500               | 1 of 3              | Deleted concrete pole detail, added METAL POLE DETAIL AND WIRING DIAGRAM.   | 18111               | 1-2 of 2            | Index totally revised.  |
|                     | 2 of 3              | Note 7, deleted "class I Concrete (Miscellaneous)" replaced with "Concrete and reinforcing for slabs around poles and pullboxes shall be included in the price for pullbox or pole."  | 18113               | 1-2 of 2            | Index totally revised.  |
|                     | 3 of 3              | Note 7, deleted "class I Concrete (Miscellaneous)" replaced with "Concrete and reinforcing for slabs around poles and pullboxes shall be included in the price for pullbox or pole."  | 20110               | 1 of 1              | Changed Insert Detail for Diaphragm Reinforcing.  |
| 17501               | 1 of 1              | Deleted note 28.  | 20199               | 1 of 1              | Changed BEAM CAMBER AND BUILD-UP NOTES.   |
| 17502               | 3 of 7              | Changed Note 9. Added Notes 10 & 11. Changed Notes 11 & 12. Deleted grout pad notes (former Notes 4 & 9). Added CSL tube note (Note 11).  | 20210               | 2 of 2              | Added "Type Q" Epoxy to Note 9.   |
|                     | 4 of 7              | Added ID plate and changed base plate thickness. Deleted grout pad. Changed drilled shaft reinforcing.  | 20299               | 1 of 1              | Changed BEAM CAMBER AND BUILD-UP NOTES.   |
|                     | 5 of 7              | Changed Weld symbol in SECTION A-A. Added padlock tab to HANDHOLE RING. Added Section E-E detail and bottom baseplate washer to SECTION C-C. Deleted grout pad and added wire screen. Added CSL tubes.  | 20500               | 1 of 1              | Added Type C Pads for larger skew ranges. Changed specification of elastomer from "durometer" to "shear modulus".   |
|                     | 6 of 7              | Grout notes and details removed, new wire screen.   | 20501               | 1 of 1              | Changed Note 4.   |
|                     | 7 of 7              | Note 3, changed "Concrete class" to "concrete NS"   | 20502               | 1 of 1              | Changed Note 4.   |
| 17503               | 1 of 1              | Index deleted.  | 20602               | 1 of 1              | Changed EDC location to 1D from tip of pile.  |
| 17504               | 1 of 1              | Dimensions 5'-6" added for height of meter base. Pole type changed from type "N" to type "P".   | 20900               | 2 of 2              | Changed coping width and End Bent lug from 6" to 5½" thickness.   |
| 17505               | 1 of 2              | Mercury Vapor Luminaires changed to Induction Luminaires. Luminaire chart deleted, dimensions revised on spacing detail note and added to structure detail.   | 20910               | 2 of 2              | Changed coping width and End Bent lug from 6" to 5½" thickness.   |
| 17515               | 1 of 8              | Added median barrier mounted light poles. Moved notes to sheet 2.   | 21100               | 1 of 3              | Deleted redundant notes from Specification Section 458.   |
|                     | 2 of 8              | New Sheet for Notes. Change Note 7 for QPL Criteria. Modified concrete classification. Added notes for median barrier mounted light pole and foundation.  |                     | 3 of 3              | Changed Sidewalk Cover Plate edge treatment.  |
|                     | 3 of 8              | Sheet renumbered from 2 to 3. Added double arm configuration to ARM ELEVATION.  | 21110               | 1 of 2              | Deleted redundant notes from Specification Section 458. Changed last line of title of bottom left detail to "DECK WITH SLOPES 2% OR GREATER".                     |
|                     | 4 of 8              | Allowed fusion weld reinforcing cage (*) and changed foundation concrete note. Added 1" dimension to Double Nuts in FOUNDATION. Modified concrete classification. Renumbered sheet from 3 of 3 to 4 of 8.   |                     | 2 of 2              | Changed Sidewalk Cover Plate edge treatment.  |
|                     | 5-8 of 8            | New Sheets for median barrier mounted light pole.   | 21200               | 1 of 2              | Added "Anchor Plate (dashed lines) (provide Design) to ELEVATION VIEW and TYPICAL SECTION. Added design of anchor bolts and accessories.                          |
| 17600               | 2 of 3              | Added detail for pole foundation to be used only behind guardrail.  |                     | 2 of 2              | Added design of anchor bolts and accessories.   |
|                     | 3 of 3              | GENERAL NOTES, note 2, changed "Class II Concrete" to "Class I Concrete"; changed note 4.   | 21600               | 1 of 7              | Clarified INSTRUCTIONS TO DESIGNER for variable end span lengths.   |
| 17723               | 1 of 3              | Changed Note 5i, 6 and 7. Added Note 8. Deleted grout pad and notes (former Notes 4d & 7). Added CSL tube note (Note 9).  |                     | 3 of 7              | Added vertical dimensions between deck surface and underside of bearings, including depth of Truss Panel.   |
|                     | 2 of 3              | Changed number of bolts in VIEW B-B, number and size of foundation reinforcing bars, and TABLE OF STRAIN POLE VARIABLES. Added foundation standoff distance and washer for base plate. Deleted grout pad and added wire screen. Added CSL tubes. Changed drilled shaft reinforcing. | 21802               | 1 of 1              | Changed "Methyl Methacrylate" to "High Molecular Weight Methacrylate".  |
|                     | 3 of 3              | Changed note in VIEW E-E; Added ¼" and ⅜" cable clamps and changed weld criteria. Changed clevis size.  | 21803               | 1-2 of 3            | Revised call-outs for Grout Outlets; Changed "Methyl Methacrylate" to "High Molecular Weight Methacrylate".   |
|                     |                     |   |                     | 3 of 3              | Shrink wrap deleted from Duct Coupler Detail. Revised call-outs for Duct Couplers; Changed "Methyl Methacrylate" to "High Molecular Weight Methacrylate".         |

A Area or Amperes  
AAA American Automobile Association  
AADT Annual Average Daily Traffic  
AASHTO American Association Of State Highway Officials  
AASHTO American Association Of State Highway And Transportation Officials  
ABC Asphalt Base Course  
Abd. Abandoned  
ABS Acrylonitrile-Butadiene-Styrene Pipe  
AC, Ac. Acre  
AC or Asph. Conc. Asphaltic Concrete  
Accel. Acceleration  
ACI American Concrete Institute  
Act. Actuated  
ADA The Americans With Disabilities Act  
Adh. Adhesive  
Adj. Adjust  
ADT Average Daily Traffic  
AFAD Automatted Flagger Assistance Device  
Agg. Aggregate  
Ah. Ahead  
AISC American Institute Of Steel Construction  
Alt. Alternate  
Al. Aluminum  
AM 12:00 Midnight Until 11:59 Noon  
ANSI American National Standards Institute  
ADS Apparent Opening Size  
Appl.. Applied, Application  
Apprh. Approach  
Approx. Approximate  
ARTBA American Road & Transportation Builders Association  
Artf. Artificial  
Asph. Asphalt  
Assem. Assembly  
Assn. Association  
Assoc. Associate, Association  
ASTM American Society For Testing And Materials  
ATPB Asphalt Treated Permeable Base  
Attn. Attention  
Attnuatr. Attenuator  
Aux. or Auxil. Auxiliary  
Ave. Avenue  
AWG American Wire Gauge  
AWS American Welding Society  
Az Azimuth

B to B Back to Back  
Basc. Bascule  
Bd. or Bnd. Bond or Bonded  
BC Bottle Cap or Bolt Circle  
B/C, B.C. Back Of Curb  
BCCMP Bituminous Coated Corrugated Metal Pipe Culvert  
BCPA Bituminous Coated Pipe Arch Culvert  
BCPCMP Bituminous Coated And Paved Corrugated Metal Pipe Culvert  
BCPPA Bituminous Coated And Paved Pipe Arch Culvert  
BCT Breakaway Cable Terminal  
BCWE Base Clearance Water Elevation  
BE Buried Electric  
Beg. Begin  
Bit. Bituminous  
Bk. Back  
BL, BLC, or B̄ Base Line, Base Line Control  
Bldg. Building  
Blkhd. Bulkhead  
BLDN Begin Length Of Need  
Blvd. Boulevard  
BM Bench Mark  
Bndry. Boundary  
Bdr. Border  
Bot. Bottom  
BO Basin Outlet  
BOS Beginning Of Survey  
BP Borrow Pit  
Bq. Becquerel

Br. Bridge  
Brg. Bearing  
Brkwy. Breakaway  
BT Buried Telephone Cable or Duct  
Btfly. Butterfly  
BW Barbed Wire, Bottom Width or Both Ways  
C Cantilever Length, Cut, Colorless, Coulomb or Cycle Length  
°C Degree Celsius  
C & G Curb And Gutter  
CA Coarse Aggregate  
Cap. Capacity  
CAP Corrugated Aluminum Pipe  
Caps. Capital Letters  
CASP Corrugated Aluminized Steel Pipe  
CATV Cable Television  
CB Catch Basin  
CBC Concrete Box Culvert  
CBS Concrete Box Structure  
CC, C/C, C to C, or C.C. Center to Center, Crash Cushion  
CCEW Center to Center Each Way  
CCTV Closed-Circuit Television  
CD Cross Drain, Cross Direction (Geotextiles)  
cd Candela  
Cem. Cement or Cemetery  
Cem'd. Cemented  
CFS Cubic Feet Per Second  
Ch. Channel  
Chchg. Channel Change  
Chg. Changeable  
CI Cast Iron  
CIP Cast Iron Pipe  
CIPL, C.I.P., C-I-P Cast In Place  
circ. Circumference  
Ckt. Circuit  
Cl. or Clear Clearance  
CL, C/L or C̄ Center Line  
CM Concrete Monument  
CMB Concrete Median Barrier  
CMP Corrugated Metal Pipe  
CMPA Corrugated Metal Pipe Arch  
Co. County or Company  
Col. Column  
Com. Commercial or Common  
CDMM Committee or By Committee  
Comp. Composite  
Con. Connect or Connection  
Conc. Concrete  
Const. Construct or Construction  
Contrl. Controller  
Cont. Continuation  
Contr. Contractor  
Coord. Coordinate  
Cor. Corner  
Corr. Corrugated  
CP Concrete Pipe  
CPE Corrugated Polyethylene Pipe  
CPT Cone Penetration Test  
CR Control Radius or County Road  
CRA Clear Recovery Area  
Crs. or Cse. Course  
CS Curve To Spiral  
CSP Corrugated Steel Pipe  
CT Clear Trunk  
CTPB Cement Treated Permeable Base  
Ctivr. Cantilever  
Ctr., Ctrs. Center  
CU or Cu Copper  
Culv. Culvert  
Cwt. Hundredweight  
CY, Cu. Yd., CY, or C.Y. Cubic Yard  
Cyl. Cylindrical

D Degree Of Curvature, Depth, Density, Distance, Diameter or Directional Distribution  
DA Drainage Area or Deflection Angle  
DBH Diameter At Breast Height  
DBI Ditch Bottom Inlet  
Dbl. Double  
DCS Degree Of Curvature (Spiral)  
DD Dry Density  
DDHV Directional Design Hour Traffic  
Decel. Deceleration  
Deg. Degree  
Delin. Delineators  
Demobl. Demobilization  
Dept. Department  
Det. Detour, Detection, Detectable  
DFE Design Flood Elevation  
DGN or Dgn. Design  
DHV Design Hourly Volume  
DHW Design High Water  
DT Ditch  
DI Drop Inlet  
Dia. or D Diameter  
Dim. Dimension  
Disp. Disposal  
Dist. Distance  
DLS District Location Surveyor  
DMM Domestic Mail Manual  
DOT Department Of Transportation  
DPI or D.P.I. Ditch Point Intersection  
Dr. or DR. Drain, Drive or Design Review  
DR Design Review  
Driv. Driven  
Drwy. Driveway  
DS Design Speed  
DSL Design Service Life  
Dwg. Drawing  
E East or External Distance  
e Rate Of Superelevation  
E to E End to End  
EA or Ea. Each  
EB Eastbound  
EIA Electronic Industries Alliance  
El. or Elev. Elevation  
Elast. Elastomeric  
Elec. Electric  
Ellip. Elliptical  
Embk. Embankment  
Emul. Emulsified  
Encl. Enclosure  
Engr. Engineer  
EOS End Of Survey or Equivalent Opening Size  
E.P. or EOP Edge Of Pavement  
EPDM Ethylene Propylene Diene Monomer  
Eq. Equation or Equal  
Equip. Equipment  
Esmt. Easement  
Est. or Estm. Estimate  
Est. Establish or Established  
Etc. or etc. Et Cetera (And So Forth)  
ETP Electronic Tough Pitch  
EW Endwall  
Ex. Except, Example  
Exc. or Excav. Excavation  
Exist. Existing  
Exp. Expansion  
Ext. Extension  
Exwy. Expressway

The abbreviations listed are the standard for contract plans production. This list is not all inclusive. Other Department accepted abbreviations may be used when deemed more appropriate. Where special abbreviations are used a descriptive tabulation may be necessary in the plans.



2010 FDOT Design Standards

**STANDARD ABBREVIATIONS**

|               |           |
|---------------|-----------|
| Last Revision | Sheet No. |
| 07/01/09      | 1 of 3    |
| Index No.     |           |
| 001           |           |

|                       |  |                   |  |                   |   |                        |  |
|-----------------------|--|-------------------|--|-------------------|---|------------------------|--|
| F                     | Fill, Farad                                | HW or H.W.        | High Water or Hot Water                        | M                 | Mass, Middle Ordinate Length or Mega                      | N m                    | Newton Meter   |
| F or Final            | Final Quantity                             | Hwy.              | Highway  | m                 | Meter or Milli  | No.                    | Number   |
| F & I                 | Furnish & Install                          | Hyd.              | Hydraulic                                      | m <sup>2</sup>    | Square Meter or Meter Square                              | Nom.                   | Nominal  |
| F to F                | Face to Face                               | Hz                | Hertz  | m <sup>3</sup>    | Cubic Meter or Meter Cubed                                | Norm.                  | Normal   |
| FA                    | Federal Aid or Fine Aggregate              |                   |  | m <sup>3</sup> /m | Cubic Meter Per Meter                                     | N.P.                   | Non Plastic  |
| FAC                   | Florida Administrative Code                | I                 | External Angle (Delta), Interstate             | m/s               | Meters Per Second   | NPS                    | Nominal Pipe Size                                    |
| FAP                   | Federal Aid Project                        | Intchg. or Ichg.  | Interchange                                    | Mach.             | Machine   | NPT                    | National Pipe Thread                                 |
| FC                    | Friction Course                            | IES               | Illuminating Engineering Society               | Maint.            | Maintenance   | NRCP                   | Non-Reinforced Concrete Pipe                         |
| FD                    | French Drain                               | ID, I.D.          | Inside Diameter or Identification              | Matl.             | Material  | NS                     | Non Stress, Not Suitable or Near Side                |
| Fdn.                  | Foundation                                 | IMC               | Intermediate Metal Conduit                     | Max.              | Maximum   | NT, N&T                | Non Traffic, Nail & Tin                              |
| FDDT                  | Florida Department Of Transportation       | In.               | Inch or Inches                                 | MB                | Median Barrier  | NTS                    | Not To Scale   |
| FE                    | Floor Elevation                            | Inc.              | Incorporated or Including                      | MBM               | Thousand (Feet) Board Measure                             | NW                     | Northwest  |
| Fed.                  | Federal                                    | Incl. or Inc.     | Included                                       | MD                | Machine Direction (Geotextiles)                           |                        |  |
| Fert.                 | Fertilizer                                 | Ind.              | Industry or Industrial                         | Med.              | Median  | Opass                  | Overpass   |
| FES                   | Flared End Section                         | INV. or Inv.      | Invert   | Mega              | One Million   | Q to Q, o to o or O.D. | Out to Out   |
| FETS                  | Flared End Terminal Section                | IP                | Iron Pipe                                      | Memb.             | Member  | QA                     | Overall  |
| FH                    | Fire Hydrant                               | Install.          | Installed                                      | MES               | Mitered End Section                                       | Q.B.G.                 | Optional Base Group                                  |
| FHWA                  | Federal Highway Administration             | Isect.            | Intersection                                   | Mess.             | Message   | QC or Q.C.             | On Center  |
| Fig.                  | Figure                                     | Isl.              | Island   | Mfg.              | Manufactured or Manufacturer                              | OD or O.D.             | Outside Diameter                                     |
| Fin.                  | Finish                                     | IR                | Iron Rod                                       | MG                | 1000 Gallons  | OE                     | Overhead Electric                                    |
| F.L., FL or $\bar{F}$ | Flow Line                                  | ITE               | Institute Of Transportation Engineers          | MH, M.H.          | Manhole, Mounting Height                                  | OH, OHD or Ohd.        | Overhead   |
| FL, Fl. or Fla.       | Florida                                    | ITS               | Intelligent Transportation Systems             | MHW               | Mean High Water   | Opt.                   | Option, Optional or Optically                        |
| Flex.                 | Flexible                                   |                   |  | $\mu$             | Micro   | OT                     | Overhead Telephone                                   |
| FNQ                   | Fuse (Type Slow Burn)                      | J                 | Joule  | Mi.               | Mile  | Oz.                    | Ounce  |
| FDC                   | Fiber Optics Cable                         | JB                | Junction Box                                   | Micro             | One-Millionth   | $\Omega$               | Ohm  |
| FPM or fpm            | Feet Per Minute                            | Jct.              | Junction                                       | Mid.              | Middle  | P                      | Passenger Car & Light Delivery Truck                 |
| FPS or fps            | Feet Per Second                            | Jt.               | Joint  | Mil               | One-Thousandth Of An Inch                                 | P or Plan              | Plan Quantity  |
| FR or Fr.             | Frame                                      |                   |  | Mil.              | Military  | Pa                     | Pascal   |
| Frang.                | Frangible                                  | K                 | Design Hour Factor or Kelvin                   | Milli             | One-Thousandth  | Par.                   | Parallel   |
| Freq.                 | Frequency                                  | k                 | Kilo (prefix)                                  | Min.              | Minimum or Minute   | Pa.s                   | Pascal Second  |
| F.S.                  | Florida Statutes                           | kg                | Kilogram                                       | Misc.             | Miscellaneous   | Part.                  | Participation or Partition                           |
| Ft.                   | Foot or Feet                               | kg/m              | Kilogram Per Meter                             | mL                | Milliliter  | Pavt.                  | Pavement   |
| FTB                   | Floating Turbidity Barrier                 | kg/m <sup>2</sup> | Kilogram Per Square Meter                      | MLW               | Mean Low Water  | PC                     | Point Of Curvature                                   |
| FTBA                  | Florida Transportation Builder Association | kg/m <sup>3</sup> | Kilogram Per Cubic Meter                       | mm                | Millimeter  | PCBC                   | Precast Concrete Box Culvert                         |
| FTP                   | Florida Traffic Plans                      | Kilo              | One Thousand                                   | mobl.             | Mobilization  | PCC                    | Point Of Compound Curvature or Plain Cement Concrete |
| Furn.                 | Furnish                                    | Kip               | 1000 Pounds                                    | Mod.              | Modify or Modified  | PCE                    | Permanent Construction Easement                      |
|                       |  | km                | Kilometer                                      | Mol               | Mole  | PE                     | Professional Engineer                                |
|                       |  | km/h              | Kilometer Per Hour                             | Mon.              | Monument  | Ped                    | Pedestrian or Pedestal                               |
| G                     | Giga or Gauss                              | kn                | Knot   | MOT               | Maintenance Of Traffic                                    | Pen.                   | Penetration  |
| g                     | Gram or Gravity                            | kN                | Kilonewton                                     | MP                | Mile Post   | PG                     | Profile Grade  |
| Galv.                 | Galvanized                                 | kPa               | Kilopascal                                     | MPa               | Megapascal  | PGL                    | Profile Grade Line                                   |
| Ga.                   | Gauge or Gage                              | ksi               | Kips Per Square Inch                           | MPH or mph        | Miles Per Hour  | Ph.                    | Phase  |
| Ga. or Gal.           | Gallon                                     | kV                | Kilovolt                                       | MSL               | Mean Sea Level  | pH                     | Measure Of Acidity or Alkalinity                     |
| Gar.                  | Garage                                     | kVA               | Kilovolt Ampere                                | MSTCSD            | Minimum Specifications For Traffic Control Signal Devices | PI                     | Point Of Intersection                                |
| GD                    | Gutter Drain                               | kWh               | Kilowatthour                                   | Mtd.              | Mounted   | Pkg.                   | Parking  |
| GFI                   | Ground Fault Interrupter                   |                   |  | MUTCD             | Manual On Uniform Traffic Control Device                  | Pkwy.                  | Parkway  |
| GIP                   | Galvanized Iron Pipe                       | L                 | Length, Length Of Curve, Liter, Left           | MUTS              | Manual On Uniform Traffic Studies                         | PL or $\bar{P}$        | Property Line or Plate                               |
| GM                    | Gas Main                                   | 2-L               | Two-Lane                                       |                   |   | PM                     | 12:00 Noon Until 11:59 Midnight                      |
| GP                    | Grade Point                                | 2L1W              | Two-Lane One-Way                               | N                 | North or Newton   | POC                    | Point On Curve                                       |
| Gr.                   | Grade, Guardrail or Grate                  | 2L2W              | Two-Lane Two-Way                               | N/m               | Newtons Per Meter   | PDST                   | Point On Semi-Tangent                                |
| Gr. or Gro.           | Gross                                      | LA or L/A         | Limited Access                                 | N/m <sup>2</sup>  | Newtons Per Square Meter                                  | POT                    | Point On Tangent                                     |
| GRC                   | Galvanized Rigid Steel Conduit             | Lat.              | Lateral or Latitude                            | N/m <sup>3</sup>  | Newtons Per Cubic Meter                                   | PP                     | Power Pole   |
| Grd.                  | Ground                                     | Lb.               | Pound  | N/mm <sup>2</sup> | Newtons Per Square Millimeter                             | PPB                    | Pier Protection Barrier                              |
| GRI                   | Geosynthetic Research Institute            | LBS.              | Pounds   | NA or N/A         | Not Available or Not Applicable                           | Pr.                    | Pair   |
| gross km              | Gross Kilometer                            | lb/sy             | Pounds Per Square Yard                         | N & C             | Nail & Cap  | PRC                    | Point Of Reverse Curvature                           |
| Gr. Wt. or gr. wt.    | Gross Weight                               | LBR               | Limerock Bearing Ratio                         | N & D             | Nail & Disk   | Prct.                  | Precast  |
| Gttr.                 | Gutter                                     | LC                | Long Chord                                     | NAVD              | National American Vertical Datum                          | Prest.                 | Prestressed  |
|                       |  | LED               | Law Enforcement With Flashing Lights And Radar | NB                | Northbound  | Prob.                  | Probability  |
| H                     | Henry                                      | LFD               | Load Factor Design                             | NC                | National Coarse or Normal Crown                           | Prod.                  | Product, Production, Producer or Produced            |
| h                     | Hour or Hecto                              | Lgth.             | Length   | NCHRP             | National Cooperative Research Program                     | Prog.                  | Program or Progression                               |
| ha                    | Hectare                                    | Lin.              | Linear   | NDCBU             | Neighborhood Delivery And Collection Box Unit             | Proj.                  | Project or Projection                                |
| HAR                   | Highway Advisory Radio                     | lm                | Lumen  | NE                | Northeast   | PRM                    | Permanent Reference Monument                         |
| HB                    | Hay Bales                                  | Lmrk.             | Limerock                                       | net km            | Net Kilometer   | Prop.                  | Proposed   |
| HC                    | Horizontal Clearance                       | LDS               | Limit Of Clear Sight                           | NEMA              | National Electrical Manufacturers Association             | Prov.                  | Provisions   |
| HD                    | High Density or Heavy Duty                 | Loc., LD          | Location                                       | NGVD              | National Geodetic Vertical Datum of 1929                  | PRS                    | Portable Regulatory Sign                             |
| HD or Hd.             | Head                                       | Long.             | Longitude                                      | NGS               | National Geodetic Survey                                  | PS & E                 | Plans, Specifications And Estimates                  |
| HDPE                  | High Density Polyethylene                  | LRFD              | Load Resistance Factor Design                  | NHS               | National Highway System                                   | PSF or psf             | Pounds Per Square Foot                               |
| Hdl.                  | Headwall                                   | LS                | Length Of Spiral                               | NHW               | Normal High Water   | PSI or psi             | Pounds Per Square Inch                               |
| HH                    | Heavy Hex                                  | LT                | Left Turn                                      | NIC               | Not In Contract   | PT                     | Point Of Tangency or Pressure Treated                |
| Hndrl                 | Handrail                                   | Lt.               | Left   | NJ                | New Jersey  | PVC                    | Polyvinyl Chloride                                   |
| HDA                   | Hand/Off/Automatic                         | Ltd.              | Lighted or Limited                             |                   |   | PW                     | Pressure Water                                       |
| Horiz. or Hor.        | Horizontal                                 | Lum.              | Luminaire                                      |                   |   |                        |  |
| HP                    | High Pressure or Horsepower                | L/W               | Lightweight                                    |                   |   |                        |  |
| Hr.                   | Hour                                       | lx                | Lux  |                   |   |                        |  |
| HS                    | High Strength                              |                   |  |                   |   |                        |  |
| HSHV                  | High Strength Horizontal Vertical          |                   |  |                   |   |                        |  |
| Hse.                  | House                                      |                   |  |                   |   |                        |  |
| Ht.                   | Height                                     |                   |  |                   |   |                        |  |

The abbreviations listed are the standard for contract plans production. This list is not all inclusive. Other Department accepted abbreviations may be used when deemed more appropriate. Where special abbreviations are used a descriptive tabulation may be necessary in the plans.



2010 FDOT Design Standards

**STANDARD ABBREVIATIONS**

|               |           |
|---------------|-----------|
| Last Revision | Sheet No. |
| 07/01/09      | 2 of 3    |
| Index No.     |           |
| 001           |           |

Q Peak Discharge or Flow Volume  
 QPL Qualified Products List

R Right  
 R or Rad. Radius  
 R or Rng. Range  
 rad Radian  
 rad/s Radian Per Second  
 RBAC Rock Base Asphaltic Concrete  
 RBST Rock Base Surface Treatment  
 RC Reverse Crown  
 RCP Reinforced Concrete Pipe  
 RCPA Reinforced Concrete Pipe Arch  
 Rd. Road or Round  
 Rdsd. Roadside  
 Rdwy. Roadway  
 Rec. Recovery  
 Rect. Reticuline or Rectangular  
 Ref. Reference  
 Refl. Reflective  
 Reg. Region, Regular, Registered or Regulation  
 Reinf. Reinforced or Reinforcing  
 Rejuv. Rejuvenation  
 Reloc. Relocated  
 Rem. Removal  
 Repl. Replace  
 Req. or Reqd. Required  
 Res. Residence or Residential  
 RGS Rigid Galvanized Steel  
 RHW Insulation (Moisture & Heat Resistant Rubber)  
 RM Reference Monument  
 r/min Revolution Per Minute  
 RP Reference Point  
 rpm Revolution Per Minute  
 RPM Raised Reflective Pavement Markers  
 r/s Revolution Per Second  
 RR Railroad  
 RSDU Radar Speed Display Unit  
 Rsf. Resurface  
 Rt. Right  
 RU Rack Unit  
 R/W, RDW Right Of Way  
 RX Receive

S or s Speed, South, Siemens, Or Second  
 SAHM Sand-Asphalt Hot Mix  
 SAN or San. Sanitary  
 SB Southbound  
 SBAC ShellBase Asphaltic Concrete  
 SBRM Sand Bituminous Road Mix  
 SBST ShellBase Surface Treatment  
 SC Seal Coat or Spiral To Curve  
 Sch. Schedule  
 SCST Sand-Clay Surface Treatment  
 SD Side Drain, Storm Drain  
 SE Southeast  
 Sec. Second  
 Sect. Section  
 Sed. Sediment  
 Sep. Separator  
 Seq. Sequential  
 Serv. Service  
 SF Adjustment Factor In Percent, Silt Fence  
 SG Subgrade  
 SG Specific Gravity  
 Sh. or Sht. Sheet  
 Shldr. Shoulder  
 SHW Seasonal High Water  
 SIP Stay In Place  
 SP Superpave  
 Spa. Space  
 Spcg. or Sp. Spacing  
 Spec. Specification  
 SPT Standard Penetration Test  
 Sq. Ft., SF, or S.F. Square Foot  
 Sq. In. Square Inch  
 Sq. Yd., SY or S.Y. Square Yard  
 SR or S.R. State Road  
 SRAP Spiral Rib Aluminum Pipe

SRASP Spiral Rib Aluminized Steel Pipe  
 SRCP Steel Reinforced Concrete Pipe  
 SRD State Road Department  
 SRSP Spiral Rib Steel Pipe  
 SS Sanitary Sewer  
 SSMD Solid State Modular Design  
 ST Surface Treatment or Spiral To Tangent  
 St. or ST. Street  
 Sta. Station  
 Stab. Stability or Stabilization  
 STB Staked Turbidity Barrier  
 Std. Standard  
 Stg. Strong  
 Stge. Storage  
 Stl. Steel  
 Str. Structure  
 Sty. Story  
 SU Single Unit Trucks  
 Sub. or Subs. Subsoil  
 Sub. or Subst. Substitute  
 Subgr. Subgrade  
 Suppts. Supports  
 SUR or Sur. Survey  
 Surf. Surface  
 SW Southwest  
 SW or Swk. Sidewalk  
 Sys. or Syst. System  
 Sv Sievert  
 Sym. Symmetrical

T Tangent, Length Of Curve, Percent Trucks, Tesla,  
 T, TWP or Twp. Township  
 t Metric Ton  
 tan. Tangent  
 TBM Temporary Bench Mark  
 TC Tangent To Curve  
 TCB Temporary Concrete Barrier  
 TCE Temporary Construction Easement  
 TCP Terra Cotta Pipe  
 TCZ Traffic Control Zone  
 TDLC Transportation Design For Livable Communities  
 Tel. Telephone  
 Temp. Temperature or Temporary  
 Theo. Theoretical  
 THRMPLSTC Thermoplastic  
 THW or THWN Insulation (Flame Retardant, Moisture And Heat Resistant Thermoplastic)  
 Thick. Thickness  
 Tk Thick, Thickness or Truck  
 Tn. Ton  
 Traf. Traffic  
 Trans. Transition, Transverse, Translate or Transportation  
 Treat. Treatment  
 TS Tangent To Spiral  
 TSC Length Of Tangent (Spiral Curve)  
 TTC Temporary Traffic Control  
 TVSS Transient Voltage Surge Suppression  
 TX Transmit  
 Typ. Typical

Upass. Underpass  
 UG Underground  
 UL Underwriters Laboratories  
 Ult. Ultimate  
 Unld. Unlimited  
 Unddr. Underdrains  
 Undrdwy. Underroadway  
 UNL or Undl. Unloaded  
 Untr. Untreated  
 UPS Uninterruptible Power Supply  
 USC & GS US Coast and Geodetic Survey (now National Geodetic Survey)  
 USGS US Geological Survey  
 USPS United States Postal Service  
 Util. Utilities  
 UV Ultraviolet

V Volt, Velocity, Volume or Hourly Volume  
 Var. Varies, Variable or Variance  
 VC Vertical Curve  
 VCP Vitrified Clay Pipe  
 VECP Value Engineering Change Proposal  
 Veh. Vehicle  
 Vert. Vertical  
 VF Vertical Foot  
 Vh Verified Horizontal Location  
 VMS Variable Message Sign  
 Vol. Volume  
 VP Vertical Panel  
 VPD or Vpd. Vehicles Per Day  
 VPH or Vph. Vehicles Per Hour  
 VPHPL or Vphpl. Vehicles Per Hour Per Lane  
 VRMS Volts Root Mean Square  
 Vv Verified Vertical Elevation  
 Vvh Verified Vertical Elevation And Horizontal Location  
 VW Variable Width

W Width, Wide, West or Watt  
 W/C Water-Cement Ratio  
 WB Westbound  
 Wb. Weber  
 WB40 Intermediate Semi Trailer  
 WB50 Large Semi Trailer  
 WB62 Interstate Semi Trailer  
 WB67D Tandem Semi Trailer  
 WM Water Main  
 W.P.I. Work Program Item  
 WT Water Table Or Weight  
 WWF Welded Wire Fabric  
 WWR Welded Wire Reinforcing

X Coordinate Value (East-West Direction) or Extra  
 X Rd. Cross Road  
 Xing. Crossing  
 Xsec. Cross Section











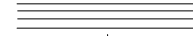

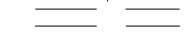
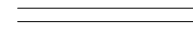

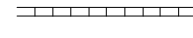
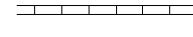

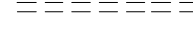
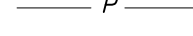
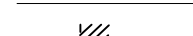

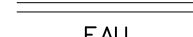

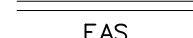
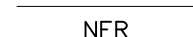
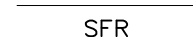
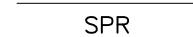

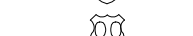
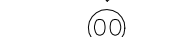
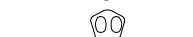



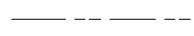
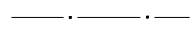
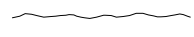
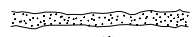







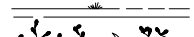
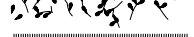





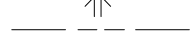
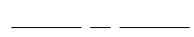

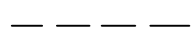
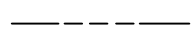



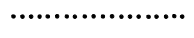
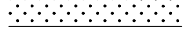
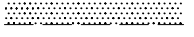
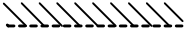
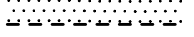
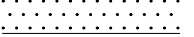





































Y Coordinate Value (North-South Direction)  
 Yd. Yard  
 Yr. Year

| UNITS OF MEASURE   |                           |
|--------------------|---------------------------|
| US MEASUREMENT     |                           |
| AC                 | Acre                      |
| AS                 | Assembly                  |
| BU                 | Bushel                    |
| CF                 | Cubic Foot                |
| CO                 | Cleanout                  |
| CY                 | Cubic Yard                |
| EA                 | Each                      |
| ED                 | Each Day                  |
| GA                 | Gallon                    |
| GM                 | Gross Mile                |
| LB                 | Pound                     |
| LF                 | Linear Foot               |
| LM                 | Lane Mile                 |
| LO                 | Per Location              |
| LS                 | Lump Sum                  |
| LU                 | Luminaire                 |
| MB                 | Thousand Board Measure    |
| MG                 | Thousand Gallons          |
| MH                 | Man Hour                  |
| NM                 | Net Mile                  |
| PA                 | Per Analysis              |
| PB                 | Per Building              |
| PE                 | Pile                      |
| PI                 | Per Intersection          |
| PL                 | Plant                     |
| PM                 | Per Mile                  |
| PS                 | Per Set                   |
| PW                 | Per Well                  |
| SI                 | Square Inch               |
| SF                 | Square Foot               |
| SY                 | Square Yard               |
| TN                 | Ton                       |
| METRIC MEASUREMENT |                           |
| AS                 | Assembly                  |
| CO                 | Cleanout                  |
| DA                 | Day                       |
| EA                 | Each                      |
| ED                 | Each Day                  |
| GK                 | Gross Kilometer           |
| HA                 | Hectare                   |
| HR                 | Hour                      |
| KG                 | Kilogram                  |
| KL                 | Kiloliter                 |
| KM                 | Kilometer                 |
| LI                 | Liter                     |
| LK                 | Lane Kilometer            |
| LO                 | Per Location              |
| LS                 | Lump Sum                  |
| LS/AS              | Lump Sum Per Assembly     |
| LS/DA              | Lump Sum Per Day          |
| LS/EA              | Lump Sum Per Each         |
| LS/HA              | Lump Sum Per Hectare      |
| LS/KG              | Lump Sum Per Kilogram     |
| LS/LS              | Lump Sum Per Lump Sum     |
| LS/MT              | Lump Sum Per Metric Ton   |
| LS/MI              | Lump Sum Per Linear Meter |
| LS/M2              | Lump Sum Per Square Meter |
| LU                 | Luminaire                 |
| MH                 | Man Hour                  |
| MO                 | Month                     |
| MT                 | Metric Ton                |
| M1                 | Meter                     |
| M2                 | Square Meter              |
| M3                 | Cubic Meter               |
| NK                 | Net Kilometer             |
| PA                 | Per Analysis              |
| PB                 | Per Building              |
| PI                 | Per Intersection          |
| PL                 | Plant                     |
| PW                 | Per Well                  |

The abbreviations listed are the standard for contract plans production. This list is not all inclusive. Other Department accepted abbreviations may be used when deemed more appropriate. Where special abbreviations are used a descriptive tabulation may be necessary in the plans.



## STANDARD SYMBOLS FOR KEY MAP

|  |  |  |  |
|--|--|--|--|
|  Highway With Full Control of Access<br> Highway With Frontage Roads<br> Highway Interchange<br> Proposed Controlled Access Highway<br> Divided Highway<br> Hard Surfaced Road<br> Soil, Gravel Or Shell Surfaced Road<br> Graded And Drained Road<br> Unimproved Road<br> Primitive Road<br> Private Road<br> Streets In Inset Or Delimited Areas<br> Extension Of Local Roads Within Cities<br> FAI Federal Aid Interstate Highway<br> FAU Federal Aid Urban Highway<br> FAP Federal Aid Primary Highway<br> FAS Federal Aid Secondary Highway<br> NFR National Forest Road<br> SFR State Forest Road<br> SPR State Park Road<br> Interstate Highway<br> US Numbered Highway<br> State Highway<br> County Road |  Free Ferry<br> Toll Ferry<br> Canal Or Drainage Ditch<br> Intracoastal Waterway<br> Narrow Stream<br> Wide Stream<br> Dam<br> Dam Or Spillway With Lock<br> Dam With Road<br> Flood Control Structure<br> Lake, Reservoir Or Pond<br> Intermittent Pond<br> Meandered Lake<br> Marsh Or Swamp<br> Mangroves<br> Levee Or Dike<br> Levee Or Dike With Road<br> Highway Bridge<br> Small Bridges Closely Spaced<br> Drawbridge<br> Highway Grade Separation<br> Tunnel<br> State Boundary Line<br> County Boundary Line<br> Civil Township Boundary<br> Extended Township Line<br> Land Grant Line<br> Land Section Line<br> State Survey Section Line<br> Survey By Others<br> Location Of Inset Boundary Within Map<br> Military Reservation Boundary<br> College Or University Boundary<br> Corporate Limits<br> Delimited Area, Population Est.<br> Reservation, Forest Or Park Boundary<br> Wildlife Refuge Boundary |  Residential Area Under Development<br> Lighthouse<br> State Capital<br> County Seat<br> Other City Or Village<br> Seminole Indian Village<br> Welcome Station<br> Wayside Park Or Small Park<br> Park With Boat Ramp<br> Boat Ramp<br> Museum<br> Recreational Area Or Historic Site<br> Scenic Site<br> Post Office<br> School<br> Church<br> Cemetery<br> Church And Cemetery<br> Hospital, Health Center Or Rest Home<br> Toll House, Port Of Entry Or Weight Station<br> Fair Grounds, Race Course Or Rodeo Arena<br> Mine Or Strip Mine<br> Governmental Research Station |  Agricultural Inspection Station<br> Farmers Market<br> Game Preserve<br> Game Checking Station<br> Bird Sanctuary<br> Fire Control Headquarters<br> Lookout Tower<br> Fire Station<br> Patrol Or Police Station<br> Correctional Institution Or Road Camp<br> Department of Transportation Facility<br> Coast Guard Station<br> Armory<br> Junkyard<br> Sanitary Fill<br> Sewage Disposal Plant<br> Incinerator<br> Power Plant<br> Power Substation<br> Communications Facility<br> Locked Gate Or Fence<br> Triangulation Station |
| <p><b>GENERAL NOTE</b></p> <p>1. Symbols on this Index are intended for use on all Roadway, Signing And Marking, Signalization, and Lighting projects. For work zone traffic control symbols refer to Index 600. When additional or similar symbols are used, legends or notations may be required for clarity.</p>  |  |  |  |





# STANDARD SYMBOLS FOR PLAN SHEETS

## GENERAL SYMBOLS

|  |   |
|--|---|
|  | State Line                                  |
|  | County Line                                 |
|  | Township Line                               |
|  | Section Line                                |
|  | City Line                                   |
|  | Base Or Survey Line                         |
|  | Right-Of-Way                                |
|  | Easement Line                               |
|  | Limited Access Line                         |
|  | Fence Line                                  |
|  | National Or State Park Or Forest            |
|  | Grant Line                                  |
|  | Railroad (Drainage Maps)                    |
|  | Railroad (Detail Plans)                     |
|  | Fence (Limited Access)                      |
|  | Box Culvert                                 |
|  | Bridge                                      |
|  | Pipe Culvert-Mitered End Section            |
|  | Pipe Culvert-Straight Endwall               |
|  | Pipe Culvert-U-Type Endwall                 |
|  | Pipe Culvert-Median Drain                   |
|  | Pipe Culvert-Other End Treatments           |
|  | 18" SD Storm Drain (Proposed)               |
|  | 18" SD Storm Drain (Existing)               |
|  | Inlet                                       |
|  | Manhole                                     |
|  | Tied Longitudinal Joint                     |
|  | Keyed Longitudinal Joint                    |
|  | Doweled Transverse Expansion Joint          |
|  | Doweled Transverse Contraction Joint        |
|  | Transverse Contraction Joint Without Dowels |
|  | Survey Reference Point                      |
|  | ALACHUA Triangulation Station               |
|  | B.M. NO. 112 Bench Mark                     |
|  | Point Of Intersection                       |
|  | North Arrow                                 |
|  | Edges Of Existing Pavement And Sidewalk     |
|  | Guardrail                                   |
|  | c.c. Crash Cushion (Attenuator)             |
|  | Piling Pier Column                          |
|  | Concrete Monument                           |
|  | Base Line                                   |
|  | Centerline                                  |
|  | Flow Line                                   |
|  | Property Line                               |
|  | Delta Angle                                 |
|  | Approximate                                 |
|  | Round Or Diameter                           |

|  |  |
|--|--|
|  | Curb   |
|  | Curb And Gutter  |
|  | Water Well, Spring   |
|  | Levee  |
|  | MP 327 Railroad Mile Post  |
|  | Railroad Signal With Gate  |
|  | Railroad Switch  |
|  | Gate   |
|  | Pump Island  |
|  | Storage Tank (Surface)   |
|  | Storage Tank (Underground)   |
|  | Mine Or Quarry   |
|  | Borrow Pit   |
|  | Church   |
|  | Store  |
|  | RES Residence  |
|  | B Barn   |
|  | S School   |
|  | Synthetic Bales  |
|  | Silt Fence   |
|  | Floating Turbidity Barrier   |
|  | Staked Turbidity Barrier   |
|  | Stream   |
|  | Shore Line   |
|  | Marsh  |
|  | Wetland Boundary (Proposed)  |
|  | Wetland Boundary (Existing)  |
|  | Hedge  |
|  | Trees  |
|  | Edge Of Wooded Area  |
|  | Shrubbery  |
|  | Grove Or Orchard   |
|  | Definition Of Skew For Cross Drains And Barrels Of Concrete Box Culverts |
|  | Rt. Skew Lt.   |
|  | Concrete   |
|  | Wood   |
|  | e Rate Of Superelevation   |

## UTILITY ADJUSTMENT SYMBOLS

| EXISTING | PROPOSED | EXISTING                  | PROPOSED   |
|----------|----------|---------------------------|--|
|          |          | W - - - - 6" - - - - W    | W W W W W 6" M M M M M M M Water Main                |
|          |          | NPW - - - 6" - - - M d N  | NPW NPW 6" M d N M d N Non Potable Water             |
|          |          | S - - - - 8" - - - - S    | S S S S S 8" S S S S S Sanitary Sewer                |
|          |          | G - - - - 6" - - - - G    | G G G G G 6" G G G G G Gas                           |
|          |          | RD - - - - 4" - - - - RD  | RD RD RD 4" RD RD RD Roof Drain                      |
|          |          | PET - - - 8" - - - L B D  | PET PET 8" PET PET Petroleum                         |
|          |          | STM - - - 12" - - - W L S | STM STM 12" W L S W L S Steam                        |
|          |          | CAS - - - 12" - - - S V D | CAS CAS 12" S V D S V D Casing                       |
|          |          | DT - - - 4"x4" - - - L D  | DT DT 4"x4" L D L D Duct                             |
|          |          | BE - - (7.5 kV) - - 3 B   | BE BE (7.5 kV) BE BE Buried Electric                 |
|          |          | OE - - (7.5 kV) - - 3 O   | 3 O 3 O (7.5 kV) OE OE Overhead Electric             |
|          |          | BTV - - - 3" - - - A L B  | BTV BTV 3" BTV BTV Buried Cable Television           |
|          |          | OTV - - - 2" - - - A L D  | A L D A L D 2" A L D A L D Overhead Cable Television |
|          |          | BT - - - 2" - - - L B     | BT BT BT 2" L B L B L B Buried Telephone             |
|          |          | OT - - - 2" - - - L D     | OT OT OT 2" L D L D L D Overhead Telephone           |
|          |          | BFO - - - 2" - - - O J B  | BFO BFO 2" O J B O J B Buried Fiber Optic            |
|          |          | OFO - - - 1" - - - O J D  | OFO OFO 1" OFO OFO Overhead Fiber Optic              |

See General Note, Sheet 1 of 3



2010 FDOT Design Standards

## STANDARD SYMBOLS

|                                  |                            |
|----------------------------------|----------------------------|
| Last Revision<br><b>07/01/09</b> | Sheet No.<br><b>2 of 3</b> |
| Index No.<br><b>002</b>          |                            |

# STANDARD SYMBOLS FOR PLAN SHEETS

## TRAFFIC SIGNALS SYMBOLS

| EXISTING | PROPOSED |   |
|----------|----------|---|
|          |          | Traffic Signal Head (Span Wire Mounted)           |
|          |          | Traffic Signal Head (Pedestal Mounted)            |
|          |          | Traffic Signal Head (Mast Arm Mounted)            |
|          |          | Traffic Signal Pole (Concrete, Wood, Metal)       |
|          |          | Vehicle Detector (Loop)                           |
|          |          | Signal Cable (On Messenger Wire)                  |
|          |          | Conduit   |
|          |          | Vehicle Detector (Points)                         |
|          |          | Pedestrian Detector                               |
|          |          | Pedestrian Signal Head (Pole Or Pedestal Mounted) |
|          |          | Controller Cabinet (Base Mounted)                 |
|          |          | Controller Cabinet (Pole Mounted)                 |
|          |          | Walk - Dont Walk                                  |
|          |          | Flashing Dont Walk                                |
|          |          | Signal Face Number                                |
|          |          | Signal Lens                                       |
|          |          | Programmed Signal Head                            |
|          |          | Messenger Wire                                    |
|          |          | Pole Tabulation Cross Reference                   |
|          |          | Pole Tabulation Cross Reference (Joint Use Pole)  |
|          |          | Signal Phase                                      |

## LIGHTING SYMBOLS

| EXISTING | PROPOSED |  |
|----------|----------|--|
|          |          | Pole & Luminaire   |
|          |          | Existing Pole & Luminaire To Be Removed                  |
|          |          | Final Position Of Relocated Or Adjusted Pole & Luminaire |
|          |          | High Mast Lighting Tower                                 |
|          |          | City Or Utility Owned Luminaire & Pole                   |
|          |          | PVC (Polyvinyl Chloride) Lighting Conduit And Conductors |
|          |          | Rigid Galvanized Lighting Conduit And Conductors         |
|          |          | Lighting Pull-Box  |
|          |          | Light Distribution Point                                 |
|          |          | Joint Use Pole   |
|          |          | Pier Cap Underdeck Luminaire                             |
|          |          | Pendant Hung Underdeck Luminaire                         |

## SIGNING AND PAVEMENT MARKING SYMBOLS

|  |                             |
|--|-----------------------------|
|  | Pavement Arrow              |
|  | Single Solid Line           |
|  | Double Solid Line           |
|  | Skip Line                   |
|  | Stop Bar                    |
|  | Traffic Sign (Post Mounted) |
|  | Traffic Sign (Overhead)     |
|  | Sign Number                 |
|  | Sign Item Number            |
|  | Traffic Flow Arrow          |

See General Note, Sheet 1 of 3



2010 FDOT Design Standards

### STANDARD SYMBOLS

|                              |                     |
|------------------------------|---------------------|
| Last<br>Revision<br>07/01/05 | Sheet No.<br>3 of 3 |
| Index No.<br><b>002</b>      |                     |

GENERAL NOTES:

Work this Standard with Index Nos. 21910, 21920 and 21930.

U.S. COAST GUARD NOTIFICATION: Notify the local office of the U.S. Coast Guard at least 30 days prior to beginning of construction of the Fender System.

16" DIAMETER COMPOSITE PLASTIC PILES - INDEX NOS. 21910 AND 21920 ONLY: Provide 16" Diameter Composite Plastic Piles in accordance with Specification Section 973. Provide piles of sufficient length to achieve a minimum embedment of 24' into soil having a blow count greater than 6 ( $N > 6$ ). Pile splices and build-ups are not permitted. Installation shall be in accordance with manufacturer's recommendations.

14" SQUARE PRESTRESSED CONCRETE PILES - INDEX NO. 21930 ONLY: Provide 14" Square Prestressed Concrete Piles of sufficient length to achieve a minimum embedment of 20' into soil having a blow count greater than 6 ( $N > 6$ ). Pile splices and build-ups are not permitted. Use only 14" Square Prestressed Concrete Piles with 8 - 1/2" diameter Low Relaxation Strands fabricated in accordance with Index No. 20614.

PLASTIC LUMBER AND STRUCTURAL COMPOSITE LUMBER WALES: Provide Plastic Lumber and Structural Composite Lumber Wales in accordance with Specification Section 973. Wales shall be continuous and spliced only at locations shown on the plans.

PLASTIC LUMBER DECKING FOR CATWALKS: Provide Plastic Lumber decking for catwalks when called for in the Plans in accordance with Specification Section 973.

Install Plastic Lumber Decking according to manufacturer's recommendations using stainless steel #10 x 3" (minimum) deck screws.

FIBERGLASS OPEN GRATING FOR CATWALKS: Provide Fiberglass Open Grating for catwalks when called for in the Plans. Fiberglass Open Grating shall be a heavy duty design suitable for exterior installations. Maximum gap opening on the walkway surface shall be 1/2". Design live loads and deflections shall be a 50 psf uniformly distributed load with a maximum deflection of 3/8" or L/120 at the center of a simple span or a concentrated load of 250 pounds with a maximum deflection of 1/4" at the center of a simple span. Color of Fiberglass Open Grating shall be gray or black.

Install Fiberglass Open Grating according to manufacturer's recommendations using stainless steel hardware, screws, bolts, nuts and washers. Attach Fiberglass Open Grating to Wales and Deck Supports at a 2'-0" maximum spacing so as to resist pedestrian live loads and uplift forces from wind, buoyancy and wave action.

CLEARANCE GAUGE AND LIGHT: Clearance Gauge to be furnished by the FDOT and erected by the Contractor. Clearance Gauge width and numeral height is dependant on visibility distance. The required visibility distance shall be determined by the United States Coast Guard District Commander. Provide and install Clearance Gauge Light in accordance with Specification Section 510 and Index No. 21220.

NAVIGATION LIGHTS: Provide and install Navigation Lights in accordance with Specification Section 510, Index No. 21220 and/or project specific details. Provide and maintain Temporary Navigation Lights during construction until permanent Navigation Lights are operational.

BOLTS, THREADED BARS, NUTS, SCREWS AND WASHERS: Furnish stainless steel Bolts in accordance with ASTM F593 Type 316. Furnish stainless steel Threaded Bars in accordance with ASTM A193 Grade B8M. Furnish stainless steel Nuts in accordance with ASTM F594 Type 316. Furnish stainless steel Screws in accordance with ASTM F593 Type 305. Furnish stainless steel Washers compatible with Bolts, Threaded Rods and Nuts under heads and nuts. Torque Nuts on 1" diameter Bolts and Threaded Bars to 150 lb-ft. Keep threads on Bolts, Threaded Bars and Nuts free from dirt, coarse grime and sand to prevent galling and seizing during tightening.

SPLICE PLATES: Furnish Splice Plates in accordance with ASTM A240 Type 316.

WIRE ROPE - INDEX NO. 21930 ONLY: Furnish Wire Rope in accordance with Specification Section 936.

INSTRUCTIONS TO DESIGNER:

Design Standards Index Series 21900 includes designs and details for Heavy, Medium and Light Duty Fender Systems. Refer to Florida Department of Transportation (FDOT) "Structures Design Guidelines", current edition, for Fender System design criteria and the selection of the appropriate standard Fender System for use at a given site. Design project specific Fender Systems for sites that do not, as a minimum, satisfy the design criteria which was used to develop these standards. Utilize standardized details and components as appropriate for project specific designs.

Complete the "Fender System Table of Variables", the "Estimated Bill of Materials" and the "Estimated Quantities" table and include them in the Plans.

Designate in the Plans the type of decking material to be used for catwalks: 2" x 12" Plastic Lumber or Fiberglass Open Grating. Catwalk decking material shall be determined by the District.

Prepare and include in the Plans supplemental project specific designs and details for the following items:

- Electrical service for navigation lights including conduit path from bridge to fender system and identification of service point. Coordinate design with Index No. 21220 and Specification Section 510.
- Access ladders and catwalks from bridge to fender system are optional and may be included at the discretion of the District.



2010 FDOT Design Standards

FENDER SYSTEM  
GENERAL NOTES AND LAYOUT

Last  
Revision

01/01/07

Sheet No.

1 of 2

Index No.

21900

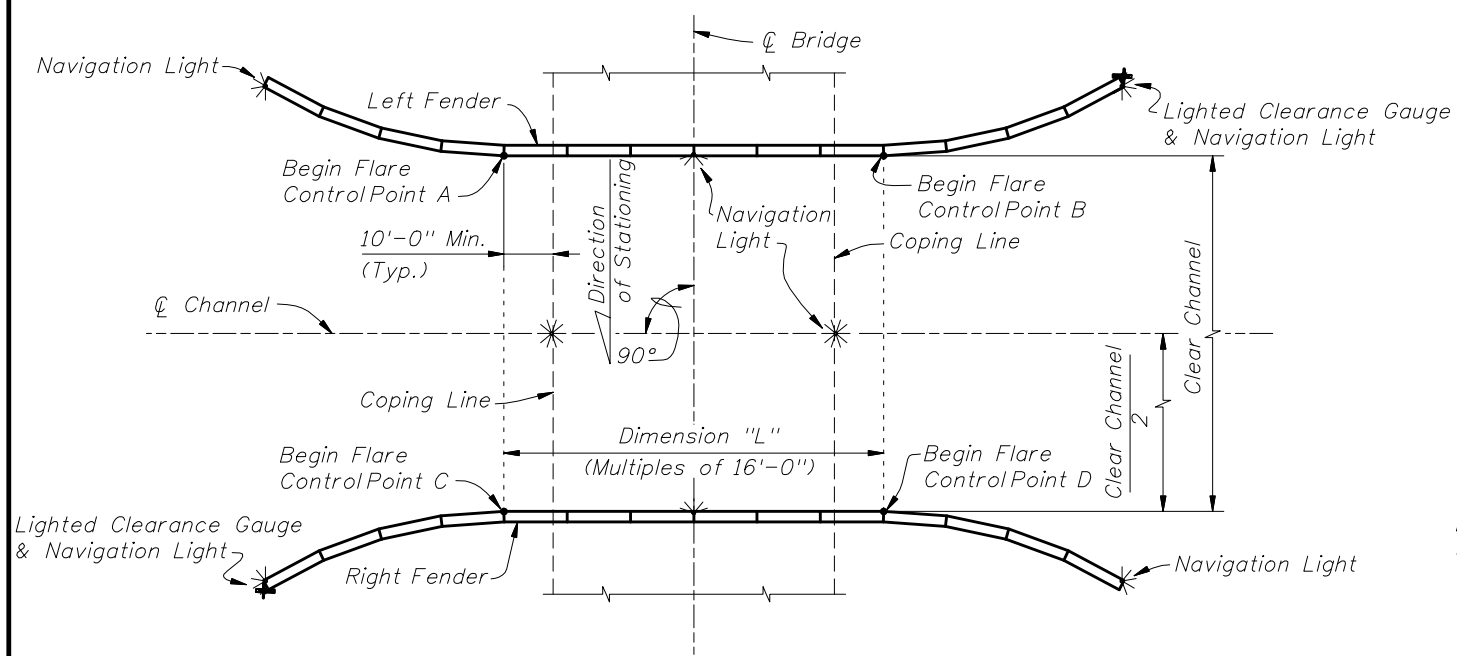

SCHMATIC OF FENDER SYSTEM SHOWING TREATMENT OF SINGLE BRIDGE WITH NONSKEWED CHANNEL

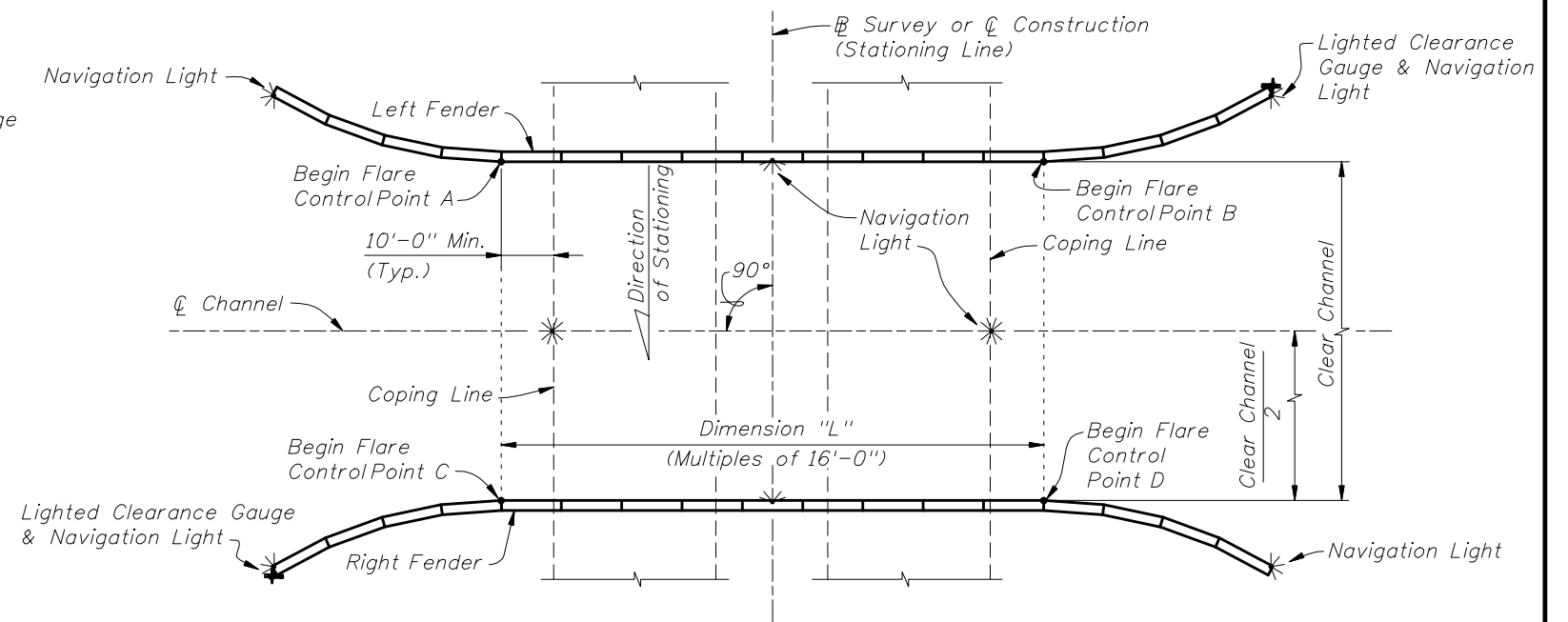

SCHMATIC OF FENDER SYSTEM SHOWING TREATMENT OF DUAL BRIDGES WITH NONSKEWED CHANNEL (PARALLEL DUAL BRIDGES SHOWN, NONPARALLEL DUAL BRIDGES SIMILAR)

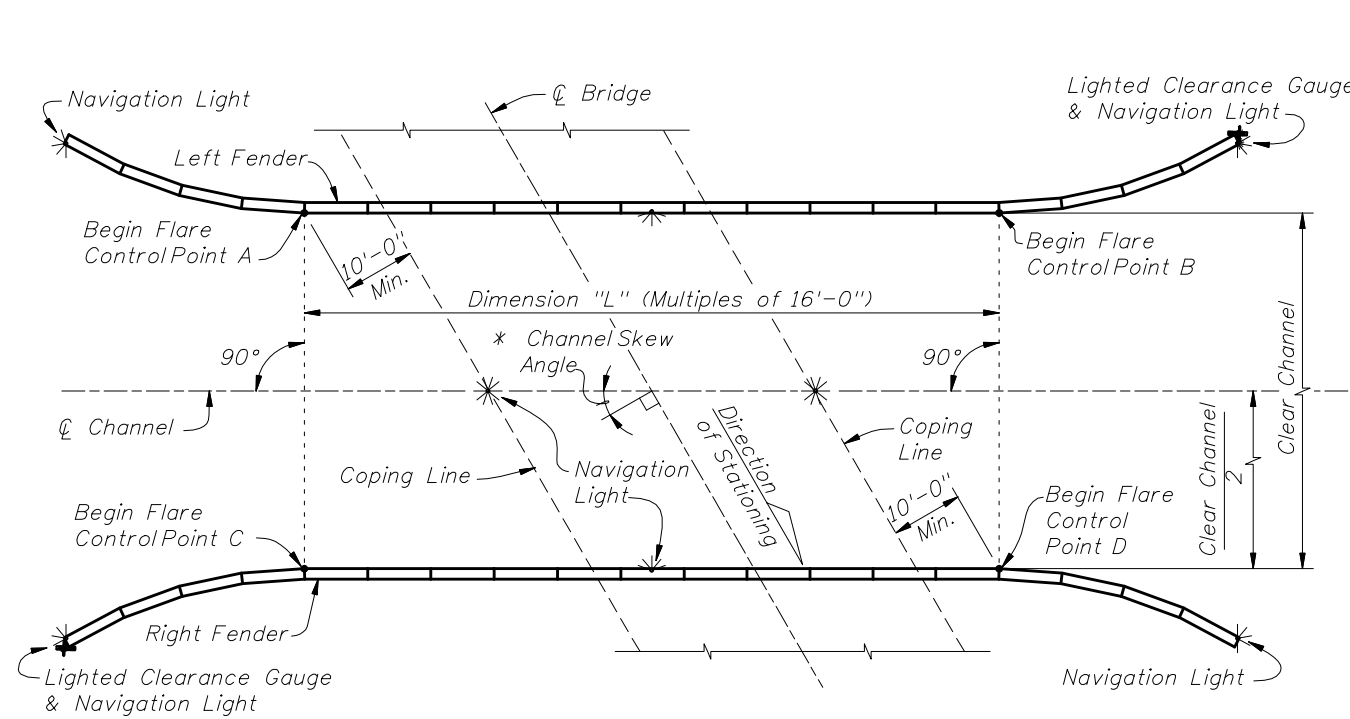

SCHMATIC OF FENDER SYSTEM SHOWING TREATMENT OF SINGLE BRIDGE WITH SKEWED CHANNEL

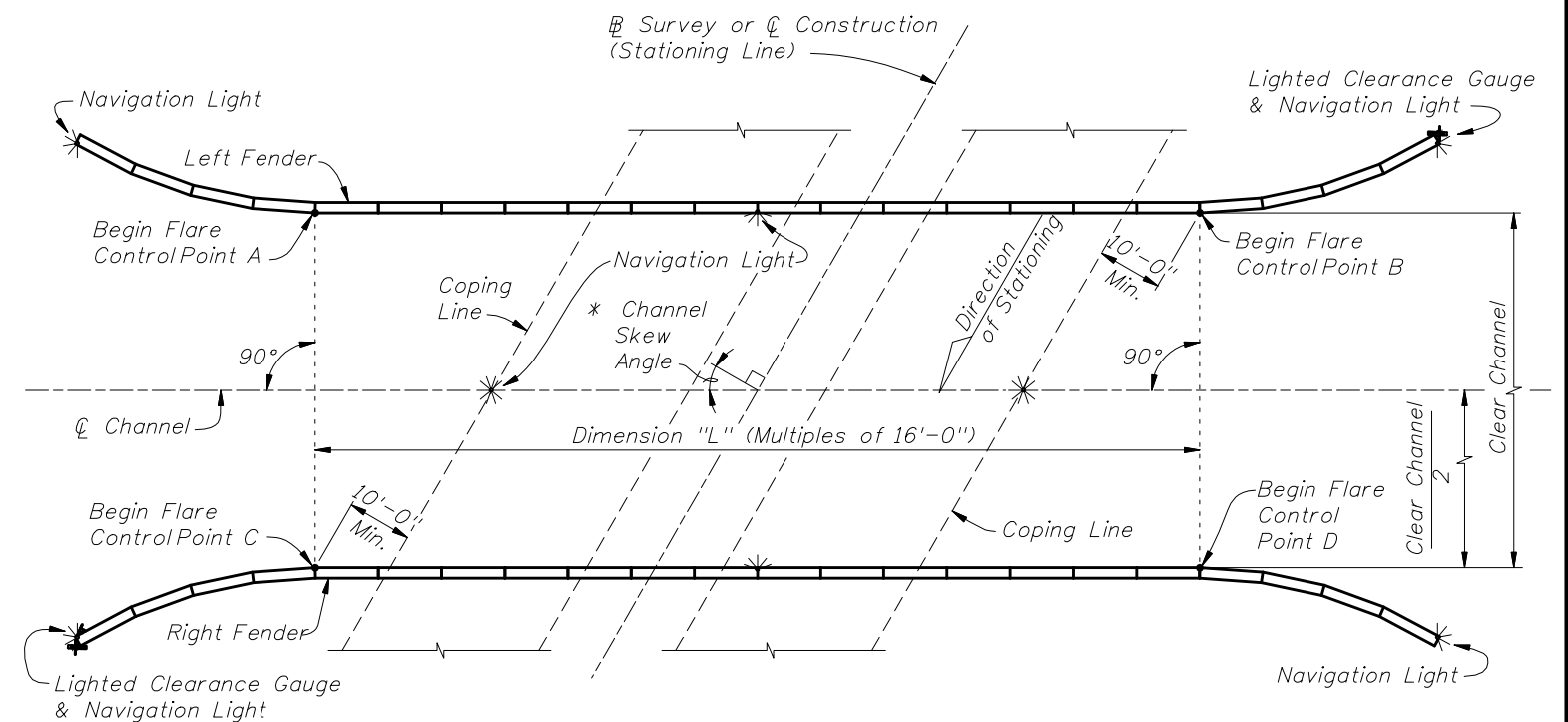

SCHMATIC OF FENDER SYSTEM SHOWING TREATMENT OF DUAL BRIDGES WITH SKEWED CHANNEL (PARALLEL DUAL BRIDGES SHOWN, NONPARALLEL DUAL BRIDGES SIMILAR)

\* See Structures Plans, Plan and Elevation and Foundation Layout Sheets for magnitude and orientation of Channel Skew Angle.

CROSS REFERENCES:

For Stations and Offsets of referenced Control Points A, B, C and D, Dimension "L" and Clear Channel Width see Fender System Table of Variables in Structures Plans.  
For Navigation Light Details see Design Standards Index 21220.



2010 FDOT Design Standards

FENDER SYSTEM  
GENERAL NOTES AND LAYOUT

Last Revision  
01/01/06

Sheet No.  
2 of 2

Index No.  
21900

CROSS REFERENCES:

For Sections A-A and B-B see Sheet 2.

For View F-F see Sheet 3.

NOTE:

Plastic Lumber and Composite Lumber Dimensions shown are based on Nominal Lumber Dimensions and may vary depending on Actual Lumber Dimension.

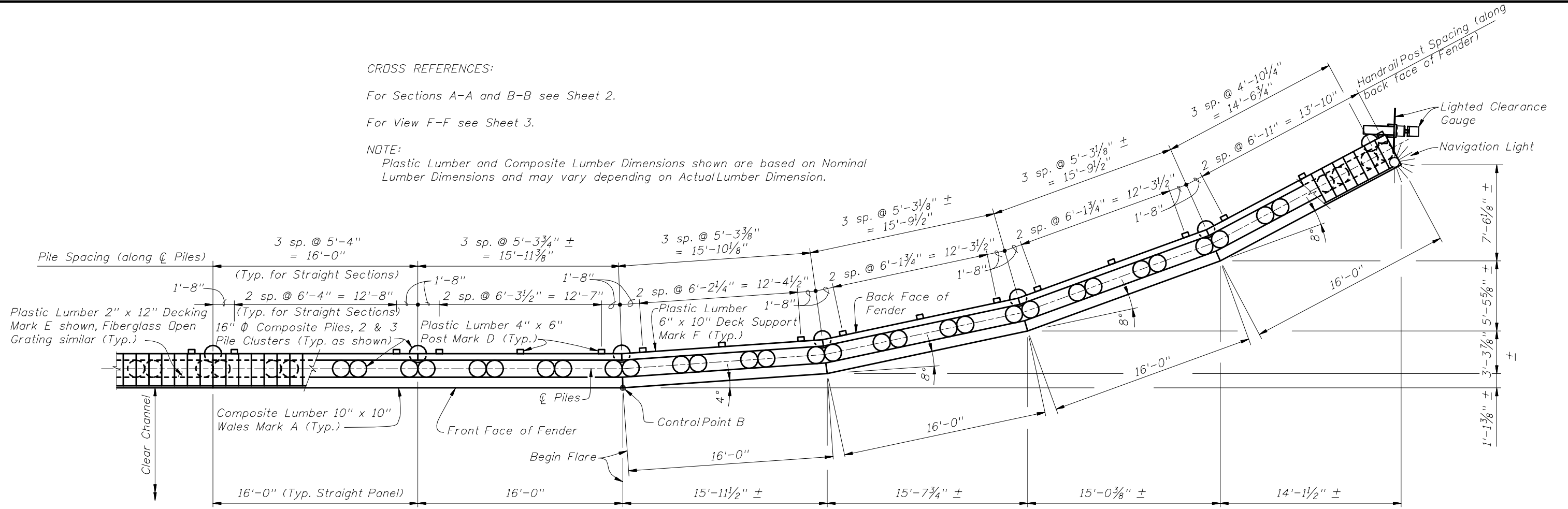

PARTIAL PLAN VIEW (TYPICAL FLARE)  
 (FLARE AT CONTROL POINT B SHOWN, CONTROL POINTS A, C & D SIMILAR)  
 (HANDRAIL NOT SHOWN FOR CLARITY)

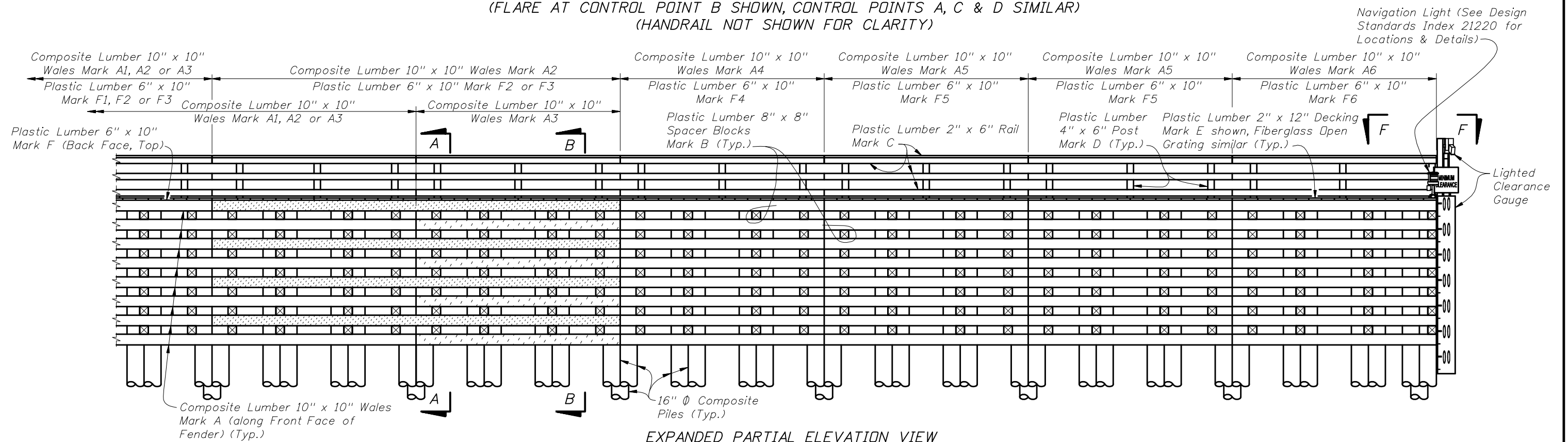

EXPANDED PARTIAL ELEVATION VIEW



2010 FDOT Design Standards

FENDER SYSTEM - HEAVY DUTY

|               |           |
|---------------|-----------|
| Last Revision | Sheet No. |
| 01/01/06      | 1 of 5    |
| Index No.     |           |
| 21910         |           |

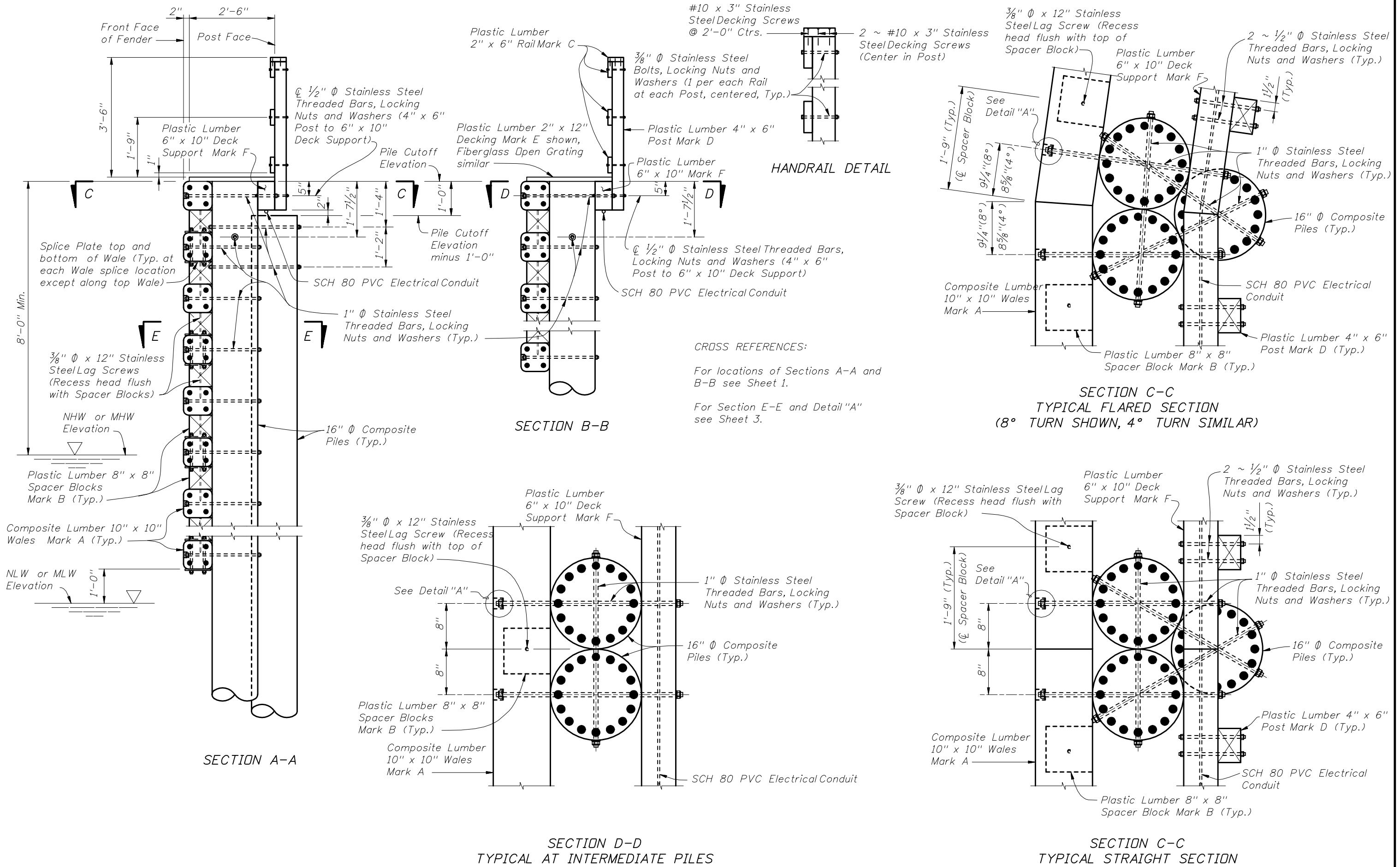

**CROSS REFERENCES:**  
 For locations of Sections A-A and B-B see Sheet 1.  
 For Section E-E and Detail "A" see Sheet 3.



2010 FDOT Design Standards

**FENDER SYSTEM - HEAVY DUTY**

|               |           |
|---------------|-----------|
| Last Revision | Sheet No. |
| 01/01/06      | 2 of 5    |
| Index No.     |           |
| 21910         |           |

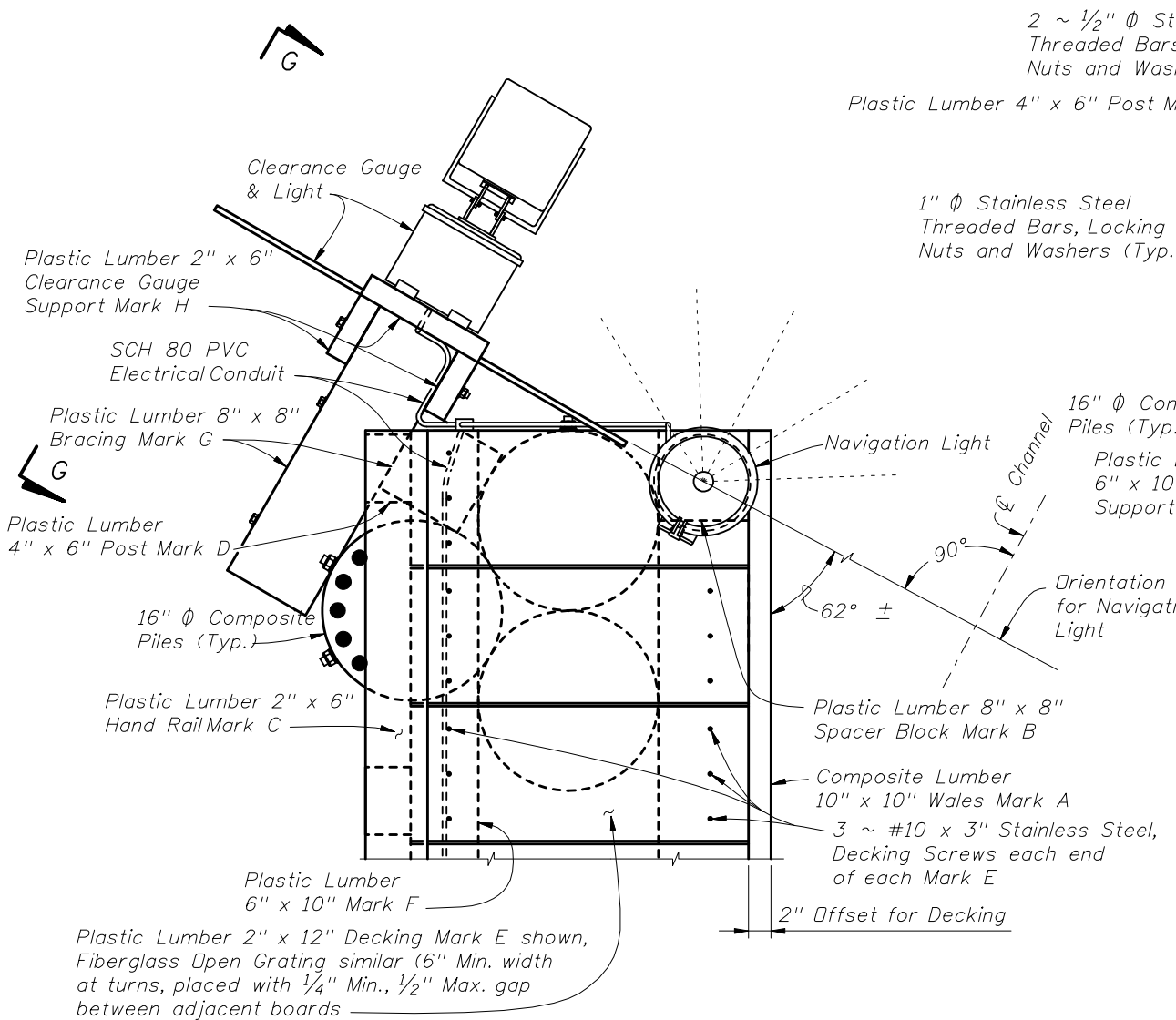

VIEW F-F  
(SHOWING FENDER END WITH CLEARANCE GAUGE; FENDER END WITHOUT CLEARANCE GAUGE SIMILAR)

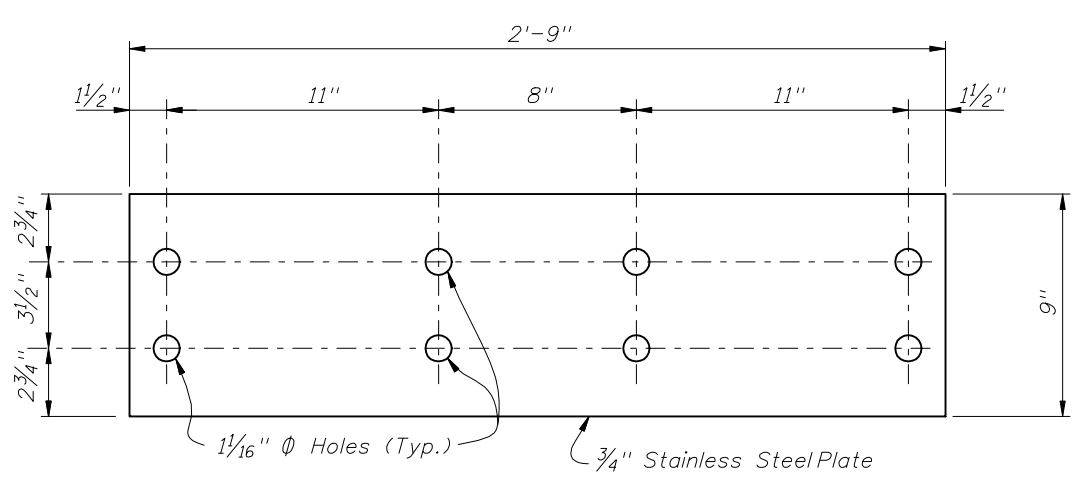

SPLICE PLATE DETAIL

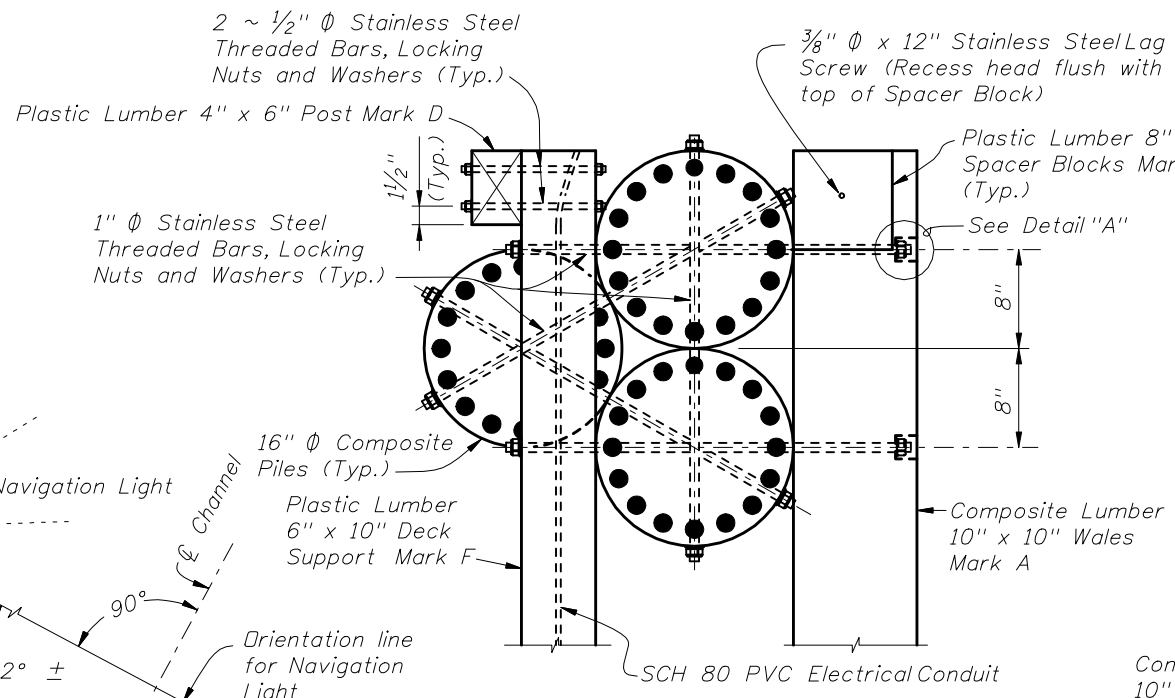

VIEW F-F  
(SHOWING FENDER END; DECKING, HANDRAIL AND CLEARANCE GAUGE NOT SHOWN FOR CLARITY)

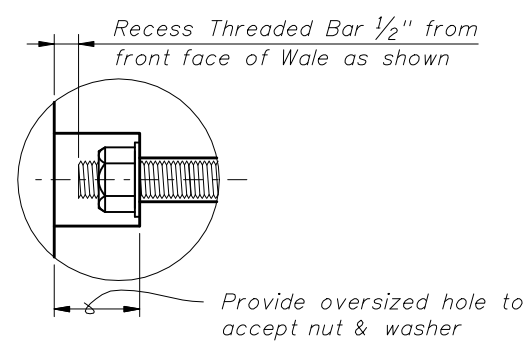

DETAIL "A"

CROSS REFERENCES:

For Navigation Lights and SCH 80 PVC Electrical Conduit Details see Design Standard Index 21220.

For Clearance Gauge Details and View G-G see Sheet 4.

For location of View F-F see Sheet 1.

For location of Section E-E see Sheet 2.

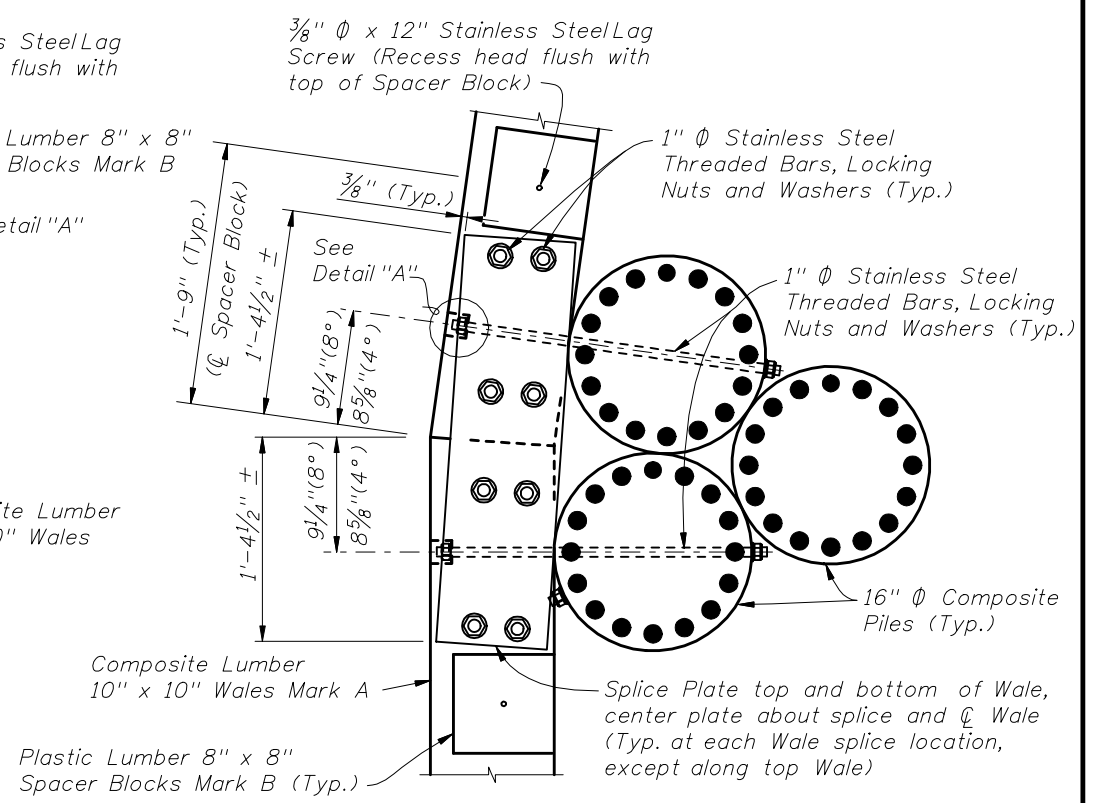

SECTION E-E  
TYPICAL FLARED SECTION  
(8° TURN SHOWN, 4° TURN SIMILAR)

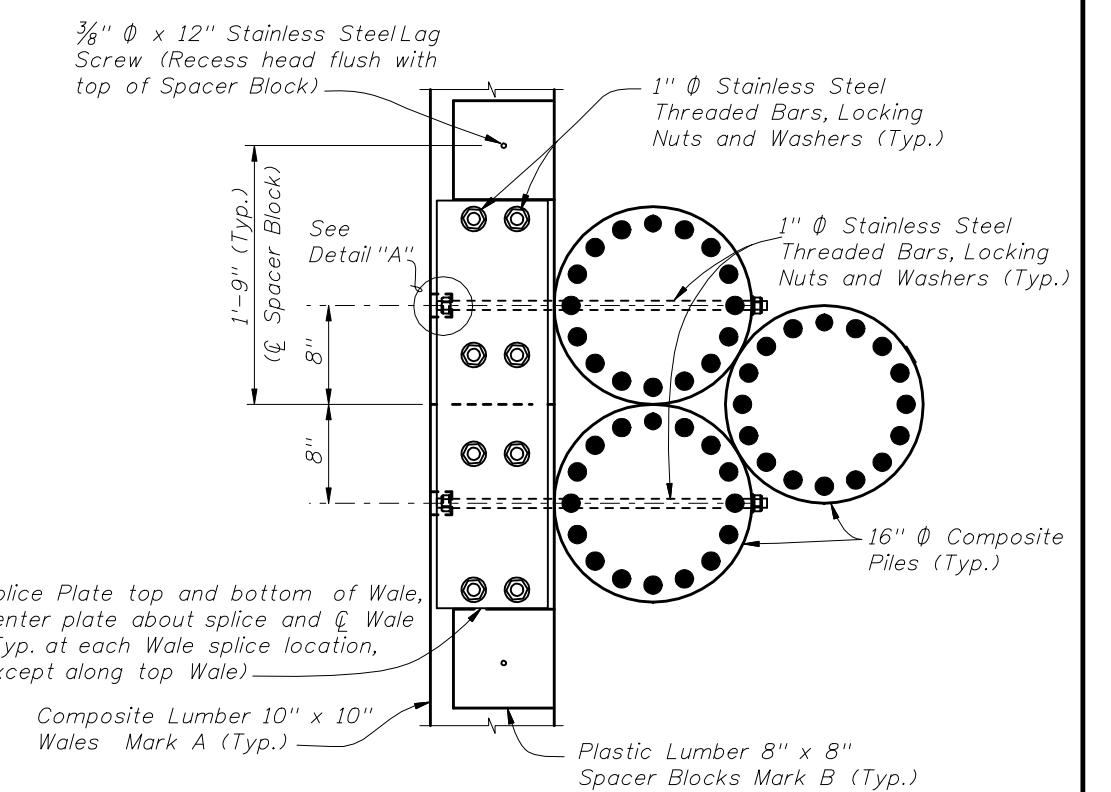

SECTION E-E  
TYPICAL STRAIGHT SECTION



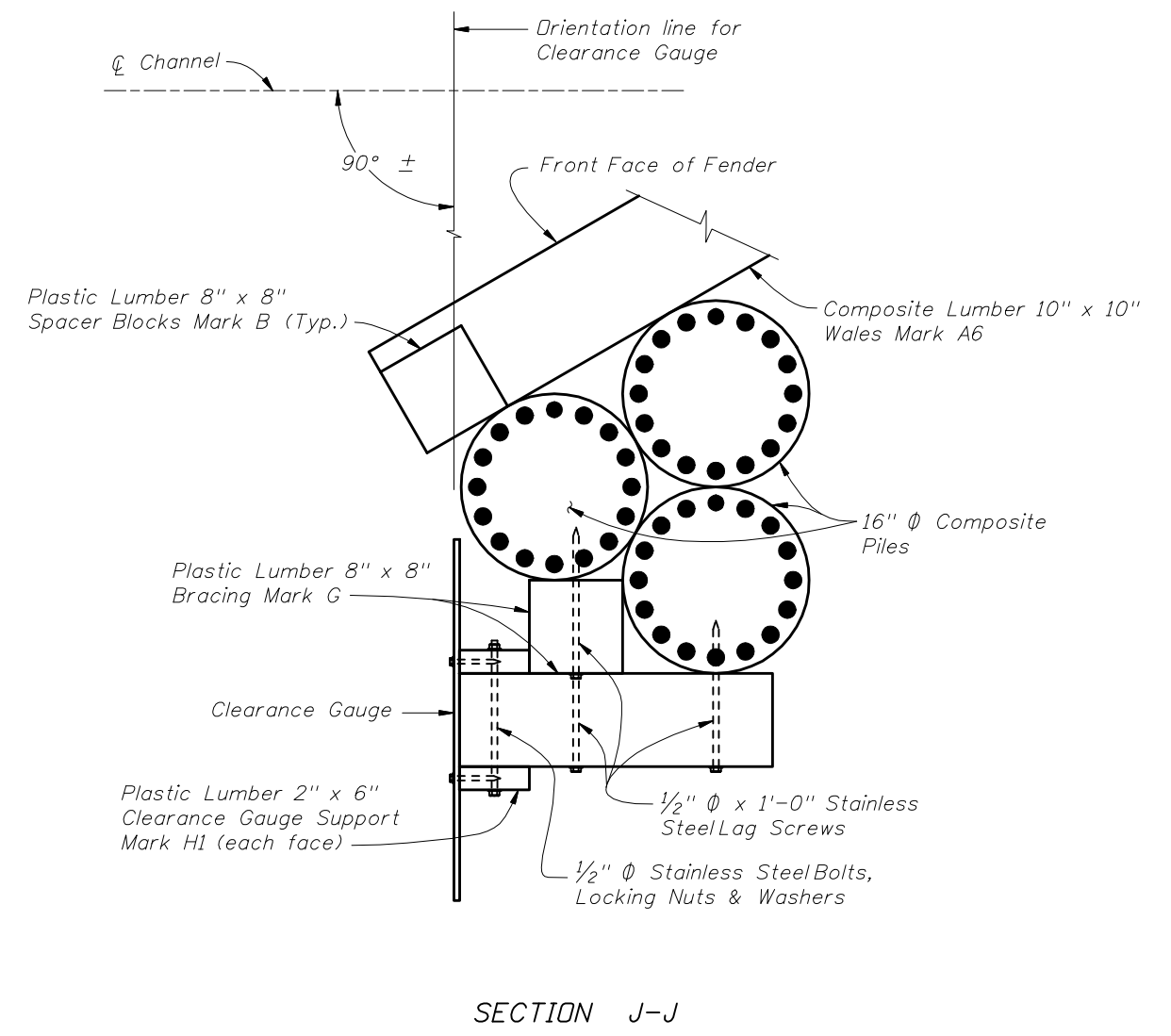
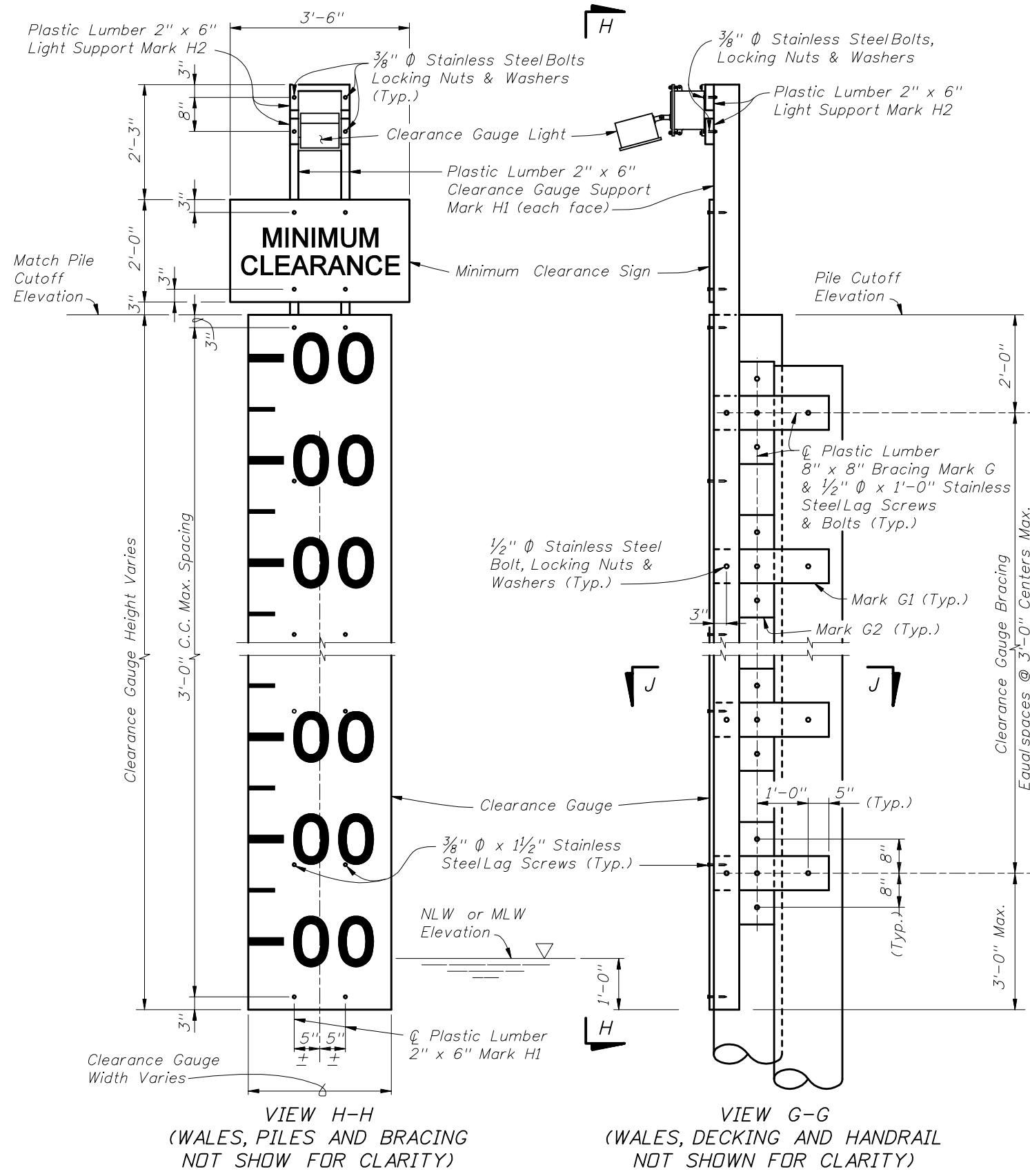

**CROSS REFERENCES:**

For Structural Composite and Plastic Lumber Bill of Materials Quantities and Fender System Table of Variables see Structures Plans.

For location of View G-G see Sheet 3.



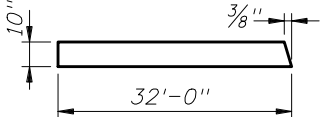
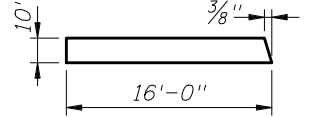
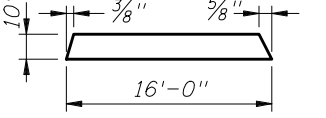
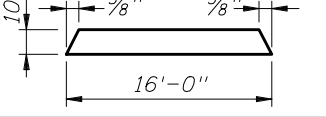
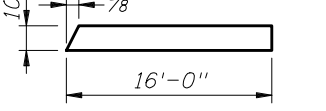

| * STRUCTURAL COMPOSITE LUMBER BILL OF MATERIALS |                            |   |                    |   |          |
|---|----------------------------|---|--------------------|---|----------|
| MARK  | SIZE (NOMINAL)             | DIMENSIONS  | BOARD FT. PER EACH | NO. REQD.   | QUANTITY |
| A1  | 10" X 10" COMPOSITE LUMBER | 32'-0" (STRAIGHT)   | 266.6              | See Estimated Structural Composite and Plastic Lumber Bill of Materials Table in Structures Plans |          |
| A2  | 10" X 10" COMPOSITE LUMBER |  | 266.6              |   |          |
| A3  | 10" X 10" COMPOSITE LUMBER |  | 133.3              |   |          |
| A4  | 10" X 10" COMPOSITE LUMBER |  | 133.3              |   |          |
| A5  | 10" X 10" COMPOSITE LUMBER |  | 133.3              |   |          |
| A6  | 10" X 10" COMPOSITE LUMBER |  | 133.3              |   |          |

\* All Plastic Lumber and Composite Lumber Dimensions and Quantities shown are based on Nominal Lumber Dimensions and may vary depending on Actual Lumber Dimension.

\*\* Provide Fiberglass Open Grating in lieu of 2" X 12" Plastic Lumber when called for in the Plans. Mounting hardware shall be Stainless Steel, install per Manufacturer's recommendations. See Index No. 21900 and Structures Plans for Notes and Details.

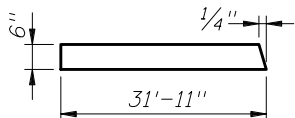
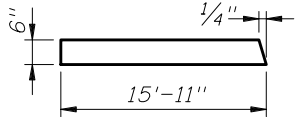
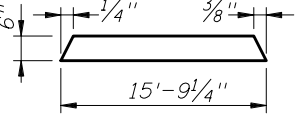
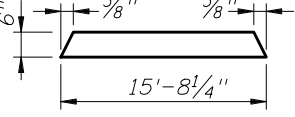
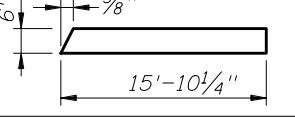
| * PLASTIC LUMBER BILL OF MATERIALS |                         |   |                    |   |          |
|------------------------------------|-------------------------|---|--------------------|---|----------|
| MARK                               | SIZE (NOMINAL)          | DIMENSIONS  | BOARD FT. PER EACH | NO. REQD.   | QUANTITY |
| B                                  | 8" X 8" PLASTIC LUMBER  | 8" (STRAIGHT)   | 3.6                | See Estimated Structural Composite and Plastic Lumber Bill of Materials Table in Structures Plans |          |
| C                                  | 2" X 6" PLASTIC LUMBER  | 16'-0" (STRAIGHT)<br>(Trim & Miter Ends as required)                                  | 16.0               |   |          |
| D                                  | 4" X 6" PLASTIC LUMBER  | 4'-4" (STRAIGHT)  | 8.7                |   |          |
| ** E                               | 2" X 12" PLASTIC LUMBER | 2'-6" (STRAIGHT)<br>(Miter as required)   | 5.0                |   |          |
| F1                                 | 6" X 10" PLASTIC LUMBER | 32'-0" (STRAIGHT)   | 160.0              |   |          |
| F2                                 | 6" X 10" PLASTIC LUMBER |    | 159.6              |   |          |
| F3                                 | 6" X 10" PLASTIC LUMBER |    | 79.6               |   |          |
| F4                                 | 6" X 10" PLASTIC LUMBER |    | 78.8               |   |          |
| F5                                 | 6" X 10" PLASTIC LUMBER |   | 78.4               |   |          |
| F6                                 | 6" X 10" PLASTIC LUMBER |  | 79.2               |   |          |
| G1                                 | 8" X 8" PLASTIC LUMBER  | 2'-3" (STRAIGHT)  | 12.0               |   |          |
| G2                                 | 8" X 8" PLASTIC LUMBER  | 2'-0" (STRAIGHT)  | 10.7               |   |          |
| H1                                 | 2" X 6" PLASTIC LUMBER  | PILE CUTOFF ELEV. MINUS NLW OR MLW ELEV. PLUS 5'-6" (STRAIGHT)                        | 1.0 PER LF EACH    |   |          |
| H2                                 | 2" X 6" PLASTIC LUMBER  | 1'-0" (STRAIGHT)  | 1.0                |   |          |



CROSS REFERENCES:

For Sections A-A and B-B see Sheet 2.

For View F-F see Sheet 3.

NOTE:

Plastic Lumber and Composite Lumber Dimensions shown are based on Nominal Lumber Dimensions and may vary depending on Actual Lumber Dimension.

\* Dimensions typical for 16'-0" Typical Straight Panels.

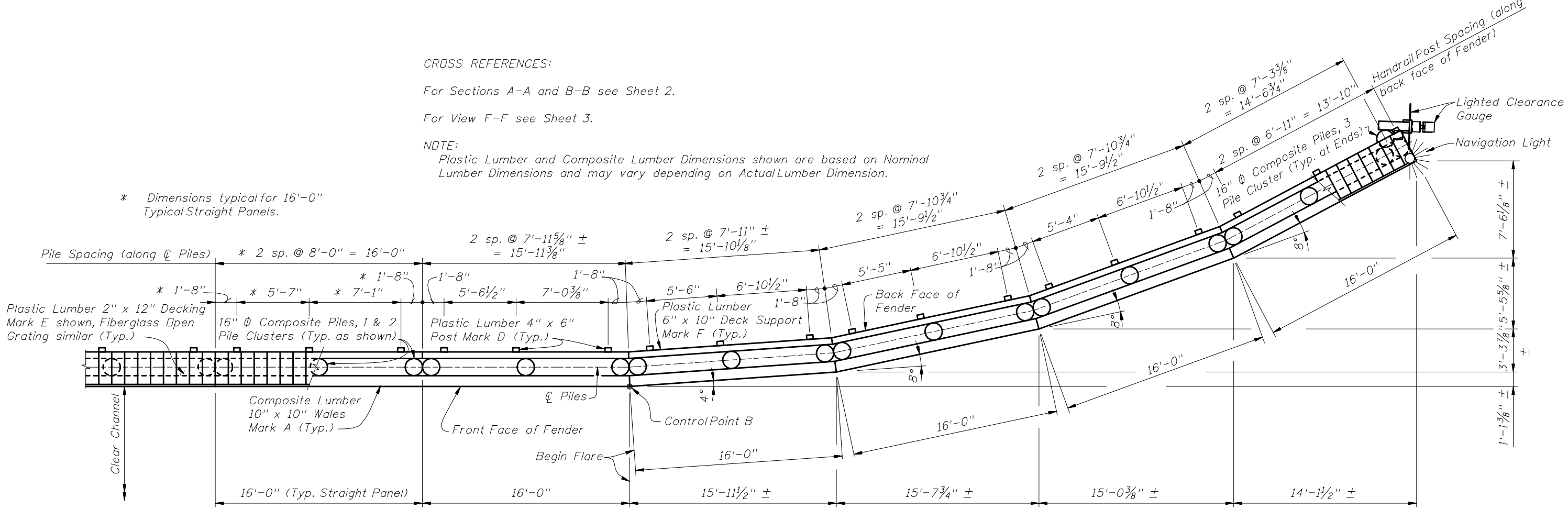

PARTIAL PLAN VIEW (TYPICAL FLARE)  
(FLARE AT CONTROL POINT B SHOWN, CONTROL POINTS A, C & D SIMILAR)  
(HANDRAIL NOT SHOWN FOR CLARITY)

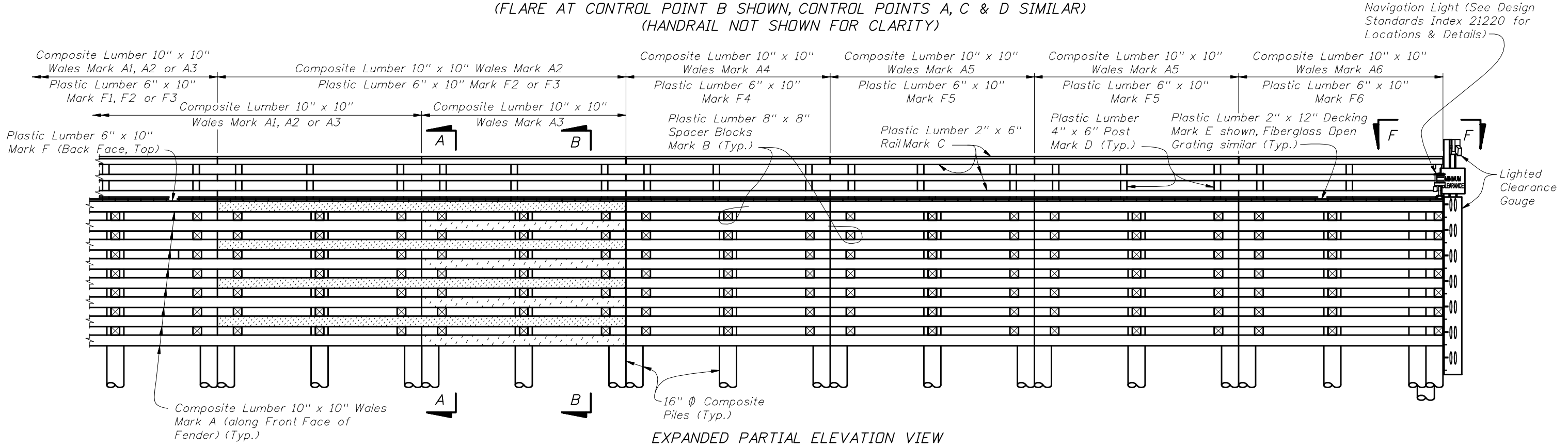

EXPANDED PARTIAL ELEVATION VIEW

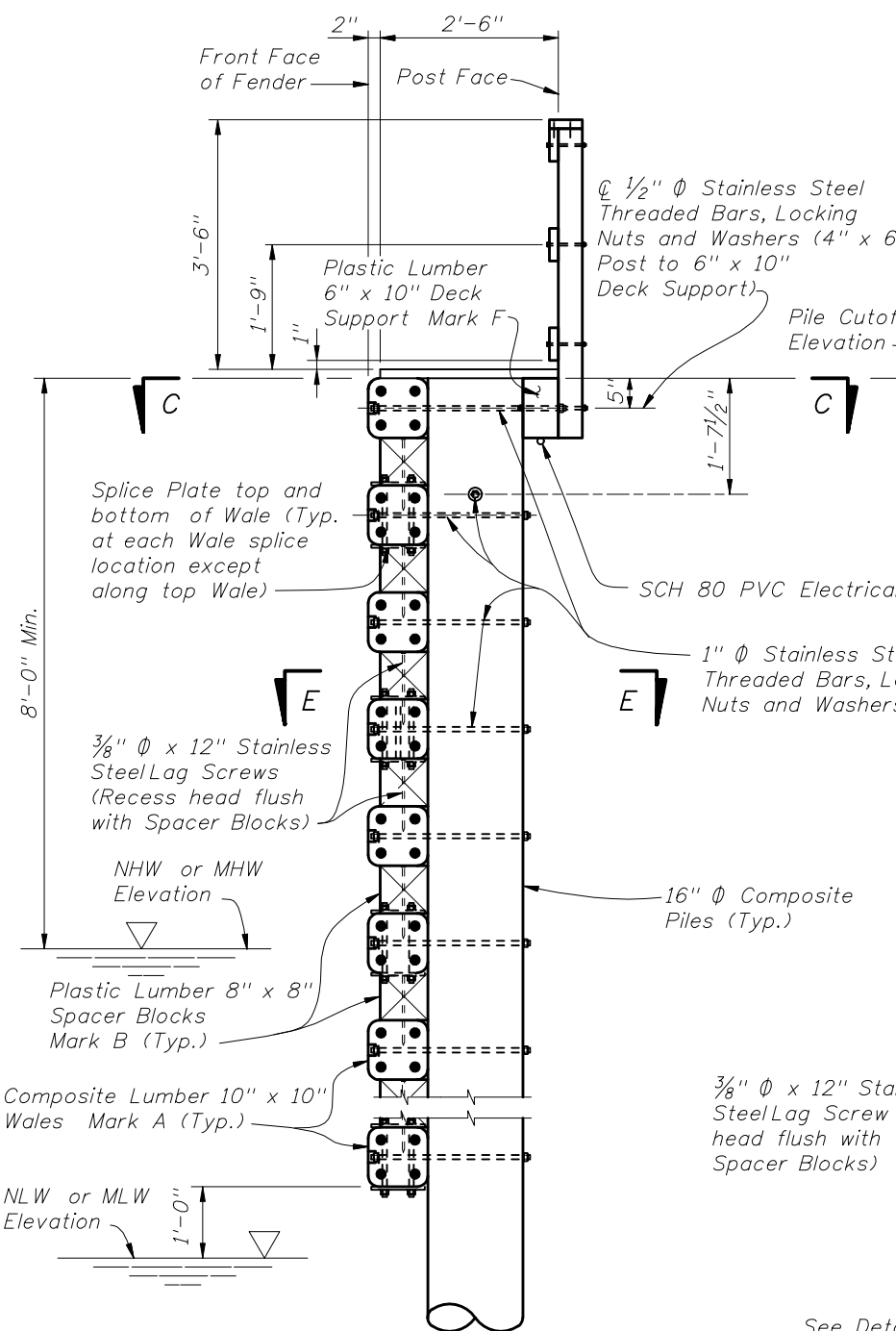

SECTION A-A

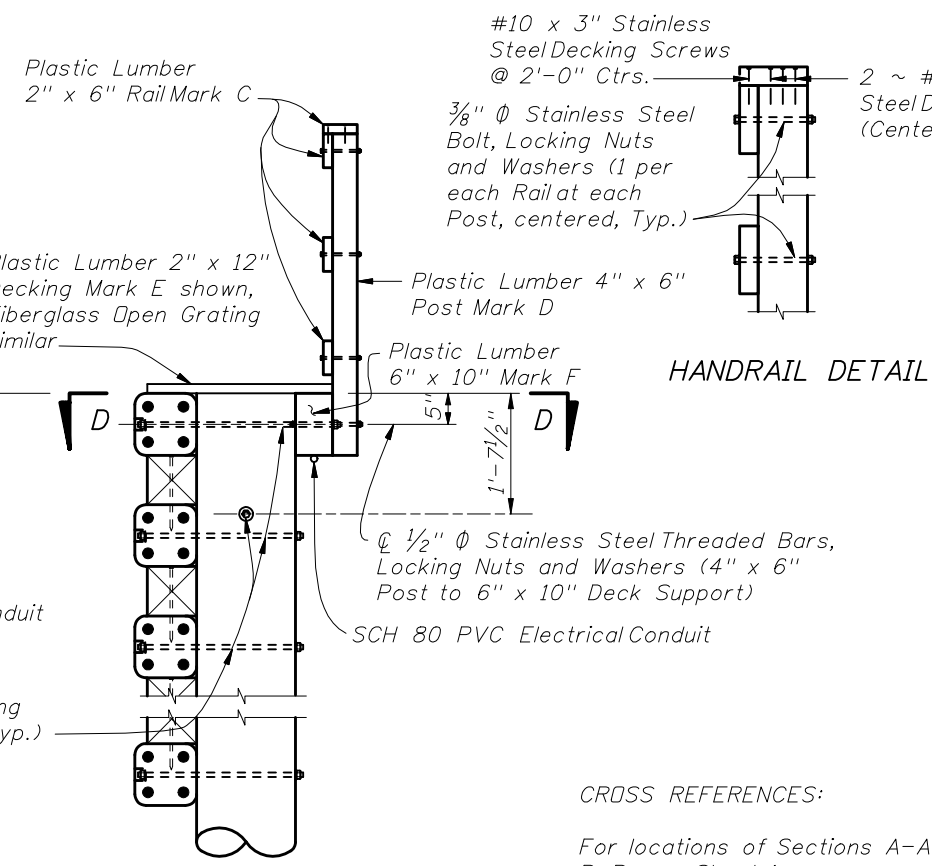
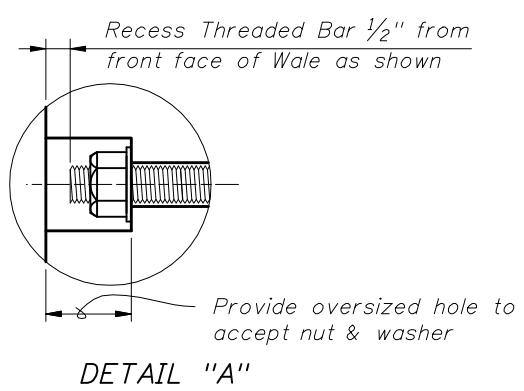

SECTION B-B

CROSS REFERENCES:  
 For locations of Sections A-A and B-B see Sheet 1.  
 For Section E-E see Sheet 3.

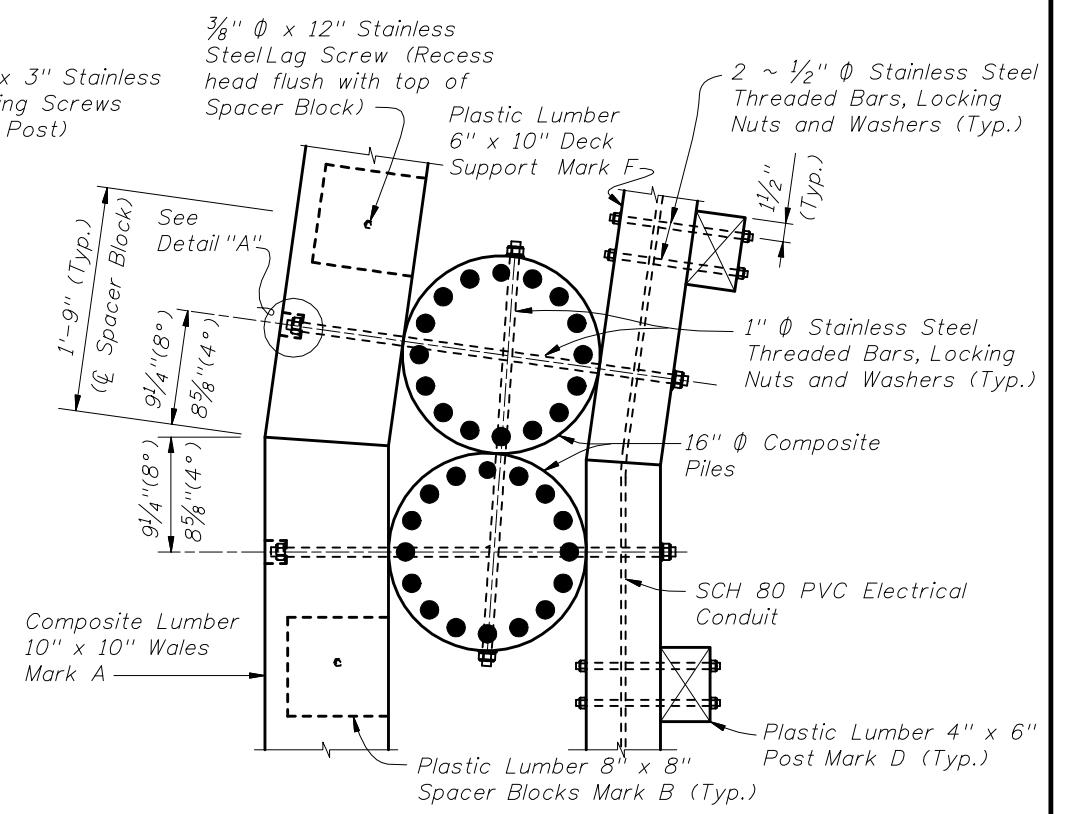

SECTION C-C  
 TYPICAL FLARED SECTION  
 (8° TURN SHOWN, 4° TURN SIMILAR)

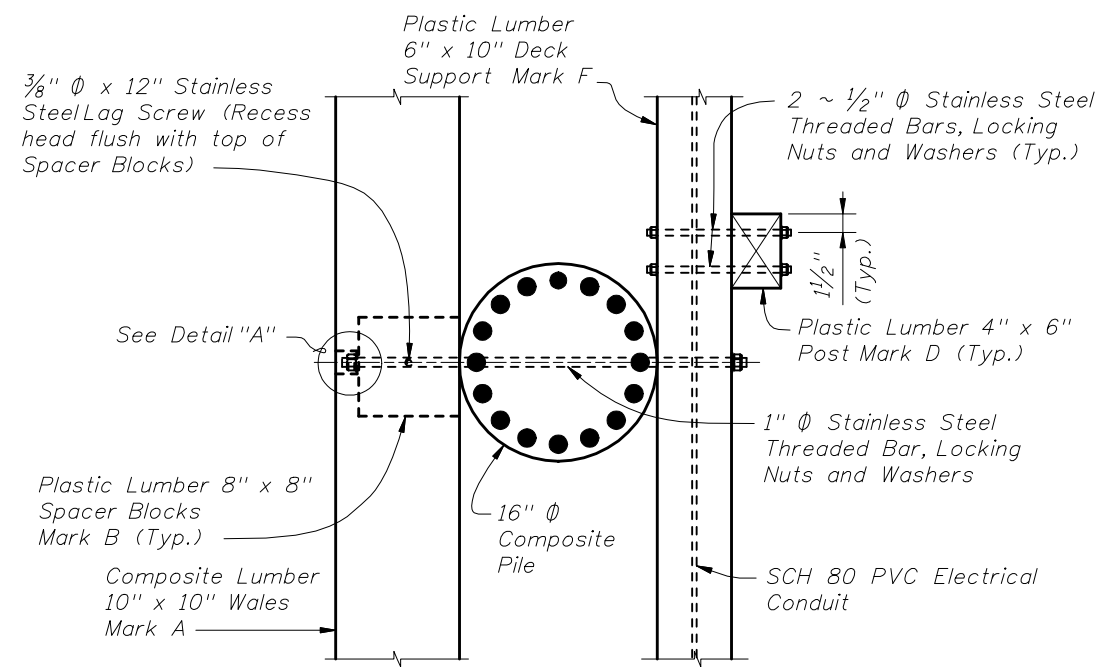

SECTION D-D  
 TYPICAL AT INTERMEDIATE PILES

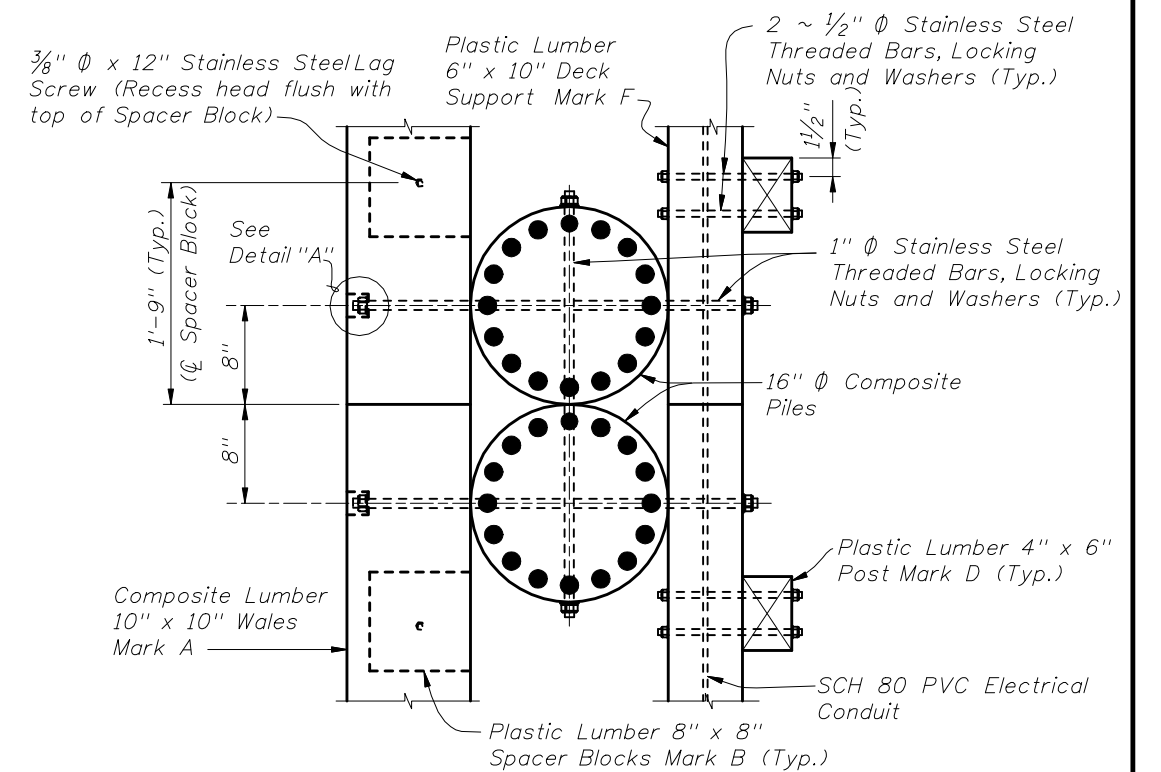

SECTION C-C  
 TYPICAL STRAIGHT SECTION



2010 FDOT Design Standards

FENDER SYSTEM - MEDIUM DUTY

|               |           |
|---------------|-----------|
| Last Revision | Sheet No. |
| 01/01/06      | 2 of 5    |
| Index No.     |           |
| 21920         |           |

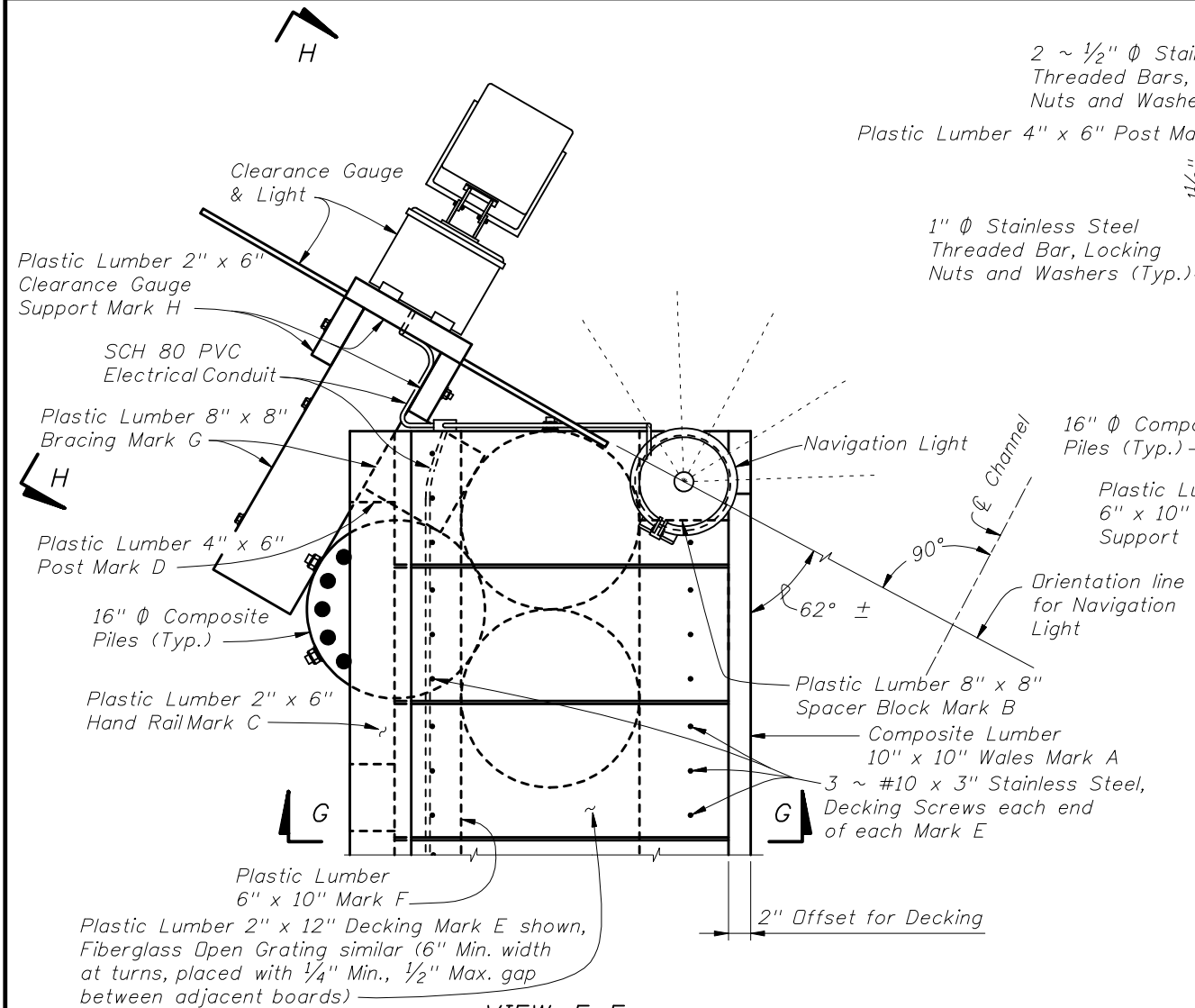

VIEW F-F (SHOWING FENDER END; DECKING, HANDRAIL AND CLEARANCE GAUGE NOT SHOWN FOR CLARITY)

CROSS REFERENCES:

- For Navigation Lights and SCH 80 PVC Electrical Conduit Details see Design Standard Index 21220.
- For Clearance Gauge Details and View H-H see Sheet 4.
- For Detail "A" and location of Section E-E see Sheet 2.
- For location of View F-F see Sheet 1.

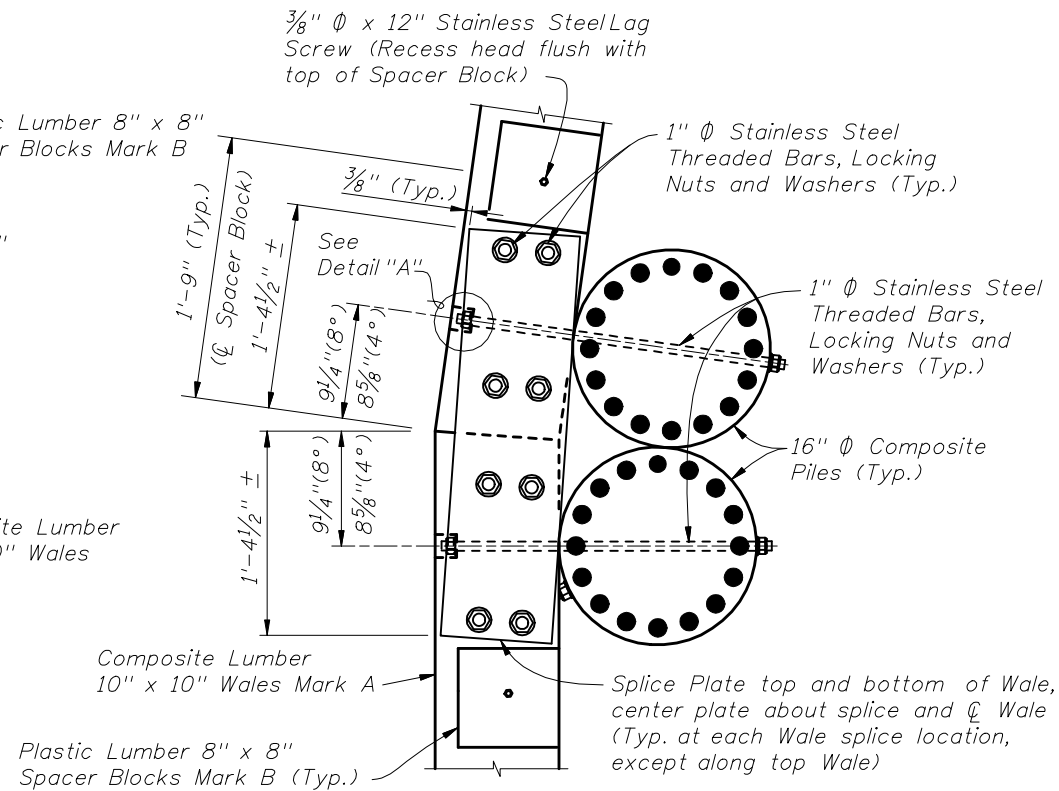

SECTION E-E TYPICAL FLARED SECTION (8° TURN SHOWN, 4° TURN SIMILAR)

VIEW F-F (SHOWING FENDER END WITH CLEARANCE GAUGE)

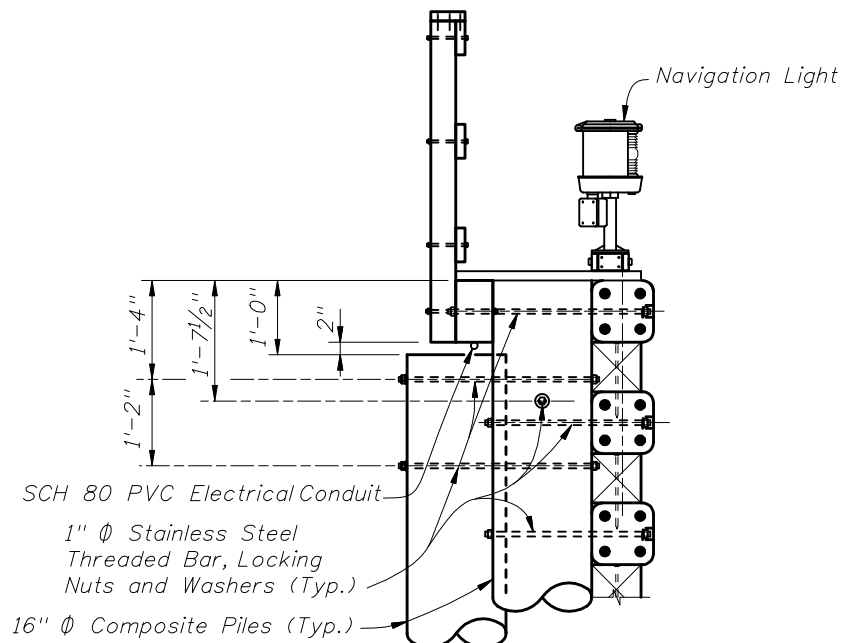

SECTION G-G (CLEARANCE GAUGE NOT SHOWN FOR CLARITY)

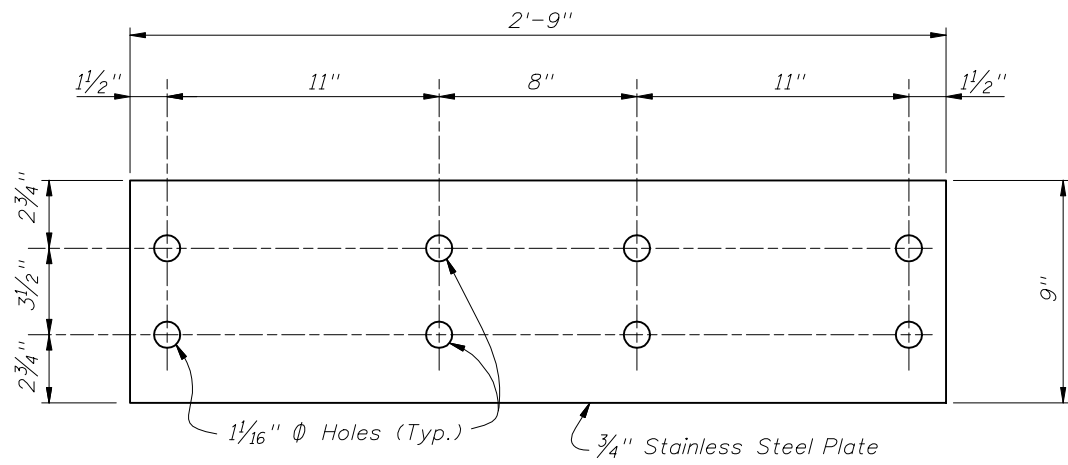

SPLICE PLATE DETAIL

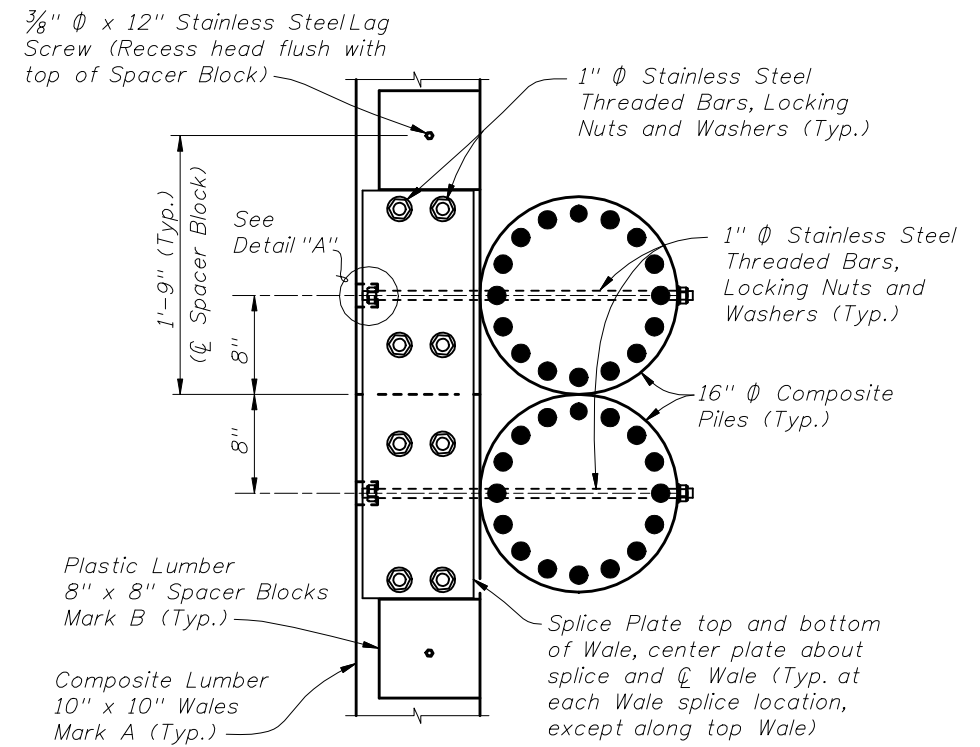

SECTION E-E TYPICAL STRAIGHT SECTION



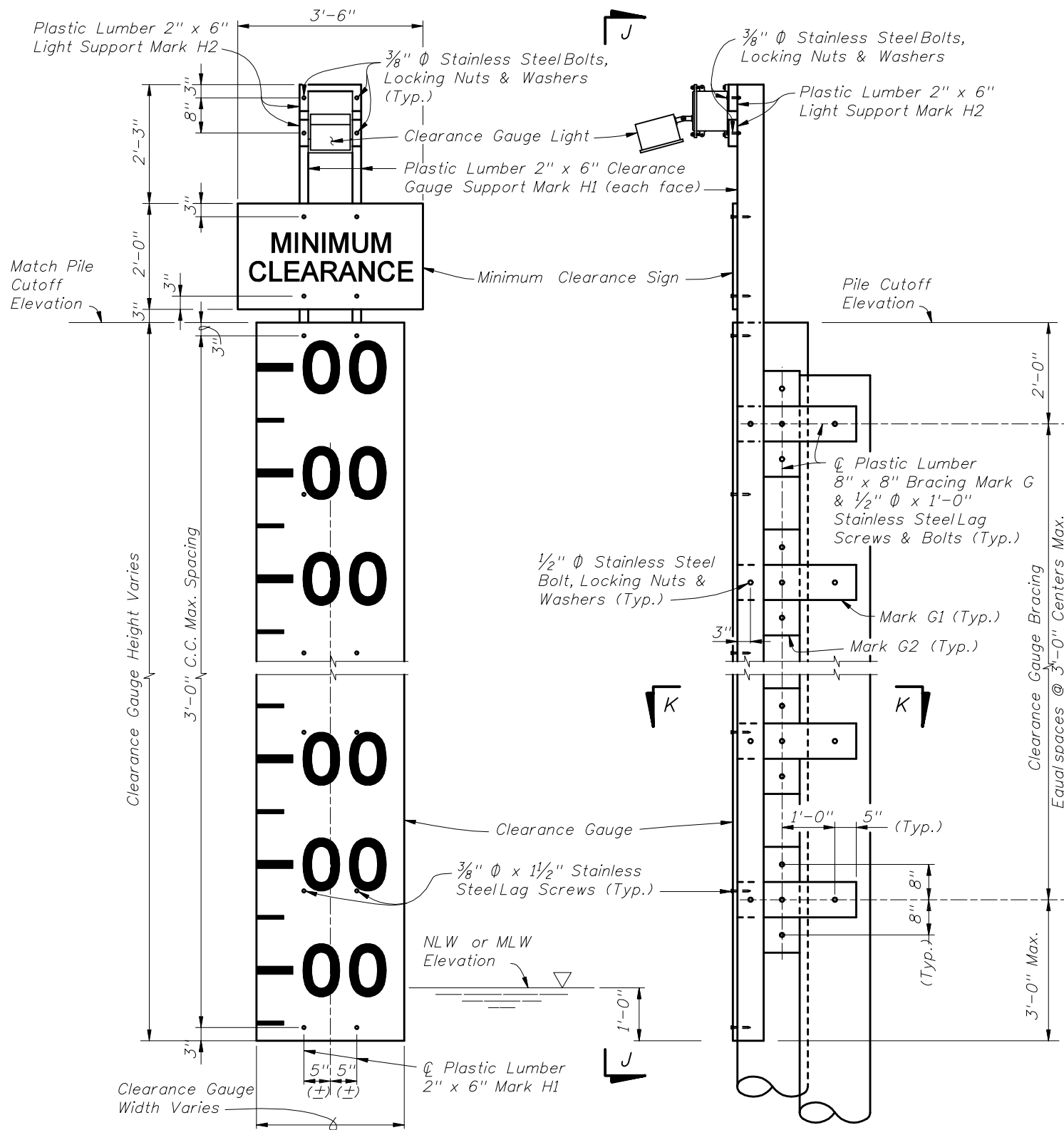

VIEW J-J  
(WALES, PILES AND BRACING  
NOT SHOWN FOR CLARITY)

VIEW H-H  
(WALES, DECKING AND HANDRAIL  
NOT SHOWN FOR CLARITY)

**CLEARANCE GAUGE DETAILS**

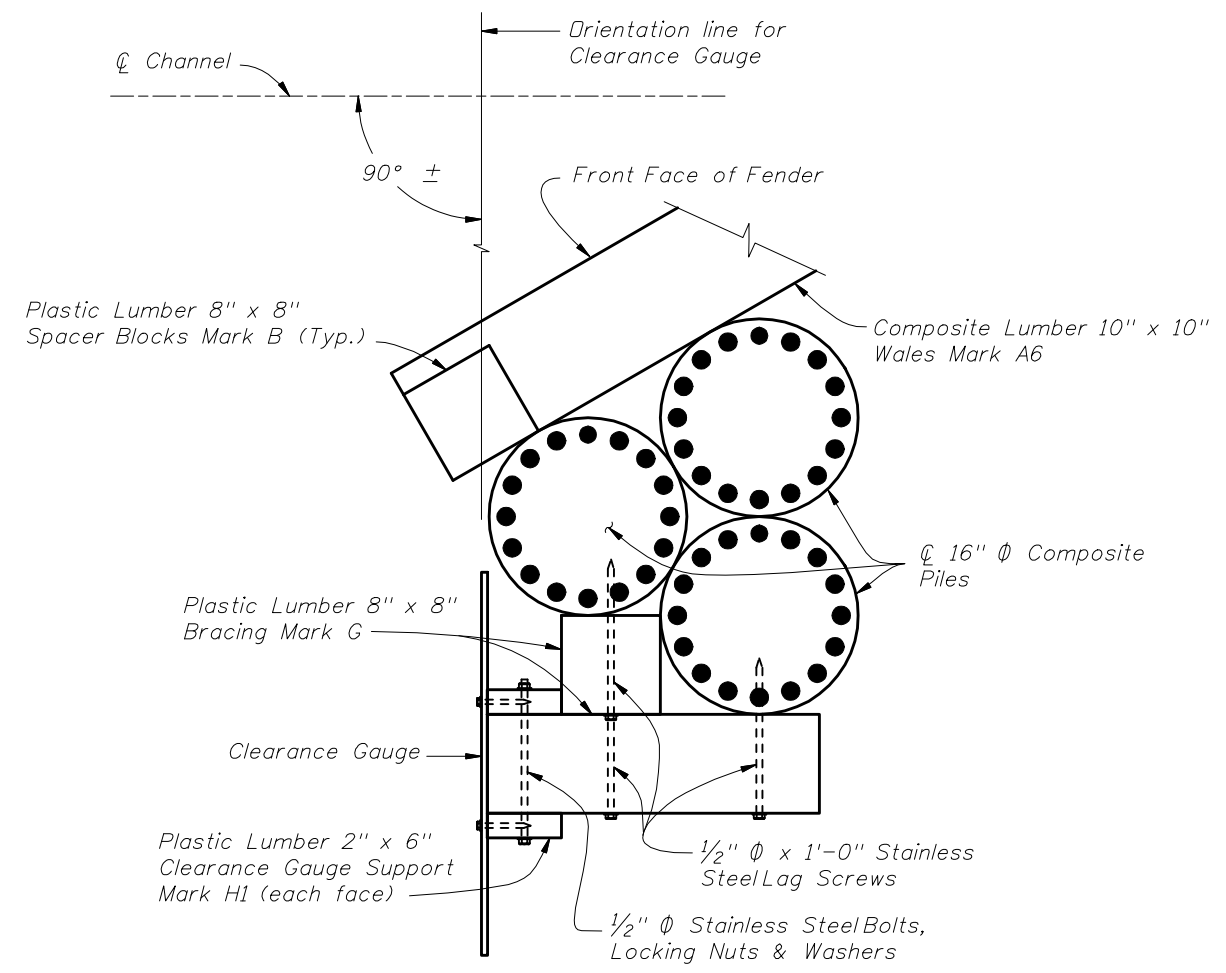

SECTION K-K

CROSS REFERENCES:  
For Structural Composite and Plastic Lumber Bill of Materials Quantities and Fender System Table of Variables see Structures Plans.

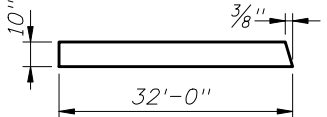
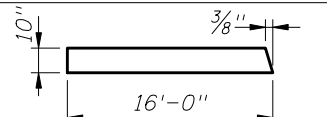
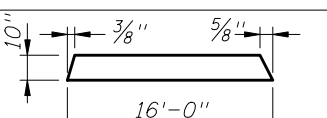
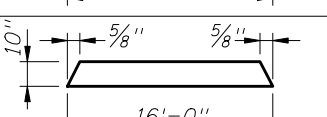
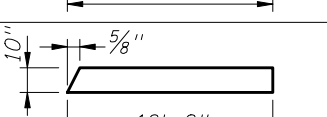

| * STRUCTURAL COMPOSITE LUMBER BILL OF MATERIALS |                            |   |                    |   |          |
|---|----------------------------|---|--------------------|---|----------|
| MARK  | SIZE (NOMINAL)             | DIMENSIONS  | BOARD FT. PER EACH | NO. REQD.   | QUANTITY |
| A1  | 10" X 10" COMPOSITE LUMBER | 32'-0" (STRAIGHT)   | 266.6              | See Estimated Structural Composite and Plastic Lumber Bill of Materials Table in Structures Plans |          |
| A2  | 10" X 10" COMPOSITE LUMBER |  | 266.6              |   |          |
| A3  | 10" X 10" COMPOSITE LUMBER |  | 133.3              |   |          |
| A4  | 10" X 10" COMPOSITE LUMBER |  | 133.3              |   |          |
| A5  | 10" X 10" COMPOSITE LUMBER |  | 133.3              |   |          |
| A6  | 10" X 10" COMPOSITE LUMBER |  | 133.3              |   |          |

\* All Plastic Lumber and Composite Lumber Dimensions and Quantities shown are based on Nominal Lumber Dimensions and may vary depending on Actual Lumber Dimension.

\*\* Provide Fiberglass Open Grating in lieu of 2" X 12" Plastic Lumber when called for in the Plans. Mounting hardware shall be Stainless Steel, install per Manufacturer's recommendations. See Index No. 21900 and Structures Plans for Notes and Details.

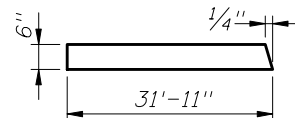
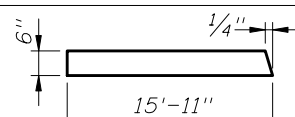
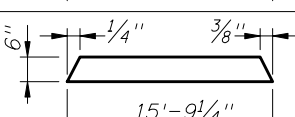
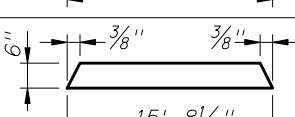
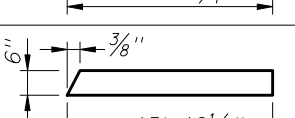
| * PLASTIC LUMBER BILL OF MATERIALS |                         |   |                    |   |          |
|------------------------------------|-------------------------|---|--------------------|---|----------|
| MARK                               | SIZE (NOMINAL)          | DIMENSIONS  | BOARD FT. PER EACH | NO. REQD.   | QUANTITY |
| B                                  | 8" X 8" PLASTIC LUMBER  | 8" (STRAIGHT)   | 3.6                | See Estimated Structural Composite and Plastic Lumber Bill of Materials Table in Structures Plans |          |
| C                                  | 2" X 6" PLASTIC LUMBER  | 16'-0" (STRAIGHT)<br>(Trim & Miter Ends as required)                                  | 16.0               |   |          |
| D                                  | 4" X 6" PLASTIC LUMBER  | 4'-4" (STRAIGHT)  | 8.7                |   |          |
| ** E                               | 2" X 12" PLASTIC LUMBER | 2'-6" (STRAIGHT)<br>(Miter as required)   | 5.0                |   |          |
| F1                                 | 6" X 10" PLASTIC LUMBER | 32'-0" (STRAIGHT)   | 160.0              |   |          |
| F2                                 | 6" X 10" PLASTIC LUMBER |    | 159.6              |   |          |
| F3                                 | 6" X 10" PLASTIC LUMBER |    | 79.6               |   |          |
| F4                                 | 6" X 10" PLASTIC LUMBER |    | 78.8               |   |          |
| F5                                 | 6" X 10" PLASTIC LUMBER |   | 78.4               |   |          |
| F6                                 | 6" X 10" PLASTIC LUMBER |  | 79.2               |   |          |
| G1                                 | 8" X 8" PLASTIC LUMBER  | 2'-3" (STRAIGHT)  | 12.0               |   |          |
| G2                                 | 8" X 8" PLASTIC LUMBER  | 2'-0" (STRAIGHT)  | 10.7               |   |          |
| H1                                 | 2" X 6" PLASTIC LUMBER  | PILE CUTOFF ELEV. MINUS NLW OR MLW ELEV. PLUS 5'-6" (STRAIGHT)                        | 1.0 PER LF EACH    |   |          |
| H2                                 | 2" X 6" PLASTIC LUMBER  | 1'-0" (STRAIGHT)  | 1.0                |   |          |



**CROSS REFERENCES:**

For Sections A-A and B-B see Sheet 2.

For View F-F see Sheet 3.

**NOTE:**

Plastic Lumber and Composite Lumber Dimensions shown are based on Nominal Lumber Dimensions and may vary depending on Actual Lumber Dimension.

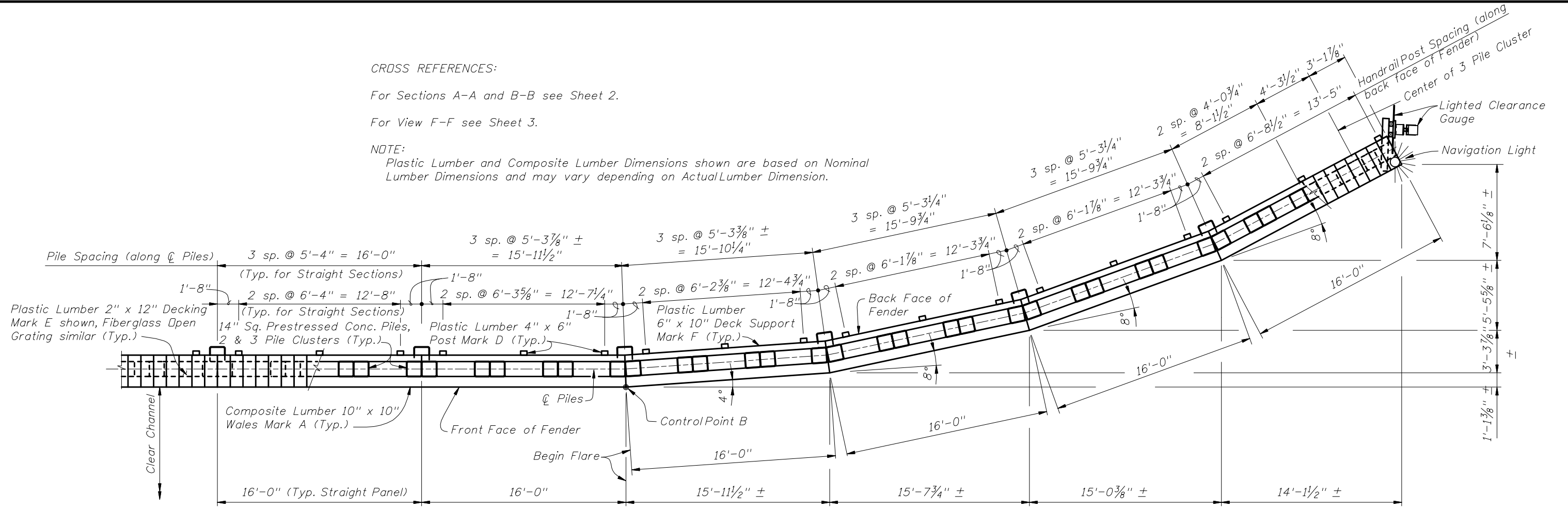

**PARTIAL PLAN VIEW (TYPICAL FLARE)**  
 (FLARE AT CONTROL POINT B SHOWN, CONTROL POINTS A, C & D SIMILAR)  
 (HANDRAIL NOT SHOWN FOR CLARITY)

Navigation Light (See Design Standards Index 21220 for locations & Details)

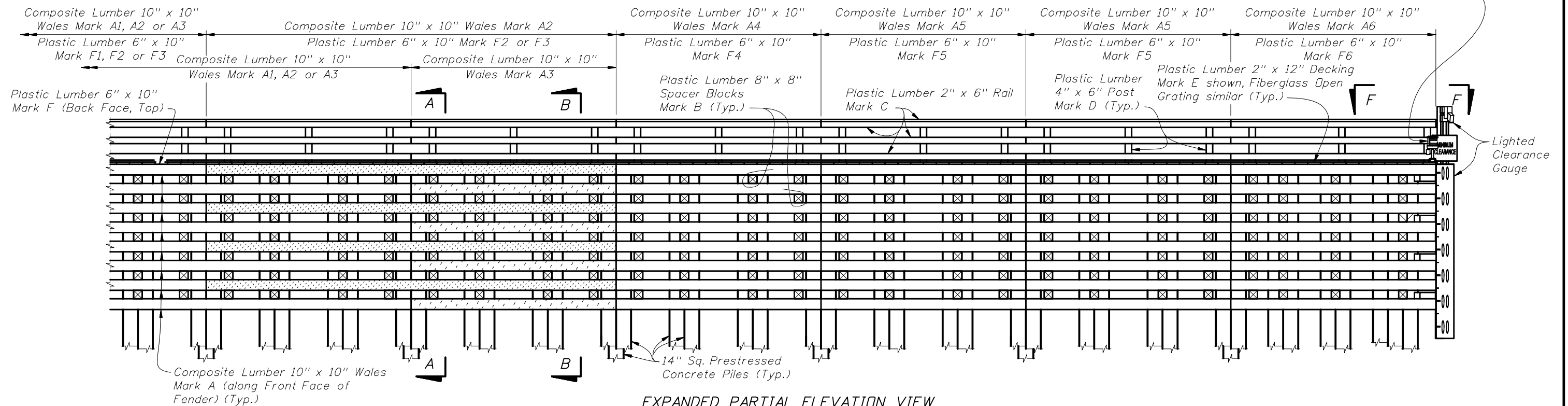

**EXPANDED PARTIAL ELEVATION VIEW**



2010 FDOT Design Standards

**FENDER SYSTEM - LIGHT DUTY**

|               |           |
|---------------|-----------|
| Last Revision | Sheet No. |
| 01/01/06      | 1 of 5    |
| Index No.     |           |
| 21930         |           |

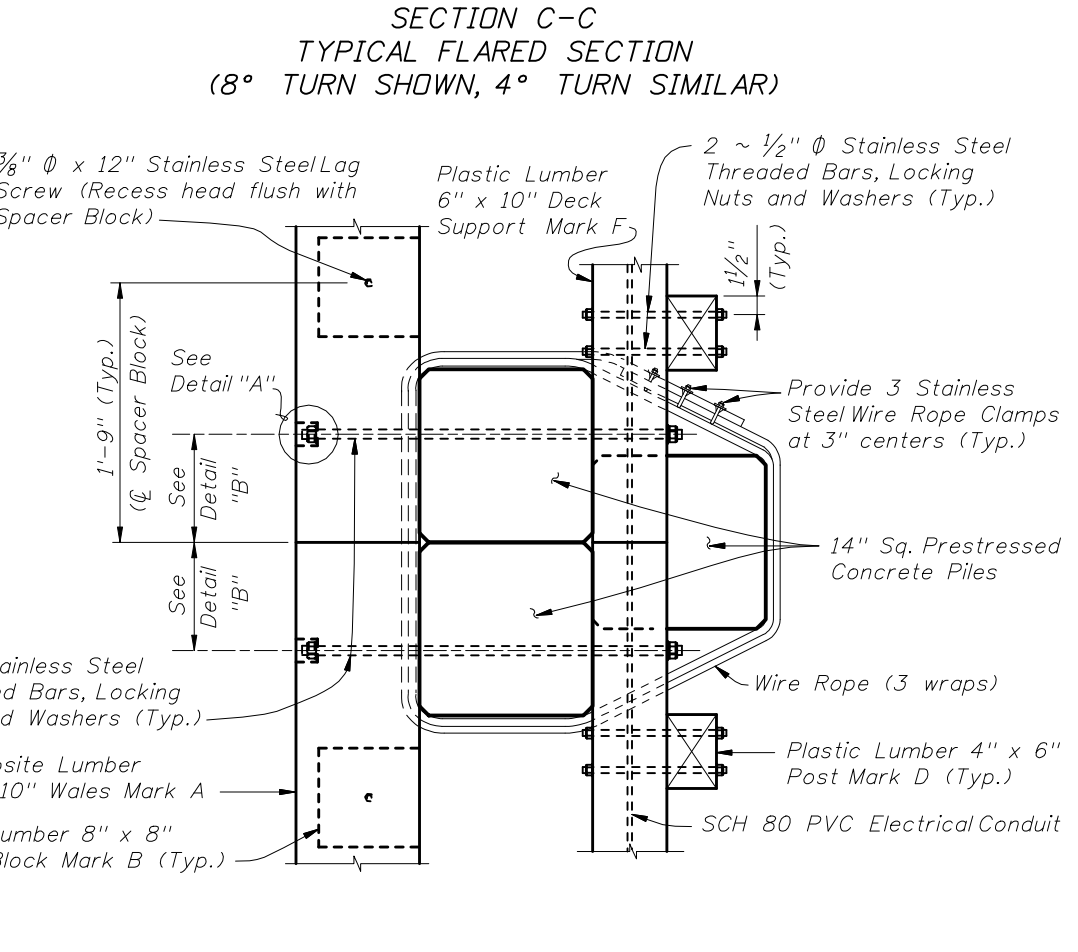
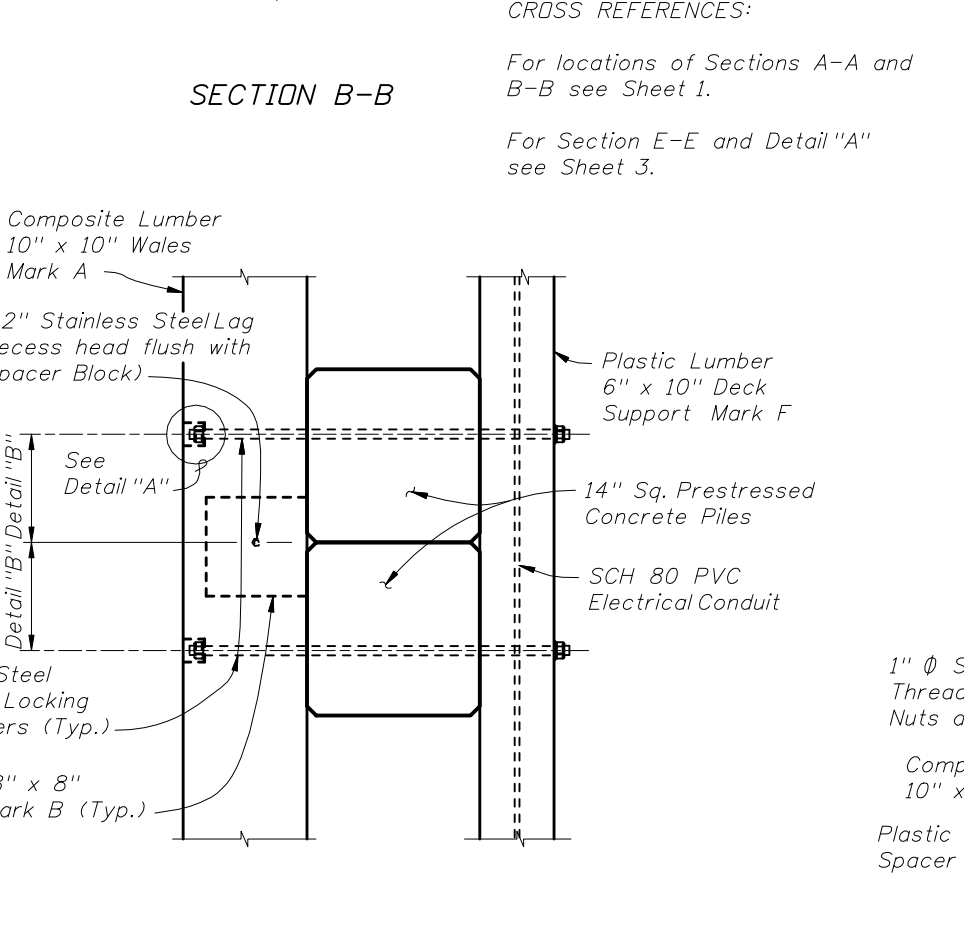
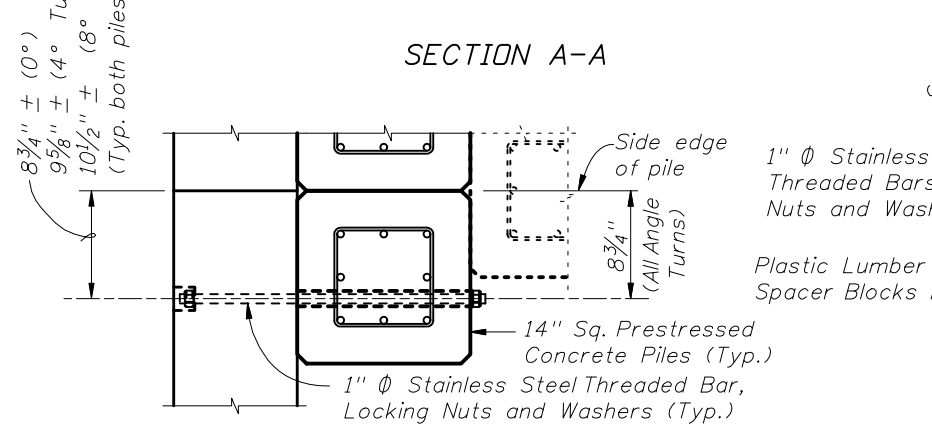
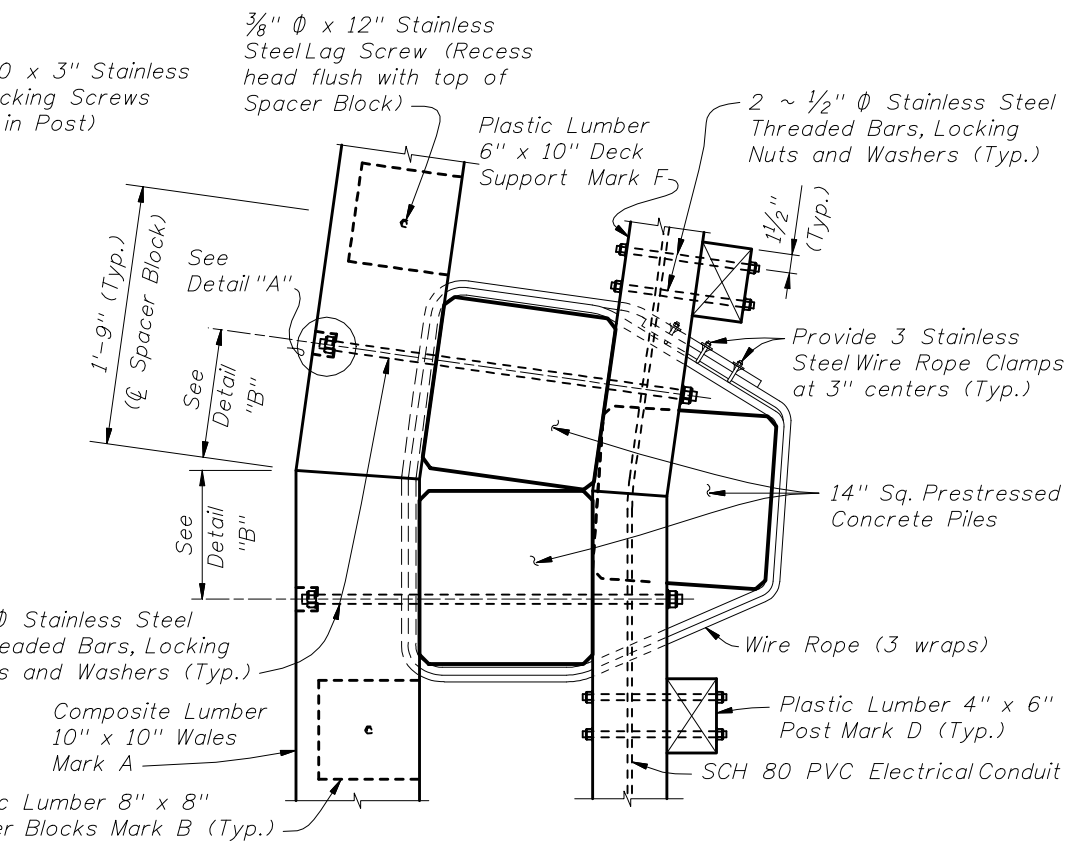
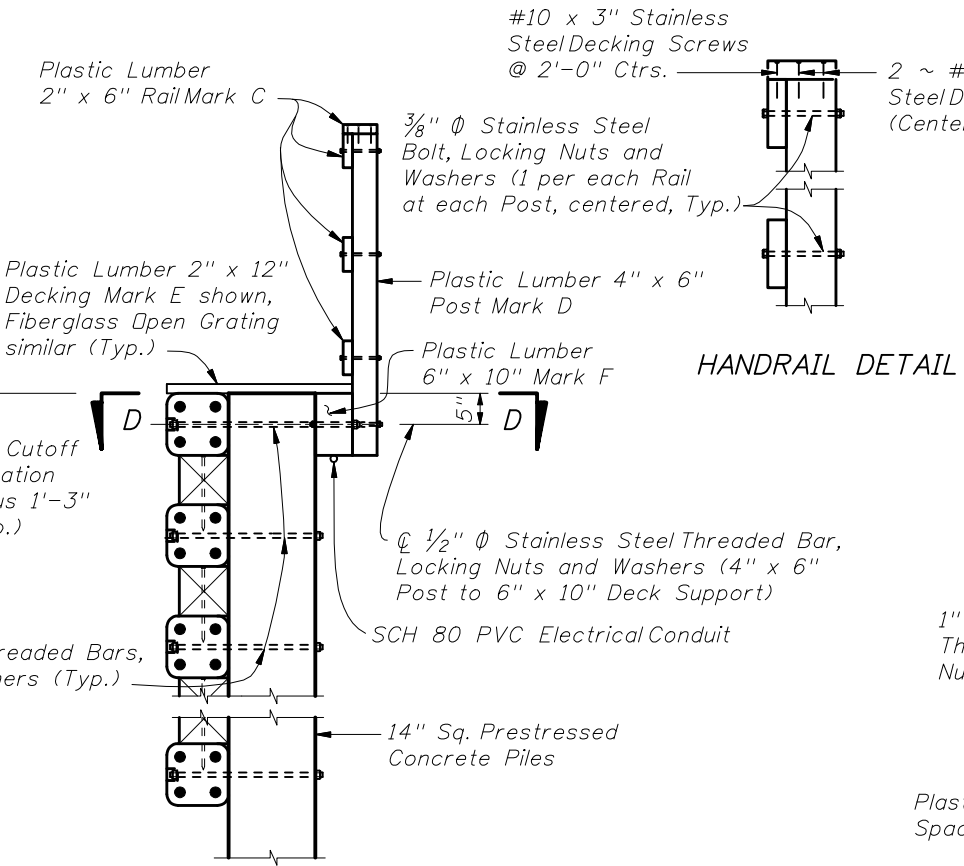
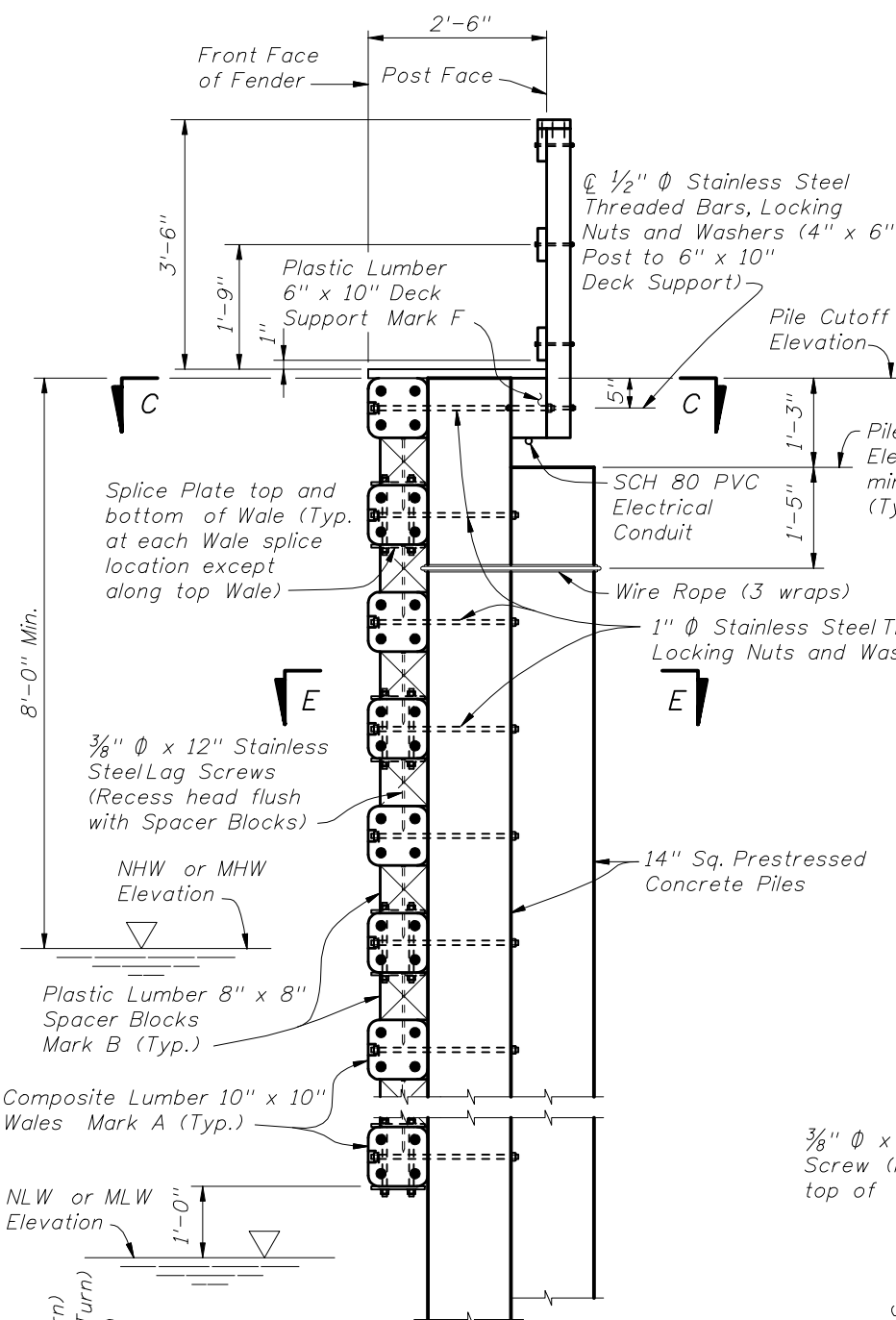

CROSS REFERENCES:  
For locations of Sections A-A and B-B see Sheet 1.  
For Section E-E and Detail "A" see Sheet 3.



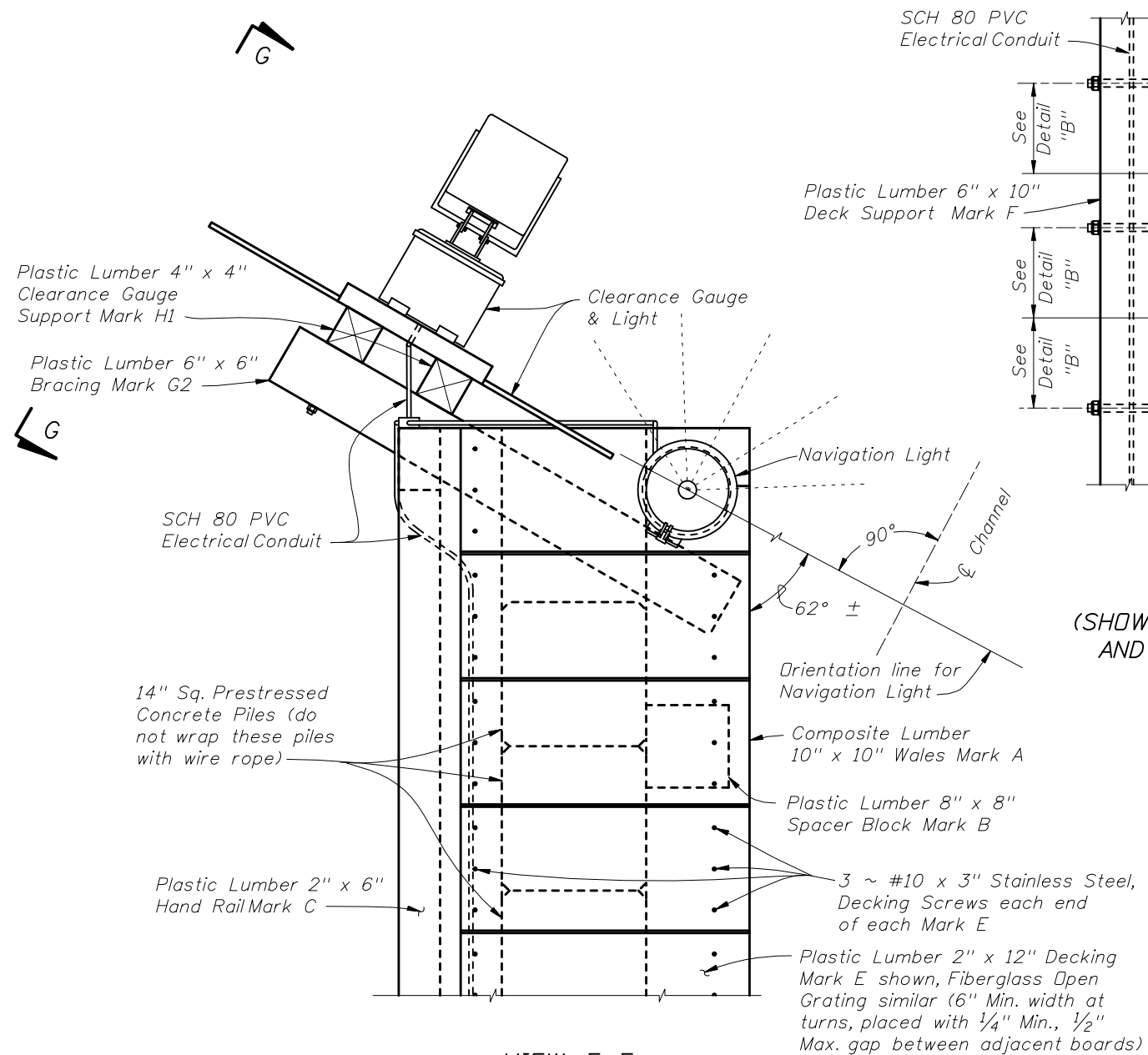

VIEW F-F  
(SHOWING FENDER END WITH CLEARANCE GAUGE)

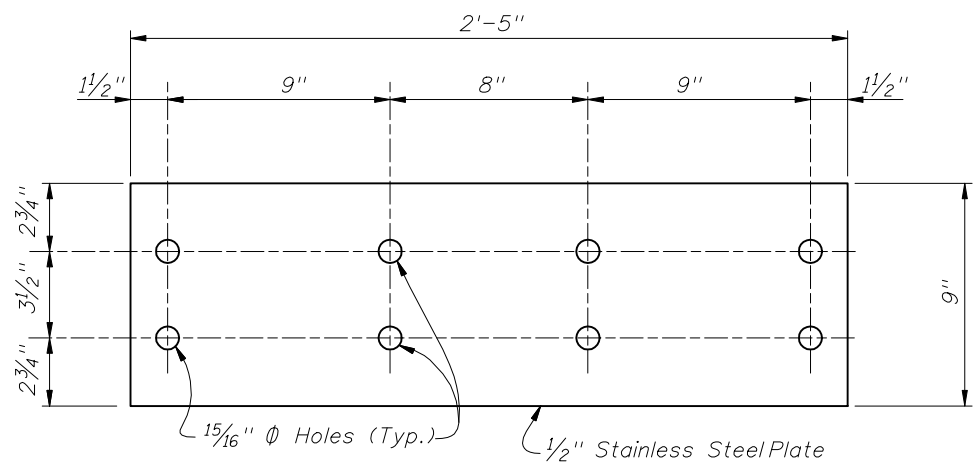

SPLICE PLATE DETAIL

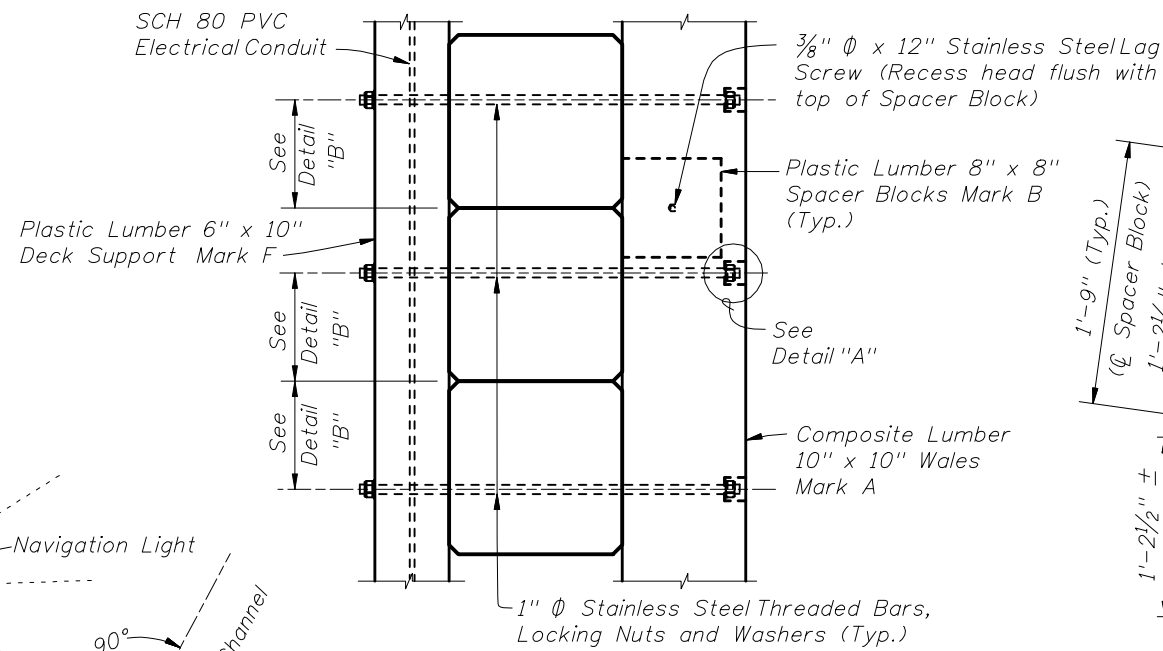

PARTIAL VIEW F-F  
(SHOWING FENDER END; DECKING  
AND HANDRAIL NOT SHOWN  
FOR CLARITY)

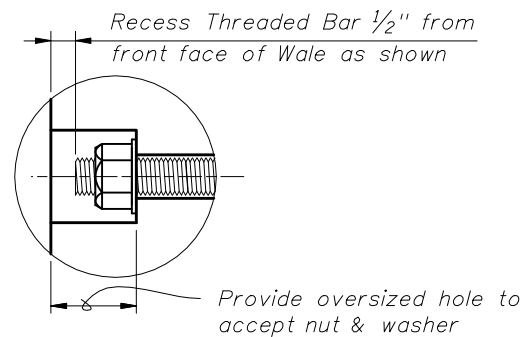

DETAIL "A"

CROSS REFERENCES:

For Navigation Lights and SCH 80 PVC Electrical Conduit Details see Design Standard Index 21220.

For View G-G and Clearance Gauge Details see Sheet 4.

For Detail "B" and location of Section E-E see Sheet 2.

For location of View F-F see Sheet 1.

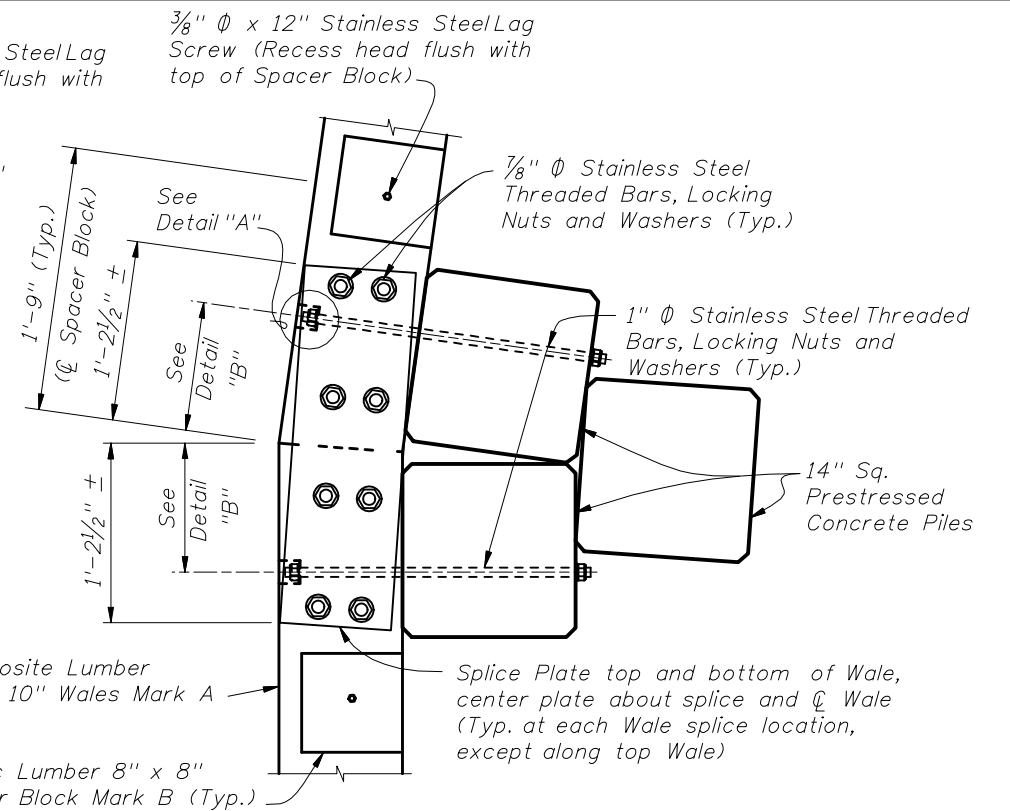

SECTION E-E  
TYPICAL FLARED SECTION  
(8° TURN SHOWN, 4° TURN SIMILAR)

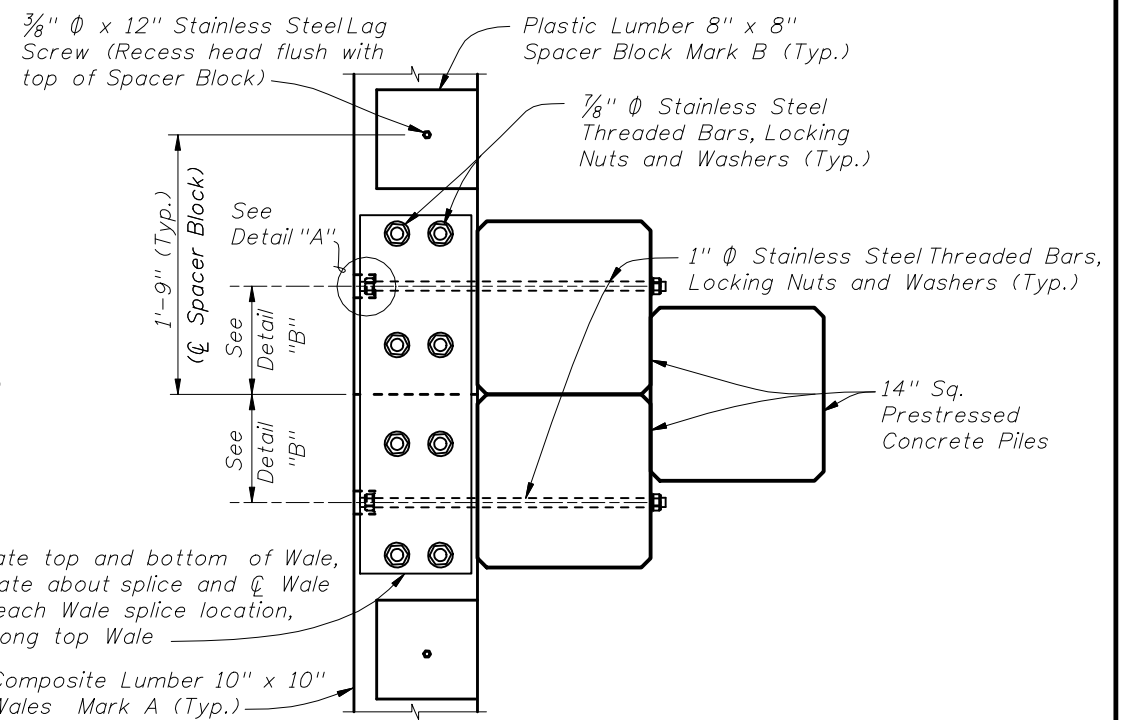

SECTION E-E  
TYPICAL STRAIGHT SECTION



2010 FDOT Design Standards

FENDER SYSTEM - LIGHT DUTY

|               |           |
|---------------|-----------|
| Last Revision | Sheet No. |
| 01/01/06      | 3 of 5    |
| Index No.     |           |
| 21930         |           |

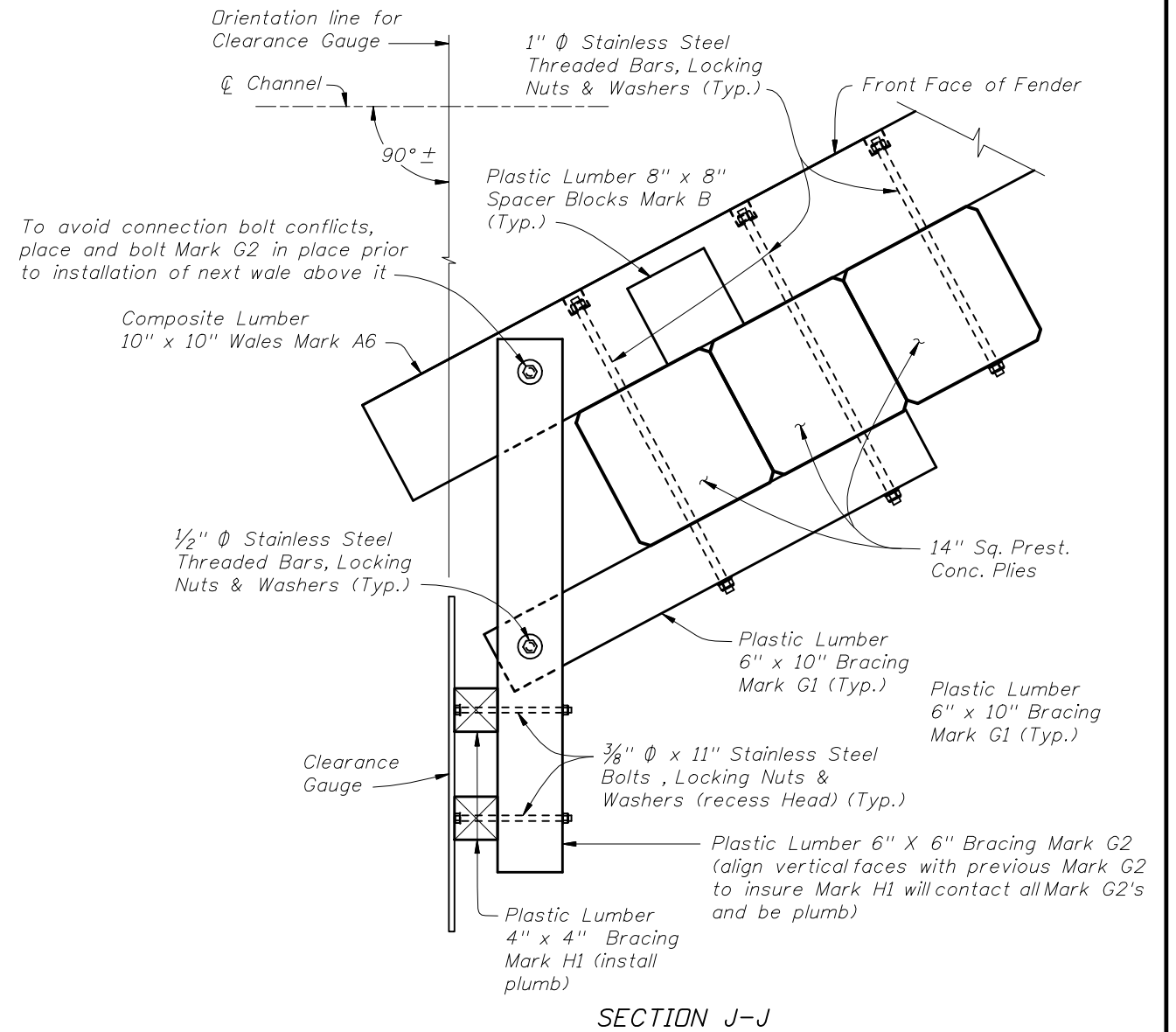
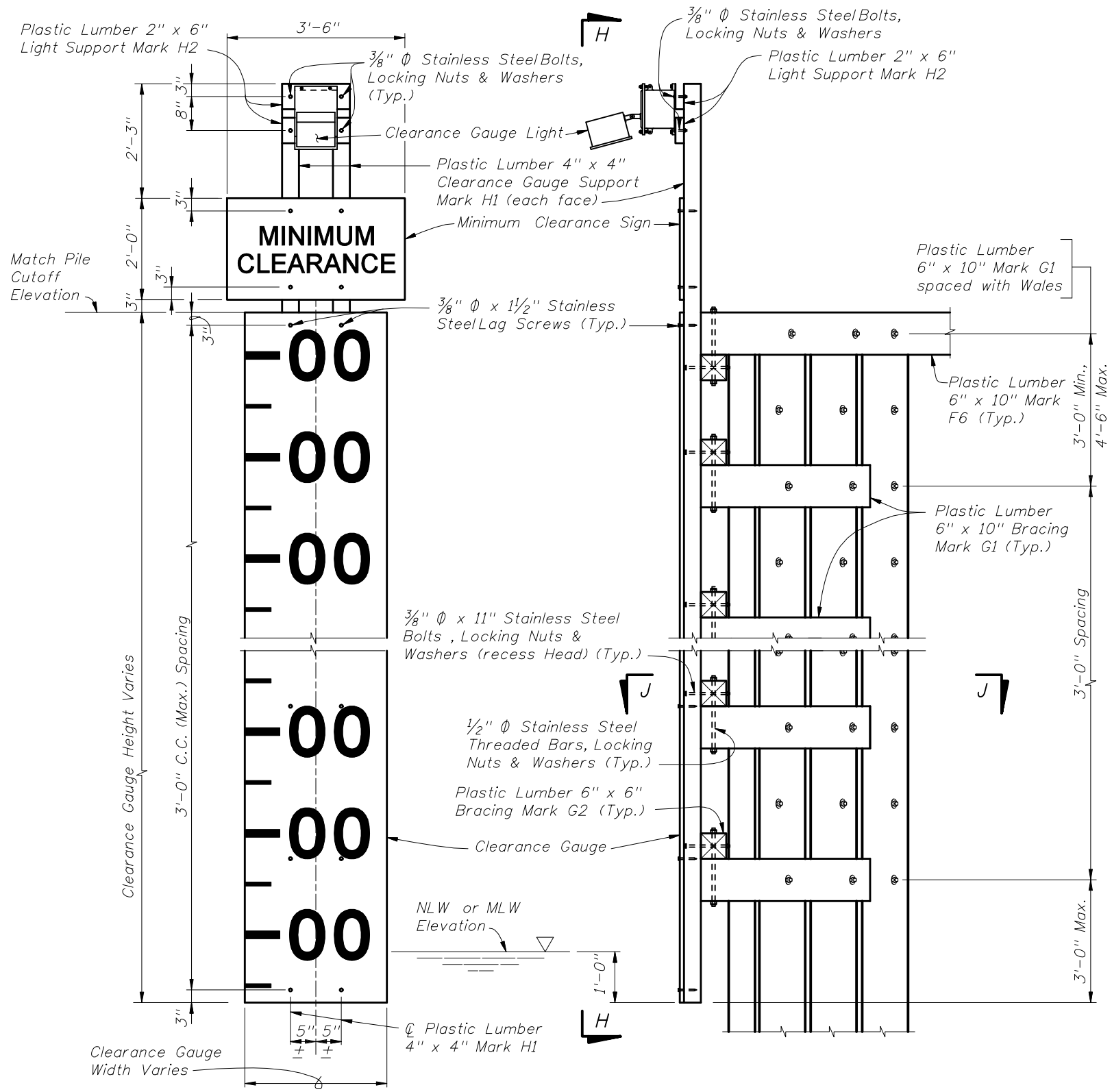

**CROSS REFERENCES:**

For Estimated Structural Composite and Plastic Lumber Bill of Materials Quantities and Fender System Table of Variables see Structures Plans.

For location of View G-G see Sheet 3.

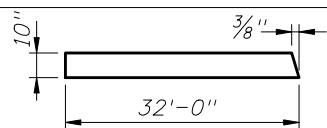
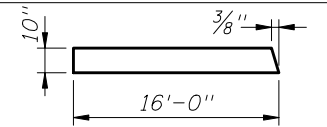
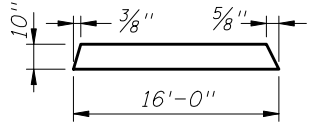
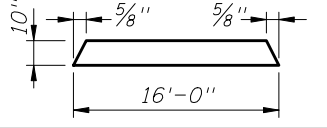
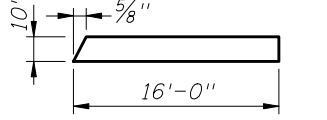

| * STRUCTURAL COMPOSITE LUMBER BILL OF MATERIALS |                            |   |                    |   |          |
|---|----------------------------|---|--------------------|---|----------|
| MARK  | SIZE (NOMINAL)             | DIMENSIONS  | BOARD FT. PER EACH | NO. REQD.   | QUANTITY |
| A1  | 10" X 10" COMPOSITE LUMBER | 32'-0" (STRAIGHT)   | 266.6              | See Estimated Structural Composite and Plastic Lumber Bill of Materials Table in Structures Plans |          |
| A2  | 10" X 10" COMPOSITE LUMBER |  | 266.6              |   |          |
| A3  | 10" X 10" COMPOSITE LUMBER |  | 133.3              |   |          |
| A4  | 10" X 10" COMPOSITE LUMBER |  | 133.3              |   |          |
| A5  | 10" X 10" COMPOSITE LUMBER |  | 133.3              |   |          |
| A6  | 10" X 10" COMPOSITE LUMBER |  | 133.3              |   |          |

\* All Plastic Lumber and Composite Lumber Dimensions and Quantities shown are based on Nominal Lumber Dimensions and may vary depending on Actual Lumber Dimension.

\*\* Provide Fiberglass Open Grating in lieu of 2" X 12" Plastic Lumber when called for in the Plans. Mounting hardware shall be Stainless Steel, install per Manufacturer's recommendations. See Index No. 21900 and Structures Plans for Notes and Details.

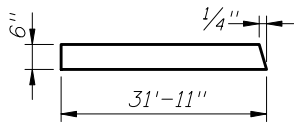
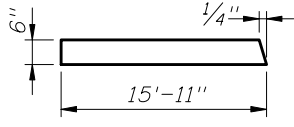
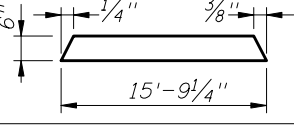
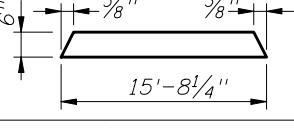
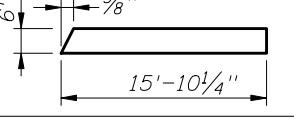
| * PLASTIC LUMBER BILL OF MATERIALS |                         |   |                    |   |          |
|------------------------------------|-------------------------|---|--------------------|---|----------|
| MARK                               | SIZE (NOMINAL)          | DIMENSIONS  | BOARD FT. PER EACH | NO. REQD.   | QUANTITY |
| B                                  | 8" X 8" PLASTIC LUMBER  | 8" (STRAIGHT)   | 3.6                | See Estimated Structural Composite and Plastic Lumber Bill of Materials Table in Structures Plans |          |
| C                                  | 2" X 6" PLASTIC LUMBER  | 16'-0" (STRAIGHT)<br>(Trim & Miter Ends as required)                                  | 16.0               |   |          |
| D                                  | 4" X 6" PLASTIC LUMBER  | 4'-4" (STRAIGHT)  | 8.7                |   |          |
| ** E                               | 2" X 12" PLASTIC LUMBER | 2'-6" (STRAIGHT)<br>(Miter as required, 6" min. width)                                | 5.0                |   |          |
| F1                                 | 6" X 10" PLASTIC LUMBER | 32'-0" (STRAIGHT)   | 160.0              |   |          |
| F2                                 | 6" X 10" PLASTIC LUMBER |    | 159.6              |   |          |
| F3                                 | 6" X 10" PLASTIC LUMBER |    | 79.6               |   |          |
| F4                                 | 6" X 10" PLASTIC LUMBER |    | 78.8               |   |          |
| F5                                 | 6" X 10" PLASTIC LUMBER |   | 78.4               |   |          |
| F6                                 | 6" X 10" PLASTIC LUMBER |  | 79.3               |   |          |
| G1                                 | 6" X 10" PLASTIC LUMBER | 3'-8" (STRAIGHT)  | 18.3               |   |          |
| G2                                 | 6" X 6" PLASTIC LUMBER  | 4'-1" (STRAIGHT)  | 12.3               |   |          |
| H1                                 | 4" X 4" PLASTIC LUMBER  | PILE CUTOFF ELEV. MINUS NLW OR MLW ELEV. PLUS 5'-6" (STRAIGHT)                        | 1.3 PER LF EACH    |   |          |
| H2                                 | 2" X 6" PLASTIC LUMBER  | 1'-2" (STRAIGHT)  | 1.2                |   |          |

