

**PLAN - OPTION B**  
**SPREAD FOOTING ADJACENT TO SKEWED APPROACH SLAB AND WITH BARRIER WALL INLET**  
 (Option A Similar)

**NOTES**

1. **CONSTRUCTION REQUIREMENTS:** Construct the Spread Footing level transversely and expansion joints plumb; do not construct the spread footing perpendicular to the roadway surface. Slip forming is not permitted.
2. **CONCRETE:** Use Class II concrete for slightly aggressive environments. Use Class IV concrete for moderately or extremely aggressive environments. Concrete will be in accordance with Specification Section 346.
3. **REINFORCING STEEL:** Provide Grade 60 reinforcing steel in accordance with Specification Section 931. Dowel Load Transfer Devices will be ASTM A 36 smooth round bar and hot-dip galvanized in accordance with Specification Section 962. Install Dowel Load Transfer Devices in accordance with Specification Section 350.
4. Construct 3/4" Expansion Joints plumb and perpendicular or radial to Gutter Line. Provide at 90'-0" maximum intervals as shown.
5. Provide and install Preformed Expansion Joint Filler in accordance with Specification Section 932.
6. Construct 1/2" V-Grooves plumb and provide at 30'-0" maximum intervals as shown. Space V-Grooves equally between 3/4" Expansion Joints and/or Begin or End Spread Footing. V-Groove locations are to coincide with V-Groove locations in the Railing/Sound Barrier.
7. **FILL REQUIREMENTS:** Shoulder or Roadway Pavement and Fill is required on the traffic side of the spread footing for a distance of 4'-0" and the full length of the spread footing (3'-0" minimum depth) on the backside of the spread footing for Option A. Fill is required for a distance of 4'-0" on the backside of the spread footing and the full length of the spread footing (3'-0" minimum depth) on the traffic side of the spread footing for Option B. See Typical Sections on Sheet Nos. 2 and 3 for details.
8. Spacing shown is along the Gutter Line.
9. Work this Standard Drawing with one or both of the following:
  - a. Index No. 5210 - Traffic Railing/Sound Barrier (8'-0").
  - b. Index No. 5211 - Traffic Railing/Sound Barrier (14'-0").

**CROSS REFERENCE:**  
 For Detail "A", see Sheet 3.  
 For Section A-A and Estimated Quantities, see Sheet 4.

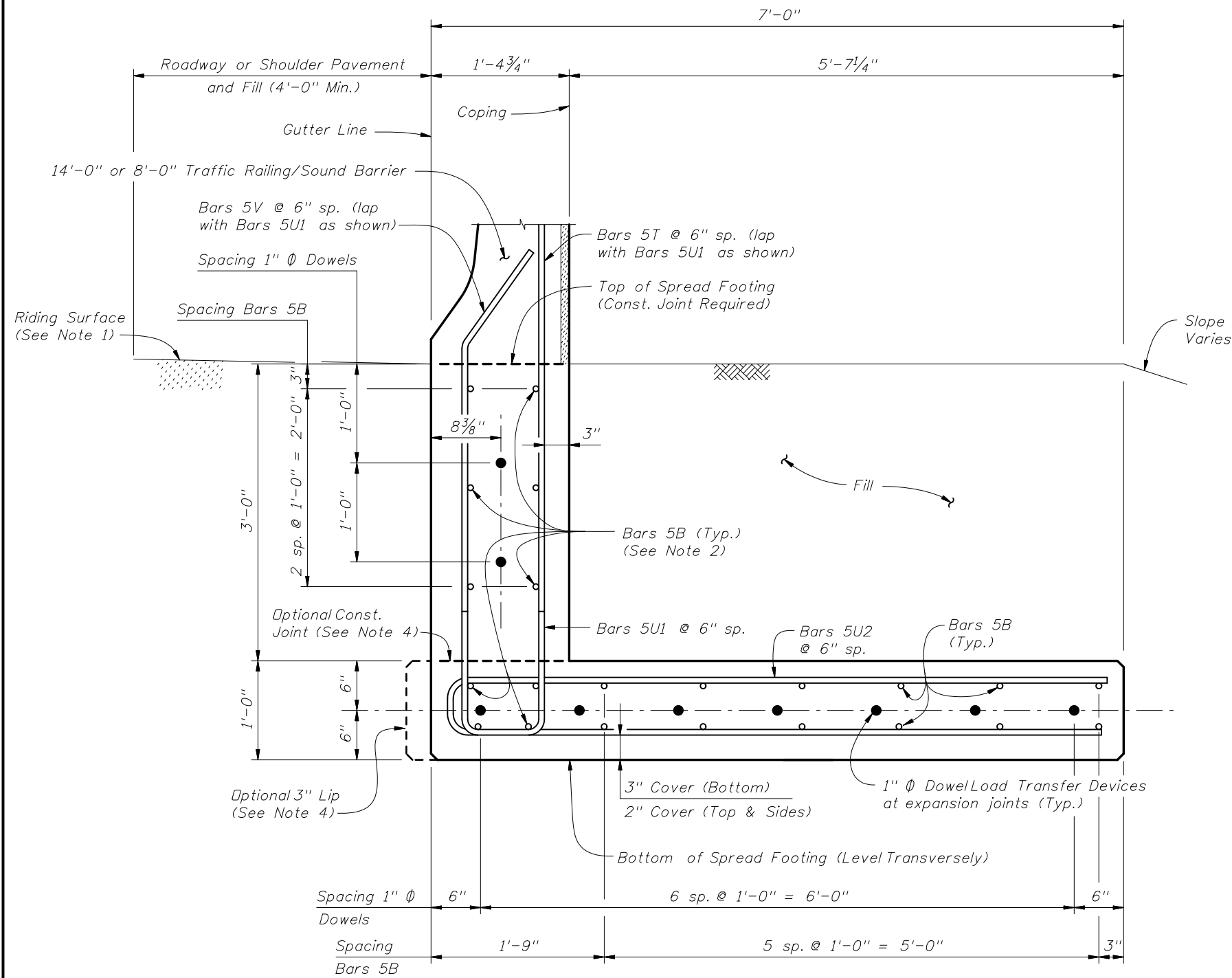

TYPICAL SECTION THRU SPREAD FOOTING - OPTION A  
(Bars 5P, 5R and 5S1 in Traffic Railing/Sound Barrier not shown for clarity)

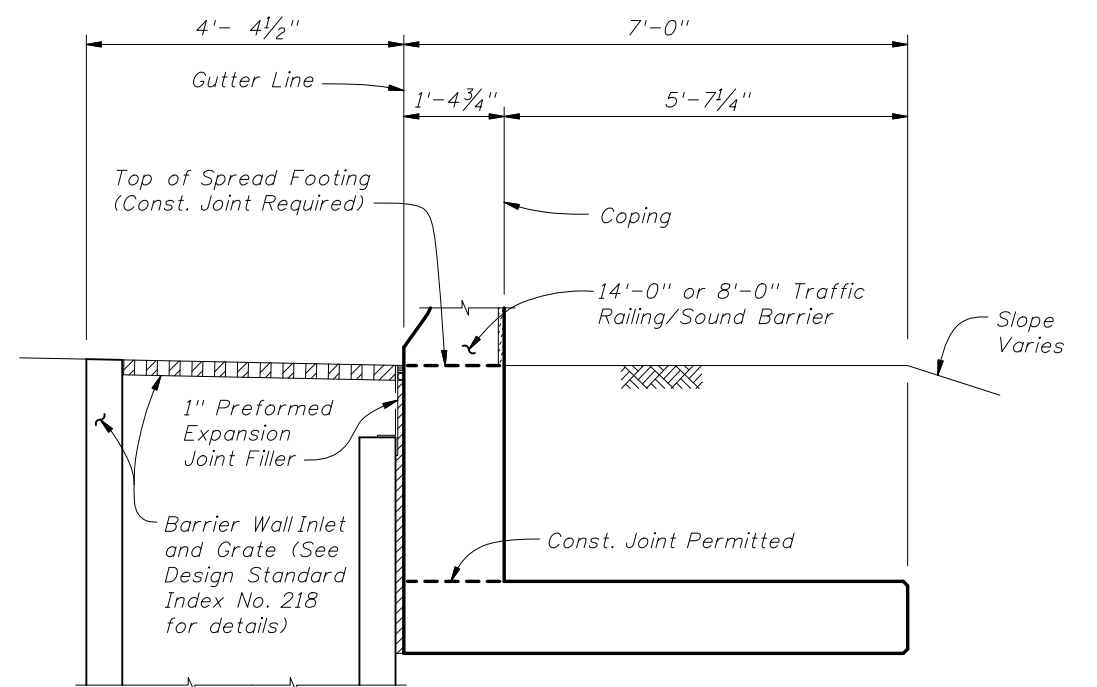

TYPICAL SECTION THRU SPREAD FOOTING AND BARRIER WALL INLET - OPTION A  
(Reinforcing Steel not shown for clarity (See Note 3))

NOTES:

1. Match Cross Slope of Travel Lane or Shoulder.
2. Place 10 ~ Bars 5B inside Bars 5U1 as shown.
3. For Reinforcing Steel spacing, see Typical Section Thru Spread Footing - Option A this Sheet.
4. Provide 3" lip when optional construction joint is used.

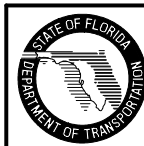

2008 FDOT Design Standards

**TRAFFIC RAILING/SOUND BARRIER  
L-SHAPED SPREAD FOOTING**

Last Revision	Sheet No.
07/01/05	2 of 4
Index No.	
<b>5214</b>	

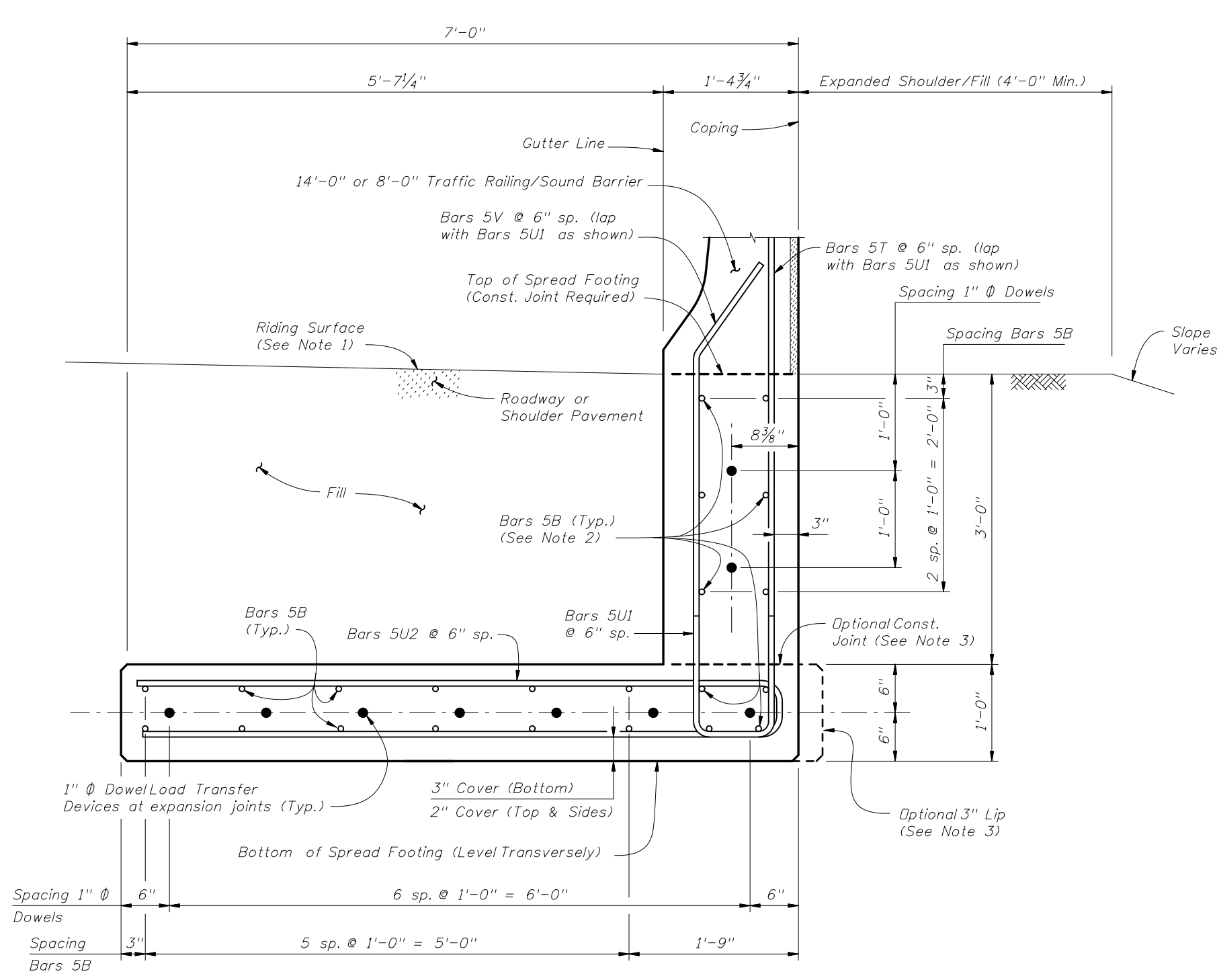

**TYPICAL SECTION THRU SPREAD FOOTING - OPTION B**  
 (Bars 5P, 5R and 5S1 in Traffic Railing/Sound Barrier not shown for clarity)

- NOTES:**
1. Match Cross Slope of Travel Lane or Shoulder.
  2. Place 10 ~ Bars 5B inside Bars 5U1 as shown.
  3. Provide 3" lip when optional construction joint is used.

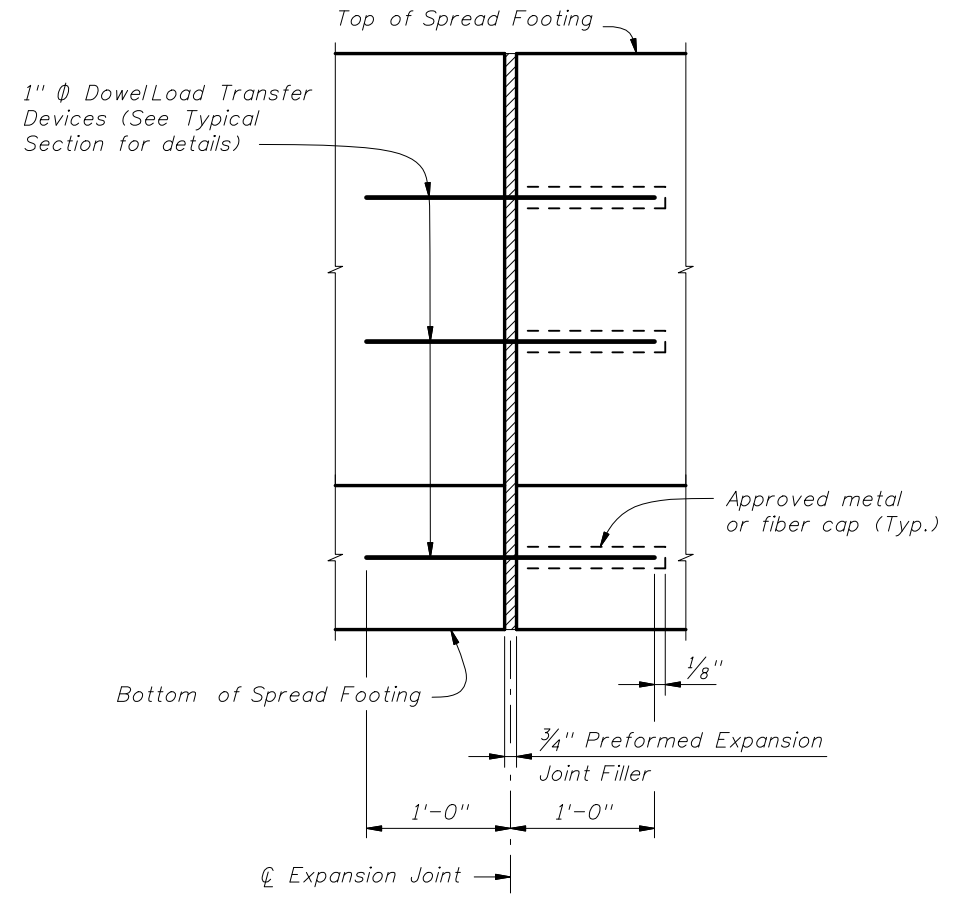

**EXPANSION JOINT DETAIL**  
 (Spread Footing expansion joints are required at 3/4" open joints in Traffic Railing/Sound Barrier)

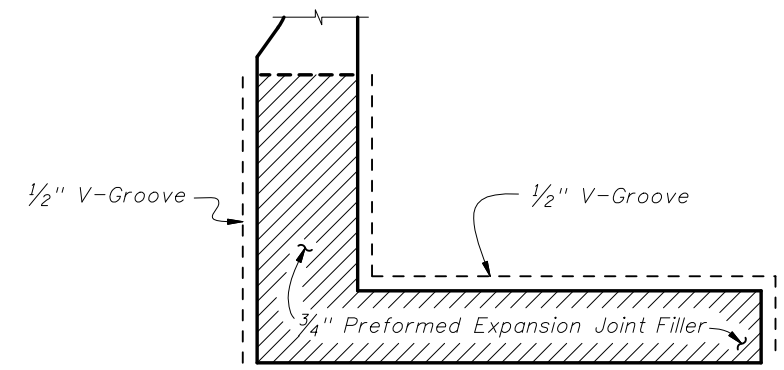

**DETAIL "A"**  
 (Option A Shown, Option B Similar)  
 (Showing Locations of 1/2" V-Grooves and 3/4" Preformed Expansion Joint Filler)

REINFORCING STEEL BENDING DIAGRAMS

BILL OF REINFORCING STEEL		
MARK	SIZE	LENGTH
B	5	AS REQD.
C	5	5'-6"
S3	5	3'-10"
S4	5	4'-3"
T	5	4'-3"
U1	5	8'-0"
U2	5	13'-11"
U3	5	12'-10"
V	5	3'-10"
DOWEL	1" $\phi$ Smooth Bar	2'-0"

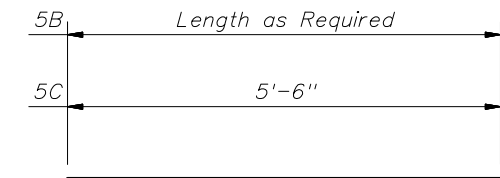

BARS 5B & 5C

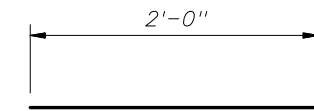

1"  $\phi$  DOWEL

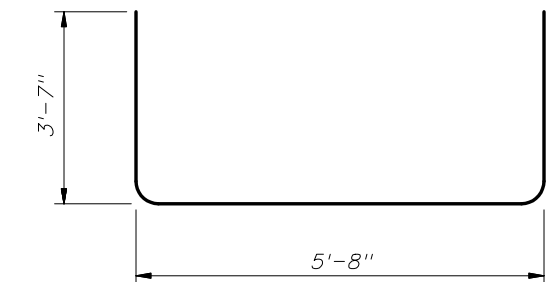

BAR 5U3

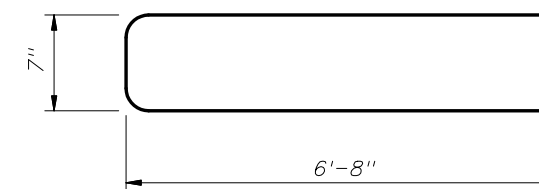

BAR 5U2

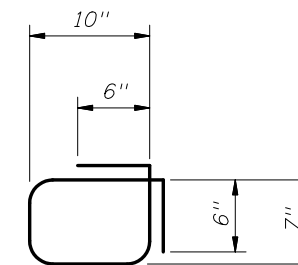

BAR 5S3

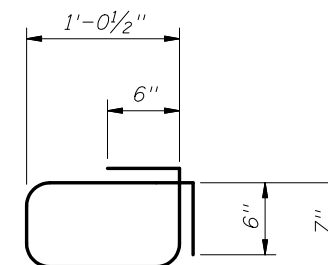

BAR 5S4

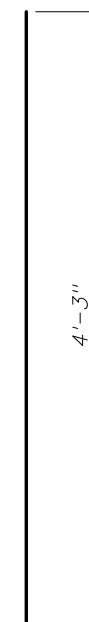

BAR 5T

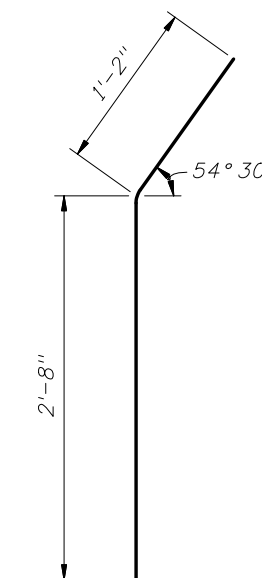

BAR 5V

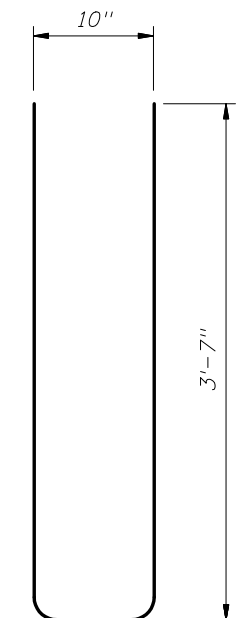

BAR 5U1

REINFORCING STEEL NOTES:

1. All bar dimensions in the bending diagrams are out to out.
2. All reinforcing steel at the open joints will have a 2" minimum cover.
3. Lap splices for Bars 5B will be a minimum of 2'-2".
4. Lap splices Bars 5T and 5V with 5U1 will be a minimum of 2'-2".
5. The Contractor may use Welded Wire Fabric when approved by the Engineer. Welded Wire Fabric will conform to ASTM A 497.

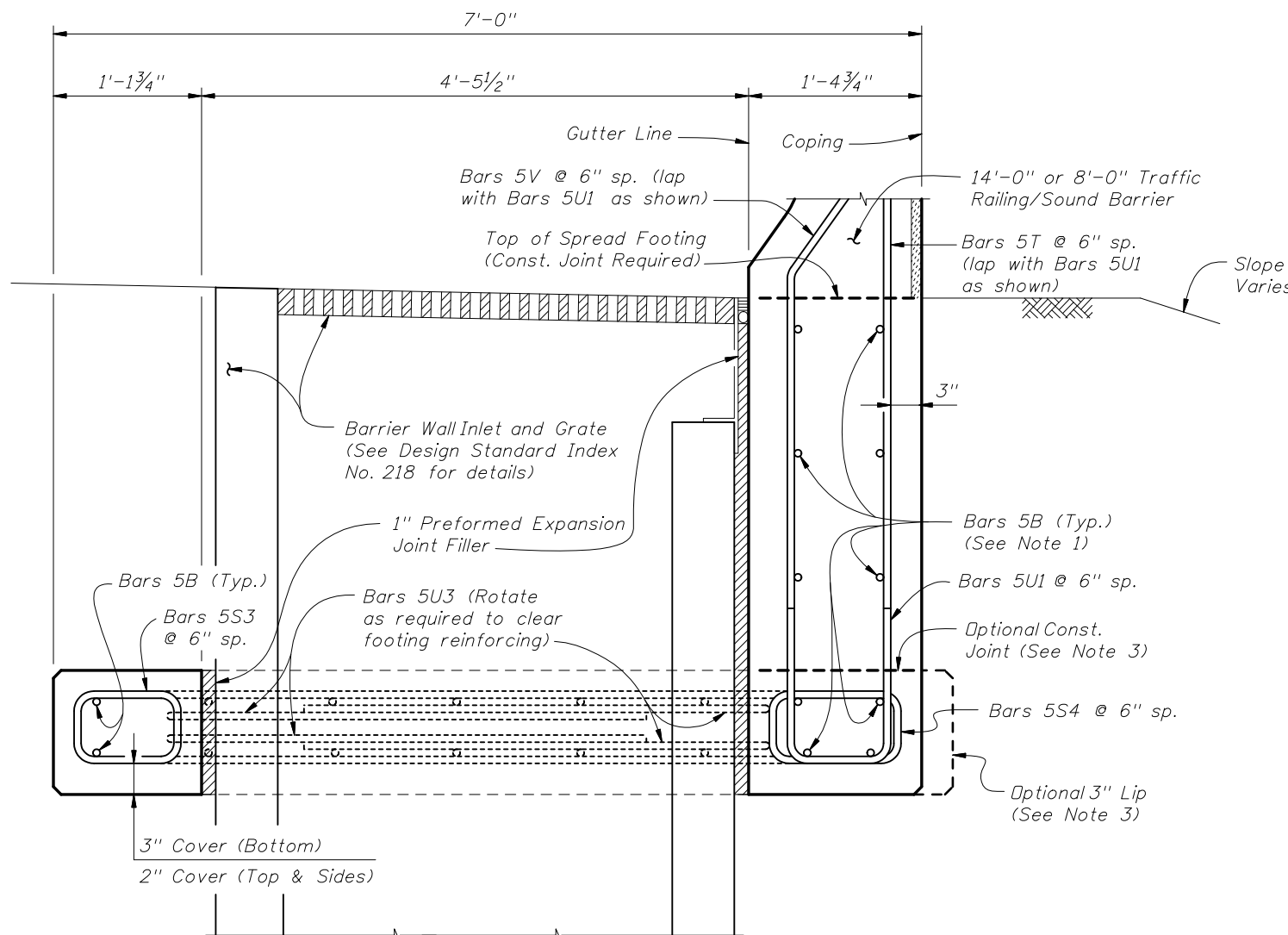

SECTION A-A

TYPICAL SECTION THRU SPREAD FOOTING AND BARRIER WALL INLET - OPTION B  
(Bars 5P, 5R and 5S1 in Traffic Railing/Sound Barrier not shown for clarity)

NOTES:

1. Place 10 ~ Bars 5B inside Bars 5U1 as shown.
2. For Reinforcing Steel spacing, see Typical Section Thru Spread Footing - Option B on Sheet 3.
3. Provide 3" lip when optional construction joint is used.

ESTIMATED L-SHAPED SPREAD FOOTING QUANTITIES		
ITEM	UNIT	QUANTITY
Concrete (Footing)	CY/Ft.	0.414
Reinforcing Steel (Typical)	LB/Ft.	85.53
Additional Reinf. @ Expansion Joint	Lb.	48.06

(Subtract 12.69 lb/ft from typical reinforcing steel quantity shown on Index No. 5210 to account for the absence of Stirrup Bars 5V and 5S1 in L-Shaped Spread Footings.)

CROSS REFERENCE:

For location of Section A-A, see Sheet 1.

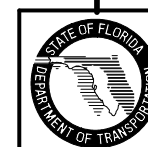

2008 FDOT Design Standards

TRAFFIC RAILING/SOUND BARRIER  
L-SHAPED SPREAD FOOTING

Last Revision: 07/01/05  
Sheet No. 4 of 4  
Index No. 5214