

FRONT VIEW

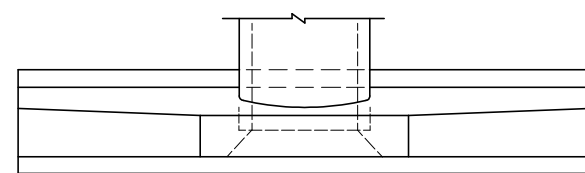

TOP VIEW

Const. Joint Permitted
See End View
(Enlarged)

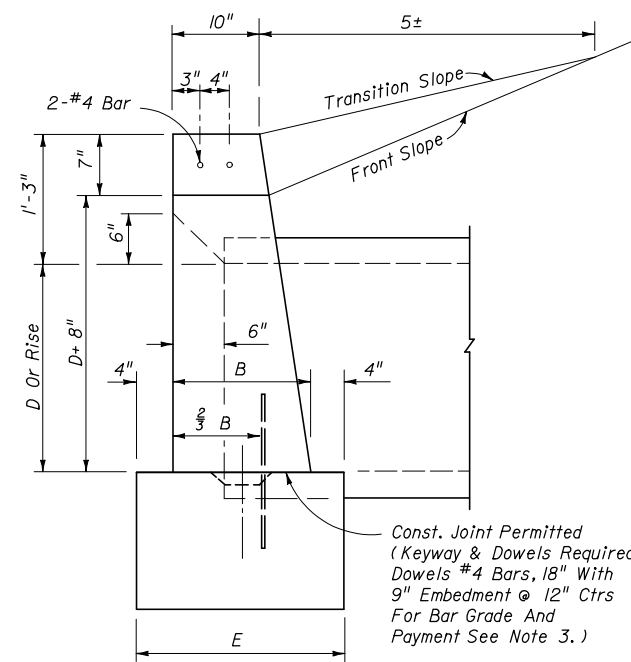

END VIEW (ENLARGED)

Const. Joint Permitted
(Keyway & Dowels Required-
Dowels #4 Bars, 18" With
9" Embedment @ 12" Ctrs
For Bar Grade And
Payment See Note 3.)

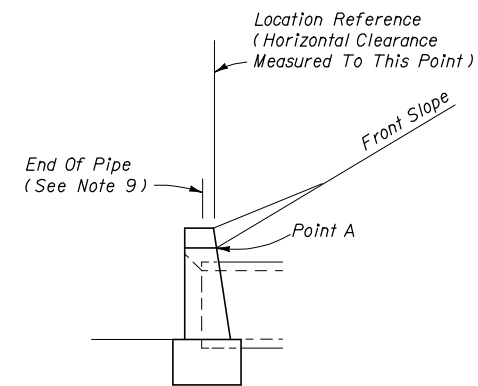

END VIEW

1. Position is set by the intersection of the front slope and Point A where this intersection falls outside the clear zone.
2. Where the front slope and Point A intersects inside the clear zone, the endwall is positioned so the location reference point is at the clear zone limit. The front slope is transitioned to the endwall as shown in Index No. 280.

STANDARD LOCATION CONTROL

GENERAL NOTES

1. Endwall dimensions, locations and positions are for round and elliptical concrete pipe and for round and pipe-arch corrugated metal pipe. Round concrete pipe shown.
2. Front slope and ditch transitions shall be in accordance with Index No. 280.
3. Endwalls may be cast in place or precast concrete. Reinforcing steel shall be Grades 40 or 60. Additional reinforcement necessary for handling precast units shall be determined by the Contractor or the supplier. Cost of reinforcement shall be included in the contract unit price for concrete, (endwalls).
4. All exposed corners and edges of concrete are to be chamfered $\frac{3}{4}$ ".
5. Concrete meeting the requirements of ASTM C478 (4000 psi) may be used in lieu of Class I concrete in precast items manufactured in plants which are under the Standard Operating Procedures for the inspection of precast drainage products.
6. On outfall ditches with side slopes flatter than 1:1 $\frac{1}{2}$ provide 20' transitions from the endwall to the flatter side slopes, right of way permitting.
7. For sodding around endwalls see Index No. 281.
8. Payment for concrete quantities for endwalls skewed to the pipe shall be made on the following basis:

Endwall Skew To Pipe	Use Tabulated Value
0° to 5°	0°
6° to 15°	15°
16° to 30°	30°
31° or over	45°
9. Pipe length plan quantities shall be based on the pipe end locations shown in the standard location control end view, or lengths based on special endwall locations called for in the plans.
10. Payment for pipe in pipe culverts shall be based on plan quantities, adjusted for endwall locations subsequently established by the Engineer.
11. Endwalls to be paid for under the contract unit price for Class I Concrete (Endwalls), CY.

ENDWALL DIMENSIONS (EXCLUSIVE OF MULTIPLE PIPE SPACING)

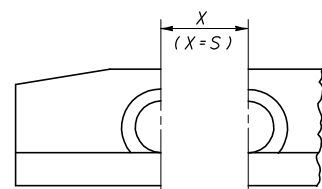

FRONT VIEW

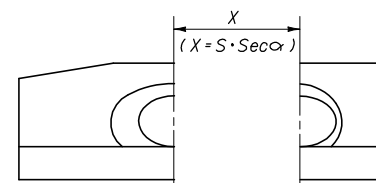

FRONT VIEW

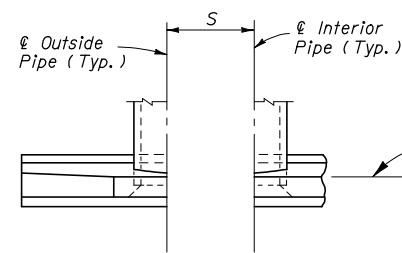

TOP VIEW

Location Reference Line
(See Location Control Above)

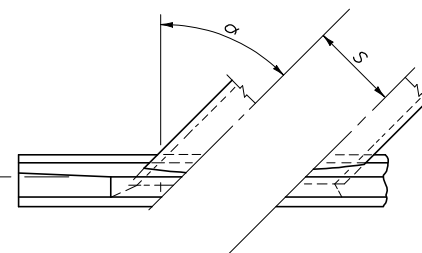

TOP VIEW

NORMAL PIPE

LEGEND

SKEWED PIPE

- α Pipe Skew
- S Center To Center Pipe Spacing
- X Centerline To Centerline Dimension At Face Of Headwall

ENDWALL POSITIONS FOR SINGLE AND MULTIPLE PIPE AND SPACING FOR MULTIPLE PIPE



2008 FDOT Design Standards

STRAIGHT CONCRETE ENDWALLS SINGLE AND MULTIPLE PIPE

Last Revision 04	Sheet No. 1 of 2
Index No. 250	

