

FRAME AND GRATE

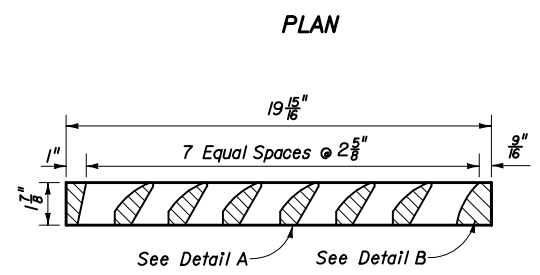

GRATE DETAIL

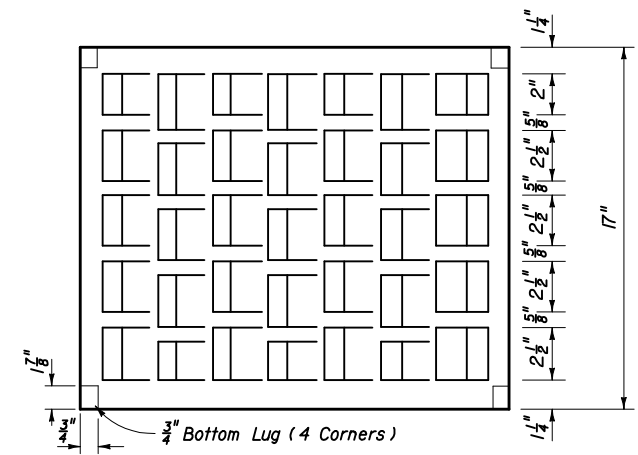
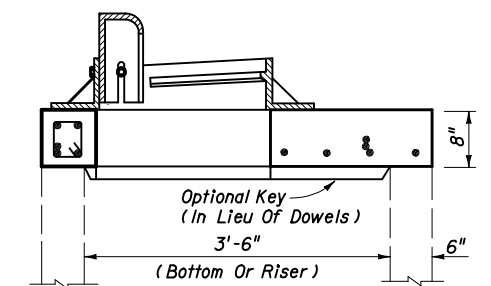
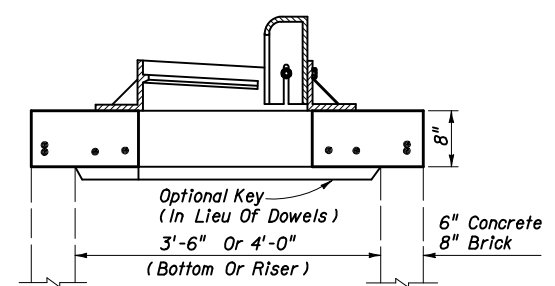
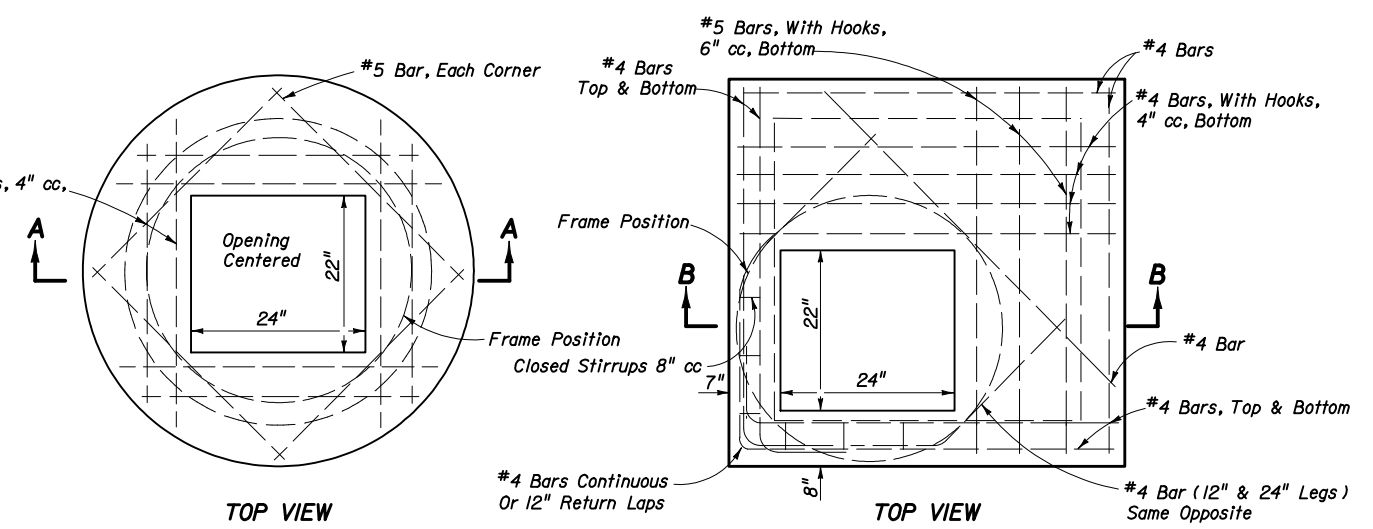
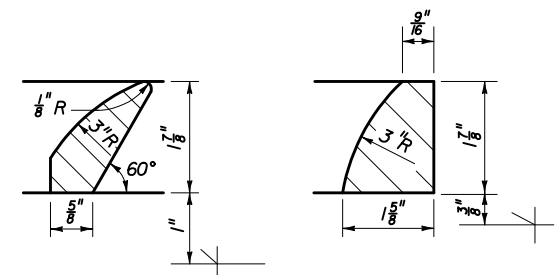
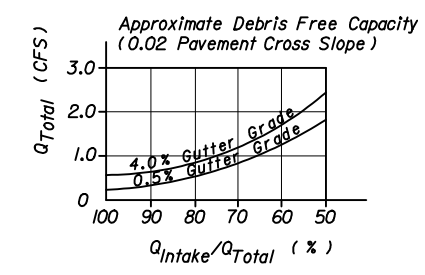

TOP SLABS

GENERAL NOTES

1. This inlet is primarily intended for locations with light flows where right of way does not permit the use of throated Curb Inlets Types I through 6. The typical application is on curb returns to city streets. The inlet grate is suitable for pedestrian and bicycle traffic.
2. This inlet to be located outside of curb ramp area in vertical faced curbs such as Curb and Gutter Type F. Grate shall be oriented with vanes directed toward predominate flow.
3. For structure bottoms see Index No. 200. For supplemental details see Index No. 201.
4. All steel in slab tops shall have 1/4" minimum cover unless otherwise shown. Tops shall be either cast-in-place or precast concrete.
5. For Alternate B applications, top slab openings shall be placed such that 2 edges of Inlet frame will be located directly above bottom or riser walls.
6. When used on a structure with dimensions larger than those detail above and risers are not applied, the top slab shall be constructed using Index No. 200 with the slab opening adjusted to 24"x36". The "Special Top Slab" on Index No. 200 is not permitted.
7. Frame may be adjusted with one to six coursed of brick.
8. Cast iron frame grate and hood to be U.S. Foundry 5161-6019, Neenah Foundry R-3065-L, or approved equal. Inlet and grate detail shown is Neenah R-3065-L. Vaned grates with approximately equal openings will be permitted that satisfy AASHTO HS-20 loading. Inlet and grate shall be Class 30 castings in accordance with ASTM A48. Grates shall be reversible.