

SOP 1

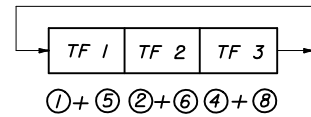

SOP 2

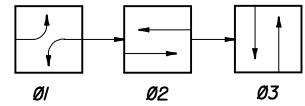
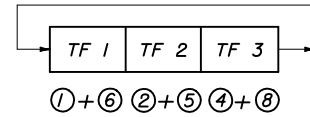
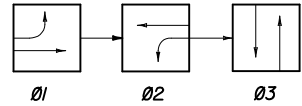

SOP 3

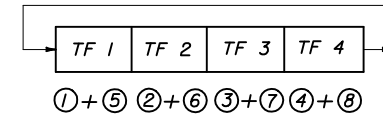
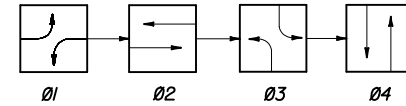

SOP 4

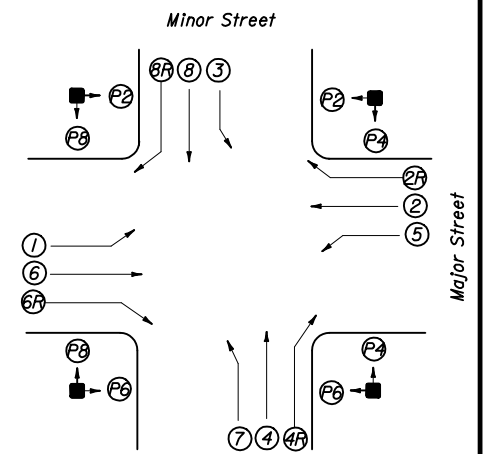

SIGNALIZED INTERSECTION

Vehicle movements & signal head number assignments are not directionally oriented but shall maintain their relative orientation about the intersection (i.e. movements 7 and 4 are always to the right of movements 1 and 6 etc.)

LEGEND

- (X) Vehicle Movement Number
- (P) Pedestrian Movement Number
- TF X Timing Function Number
- 0X Phase Number
- ← Green Arrow (Left or Right)
- ← Red Arrow
- ← Yellow Arrow

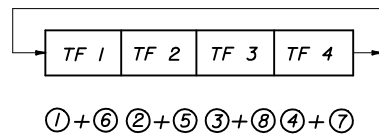
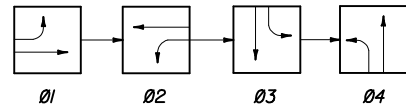

SOP 5

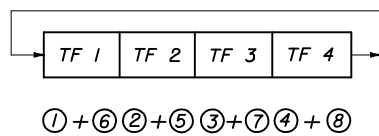
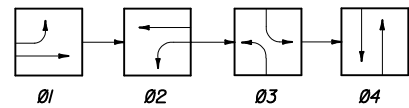

SOP 6

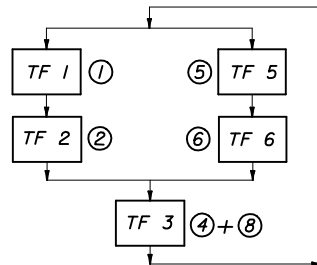
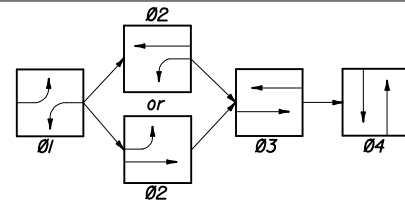

SOP 7

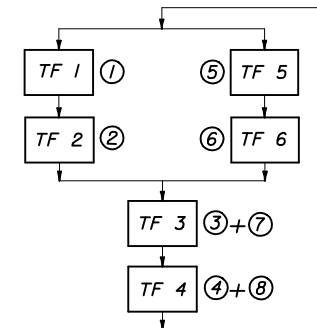
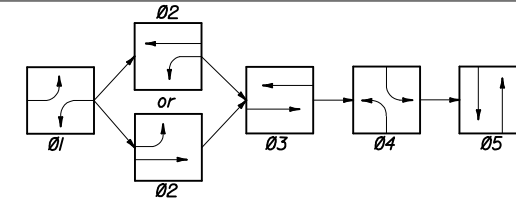

SOP 8

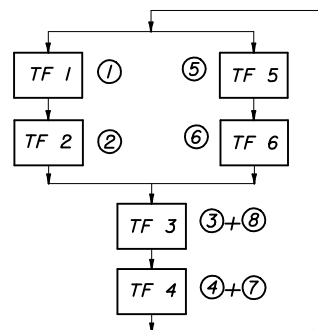
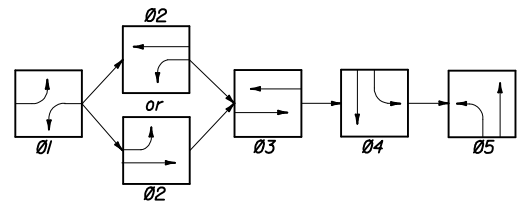

SOP 9

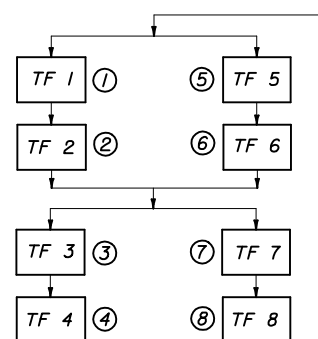
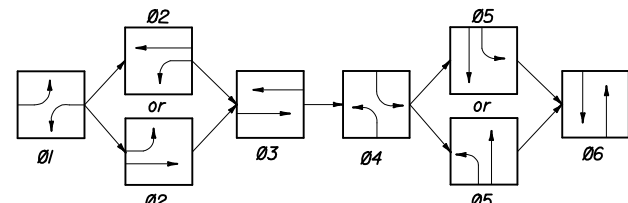

SOP 10

SIGNAL CLEARANCE TABLE
(Blank Indicates No Clearance Required)

From \ To		SIGNAL INDICATIONS						
		R	R	G	G	G	WALK	DONT WALK
SIGNAL INDICATIONS	R			Y	Y	Y		
	R			Y	Y	Y		
	G				Y			
	G							
	G							
	WALK							
	DONT WALK							Flash DONT WALK
	DONT WALK							



2006 FDOT Design Standards

STANDARD SIGNAL OPERATING PLANS

Last Revision: 07/01/05
Sheet No. 1 of 2
Index No. 17870

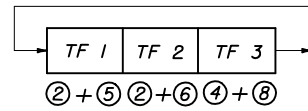
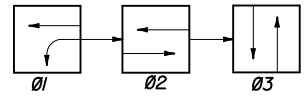

SOP 11

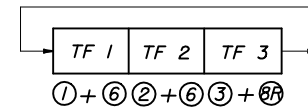
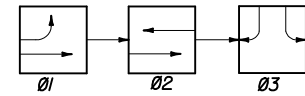

SOP 12

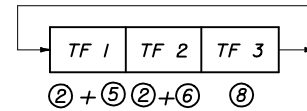
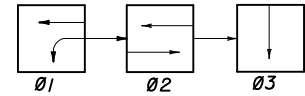

SOP 13
(ONE-WAY STREET INTERSECTION)

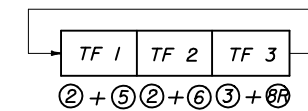
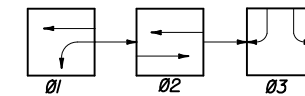

SOP 14
(DIAMOND INTERCHANGE OPERATION)

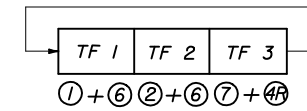
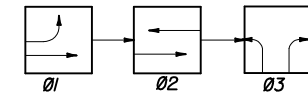

SOP 15
(DIAMOND INTERCHANGE OPERATION)

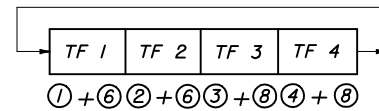
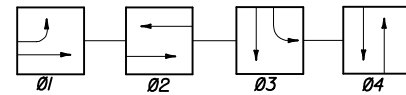

SOP 16

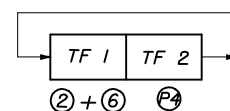
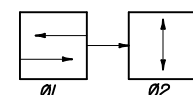

SOP 17
(MID-BLOCK)

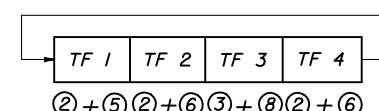
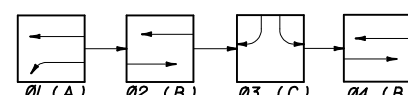

NOTE:
Only Ø2 Or Ø4 Used, Not Both To Obtain
ABC, Or ACB Operation.

SOP 18
(DIAMOND INTERCHANGE OPERATIONS)

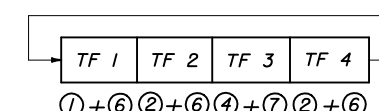
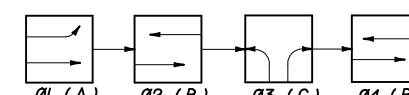

NOTE:
Only Ø2 Or Ø4 Used, Not Both To Obtain
ABC, Or ACB Operation.

SOP 19
(DIAMOND INTERCHANGE OPERATIONS)

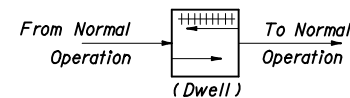

POP 1

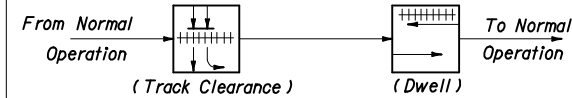

POP 2



POP 3

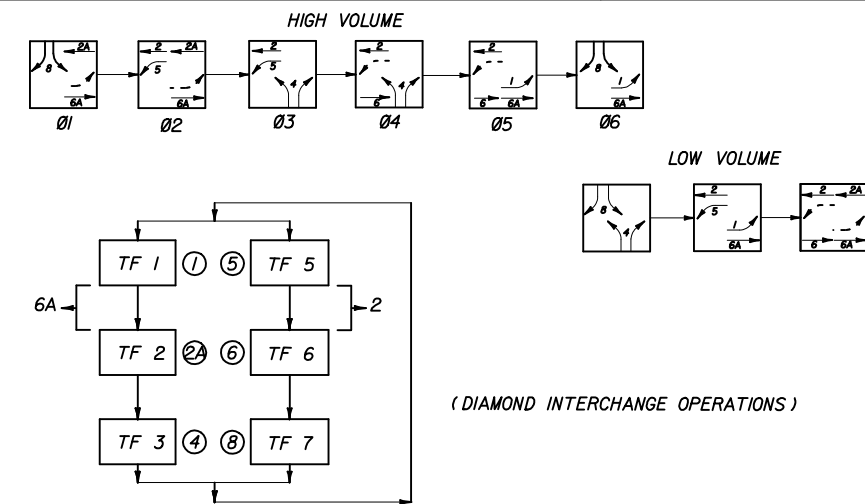

(DIAMOND INTERCHANGE OPERATIONS)

SOP 20



2006 FDOT Design Standards

STANDARD SIGNAL OPERATING PLANS

Last Revision 00 Sheet No. 2 of 2

Index No. 17870